

# Marine Insects

*Edited by*

Lanna Cheng

*Scripps Institution of Oceanography,  
University of California, La Jolla, Calif. 92093, U.S.A.*



1976

NORTH-HOLLAND PUBLISHING COMPANY, AMSTERDAM - OXFORD  
AMERICAN ELSEVIER PUBLISHING COMPANY, NEW YORK

© North-Holland Publishing Company - 1976

*All rights reserved. No part of this publication may be reproduced, stored in a retrieval system, or transmitted, in any form or by any means, electronic, mechanical, photocopying, recording or otherwise, without the prior permission of the copyright owner.*

*North-Holland ISBN: 0 7204 0581 5  
American Elsevier ISBN: 0444 11213 8*

PUBLISHERS:

NORTH-HOLLAND PUBLISHING COMPANY - AMSTERDAM  
NORTH-HOLLAND PUBLISHING COMPANY LTD. - OXFORD

SOLE DISTRIBUTORS FOR THE U.S.A. AND CANADA:

AMERICAN ELSEVIER PUBLISHING COMPANY, INC.  
52 VANDERBILT AVENUE, NEW YORK, N.Y. 10017

### **Library of Congress Cataloging in Publication Data**

Main entry under title:

Marine insects.

Includes indexes.

1. Insects, Marine. I. Cheng, Lanna.

QL463.M25 595.7'09'2 76-17123

ISBN 0-444-11213-8

## Preface

In a book of this kind, it would be difficult to achieve a uniform treatment for each of the groups of insects discussed. The contents of each chapter generally reflect the special interests of the contributors. Some have presented a detailed taxonomic review of the families concerned; some have referred the readers to standard taxonomic works, in view of the breadth and complexity of the subject concerned, and have concentrated on ecological or physiological aspects; others have chosen to review insects of a specific set of habitats. Nevertheless, each has presented a general picture of the group of insects under discussion, their nature, ecology, life histories, special adaptations to marine environments, and a comprehensive review of the literature.

It is difficult to draw a line between the sea and dry land, or between marine and fresh waters. The word 'marine' is broadly interpreted here as referring to any more or less saline waters, and a 'marine insect' as one that spends at least part of its life in association with the marine environment.

Chapters in the first part of this book are predominantly ecological in the broad sense, while the rest of the chapters deal with major groups of insects found in marine environments. It has been impossible to cover all the orders or families of insects with marine representatives. There is no chapter here dealing with Hymenoptera, which include several genera of tiny wasps parasitic on marine Canaceidae, etc., as well as the more familiar ants which help to clear up crumbs and debris on the beaches. There are no chapters dealing with the Dermaptera, which include a marine earwig, *Anisolabis littorea* (White), known so far only from New Zealand; or the Homoptera, though some discussions of saltmarsh aphids can be found in Ch. 2; or the Neuroptera, although the larvae of at least two species of Sisyridae, *Climacia areolaris* (Hagen) and *Sisyra vicaria* (Walker), are quite common in two brackish water sponges (Vincent Resh, personal communication). Nor are there chapters on the Orthoptera or the Lepidoptera. Several families of Diptera with marine representatives, notably Dolichopodidae, Canaceidae, and

Tipulidae, are discussed only with respect to their respiratory adaptations (see Ch. 3).

A number of topics of general interest have been excluded because of insufficient knowledge. In particular, we might mention the evolutionary and genetic aspects of marine insect distributions, which present challenging problems relating, for instance, to dispersal to new territories, gene exchange from ocean to ocean across or around continental land masses, and patterns of gene flow in coastal species whose territories are virtually linear or one-dimensional - several thousand kilometres long yet only a few metres wide. (However, some genetic studies on *Coelopa frigida* (Fabricius) are given in Ch. 16.) We hope such omissions will not be regarded as demerits of this book, but rather as incentives to others to study some of the less familiar kinds of marine insects.

We have considered in this volume not only true insects, including the Collembola (Ch. 7), and insect parasites of marine birds and mammals (Ch. 4), but also other kinds of intertidal air-breathing arthropods (Ch. 6), notably spiders, scorpions, mites, centipedes and millipedes, which live and feed with, or even on, the insects of marine habitats. We have also included a chapter on migratory and other insects at sea (Ch. 5), even if they are blown seaward only sporadically and probably involuntarily!

Clearly there is vast scope for studies on marine insects at present.

## List of contributors

Andersen, N. Møller *Universitetets Zoologiske Museum, Universitetsparken 16, Kobenhavn, Denmark*

Axtell, Richard C. *Department of Entomology, North Carolina State University, Raleigh, N.C. 26707, U.S.A.*

Bowden, John *Rothamsted Experimental Station, Harpenden, Herts, England*

Brown, Wynne L. *Department of General Biology, University of Arizona, Tucson, Ariz. 85721, U.S.A.*

Cheng, Lanna *Scripps Institution of Oceanography, University of California at San Diego, La Jolla, Calif. 92093, U.S.A.*

Dobson, Terry *Department of Genetics, University of Aarhus, Aarhus 8999, Denmark*

Doyen, John T. *Department of Entomology, University of California, Berkeley, Calif. 94720, U.S.A.*

Foster, William D. *Department of Zoology, University of Cambridge, Downing Street, Cambridge, England*

Hashimoto, Hiroshi *General Education Department, Shizuoka University, Shizuoka, Japan*

Hinton, Howard E. *Department of Zoology, Bristol University, Bristol, England*

Johnson, C.G. *Rothamsted Experimental Station, Harpenden, Herts, England*

Joose, Els N.G. *Biologisch Laboratorium, Vrije Universiteit, Amsterdam, The Netherlands*

Leader, John *Department of Physiology, Otago Medical School, P.O. Box 913, Dunedin, New Zealand*

Legner, E.F. *Department of Entomology, University of California, Riverside, Calif. 92502, U.S.A.*

Linley, John R. *Florida Medical Entomology Laboratory, P.O. Box 520, Vero Beach, Fla. 32960, U.S.A.*

Moore, Ian *Department of Entomology, University of California, Riverside, Calif. 92502, U.S.A.*

Murray, M.D. *Division of Animal Health, McMaster Laboratory, CSIRO, Glebe, N.S.W. 2037, Australia*

O'Meara, George F. *Florida Medical Entomology Laboratory, P.O. Box 520, Vero Beach, Fla. 32960, U.S.A.*

Polhemus, John T. *3115 South York, Englewood, Colo. 80110, U.S.A.*

Roth, Vincent D. *Southwestern Research Station, American Museum of Natural History, Portal, Ariz. 85632, U.S.A.*

Scudder, Geoffrey G.E. *Department of Zoology, University of British Columbia, Vancouver 8, B.C., Canada*

Simpson, Karl W. *Division of Laboratories and Research, State of New York Department of Health, New Scotland Avenue, Albany, N.Y. 12201, U.S.A.*

Treherne, John E. *Department of Zoology, University of Cambridge, Cambridge, England*

## Acknowledgements

No multi-authored book could be compiled without cooperation between the contributors and the editor. I would like to thank the contributors not only for the time and effort they devoted to their chapters, but also for generously considering and accepting many suggestions from their colleagues as well as from the editor. To all those who have helped in one way or another during the editorial process of this book, I offer my sincere thanks; in particular to Donna DeCamp, Virginia L. DeCamp and Vickie Gillespie for their skillful transformation of scribbled and cut-and-pasted pages into flawless typescripts; to Chi-ling Liu and Gayle M. Kidder for assistance in compiling the indexes; and to the following for all kinds of helpful suggestions and unpublished observations and comments: Dru Binney, Martin C. Birch, Linda Birch, Ted H. Bullock, Eric B. Edney, K.C. Emerson, John D. Isaacs, B.C. Nelson, Dietrich Neumann, Lester J. Newman, William A. Newman, Vincent Resh, Richard A. Schwartzlose, Eric Shulenberger, Gerry L. Wick and, of course, Ralph A. Lewin.

The preparation of this book was partly supported by the National Sea Grant Program NOAA, Department of Commerce, under grant number 04-5-158-20 to the Scripps Institution of Oceanography.

I should also like to thank the following for permission to reproduce figures: 4.3, Pacific Coast Entomological Society; 7.14 & 7.16, C.N.R.S., Paris; 7.4–7.13, Akademische Verlagsgesellschaft Geest & Portig, Leipzig; 7.28, 7.29, Faun.-Ökol. mitt., Kiel.; 9.1, 9.2, 9.6, 9.7, 9.9, 9.10, University of California Press; 9.5 & 9.11, Bishop Museum Press; 9.8, Smithsonian Institution; 9.13, Entomological Society of America; 9.3, Royal Entomological Society, London.

## Contents

For a detailed list of contents the reader is referred to the opening page of each chapter

Preface		V
List of contributors		VII
Acknowledgements		IX
<b>Contents</b>		
Chapter 1	Insects in marine environments, by <i>Lanna Cheng</i> <i>Topics of general interest</i>	1
Chapter 2	Insects of marine saltmarshes: problems and adaptations, by <i>William A. Foster and John E. Treherne</i>	5
Chapter 3	Respiratory adaptations of marine insects, by <i>Howard E.</i> <i>Hinton</i>	43
Chapter 4	Insect parasites of marine birds and mammals, by <i>M.D.</i> <i>Murray</i>	79
Chapter 5	Migrating and other terrestrial insects at sea, by <i>John</i> <i>Bowden and C.G. Johnson</i>	97
Chapter 6	Other intertidal air-breathing arthropods, by <i>Vincent D. Roth</i> <i>and Wynne L. Brown</i> <i>Reviews of major groups of marine insects</i>	119
Chapter 7	Littoral apterygotes (Collembola and Thysanura), by <i>Els</i> <i>N.G. Joosse</i>	151



Chapter 8	Water-striders (Hemiptera: Gerridae, Veliidae, etc.) by <i>Nils Møller Anderson and John T. Polhemus</i>	187
Chapter 9	Shore bugs (Hemiptera: Saldidae, etc.) by <i>John T. Polhemus</i>	225
Chapter 10	Water-boatmen of saline waters (Hemiptera: Corixidae) by <i>Geoffrey G.E. Scudder</i>	263
Chapter 11	Marine caddis flies (Trichoptera: Philanisidae) by <i>John P. Leader</i>	291
Chapter 12	Saltmarsh mosquitoes (Diptera: Culicidae) by <i>George F. O'Meara</i>	303
Chapter 13	Biting midges of mangrove swamps and saltmarshes (Diptera: Ceratopogonidae) by <i>John R. Linley</i>	335
Chapter 14	Non-biting midges of marine habitats (Diptera: Chironomidae) by <i>Hiroshi Hashimoto</i>	377
Chapter 15	Horse flies and deer flies (Diptera: Tabanidae) by <i>Richard C. Axtell</i>	415
Chapter 16	Seaweed flies (Diptera: Coelopidae, etc.) by <i>Terry Dobson</i>	447
Chapter 17	Shore flies and brine flies (Diptera: Ephydriidae) by <i>Karl W. Simpson</i>	465
Chapter 18	Marine beetles (Coleoptera excluding Staphylinidae) by <i>John T. Doyen</i>	497
Chapter 19	Intertidal rove beetles (Coleoptera: Staphylinidae) by <i>Ian Moore and E.F. Legner</i>	521
	Subject index	553
	Taxonomic index	561

## Insects in marine environments

Lanna Cheng

Insects now comprise over 75 % of all described animal species and exhibit not only a rich variety of form, colour and shape, but also a range of ecological adaptations unexcelled by any other group. Nevertheless, they have generally failed to establish themselves in the world's seas and oceans. Some speculations as to why insects are so rare in marine habitats have been based on a single postulated obstacle, such as the low concentrations of calcium in seawater (Pruthi, 1932, refuted by Thorpe, 1932). Others have been based on a complex combination of biological, physical and chemical factors (Carpenter, 1901; Walsh, 1925; Buxton, 1926; MacKerras, 1950; Usinger, 1957). How such factors may have operated to exclude most of an otherwise highly successful group of animals from the most extensive biotope on earth is still not understood.

Actually, some insects are associated with the sea. Even on the open ocean, thousands of kilometres from land, we can find *Halobates*, which, however, spends all its life on the sea surface. As far as we know, no marine insects remain submerged throughout their lives. (The report that *Pontomyia* (Chironomidae) is permanently submarine (Edwards, 1926) is erroneous (Tokunaga, 1932).)

About 3 %, some 25,000 to 30,000 species of insects, are aquatic or have aquatic larval stages. Of these only a fraction, perhaps several hundred species, are marine or intertidal. Nevertheless, certain marine insects are of considerable economic or medical importance. Man's progress and the development of millions of acres of coastal land around the world have been impeded by saltmarsh mosquitoes, midges and tabanid flies (see Chs 12, 13 and 15), some of which not only bite man but may also carry human diseases. Many beaches are at times rendered unsuitable for recreation because of an abundance of these biting insects, or of various seaweed flies or beach flies (see Chs 16 and 17) which, though they do not bite, may occur in such large numbers (hundreds of thousands per kilometre) that they constitute quite a nuisance. Although we have considerable information on saltmarsh mosquitoes and midges, especially those aspects relevant to the control

of these pests, our knowledge of the basic biology, physiology and adaptations of even the most intensively studied species is still far from adequate.

Marine insects have generally been ignored in standard entomological books on the one hand, and in marine invertebrate books on the other. However, several lists of marine insects have been compiled (Backlund, 1945; Marine Biological Association, 1957; Smith and Carlton, 1975; etc.). Such lists are generally regional and far from complete, but they do indicate the existence of potentially rich faunas of coastal marine insects that are often overlooked.

According to the fossil record, land insects, along with vascular plants, arose in the Mid-Palaeozoic some 250–300 million years ago, when the seas were shallow, extensive, warm, and already populated by virtually all major phyla of marine invertebrates which had evolved some 200 million years earlier. The first winged insects probably became established in the Upper Palaeozoic (Tiegs and Manton, 1958). Their juvenile stages could have been aquatic or semi-aquatic, living in non-saline swamp pools. From such forms emerged the modern insects, most of which are now completely terrestrial and independent of aqueous environments.

Special adaptations of insects to an aerial existence include the development of a hardened cuticle, often impregnated with lipids, which not only affords protection from physical damage but also retards loss of water; a breathing system of non-collapsible tracheae, whereby oxygen is distributed to the tissues by diffusion (this system is progressively less efficient as internal distances increase, resulting in an eventual limitation of body size); and wings, permitting migration to far distant or isolated areas that otherwise might have been inaccessible. The evolution of complete metamorphosis, which allows adults to exploit habitats totally different from those of the young, further extends their range of available habitats. Thus, two trends seem to pervade insect evolution: achieving independence from the damp habitat in which their ancestors evolved, and increasing their ability to disperse.

To return to an aquatic existence, insects, which are primarily terrestrial or aerial organisms, have to solve several ecological, physiological and physical problems. For such a return to be possible there must be 'bridging' habitats. Between land and sea such environments are provided by estuaries, saltmarshes, mangrove swamps and the intertidal zones. The majority of our so-called marine insects are still found in such habitats.

It has been suggested that the highly successful Crustacea, which had already diversified much earlier in the Cambrian, had become so well-established in fully marine environments that competition and predation may have been important factors in limiting the further invasion of marine habitats by insects (Usinger, 1957).

In order to live in the sea, insects also have to overcome physical constraints of buoyancy and surface tension and physiological problems of respiration and osmoregulation.

A reduction in body weight and an increase in surface–volume ratio, while advantageous for becoming airborne, may be a hindrance for insects which have to penetrate air–water interfaces. Wings, too, tend to be a nuisance for such small animals associated with water or air–water interfaces. Many marine insects have become wingless (e.g. sea-skaters, see Ch. 8) or have reduced wings (e.g. chironomids, see Ch. 14). Others have fully developed wings but are flightless or weak fliers (e.g. certain shore bugs, beach flies and beetles, see Chs 9, 18 and 19). Such adaptations perhaps help to prevent these insects from being readily blown away from their proper habitat.

Insects that become temporarily submerged need some means of breathing under water. Several marine species, notably the sea-skaters, are known to trap air between the hydrofuge hairs covering their bodies, and thus prevent drowning. Other special respiratory adaptations superimposed on the tracheal system include breathing siphons, blood-gills and various kinds of ‘physical gills’ (see Ch. 3). In one way or another all of these devices have been used by marine insects, but the mechanisms and structures have not been studied in as much detail as they have for a few of the freshwater species.

Experimental studies on the osmoregulation of marine insects have been carried out on larvae of the marine caddis-fly *Philaniscus plebeius* Walker (see Ch. 11), saltmarsh mosquitoes such as *Opifex fuscus* Hutton and *Aedes detritus* (Haliday) (see Ch. 2), and certain Corixidae (see Ch. 10). It is clear from these studies that some insects are able to osmoregulate over a wide range of salinities.

Perhaps the physiology of the muscular or nervous system of an insect is so specialized that it cannot tolerate physico-chemical conditions like those of sea-water. It may be that osmotic regulation and submarine respiration involve evolution of such different physiological adaptations that few insects have been successful in achieving both goals. This may be hard to prove, but what more plausible explanation could one suggest for the paucity of marine insects?

## REFERENCES

- Backlund, H.O. (1945) Wrack fauna of Sweden and Finland. Opusc. Entomol. suppl., 237 pp.
- Buxton, P.A. (1926) The colonization of the sea by insects: with an account of the habits of *Pontomyia*, the only known submarine insect. Proc. Zool. Soc. Lond. 1926, 808–814.
- Carpenter, G.H. (1901) The insects of the sea. Knowledge 24, 19–21, 51–54, 114–116, 161–163, 194–198, 245–248.
- Edwards, F.W. (1926) On marine Chironomidae (Diptera): with descriptions of a new genus and four new species from Samoa. Proc. Zool. Soc. Lond., 1926, 779–806.
- Mackerras, I.M. (1950) Marine insects. Proc. R. Soc. Queensl. 61, 19–29.
- Marine Biological Association (1957) Plymouth Marine Fauna.
- Pruthi, H.S. (1932) Colonization of the sea by insects. Nature 130, 312.
- Smith, R.I. and Carlton, J.T. (Eds.) (1975) Intertidal Invertebrates of the Central California Coast.

- Tiegs, O.W. and Manton, S.M. (1958) The evolution of the Arthropoda. *Biol. Rev.* 33, 255–337.
- Thorpe, W.H. (1932) Colonization of the sea by insects. *Nature* 130, 629–630.
- Tokunaga, M. (1932) Morphological and biological studies on a new marine chironomid fly, *Pontomyia pacifica*, from Japan. *Mem. Coll. Agric., Kyoto Imp. Univ.* 19, 1–56.
- Usinger, R.L. (1957) Marine insects. *Geol. Soc. Am. Mem.* 67, (1) 1177–1182.
- Walsh, G.B. (1925) The coast Coleoptera of the British Isles. *Entomol. Mon. Mag.* 61, 137–151.

# Insects of marine saltmarshes: problems and adaptations

W.A. Foster J.E. Treherne

<b>Contents</b>		
2.1	Introduction	5
2.2	The insect fauna	6
2.3	The saltmarsh	7
2.4	Respiratory problems and adaptations	11
2.5	Osmotic and ionic problems and adaptations	17
2.6	Other physical factors	24
	2.6.1 Tide	24
	2.6.2 Substrate	26
	2.6.3 Temperature	26
2.7	Nutrition	26
2.8	Dispersal	29
2.9	Predators, parasites and pathogens	31
2.10	Epilogue	34
References	35	

## 2.1 INTRODUCTION

Saltmarshes are areas of angiosperm herbs and shrubs which are periodically inundated by the sea. They are largely confined to temperate regions, although areas of saltmarsh may occur on the landward side of mangrove vegetation in less humid tropical regions (Macnae, 1968; Chapman, 1974a). In temperate regions saltmarshes tend to form along any coast that is sufficiently sheltered to allow deposition of particulate matter, and they form one of the most important and abundant environments of the land/sea interface (e.g. Teal and Teal, 1969). In this chapter the term saltmarsh will be taken to include the whole area between

the lowest zone of angiosperm vegetation (excluding the 'sea-grasses') and the limit of coverage by extreme high water of spring tides.

The insect fauna of marine saltmarshes has been little studied and is often considered to be of negligible importance; Chapman (1974a), for example, in a 492-page book on saltmarshes and salt deserts devotes 3 sentences to insects. However, investigations on the trophic relations of the *Spartina alterniflora* marshes of the Atlantic coast of North America show that insects can be of significance in the marsh ecosystem (e.g. Smalley, 1960; Teal, 1962; Marples, 1966), and general surveys indicate that the saltmarsh insect fauna can be varied and abundant (e.g. Paviour-Smith, 1956; Davis and Gray, 1966; Stebbings, 1971; Cameron, 1972). Saltmarshes form the breeding habitats of a number of medically important insect species, in particular mosquitoes and other obnoxious biting Diptera (e.g. Thomson, 1951; Daiber, 1974; see also Chs. 12, 13 and 15). It may be noted that what appear to be the first recorded marine insect species were found in a marine saltmarsh (Burrell, 1812). It is in the intertidal saltmarshes that the marine insect fauna is most rich and abundant.

This chapter will not present a detailed list of the insect species that have been recorded from marine saltmarshes; such information may be more appropriately sought in the review chapters. We will instead consider the problems (and advantages) that are presented to insects which inhabit this marine environment and the way in which such insects negotiate these problems.

## 2.2 THE INSECT FAUNA

Saltmarsh insects are not easily defined. Definition is complicated by the presence of a large number of vagrants and of other species whose range includes habitats other than saltmarshes. We shall here consider those species that have a habitual requirement for some part of the saltmarsh environment at some stage of their life cycle.

Species from all the major insect orders have been recorded from marine saltmarshes: the Diptera, Coleoptera and Hemiptera appear to predominate, comprising more than 75% of the total number of species recorded (Fig. 2.1).

The insect fauna can conveniently be divided into aquatic, subterranean and surface-living groups. Aquatic species are invaders of freshwater origin and include dipterous larvae (especially those of the Culicidae, Chironomidae and Ceratopogonidae), heteropterans, coleopterans and certain trichopteran larvae (cf. Nicol, 1935; Balfour-Brown, 1958; Sutcliffe, 1961; Green, 1968). The subterranean and surface-living forms are regarded as being of terrestrial origin and include representatives of most major insect orders.

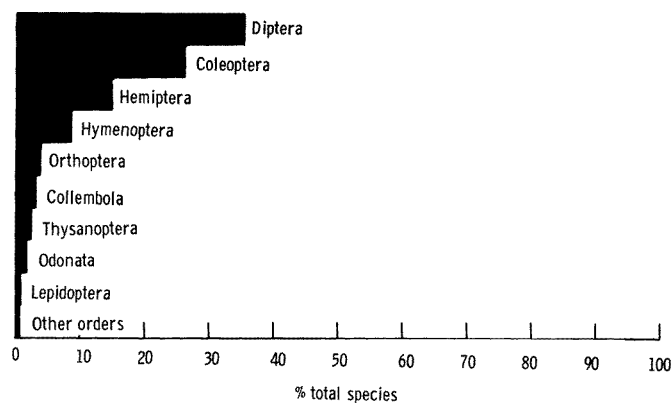

Fig. 2.1. Ordinal composition of saltmarsh insect species. The diagram gives an indication of the relative importance of the different insect orders in the saltmarsh insect fauna. The data is taken from five papers, each of which gives a detailed list of the insect fauna of a particular saltmarsh (Nicol, 1935; Paviour-Smith, 1956; Davis and Gray, 1966; Stebbings, 1971; Cameron, 1972, detailed list supplied by author). Total number of species, 308. Unidentified species of identified genera are included, unidentified genera are not. A small but unspecified number of the species are vagrants.

### 2.3 THE SALTMARSH

Chapman (1974a,b) has divided the saltmarshes of the world into nine groups. Very little is known about the flora, and still less about the fauna, of several of these groups, and most attention has been devoted to the Northern European and Western Atlantic groups. However, despite considerable variation in the nature of the plant species and the soil structure in different areas, a generalized plan of a saltmarsh may be made (Fig. 2.2). A marine saltmarsh consists essentially of a gently sloping plateau of herbaceous and shrubby vegetation growing in a relatively sheltered intertidal area. The demarcation on the seaward side of the marsh is usually fairly clear, the vegetated regions giving way to areas uncolonized by higher plants other than *Zostera* and other 'sea-grasses'. The boundary of the marsh on the landward side is generally much less discrete and depends greatly on the local conditions: frequently, freshwater influence can create extensive zones of intermediate character (e.g. Chapman 1974a; Macdonald and Barbour, 1974).

A number of subhabitats within the marsh can be described (Fig. 2.2a). The marsh surface may be divided into low or submergence marsh and high or emergence marsh (Chapman, 1960; Ranwell, 1972). The distinction cannot be precisely defined but it is nevertheless useful; low marshes are dominated by factors associated with submergence (e.g. reduced light intensity, greater mechanical disturbance), and high marshes are dominated by factors associated with emergence



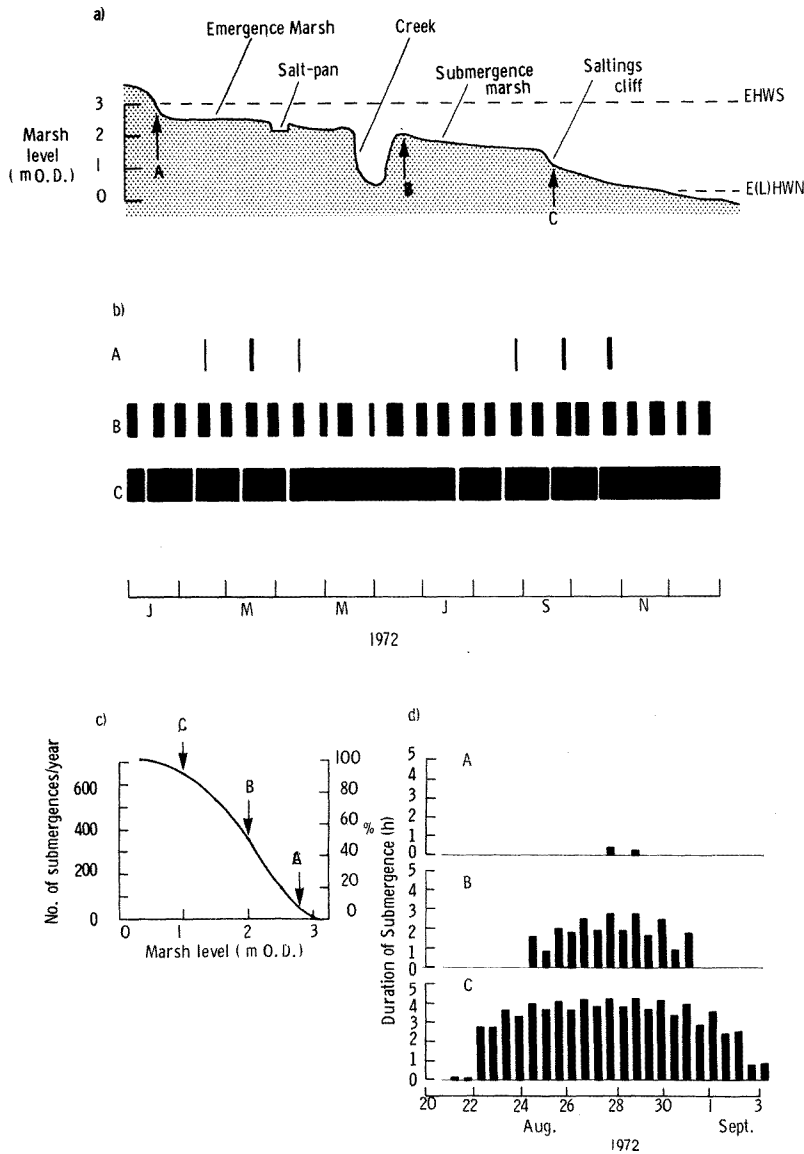

Fig. 2.2. Pattern of tidal inundation on a saltmarsh. The data were obtained from Admiralty Tide Tables (1972) and from observations on Scolt Head, Norfolk, U.K. (a) Cross-section of a marsh, showing sub-habitats and maximum tidal range. EHWS, extreme high water spring tide; E(L)HWN, extreme (lowest) high water neap tide: all high tides fall within this range. Heights of the three sites above Ordnance Datum (O.D.) in metres: A, 2.8 m; B, 2.0 m; C, 1.0 m. (b) Annual pattern of tidal inundation. Black bars indicate periods when the tide covered a particular site at least once daily for two or more consecutive days. (c) Number of submergences per year in relation to height above O.D. (d) Duration of tidal inundation at the three sites during a tidal cycle that included a high spring tide.

(e.g. higher and more variable salinity, reduced mechanical disturbance). Drainage channels or creeks are a characteristic feature of saltmarshes (e.g. Chapman, 1960; Pethick, 1969, 1971). Artificial drainage dikes, designed for the control of mosquitoes, are common in some marshes of the Atlantic Coast of the USA (Daiber, 1974). Salt-pans, depressions in the marsh surface uncolonized by higher plants and usually containing water, are also a common feature of saltmarshes (Yapp et al., 1917; Pethick, 1974). Frequently at the seaward margin the saltmarsh ends in a small steep cliff (e.g. Green, 1968; Dalby, 1970; Packham and Liddle, 1970).

Regular tidal inundation is the major factor that distinguishes marine saltmarshes from other areas of angiosperm vegetation. The pattern of tidal coverage on marine saltmarshes is complex and variable. The lowest regions are generally submerged twice daily, whereas the highest levels are covered only a few times each year (Fig. 2.2b-d). The duration of submergence can vary widely. In some saltmarshes, the duration of normal tidal submergence may be very prolonged; a continual submergence of 23 1/2 h was recorded by Hubbard (1969) around the lowest *Spartina* plants in a marsh on the South coast of England. However, in most of the saltmarshes that have been studied, the maximum period of submergence is about 5 h, although this will be exceeded in abnormal weather conditions. Considerably longer periods of coverage can also occur locally in salt-pans and other poorly drained areas.

The duration of submergence experienced by saltmarsh insects can also depend upon the type of vegetation with which they are associated. A root-living species in poorly drained areas can be effectively submerged for extended periods, whereas those living on the aerial parts of the vegetation can avoid submergence or be covered by only the most extreme of high tides.

Saltmarsh soils are extremely varied in structure and composition. Relatively unstructured soil with low organic content and poor development of pore spaces is a characteristic feature of many temperate saltmarsh habitats (e.g. Adriani, 1945; Teal and Kanwisher, 1961; Wieser and Kanwisher, 1961; Clarke and Hannon, 1967, 1969; Macleod, 1967; Brereton, 1971; Redfield, 1972). In general, as a saltmarsh develops, there is a decrease in the proportion of sand and an increase in organic matter and pore spaces (Ranwell, 1972). In submergence marsh, the restricted pore structure frequently produces prolonged waterlogging of the soil following tidal coverage (Fig. 2.3). Effective drainage generally occurs only at marsh edges and in the soil bordering creeks and salt-pans (Chapman, 1960; Foster and Treherne, 1976). In edge regions, the soil has an enlarged pore structure, usually in the form of extensive cracks and fissures (Macleod, 1967; Foster and Treherne, 1975), which are suitable for colonization by insects and other marine invertebrates.

Saltmarshes contain a number of unstable habitats. The general pattern of drainage creeks is stable, but the detailed topography of creek margins is continually

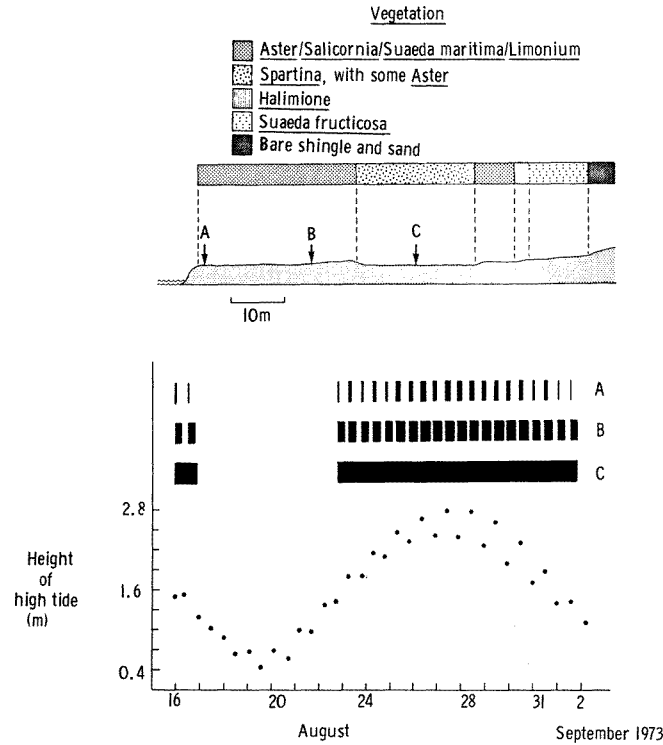

Fig. 2.3. Tidal coverage in relation to height of tides and saltmarsh topography. The upper diagram shows vegetation and position of the three sites (A, B and C) at which tidal coverage was measured. The black bars on the lower diagram indicate the periods of coverage of the soil surface at the three sites during tidal inundation. Observations made at Scolt Head, Norfolk, U.K. (from Foster and Treherne, 1976).

changing, and eroded creek banks are a familiar feature of saltmarshes (Yapp et al., 1917; Steers, 1969; Dalby, 1970; Packham and Liddle, 1970; Redfield, 1972). In addition, accretion is a relatively rapid process in submergence marshes (Ranwell, 1972). The instability of edge regions is of fundamental importance, since it is to such regions that a number of soil-living species are largely confined (Green, 1968; Evans et al., 1971; Foster and Treherne, 1975).

The tidal inundation of marine saltmarshes creates conditions of high and fluctuating salinity. Teal (1962), for example, states that the salinity of the mud in a Georgia saltmarsh ranges between 5 and 70<sup>0/00</sup> and that soil animals are exposed to an average salinity variation of 20–30<sup>0/00</sup>. On submergence marshes, salinity approximates to that of the sea water which bathes it, but on emergence marshes, considerable variations in salinity occur as a result of evaporation and the input of rain and freshwater (Ranwell, 1972). In subtropical marshes, very high surface salinities have been recorded: Purer (1942) reported a salinity range

of 5–234<sup>0/00</sup> in the soil water of Californian saltmarshes. The salinity of saltmarsh pools can also vary widely; Nicol (1935) observed that the salinity of Scottish saltmarsh pools could vary from 8 to 40<sup>0/00</sup>, Sutcliffe (1961a) recorded similar salinity fluctuations in saltmarsh pools on the north-east coast of England, and Purer (1942) recorded a salinity range of 12–140<sup>0/00</sup> in saltmarsh pools in California.

## 2.4 RESPIRATORY PROBLEMS AND ADAPTATIONS

Saltmarsh insects of terrestrial origin face the problem of occasional separation from their normal oxygen supply; aquatic insects, however, encounter no special respiratory problems in calm saline waters. For surface-living species this separation will not normally exceed five hours and may be avoided by behavioural adaptations. Such avoidance is well exemplified by laboratory and field observations of the responses of twelve species (2 Orthoptera, 4 Heteroptera, 2 Homoptera, 2 Dipdera, 2 Coleoptera) to a rising tide (Davis and Gray, 1966). On this North Carolina saltmarsh, no insects were observed to be submerged by inundating tides. Submergence was avoided by flight, climbing, or movement on the surface film. Other examples of insects avoiding tidal coverage are given by Arndt (1914), Teal (1962), Payne (1972), Ranwell (1972), Eisikowitch and Woodell (1975) and Polhemus (Ch. 9, this volume).

However, avoidance mechanisms are not universally adopted. Cameron (1975), for example, observed that periodic tidal inundation had little effect on the numbers or composition of the adult insect fauna on a Californian saltmarsh. This contrasts with Davis and Gray's (1966) findings, perhaps because their laboratory observations were made at 22–25°C, whereas Cameron's field observations were made in the morning hours, when the temperature rarely exceeded 20°C. There are a number of earlier records of saltmarsh insects that remain submerged during tidal inundation (e.g. Mason, 1889; Arndt, 1914; Metcalf and Osborn, 1920; Brown, 1948; Paviour-Smith, 1956; Eisikowitch and Woodell, 1975). In any case, a proportion of the saltmarsh insect fauna is relatively immobile, for example shoot-feeding aphids and coccids, and immature stages such as the larvae and pupae of Diptera and Lepidoptera; many such insects are inevitably submerged by high tides. A number of surface-living insects become quiescent during submergence by the tide (Mason, 1889; Miall, 1902; Arndt, 1914; Brown, 1948), and it is probable that this is a behavioural adaptation to conserve oxygen: many terrestrial insects struggle violently when submerged in seawater (Miall, 1902; Foster, unpublished observations; Hinton, Ch. 3).

No detailed studies of respiratory mechanisms of surface-living intertidal insects have been made, although it has been shown that there is great variation in survival during laboratory submergence (e.g. Audouin, 1833; Coquerel, 1850;

Plateau, 1890; Imms, 1906; Arndt, 1914; Metcalf and Osborn, 1920; Alluaud, 1926; China, 1927; Saunders, 1928; Le Masne, 1938; Brown, 1948; Evans et al., 1971; Abraham, 1972; Chan and Trott, 1972; Eisikowitch and Woodell, 1975; Foster and Treherne, 1976). Many of these studies, as emphasized by Alluaud (1926) and by Davis and Gray (1966), were not related to submergence conditions in the field, and therefore the significance of the relative tolerances to submergence are frequently unclear. However, the tolerances of adults of the salid *Halosalda lateralis* (Fallen) and of adults and larvae of another salid *Saldula palustris* (Douglas) can be related to their relative positions on the saltmarsh (Brown, 1948). Another example is provided by the aphid *Staticobium limonii* Contarini, which exhibits a 50% mortality after 12–20 h submergence, an adequate response for the aphid's survival in the field, and contrasts with the much greater tolerance of the subterranean root-aphid *Pemphigus trehernei* Foster (Fig. 2.4) which experiences longer periods of submergence on

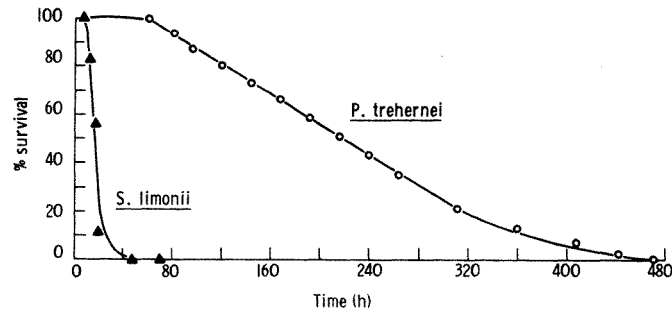

Fig. 2.4. Survival of adults of the root aphid, *Pemphigus trehernei*, and shoot-feeding aphid, *Staticobium limonii*, during submergence in aerated sea-water at 20°C (from Foster and Treherne, 1976).

the tidal saltmarsh (Foster and Treherne, 1976b). It is most probable that the survival of many submerged surfaceliving insects is assisted by the presence of air stores in the form of trapped air bubbles, which have frequently been described and which could conceivably function as effective physical gills. These insects may also possess plastrons (cf. Hinton, 1966), although none has yet been described in the literature; both plastrons and temporary air stores would be effective in respiration because of the relatively aerated nature of the flooding tidal waters.

Subterranean insects are potentially vulnerable to the prolonged deterioration in soil aeration that can result from tidal inundation. These conditions commonly occur in poorly drained regions of marine saltmarshes (Fig. 2.3). The restriction of the root aphid *P. trehernei* to edge regions in submergence marshes, for example, appears to result from the poor drainage observed in the rest of the marsh (Fig. 2.5) (Foster and Treherne, 1975, 1976). A similar 'edge effect' has also been

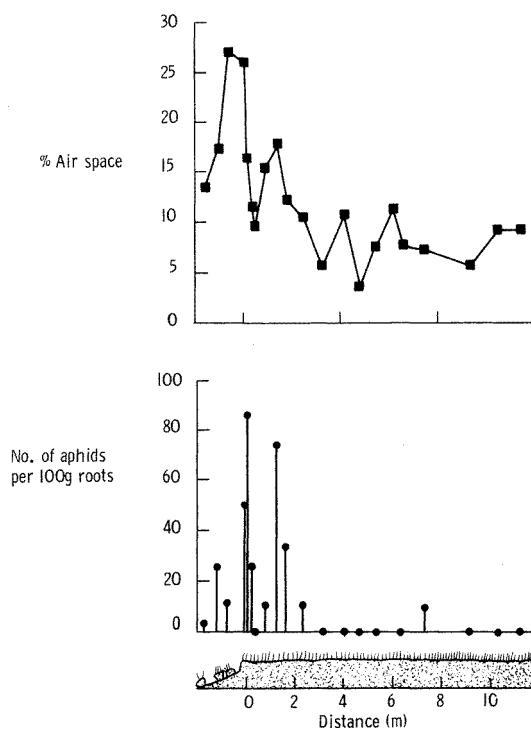

Fig. 2.5. Density of the root aphid, *P. trehernei*, and % soil air space along a transect on a submergence marsh at Scolt Head, Norfolk, U.K. (from Foster and Treherne, 1975).

described for other insect species, for instance some beetles (Evans et al., 1971) and a collembolan (Green, 1968).

During tidal submergence, air is usually trapped within the surface layers of the marsh soil (cf. Chapman, 1960; Clarke and Hannon, 1967), and it is generally assumed that soil insects are not directly exposed to sea water. The use of physiological responses to natural field submergence indicates that the burrows of three species of beetle (*Bledius spectabilis* Kraatz, *Dicheirotichus gustavi* Crotch (= *pubescens* Paykull), and *Bembidion laterale* (= Samouelle)) are not flooded during tidal coverage (Evans et al., 1971). A proportion of the individuals of *Heterocerus fenestratus* Thunberg (about 16%) were, however, found to be vulnerable to flooding of their relatively shallow burrow systems. The silk lining of the burrows of the pyralid larva *Scoparia tetracycla* Meyr (Paviour-Smith, 1956), and the waxing of the soil cavities inhabited by the aphid *P. trehernei* (Foster, 1975) and *Aploneura lentisci* (Passerini) (Foster, 1974) have been suggested to confer waterproofing properties.

The conditions in soil air cavities deteriorate during prolonged tidal coverage. This is shown by the responses of the aphid *P. trehernei* to artificial submergence

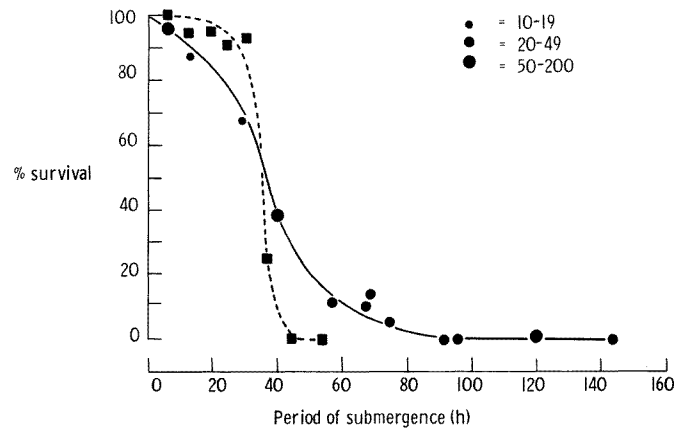
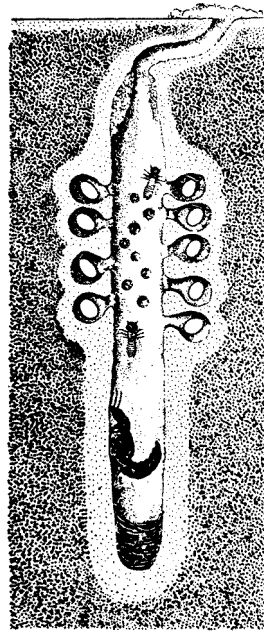

Fig. 2.6. Survival of the aster root aphid, *P. trehernei*, during experimental submergence in the field (circles) and in oxygen-deficient sea-water (18–20°C) in the laboratory (squares). The size of the circles indicates the number of aphids (2nd-4th instars and adults) recovered in the field experiments. Adult aphids (23–25 individuals for each reading) were used in the laboratory experiments (from Foster and Treherne, 1976).



5 mm

Fig. 2.7. Maternal burrow of the beetle *B. spectabilis*, showing multiple egg chambers and 1st instar larvae which are kept in the burrow (from Bro Larsen, 1950).

in the field (Fig. 2.6); the observed mortality and recovery from anoxia were found to be similar to those recorded in oxygen-deficient seawater in laboratory experiments (Foster and Treherne, 1976). It is proposed that the sustained deterioration in soil aeration in non-edge marsh soil is a primary factor in restricting the aphid to well-drained edge regions.

The adverse effects of anaerobic mud on the oxygen conditions within the burrows of *Bledius spectabilis* have been shown to be counteracted by the ventilatory activity and constant digging of the insects (Bro Larsen, 1952). Unlike most *Bledius* species, *B. spectabilis* does not lay its eggs in single soil cavities but maintains them in a multiple chamber which is ventilated daily (Fig. 2.7). The first instar larvae are kept in the well-ventilated maternal burrow as, it is suggested, they are too small to excavate and ventilate adequately their own burrows (Bro Larsen, 1952).

Four species of beetle rapidly become immobile when submerged in well-oxygenated seawater (Evans et al., 1971). When *Dicheirotichus gustavi* was submerged its oxygen consumption rapidly declined (Fig. 2.8). Return to air resulted in a relatively slow recovery in locomotory activity and an increased oxygen consumption, indicating an oxygen debt. *Heterocerus fenestratus*, the species most liable of the four to flooding of its burrow system (Evans et al., 1971), differed from the others in showing a relatively rapid recovery from anoxia (Fig. 2.9). The immobility which is rapidly induced in several insect species by submergence is perhaps a response to contact with water rather than a shortage

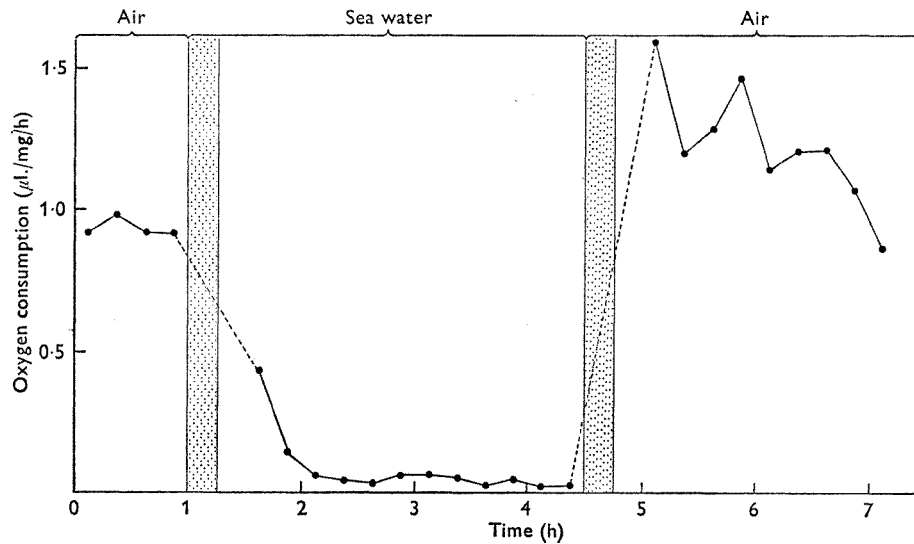

Fig. 2.8. The effect of submergence in sea water on the oxygen consumption of adult *Dicheirotichus gustavi* (five individuals). The shaded areas indicate the equilibration period allowed on introduction and removal of sea-water from the manometer flasks (from Evans et al., 1971).



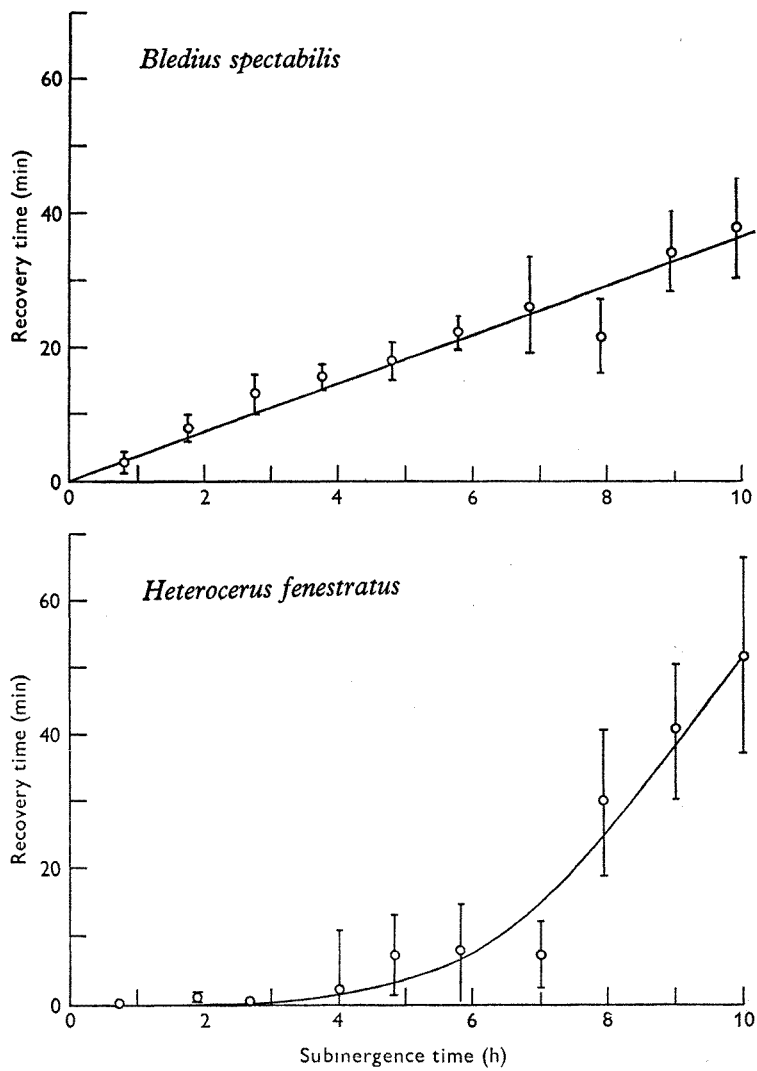

Fig. 2.9. The times of recovery from anoxia, produced by varying periods of submergence in sea water, in adult beetles, *B. spectabilis* and *H. fenestratus*. The symbols indicate the mean and 95% confidence limits (from Evans et al., 1971).

of oxygen (Hinton, 1961). It has recently been proposed that the rapid development of anoxia by shore animals is a physiological adaptation to stranding, and in the xiphosuran *Limulus* it has been shown to be a neurally-mediated response (Thompson and Page, 1975). This response will presumably ensure that the limited oxygen supply is not rapidly depleted and it is perhaps analogous to the behavioural response of quiescence during tidal flooding shown by some saltmarsh insects.

Some subterranean saltmarsh insects may make use of plastrons for respiration (see Section 3.4). For example, pupae of the dolichopodid *Aphrosylus*, some species of which are common in saltmarshes (Dyte, 1959), possess plastronbearing spiracular gills. The structure, function and evolution of such gills in the pupae of marine Diptera is discussed by Hinton (1966, 1967a,b,c, 1968), who has shown that the plastron can be effective even for flies which breed in the lower part of the intertidal zone. In addition, larger air stores surrounding the insect, providing that they are not destroyed by the pressure of the flooding tide, may function as plastrons. For example, the cocoon of the pupae of dolichopodids can act as a plastron (Hinton, 1967b). Air stores trapped in the vicinity of rocky shore insects may act as physical gills (e.g. Walsh, 1925; Alluaud, 1926; Glynne-Williams and Hobart, 1952; Morton, 1954). On saltmarshes, the soil burrows of beetles and of caterpillars, and the wax-lined cavities around soil aphids and coccids could act as physical gills. Such physical gills will of course be effective only in well-aerated conditions and not in poorly-drained anaerobic soil.

An additional potential source of oxygen for saltmarsh insects is provided by the roots of halophytes, which in many species are abundantly supplied with aerenchyma (Purer, 1942; Anderson, 1974) through which oxygen may diffuse from the shoots (Teal and Kanwisher, 1966). A number of insect species obtain oxygen from plant roots, and methods of piercing plant tissue have been evolved in several species of Coleoptera and Diptera (cf. Varley, 1937; Hartley, 1958; Houlihan, 1969a,b, 1970; Gillett, 1971). Larvae and adults of *Haemonia mutica* F. (= *curtisi* Lac.) have been reported from *Zostera* and *Ruppia*, from which they apparently obtain a supply of oxygen (Carpenter, 1928; Portevin, 1934; Wesenberg-Lund, 1943). There are no records of beetles obtaining oxygen from plants of the true saltmarsh flora. Although *Mansonia perturbans* (Walker) is one of the first mosquitoes to become established after impoundment of high-level marshes (Daiber, 1974), there are apparently no detailed observations of saltmarsh mosquito species which can obtain oxygen from plants. There appear to be no published accounts of this mode of respiration in saltmarsh species of other dipteran genera (e.g. *Erioptera*, *Chrysops*) that contain species able to tap plant air-spaces (Hinton, 1953; Houlihan, 1969b). In view of the anaerobic nature of the soil of many saltmarsh habitats and the possession of aerenchyma by a number of halophytes, it is highly probable that this mode of respiration is more widespread in saltmarsh insects than is now apparent.

## 2.5 OSMOTIC AND IONIC PROBLEMS AND ADAPTATIONS

The high and often widely fluctuating salinities of saltmarsh habitats create obvious difficulties for insect invaders from freshwater and terrestrial environments.

Saltmarsh insects exhibit a wide range of tolerances to environmental salinity. This range is well illustrated by the larvae of aquatic dipterans found in various saltmarsh situations (Fig. 2.10). Species such as *Chironomus aprilius* Meigen and *C. halophilus* Kieffer are able to cope with brackish water conditions. Some species (e.g. *Chironomus salinarius* Kieffer, *Cricotopus vitripennis* var. *halophilus* Kieffer and *Aedes taeniorhynchus* Wiedemann) can tolerate prolonged exposure to seawater, whereas others (e.g. *Ephydra riparia* Fallén, *Aedes caspius* Pallas, *A. detritus* Haliday and *Opifex fuscus* Hutton) are adapted to withstand hypersaline conditions. The larvae of aquatic diptera do not of course occur in natural waters throughout the range of salinities shown in Fig. 2.10; the most important mechanism limiting that distribution, at least in mosquito species, is the discrimination of the ovipositing female (e.g. Clements, 1963; Macan, 1974).

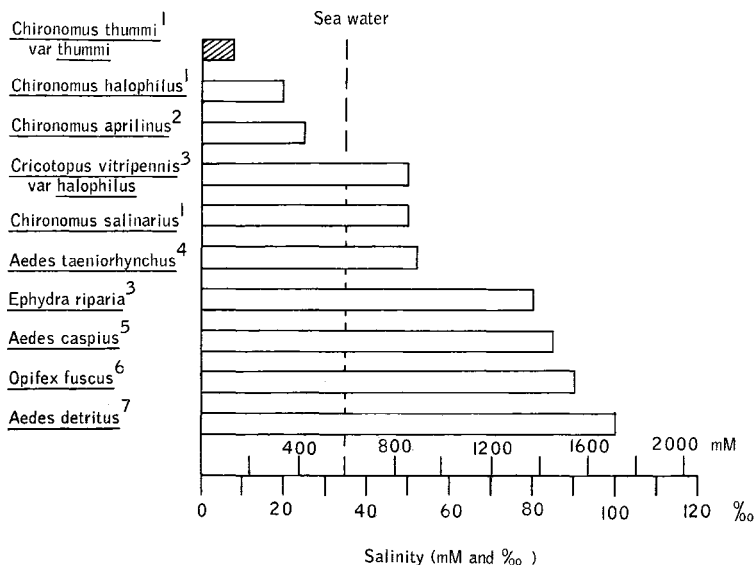

Fig. 2.10. Salinity tolerances of some dipterous larvae from saltmarshes compared with that of a freshwater species (*Chironomus thummi* var. *thummi*). Data from: (1) Neumann, 1961; (2) Sutcliffe, 1961a; (3) Sutcliffe, 1960; (4) Nayar and Sauerman, 1974; (5) Cambouranc, 1937 (quoted in Beadle, 1939); (6) McGregor, 1965; (7) Beadle, 1939.

Many of the insects which have adapted to saltmarsh conditions have done so by the development of effective mechanisms for the regulation of the ionic and osmotic concentrations of the body fluids. Insects of terrestrial origin encounter a potentially similar physiological problem, during submergence, to that experienced in dry terrestrial environments, that is a tendency for water-loss caused by the relatively high osmotic concentration of seawater. This tendency is minimized by the efficient waterproofing of the integument of terrestrial insects

(cf. Beament, 1964; Ebeling, 1964; Neville, 1975) and of some aquatic species (Beament, 1961). The extreme impermeability of the integument to salts (cf. Shaw and Stobbart, 1963; Stobbart and Shaw, 1974) implies that both aquatic and terrestrial species face additional physiological problems which arise largely from the ingestion of food of high salinity.

The problems caused by a saline diet can be lessened by behavioural adaptations which enable individuals to select food of the lowest available salinity. Thus the staphylinid beetles *Bledius furcatus* Olivier (= *taurus* Germ) and *B. diota* Schiødte, which experience extreme fluctuations in environmental salinity, often collect food stores immediately after rain to avoid the ingestion of high salt concentrations (Bro Larsen, 1952). *B. spectabilis* (which lives in a lower marsh situation of more stable salinity) also selects food of the lowest available salt content and shows a reduced dietary intake at higher salinities (Bro Larsen, 1953). The larvae of a saltmarsh caddis fly, *Limnephilus affinis* Curtis, drink only small quantities of salt water, equivalent to 3–7% of the body weight per day, as compared with freshwater species which consume amounts equivalent to 50% of the body weight per day (Sutcliffe, 1962).

Saltmarsh insects have evolved ionic and osmoregulatory mechanisms of varying efficiencies which enable them to counteract the effects of exposure to high, and often fluctuating, salinities. Some dipterous larvae, for example *Opifex fuscus* (Nicolson, 1972), *Aedes taeniorhynchus* (Nayar and Sauerman, 1974), *Ephydra riparia* and *Aedes detritus* (Fig. 2.11), can maintain relatively stable osmotic

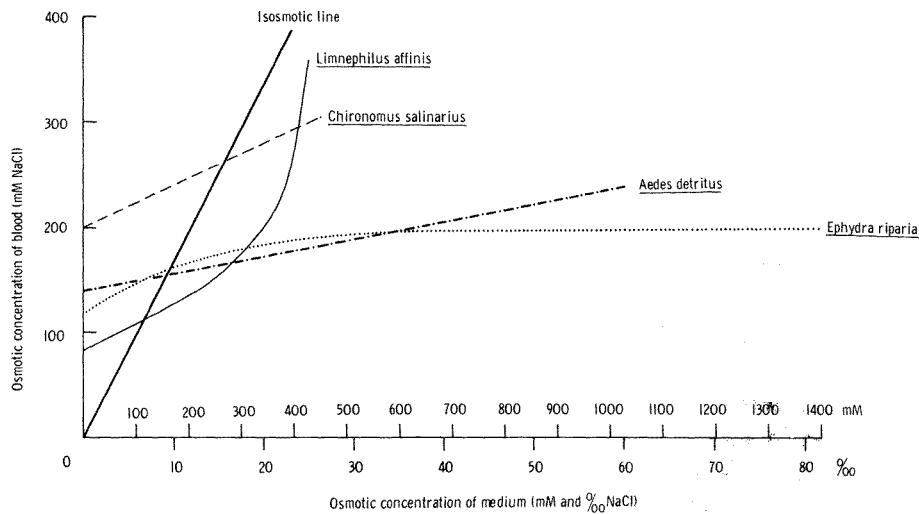

Fig. 2.11. The effects of variation of the salinity of the medium on the osmotic concentration of the blood of some representative saltmarsh insects. Data for *L. affinis* from Sutcliffe (1961b), for *E. repara* from Sutcliffe (1960), for *A. detritus* from Beadle (1939) and for *C. salinarius* from Neumann (1961).

concentrations in the blood when exposed to a wide range of external salinities. Other insects, such as larvae of the corixid *Sigara stagnalis* (Leach) [= *lugubris* (Fieber)] (Claus, 1937), the dipterans *Chironomus aprilinus* (Sutcliffe, 1959) and *C. halophilus* (Neumann, 1961) and the trichopteran *Limnephilus affinis* (Fig. 2.11), can maintain the blood below the osmotic concentration of the external medium only over a limited range of salinities. In these species effective regulation breaks down at external concentrations below that of seawater. These limited osmoregulatory abilities, which are nevertheless much greater than those of related freshwater species (cf. Shaw and Stobbart, 1963; Stobbart and Shaw, 1974), enable the insects to survive the brackish water conditions experienced in some saltmarsh situations and limited periods of exposure to undiluted seawater (Sutcliffe, 1961a). *Chironomus salinarius*, which has limited osmoregulatory abilities (Fig. 2.11) but can survive exposure to 5.0% NaCl (Neumann, 1961), is regarded as being intermediate between fully saltwater and brackish water species (Stobbart and Shaw, 1974). As with *L. affinis* (Sutcliffe, 1961b) and *C. aprilinus* (Sutcliffe, 1959), *C. salinarius* withstands saline waters by its ability to tolerate increased osmotic concentrations in the blood. This is particularly so with the larvae of *L. affinis* which can withstand a 3-fold increase in the osmotic concentration of the blood (Fig. 2.11; Sutcliffe, 1961b).

With efficient osmoregulators, such as *E. ripara* (Sutcliffe, 1960) and (to a lesser extent) *A. detritus* (Beadle, 1939) and *O. fuscus* (Nicolson, 1972), blood chloride is maintained at relatively constant concentrations at the higher salinity ranges illustrated in Fig. 2.11. In *L. affinis*, on the other hand, an increase in electrolyte concentration contributes to the observed rise in osmotic concentration of the blood with increasing salinity of the external medium (Fig. 2.12). The rise in sodium level, however, occurs less rapidly than the osmotic concentration, until sodium regulation breaks down at around 400 mM Na. The divergence in the increases of osmotic and electrolyte concentrations has been suggested to result from an additional regulation of the non-electrolyte fraction of the blood (Sutcliffe, 1961b). This regulation is assumed to involve a release of osmotically-active organic molecules into the blood which tends to reduce the osmotic gradient between the blood and the external medium at higher salinities. This mechanism is probably associated with the relatively high water permeability of the integument of *L. affinis* (Sutcliffe, 1961b) which would make it metabolically expensive to maintain hyposmotic blood. In *A. detritus*, which maintains markedly hyposmotic blood (Fig. 2.11), the general body surface is relatively impermeable to water (Beadle, 1939). This impermeability is reinforced by a reduction in the surface area of the permeable papillae (Beadle, 1939). Quantitative measurements on the larva of *O. fuscus* also indicate a low water permeability of the integument, the diffusional water permeability of  $4.8 \times 10^{-3} \text{ cm l}^{-1}$  (Nicolson and Leader, 1974) being an order of magnitude less than that of freshwater insects (cf. Shaw, 1955; Staddon, 1966).

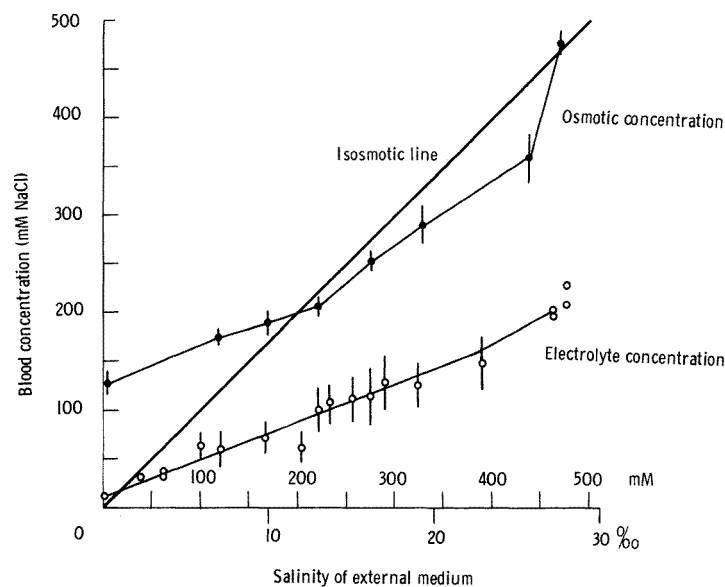

Fig. 2.12. The relationship between the osmotic and electrolyte concentration (conductivity) of the blood and the salt concentration of the medium for larvae of *L. affinis* (redrawn from Sutcliffe, 1961b).

Ingested sea water rapidly achieves osmotic equilibrium with the blood in the midgut of larvae of *A. detritus* (Fig. 2.11) (Ramsay, 1950). This could result either from a net entry of water from the blood or from the active uptake of ions from the midgut fluid. Isotonicity with the blood is also maintained in the intestinal fluid, which implies that the Malpighian tubules are unable to produce a fluid more concentrated than the blood, but a dramatic concentration occurs in rectal fluid (Fig. 2.13). Hypertonic rectal fluids also occur in *L. affinis* (Sutcliffe, 1961b), *E. riparia* and *Coleopa frigida* F. (Sutcliffe, 1960) in saline media. The elaboration of hypertonic rectal fluid represents a physiological specialization for insects of freshwater origin, for in most freshwater insects regulation in dilute media involves the production of rectal fluid which is hypotonic to the blood (cf. Stobbart and Shaw, 1974). Terrestrial insects, on the other hand, are able to maintain rectal fluids which are markedly hypertonic to the blood (cf. Maddrell, 1971). The ability of saltmarsh insects of terrestrial origin, such as the staphylinid *B. spectabilis* (Bro Larsen, 1952), to produce hypertonic rectal fluid can thus be regarded as a pre-adaptation. In terrestrial species it is well established that the removal of water from the rectal lumen is achieved by a mechanism involving solute recycling within the large cells and associated intercellular spaces of the rectal epithelium (Berridge and Gupta, 1967; Berridge, 1970). This mechanism appears to be physiologically unique in that uphill water movements are, unlike those in the vertebrate kidney, produced by the activities of a single cellular layer.

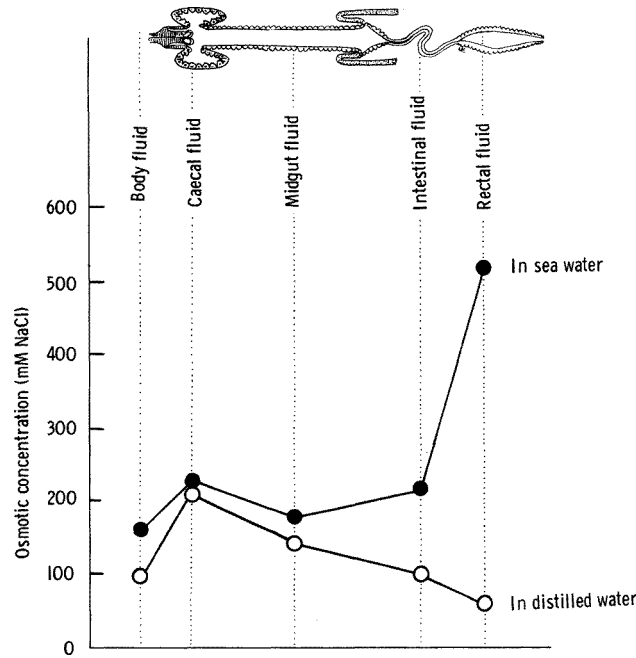

Fig. 2.13. The osmotic concentrations of the fluid in the gut lumen of larvae of *A. detritus* kept in sea-water and distilled water (redrawn from Ramsay, 1950).

In terrestrial species an active transport of inorganic ions from rectal lumen into the blood is known to occur (cf. Maddrell, 1971). In a saline environment such a net transport of ions into the blood would be physiologically inappropriate. It has recently been shown in an aquatic saltmarsh larvae (*A. taeniorhynchus*) that a hyperosmotic fluid is produced in a specialized terminal region of the rectum by ion transport from the blood into the lumen (Bradley and Phillips, 1975). This transport mechanism can thus be regarded as a physiological adaptation to a saline environment.

Excretion of absorbed sulphate ions is achieved by transport through the Malpighian tubules in *A. taeniorhynchus* in hypersaline media (S.H.P. Maddrell and J.E. Phillips, personal communication). The Malpighian tubules of larvae reared in sulphate-free media lack this ability. It has been shown, however, that on transfer to hypersaline media the elevated sulphate concentration rapidly induces transport of this anion by the Malpighian tubules.

The maintenance of osmotic and ionic homeostasis in saline conditions may necessitate the expenditure of considerable metabolic energy. This is well illustrated by larvae of the corixid *Sigara stagnalis* (Leach) [= *lugubris* (Fieber)] which showed a spectacular increase in oxygen utilization when salinity was increased above 6<sup>0/00</sup> and a smaller increase with decreased salinity (Claus, 1937)

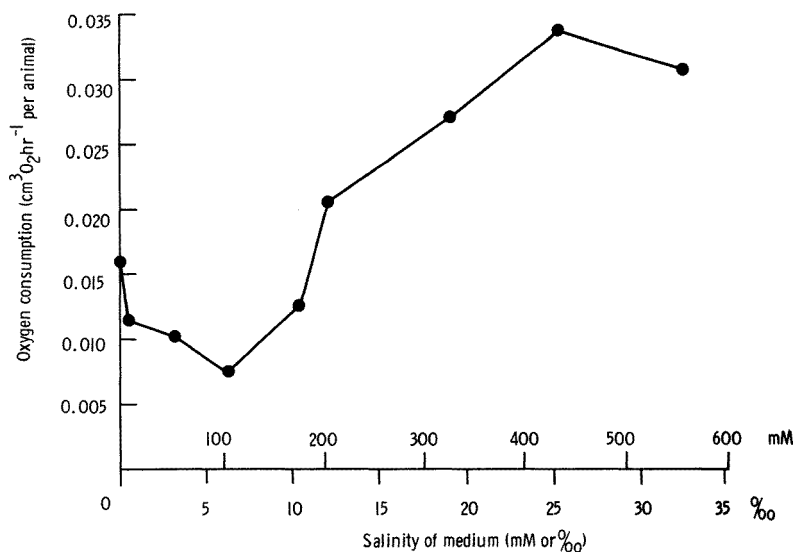

Fig. 2.14. The oxygen consumption of larvae of *Sigara lugubris* (= *stagnalis*) in media of various salinities (redrawn from Claus, 1937).

(Fig. 2.14). This suggests that the invasion of marine saltmarshes by freshwater and probably terrestrial insects could be metabolically expensive. It is conceivable that the low rate of sulphate pumping by Malpighian tubules of *A. taeniorhynchus* in dilute media, which contrasts with the high rate observed in hypersaline conditions (S.H.P. Maddrell and J.E. Phillips, personal communication), could represent a mechanism for the conservation of metabolic energy. In terrestrial species (*Rhodnius prolixus* Stal), in contrast, the unadapted Malpighian tubules show a uniformly high rate of oxygen consumption whether or not they are involved in ion transport (S.H.P. Maddrell and B.O.C. Gardiner, personal communication).

The necessity for an appreciable energy expenditure in osmotic work implies that it could be a limiting factor in the invasion of marine saltmarshes by insects of freshwater and terrestrial origin. Insect species could thus be at a disadvantage as compared with marine competitors or could experience difficulties in utilizing some potential sources of food on marine saltmarshes. For example, larvae of *A. taeniorhynchus* showed delayed onset of pupation at salinities of more than 25‰ seawater, and, with > 50‰ seawater, showed an increased number of pupation peaks (Nayar, 1967). The increased energy expenditure at higher salinities may delay the accumulation of sufficient reserves for pupation.



## 2.6 OTHER PHYSICAL FACTORS

### 2.6.1 Tide

Although saltmarshes are one of the most sheltered of intertidal environments, tidal inundation nevertheless presents mechanical difficulties for denizens of saltmarsh habitats. Many insects are delicate organisms, especially those with membranous wings, which could be vulnerable to damage during wetting with seawater: struggling winged insects on flooding tides are a common feature of saltmarshes (e.g. Edwards, 1973; Abraham, 1970). Sexuparae of the aphid *P. trehernei*, for example, are unable to fly after submergence in calm seawater, the delicate wings adhering to one another and to the insect's body (Foster, 1975). Similar effects were observed on alates of *Aphis tripolii* Laing and *Staticobium limonii*. Other examples of this vulnerability are the dipterans *Chaetopsis apicalis* Johnson and *Ch. fulvifrons* (Macquart), whose large membranous wings adhere to the surface film and prevent effective movement (Davis and Gray, 1966). However, the flying ability of homopterans with stronger wings, such as *Prokelisia marginata* Van Duzee (*Megamelus marginatus*) is unaffected by tidal submergence (Arndt, 1914). Insects such as beetles, which can protect their wings, are preadapted to withstand exposure to seawater.

As already emphasized, many potentially vulnerable insects can avoid submergence by retreating from the tide. Other winged insects may possess behavioural adaptations which tend to exclude them from the tidal regions of saltmarshes. Bumble bees (*Bombus* spp.), for example, are deterred from visiting saltmarsh *Armeria* plants, it is suggested, by the 'negative experience' of being deposited on the wet marsh surface by the bending of the inflorescence stalks (Eisikowitch and Woodell, 1975). The presence of standing water may also reduce the alighting of aphids on saltmarsh vegetation due to the increased reflectance of short wavelength light, which is known to reduce aphid alighting (cf. Kennedy et al., 1961; Kennedy and Fosbrooke, 1973). Field experiments have shown that water surfaces tend to reduce the alighting of flying aphids (Foster, 1974).

Insects are probably most at risk to the effects of submergence when they are newly born or moulted. For example, newly born apterae of the aphid *P. trehernei* are killed by a 2-h submergence (Fig. 2.15) (Foster and Treherne, 1976). In this case the cause of death could be the absence of an adequately waterproofed cuticle. Newly born and recently moulted aphids are very subject to surface forces and often become trapped in films of water. There is evidence for terrestrial insects that waterproofing is not complete immediately after ecdysis (Wigglesworth and Gillett, 1936; Smallman, 1942; Wigglesworth, 1948). This problem is probably of general significance for intertidal insects of terrestrial origin. For example, in a submerged colony of *Aphis tripolii* it was observed that the only aphids which died were those that had ecdysed during submergence (Foster, 1974). Larvae of

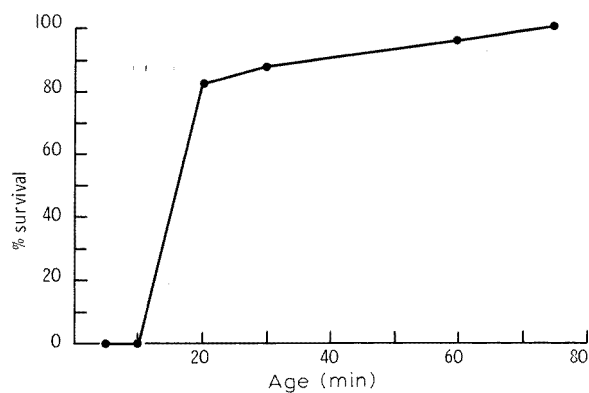

Fig. 2.15. Survival, in relation to age, of 1st instar aphids (*P. trehernei*) submerged for two hours in aerated sea-water at 20°C (from Foster and Treherne, 1976).

the beetle *Aepopsis* (= *Aepus*) *robini* Lab. which were submerged in seawater 10 days after eclosion survived considerably longer than those submerged 6 h after eclosion (Le Masne, 1938). Intertidal insects could reduce their vulnerability by more efficient waterproofing before ecdysis, by waterproofing their local environment (as does the root aphid *P. trehernei*), or by confining ecdysis and hatching to periods of low tides.

Saltmarsh insects may be washed away during tidal coverage. Paviour-Smith (1956) noted that a large proportion of the collembolan populations on a New Zealand saltmarsh were swept away on the incoming tide, and Dexter (1943) also observed transport of collembola (*Anurida maritima* (Guérin)) on the tide. Arndt (1914) suggested that a plant louse (Bdellidae) was washed away during high tides. High tides may denude whole areas of saltmarsh of their populations of Pteromalidae (Chalcidoidea) (Abraham, 1970). Saltmarsh mosquitoes do not usually breed in submergence marshes, perhaps because they cannot withstand frequent flushing out of their habitats by the tide (e.g. Connell, 1940). However, the saline-water mosquito *Anopheles gambiae* var *melas* (Theobald), although restricted in the intertidal zone to 'high' marsh areas of the mangal, characteristically completes its larval development during spring tides when the larvae are flooded every 12 h (Thomson, 1945). This undoubtedly leads to considerable wastage of eggs and larvae, but it is also ensures widespread dispersal (Thomson, 1945, 1951).

Many of the surface-living insects on saltmarshes are adapted to cling to vegetation during tidal submergence. The homopterans *Saldula saltatoria* (L.) (= *Salda saltatoria* L.) (Mason, 1889; Polhemus, Ch. 9) and *Prokelisia marginata* (Arndt, 1914) have been observed to cling tenaciously to vegetation during tidal submergence. Shoot-feeding aphids, such as *Aphis tripolii*, are anchored to their host plants by their embedded stylets. Surface-living beetles seek refuge beneath gravel and in sand during tidal coverage (Arndt, 1914).

### 2.6.2 Substrate

Saltmarsh insects are vulnerable to extreme changes in their habitats due to environmental instability, for example the erosion of edge regions. During erosion the abundant insect population of edge regions may be washed away. In submergence marsh, large eroded soil masses frequently fall into positions in which the insects and plants may not survive. In this situation it has been observed that a significant proportion of the aster root aphid *P. trehernei* can, however, escape and float to the surface (Foster and Treherne, unpublished observations). Such rapid erosion can cause large fluctuations in the aphid populations in saltings cliffs (Foster, 1974).

The relatively unstructured nature of saltmarsh soil, with its generally high clay content, low organic content, and poor development of pore spaces, apart from encouraging waterlogging, also presents problems for non-burrowing insects attempting to colonize subterranean habitats. For example, it is much easier for 1st instars of the aphid *P. trehernei* to penetrate the fissured soil surfaces of edge regions than the uniform 'floor' of non-edge regions in submergence marshes (Foster and Treherne, 1975). In addition, large aphid colonies are only found on asters whose roots grow in large soil pore spaces, such as those growing in shingle or potted in soil with artificially provided pore spaces. This physical effect of soil structure is probably an important factor in the restriction of the aphids in submergence marshes to the fissured soil of regions bordering the edges of creeks and salt-pans (Foster and Treherne, 1975).

### 2.6.3 Temperature

It is generally assumed that the sea has an ameliorating effect on the climate of saltmarsh soils, imposing a reduced range of temperature in comparison with adjacent regions not subject to tidal coverage (cf. Ranwell, 1972). Although few detailed observations have been made, those of Duff and Teal (1965) and Foster (1974), made on North American and European marshes, respectively, confirm this view: extreme and rapidly changing temperatures were confined to the higher marshes not covered by the sea. Such effects could have important influences on saltmarsh insect populations, but this aspect has never been investigated.

## 2.7 NUTRITION

An obvious peculiarity of the saltmarsh environment is the high salinity of the insects' potential food sources — plants, detritus and other marine organisms. As has already been mentioned, the ingested salts are eliminated by extremely effective ionic and osmoregulatory mechanisms in saltmarsh insects. However,

in a terrestrial insect (*Periplaneta americana* L.) it has been shown that the osmotic concentration of ingested food is monitored and the subsequent rate of discharge into the midgut regulated to avoid overloading its absorptive mechanisms (Treherne, 1957; Davey and Treherne, 1963). It was shown that the rate of absorption of glucose into the blood was greatly reduced by the addition of non-electrolytes or sodium chloride to the diet. It is therefore conceivable that the high salinity of the food of saltmarsh insects could have a profound effect on the effective nutritive value of the diet. This problem has never been investigated in saltmarsh insects. However, it may be significant that, despite its effective mechanisms of ionic regulation, the saltmarsh beetle *Bledius spectabilis* selects algae of the lowest available salinity and does not store algae of more than 40<sup>0/00</sup> NaCl (Bro Larsen, 1952, 1953). Alternatively the rate of access of nutrient molecules to the absorptive surfaces may be differently controlled in saltmarsh insects.

The high salinity of saltmarsh plants probably makes them unpalatable to many terrestrial insects. This is particularly relevant for the insect associates of plants whose ranges extend into tidal saltmarshes from non-saline habitats (e.g. *Armeria maritima* and *Plantago maritima*). It has been shown, for example, that spraying the leaves or watering the plants of sugar-beet (the wild type of which, *Beta vulgaris* ssp. *maritima*, grows in coastal habitats) with seawater greatly reduces the extent of colonization by the aphid *Myzus persicae* (Sulzer) (Gibbs, 1960).

The influence of saline conditions on plant growth is complex and varied. High salinity has been shown to reduce plant growth (e.g. Black, 1956; Slatyer, 1967; Phleger, 1971), to reduce the shoot: root ratio (Freijnsen and van Dijk, 1975), to alter the mechanism of CO<sub>2</sub> assimilation (Winter, 1973a,b), to limit flowering (Jefferies, 1972) and may also reduce the water availability to the plant (e.g. Slatyer, 1967). These effects may have important influences on the nutritiousness of saltmarsh plants for herbivorous insects. For example, the performance of some aphid species has been shown to be impaired by slow growth and water stress of the host plant (e.g. Kennedy et al., 1958; Kennedy and Booth, 1959; Wearing, 1967; Wearing and van Emden, 1967). Flower-feeding insects may have limited food supplies in saltmarshes. An interesting example of a possible indirect effect of high salinity on a plant's nutritiousness for insects is provided by the alteration in amino acid metabolism that can occur in plants of saline environments. Several halophyte species produce amino acids rather than organic acids as the major products of the dark fixation of CO<sub>2</sub> (Webb and Burley, 1965). In a number of saltmarsh species (but not all — see Cruz and Pole, 1975) the major amino acid accumulated is proline, which may account for over 70% of the total amino acid pool (Stewart and Lee, 1974). Van Emden (1972, 1973) has shown that there is a significant negative correlation between the performance of the polyphagous aphid *Myzus persicae* and the occurrence of proline in Brussels sprouts. The occurrence of proline in halophytes will therefore make them unsuitable for

*M. persicae* and possibly for other aphids. In addition, asparagine and glutamine, amino acids that are positively correlated with aphid performance on Brussels sprouts, comprise a relatively small proportion (7–17%) of the total amino acid pool in the halophyte species studied by Stewart and Lee (1974). An experimental analysis of aphid performance in relation to halophyte amino acids would be of great interest.

The generally limited number of plant species on saltmarshes restricts the variety of potential food sources for herbivorous insects. The large proportion of detritus swept away from the marsh surface by the tides (e.g. Teal, 1962; Cameron, 1972; Jefferies, 1972) reduces the quantity of food available to insect detritus-feeders. On a Georgia saltmarsh Teal (1962) estimated that 45% of the *Spartina* production was removed by the tides before utilization by the marsh consumers. Marine algae, however, which are common in many saltmarsh habitats (cf. Chapman, 1960), provide a novel food source for insect invaders from terrestrial and freshwater environments.

On the basis of the feeding habits of detritus-algal feeders and carnivores on a Georgia saltmarsh, Teal (1962) suggested that stability of saltmarsh ecosystems is achieved by the strategy of a limited number of species each with a broad dietary range. Teal studied only two insect species, both of which fed on *Spartina alterniflora*. However, the detailed list of Davis and Gray (1966) for the insects of North Carolina marshes showed that they were restricted in their association with particular plant zones; 50% of the plant tissue and sap feeders were associated with only one of the five plant zones. In a detailed study of insect trophic diversity in two Californian saltmarshes, Cameron (1972) found a wide variety of feeding mechanisms amongst the diverse insect fauna, and concluded that both the persistent and the seasonal insect herbivores and saprovores were specialist feeders. There is therefore no evidence that saltmarsh insects have more generalized feeding habits than their terrestrial relatives.

Energy flow has been studied in some detail in the marine saltmarshes of the Atlantic coast of the USA (e.g. Odum and Smalley, 1959; Smalley, 1960; Teal, 1962; Nixon and Oviatt, 1973). The major energy flow between autotrophic and heterotrophic levels is through the detritus rather than the grazing food chain. As most saltmarsh insects are grazers (Marples, 1966) their role in the consumption of primary production will be small. Indeed, Williams and Murdoch (1972), working on North Carolina marshes, and Nixon and Oviatt (1973), working on a New England marsh, could find no significant populations of any insects. However, Smalley (1960) estimated that the grasshopper (*Orchelimum fidicinium* Rehn and Hebard) population of a Georgia saltmarsh consumed 1% of the *Spartina* production, and Teal (1962) estimated that the herbivorous insects (*Orchelimum*, *Prokelisia marginata*) on a Georgia saltmarsh assimilated about 4.6% of the *Spartina* production. Since a number of other insects have been shown to feed on Georgia saltmarshes (Davis and Gray, 1966; Marples, 1966), it is

probably reasonable to assume, following Kraeuter and Wolf (1974), that insects on these marshes consume approximately 10% of the annual *Spartina* production.

## 2.8 DISPERSAL

The instability of many saltmarsh habitats creates a need for effective mechanisms of dispersal. However, the saltmarsh environment provides a number of difficulties for dispersing insects. In seeking a new habitat, insects must leave their usual refuges and expose themselves to the physical dangers of tidal inundation. There is the added danger that dispersing insects will be transported away from the narrow zone of suitable intertidal habitats.

Flight is the characteristic mode of dispersal of terrestrial insects. However, the air is an untrustworthy medium for the dispersal of an intertidal insect, which might, by taking to the air, be rapidly transported to unsuitable regions of the sea or land (see Ch. 5). Partial or total winglessness is a common feature of insects that are closely associated with the sea (Carpenter, 1928). Nevertheless, a number of saltmarsh insects disperse by flying and, probably because of the more extensive area of the environment, brachyptery is not as common in saltmarsh insects as in those from rocky shores.

Other methods of dispersal are well developed in saltmarsh insects. More limited, local dispersal can be achieved by walking or crawling. Bro Larsen (1951) observed that sand-digging saltmarsh beetles made extensive excursions on foot. Gerry (1949) reported that larval Tabanidae moved in the soil to better drained regions of a saltmarsh, although this was not confirmed by Rockel and Hansens (1970). Collembola (e.g. *Archisotoma besselsi* (Packard)) moving over the bare mud are a common feature of saltmarsh cliffs (Green, 1968). Walking is an important method of colonizing new host plants by 1st instars of *Pemphigus trehernei* (Foster and Treherne, unpublished).

A novel and effective means of dispersal is available to insects of marine saltmarshes: floating on the surface of the tides. Quite large excursions can be made by this means, but the organism is at the same time retained within the general region of suitable habitats (see Ch. 7). Although aquatic dispersal of seeds is common in many saltmarsh plants (e.g. Turrill, 1948; Dalby, 1963; Gray, 1971) and is used by a prosobranch mollusc, *Hydrobia ulvae* (Pennant) (Newell, 1962, 1964) there appear to be very few accounts of this mode of dispersal being used by insects. From a combination of casual observations and the known distribution of certain insects, several authors have suggested that particular insect species are dispersed on the oceans (e.g. Edwards, 1923; Walsh, 1926; Hutchinson, 1931; Lindroth, 1957). Thomson (1945) observed that eggs and larvae of *Anopheles gambiae* var. *melas* were transported over considerable distances by twice-daily tidal inundation during their development on mangrove swamps in Sierra Leone.

The only detailed investigation of tidal dispersal of an insect is that made on the root aphid *P. trehernei* (Foster, 1974). The 1st instar larvae crawl to the surface and are taken up by the flooding tide. Due to their waxy covering they float proud of the surface and are virtually unwettable. The floating aphids are sensitive to wind movements and are propelled rapidly across the surface of the sea. Experiments with model aphids (i.e. small polystyrene balls) indicated that the tide is a very effective means of dispersing floating objects from restricted sources over a wide area of marsh (Foster and Treherne, unpublished). The movements of these models was influenced by both water movements and by the wind; usually a period of tide-influenced movement was followed by a period of wind-influenced movement as the tide flooded the marsh. It was also observed that a significant proportion of the floating models were deposited in edge situations on the marsh. Field observations and experiments showed that 1st instar aphids, which had floated on the tides, were able to gain access and to colonize aster plants in edge situations (Foster, 1974).

Newly born 1st instar aphids differ from all subsequent stages in moving towards

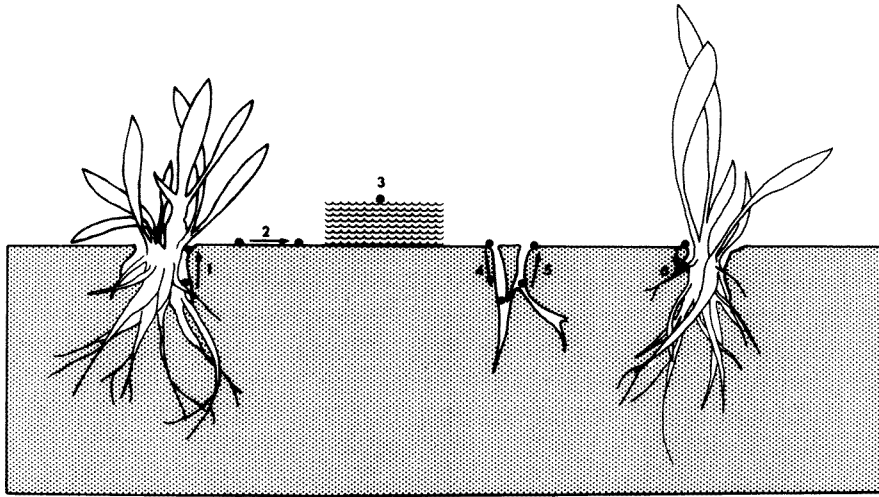

Fig. 2.16. Diagrammatic representation of the scheme proposed for the dispersal of 1st instars of the aster root aphid, *P. trehernei*. (1) Movement out of soil of young 1st instars. Positive response to light overruling positive response to gravity. Possibly encouraged by crowding, shortage of food and dryness of soil. (2) Movement on soil surface. (3) Floating on the tide. (4) Movement down into a soil crack by (a) older 1sts (> 60-h old) that have not necessarily dispersed on the tides, and (b) younger 1sts after dispersal on the tides. Negative response to light reinforcing positive response to gravity. (5) Movement up to soil surface by young 1sts that have found no suitable aster roots. Positive response to light overruling positive response to gravity. (6) Movement of older 1sts, or younger 1sts after dispersal on tide, into cracks containing suitable aster roots, where the aphids may then find a colony. Negative response to light reinforcing positive response to gravity (from Foster, 1974).

light (Foster, 1974). This positive response wanes with age and can be rapidly reversed by a short period of floating on sea water. These observations can be incorporated in a scheme for the dispersal behaviour of this saltmarsh aphid (Fig. 2.16).

The aster root aphid shows a marked reduction in the importance of flight in dispersal as compared with its terrestrial relatives, such as the lettuce root aphid *Pemphigus bursarius* (Foster, 1975). Alates of *P. trehernei* are scarce on marsh *Aster tripolium* in late summer and autumn, and only a negligible input of gall migrants was observed from the primary host (*Populus nigra* L.). Dispersal in this intertidal species is therefore largely limited to movements of 1<sup>st</sup> instars of the anholocyclic marsh populations. *P. trehernei* thus provides another example of the reduced emphasis on flight associated with the intertidal environment.

## 2.9 PREDATORS, PARASITES AND PATHOGENS

It has been suggested that organisms such as saltmarsh insects, which live in environments of extreme physical conditions, enjoy a compensating reduction in biological competition (e.g. Bro Larsen, 1952; Teal, 1962). A number of organisms are postulated to be restricted to 'extreme' habitats, not because these provide optimal physical environmental conditions but because in more 'favourable' habitats they are unable to cope with the competition from other organisms. The distribution of many saltmarsh plants has been explained on this basis (e.g. Chapman, 1960; Ranwell, 1972; Waisel, 1972), and there is experimental evidence in support of this view (Waisel, 1972). The brine shrimp *Artemia salina* is said to be restricted to extremely saline pools because it cannot tolerate predation in the sea (Boone and Baas-Becking, 1931; Hedgpeth, 1957). Bro Larsen (1952) has used this idea to account for the distribution of beetles (*Bledius* spp.) on a Danish saltmarsh, and provided experimental evidence that they actively seek out habitats of high salinity, where predators and pathogens 'thrive badly'. She showed that fewer individuals of the predatory beetle genus *Dyschirius* occurred with *Bledius* spp. in marine as compared with non-saline habitats. The absence from colonies of the aphid *P. trehernei* of chloropid fly larvae (*Thaumatomyia* spp.), which are widespread and usually found with terrestrial *Pemphigus* root colonies, suggests that they are unable to maintain themselves in the intertidal zone (Foster, 1975).

However, a wide variety of predators and parasites of insects have been recorded from marine saltmarshes. Birds, many species of which are common feeders on saltmarshes (e.g. Packham and Liddle, 1970), are the most important vertebrate predators (cf. Green, 1968). Birds prey on herbivorous insects that seek refuge on tall vegetation during tidal submergence (Arndt, 1914; Smalley, 1960; Teal, 1962; Davis and Gray, 1966). Green (1954) observed a small flock of ringed plovers



(*Charadrius hiaticula* L.) and dunlin (*Calidris alpina* L.) feeding at high frequency on the beetle *Bembidion laterale* (Samouelle) on the surface of a Welsh marsh. Insectivorous mammals may also be important predators; Cameron (1972) recorded the shrew *Sorex ornatus* as a potential predator of insects on a Californian marsh.

Davis and Gray (1966) and Cameron (1972) described a number of insect predator species on saltmarshes of North Carolina and California, respectively. In the *Salicornia* insect community studied by Cameron, there were 61 herbivore and saprovores species and 9 predator species (13% of the total), and in the *Spartina* community, 70 herbivores and saprovores and 13 predators (16% of the total).

From the general lack of correlation between predator diversity and either saprovores or herbivore diversity, Cameron (1972) concluded that animals other than insects must be important predators of the insect fauna. Spiders are characteristic inhabitants of saltmarshes in various parts of the world (e.g. Barnes, 1953; Paviour-Smith, 1956; Davis and Gray, 1966; Stebbings, 1971) and their importance as predators of insects has been emphasized by several authors (Davis and Gray, 1966; Marples, 1966; Cameron, 1972; Ch. 6, this volume). From studies with radioactive tracers in a Georgia marsh, Marples (1966) concluded that spiders were the most important predators in both the grazing and detritus food chains.

Hymenopterous parasites (including Chalcidoidea, Ichneumonidae, Braconidae, Scelionidae and Tiphidae) have been reported from a number of saltmarshes (Davis and Gray, 1966; Abraham, 1970; Horstmann, 1970). Horstmann (1970) found 20 species of Ichneumonidae on a saltmarsh on the North Sea coast of Germany, and showed that all the usual groups of insect hosts for ichneumonids were also parasitized on the saltmarsh. However, adult Pteromalidae (Chalcidoidea), although common in many saltmarshes, show no real adaptation to intertidal life (Abraham, 1970, 1972), being very susceptible to flooding with seawater. Pteromalid populations survive on saltmarshes chiefly because the larvae are protected within leaf-mining dipterous hosts and there is rapid dispersal of adults from terrestrial to saltmarsh habitats.

The above evidence indicates that a wide variety of predators and parasites have accompanied terrestrial insects into marine saltmarshes. It remains to be established whether the level of predation and parasitism exerted by this apparently large assemblage of species is less than that experienced by similar insects in terrestrial habitats. The number of insect predator species recorded by Cameron (1972) - 13% and 16% of the total insect fauna - seem rather small when compared, for example, with Waloff's (1968) description of the insect fauna of Scotch Broom, *Sarothamnus scoparius* (L.) Winner, in England; the 23 phytophagous species studied by her were associated with a complex of 70 parasitic species and about 60 common predators. It would be of considerable interest to study the

predators and parasites of an insect species which can maintain populations both in saltmarshes and terrestrial habitats.

Many species of fungi can tolerate saline conditions (Johnson and Sparrow, 1961). Although fungi are not as common in saltmarsh soils as in terrestrial soils, the fungal flora of saltmarsh soils is nevertheless rich (Elliot, 1930; Pugh, 1960, 1961, 1962). It is difficult to generalize about the effect of the saltmarsh environment on entomogenous fungi. Bro Larsen (1952) observed that *Bledius* spp. were much less liable to fungal attack by Laboulbeniales in saline (ca. 1% infection) than in freshwater situations (ca. 40% infection). Green (1968) reported that fungal infections of *Bledius arenarius* Paykull were most severe after periods of heavy rain and subsequent drying. It is possible that these beetles and the saline populations studied by Bro Larsen were less exposed to fungal attack because of the anaerobic soil conditions, which are considered to be unfavourable for fungi (Pugh, 1961).

Picard (1908), who recorded the first marine entomogenous fungus, noted that infection of the intertidal beetle *Aepus robini* by *Laboulbenia* was very widespread, although apparently causing little harm. Root colonies of the aphid *P. trehernei*, which lives in aerobic conditions, are subject to attack by the hyphomycete fungus *Metarrhizium anisopliae* (Metch.) Sorok. Fungal attack may be severe during summer and autumn, and is probably an important factor influencing the aphid's abundance (Fig. 2.17) (Foster, 1975). This widespread fungus has not previously been reported from any terrestrial aphid species, perhaps suggesting that the conditions in

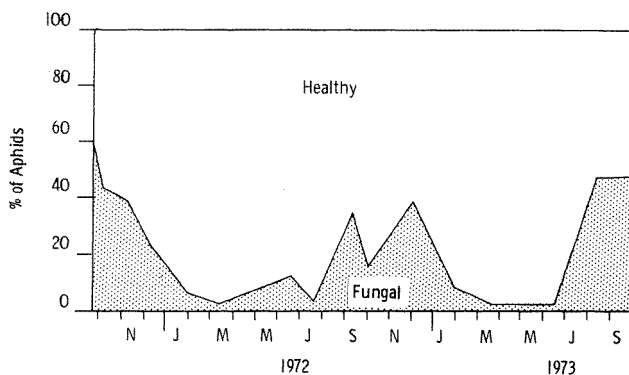

Fig. 2.17. Seasonal incidence of fungal attack in colonies of the aster root aphid, *P. trehernei*. Observations made at Scolt Head, Norfolk, U.K. (redrawn from Foster, 1975b).

the submergence marsh soil (e.g. the permanently high humidity) favour sporulation and germination of this type of entomogenous fungus. Green (1954) found that 27% of a population of the beetle *Bembidion laterale* were infected with the fungus *Laboulbenia pedicillata* Thaxter. Payne

(1972) observed on one occasion that a large proportion of the population of a hemipteran *Euscelis obsoletus* Kirsch on *Spartina* leaves had been killed by a fungus (*Entomophthora* sp.). It therefore appears that the concept of protection from fungal attack in saline environments is not applicable to all saltmarsh insects.

## 2.10 EPILOGUE

Saltmarshes form the most important route by which terrestrial and aquatic insects have become adapted to marine conditions. The variable degree of tidal coverage and the wide range of microhabitats on saltmarshes provide a graded series of environments, which has enabled insects of both terrestrial and freshwater origin to become progressively adapted to the extreme conditions of the intertidal zone.

The successful invasion of marine saltmarshes by terrestrial insects appears to have been facilitated by a number of 'pre-adaptations' which enable them to avoid or minimize the effects of tidal submergence. The possession of an extremely impermeable integument reduces the osmotic and ionic stress resulting from high and variable salinities. The classical terrestrial mechanism of water conservation by producing hypertonic excretory fluids has also been used with advantage in the osmoregulation of saltmarsh insects. Gaseous respiration is effectively employed by insects of terrestrial origin by using soil and plant air spaces and the hydrofuge properties of the integument to retain air stores during tidal submergence.

Freshwater insects, although adapted to aquatic life, face the additional problem of high environmental salinity and are exposed to the mechanical dangers of tidal inundation. The impermeability of the integument to water and inorganic ions of some freshwater species pre-adapts them to saline conditions. The restricted water-loss and limited entry of salts through the general body surface of insects of freshwater origin is correlated with effective mechanisms of ionic and osmotic regulation which enable them to tolerate a variety of environmental salinities, ranging from brackish to hypersaline conditions. An apparently novel regulatory mechanism, demonstrated in *Aedes taeniorhynchus*, involves an active ion transport from the blood into the rectal lumen. Osmotic and ionic regulation appears to be metabolically expensive at high salinities and could be a limiting factor in the invasion of marine saltmarshes by insect species.

The vulnerability of saltmarsh insects to the effects of environmental instability creates the need for effective mechanisms of dispersal. Despite a tendency for brachyptery in marine insects dispersal in saltmarshes is frequently achieved by flight, as well as by local walking and, in one case at least, by tidal dispersal.

The assumption that the restricted diversity of the saltmarsh fauna entails reduced biological competition and the adoption of broad diets is not supported by observations on saltmarsh insects. A wide variety of predators appears to be associated with the saltmarsh insect fauna, although there may be interesting differences in the identity of these predators in comparison with those of terrestrial habitats; spiders, for example, seem to be of particular importance as predators of saltmarsh insects. There also appear to be a large number of parasite species, and possibly also of pathogens, associated with saltmarsh insects. It seems probable that saltmarsh insects, in contrast to other saltmarsh invertebrates, have specialist feeding strategies, and do not differ in this respect from insects of terrestrial environments.

It is evident that much basic information has yet to be obtained on all aspects of the biology of saltmarsh insects. Complete fauna lists have only been compiled for very few marine saltmarshes and we are ignorant of the detailed biology of all but a handful of saltmarsh insects. This dearth of knowledge is surprising since this extreme environment has already been shown to have generated novel adaptations which are worthy of study at all levels - from cellular physiology to community ecology.

## REFERENCES

- Abraham, R. (1970) Ökologische Untersuchungen an Pteromaliden (Hym., Chalcidoidea) im Grenzraum Land-Meer an der Nordseeküste Schleswig-Holsteins. *Oecologia* 6, 15–47.
- Abraham, R. (1972) Untersuchungen zur Resistenz von Chalcidoidea und Cynipidae (Hymenoptera parasitica) gegenüber Seewasser. *Oecologia* 11, 55–66.
- Adriani, M.J. (1945) Sur la phytosociologie, la synecologie et le bilan d'eau de halophytes de la région Néerlandaise Méridionale, ainsi que de la Méditerranée Française. *S.I.G.M.A., Groningen* 88, 1–217.
- Alluaud, C. (1926) Observations sur la faune entomologique intercotidale. *Bull. Soc. zool Fr.* 51, 152–154.
- Anderson, C.E. (1974) A review of structure in several North Carolina saltmarsh plants. In: *Ecology of Halophytes*. (R.J. Reimold and W.H. Queen, Eds.), pp. 307–344.
- Arndt, C.H. (1914) Some insects of the between tides zone. *Proc. Indiana Acad. Sci.* 323–336.
- Audouin, V. (1833) Observations sur un insecte qui passe une grande partie de sa vie sous la mer. *Nouv. Ann. Mus. Hist. nat.* 3, 117–128.
- Balfour-Brown, F. (1958) *British Water Beetles*. Vol. 3. (, .)
- Barnes, R.D. (1953) The ecological distribution of spiders in non-forest maritime communities at Beaufort, North Carolina. *Ecol. Monogr.* 23, 315–337.
- Beadle, L.C. (1939) Regulation of the haemolymph in the saline water mosquito *Aedes detritus*. *J. exp. Biol.* 16, 346–362.
- Beament, J.W.L. (1961) The waterproofing mechanism of arthropods. II. The permeability of the cuticle of some aquatic insects. *J. exp. Biol.* 38, 277–290.
- Beament, J.W.L. (1964) The active transport and passive movement of water in insects. *Adv. Insect Physiol.* 2, 67–129.

- Berridge, M.J. (1970) Osmoregulation in terrestrial arthropods. In: Chemical Zoology, Vol. V. (M. Florkin and B.T. Scheer, Eds.), , pp. 287–319.
- Berridge, M.J. and Gupta, B.L. (1967) Fine-structural changes in relation to ion and water transport in the rectal papillae of the blowfly, *Calliphora*. *J. Cell Sci.* 2, 89–112.
- Black, R.F. (1956) Effect of NaCl in water culture on the ion uptake and growth of *Atriplex hastata* L. *Aust. J. Biol. Sci.* 9, 67–80.
- Boone, E. and Baas-Becking, L.G.M. (1931) Salt effects on eggs and nauplii of *Artemia salina* L. *J. Gen. Physiol.* 14, 753–763.
- Bradley, T.J. and Phillips, J.E. (1975) The secretion of hyperosmotic fluid by the rectum of a saline-water mosquito larva *Aedes taeniorhynchus* (Wiedman) *J. Exp. Biol.* 63, 331–342.
- Brereton, A.J. (1971) The structure of the species populations in the initial stages of salt-marsh succession. *J. Ecol.* 59, 321–338.
- Bro Larsen, E. (1950) In: Vort. Lands Dyreliv. (, ) pp. 107–126.
- Bro Larsen, E. (1951) Studies on the soil fauna of Skallingen. *Oikos* 3, 166–192.
- Bro Larsen, E. (1952) On subsocial beetles from the salt-marsh, their care of progeny and adaptation to salt and tide. *Proc. 9th. Int. Congr. Entomol., Amsterdam I*, 502–506.
- Bro Larsen, E. (1953) Successionsstudier i et havendigsområde, Skomargersletten, Skallingen. *Geogr. Tidsskr.* 52, 182–200.
- Brown, E.S. (1948) The ecology of Saldidae (Hemiptera-Heteroptera) inhabiting a salt marsh, with observations on the evolution of aquatic habits in insects. *J. Anim. Ecol.* 17, 180–188.
- Burrell, J. (1812) Remarks on *Staphylinus tricornis*. *Trans. entomol. Soc. Lond.* 1 (3) 310–313.
- Cameron, G.N. (1972) Analysis of insect trophic diversity in two salt marsh communities. *Ecology* 53, 58–73.
- Cameron, G.N. (1975) Do tides affect insect communities? *Am. Midl. Nat.* (In Press).
- Carpenter, G.H. (1928) *The Biology of Insects.* (, )
- Chan, T.D. and Trott, L.B. (1972) The collembolan, *Oudemansia esakii*, an intertidal marine insect in Hong Kong, with emphasis on the flotation method of collection. *Hydrobiologia* 40, 335–343.
- Chapman, V.J. (1960) The plant ecology of Scolt Head Island. In: *Scolt Head Island.* (J.A. Steers, Ed.) , pp. 85–163.
- Chapman, V.J. (1974a) *Salt Marshes and Salt Deserts of the World.* 2nd. suppl. reprint ed. (, )
- Chapman, V.J. (1974b) *Salt marshes and salt deserts of the world.* In: *Ecology of Halophytes.* (R.J. Reimold and W.H. Queen, Eds.) , , pp. 3–19.
- China, W.E. (1927) Notes on the biology of *Aëpophilus bonnairei* Sign. (Hemiptera-Homoptera). *Entomol. Mon. Mag.* 63, 238–241.
- Clarke, L.D. and Hannon, N.J. (1967) The mangrove swamp and salt marsh communities of the Sydney district. I. Vegetation, soils and climate. *J. Ecol.* 55, 753–771.
- Clarke, L.D. and Hannon, N.J. (1969) The mangrove swamp and salt marsh communities of the Sydney district. II. The holocoenotic complex with particular reference to physiography. *J. Ecol.* 57, 213–234.
- Claus, A. (1937) Vergleichend-physiologische Untersuchungen zur Ökologie der Wasserwanzen mit besonderer Berücksichtigung der Brackwasserwanze *Sigara lugubris* Fieb. *Zool. Jb. (Physiol.)* 58, 365–432.
- Clements, A.N. (1963) *The Physiology of Mosquitoes.* (, )
- Connell, W.A. (1940) Tidal inundation as a factor limiting the distribution of *Aedes* spp. on a Delaware saltmarsh. *Proc. NJ Mosqu. Exterm. Assoc.* 27, 166–177.
- Coquerel, C. (1850) Note pour servir à l'histoire de l'*Aepus robinii* et de sa larve. *Ann. Soc. entomol. Fr.* 2, 529–532.
- Cruz, A. A. de la and Pole, W.E. (1975) Amino acid content of marsh plants. *Estuar. Coastal Mar. Sci.* 3, 243–246.

- Daiber, F.C. (1974) Salt marsh plants and future coastal salt marshes in relation to animals. In: Ecology of Halophytes. (R.J. Reimold and W.H. Queen, Eds.) , , pp. 475–508.
- Dalby, D.H. (1963) Seed dispersal in *Salicornia pusilla*. Nature 199, 197–198.
- Dalby, D.H. (1970) The saltmarshes of Milford Haven, Pembrokeshire. Fld. Stud. 3, 297–330.
- Davey, K.G. and Treherne, J.E. (1963) Studies on crop function in the cockroach (*Periplaneta americana* L.). II. The nervous control of crop-emptying. J. Exp. Biol. 40, 775–780.
- Davis, L.V. and Gray, I.E. (1966) Zonal and seasonal distribution of insects in North Carolina salt marshes. Ecol. Monogr. 36, 275–295.
- Dexter, R.W. (1943) *Anurida maritima*: an important sea-shore scavenger. J. Econ. Entomol. 36, 797.
- Duff, S. and Teal, J.M. (1965) Temperature changes and gas exchange in Nova Scotia and Georgia salt-marsh muds. Limnol. Oceanogr. 10, 67–73.
- Dyte, C.E. (1959) Some interesting habitats of larval Dolichopodidae (Diptera). Entomol. Mon. Mag. 95, 139–143.
- Ebeling, W. (1964) The permeability of insect cuticle. In: The Physiology of Insecta. 1st edn, Vol. III. (M. Rockstein, Ed.) , , pp. 507–556.
- Edwards, F.W. (1923) Insects floating on the sea. Entomol. Mon. Mag. 59, 235.
- Eisikowitch, D. and Woodell, S.R.J. (1975) Some aspects of pollination ecology of *Armeria maritima* (Mill.) Willd. in Britain. New Phytol. 74, 307–322.
- Elliot, J.S.B. (1930) The soil fungi of the Dovey salt marshes. Ann. Appl. Biol. 17, 284–305.
- Evans, P.D., Ruscoe, C.N.E. and Treherne, J.E. (1971) Observations on the biology and submergence behaviour of some littoral beetles. J. Mar. Biol. Assoc. U.K. 51, 375–386.
- Foster, W.A. (1974) The biology of a salt marsh aphid (*Pemphigus* sp.). Ph.D. Thesis, (University of Cambridge, U.K.).
- Foster, W.A. (1975) The life history and population biology of an intertidal aphid, *Pemphigus trehernei* Foster. Trans. R. Entomol. Soc. Lond. 127, 193–207.
- Foster, W.A. (1976) A new species of *Pemphigus* Hartig (Homoptera: Aphidoidea) from Western Europe. J. Entomol. (B). 44, 255–263.
- Foster, W.A. and Treherne, J.E. (1975) The distribution of an intertidal aphid, *Pemphigus trehernei* Foster, on marine saltmarshes. Oecologia 21, 141–155.
- Foster, W.A. and Treherne, J.E. (1976) The effects of tidal submergence on an intertidal aphid, *Pemphigus trehernei* Foster. J. Anim. Ecol. (In press).
- Freijnsen, A.H.J. and van Dijk, A. (1975) Differences in growth rate and salt tolerance between varieties of the halophyte *Centaurium littorale* (Turner) Gilmour, and their ecological significance. Acta bot. neerl. 24, 7–22.
- Gerry, B.I. (1949) Control of a salt marsh Tabanid by means of residual DDT-oil spray. J. Econ. Entomol. 42, 888–890.
- Gibbs, A.J. (1960) Studies on the importance of wild beet as a source of pathogens for the sugar-beet crop. Ann. Appl. Biol. 48, 771–779.
- Gillett, J.D. (1971) Mosquitos. (, .)
- Glynne-Williams, J. and Hobart, J. (1952) Studies on the crevice fauna of a selected shore in Anglesey. Proc. Zool. Soc. Lond. 122, 797–824.
- Gray, A.J. (1971) Variation in *Aster tripolium* L., with particular reference to some British populations. Ph.D. Thesis, (University of Keele, U.K.).
- Green, J. (1954) The food, predators and a parasite of *Bembidion laterale* (Samouelle) (Col., Carabidae) Entomol. Mon. Mag. 90, 226–227.
- Green, J. (1968) The Biology of Estuarine Animals. (, .)
- Hartley, J.C. (1958) The root-piercing spiracles of the larva of *Chrysogaster hirtella* Loew (Diptera: Syrphidae). Proc. R. Entomol. Soc. Lond. A. 33, 81–87.

- Hedgpeth, J.W. (1957) Estuaries and Lagoons. II. Biological aspects. Mem. Geol. Soc. Am. 67 (I) 693–729.
- Hinton, H.E. (1953) Some adaptations of insects to environments that are alternately dry and flooded, with some notes on the habits of the Stratiomyidae. Trans. Soc. Br. Entomol. 11, 209–227.
- Hinton, H.E. (1961) How some insects, especially the egg stages, avoid drowning when it rains. Proc. S. Lond. Entomol. Nat. Hist. Soc. 1960, 138–152.
- Hinton, H.E. (1966) Plastron respiration in marine insects. Nature 209, 220–221.
- Hinton, H.E. (1967a) Plastron respiration in the marine fly *Canace*. J. Mar. Biol. Assoc. U.K. 47, 319–327.
- Hinton, H.E. (1967b) Spiracular gills in the marine fly *Aphrosylus* and their relation to the respiratory horns of other Dolichopodidae. J. Mar. Biol. Assoc. U.K. 47, 485–497.
- Hinton, H.E. (1967c) Structure of the plastron in *Lipsothrix*, and the polyphyletic origin of plastron respiration in Tipulidae. Proc. R. Entomol. Soc. Lond. (A) 42, 35–38.
- Hinton, H.E. (1968) Spiracular gills. Adv. Insect Physiol. 5, 65–162.
- Horstmann, K. (1970) Ökologische Untersuchungen über die Ichneumoniden (Hymenoptera) der Nordseeküste Schleswig-Holsteins. Oecologia 4, 29–73.
- Houlihan, D.F. (1969a) Respiratory physiology of the larva of *Donacia simplex*, a root piercing beetle. J. Insect Physiol. 15, 1517–1536.
- Houlihan, D.F. (1969b) The structure and behaviour of *Notiphila riparia* and *Erioptera squalida*, two root-piercing insects. J. Zool. 159, 249–267.
- Houlihan, D.F. (1970) Respiration in low oxygen partial pressures: the adults of *Donacia simplex*, that respire from the roots of aquatic plants. J. Insect Physiol. 16, 1607–1622.
- Hubbard, J.C.E. (1969) Light in relation to tidal immersion and the growth of *Spartina townsendii* (s.l.). J. Ecol. 57, 759–884.
- Hutchinson, G.E. (1931) On the occurrence of *Trichocorixa* Kirkaldy (Corixidae, Hemiptera-Heteroptera) in salt water and its zoo-geographical significance. Am. Nat. 65, 573–574.
- Imms, A.D. (1906) *Anurida*. L.M.B.C. Mem. Typ. Br. Mar. Pl. Anim. 13.
- Jefferies, R.L. (1972) Aspects of salt-marsh ecology with particular reference to inorganic plant nutrition. In: The Estuarine Environment. (R.S.K. Barnes and J. Green, Eds.) , , pp. 61–85.
- Johnson, T.W. and Sparrow, F.K. (1961) Fungi in Oceans and Estuaries. (, .)
- Kennedy, J.S. and Booth, C.O. (1959) Responses of *Aphis fabae* Scop. to water shortage in host plants in the field. Entomol. Exp. Appl. 2, 1–11.
- Kennedy, J.S., Booth, C.O. and Kershaw, W.J.S. (1961) Host finding by aphids in the field. III. Visual attraction. Ann. Appl. Biol. 49, 1–21.
- Kennedy, J.S. and Fosbrooke, I.H.M. (1973) The plant in the life of an aphid. In: Insect/Plant Relationships. (H.F. van Emden, Ed.) Symp. R. Entomol. Soc. Lond. 6, , , pp. 129–140.
- Kennedy, J.S., Lamb, K.P. and Booth, C.O. (1958) Responses of *Aphis fabae* Scop. to water shortage in host plants in pots. Entomol. Exp. Appl. 1, 274–291.
- Kraeuter, J.N. and Wolf, P.L. (1974) The relationships of marine macroinvertebrates to saltmarsh plants. In: Ecology of Halophytes. (R.J. Reimold and W.H. Queen, Eds.) , , pp. 449–462.
- Le Masne, G. (1938) La nymphe d'*Aepopsis robini* Lab., description et biologie. Bull. Zool. Soc. Fr. 63, 68–72.
- Lindroth, C.H. (1957) The Faunal Connections between Europe and America. (, .)
- Macan, T.T. (1974) Freshwater Ecology. (, .)
- Macdonald, K.B. and Barbour, M.G. (1974) Beach and salt marsh vegetation of the North American

- coast. In: Ecology of Halophytes. (R.J. Reimold and W.H. Queen, Eds.) , , pp. 175–233.
- McGregor, D.D. (1965) Aspects of the biology of *Opifex fuscus* Hutton (Diptera: Culicidae). Proc. R. Entomol. Soc. Lond. A. 40, 9–14.
- Macleod, D.A. (1967) The morphology and genesis of salt marsh soils and the changes taking place in them on reclamation. Ph.D. Thesis, (University of Cambridge, U.K.).
- Macnae, W. (1968) A general account of the fauna and flora of mangrove swamps and forests in the indo-west-pacific region. Adv. Mar. Biol. 6, 73–270.
- Maddrell, S.H.P. (1971) The mechanisms of insect excretory systems. Adv. Insect Physiol. 8, 199–331.
- Marples, T.G. (1966) A radionuclide tracer study of arthropod food chains in a *Spartina* salt marsh ecosystem. Ecology 47, 270–277.
- Mason, J.E. (1889) Aquatic habits of Salda. Entomol. Mon. Mag. 25, 236–237.
- Metcalf, Z.P. and Osborn, H. (1920) Some observations on insects of the between tides zones of the North Carolina coast. Ann. Entomol. Soc. Am. 13, 108–120.
- Miall, L.C. (1902) The Natural History of Aquatic Insects. Revised edn. (, ).
- Morton, J.E. (1954) The crevice faunas of the upper intertidal zone at Wembury. J. Mar. Biol. Assoc. U.K. 33, 187–224.
- Nayar, J.K. (1967) The pupation rhythm in *Aedes taeniorhynchus* (Diptera: Culicidae). II. Ontogenetic timing, rate of development, and endogenous diurnal rhythm of pupation. Ann. Entomol. Soc. Am. 60, 946–971.
- Nayar, J.K. and Sauerman, D.M. (1974) Osmoregulation in larvae of the salt-marsh mosquito, *Aedes taeniorhynchus*. Entomol. Exp. Appl. 17, 367–380.
- Neumann, D. (1961) Osmotische Resistenz und Osmoregulation aquatischer Chironomidenlarven. Biol. Zbl. 80, 693–715.
- Newell, R. (1962) Behavioural aspects of the ecology of *Peringia* (= *Hydrobia*) *ulvae* (Pennant) (Gasteropoda, Prosobranchia). Proc. Zool. Soc. Lond. 138, 49–75.
- Newell, R. (1964) Some factors controlling the upstream distribution of *Hydrobia ulvae* (Pennant) (Gasteropoda, Prosobranchia). Proc. Zool. Soc. Lond. 142, 85–106.
- Neville, A.D. (1975) Biology of the Arthropod Cuticle. (, ).
- Nicol, E.A.T. (1935) The ecology of a salt marsh. J. Mar. Biol. Assoc. U.K. 20, 203–261.
- Nicolson, S.W. (1972) Osmoregulation in larvae of the New Zealand salt-water mosquito *Opifex fuscus* (Hutton) (Diptera, Culicidae). J. Entomol. (A) 47, 101–108.
- Nicolson, S.W. and Leader, J.P. (1974) The permeability to water of the cuticle of the larva of *Opifex fuscus* (Hutton) (Diptera, Culicidae). J. Exp. Biol. 60, 593–603.
- Nixon, S.W. and Oviatt, C.A. (1973) Ecology of a New England salt marsh. Ecol. Monogr. 43, 463–498.
- Odum, E.P. and Smalley, A.E. (1959) Comparison of population energy flow of a herbivorous and a deposit-feeding invertebrate in a salt marsh ecosystem. Proc. Natl. Acad. Sci. U.S. 45, 617–622.
- Packham, J.R. and Liddle, M.J. (1970) The Cefni salt-marsh, Anglesey, and its recent development. Fld. Stud. 3, 311–356.
- Paviour-Smith, K. (1956) The biotic community of a salt meadow in New Zealand. Trans. R. Soc. N.Z. 83, 525–554.
- Payne, K. (1972) A survey of the *Spartina*-feeding insects in Poole Harbour, Dorset. Entomol. Mon. Mag. 108, 66–79.
- Pethick, J.S. (1969) Drainage in tidal salt marshes. In: The Coastline of England and Wales, 2nd edn (J.A. Steers, Ed.) , , pp. 725–730.
- Pethick, J.S. (1971) Salt marsh morphology. Ph.D. Thesis (University of Cambridge, U.K.).
- Pethick, J.S. (1974) The distribution of salt pans on tidal salt marshes. J. Biogeogr. 1, 57–62.



- Phleger, C.F. (1971) Effect of salinity on growth of a salt marsh grass. *Ecology* 52, 908–911.
- Picard, F. (1908) Sur une Laboulbéniaçée marine (*Laboulbenia marina* n. sp.) parasite d'*Aepus robini* Laboulbène. C.R. Seanc. Soc. Biol. 65, 484–486.
- Plateau, F. (1890) Les myriapodes marins et la résistance des arthropodes à respiration aérienne à la submersion. *J. Anat. Physiol. Paris* 26, 236–269.
- Pontevin, G. (1934) Encyclopedie Entomologique A, 17. Histoire naturelle des Coleopteres de France. III. : (, ).
- Pugh, G.J.F. (1960) The fungal flora of tidal mud flats. In: *The Ecology of Soil Fungi*. (D. Parkinson and J.S. Waid, Eds.), pp. 202–208.
- Pugh, G.J.F. (1961) Fungal colonization of a developing salt marsh system. *Nature* 190, 1032–1033.
- Pugh, G.J.F. (1962) Studies on fungi in coastal soils. II. Fungal ecology in a developing salt marsh. *Trans. Br. Mycol. Soc.* 45, 560–566.
- Purer, E.A. (1942) Plant ecology of the coastal salt marshlands of San Diego Country, California. *Ecol. Monogr.* 12, 81–111.
- Ramsay, J.A. (1950) Osmotic regulation in mosquito larvae. *J. Exp. Biol.* 27, 145–57.
- Ranwell, D.S. (1972) Ecology of salt marshes and sand dunes. (, .)
- Redfield, A.C. (1972) Development of a New England salt marsh. *Ecol. Monogr.* 42, 201–237.
- Rockel, E.G. and Hansens, E.J. (1970) Distribution of larval horse flies and deer flies (Diptera: Tabanidae) of a New Jersey salt marsh. *Ann. Entomol. Soc. Am.* 63, 681–684.
- Saunders, L.G. (1928) Some marine insects of the Pacific coast of Canada. *Ann. Entomol. Soc. Am.* 21, 521–545.
- Slatyer, R.O. (1967) Plant-water Relationships. (, .)
- Shaw, J. (1955) The permeability and structure of the cuticle of the aquatic larvae of *Sialis lutaria*. *J. Exp. Biol.* 32, 330–352.
- Shaw, J. and Stobbart, R.H. (1963) Osmotic and ionic regulation in insects. *Adv. Insect Physiol.* 1, 315–399.
- Smalley, A.E. (1960) Energy flow of a salt marsh grasshopper population. *Ecology* 41, 672–677.
- Smallman, B.N. (1942) Quantitative characters of the growth and development of a paurometabolous insect, *Dixippus (Carausius) morosus* Br. et Medt. I. The loss of water in relation to ecdysis. *Proc. R. Soc. Edin.* 61, 167–185.
- Staddon, B.W. (1966) The permeability to water of the cuticle of some adult water bugs. *J. Exp. Biol.* 44, 69–76.
- Stebbins, R.E. (1971) Some ecological observations on the fauna in a tidal marsh to woodland transition. *Proc. Br. Entomol. Nat. Hist. Soc.* 4, 83–88.
- Steers, J.A. (1960) Physiography and evolution. In: *Scot Head Island*. (J.A. Steers, Ed.), , pp. 12–66.
- Steers, J.A. (1969) *The Coastline of England and Wales*. 2nd edn (, .)
- Stewart, G.R. and Lee, J.A. (1974) The role of proline accumulation in halophytes. *Planta* 120, 279–289.
- Stobbart, R.H. and Shaw, J. (1974) Salt and water balance: excretion. In: *The Physiology of Insecta*. 2nd edn, Vol. 5. (M. Rockstein, Ed.), , pp. 361–446.
- Sutcliffe, D.W. (1959) Studies on the Biology of some salt-marsh insects. Ph.D. Thesis (University of Durham, U.K.).
- Sutcliffe, D.W. (1960) Osmotic regulation in the larvae of some euryhaline Diptera. *Nature* 187, 331–332.
- Sutcliffe, D.W. (1961a) Salinity fluctuations and the fauna in a salt marsh with special reference to aquatic insects. *Trans. Nat. Hist. Soc. Northumb.* 14, 37–56.
- Sutcliffe, D.W. (1961b) Studies on salt and water balance in caddis larvae (Trichoptera): I. Osmotic and ionic regulation of body fluids in *Limnephilus affinis* Curtis. *J. Exp. Biol.* 38, 501–519.

- Sutcliffe, D.W. (1962) Studies on salt and water balance in caddis larvae (Trichoptera). III. Drinking and excretion. *J. Exp. Biol.* 39, 141–160.
- Teal, J.M. (1962) Energy flow in the salt marsh ecosystem of Georgia. *Ecology* 43, 614–624.
- Teal, J.M. and Kanwisher, J. (1961) Gas exchange in a Georgia salt marsh. *Limnol. Oceanogr.* 6, 388–399.
- Teal, J.M. and Kanwisher, J. (1966) Gas transport in the marsh grass, *Spartina alterniflora*. *J. Exp. Bot.* 17, 355–361.
- Teal, J. and Teal, M. (1969) *Life and Death of the Salt Marsh*. (, .)
- Thompson, C. and Page, C.H. (1975) Oxygen sensitive elements in the prosoma of *Limulus polyphemus*. *J. Exp. Biol.* 62, 545–554.
- Thomson, R.C.M. (1945) Studies on the breeding places and control of *Anopheles gambiae* and *Anopheles gambiae* var *melas* in coastal districts of Sierra Leone. *Bull. Entomol. Res.* 36, 185–252.
- Thomson, R.C.M. (1951) Mosquito Behaviour in Relation to Malaria Transmission in the Tropics. (, .)
- Treherne, J.E. (1957) Glucose absorption in the cockroach. *J. Exp. Biol.* 34, 478–485.
- Turrill, W.B. (1948) *British Plant Life*. (, .)
- van Emden, H.F. (1972) Aphids as phytochemists. In: *Phytochemical Ecology* (J.R. Harborne, Ed.) , , pp. 25–43.
- van Emden, H.F. (1973) Aphid host-plant relationships. In: *Perspectives in Aphid Biology*. (A.D. Lowe, Ed.) *Bull. No. 2*, , pp. 54–64.
- Varley, G.C. (1937) Aquatic insect larvae which obtain oxygen from the roots of plants. *Proc. R. Entomol. Soc. Lond. A.* 12, 55–60.
- Waisel, Y. (1972) *Biology of Halophytes*. (, .)
- Waloff, N. (1968) Studies on the insect fauna on Scotch Broom *Sarothamnus scoparius* (L.) Winner. *Adv. Ecol. Res.* 5, 88–208.
- Walsh, G.B. (1925) The coast Coleoptera of the British Isles. *Entomol. Mon. Mag.* 61, 137–151.
- Walsh, G.B. (1926) The origin and distribution of the coast Coleoptera of the British Isles. *Entomol. Mon. Mag.* 62, 221–231, 257–262.
- Wearing, C.H. (1967) Studies on the relations of insect and host plant. II. Effects of water stress in host plants on the fecundity of *Myzus persicae* (Sulz.) and *Brevicoryne brassicae* (L.) *Nature* 213, 1052–1053.
- Wearing, C.H. and van Emden, H.F. (1967) Studies on the relations of insect and host plant. I. Effects of water stress in host plants on infestation by *Aphis fabae* Scop., *Myzus persicae* (Sulz.) and *Brevicoryne brassicae* (L.). *Nature* 213, 1051–1052.
- Webb, K.L. and Burley, W.A. (1965) Dark fixation of CO<sub>2</sub> by obligate and facultative salt marsh halophytes. *Can. J. Bot.* 43, 281–285.
- Wesenberg-Lund, C. (1943) *Biologie der Süßwasserinsekten*. (, .)
- Wieser, W. and Kanwisher, J. (1961) Ecological and physiological studies on marine nematodes from a small salt marsh near Woods Hole, Massachusetts. *Limnol. Oceanogr.* 6, 262–270.
- Wigglesworth, V.B. (1933) The adaptation of mosquito larvae to salt water. *J. Exp. Biol.* 10, 27–37.
- Wigglesworth, V.B. (1948) The structure and deposition of the cuticle in the adult mealworm, *Tenebrio molitor* L. (Coleoptera). *Q.J. Microsc. Sci.* 89, 197–217.
- Wigglesworth, V.B. and Gillett, J.D. (1936) The loss of water during ecdysis in *Rhodnius prolixus* Stal. *Proc. R. Entomol. Soc. Lond. (A)*. II, 131–150.
- Williams, R.B. and Murdoch, M.B. (1972) Compartmental analysis of the production of *Juncus roemerianus* in a North Carolina salt marsh. *Chesapeake Sci.* 13, 69–79.
- Winter, K. (1973a) Zum Problem der Ausbildung des Crassulaceensäurestoffwechsels bei *Mesembryanthemum crystallinum* unter NaCl-Einfluss. *Planta* 109, 135–145.

- Winter, K. (1973b) NaCl-induzierter Crassulaceensäurestoffwechsel bei einer weiteren Aizoacee: *Carpobrotus edulis*. *Planta* 115, 187–188.
- Yapp, R.H., Johns, D. and Jones, O.T. (1917) The salt marshes of the Dovey estuary. II. The salt marshes. *J. Ecol.* 5, 65–103.

## Respiratory adaptations of marine insects

H.E. Hinton

<b>Contents</b>		
3.1	Introduction	43
3.2	Physical gills	46
	3.2.1 The compressible or shrinking physical gill	46
	3.2.2 The plastron or incompressible physical gill	47
3.3	Submergence akinesis	50
3.4	Plastron-bearing spiracular gills	51
	3.4.1 Utilization by developing adult of spiracular gills of pupa	52
	3.4.2 Polyphyletic origin of plastron-bearing gills in marine insects	52
	3.4.3 Origin and significance of tissue isolated in spiracular gills	54
	3.4.4 Function of tissue isolated in spiracular gills	60
3.5	Respiratory adaptations in some marine Diptera	63
	3.5.1 Tipulidae	63
	3.5.2 Dolichopodidae	67
	3.5.3 Canaceidae	70
3.6	Respiratory adaptations of marine Phthiraptera	73
3.7	Eggs of marine insects	74
References	76	

### 3.1 INTRODUCTION

There are no respiratory adaptations among marine insects that are not also found among freshwater ones. Indeed, the number of different kinds of respiratory adaptations in marine insects is much fewer than in freshwater ones, as might be expected simply on the grounds that there are much fewer marine insects. Most of the respiratory adaptations of marine insects were already present in their freshwater or terrestrial ancestors, and those that were evolved after invasion of

the sea, e.g. the spiracular gills of the larvae of *Canace*, do not differ in any important particular from gills evolved in freshwater.

The origins of the respiratory adaptations of marine insects can be better understood by a brief glance at the kind of problems insects had to solve in order to invade freshwater or the sea, problems that were, so to speak, imposed upon them by their previous history of adaptation to relatively dry terrestrial environments.

Respiratory membranes must have holes large enough to allow oxygen molecules to enter, but any holes large enough for these molecules will allow water to escape because the water molecules are smaller. It is because of this difference in the size of the two molecules that dry environments present organisms with incompatible demands: they have to have an extensive permeable surface through which to satisfy their demands for oxygen but must somehow prevent an undue loss of water through such membranes. Respiratory membranes are moist, not because this assists the diffusion of oxygen but because they cannot help being moist if they have holes large enough to pass oxygen molecules. For instance, a frog can breathe through its skin. In terrestrial environments this moist and permeable skin is not an advantage but, on the contrary, restricts the frog to damp places.

Pterygote insects, some Chelicerata, and a few other arthropods have dealt successfully with the incompatible demands of dry environments. The exposed cuticle is water-proofed, and effectively oxygen-proofed, by a waxy layer. At the same time an enormous surface area freely permeable to both oxygen and water vapour is invaginated and forms tracheae that ramify through the body. The air in the tracheae can be kept saturated and the loss of water reduced to manageable proportions because the surface area of the spiracles is only a very small fraction of the total surface area of the tracheae. As a further improvement, pterygote insects have an apparatus that can close the spiracles, and by this means they restrict the loss of water to periods when the spiracles are open. Dipterous larvae have secondarily lost a closing apparatus. They have a fine cuticular felt in the spiracular atrium that by pressure resistance and frictional drag prevents tidal flows of air through the spiracles and makes it possible to establish a humidity gradient that reduces the amount of water lost by the saturated air in the tracheae to the drier air outside.

All aquatic pterygote insects are evolved from terrestrial ancestors that had highly impermeable cuticles and breathed through spiracles. In water the total surface area of the kind of spiracles that are evolved on land is far too small to allow a significant amount of oxygen to diffuse into the tracheae. The successful invasion of water by pterygote insects has resulted in six rather distinct adaptations (summary in Hinton, 1953), that may be briefly noted here: (1) The ability to make periodic trips to the surface and renew supplies of air. These insects are among the most numerous of all aquatic forms. They are completely absent in the intertidal zone, chiefly because of the turbulence of the surface. (2) Long spiracles

or spiracles opening on the ends of long projections. This adaptation enables insects to use atmospheric oxygen while below the surface; it is never found in intertidal forms: the depths involved are too great. (3) Conversion of an impermeable cuticle to a permeable one by loss of the waxy layer on part or all of the body wall so that oxygen needs can be satisfied by cutaneous respiration. This modification is particularly common in freshwater forms, and it is the most widely used method in marine forms, e.g. nearly all endopterygote larvae. (4) Pointed spiracles that can be thrust into plant tissue and so tap the intercellular airspaces. No intertidal insects are thus modified, but some of the estuarine or salt-marsh species have piercing spiracles (see Ch. 2). A number of species of *Erioptera* are estuarine, e.g. *E. stictica* (Meig.), and in this same genus some of the freshwater species have piercing spiracles in both larval and pupal stages, e.g. *E. flavescens* (L.) and *E. squalida* Loew (Hinton, 1953). (5) In some aquatic beetles and moths the gas in the pupal cocoon is in communication with the intercellular air-spaces of the plant, as first shown by Ege (1923). This adaptation is unknown among marine insects. (6) A plastron or permanent physical gill has been independently evolved by a very large number of freshwater insects, and a high proportion of those that have successfully invaded the sea have plastron-bearing spiracular gills in the pupal or larval stages. Only this particular adaptation will be discussed in any detail in this chapter.

It is interesting to note that probably more than half of the species of insects that have successfully invaded intertidal areas have come from land rather than freshwater, e.g. Tipulidae, Dolichopodidae, Canaceidae, Hymenoptera, and all groups of beetles except the Hydraenidae and possibly a few of the Staphylinidae. The notable exceptions are the Chironomidae, possibly the most numerous single group of marine insects, and the Trichoptera. The intertidal Tabanidae (English, 1949) probably come from terrestrial rather than freshwater members of the family. The Hemiptera, i.e. the pelagic Gerridae and the intertidal Saldidae and Omaniidae, are derived from forms associated with freshwater.

The insects which I will discuss in some detail are those with aquatic larval stages which live below high tide, chiefly on rocky rather than sandy coasts. They live in places that are exposed to the open ocean and pounding by waves, although they also live in rocky shores and reefs of more sheltered waters. I have arbitrarily excluded estuarine areas and others that are regularly or occasionally inundated at high tide, such as mangrove swamps and salt marshes. Insects of these habitats and some of their special adaptations will be discussed in other chapters.

Relatively few insects invade the intertidal areas exposed to the open ocean and pounding by waves. It is the violent turbulence, extreme and rapid variations of depth, and the regular alternate flooding and drying of this environment rather than its salinity that has made it so inhospitable for insects. The much greater abundance of insects in some saltmarshes suggests that although salinity may be a contributory factor it is not one of major importance in preventing the

colonization of intertidal areas pounded by waves, an opinion I share with both Buxton (1926) and Mackerras (1950).

Several hundred species of insects have colonized intertidal areas despite their physical violence. This of course seems extraordinarily few when compared with terrestrial insects, but it must be remembered that relatively few insects are aquatic. The vast majority of aquatic insects live in relatively still waters such as ponds, lakes and quiet bywaters of large rivers: relatively few have invaded the less stable and more violent environment of fast-flowing streams. For instance, from my experience I would guess that in a tropical country, say Mexico, there are more different kinds of insects in a hectare of land than in the many thousands of square kilometres of relatively fast-flowing streams and rivers.

## 3.2 PHYSICAL GILLS

### *3.2.1 The compressible or shrinking physical gill*

A bubble or film of air held under water and in communication with the respiratory system functions as an air store. But much more important, it functions as a gill in the sense that it permits the extraction of additional supplies of oxygen from the ambient water. The use of a bubble of air as a gill seems to have been first noticed by Comstock (1887), but it was left to Ege (1915) to provide the first satisfactory experimental and theoretical analysis of the way in which bubbles of air are used as gills by insects. If a bubble or film of air is to be used as a physical gill, it is a matter of no great importance whether the air is trapped in a cavity in the substrate, say, a crevice in a rock, or by hydrofuge structures over part or all of the animal.

As the insect withdraws oxygen from the bubble, the partial pressure of oxygen in the bubble falls and the partial pressure of nitrogen rises. Oxygen therefore diffuses into the bubble and nitrogen diffuses out of it. However, because oxygen is much more soluble in water than nitrogen, the liquid-air interface of the bubble is much more permeable for oxygen than for nitrogen. Because of this difference in the solubilities of the two gases there will be a tendency for equilibrium to be restored by oxygen diffusing into the bubble rather than by nitrogen diffusing out of it. Nevertheless, some nitrogen is continuously leaking out of the bubble so that it is continuously becoming smaller. Eventually the surface area of the bubble is too small for the insect to satisfy its oxygen requirements by diffusion of oxygen into the bubble from the surrounding water. When this happens the insect must drown, or utilize some other method of respiration, or, if it is an active stage, come to the surface to replenish its bubble.

In the compressible type of physical gill the most important gas is nitrogen, and the duration of the gill is determined by the rate at which nitrogen is lost.

The rate of loss of any gas depends upon the product of solubility and diffusion coefficient ( $\alpha D$ ). The substitution of inert gases for nitrogen in the bubble will therefore shorten or lengthen the life of the bubble according to the ratio:  $(\alpha D)_{\text{inert gas}}/(\alpha D)_{\text{N}_2}$ . In experiments with inert gases, Rahn and Paganelli (1968) found that only neon rivaled nitrogen. However, when the synthetic gas, sulfur hexafluoride, was substituted for nitrogen, the duration of the bubble was increased four times because of the very low solubility and high molecular weight of the synthetic gas.

At least some if not most of the carbon dioxide excreted will pass into the compressible gill. Although carbon dioxide diffuses more slowly than nitrogen or oxygen, it is very much more soluble than either of these gases, and  $(\alpha D)_{\text{CO}_2}$  is about 20 times greater than  $(\alpha D)_{\text{O}_2}$ . Thus, the effect of carbon dioxide on the volume and pressure of gas in the bubble is small and probably does not materially affect the lifetime of the bubble under water.

Ege (1915) has shown that under certain conditions adults of the backswimmer (*Notonecta*) extract from the ambient water as much as 13 times the amount of oxygen that the bubble originally contained. Other writers have shown that at low temperatures when insects are not very active and not much oxygen is used, the respiratory bubble may last for several days. Intertidal insects are probably often in crevices in which the amount of trapped air is sufficient for their needs during submersion at high tide, particularly if during this period they reduce their consumption of oxygen by not moving about too much. But there is another phenomenon that may occasionally occur. When water is super-saturated with air so that no pressure difference develops between the nitrogen in the bubble and that in the water, the compressible or shrinking gill may cease to shrink for a time. Breaking waves in an intertidal area may possibly locally convert a shrinking gill into a non-shrinking one for a time.

The efficiency of the compressible gill is of course affected by diffusion boundary layers. Insects in the egg stage can do nothing about reducing such boundary layers, but the active stages can reduce their thickness by moving about or, when they are stationary, by driving water past the surface of the bubble.

### 3.2.2 *The plastron or incompressible physical gill*

The term 'plastron' was first used by Brocher (1912) to describe the gas films on certain plastron-breathing chrysomelid and elmid beetles, but it was left to Thorpe and Crisp to give the first comprehensive experimental and theoretical account of plastron respiration (review by Thorpe, 1950).

A plastron is a gas film (or bubble) of constant volume and an extensive water-air interface. Such films are held in position by hydrofuge hairs or hydrofuge meshworks of various kinds. They resist wetting under the hydrostatic pressures to which they are normally subjected in nature. In well-aerated water a plastron



enables an animal to remain immersed indefinitely, when it obtains the oxygen it requires from the ambient water. In the plastron or incompressible gill, nitrogen plays no essential part, but of course it contributes to the backpressure of the system. Removal of all nitrogen from the plastron space without substituting another gas would effectively increase the pressure on the water-air interface of the plastron by 0.79 atmospheres, which would be enough to wet the plastrons of most insects.

I have previously (Hinton, 1969b) shown that only a relatively slight morphological change need take place in order to alter structures that will support a gas bubble that behaves as a temporary or compressible physical gill into structures that will hold a gas film against a pressure difference: the setae or micro-trichia only have to become a little denser. The modification required for this conversion is so slight that it is surprising that it has not happened more often. Nearly all of the intertidal bugs and beetles, however, are submerged for only a few hours at a time. The density of the setae of the intertidal limnichid, from Heron Island, *Hyphalus insularis* Britton, is shown in Fig. 3.1 A. The density of these setae may be compared with the density required for a plastron, e.g. that of an elmid beetle (Fig. 3.1B).

At one time or another I have examined a fair number of adult intertidal beetles, mostly Carabidae and Staphylinidae, but in none of these is there a plastron. A plastron is also absent in the Saldidae I have seen. It is to be noted that a plastron is not developed in the adults of the freshwater representatives of these groups. I have not examined the intertidal Hydraenidae, but the members of this family that live in freshwater streams often develop a plastron. Recent experiments with the plastron of *Hydraena gracilis* Germar show that much of it is retained after an exposure to an excess pressure in tap water for up to 3 hours.

It would appear that the adults of the intertidal Saldidae all use the compressible physical gill with the possible exception of *Aepophilus*, which is said to have a plastron (King and Ratcliffe, 1970). The prothorax and elytra of *Aepophilus* have microtrichia similar to those of the plastrons of many kinds of insects. Furthermore, on these areas the film of air is held against a pressure difference. Nevertheless, before the adults of this bug can be included among the plastron-breathers it has to be shown how the film of air on the prothorax and elytra communicates with the spiracles (but see Baudoin, 1955, Bull. Biol. Fr. Belg. 89, p. 87). The setae on the abdomen (where we would expect the plastron to be) are much too sparse for a plastron, and the abdomen lacks the mat of dense microtrichia.

Adults of bugs of the family Omaniidae and of beetles of the families Carabidae, Hydraenidae (all?), Staphylinidae, Melyridae, Lampyridae, Elacatidae, and Curculionidae either use a compressible physical gill or, e.g. some Staphylinidae, survive submergence by becoming comatose and thus drastically reducing their oxygen consumption. The adults of the few recorded intertidal Hymenoptera, e.g. Scelionidae (Masner, 1968) may also use a compressible physical gill. The

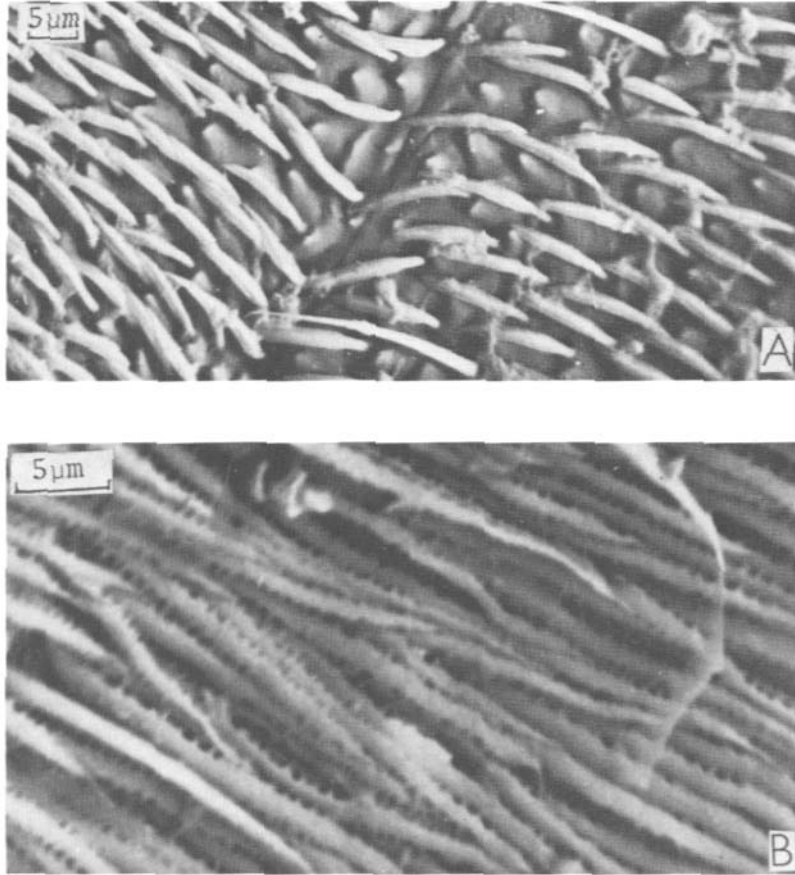

Fig. 3.1. Stereoscan electron micrographs of (A) the setae of the second and third abdominal sternites of the intertidal limnichid from Heron Island, *Hyphalus insularis*, and (B) the plastron of the elmid beetle, *Elmis maugetti* (original).

larvae of the Saldidae, Omaniidae, and larvae and pupae of all intertidal beetles are cutaneous breathers when submerged, but from time to time many will be trapped in air pockets and will then be using the compressible type of physical gill.

The larvae of all intertidal Diptera except *Canace* rely upon cutaneous respiration when submerged. *Canace* is a plastron-breather; the pupae and pharate adults of all intertidal Diptera except the Tipulidae, Dolichopodidae, *Canace*, and perhaps some other Canaceidae, are plastron-breathers. The pupae of some of the intertidal Chironomidae have very enlarged respiratory horns, but the functional significance of these enlargements is not known to me.

### 3.3 SUBMERGENCE AKINESIS

The larvae and adults of very many terrestrial insects inhabit environments in which involuntary submergence in water for hours or even days is a natural hazard. This particular hazard has resulted in the evolution of a very specific but complicated response to submergence: the insect ceases to struggle after a very short time and becomes comatose and no longer responds to stimuli. When it is later exposed above water and dry, it recovers its natural activity after some minutes or even hours. In contrast, many aquatic species when prevented from coming to the surface to replenish their supplies of air, e.g. dytiscid beetles, continue to struggle until they are killed by asphyxiation.

Terrestrial insects that become comatose on submergence survive simply because their oxygen demands in this state of akinesis or sustained quiescence are not incompatible with those that can be satisfied by cutaneous respiration at a time when much of the reduced metabolism is in any event anaerobic (Hinton, 1961). In a very interesting paper Evans et al. (1971) have shown that some littoral carabids (*Bembidion*, *Dichirotrichus*), staphylinids (*Bledius*), and heterocerids become comatose when submerged during high tide, when their oxygen consumption drops to a very low level. On recovery, the accumulated oxygen debt results in a period of increased oxygen consumption.

Adults of the staphylinid, *Oxyopus olens* (Mueller), larvae of the mealworm, *Tenebrio molitor* L., and many other insects often become comatose within 30 seconds of submergence. Attention has already been drawn to the fact that the speed of the response is such that the token stimulus must be contact with water and not lack of oxygen (Hinton, 1961). Many experiments confirm this view. For instance, there is no significant difference (R.M. Clayton, unpublished) between the speed at which larvae of the mealworm become comatose and the oxygen pressure in the water (Table 3.1). In this Table larvae were recorded as comatose when they ceased to move. From the point of view of subsequent survival,

Table 3.1. Times in seconds after which larvae of *Tenebrio molitor* became comatose when submerged in tap water at 17°C and various oxygen saturations. Twenty-five larvae were used for each series of experiments.

Percentage saturation	Minimum	Maximum	Mean	S.E.
6	48	112	69	4
10	5	134	77	2
30	2	118	54	6
50	2	180	74	7
80	5	120	47	4
95	5	180	86	8

this is the critical point. However, such larvae would sometimes respond to violent stimulation for a considerable period longer. In all instances continued submergence eventually led to a state when even the most violent stimulation, such as hard pinching, failed to evoke a response. Some experiments showed a relation between both oxygen and carbon dioxide pressures in the water and the time that the mealworm larvae would respond to violent stimulation. However, no such relation was found between either carbon dioxide or oxygen pressure in the water and the beginning of the comatose condition.

The phenomenon is clearly quite complicated. It may begin as a kind of reflex immobilization in which the nervous system is abnormally inhibited. Reflex immobilization may be caused in some insects by simply touching them or rolling them between the fingers (review in Wigglesworth, 1972). During immobilization the muscles are in a state of tonic contraction. However, reflex immobilization does not appear to be an apt description of the comatose state after prolonged submergence, especially when water has been absorbed and the insect is somewhat swollen.

I have dwelt at some length with the sustained comatose condition induced by submergence because from the point of view of the respiration of marine insects it may prove to be of great importance. The extent to which intertidal insects that do not normally use an air bubble become comatose is not known. Some of those that accidentally lose their air bubble survive only because they become comatose, as suggested by the work of Evans et al. (1971).

### 3.4 PLASTRON-BEARING SPIRACULAR GILLS

In order to understand the significance of spiracular gills in relation to the very special sorts of environments in which they have been repeatedly evolved by different kinds of insects, it is necessary to consider them not merely as structures adapted for underwater respiration, but as structures adapted both for the extraction of oxygen from the water and for atmospheric respiration. They are thus structures very well adapted to the intertidal environment where they are regularly subjected to alternate flooding and drying. In water a spiracular gill provides a relatively enormous surface area for diffusion, and its structure is such that it does not collapse under the hydrostatic pressures to which it is normally subjected. Out of water the enormous surface area of the gill does not involve the insect in water loss over such an area because the connection between the gill and the internal tissues of the insect is restricted to a cross-sectional area that is hardly, if at all, greater than that of the spiracles of terrestrial insects. Thus, a spiracular gill not only provides an enormous surface area for the extraction of oxygen from the ambient water, but in the air the total surface area for humidity exchanges between the saturated air in the tracheae and the drier air outside is about as

restricted as in any terrestrial insect with normally formed spiracles. We do not yet know for any one insect the relative amounts of oxygen absorbed through the body-wall cuticle and the spiracular gills. However, in many species the total water-air interface of the plastron of the gills is such that we may suppose that no limit is set to the impermeability of the body-wall cuticle.

#### *3.4.1 Utilization by developing adult of spiracular gills of pupa*

The pupal spiracular gill also functions as the respiratory organ of the pharate adult, i.e. the adult before it has shed the pupal cuticle. The manner in which one stage makes use of the respiratory organs of the previous stage has been described many times (review in Hinton, 1968a). So far as spiracular gills are concerned, the important point is that adult cuticle envelopes any inward projections of pupal cuticle, such as apodemes and tracheae. Thus the pupal tracheae are enclosed within the adult tracheae. The problem of water loss through the unmodified pupal spiracles, or the pupal spiracular gills, should the insect be exposed above water when the tide recedes, first arises when the larval cuticle is shed. In flies with spiracular gills this event normally occurs after the pupal-adult apolysis, when water loss through the spiracles is under the effective control of the pharate adult. In the pharate adult the regulatory apparatus appears to be effective in controlling water loss even though the pupal tracheae extend through the adult spiracular atria.

Dipterous larvae are descended from a common ancestor that had lost the regulatory apparatus of all spiracles, and no recent dipterous larvae have evolved such an apparatus. The spiracles of dipterous pupae never have a functional regulatory apparatus (in a few, e.g. Simuliidae and Psychodidae, such a regulatory apparatus is present on the pupal cuticle but it is operated by the muscles of the pharate adult). The Diptera are the only endopterygote insects that as a primitive feature lack a regulatory spiracular apparatus in both larvae and pupae. It seems evident from what has been said above that this fact may be of great significance in accounting for the fact that, unlike other endopterygotes, the non-pharate pupal stage is either absent or of very short duration in the Diptera.

#### *3.4.2 Polyphyletic origin of plastron-bearing gills in marine insects*

Plastron-bearing spiracular gills have been independently evolved in beetles and flies no less than 17 times (Hinton, 1968a). Among intertidal insects they have been evolved only in the Diptera, and within this order they have been independently evolved at least four times, as follows:

## Nematocera

1. Tipulidae (Limoniini): *Geranomyia*
2. Tipulidae (Limoniini): *Dicranomyia* and *Idioglochina* Brachycera-Orthorrhapha
3. Dolichopodidae: *Aphrosylus* Brachycera-Cyclorrhapha
4. Canaceidae: *Canace*

The families Tipulidae, Dolichopodidae, and Canaceidae belong to very different sections of the order Diptera, and it can therefore hardly be disputed that the marine representatives of each invaded the sea independently.

The few Tipulidae that have invaded the sea from land or freshwater have come from at least two quite different stocks. Although at first sight this seems to be most unlikely, looking at the matter a little more closely no other conclusion appears to be possible. *Geranomyia* is a cosmopolitan genus of nearly 300 described species. The larvae and pupae live in moist terrestrial environments, but a few are semi-aquatic or aquatic. A few species are intertidal, e.g. *G. unicolor* Haliday and *G. bezzi* Alexander and Leonard, and only these intertidal species have, so far as we know, plastron-bearing spiracular gills.

*Dicranomyia* is also a cosmopolitan genus but with an even larger number of described species. The habits of the larvae and pupae are similar to those of *Geranomyia*. A few species are intertidal, and these have spiracular gills that are sometimes very similar to those of *Geranomyia*, whereas the terrestrial species of *Dicranomyia*, like the terrestrial species of *Geranomyia*, have respiratory horns similar to those of most genera of Limoniini. Although the spiracular gills of the intertidal species of *Geranomyia* and *Dicranomyia* are similar, this similarity is the result of convergence, a convergence of structure that has not extended to the adults of the two genera. Some of the species of *Dicranomyia*, e.g. *D. trifilamentosa* Alex. (Fig. 3.2D) have 3-branched gills, and the branches are entirely covered by a plastron network. In others, e.g. *D. monostromia* Tokunaga, the gills are unbranched (Fig. 3.2E) and more closely resemble those of *Geranomyia* than they do other species of *Dicranomyia*. However, the fine structure of the plastron of the different species of *Dicranomyia* (Figs 3.3, 3.4 and 3.6B) is identical, however much the gills differ in general appearance, and very different indeed from that of the plastron of *Geranomyia* (Figs 3.5 and 3.6A).

About 25 species of *Idioglochina* have been described. Although the immature stages of only a few intertidal species are known, the available evidence suggests that all of the species are intertidal and that all of the pupae have plastron-bearing spiracular gills (Hinton, 1967b). *Idioglochina* is of course derived from terrestrial ancestors. If the genus is really distinct from *Dicranomyia*, which I doubt, it must represent a third independent origin of spiracular gills in marine Tipulidae. However, even if *Idioglochina* is not distinct from *Dicranomyia*, the

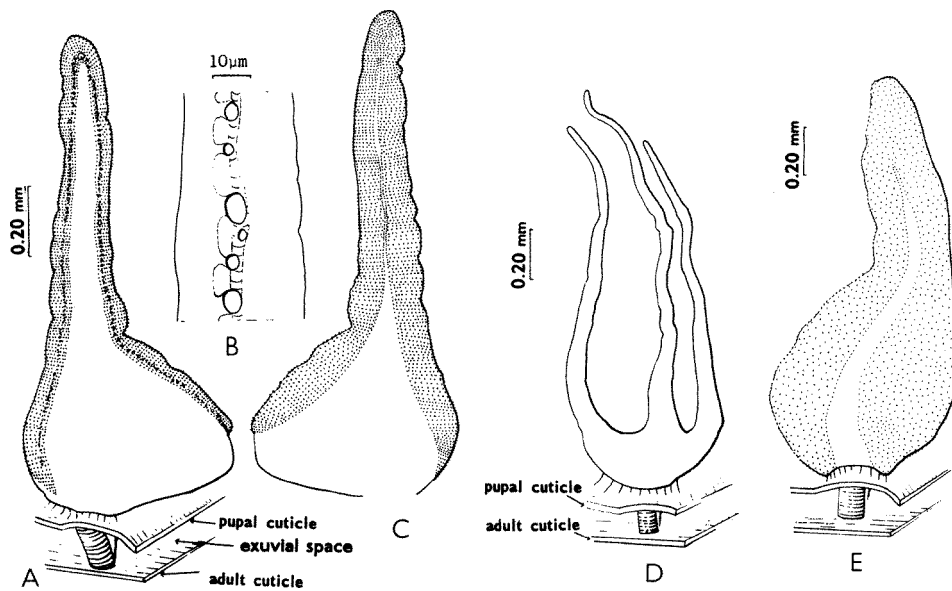

Fig. 3.2. Spiracular gills of intertidal Tipulidae. (A) Dorsal view of *Geranomyia unicolor*. (B) Aeropyles of same, surface view. (C) Ventral view of gill of same. (D) *Dicranomyia trifilamentosa*. (E) *Dicranomyia monostromia*. In two of the species the plastron areas are stippled (after Hinton, 1968a).

possibility remains that two different groups of the genus *Dicranomyia* have independently invaded the sea from land or freshwater. Scanning electron micrographs of the plastron of *Idioglochina marmorata* (O.-S.) and species of *Dicranomyia* do not reveal any significant difference in fine structure (Hinton, 1968a). This suggests a common origin but is not certain proof of one.

### 3.4.3 Origin and significance of tissue isolated in spiracular gills

One of the most remarkable phenomena known in insects is the isolation of living epidermal cells in the lumen of the spiracular gills. This isolation of living epidermis occurs in the spiracular gills of marine Tipulidae and Dolichopodidae as well as in the spiracular gills of a number of freshwater insects. The isolated tissue seems to have no function in some insects. However, in others it plays an essential role either in expansion of the gill, e.g. Simuliidae, or in maintaining the turgor pressure within the gill lumen necessary for its proper function, e.g. some Tipulidae.

During the whole of the pupal period the lumen of the spiracular gill is continuous with the haemocoel, and the layer of epidermal cells that secretes the cuticle of the gill wall is continuous with the epidermis of the body wall of the pupa. At the pupal-adult apolysis of the Tipulidae and Dolichopodidae the

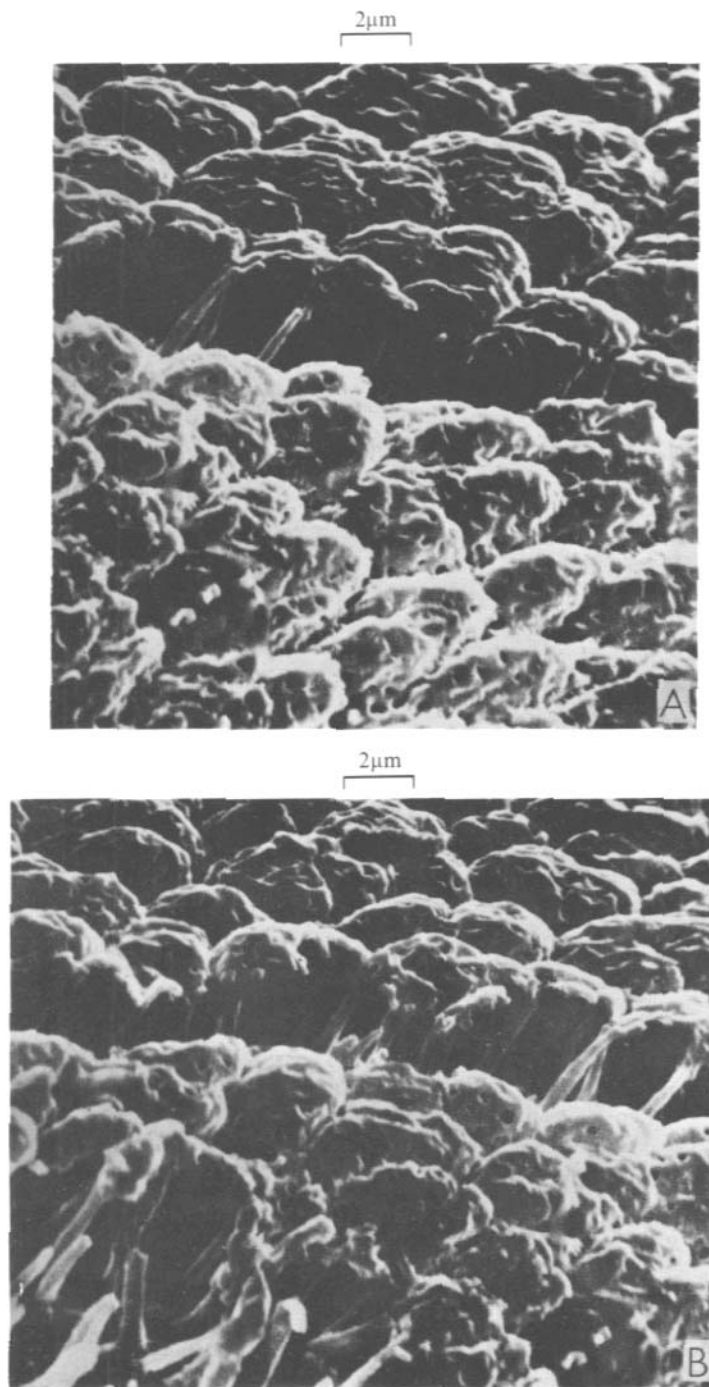

Fig. 3.3. Stereoscan electron micrographs of the plastron of the spiracular gill of *Dicranomyia triflamentosa* (original).



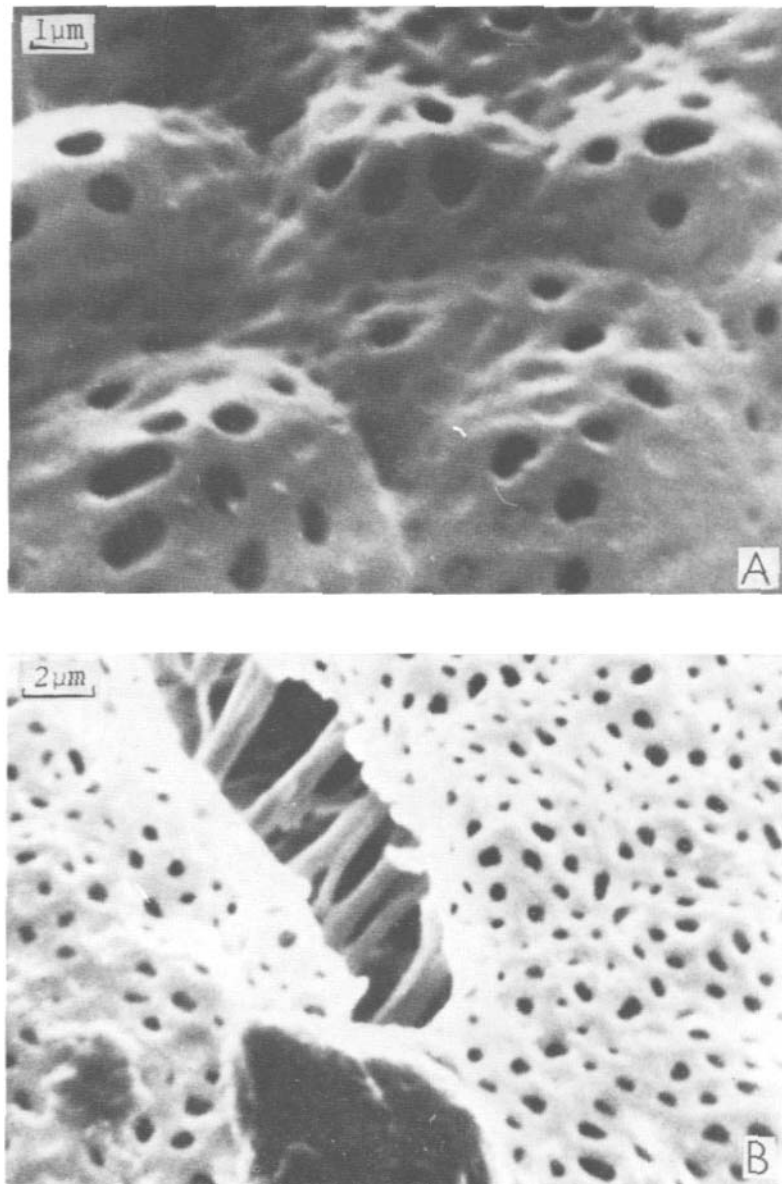

Fig. 3.4. (A) Stereoscan electron micrograph of the plastron of *Idioglochina marmorata*. (B) Same of *Diceromyia monostromia* (original).

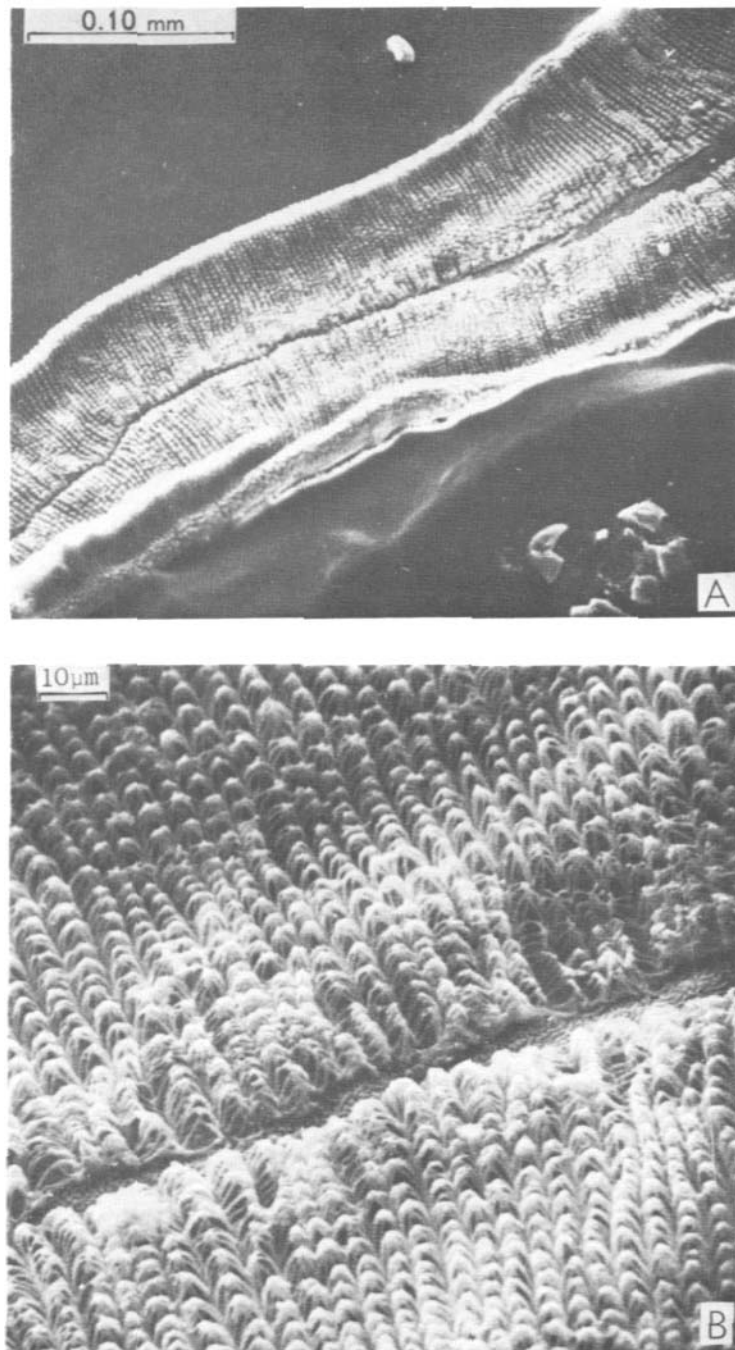

Fig. 3.5. Stereoscan electron micrographs of the plastron of the ventral side of the spiracular gill of *Geranomyia unicolor* (original).

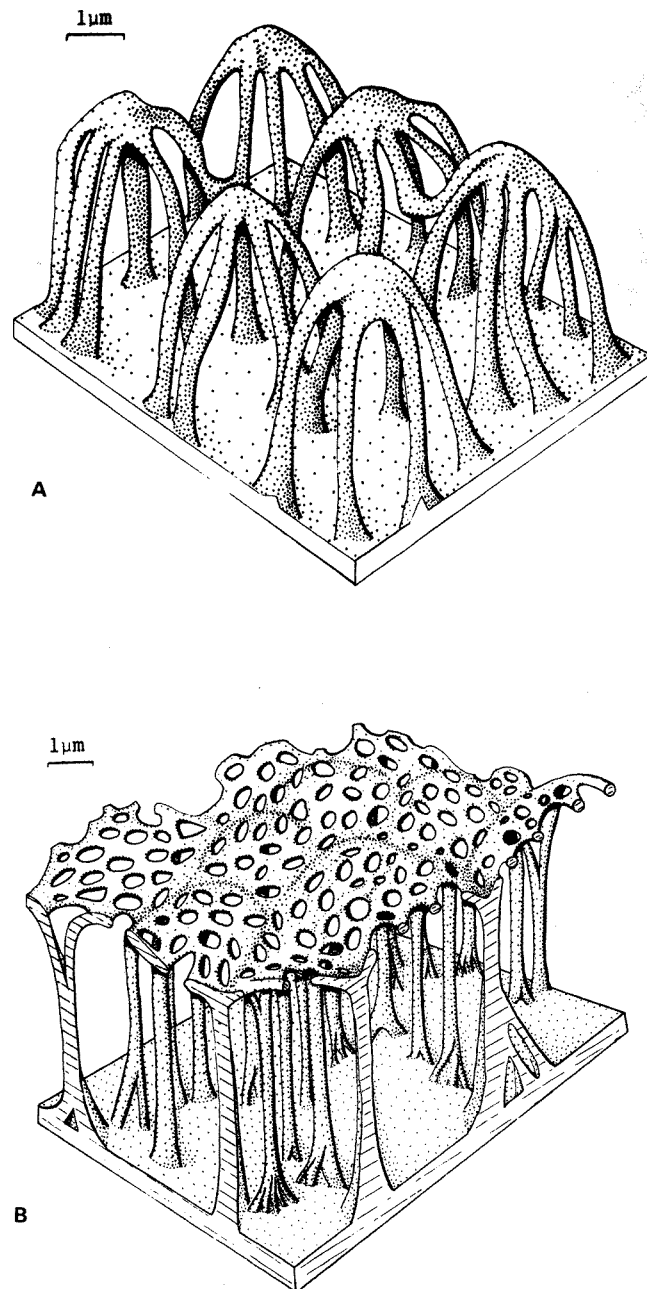

Fig. 3.6. Fine structure of the plastron of (A) *Geranomyia unicolor* and (B) *Dicranomyia trifilamentosa* (after Hinton, 1968a). The fine structure of the plastron of *Geranomyia* is unlike that of any other known tipulid but is rather like that of the spiracular gills of some Chironomidae, e.g. *Amatopynia nebulosa*, and that on the inside of the prothoracic trumpets of some Culicidae.

epidermis of the body wall retracts away from the opening into the gill lumen and in time loses all connection with the epidermis of the gill wall, which is left behind in the lumen of the gill. During the pupal-adult apolysis a thin sheet of cuticle, the basal membrane, is secreted across the opening into the gill lumen. When the adult cuticle is secreted, the tissue in the gill lumen is isolated from the living animal not only by the basal membrane but also by a layer of moulting fluid and the cuticle of the body wall of the pharate adult. The isolation of the tissue in the spiracular gill from the body of the insect is both mechanically and physiologically complete: after the secretion of the basal membrane the gill may be detached from the insect without in any way affecting the activity or the duration of life of the isolated tissue. It is not known if the basal membrane is secreted by the retracting epidermis of the body wall, or by the epidermis within the gill, or by both.

Besides the epidermis, a quantity of blood is also isolated in each gill. In most species the blood appears to lack blood cells. Blood cells are certainly absent in the gills of *Antocha vitripennis*, a freshwater tipulid that has rather transparent gill walls that make it possible to examine the contained tissue in the live animals (Hinton, 1957). In the spiracular gills of some freshwater insects, e.g. *Dutero-phlebiidae*, a few cells thought to be blood cells were found on the lumen side of the basement membrane, but these cells may well have been epidermal cells that had undergone a precocious dissociation and migration (Hinton, 1962). The isolation of epidermis and blood in the pupal spiracular gills of marine and fresh water insects has been independently evolved on at least 11 occasions. There is good reason for believing that isolation occurs in the first instance because it is advantageous to complete the process of apolysis as quickly as possible. When a new and very long appendage is formed a lot of time is required by the new stage to retract or absorb the tissues from the old appendage. It has been shown that one of four things can happen with the epidermis of old appendages: (1) it may be completely retracted out of the old appendages and incorporated into the body of the new stage, which is its normal fate, particularly when the appendages of the new stage are relatively short; (2) the epidermis that secreted the cuticle of the appendages of the previous stage may be cytolysed in situ and the products of cytolysis utilised by the new stage; (3) the epidermis may be partly retracted, partly cytolysed in situ, and partly discarded, as in the gills of *Sialis* at the larval-pupal apolysis (Selman, 1960); or (4) the epidermis may be completely discarded in the lumen of the appendages of the previous stage, as in the spiracular gills of most insects at the pupal-adult apolysis, or even (*Simuliidae*) before this apolysis.

The tissue discarded within the appendages of the previous stage generally ceases to have a function and therefore a selective value for the new stage. The discarded tissue is a loss to the insect. It has been supposed that the cost of this loss is less in the long run than the cost of retrieving the tissue (Hinton, 1968a). Retraction of tissue in an appendage requires a prolongation of the moulting

period, a period when the insect is particularly vulnerable. It has therefore been supposed that the tissue is discarded in certain appendages of the previous stage because, on balance, the loss it represents as a reserve of food is less than the cost that would be incurred in other ways by its absorption or retraction into the body of the new stage.

#### 3.4.4 *Function of tissue isolated in spiracular gills*

In the preceding paragraphs the origin of the habit of discarding living epidermis in the spiracular gills is discussed. In some families of insects the attributes of the tissue isolated in the gill are invariably exploited and have come to be of great significance in the proper functioning of the gill. We do not know enough about the ancestry of many groups, e.g. flies of the family Simuliidae, to know whether the isolation of tissue preceded its exploitation or whether the habit of isolating tissue in the gills was evolved *pari passu* with the exploitation of its attributes. However, it seems most probable that in each group there was a long history of discarding tissue in the spiracular gills before circumstances were such that some of its attributes could profitably be exploited. This sequence of events seems the most likely because, firstly, in most of the groups that isolate tissue the isolated tissue has no discernable function, and, secondly, where the evolutionary history of the group is sufficiently well known to choose between the alternatives, e.g. the Limoniini (Tipulidae), there is no question but that the selective pressures that resulted in the isolation of the tissue were effective long before there was sufficient selective pressure to exploit the attributes of the tissue (Hinton, 1968a).

An extended account of the functions subserved by the tissue isolated in the spiracular gills has been given by Hinton (1968a). These functions are surprisingly varied. No less than six different ones are already known, as follows: (1) Contraction of the gills in the Simuliidae before the larval-pupal ecdysis when they are evaginated from the pupa but lie in the moulting fluid between larval and pupal cuticles. (2) Expansion of the gills after the larval-pupal ecdysis, when the gills for the first time come into contact with the ambient water, e.g. Simuliidae and some Tipulidae. The unwrinkling and swelling out of the gills on contact with the ambient water is quite independent of any activity of the living animal but is brought about by absorption by the isolated tissue of water through the semi-permeable gill walls. (3) Sclerotization of walls of spiracular gills after the larval-pupal ecdysis. In many insects, e.g. Simuliidae and some Tipulidae, there is some sclerotization of the gill walls after the larval-pupal ecdysis. This sclerotization is brought about by the isolated epidermis. (4) Maintenance of gill turgidity in the Tipulidae. In a number of freshwater Tipulidae and possibly also in some of the marine species of *Dicranomyia* the gill walls are not rigid. It would appear that this loss of rigidity is only made possible by the presence of isolated epidermis and blood in the lumen. The isolated tissue takes up water by osmosis and so

keeps the gill turgid so that the scanning capacity of the plastron is not lost by crumpling of the surface. (5) Equalization of internal and ambient pressures in the Simuliidae by rupture of a pre-formed area of weakness, the ventral membrane. After the larval-pupal ecdysis water continues to be absorbed by the isolated tissue in the gill lumen through the ventral membrane until the internal pressure becomes sufficient to rupture the ventral membrane. When this happens, the shape of the gill will not be affected by high hydrostatic pressures because the pressures within and without are always equal. (6) Strengthening of the gill by cuticularization of the isolated epidermis. In the marine *Aphrosylus* there is some cuticularization of the isolated tissue: the gill is not distorted when dried in a vacuum of  $4 \times 10^{-6}$  Hg (Hinton, 1967c), but its rigidity is chiefly the result of sclerotization of the walls rather than cuticularization of the isolated epidermis. In many of the freshwater Blepharoceridae the isolated epidermis is entirely cuticularized.

In probably all marine flies the epidermal cells contribute to the tanning of the gill walls even after their isolation. In the Dolichopodidae there is some cuticularization of the isolated epidermal cells. In the Tipulidae the isolated epidermis and blood absorb water through the semipermeable gill walls and so effect the full expansion of the gills after the larval-pupal ecdysis when they come into contact with the ambient water for the first time. It should be remembered that in many flies, such as the Tipulidae, the pupal-adult apolysis occurs very soon after the larval-pupal ecdysis, and in a fair number even before this ecdysis. Thus, by the time that the larval cuticle is shed the insect is either an adult or shortly to be one.

Because of the time-relations between apolyses and ecdyses, the chief function of the spiracular gills is as respiratory organs of the adult enclosed within the pupal cuticle, i.e. the pharate adult. Indeed, in all flies the pupal gill functions as the respiratory organ of the pupa for only the very brief period after the larval cuticle is shed but while the insect is still a pupa. In a number of Tipulidae and other flies in which the pupal-adult apolysis occurs before the larval-pupal ecdysis, the pupal gills function only in the pharate adult stage.

In the only marine tipulid that I have bred, *Geranomyia unicolor*, the gill walls are sufficiently rigid so that the lumen may be broken into without causing crumpling of the plastron surface. Thus, although the isolated epidermis and blood are responsible for the slight expansion of the gill that occurs when it comes into contact with water at the larval-pupal ecdysis, once the gill walls become rigid and tanning in them is complete the isolated tissue seems to have no further function. However, in some of the species of *Dicranomyia* the gill walls are not nearly so rigid. Although I have not been able to experiment with any of these species of *Dicranomyia*, or any marine *Idioglochina*, experience with related freshwater forms such as *Orimagula* (Hinton, 1965, 1966a) and *Antocha* (Hinton, 1957) makes it possible to predict with confidence that the tissue isolated in the

gill will have a considerably greater significance in gill function than it has in such forms as *Geranomyia*.

In the many different groups of Diptera now known to isolate epidermis in the spiracular gills, the duration of life of the isolated epidermis is much the same whether it plays an important part in gill function or not. Two notable exceptions occur to this rule, e.g. the Simuliidae and Blepharoceridae, both freshwater forms that do not concern us here. Apart from the exceptions mentioned, the epidermis remains in good condition and competent to repair damage to the gill wall even after the adult has shed the pupal cuticle and flown away. In experiments with *Geranomyia unicolor* (Hinton, 1957) the epidermis repaired the gill wall 10 hours after the adult had emerged. In the semi-aquatic *Lipsothrix* and the freshwater *Antocha* repair of the gill walls has been shown to occur no less than five days after the emergence of the adult (Hinton, 1957).

Cuts or tears in the gill walls are repaired in both the marine *Geranomyia* and freshwater tipulids (*Lipsothrix*, *Orimagula*, *Antocha*) by sclerotin: the material withstands hot concentrated nitric acid for more than 10 minutes, and its formation is completely inhibited by phenylthiourea. Repair consists of no more than the formation of a sclerotized wound plug that seals the lumen from the ambient liquid. The plastron or any plastron structures that are damaged are never secreted again by the isolated epidermis.

As noted above, the loss of rigidity of the gill walls in tipulids is only possible because the isolated epidermis and blood maintain the rigidity of the gill necessary for its proper functioning. In gills with semipermeable, non-rigid walls, the osmotic pressure of the isolated tissue is equivalent to a real physical pressure less the osmotic pressure of the ambient water. For instance, the turgor pressure in the gill of *Antocha vitripennis* is about 4.3 atmospheres less the osmotic pressure of the stream water, which is about 0.1 atm.

A tear or cut into the lumen of a non-rigid gill results in an instantaneous expulsion of some of the isolated tissue as the internal and ambient hydrostatic pressures are equalised. Experiments have shown that in freshwater species (*Orimagula*, *Antocha*) breaking into the lumen of the gill immediately activates the isolated epidermis to form a wound plug. It seems certain that the same occurs in some of the marine species of *Dicranomyia* and *Idioglochina* with non-rigid gill walls. As soon as a plug is formed and before it is fully tanned, the osmotic pressure of the tissue that has remained within the gill causes an inflow of water through the semipermeable gill walls. Thus, a little pressure is almost immediately exerted against the newly formed clot or wound plug. Experiments with *Orimagula* and *Antocha* have shown that the mechanical strength of the wound plug increases fast enough effectively to resist the increasing turgor pressure in the gill.

The turgor pressure that can be achieved after a break in the gill wall has been sealed is always less than the original turgor pressure. This is because at the time of a break there is an explosive outflow of some tissue with the result that the

total volume of isolated tissue after a break is less than before one. Although the original turgor pressure is high enough to allow for a wide safety margin and a few breaks, there is nevertheless a limit to the number of times that a gill can be torn open by abrasion or by predators and still retain the amount of tissue necessary to achieve the appropriate turgor pressure. The number of times that a gill can be damaged and still recover a sufficient turgor pressure depends entirely upon the total volume of isolated tissue: the greater the total amount of isolated tissue the less it is diluted after an injury. In non-rigid gills, like those of the tipulids, there would seem to be some selective pressure for increasing the amount of the isolated tissue. It is therefore not very surprising to find that special structures, called tissue reservoirs, have been independently evolved on no less than three occasions, once in *Orimagula* and twice in *Antocha* (Hinton, 1966a).

Insects with spiracular gills will spend all or much of the time between tides above water. At this time it may be expected that the gills will dry up and the isolated tissue lose its water through the gill walls that are, as we have seen, freely permeable to water. It is when the pupae are exposed above water and the gills are dry that they are most liable to damage. Curiously enough, the isolated tissue is always, so far as is now known, capable of entering a state of cryptobiosis when it is dry. By cryptobiosis is meant a state when the metabolism comes reversibly to a standstill (review in Hinton, 1971). Experiments with some tipulids have shown that when the gill is dry, injuries to it do not, as a matter of course, result in an immediate loss of tissue. When the gill is subsequently flooded, the isolated tissue rapidly absorbs water. At some stage in its re-hydration it becomes metabolically active again and initiates the formation of a wound plug. The amount of tissue lost during rehydration before an initial wound plug is formed is not known. The ability of the isolated tissue to enter a state of cryptobiosis is of great selective value to an insect like a tipulid with non-rigid gill walls because in both intertidal areas, as well as in many freshwater environments, alternate flooding and drying is a normal hazard. It has previously been noted that the capacity of the isolated epidermis to enter a state of cryptobiosis was not evolved in response to the requirements of the spiracular gill. It has been shown that this capacity is a very general characteristic of epidermis (Hinton, 1957, 1968a): in a manner of speaking, the isolated epidermis is already pre-adapted for one of the requirements of spiracular gills.

### 3.5 RESPIRATORY ADAPTATIONS IN SOME MARINE DIPTERA

#### 3.5.1 *Tipulidae*

In the last section, much has been said about the gills of the Tipulidae, so that here it is only necessary to refer briefly to some of the attributes of these remarkable respiratory



structures not mentioned elsewhere. The marine tipulids include a few species of *Dicranomyia* and *Geranomyia* and about 25 species of *Idioglochina*, a genus that at present appears to be exclusively intertidal. Notes on the biology, sometimes with brief descriptions of the pupal gills, have been given for a number of intertidal tipulids: *Geranomyia* (Seurat, 1924; Saunders, 1930; Poisson, 1932; Morton, 1954) *Dicranomyia* (Tokunaga, 1930, 1933) and *Idioglochina* (Saunders, 1928; Tokunaga, 1939).

Among tipulids spiracular gills are known only in the Limoniinae (some writers give family rank to this subfamily). The intertidal forms all belong to the tribe Limoniini. So far as I know, in all members of this tribe, including the very numerous terrestrial forms, epidermis and blood are isolated in the lumen of the respiratory horn at the pupal-adult apolysis, whereas in the terrestrial Eriopterini the epidermis that secreted the walls of the respiratory horn and the spiracular atrium is withdrawn into the body of the adult at the pupal-adult apolysis. However, in the semiaquatic Eriopterini with spiracular gills (*Lipsothrix*) tissue is isolated in the lumen of the gills. Thus in the Eriopterini the habit of isolating

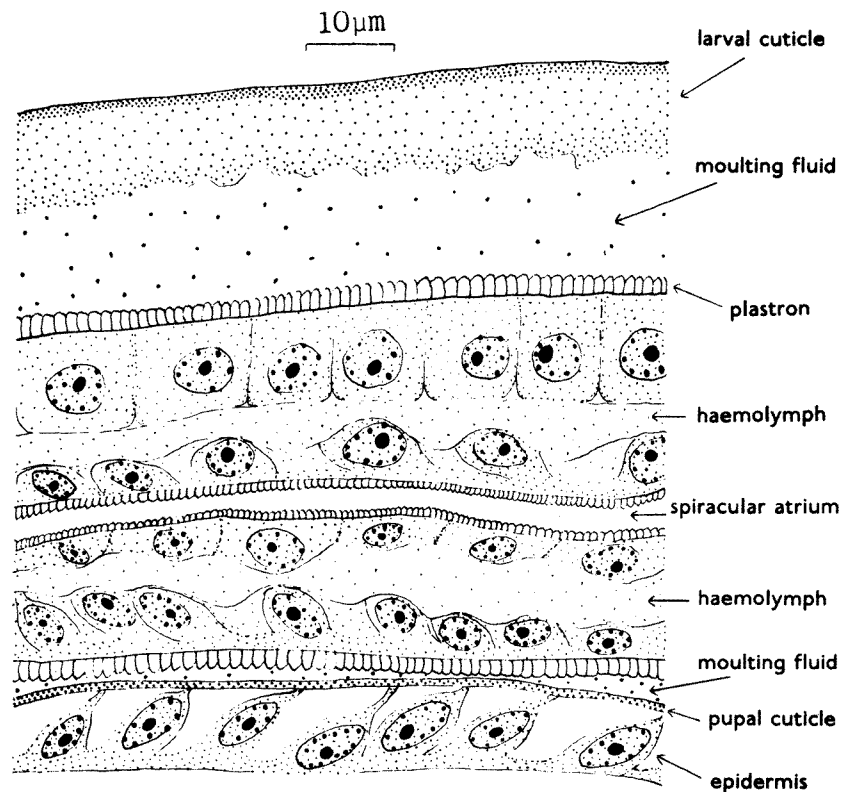

Fig. 3.7. Section through the spiracular gill of *Geranomyia unicolor* in the pharate pupal stage when the gill is between the old larval cuticle and the new pupal cuticle (original).

tissue in the gills is established some time during the process of evolving a spiracular gill from a respiratory horn, whereas in the Limoniini the habit is well-established long before spiracular gills are evolved and persists after they have been evolved.

After the larval-pupal apolysis, and after the evagination of the spiracular gills from the body of the pupa, the gills come to lie in the moulting fluid between the old larval cuticle and the new pupal cuticle (Fig. 3.7). During this pharate phase of the pupa the epidermal cells that secreted the walls of the gill and the spiracular atrium are more or less cubical (Fig. 3.7). However, after the larval-pupal ecdysis the epidermal cells become detached from the cuticle, round up, and migrate for short distances. They eventually cluster together in groups of irregular size in the proximal part of the lumen. At this time it is very difficult to distinguish them from blood cells. The process of migration and dissociation has actually been followed in a species of *Antocha* with more or less transparent gill walls (Hinton, 1957). Clusters of dissociated epidermal cells in the proximal part of the lumen of the gill of *Geranomyia* are shown in Fig. 3.8.

The spiracular atrium, at least proximally (Figs. 3.8 and 3.9), has numerous fine cuticular projections. The functional significance of such projections into spiracular atria is to reduce water loss (Hinton, 1947). By pressure resistance and frictional drag they restrict or altogether prevent tidal movements of air through the spiracles and so make it possible to establish a humidity gradient between the saturated air in the tracheae and the drier air outside. That they function in this way even in normally formed spiracles has been confirmed by Brockway and Schneiderman (1967). Of course, the cuticular projections into the atria function in preventing water loss only when the tide recedes and the insect is exposed above the surface.

The only intertidal tipulid in which the plastron has been tested for resistance to hydrostatic pressures is *Geranomyia unicolor*. The plastron of this species is immediately wetted at 1.4 atmospheres, resists wetting at 1 atm for about 10 minutes, but resists wetting at 0.3 atm for more than two hours (Hinton, 1968a). The larvae live in the upper intertidal zone among lichens and algae, especially *Lichina pygmaea* and *Catenella repens*, on which they feed. The larvae pupate where they feed, and the resistance of the plastron of the pupa to high pressures seems to provide a reasonable safety margin. It is interesting to compare the resistance of the plastron of *Geranomyia* with that of *Canace*. The much greater resistance to hydrostatic pressures of the plastron of *Canace*, e.g. 1 atm for 9 hours, is but a reflection of the fact that although *Canace* is usually found in the upper half of the intertidal zone, it may nevertheless occur in the lower part of this zone feeding on *Enteromorpha* where freshwater streams enter the sea (Hinton, 1967a).

If the plastron is to serve as an efficient respiratory structure, its water-air interface must be sufficient to satisfy oxygen demands during the whole of the pharate adult period and perhaps in some species also during the late pupal

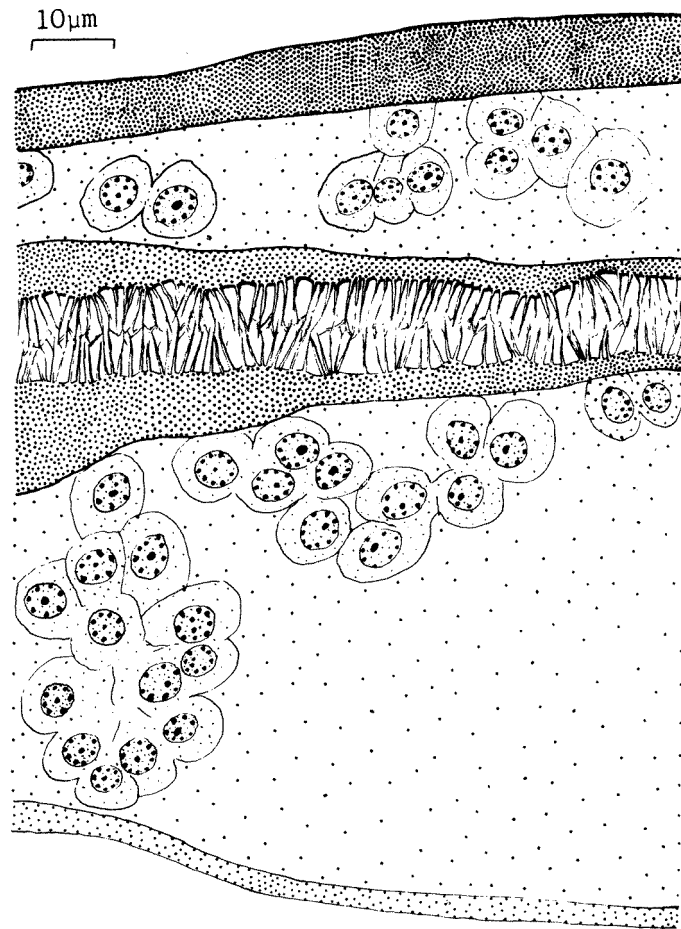

Fig. 3.8. Section near the base of the spiracular gill of *Geranomyia unicolor* after the larval-pupal ecdysis and after the dissociation and migration of the epidermal cells is completed in the pharate adult stage (original).

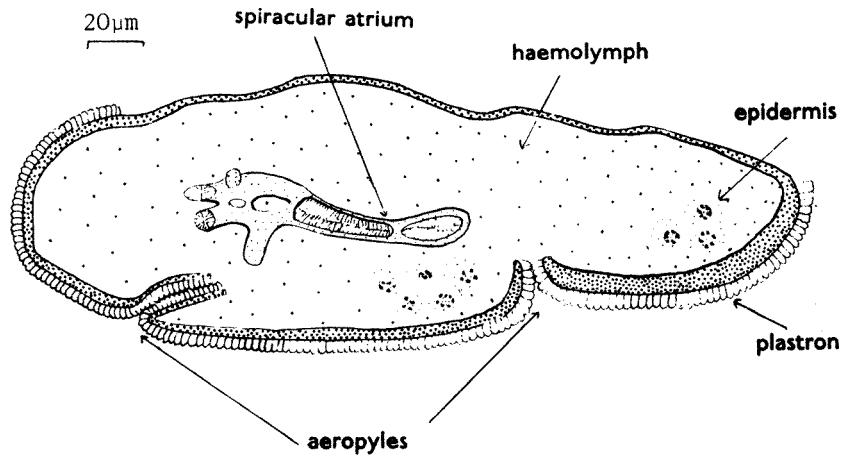

Fig. 3.9. Section near the base of the spiracular gill of *Dicranomyia triflamentosa* in the pharate

period, i.e. in species in which the pupal-adult apolysis occurs after the larval-pupal ecdysis. The oxygen consumption of none of the intertidal forms with spiracular gills has been measured, but, speaking generally, the rate of respiration of insects is roughly proportional to their total live weight. It is thus possible to compare, if only very roughly, the efficiencies of the plastrons of different kinds of insects. For reasons discussed at length elsewhere (e.g. Hinton, 1968a), it seems that when the ratio of water-air interface to weight is about  $1.5 \mu\text{m}^2$  per milligram or better, the insect can probably satisfy its oxygen demands through the plastron. The ratios of water-air interface to weight of some intertidal tipulids, compared with *Aphrosylus* and *Canace*, are as follows: It should be noted that in at least some of these intertidal forms the pupa and pharate adult can

	Interface ( $\mu\text{m}^2/\text{mg}$ )	Total plastron area ( $\mu\text{m}^2/\text{mg}$ )
<i>Geranomyia unicolor</i>	—	$1.0 \times 10^5$
<i>Dicranomyia trifilamentosa</i>	$1.0 \times 10^5$	$4.5 \times 10^5$
<i>Dicranomyia monostromia</i>	$6.7 \times 10^4$	$2.9 \times 10^5$
<i>Canace nasica</i>	$3.9 \times 10^4$	$1.1 \times 10^5$
<i>Aphrosylus celtiber</i>	$3.9 \times 10^5$	$1.6 \times 10^6$

satisfy at least some of their oxygen demands by cutaneous respiration, but no figures are available.

### 3.5.2 Dolichopodidae

A large number of Dolichopodidae have invaded coastal or estuarine intertidal areas, e.g. Dolichopodinae (*Dolichopus*, *Hygrocelethus*), Hydroporinae (*Thinophilus*, *Hydroporus*, *Hypocharassus*), Aphrosylinae (*Aphrosylus*, *Cymatopus*), Raphinae (*Machaerium*, *Porphyrops*, *Epithalassius*), and Diaphorinae (*Asyndetys*). All species of *Aphrosylus* appear to be intertidal, and it is suspected that all genera of Aphrosylinae will be found to breed only in the intertidal zone. However, most of the genera listed above of other subfamilies have species that breed both in the intertidal area and far inland, e.g. *Dolichopus nubilus* Meig. and *Hydroporus oceanus* (Macq.) (Dyte, 1959). The wide salinity tolerance of species of Dolichopodidae is unusual. I have found larvae of *Liancalus virens* (Scop.) and *Syntormon pallipes* (F.) in algae on rocks very close to the splash zone and also in inland areas far from the sea. The biology of coastal and estuarine Dolichopodidae is reviewed by Smith (1952) and Dyte (1959).

Nearly all Dolichopodidae have the first pair of thoracic spiracles modified to form long respiratory horns. Some, at least of the species of *Thrypticus*, are

exceptional and have instead the spiracles of the second to fifth abdominal segments conspicuously modified. The latter spiracles are long, sharply pointed, and serve to tap the intercellular air spaces of the host plant. I have been able to examine the respiratory horns of 15 species of dolichopodids (most kindly lent to me by Mr C.E. Dyte of the Pest Infestation Control Laboratory, Slough), and in all species tissue is isolated in the lumen of the horn at the pupal–adult apolysis. The selective advantage, if any, of the isolated tissue is unknown. The almost universal occurrence of isolated tissue in the respiratory horns of the family is sufficient evidence that in the intertidal forms the modification of a normal respiratory horn into a plastron-bearing gill took place after and not before the isolation of tissue.

The structure of the plastron-bearing spiracular gill of *Aphrosylus celtiber* Haliday has been described in some detail (Hinton, 1967c). The respiratory horns are 2 mm long, and the apical 1.5 mm of each horn is modified to form a plastron. The basal 0.37 mm or so of the respiratory horn is unmodified and identical in structure to the respiratory horns of wholly terrestrial dolichopodids. The spiracular atrium is present only within the unmodified part of the horn (Fig. 3.10A). In the dolichopodids without a plastron the spiracular atrium extends more or less to the apex of the respiratory horns. The gill, that is the structure beyond the basal sixth of the horn, is a prolongation of the body wall adjacent to the spiracle and does not include any structures that can properly be considered to be parts of the spiracle itself. The walls of the gill consist of two distinct parts: (1) an inner solid wall that surrounds the epithelium, and (2) an outer meshwork that contains the plastron gas (Fig. 3.10B).

*Aphrosylus* is most unusual in that it is the only known pupa with plastron-bearing spiracular gills that also has functional abdominal spiracles. The significance of the retention of abdominal spiracles in *Aphrosylus* is immediately apparent when we consider its pupation habits: it is the only pupa with such gills that pupates in an air-filled cocoon that stays air-filled when it is submerged. In the marine Tipulidae, as well as in other pupae with plastron-bearing gills, the abdominal spiracles are non-functional (the freshwater Empididae are a special case in which the abdominal spiracles are modified to form gills), and their cocoons do not trap air but fill with water.

It is worth noting that unmodified spiracles are not likely to be significant in respiration beneath the surface. Plastron respiration across the water–air interface of the spiracles inevitably occurs, but the total surface area of the spiracles in relation to the weight of the insect is about an order of magnitude less than that required to satisfy the oxygen demands of the insect. For instance, it has been calculated that in pupae with unmodified spiracles the sum of the surface areas of the spiracles is about 500 to 1000  $\mu\text{m}^2$  per mg of body weight (Hinton, 1966b), whereas pupae that have plastrons with the least area of water–air interface, e.g. the fly *Eutanyderus*, have 15,000  $\mu\text{m}^2$  per mg. These rough calculations seem

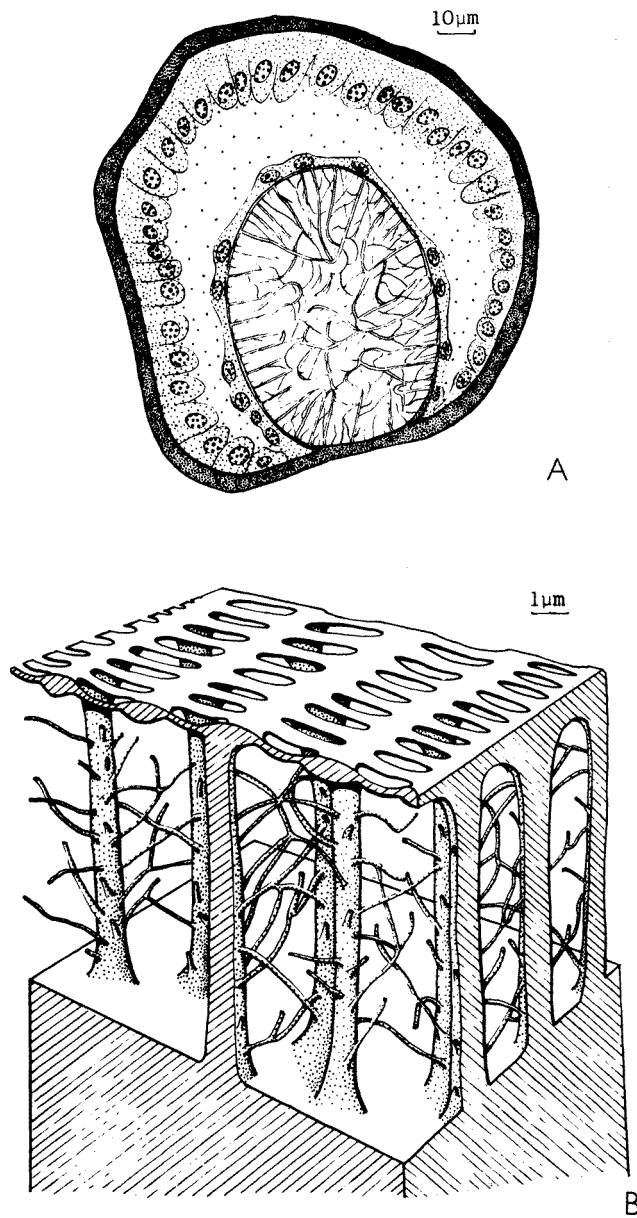

Fig. 3.10. *Aphrosylus celtiber*. (A) Transverse section through the middle part of the pupal respiratory horn in the pharate adult stage showing the epidermal cells isolated in the lumen. This section is below the plastron-bearing part of the horn. (B) Diagrammatic view of the vertical struts and the plastron network of the apical part of the spiracular gill (after Hinton, 1967c).

to confirm what is evident enough anyway: the loss of functional abdominal spiracles in pupae that are normally submerged is evidence enough that the volume of gas exchange across spiracles is not of sufficient selective advantage for unmodified spiracles to be retained in a functional condition.

*Aphrosylus* has functional spiracles on the first seven abdominal segments as do the pupae of all terrestrial and freshwater Dolichopodidae examined (Hinton, 1967c). Apart from *Aphrosylus*, all other dolichopodid pupae lack a plastron but have very well-developed respiratory horns. All of these also pupate within an air-filled cocoon (Fig. 3.11). Most pupate in places that when not actually under a thin film of water are likely to be

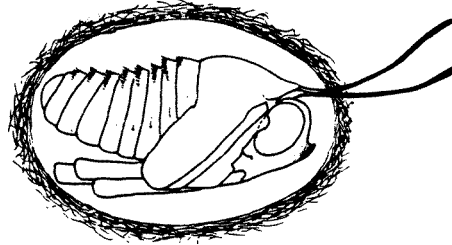

Fig. 3.11. Pupa of the dolichopodid, *Aphrosylus praedator*, in its air-filled cocoon (after Saunders, 1928).

regularly submerged for shorter or longer periods. In all these dolichopodid genera, as well as in the marine *Aphrosylus*, the cocoon itself functions as a plastron. It has a large water–air interface and the volume of air it contains remains constant so long as the mechanical strength of the cocoon resists the hydrostatic pressures to which it is subjected. The pupa and pharate adult of *Aphrosylus* have in effect two quite different plastrons, that of the spiracular gills and that of the cocoon. *Aphrosylus* seems also to be pre-adapted to invade the intertidal region in quite another way. The air layer around the pupa functions as an osmotic barrier. In this connection it must be noted again not only that *Aphrosylus* is one of the most numerous genera of flies that have invaded the sea, but that the Dolichopodidae are also very successful invaders of saltmarshes and lagoons, perhaps pre-adapted to some extent by having an air layer around the pupa.

### 3.5.3 Canaceidae

About 40 species of Canaceidae are known. All appear to be intertidal except for two species of *Procanace* that have invaded freshwater streams, one in the Hawaiian Islands and the other in Java. All of the Hawaiian Islands originated in the Tertiary, chiefly during and since the Miocene. It therefore seems very probable that *Procanace* is not a primitive member of this family but a specialised

form that has secondarily invaded freshwater. In the almost exclusively intertidal Chironomidae of the sub-family Clunioninae there are five species of the genus *Telmatogeton* that have also invaded freshwater streams of the Hawaiian Islands (Wirth, 1951; Ch. 14 this volume).

The larvae of the *Canace* apparently feed chiefly upon algae. *Canace nasica* Haliday is very common around the English coast in growths of *Enteromorpha* on which it feeds.

The structure of the spiracular gills of *Canace nasica* has been described by Hinton (1967a), who for some inexplicable reason called them pupal gills. They are the first pair of thoracic spiracles of the larva. The larvae of the Canaceidae are plastron-breathers. The only other larvae known to have plastrons are beetles of the sub-order Myxophaga (Hinton, 1968a). As in all other Cyclorrhapha, pupation takes place within the hardened cuticle of the third instar larva. The respiratory structures of the third instar larva are used by the pupa and later by the pharate adult. Thus, there is plastron respiration in all of these stages. The spiracular gills of *Canace* are modifications of the spiracle itself as are those of some freshwater beetles, such as the Psephenidae. The only other known plastron-bearing spiracular gills in marine insects are those of the Tipulidae and Dolichopodidae, and these have been evolved from respiratory horns.

The general shape of the plastron-bearing spiracular gills of *Canace* is shown in Fig. 3.12(A and B). A section through the middle part of the spiracle is shown in Fig. 3.12C and one through the middle part of the gill in Fig. 3.13A. The transition between the structure of the basal part of the spiracle and the plastron-bearing apical part is abrupt. The cuticular wall, which is dorsally and laterally 10–20  $\mu\text{m}$  thick, becomes the plastron network which is only 0.3–0.5  $\mu\text{m}$  thick. The spiracular atrium extends to the apex of the gill. In the gill part of the spiracle the atrium extends around the dorsal and the lateral parts of the thickened ventral wall so that the latter is almost entirely enveloped by the atrium (Fig. 3.13A). The fine structure of the plastron, as deduced from electron micrographs, is shown in Fig. 3.13B.

Under high hydrostatic pressures the opposed walls of the atrium would tend to be pressed together because the very thin wall, i.e. the plastron network, outside the atrium and the dorsal and lateral sides of the gill has little rigidity. When the opposed walls of the atrium were forced together, it was found that a large volume of gas was nevertheless retained in the meshwork that lines the atrium. In order to crush the meshwork and force into solution the air that it normally contains, pressures of another order of magnitude are required. The function of the rather rigid meshwork that rises from the walls of the spiracular atrium thus seems clear enough.

Measurements for the resistance of the plastron to wetting under high hydrostatic pressures have been given by Hinton (1967a). When exposed to 1 atmosphere excess pressure for 3 hours the plastron was not damaged and in most



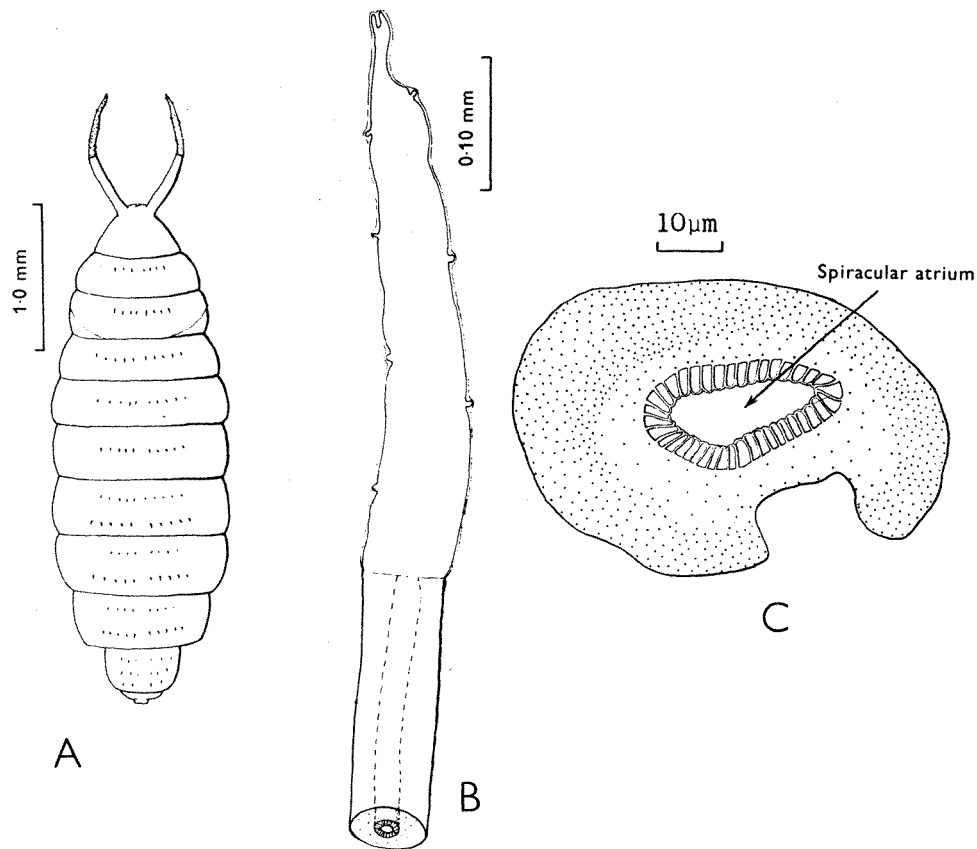

Fig. 3.12. *Canace nasica*. (A) Dorsal view of puparium. The area of the plastron is stippled. (B) Dorsal view of spiracular gill and part of the base of the spiracle. (C) Transverse section through the middle of the basal part of the spiracle (after Hinton, 1967a).

specimens the plastron was more or less intact after 9 hours at an excess pressure of 1 atm. After exposure to an excess pressure of 3 atm for 3 hours approximately 10% of the gills tested retained most or all of the plastron.

The total plastron area of both spiracular gills was calculated to be  $1 \times 10^5 \mu\text{m}^2$  or  $1.1 \times 10^5 \mu\text{m}^2$  per mg body weight of the pupa or pharate adult. The proportion of the total plastron area that forms the water–air interface will depend upon the precise manner in which the air is held in the plastron network, which in turn depends upon the geometry and contact angles of the network. It has been found that in other insects the water–air interface or effective area of the plastron may be equal to the total area of the plastron when allowance is made for the bulging of the menisci between the struts of the plastron network, or it may be as little as a third of the total plastron area. Even assuming that the effective plastron area is only a third of the total plastron area, the ratio in *Canace* works out as

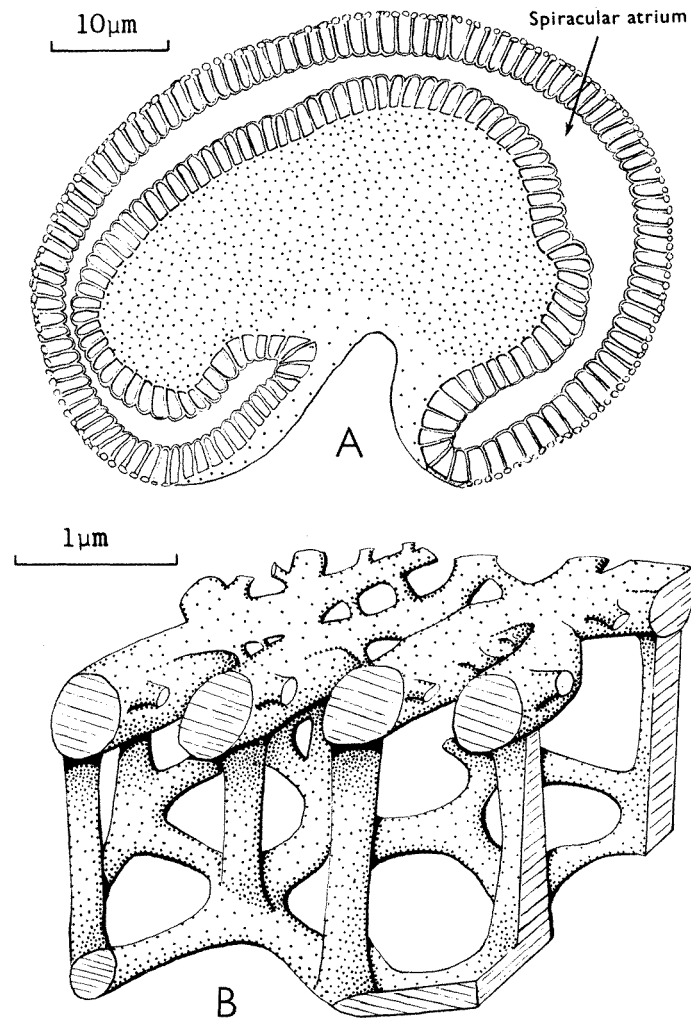

Fig. 3.13. *Canace nasica*. (A) Transverse section through the middle part of the spiracular gill. (B) Diagrammatic view of the outer wall or plastron network of the spiracular gill supported by the atrial meshwork (after Hinton, 1967a).

$3.9 \times 10^4 \mu\text{m}^2/\text{mg}$ . The ratios for other insects with plastron-bearing spiracular gills vary from  $1.5 \times 10^4$  to  $1.4 \times 10^6 \mu\text{m}^2$  per mg (Hinton, 1966c).

### 3.6 RESPIRATORY ADAPTATIONS OF MARINE PHTHIRAPTERA

In birds that occasionally dive below the surface, as well as in penguins, a layer of air is held against the body, and the lice that infest them do not necessarily

come into contact with the seawater. From the point of view of respiration they are no different from terrestrial insects. In some freshwater mammals, e.g. the water-vole, a layer of air held by the pelage is taken below the surface. It has been said that in some of the pinnipeds, e.g. the northern fur seal, *Callorhinus ursinus*, the underfur holds a layer of air. Lice in this air layer breathe like terrestrial insects. However, sucking lice of the genus *Antarctophthirus* live on the more exposed parts of their hosts – naked areas, eyelids, nostrils, auditory canals, umbilical area – and they are always in contact with the water when their hosts submerge. It is of great interest that only these lice have their bodies covered with scales that closely resemble the scale-like plastrons of certain freshwater weevils such as *Lissorhoptrus oryzophilus* Kuschel and others, as is evident from Fig. 3.14. It is also significant that it is the second and third larval instars and the adult that have the covering of scales. The first instar is like other lice and lacks scales. Its habits are also quite different: it remains in the air layer trapped in the pelage (Kim, 1971).

The species of *Antarctophthirus* live in an environment that might be expected to produce a plastron: it is alternately flooded and dry but when flooded the oxygen pressure in the water is relatively high. The scales of *A. ogmorhini* Enderlein are shown in Fig. 3.14A. This species lives on the exposed parts of the Weddell seal. This seal comes out on the ice regularly, and in summer often daily. When on ice in the sun the skin temperature of the whole body can rise to 32°C (Ch. 4).

Murray et al. (1965) are very emphatic that there is no plastron in *A. ogmorhini*. They say (p. 766)... ‘Occasionally air was trapped temporarily beneath the scales but it was not a regular occurrence, nor was the area of trapped air extensive, nor in direct communication with the tracheal system...’ Sometimes plastrons are particularly difficult to see, especially the scale-like ones. Furthermore, the so-called ‘macroplastron’, or a temporary air film, may exist over the ‘true’ plastron, i.e. the pressure-resistant plastron. While I believe that Murray et al. may be correct in saying that these lice are cutaneous breathers, nevertheless the possible respiratory function of the scales should be examined again, particularly in view of the statements by Ass (1934) about *Antarctophthirus trichechi* Boheman, ‘When a walrus . . . . . dives, a louse which has come into contact with air takes with it under the water surface a layer of air in the form of a bubble around its body, which is distributed non-uniformly over the dorsal and ventral sides. The supply of air is located between the body surface and the scales. . .’.

### 3.7 EGGS OF MARINE INSECTS

Very little is known about the structure of the eggshells of intertidal insects. I know of none that have a chorionic respiratory system. A chorionic respiratory system is absent in the Omaniidae and in *Aepophilus* among the Saldidae

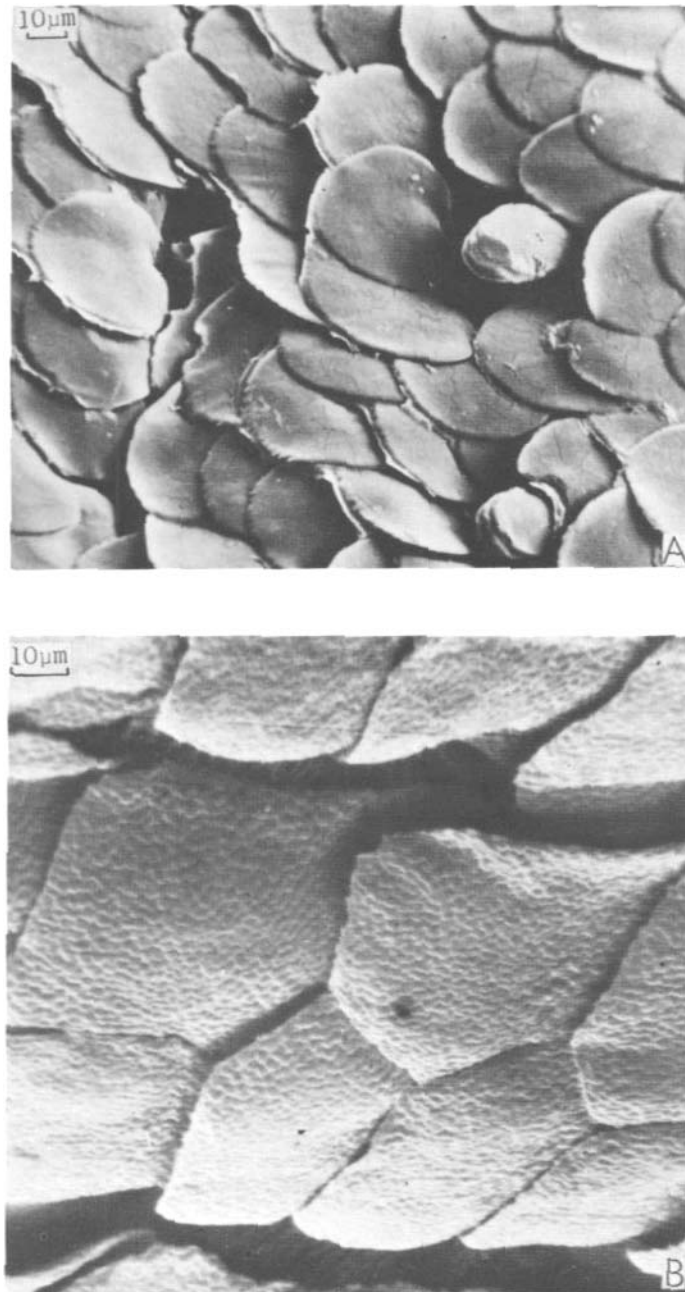

Fig. 3.14. Stereoscan electron micrographs of (A) scales on the dorsal part of the abdomen of the sucking louse, *Antarctophthirus ogmorhini*, of the Weddell seal, and (B) of the plastron scales of the freshwater weevil, *Endalus disgregus* (original).

(Cobben, 1970). Some of the Saldidae associated with freshwater have a distinct chorionic respiratory system and a few may have a plastron (Cobben, 1968). It seems likely that the eggs of at least some of the intertidal Saldidae may be similar. The eggs of the Chironomidae lack a chorionic respiratory system. I know nothing of the eggs of the intertidal Tipulidae and other intertidal Diptera. Among the Staphylinidae chorionic respiratory systems are known among the Staphylininae, which sometimes have plastrons, but not in the groups to which the marine forms belong. A number of *Culex* and *Anopheles* mosquitoes breed in tidal marshes and brackish coastal swamps. Species of *Culex* (Hinton, 1968b) and *Anopheles* (Hinton, 1968c) all have plastrons. Other information on the respiratory systems of insect eggs has recently been reviewed (Hinton, 1969a).

Although I am not here concerned with insects that live on the shore above high tide, it may be noted that most of the Diptera that lay in wrack beds, e.g. Coelopidae, Sphaeroceridae, Muscidae, have eggs with plastrons. The egg of one of the coleopids, *Orygma luctuosa* Meig. has a pair of plastron-bearing anterior horns (Hinton, 1961).

## REFERENCES

- Ass, M.Y. (1934) Towards the knowledge of ectoparasites of sea mammals. Anoplura of the walrus. Trudy Arkt. Antarkt. Nauchno-Issled. Inst. 9, 89–105 (translated by P.A. Kazakov).
- Brocher, F. (1912) Recherches sur la respiration des insectes aquatiques adultes. Les Haemonia. Ann. Biol. Lacust. 5, 5–26.
- Brockway, A.P. and Schneiderman, H.A. (1967) Strain-gauge transducer studies on intratracheal pressure and pupal length during discontinuous respiration in diapausing silkworm pupae. J. Insect Physiol. 13, 1413–1451.
- Buxton, P.A. (1926) On the colonization of the sea by insects: with an account of the habits of *Pontomyia*, the only known submarine insect. Proc. Zool. Soc. Lond. 1926, 807–814.
- Cobben, R.H. (1968) Evolutionary trends in Heteroptera. Part I. Eggs, architecture of the shell, gross embryology and eclosion. ( Document. )
- Cobben, R.H. (1970) Morphology and taxonomy of intertidal dwarfbugs (Heteroptera: Omaniidae fam. nov.). Tijd. Entomol. 113, 61–90.
- Comstock, J.H. (1887) Note on the respiration of aquatic bugs. Am. Nat. 21, 577–578.
- Dyte, C.E. (1959) Some interesting habitats of larval Dolichopodida (Diptera). Entomol. Mon. Mag. 95, 139–143.
- Ege, R. (1915) On the respiratory function of the air stores carried by some aquatic insects. Z. Allg. Physiol. 17, 81–124.
- Ege, R. (1923) Respirationsforholdene hos *Hydrocampa nymphaeta* (Larve og Puppe). Vidensk. Medd. dansk Foren. Kbh. 76, 29–42.
- English, K.M.I. (1949) Notes on the morphology and biology of a new species of *Tabanus* (Diptera, Tabanidae). Proc. Linn. Soc. N.S.W. 74, 153–160.
- Evans, P.D., Ruscoe, C.N.E. and Treherne, J.E. (1971) Observations on the biology and submergence behaviour of some littoral beetles. J. Mar. Biol. Assoc. U.K. 51, 375–386.
- Hinton, H.E. (1947) The gills of some aquatic beetle pupae (Coleoptera, Psephenidae). Proc. R. Entomol. Soc. Lond. (A) 22, 52–60.

- Hinton, H.E. (1953) Some adaptations of insects to environments that are alternately dry and flooded, with some notes on the habits of the Stratiomyidae. *Trans. Soc. Br. Entomol.* 11, 209–227.
- Hinton, H.E. (1957) The structure and function of the spiracular gill of the fly *Taphrophila vitripennis*. *Proc. R. Soc. Lond. (B)* 147, 90–120.
- Hinton, H.E. (1961) How some insects, especially the egg stages, avoid drowning when it rains. *Proc. S. Lond. Nat. Hist. Soc.* 1960, 138–154.
- Hinton, H.E. (1962) The structure and function of the spiracular gills of *Deuterophlebia* (Deuterophlebiidae) in relation to those of other Diptera. *Proc. Zool. Soc. Lond.* 138, 111–122.
- Hinton, H.E. (1965) The spiracular gill of the fly *Orimagula australiensis* and its relation to those of other insects. *Aust. J. Zool.* 13, 783–800.
- Hinton, H.E. (1966a) The spiracular gill of the fly, *Antocha bifida*, as seen with the scanning electron microscope. *Proc. R. Entomol. Soc. Lond. (A)* 41, 107–115.
- Hinton, H.E. (1966b) Respiratory adaptations of pupae of beetles of the family Psephenidae. *Phil. Trans. R. Soc. Lond. (B)* 251, 211–245.
- Hinton, H.E. (1966c) The spiracular gill of the fly *Eutanyderus* (Tanyderidae). *Aust. J. Zool.* 14, 365–369.
- Hinton, H.E. (1967a) Plastron respiration in the marine fly *Canace*. *J. Mar. Biol. Assoc. UK.* 47, 319–327.
- Hinton, H.E. (1967b) Structure of the plastron in *Lipsothrix*, and the polyphyletic origin of plastron respiration in Tipulidae. *Proc. R. Entomol. Soc. Lond. (A)* 42, 35–38.
- Hinton, H.E. (1967c) Spiracular gills in the marine fly *Aphrosylus* and their relation to the respiratory horns of other Dolichopodidae. *J. Mar. Biol. Assoc. UK.* 47, 485–497.
- Hinton, H.E. (1968a) Spiracular gills. *Adv. Insect Physiol.* 5, 65–162.
- Hinton, H.E. (1968b) Structure and protective devices of the egg of the mosquito *Culex pipiens*. *J. Insect Physiol.* 14, 145–161.
- Hinton, H.E. (1968c) Observations on the biology and taxonomy of the eggs of Anopheles mosquitoes. *Bull. Entomol. Res.* 57, 495–508.
- Hinton, H.E. (1969a) Respiratory systems of insect egg shells. *Annu. Rev. Entomol.* 14, 343–368.
- Hinton, H.E. (1969b) Plastron respiration in adult beetles of the suborder Myxophaga. *J. Zool., Lond.* 159, 131–137.
- Hinton, H.E. (1971) Reversible suspension of metabolism. *Proc. 2nd Int. Conf. Theoret. Phys. Biol., Versailles*, pp. 69–89.
- Kim, K.C. (1971) The sucking lice (Anoplura: Echinophthiriidae) of the northern fur seal; descriptions and morphological adaptations. *Ann. Entomol. Soc. Am.* 64, 280–292.
- King, P.E. and Ratcliffe, N.A. (1970) The surface structure of the cuticle of an intertidal hemipteran, *Aepophilus bonnairei* (Signoret). *Entomol. Mon. Mag.* 106, 1–2.
- Mackerras, I.M. (1950) Marine insects. *Proc. R. Soc. Queensld.* 61, 19–29.
- Masner, L. (1968) A new scelionid wasp from the intertidal zone of South Africa (Hymenoptera: Scelionidae). *Ann. Natal Mus.* 20, 195–198.
- Morton, J.E. (1954) The crevice faunas of the upper intertidal zone at Wembury. *J. Mar. Biol. Assoc. UK.* 33, 187–244.
- Murray, M.D., Smith, M.S.R. and Soucek, Z. (1965) Studies on the ectoparasites of seals and penguins. II. The ecology of the louse *Antarctophthirus ogmorhini* Enderlein on the Weddell seal, *Leptonychotes weddelli* Lesson. *Aust. J. Zool.* 13, 761–771.
- Poisson, R. (1932) Sur la biologie de *Geranomyia unicolor* Haliday. *Soc. Entomol. Fr., Paris Livre Centen.* 311–318.
- Rahn, R. and Paganelli, C.V. (1968) Gas exchange in gas gills of diving insects. *Resp. Physiol.* 5, 145–164.
- Saunders, L.G. (1928) Some marine insects of the Pacific Coast of Canada. *Ann. Entomol. Soc. Am.* 21, 521–545.

- Saunders, L.G. (1930) The early stages of *Geranomyia unicolor* Haliday, a marine tipulid. Entomol. Mon. Mag. 66, 185–187.
- Selman, B.J. (1960) On the tissue isolated in some of the larval appendages of *Sialis lutaria* L. at the larval-pupal moult. J. Insect Physiol. 4, 235–257.
- Seurat, L.G. (1924) Moeurs et evolution d'un Tipulide à larve et nymphe marines. Bull. Soc. Hist. Nat. Afr. N. 15, 113–121.
- Smith, M.E. (1952) Immature stages of the marine fly, *Hypocharassus pruinosis* Wh., with a review of the biology of immature Dolichopodidae. Am. Midl. Nat. 48, 421–432.
- Thorpe, W.H. (1950) Plastron respiration in aquatic insects. Biol. Rev. 25, 344–390.
- Tokunaga, M. (1930) The morphological and biological studies on a new marine crane-fly, *Limonia (Dicranomyia) monostromia*, from Japan. Mem. Coll. Agric. Kyoto Imp. Univ. 10, 1–93.
- Tokunaga, M. (1933) A marine crane-fly, *Limonia (Dicranomyia) trifilamentosa*, of the Pacific Coast of Japan, with special reference to the ecology and morphology of its immature stages. Philipp. J. Sci. 50, 327–344.
- Tokunaga, M. (1939) Female and larva of the marine crane-fly, *Limonia (Idioglochina) gloriosa* Tokunaga. Annot. Zool. Jap. 18, 101–104.
- Wigglesworth, V.B. (1972) The Principles of Insect Physiology. 7th edn (, ).
- Wirth, W.W. (1951) A revision of the dipterous family Canaceidae. Occ. Pap. Bernice P. Bishop Mus. 20, 245–275.

# Insect parasites of marine birds and mammals

M.D. Murray

<b>Contents</b>		
4.1	Introduction	79
4.2	Permanent ectoparasites	80
4.3	Mallophaga	80
4.4	Anoplura – Key to genera of Echinophthiriidae	84
	4.4.1 General biology of Anoplura	85
	4.4.2 Infestations of seals with Anoplura	87
4.5	Distribution and abundance of lice on other seals	92
4.6	Adaptations of Anoplura to the marine environment	93
	Acknowledgements	95
	References	95

## 4.1 INTRODUCTION

Many insects are closely associated with and dependent on birds and mammals for their survival. The association may be temporary, usually to obtain food, or permanent, in that their whole life is spent on the avian or mammalian host, with the resultant evolutionary problems inherent to island populations.

The marine birds with which insects are associated range from the familiar gulls of the shore, to the diving feeders such as the auks, murre, cormorants, terns and gannets, to the oceanic shearwaters, petrels and albatrosses which feed from the surfaces of the sea. In common with most land birds, they have the ability to fly. They are marine in that they have evolved the ability to feed from the sea during dives of short duration or by scavenging from the surface, and the ability to rest by floating on the surface of the water. The penguins, however,



may be considered to be truly marine for they have lost the power of flight, swimming mostly beneath the surface to travel and feed.

Many marine mammals, e.g., the whales, dolphins and dugongs live within oceanic, coastal or estuarine waters throughout the whole of their lives. Seals spend much if not most of their lives in the sea but must come ashore to give birth to their young. The ectoparasites of whales are not of terrestrial origin – they are similar to the parasitic crustaceans on fishes; those of birds or mammals that come ashore regularly are acarines or insects.

Marine birds and all marine mammals except whales, dolphins and dugongs, breed in a terrestrial environment, whether it be on a mountain, a headland, an island or floating ice. Regardless of the ability of birds to range widely around the tropics (e.g. bridled terns and sooty terns) from the subarctic to subantarctic (e.g. shearwaters), or circumpolar (e.g. giant petrels and albatrosses in the southern hemisphere), they all return to the same locality or colony to breed and nest. Awaiting their return are their temporary ectoparasites, the fleas and ticks whose life cycles have evolved to survive the adverse conditions when food is unavailable, and to complete the other phases of their life cycles rapidly while their hosts are present (Murray et al., 1967; Murray and Vestjens, 1967).

#### 4.2 PERMANENT ECTOPARASITES

The marine ectoparasites are among those that live permanently on their hosts. There are a multitude of mites that infest the skin and pelage, particularly feathers, and about which little is known except for those of economic importance to man and his livestock. The mites of the pelages of birds and mammals are at present a rapidly expanding taxonomic frontier awaiting biological understanding. The insects fall into the order Phthiraptera, collectively known as lice, the specific status of whose members remains relatively constant but the generic and familial relationships can change with bewildering rapidity. Lice are wingless, dorsoventrally flattened exopterygote insects with mandibulate or sucking and piercing mouthparts. Those found on marine birds and mammals belong to the suborders Mallophaga and Anoplura. A list of species of Anoplura found on seals is given in Table 4.1. A list of genera of Mallophaga found on oceanic birds is given in Table 4.2.

#### 4.3 MALLOPHAGA

The Mallophaga, or biting lice have mandibulate mouthparts and comprise two distinct divisions, Amblycera and Ischnocera. Amblyceran lice probably cannot survive entirely on a diet of feathers or mammalian skin scurf. They are known to

Table 4.1 Species of Anoplura found on seals (after Kim et al. 1975; Murray, unpublished data).

Mammalia	Anoplura
Pinnipedia	
Otariidae	
Arctocephalinae	
<i>Callorhinus ursinus</i>	<i>Antarctophthirus callorhini</i> (Osborn)
	<i>Proechinophthirus fluctus</i> (Ferris)
<i>Arctocephalus pusillus</i>	( <i>A. callorhini</i> , ?)
	<i>P. zumpti</i> (Werneck)
<i>Arctocephalus doriferus</i>	<i>A. microchir</i> (Trouessart and Neumann)
<i>Arctocephalus forsteri</i>	<i>A. microchir</i>
Otariinae	
<i>Eumetopias jubatus</i>	<i>A. microchir</i>
<i>Otaria bryonia</i>	<i>A. microchir</i>
<i>Zalophus californianus</i>	<i>A. microchir</i>
<i>Neophoca cinerea</i>	<i>A. microchir</i>
<i>Phocarcos hookeri</i>	<i>A. microchir</i>
Odobenidae	
<i>Odobenus rosmarus</i>	<i>A. trichechi</i> (Bohemann)
Phocidae	
Monachinae	
<i>Monachus monachus</i>	<i>Lepidophthirus piriformis</i> Blagoveschensky
<i>Mirounga leonina</i>	<i>L. macrorhini</i> Enderlein
<i>Hydrurga leptonyx</i>	<i>A. ogmorhini</i> Enderlein
<i>Leptonychotes weddelli</i>	<i>A. ogmorhini</i>
<i>Lobodon carcinophagus</i>	<i>A. lobodontis</i> Enderlein
<i>Ommatophoca rossi</i>	<i>A. mawsoni</i> Harrison
Phocinae	
<i>Cystophora cristata</i>	<i>Echinophthirus horridus</i> (von Olfers)
<i>Erignathus barbatus</i>	<i>E. horridus</i>
<i>Halichoerus grypus</i>	<i>E. horridus</i>
<i>Pagophilus groenlandicus</i>	<i>E. horridus</i>
<i>Phoca vitulina</i>	<i>E. horridus</i>
<i>Pusa hispida</i>	<i>E. horridus</i>
<i>Pusa sibirica</i>	<i>E. horridus</i>

feed on blood of various hosts; e.g. *Piagetiella* sp. (Menoponidae) feeds on the interior lining of the bill pouches of pelicans (Dubinin, 1947). Others prey on eggs and moulting nymphs of their own or other species (Nelson and Murray, 1971; Nelson, 1971). Ischnoceran lice, however, can survive solely on feathers and scurf. There are likely to be fundamental differences in the physiology of these two divisions of the Mallophaga. Some studies on water metabolism have been made by Williams (1971).

Mallophaga are absent from marine mammals but are rather common on

Table 4.2 The genera of Mallophaga found on oceanic birds.

	AVES	MALLOPHAGA	
		Amblycera	Ischnocera
SPHENISCIFORMES			
Spheniscidae (Penguins)	<i>Aptenodytes, Eudyptes, Eudyptula, Megadyptes, Pygoscelis, Spheniscus</i>		<i>Austrogoniodes, Nesiotinus</i>
PROCELLARIIFORMES			
Diomedidae (Albatrosses)	<i>Diomedea, Phoebastria</i>	<i>Austromenopon</i>	<i>Docophoroides, Episbates, Harrisoniella, Naubates, Paraclisis, Perineus</i>
Procellariidae (Petrels, Shearwaters, Fulmars)	<i>Adamastor, Bulweria,</i>	<i>Ancistrona,</i>	<i>Bedfordiella, Docophoroides</i>
	<i>Daption, Fulmarus, Halobaena, Macronectes, Pachyptila, Pagodroma, Procellaria, Pterodroma, Puffinus, Thalassoica</i>	<i>Austromenopon, Longimenopon,</i>	<i>Halipeurus, Harrisoniella, Naubates, Paraclisis, Perineus, Pseudonirmus Saemundssonina, Trabeculus</i>
Hydrobatidae (Storm-petrels)	<i>Fregetta, Garrodia, Halocyptena, Hydrobates, Loomelania, Nesofregetta, Oceanodroma, Oceanites, Pelagodroma</i>	<i>Ancistrona, Austromenopon, Longimenopon</i>	<i>Halipeurus, Philoceanus, Saemundssonina</i>
Pelecanoididae (Diving-petrels)	<i>Pelecanoides</i>	<i>Austromenopon</i>	<i>Halipeurus, Pelmatocerandra</i>
PELECANIFORMES			
Phaethontidae (Tropic-birds)	<i>Phaethon</i>	<i>Austromenopon</i>	<i>Saemundssonina</i>

Pelecanidae (Pelicans)	<i>Pelecanus</i>	<i>Colpocephalum,</i> <i>Piagetiella</i>	<i>Pectinopygus</i>
Sulidae (Gannets)	<i>Morus, Sula</i>	<i>Eidmanniella</i>	<i>Pectinopygus</i>
Phalacrocoracidae (Cormorants or Shags)	<i>Haliastur, Nannopterum,</i>  <i>Phalacrocorax</i>	<i>Eidmanniella,</i>  <i>Piagetiella</i>	<i>Pectinopygus</i>
Fregatidae (Frigate birds)	<i>Fregata</i>	<i>Colpocephalum,</i> <i>Fregatiella</i>	<i>Pectinopygus</i>
CHARADRIIFORMES			
Phalaropodidae (Phalaropes)	<i>Lobipes, Phalaropus,</i> <i>Steganopus</i>	<i>Actornithophilus</i> <i>Austromenopon</i>	<i>Quadriceps, Saemundssonina</i>
Stercorariidae (Skuas, Jaegers)	<i>Catharacta, Stercorarius</i>	<i>Austromenopon</i>	<i>Haffneria,</i>  <i>Harrisoniella, Quadriceps,</i> <i>Saemundssonina</i>
Laridae (Gulls)	<i>Larus, Pagophila,</i> <i>Rhodostethia, Rissa, Xema</i>	<i>Actornithophilus,</i> <i>Austromenopon,</i> <i>Colpocephalum</i>	<i>Quadriceps, Saemundssonina</i>
Sternidae (Terns, Noddies)	<i>Anous, Chlidonias,</i> <i>Gelochelidon,</i> <i>Gygis, Hydroprogne,</i> <i>Larosterna,</i> <i>Phaetusa, Procelsterna</i>	<i>Actornithophilus,</i>  <i>Austromenopon</i>	<i>Quadriceps, Saemundssonina</i>
Rynchopidae (Skimmers)	<i>Rynchops</i>		<i>Quadriceps, Saemundssonina</i>
Alcidae (Auks, Guillemots, Puffins)	<i>Aethia, Alca, Alle,</i> <i>Brachyramphus,</i> <i>Cepphus, Cerorhinca,</i> <i>Cyclorhynchus, Fratercula,</i> <i>Lunda,</i> <i>Ptychoramphus,</i> <i>Synthliboramphus, Uria</i>	<i>Austromenopon</i>	<i>Craspedonirmus,</i>  <i>Quadriceps, Saemundssonina</i>

---

penguins. Only ischnoceran lice have been found on these seabirds, living in the feather coat. The feathers on a penguin are water repellent and encase around the body a blanket of air to prevent heat loss. Stout feathers within the plumage maintain the general conformation of the coat both in the water and on land where they prevent the wind from disrupting this air layer. Muscles attached to the feather follicles in the skin enable the coat thickness to be increased or decreased to aid in thermal conservation or dissipation. The feather coat of a penguin also enables the bird to withstand the buffeting they suffer when thrown on to the rocks as they come ashore in rough seas. A penguin is thus always surrounded by air, and consequently its lice always live in a terrestrial environment. *Austrogoniodes waterstoni* (Cummings), the louse of the little penguin *Eudyptula minor*, which is found around the southern coast of Australia, can be reared in the laboratory on down feathers. It is drowned when placed in sea-water for 24 hours, requires temperatures over 25°C for oviposition and egg development, and is thus similar to other mallophagan lice that have been studied (Murray, 1964, and unpublished). There is no reason to doubt that other penguin lice are different. Since they are never exposed to seawater, their life is essentially terrestrial and they do not need special adaptation for a marine existence.

#### 4.4 ANOPLURA

The Anoplura or sucking lice, feed by sucking blood directly from the capillaries within the skin of their host (Lavoipierre, 1967), and are only found on mammals.

The sucking lice found on most species of seals fall into a distinctive family – the Echinophthiriidae. Until recently these lice had only been found on seals, but Kim and Emerson (1974) described a species from the River Otter. They have also given a description of the family and the following key to the genera.

The echinophthirid lice are fairly large. The body is thickly covered with various setae, scales and pegs. There are no external eyes. The antennae can be 3-, 4- or 5-segmented. The mid- and hindlegs are large and similar in size and shape, with blunt claws and elaborate tibial thumb. The forelegs are usually small and slender, with acuminate claw. The abdomen is completely membranous or leathery, with no sclerotized plates. The spiracles are small and of a distinctive type, each with a long, slender atrial chamber and a long chitinous rod.

#### KEY TO GENERA OF ECHINOPHTHIRIIDAE

- |    |   |  |   |
|----|---|--|---|
| 1. | Antennae 3-segmented; on <i>Lutra</i> (river otter)                                   | <i>Latagophthirus</i> Kim & Emerson      |   |
|    | Antennae 4- or 5-segmented; on <i>Pinnipedia</i> (marine carnivores)                  |  | 2 |
| 2. | Forelegs small and slender, with acuminate claw, completely different from other legs |  | 3 |
|    | Legs all of same size and shape, with stout claw; on phocine Phocidae (various seals) | <i>Echinophthirus</i> Giebel (Fig. 4.3a) |   |

- |    |  |  |
|----|--|--|
| 3. | Abdomen without scales; ♀ with genital setae horizontally arranged; ♂ pseudopenis U-shaped; antennae 4-segmented; on <i>Callorhinus</i> , <i>Arctocephalus</i> (fur seals) and occasionally <i>Eumetopias</i> (sea lions)  | <i>Proechinophthirus</i> Ewinb (Fig. 4.3c)           |
|    | Abdomen with scales and pegs in addition to regular setae; ♂ pseudopenis V-shaped or not fused apically  | 4  |
| 4. | Body moderately slender; head longer than wide; adult antennae 5-segmented; thorax narrowly connected to abdomen; ♀ with patches of genital setae convergently arranged; ♀ pseudopenis V-shaped; on a wide range of Pinnipedia   | <i>Antarctophthirus</i> Enderlein (Fig. 4.3b)        |
|    | Body wide and compact; head wider than long; adult antennae 4-segmented; thorax broadly connected to abdomen; ♀ with patches of genital setae divergently arranged; ♂ pseudopenis not fused apically; on <i>Mirounga</i> (elephant seals) and <i>Monachus</i> (monk seals) | <i>Lepidophthirus</i> Enderlein (Figs. 4.3d and 4.5) |

#### 4.4.1 General biology of Anoplura

The life cycle of an anopluran louse comprises an egg, three nymphal instars, and adult males or females. The eggs are attached to the hair near to the skin by a cement so that the operculum, which the nymph forces open to emerge, is directed away from the skin (Fig. 4.1). The alignment of the eggs along the hair and their

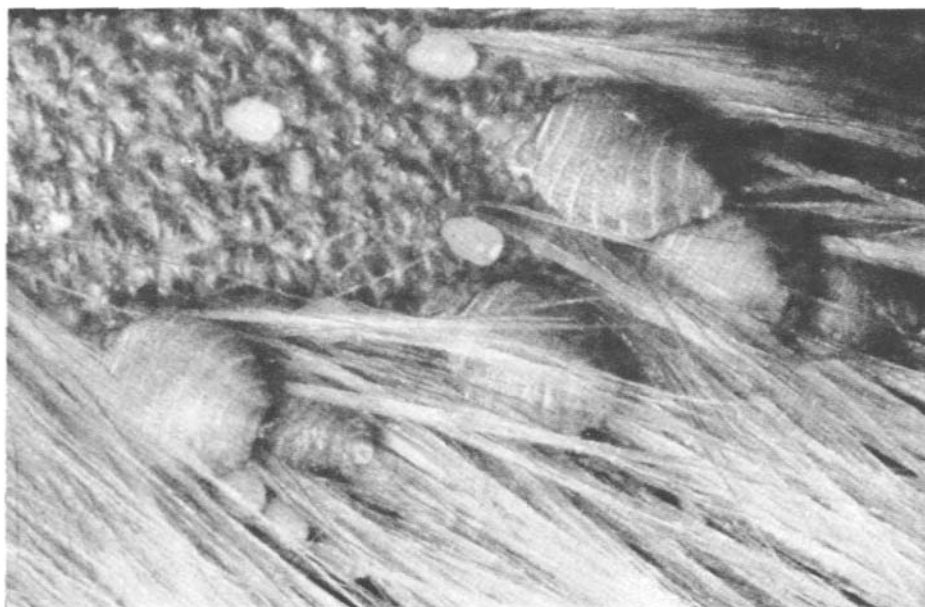

Fig. 4.1. *A. ogmorhini* on the skin of the Weddell seal. The hair coat of the Weddell seal consists of groups of hairs comprising a guard hair with several undercoat hairs, all of which emerge from a single orifice at the base of a depression in the skin. The lice lie close to the surface of the skin with their heads within the skin depressions. Eggs are attached to the hair groups singly and close to the skin. The hair has been removed from the upper left portion of this preserved specimen to show the uneven surface of the skin, and to reveal the eggs and lice. The four largest lice are females, the other two are males. (Photograph by I. Roper)

distribution along the hair is determined by the oviposition behaviour of the female. In the initial phases they are attracted to warmth which usually leads them to the skin of their host. There they remain for periods up to an hour, and if the temperatures are suitable this innate behaviour continues. Suddenly, the louse turns about, orients itself to the temperature gradient, grasps a hair in its ovipods, and rubs its abdomen up and down the hair. This tactile stimulus causes the excretion of the cement which commences to set within a few seconds, and the egg is expelled, assisted by the louse walking along the hair away from the skin. Eggs are laid singly, and the complete behaviour pattern is repeated between the laying of each egg (Murray, 1957a,b, 1960, 1963).

The egg-laying behaviour is influenced by two critical factors: the temperature must be within a certain range, usually over 25°C for the behaviour to continue after the initial attraction to warmth; a hair or any fibre of suitable diameter must be present to supply the tactile stimulus that initiates the excretion of the cement and the subsequent expulsion of the egg. Anoplura do not oviposit when immersed in water.

There are two distinct physiological phases in the development of the egg – morphogenesis and hatching – and the microclimatic requirements for each phase are not necessarily the same. Anopluran eggs often develop in a rather restricted range of constant temperatures, usually between 30–40°C. There is no evidence of an ability to withstand for prolonged periods temperatures cooler than those in the range within which they develop, and higher temperatures become rapidly lethal. They can develop within a wide range of relative humidities, often from 9–100%. However, at hatching, relative humidities higher than 92% can be lethal and the embryo fails to emerge (Murray, 1963).

The physical requirements for oviposition and egg development of Anoplura largely determine the distribution of those areas upon a mammal which are suitable for breeding. These factors vary in space and time on their hosts, being closely associated with the thermoregulatory mechanisms evolved by the various mammals to survive in their own environments.

Survival of the nymphs and adults may depend on their abilities to escape the grooming activities of their host, to avoid areas in the pelage with lethal high temperatures caused by solar radiation, or to survive low temperatures for prolonged periods of up to several days, as shown by the louse of the southern elephant seal (Fig. 4.2). Most have the ability to feed quickly when the capillaries in the skin are dilated and food is available.

The size of populations of Anoplura on mammals may remain fairly constant, or vary dramatically with season, being low in the summer and increasing in abundance towards the end of the winter (Murray, 1965). The blood sucking behaviour of Anoplura undoubtedly enables them to increase egg production, for no mallophagan louse is known to be able to lay more than one or two eggs daily. However, blood feeding necessitates the injection of salivary secretions into

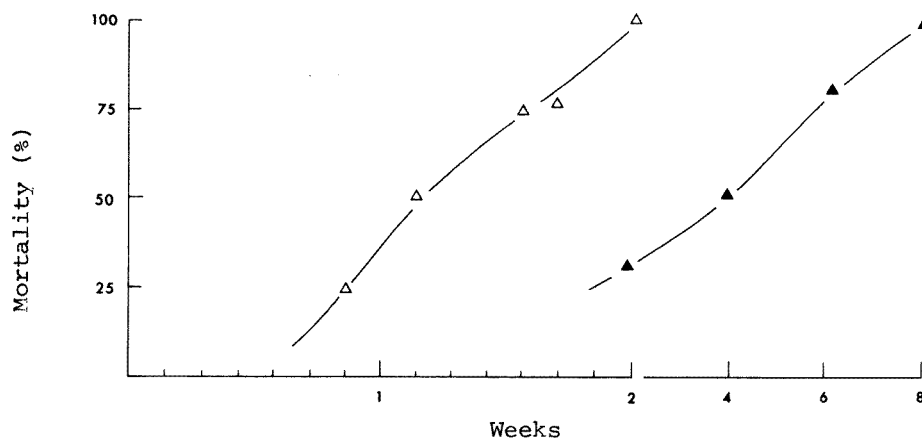

Fig. 4.2. Mortality off host, in water or moist air. *A. ogmorhini* (Δ) (Weddell seal) at 6°C; *L. macrorhini* (▲) (southern elephant seal) at 5–10°C (after Murray and Nicholls, 1965; Murray et al., 1965).

the host, and these antigens stimulate local immune responses. One consequence of this may be to cause capillary contraction (Nelson et al., 1972) which may deprive the lice of food and thus affect their ability to multiply.

Transfer of lice usually occurs from the lactating mother to her offspring, but the stages of the life cycle that transfer differ between species. Thus it is the nymphs of *Antarctophthirus callorhini* and the adults of *Proechinophthirus fluctus* that transfer from the mother northern fur seal to her pup (Kim, 1975).

#### 4.4.2 Infestations of seals with Anoplura

Seals are of two types, the fur seals and the hair seals. Fur seals retain an air-blanket in their fur to insulate them at sea, whereas water permeates through the hair to the skin of hair seals, which depend on blubber to insulate the body core. The lice on a hair seal are immersed in water whenever the seal goes to sea and thus lead a truly marine existence. The biological studies on these species are limited except for the infestations of the southern elephant seal, *Mirounga leonina* by *Lepidophthirus macrorhini* (Murray and Nicholls, 1965). A detailed discussion of this host–parasite relationship is presented here.

The southern elephant seal comes ashore only twice a year for 4–5 weeks, yet most are infested with lice, particularly pups before they go to sea. Breeding cows join the harems about the last week of August, coming ashore about five days before pupping, and remain for about 23 days afterwards until the pups are weaned. The pups are about three weeks old when weaned and fast for the subsequent 5–6 weeks when they learn how to swim prior to leaving the island. This system is particularly suited for experimental studies as the louse responds well



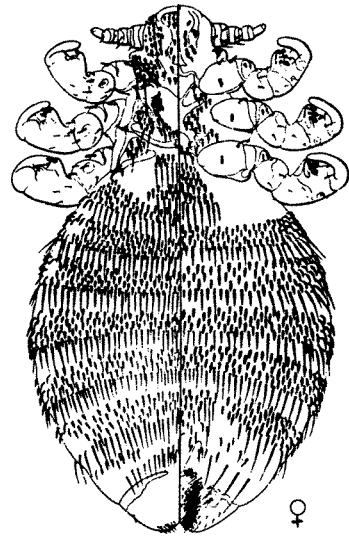

Echinophthirus horridus

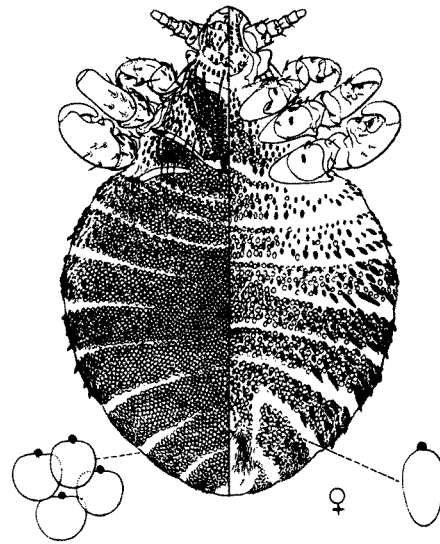

Antarctophthirus ogmorhini

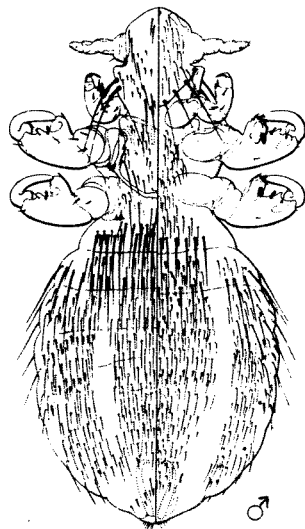

Proechinophthirus fluctus

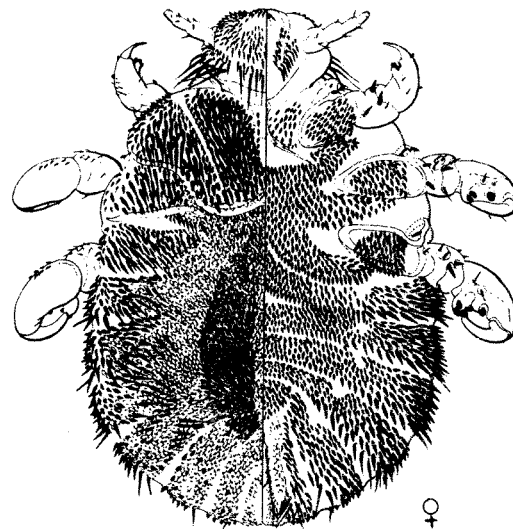

Lepidophthirus macrorhini

Fig. 4.3. The genera of lice of the family Echinophthiriidae found on seals; dorsal aspect on left, ventral on right; not to scale (from Ferris, 1951, pages 74, 76, 79 and 82).



Fig. 4.4. Examination of the hind flipper of a female elephant seal. It is frequently possible to examine a hind flipper thoroughly for lice provided it is done quietly and slowly. (A.N.A.R.E. photograph by J. Ling.)

and the host is easy to handle during the experiments. A host that also does not require to be fed for a few weeks and can be strapped to a laboratory bench is unique (Fig. 4.4) and warrants a long voyage and a little discomfort to study.

The body of these seals is covered with scale-like hair which is sparser on the flippers (Fig. 4.6). Insulation is provided by a blubber beneath the skin. On Macquarie Island the air temperature is usually 0–8°C, and the skin temperature of an elephant seal when the air temperature is 8°C may be 30–33°C on the body

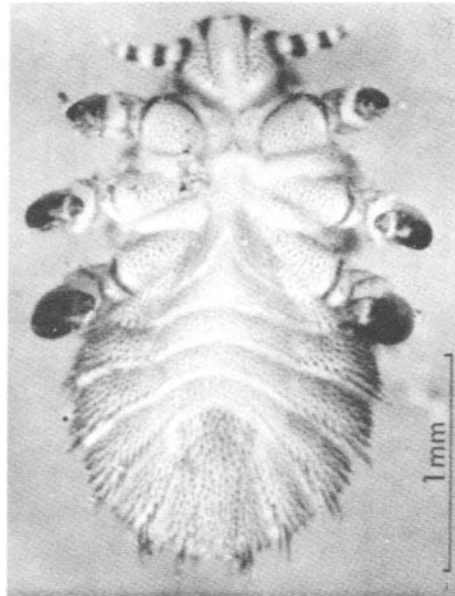

Fig. 4.5. Ventral aspect of male *L. macrorhini*. The abdomen is covered with many stout spines, and the intersegmental regions of the thorax and abdomen are more invaginated than in lice from terrestrial mammals. (Photograph by I. Roper.)

or 24–34°C on the flippers. When the air temperature is 1.8°C the skin temperature of the body can be 1–6°C and that of the flippers 29–32°C. In the sea when the temperature is 8°C the skin temperature virtually drops to sea temperature.

The blubber distribution and thickness usually enables the seal to conserve heat when in the sea and to retain normal metabolic rate when it is inactive (Bryden, 1964). The blood circulation to the skin is reduced and temperature gradients are established through the blubber to the body core. When necessary, heat is dissipated through the flippers, which lack insulation. On land, seals are often under heat stress and additional heat is dissipated through the whole surface area of the skin, often assisted by throwing damp sand onto the body or fanning the flippers.

The distribution of the louse *L. macrorhini* closely follows the areas of the skin used regularly for heat dissipation. They are found in greatest densities on the hind flippers where the skin temperature is more frequently warm and within a favourable range for multiplication for prolonged periods. An increase in skin temperature is due to an increase in the flow of blood through the skin capillaries, and thus food is available more regularly. *L. macrorhini* lives in a habitat that changes abruptly from terrestrial to marine, from warm to cold, from abundance of food to absence. The louse has evolved the ability to multiply rapidly whenever the seal is ashore, and to feed whenever possible when the seal is at sea (Fig. 4.6). *L. macrorhini* is inactive at 0–10°C and active from 20–30°C in air but less active when submerged in sea-water. It can engorge with blood within five minutes, and will feed when submerged in water if the skin temperature is sufficiently warm. The females lay 6–9 eggs a day at 25–35°C but none at 6°C in air; no eggs are laid when the lice are submerged in water at 15, 20 or 25°C. Eggs kept at 25–35°C in air hatch within 5–10 days but none hatch at 6°C; no eggs survive immersion in sea-water at 6°C for three weeks. The life cycle, therefore, can only be completed on flippers in air, and takes about 21 days when flippers are kept at 25–35°C. The percentage survival of lice kept at 5–10°C immersed in sea-water or left in air at 100% R.H. are similar (Fig. 4.2). Food is the limiting factor, not availability of oxygen. At these temperatures the lice are inactive and their oxygen consumption is low but they are not in a state of suspended animation.

At temperatures of 25–35°C adult lice are active and disperse rapidly from mother to pup. Since pups remain ashore for about 8 weeks before they go to sea, there is sufficient time for the completion of two generations. This well compensates for any losses when the pups moult, and ensures there are sufficient numbers of nymphs and adults on the hind flippers to survive the losses at sea to repopulate the flippers when the seal returns to land. This basic cycle is repeated annually. The older breeding cows moult in mud wallows where little multiplication of *L. macrorhini* can occur as they are submerged in water. However, by this time their lice have infested their offspring, so the declining populations on the older seals are of no consequence to the survival of the louse population.

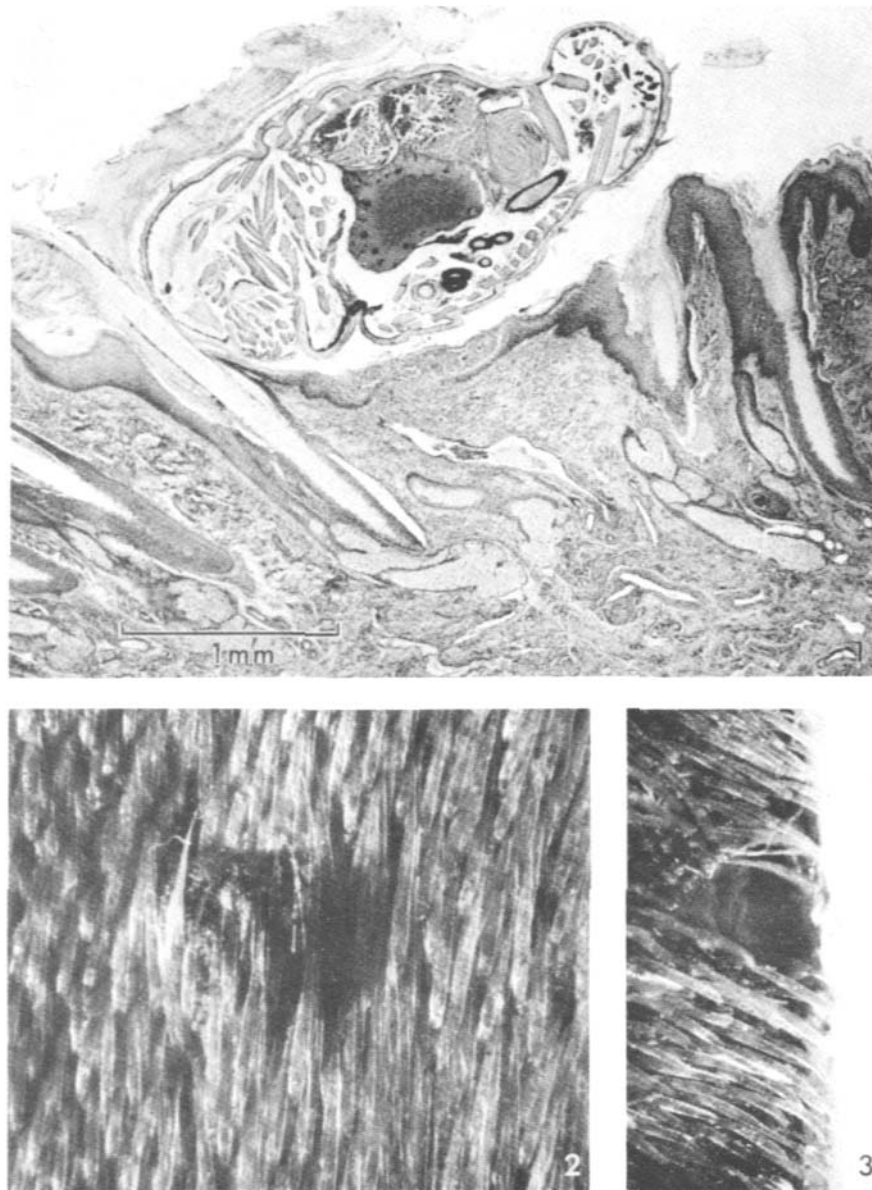

Fig. 4.6. (1) Longitudinal section of *L. macrorhini* nymph in burrow in stratum corneum of the skin of an elephant seal. At the moult the stratum corneum and hair are shed attached together, and this removes the roof of the burrow. An inflammatory reaction to the louse is present. The stomach of the louse is not large, and is full of blood undergoing digestion. (Photograph by I. Roper.) (2) *L. macrorhini* adult on the skin of an elephant seal. The posterior tip of the louse is visible, and the disarranged seal hair indicates a large louse. (Photograph by I. Roper.) (3) Burrow of *L. macrorhini* in skin of the edge of a hind flipper. An adult louse has been removed to show the extent of a burrow. (Photograph by I. Roper.)

#### 4.5 DISTRIBUTION AND ABUNDANCE OF LICE ON OTHER SEALS

The Weddell seal, *Leptonychotes weddelli*, lives around the antarctic continent where it hauls out onto the ice regularly when the sea ice is broken in the summer, but can remain submerged throughout the winter, obtaining air from the holes that it maintains through the ice. Its louse, *Antarctophthirus ogmorhini* Enderlein, is again restricted to those areas used in heat dissipation, the flippers, ankle, hip, tail and the genital and anal orifices. When Weddell seals were removed from Antarctica to the New York Aquarium, Coney Island, where the water was kept at 14°C, lice spread over the whole body. Major biological differences between *A. ogmorhini* and *L. macrorhini* are that it is active at lower temperatures, 6–10°C, it can oviposit at 10–12°C and eggs will develop and hatch at 5–10°C. However, like *L. macrorhini*, they must feed regularly and they die at the same rate at 6°C whether they are in air or water (Fig. 4.2). Population numbers are again determined by the behaviour of the seal, and its social position in its population. Pups, immature and female Weddell seals are lousiest, these animals spend more time on the ice than do the dominant males (Murray et al., 1965).

The distribution of *Antarctophthirus lobodontis* Enderlein on the crabeater seal, *Lobodon carcinophagus*, is similar. All these areas supply more opportunities to feed fulfilling the nutritional demands of rapid multiplication when the seal is ashore, and survival when the seal is at sea.

The northern fur seal, *Callorhinus ursinus*, is infested with two species of lice, *Antarctophthirus callorhini* (Osborn) and *Proechinophthirus fluctus* (Ferris). Infestations of these seals have been studied by Dubinin (1955) and more recently by Kim (1971, 1972, 1975). *P. fluctus* infests the fur pelage, particularly on the neck, belly and hip. It lives in an airblanket and is not exposed to a marine environment. It lacks the modified setae and spiracles of the lice of hair seals. *A. callorhini* is found on the naked parts of the body or those only covered with hair, such as the nostrils, the auditory canal, the eyelids, the penial orifice of males and the umbellicus of pups (Fig. 4.7).

Both species transfer rapidly from the mothers to their pups, and heavy infestations may develop on pups before their first moult. Most northern fur seals (91 %) are infested with lice, and surprisingly heavy infestations have been found on pelagic seals off the western coast of the USA in the spring before they return to breed on islands in the Bering Sea. These populations are comprised mainly of nymphs, and it appears that *P. fluctus* can complete a generation while the fur seal is at sea (Kim, 1975). Both of these lice can lay 8–10 eggs a day, and the generation time of *A. callorhini* is a little over 20 days. It would appear that their reproduction potentials may be similar to *L. macrorhini* and *A. ogmorhini*, although the causes of their mortalities could be quite different. The restricted distribution of *A. callorhini* is particularly interesting because of the densities of the populations that may be found (Fig. 4.7). In such situations of high densities of lice on a restricted



Fig. 4.7. Cluster of *A. callorhini* around the umbilicus of the northern fur seal. (Photograph by V.B. Scheffer.)

area, an immune response by the host may well play a role in population regulation, especially if the louse is unable to disperse laterally. Dubinin (1955) considered this to be the explanation for the cessation of multiplication of *A. callorhini* around the orifices of pups when they were 6–8 weeks old. A critical appraisal of such phenomena in the regulation of natural populations of lice awaits study.

#### 4.6 ADAPTATIONS OF ANOPLURA TO THE MARINE ENVIRONMENT

Many of the adaptations described are extensions of those known for lice on terrestrial mammals. *A. ogmorhini* can survive 12 days at 6°C at 100% R.H., and *L. macrorhini* 6–8 weeks at 5–10°C (Fig. 4.2). *A. ogmorhini* can apparently survive supercooling for they are unharmed by an exposure to -20°C for 36 hours (Murray et al., 1965). In their ability to survive prolonged immersion in water, seal lice do differ from others, but when they are submerged naturally they are at sea temperature for most of the time and this may not impose much of a problem, certainly in high latitudes where the temperatures of the oceans range from 8 to -2°C and the little oxygen required could be absorbed directly through the cuticle. This may account for the deep invaginations between the abdominal segments, which greatly increase the surface area of the cuticle.

Seals do not feed on the surface of the ocean, they dive for food. The Weddell seal has been recorded to dive to 600 m (Kooyman, 1966) during a dive of 45 minutes,

and the harbour seal, *Phoca vitulina*, has been recorded diving to 90 m in a 28-minute dive (Harrison and Tomlinson, 1960). The well-developed musculature and valve for closing the atrium of the lice is probably an adaptation to prevent water being forced into the spiracles when the host dives. The abdominal invaginations may permit the body to be compressed.

It has been postulated that the abdominal scales of the lice function as a plastron, as the structure is similar to those found on other insects (Figs 4.8 and 3.14A) (see Hinton, Chapter 3, p. 74). Ass (1934) states that

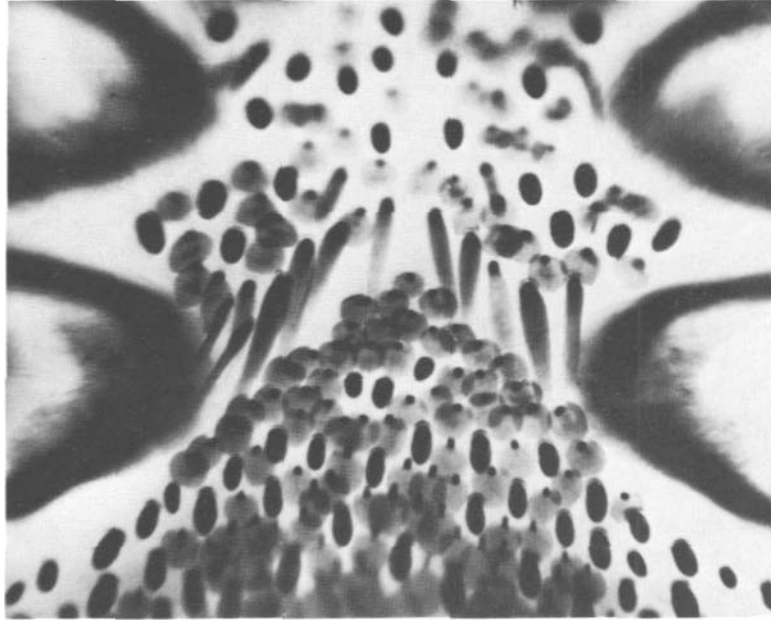

Fig. 4.8. The modified setae on *Antarctophthirus* spp. The scales and setae of the ventral thorax and abdomen of *A. lobodontis* of the crab-eater seal. (Photograph by I. Roper.)

bubbles of air are trapped around the body of *Antarctophthirus trichechi* (Bohemann) of the walrus when it is immersed in water. This was not observed with *A. ogmorhini* or *L. macrorhini* (Murray et al., 1965; Murray and Nicholls, 1965). Further studies on *L. macrorhini* (Murray, unpublished) have confirmed previous observations. Whenever trapped air was seen beneath the scales, as revealed by iridescence, the area involved was small and never communicated with the spiracles. Water was often seen to percolate beneath the scales. Thus the scales may serve to protect the delicate cuticle through which adequate gaseous diffusion can take place at low temperatures.

Scales may also prevent desiccation by trapping water around the louse when the seal is ashore, particularly in the arctic or antarctic, where the louse can be

in an arid microclimate of 0% R.H. and the skin temperature of the host may be 30°C. Clearly, although many of the ecological problems of population regulation of these lice are understood, our understanding of the physiology of key adaptations to enable these lice to lead a marine as well as a terrestrial life is lacking.

### ACKNOWLEDGEMENTS

I wish to thank Dr. B.C. Nelson, Vector Control Section, California State Department of Health, who kindly assisted in the preparation of Table 4.2.

Permission to reproduce text figures was kindly given by the editor of the Australian Journal of Zoology. I also wish to thank Dr. V.B. Scheffer of Bellevue, Washington, USA, for providing Fig. 4, and Mr. I. Roper, C.S.I.R.O. Division of Animal Health, McMaster Laboratory for his photographic assistance.

### REFERENCES

- Ass, M.Y. (1934) Anoplura der Walrosse. Trudy Arkt. Antarkt. Nauchno-Issled. Inst. 9, 89–105.
- Bryden, M.M. (1964) Insulating capacity of the subcutaneous fat of the southern elephant seal. *Nature* 203, 1299–1300.
- Dubinin, V.B. (1947) Studies on adaptation of ectoparasites. Ecological adaptations of the mallophagans and feather ticks. *Parazitol. Sbor.* 9, 191–222.
- Dubinin, V.B. (1955) The phenomenon of 'parasitophoria' among ectoparasites and its significance for livestock and wild animal raising. *Trudy Zool. Inst., Leningr.* 21, 18–35.
- Ferris, G.F. (1951) The sucking lice. *Mem. Pacif. Cst Entomol. Soc.* 1, 1–320.
- Harrison, R.H. and Tomlinson, J.D.W. (1960) Normal experimental diving in the common seal (*Phoca vitulina*). *Mammalia* 24, 386–399.
- Kim, Ke Chung (1971) The sucking lice (Anoplura: Echinophthiriidae) of the northern fur seal: descriptions and morphological adaptation. *Ann. Entomol. Soc. Am.* 64, 280–292
- Kim, K.C. (1972) Louse numbers on the northern fur seal (*Callorhinus ursinus*). *Am. J. Vet. Res.* 33, 2027–2036.
- Kim, K.C. and Emerson, K.C. (1974) *Latogophthirus rauschi*, new genus and new species (Anoplura: Echinophthiriidae) from the river otter (Carnivora: Mustelidae). *J. Med. Entomol.* 11, 442–446.
- Kim, K.C. (1975) Ecology and morphological adaptation of the sucking lice (Anoplura: Echinophthiriidae) on the northern fur seal. In: *The Biology of the Seal* (K. Ronald and A.W. Mansfield, Eds) p.-v. Reun. Cons. Term. Int. Explor. Mer., Vol. 1, no. 69 (I.C.E.S. Rapp) pp. 504–515.
- Kim, K.C., Reppening, C.A. and Morejohn, G.V. (1975) Specific antiquity of the sucking lice and evolution of Otariid Seals. In: *The Biology of the Seal*. (K. Ronald and A.W. Mansfield, Eds) p.-v. Reun. Cons. Term. Int. Explor. Mer., Vol. 1, no. 69 (I.C.E.S. Rapp) pp. 544–549.
- Kooyman, G.L. (1966) Maximum diving capacities of the Weddell Seal, *Leptonychotes weddelli*. *Science* 151, 1553–1554.
- Lavoipierre, M.M.J. (1967) Feeding mechanism of *Haematopinus suis* on the transilluminated mouse ear. *Exp. Parasitol.* 20, 303–311.
- Murray, M.D. (1957a) The distribution of the eggs of mammalian lice on their hosts. I. Description of the oviposition behaviour. *Aust. J. Zool.* 5, 13–18.



- Murray, M.D. (1957b) The distribution of the eggs of mammalian lice on their hosts. II. Analysis of the oviposition behaviour of *Damalinia ovis*. Aust. J. Zool. 5, 19–29.
- Murray, M.D. (1960) The ecology of lice on sheep. I. The influence of skin temperature on populations of *Linognathus pedalis* (Osborn). Aust. J. Zool. 8, 349–356.
- Murray, M.D. (1963) The ecology of lice on sheep. IV. The establishment and maintenance of populations of *Linognathus ovis* (Neumann). Aust. J. Zool. 11, 157–172.
- Murray, M.D. (1964) Ecology of the ectoparasites of seals and penguins. In: Antarctic Biology. Proc. 1st S.C.A.R. Symp. Antarctic Biol., Paris, 1962, (R. Carrick, J. Prévost and M.W. Holdgate, Eds.) , , pp. 241–245.
- Murray, M.D. (1965) The diversity of the ecology of mammalian lice. Int. Congr. Entomol., 1964, 366–367.
- Murray, M.D. and Nicholls, D.G. (1965) Studies on the ectoparasites of seals and penguins. I. The ecology of the louse *Lepidophthirus macrorhini* Enderlein on the southern elephant seal *Mirounga leonina* (L.). Aust. J. Zool. 13, 437–454.
- Murray, M.D., Smith, M.S.R. and Soucek, Z. (1965) Studies on the ectoparasites of seals and penguins. II. The ecology of the louse *Antarctophthirus ogmorhini* Enderlein on the Weddell seal *Leptonychotes weddelli* Lesson. Aust. J. Zool. 13, 761–771.
- Murray, M.D., Orton, M.N. and Cameron, A.S. (1967) The antarctic flea *Glaciopsyllus antarcticus* Smit and Dunnet. Antarct. Res. Ser. 10, 393–395.
- Murray, M.D. and Vestjens, W.J.M. (1967) Studies on the ectoparasites of seals and penguins. III. The distribution of the tick *Ixodes uriae* White and the flea *Parapsyllus magellanicus heardi* de Meillon on Macquarie Island. Aust. J. Zool. 15, 715–725.
- Nelson, B.C. (1971) Successful rearing of *Colpocephalum turbinatum* (Phthiraptera). Nature New Biol. 232, 255.
- Nelson, B.C. and Murray, M.D. (1971) The distribution of Mallophaga on the domestic pigeon (*Columba livia*). Int. J. Parasitol. 1, 21–29.
- Nelson, W.A., Clifford, C.M., Bell, J.F. and Hestekin, B. (1972) *Polyplax serrata*: Histopathology of the skin of louse-infested mice. Exp. Parasitol. 31, 194–202.
- Williams, R.T. (1971) In vitro studies on the environmental biology of *Goniodes colchici* (Denny) (Mallophaga: Ischnocera). III. The effects of temperature and humidity on the uptake of water vapour. J. Exp. Biol. 55, 553–568.

# Migrating and other terrestrial insects at sea

John Bowden C.G. Johnson

<b>Contents</b>		
5.1	Introduction	97
5.2	Insects recorded flying far out to sea	98
5.3	The size of insect populations over the sea compared with estimates made over the land	102
5.4	Colonization of the open sea	103
5.5	Trans-oceanic dispersal in relation to wind currents	105
5.6	Colonization of oceanic islands	112
5.7	Aerial transport of biomass from land to sea	113
References	116	

## 5.1 INTRODUCTION

Insects observed flying far out to sea reflect the dispersal processes of terrestrial populations and are relevant mainly to the colonisation of distant lands. We do not intend to discuss this problem; we are chiefly concerned with the presence of insects at sea, that is to say how they impinge on the marine environment, especially the open waters. There are two issues: the colonization of the sea and the supply of organic matter to the sea, both of which are largely unassessed.

However, it is possible at present, only to indicate rather than to explore these problems. We shall also briefly discuss the dispersal and deposition of insects over land as a background to any future quantitative approach to the problems of insects over the sea.

The data presented in this chapter have been selected from a large, inchoate literature which has not yet been satisfactorily systematised.

## 5.2 INSECTS RECORDED FLYING FAR OUT TO SEA

All insects recorded far out over the sea, even the fast-flying locusts and Lepidoptera, are borne there on the wind while they themselves are flying actively. The majority of insects are small, slow fliers, often with less than 1-cm wing span and are displaced even by slow winds of less than 5 km h<sup>-1</sup>. In this way they may often travel hundreds of kilometres; though 'weak', many can sustain themselves in the air by active flight for many hours and can thus travel far on the wind. Also, insects can attain heights of some thousands of metres, where the wind is usually strongest, by convection currents. Many examples of such long distance displacements and high altitude flights are given in Williams (1958), Johnson (1969) and Johnson and Bowden (1973); a few are mentioned below.

Many small insects have been sampled more or less systematically by nets or by suction traps over the sea because they are relatively numerous and are most likely to be caught in aerial traps. The relatively uncommon but much more spectacular butterflies, moths, and locusts have also been observed many times far out over the sea but infrequently trapped. All these records indicate the presence of particular species and, where sampled by trapping, their relative abundance. However, they do not supply data on air-volume densities from which the total biomass in the air can be estimated. The records thus only reflect the immense numbers involved; they do not assess them, and the records moreover are mostly unrelated to outputs from terrestrial sources. We shall therefore list relative numbers of different taxa trapped over the seas. An attempt will also be made to compare the figures with those obtained over the land, where it has been possible to estimate the total numbers of insects (or biomass) in the air over a given area, which gives some idea of the numbers eventually deposited.

Hardy and Milne (1937) trapped insects with nets on large kites flown from ships in the North Sea (Fig. 5.1). Table 5.1 shows the relative numbers of different

Table 5.1 Insects trapped on ships in the North Sea (from Hardy and Milne, 1937)

<i>Diptera</i>		<i>Hemiptera</i>		<i>Lepidoptera</i>	
Acalyptates	355 (69.1%)	Aphididae*	171	Microlepidoptera	5
Chironomidae	54 (10.5%)	Psyllidae	1	Noctuidae	1
Mycetophilidae	53 (10.3%)	Total	172	Total	6
Cecidomyiidae	21 (4.1%)	<i>Hymenoptera</i>		<i>Neuroptera</i>	
Psychodidae	20 (3.9%)	Ichneumoidea	7	Hemerobiidae	2
Syrphidae	7 (1.4%)	Chalcidoidea	5	Chrysopidae	1
Phoridae	3 (0.6%)	Total	12	Total	3
Culicidae	1 (0.2%)	<i>Trichoptera</i>		Unrecognisable	16
Total*	514 (100%)	Spiders	6	Grand Total	730

Percentage of total catch: (a) Diptera, 69%; (b) Aphididae, 23%.

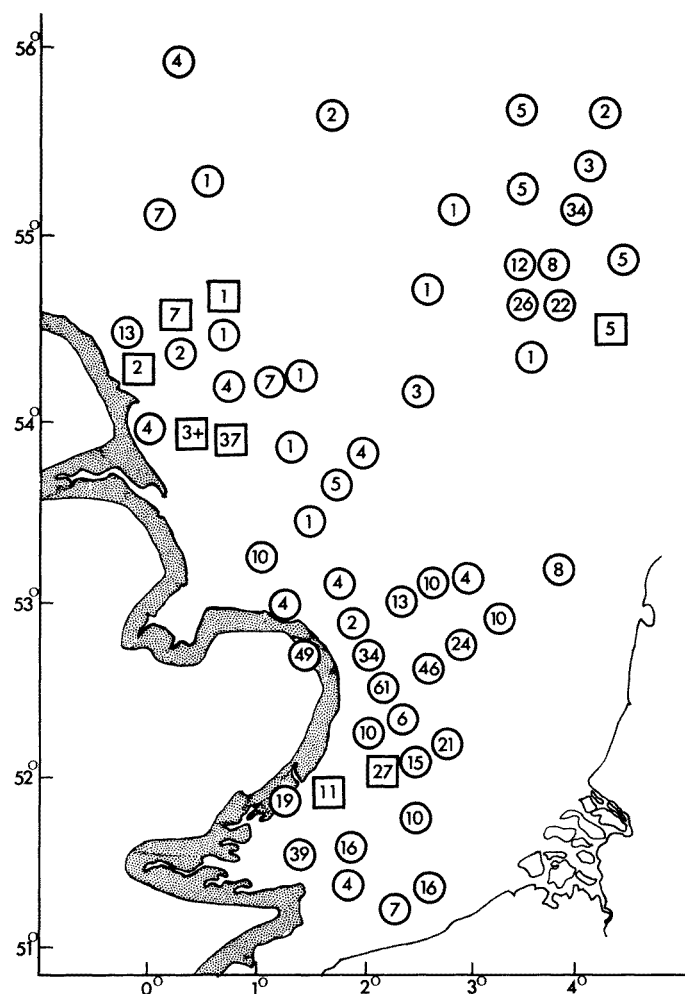

Fig. 5.1. Insects trapped on ships over the North Sea, during August 1936. Figures in circles are numbers of insects caught in nets at mast-head, approximately 14 m above sea level; those in squares in nets flown from kites approximately 70–140 m above sea level. Shaded land area represents the 16-km strip referred to in text. Adapted from Hardy and Milne, 1937.

taxa. More were caught in some places than in others and this was attributed to variation at the source (most probably in Britain) caused by changes in convection there. Lack of convection at night is, however, unlikely to be the only factor responsible for the variation of numbers at particular places, because such variation is also affected by the sizes of populations at the source, particular flight periodicities and wind direction. In fact many crepuscular and nocturnal fliers, flying when convection is minimal, were represented - e.g. Psychodidae and Chironomidae. The most abundant taxa were the day-flying aphids and acalyprate

Diptera, most of which are strongly diurnal - e.g. Frit fly (*Oscinella frit* (L.)). Among them are also species which are, at least on occasion, crepuscular, e.g. some Chloropidae and Agromyzidae.

The most extensive data on insects trapped at sea are in papers by Gressitt and his colleagues who trapped on ships mainly in the Pacific Ocean but also in the Antarctic, Indian and Atlantic Oceans and other seas. We give in Tables 5.2 and 5.3 lists of the families and orders of insects and other arthropods they trapped at sea. Most of their samples are collected several hundred kilometres away from land. Some taxa are particularly well represented both in numbers and frequencies trapped, indicating the commonness of a taxon and its proneness to dispersal per se, respectively, (Fig. 5.2).

Table 5.2 Numbers of insects of different Orders trapped mainly in the Pacific Ocean but also in the Atlantic, Indian and Antarctic Oceans. (Compiled from Gressitt et al., 1960, 1961, 1962; Yoshimoto and Gressitt, 1960, 1961; Yoshimoto et al., 1962a, b; Harrell and Yoshimoto, 1964; Harrell and Holzapfel, 1966).

Homoptera	2982
Diptera	2950 (3397*)
Hymenoptera	498
Heteroptera (excluding <i>Halobates</i> )	142
Coleoptera	139 (185*)
Lepidoptera	125
Thysanoptera	44
Psocoptera	29
Neuroptera	1g
Odonata	19
Orthoptera	14
Blattaria (including Mantidae)	4
Collembola	2
Anopleura	2
Isoptera	1
Ephemeroptera	1
Total Insects	6968
Araneida	235
Acarina	13
Total	7216

\* Including those specimens likely to have originated on the ship or in ports (Yoshimoto et al., 1962b).

Table 5.3 Insects trapped over the Pacific, Indian and Antarctic Oceans, and other seas, arranged in Families as percent of total in each Order (sources as in Table 5.2).

<i>Homoptera</i>	%	<i>Heteroptera</i>	%
Aphididae	56	Miridae	54
Cicadelloidae (including Jassidae and Tettigellidae)	23	Lygaeidae	16
		Coreidae	7
Fulgoroidea (including Derbidae, Delphacidae (= Araeopidae)	19	Nabidae	6
		Pentatomidae	6
Psyllidae	1	Tingidae	2
Aleyrodoidea	1	Anthocoridae	1
Coccoidea	< 0.1	5 other families each with Unknown	< 1 6

<i>Hymenoptera</i>		<i>Lepidoptera</i>	
Agaontidae	38	Microlepidoptera (unspecified)	30
Formicidae	18	Pyralidae	25
Eulophidae	11	Noctuidae	11
Pteromalidae	8	Gelechiidae	10
Scelionidae	5	Blastobasidae	8
Braconidae	4	Opostegidae	4
Elasmidae	4	Epermeniidae	2
Ichneumonidae	2	Lyonetiidae	2
Mymaridae	2	Oecophoridae	2
Perilampidae	2	Arctiidae	1 each
Proctotrupidae	2	Coleophoridae	
12 other families each with	< 1	Hesperiidae	
		Nymphalidae	
		Pterophoridae	
		Pyromorphidae	
		Sphingidae	
		Tineidae	
		Tortricidae	
		Unknown	
<i>Coleoptera</i>		Diptera	
Staphylinidae	a 18	b 14	a 50
Coccinellidae	15	11	44
Nitidulidae	9	21	10
Hydrophilidae	8	6	8
Chrysomelidae	8	4	7
Lathridiidae	5	4	5
Carabidae	4	3	5
Curculionidae	4	3	4
Scolytidae	3	3	3
Cleridae	2	2	14
Cucujidae	2	2	2
Cybocephalidae	2	2	2
Tenebrionidae	2	2	1
Anobiidae	1	< 1	1
Buprestidae	1	1	1
Scarabaeidae	1	1	1
Corynetidae	<1	11	1
12 other families each with	<1	<1	<1
Unknown	6	4	<1
			2

<sup>a</sup> Excluding insects likely to have originated on the ship or in ports (Yoshimoto et al., 1962b)

<sup>b</sup> Including all insects.

This does not necessarily mean that they are absent far out at sea, merely that their aerial densities may be too small to detect. Similarly the catches of those taxa that are poorly represented may reflect large numbers in the air, though these numbers may be small relative to those of the commoner taxa - a point to be enlarged upon in the next section.

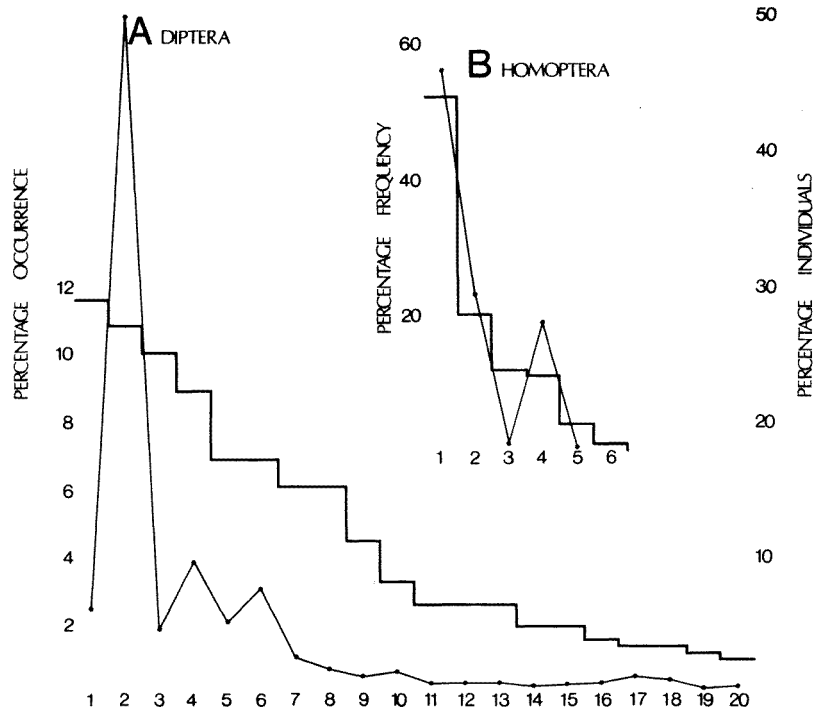

Fig. 5.2. Percentage of occurrences (histogram) and of individual specimens (graph) of different taxa listed in Table 5.3. (A) 1, Ceratopogonidae; 2, Drosophilidae; 3, Milichiidae; 4, Chironomidae; 5, Ephydriidae; 6, Agromyzidae; 7, Phoridae; 8, Chloropidae; 9, Cecidomyiidae; 10, Sphaeroceridae; 11, Sciaridae; 12, Dolichopodidae; 13, Tephritidae; 14, Muscidae; 15, Anthomyiidae; 16, Tipulidae; 17, Culicidae; 18, Opomyzidae; 19, Mycetophilidae; 20, Scatopsidae. (B) 1, Aphididae; 2, Cicadelloidea; 3, Psyllidae; 4, Fulgoroidea; 5, Aleyrodidae; 6, Coccoidea.

The orders and families of insects represented in the catches made by Hardy and Milne and by Gressitt and his colleagues are remarkably similar in general. For example, the Acalypteres make up 69% of the numbers of Diptera caught over the North Sea and 72% over the other waters. Of all orders of insects, Diptera represent 49% over the North Sea and 42% over the other oceans. Homoptera represent 24% and 43%, respectively, presumably reflecting both greater abundance and greater diversity of migratory taxa in lower and warmer latitudes, particularly over the Pacific Ocean.

### 5.3 THE SIZE OF INSECT POPULATIONS OVER THE SEA COMPARED WITH ESTIMATES MADE OVER THE LAND

The air above the land is more or less continuously populated by flying insects up to heights of several thousand metres. In general, density is inversely proportional

to height; nevertheless, because of the greater volume of air above, say, 30 m than below it, most insects in the air are above that level.

The total number of insects in the air above a particular place on land can be assessed by integrating the density-height gradient above it (Johnson, 1969). This can give some idea of the huge numbers of insects available to be blown out to sea. However, the absence of data on density-height gradients above the sea itself makes it difficult to assess the actual numbers in the air over the oceans. Their number must be vast, judging by the estimates obtained of total aerial insect populations up to great heights over the land. For example, in one of the first investigations on aerial insects, Coad (1931) estimated that over an area of  $2.6 \times 10^6 \text{ m}^2$  (one square mile) in Louisiana, there were as many as 36 million insects in the column of air up to a height of 4300 m. The density of aphids at 3 m above ground level in England could reach  $3.6/\text{m}^3$  in August. Using this data it can be estimated (from the density-height profile, see Johnson, 1969) that there could be as many as  $2.8 \times 10^9$  aphids at the maximum peak of daily flight in the summer (with somewhat lesser numbers at other times of day) above the strip of land in Eastern England ( $16 \times 650 \text{ km}$ ) from which Hardy and Milne's (1937) catches probably originated (see Fig. 5.1). Unfortunately their data do not provide sufficient information for estimating aerial insect densities over the sea, but merely indicate the presence of these insects in the air over the sea.

Among the Acalypterate Diptera, Chloropidae are particularly prone to largescale dispersal. Glick (1939), who trapped up to 4600 m above Louisiana, found that Diptera was by far the most numerously represented order and Chloropidae the most numerous of the dipteran families. The percentage of chloropids caught remained fairly constant at all heights; 32% (1010 individuals out of a total of 3133) at 60 m, and 33% (74 out of 224) at 1620 m (see Johnson, 1969). Two chloropids have been caught 960 km from land (Yoshimoto et al., 1962) but these give no idea of the size of the aerial population they presumably represent. We do, however, have some information on the densities of one species of chloropid (*Oscinella frit*, the frit fly) over land in England. An average of only 3 frit flies per day were caught at 3 m above ground level in  $85,000 \text{ m}^3$  of air sampled when the integrated density-height profile to 1000 m indicated the presence of about 7000 flies above an area of  $28,200 \text{ m}^2$  (one million square feet) (Johnson, 1969). This may give us some idea of the chloropid population that may be available over the ocean.

#### 5.4 COLONIZATION OF THE OPEN SEA

Aquatic insects are relatively few in number compared with those on land; marine insects are even fewer and most of them are littoral. There are only 5 insect species found in the open ocean, all belonging to the genus *Halobates* (Hemiptera,



Gerridae) (Cheng, 1974; Ch. 8 this volume). Nevertheless, untold millions of insects rained down upon the open seas for millions of years. Why so few have become adapted to live in the sea and in particular the open waters, is obscure. The reason cannot altogether be because such insects drown, for even small leaf hoppers can alight on the sea and take off again (Kisimoto, 1971). Migratory Lepidoptera have been seen to alight on the sea and then to take off (Williams, 1931) and many species are adapted to swim beneath, walk on or fly from the surface film of water. Many larval insects are filter feeders, e.g. mosquitoes, and adults of these insects have been recorded over 100 km from land (Johnson, 1969). Adult female mosquitoes can become independent of blood by autogeny and many littoral species have adapted to saline waters (Ch. 12). It is therefore unlikely that the absence of blood meals for adults or excessive salinity for larvae are limiting factors for mosquitoes. The thermal properties of seas and oceans, said by Urdvady (1969) to add to their effectiveness as barriers against dispersal of terrestrial animals, cannot be considered as seriously inhibitory for insects. Numerous freshwater insects are cold adapted and, though temperature may well play some part in limiting the distribution of *Halobates*, this genus is, nevertheless, found between 40°N and 40°S (Cheng, 1973, 1974), a latitudinal belt in which enormous numbers of many species of insects fly over and are deposited upon the oceans. It might be thought that insects deposited on the oceans would inevitably drift to land and might be more prone to colonise shores than the open sea; but open, and often rough, freshwater is colonised by corethrid (Chaoboridae) larvae 100 km or more offshore in Lake Victoria. Furthermore, *Halobates* seems to have no difficulty in maintaining mid-oceanic stations and is rarely washed to shore.

There are few quantitative data on the extent to which insects survive as drifters. Drifting vegetation found up to 16 km offshore supported many insects, though only 25% of such flotsam contained living terrestrial animals; no insect was found on flotsam collected 160 km offshore (Heatwole and Levins, 1972). Colonies of ants have been recorded in drifting wood (Wheeler, 1916; Heatwole and Levins, 1972) but the cosmopolitan distribution of many tramp species is largely if not entirely due to human agency (Brown, 1954; Johnson and Bowden, 1973), suggesting that survival at sea, even in relatively protected situations inside floating wood, is short. Although live Staphylinidae have been found in drift items (Heatwole and Levins, 1972), Moore and Legner (1974) believe that eight out of the nine cosmopolitan species of Staphylinidae have most probably been spread by man in recent times. Zimmerman (1948) concludes that marine drift has probably been the least successful method of insect dispersal, yet it has been suggested that trans-Atlantic rafting which requires 8–12 weeks to accomplish (Guppy, 1917; Kluge, 1969) may explain the disjunct amphi-Atlantic distributions of some animals (e.g. Gekkonidae: Kluge, 1969; Scorpionidae: Newlands, 1973). This highlights the apparent inability of insects to survive for

long periods at sea, even among taxa in which some degree of success might have been expected. But why are there no drifting aquatic larvae living in the surface waters of the oceans, or corixids or notonectids in the open sea? Why have no salt-water mosquitoes colonised the oceans? As far as insects are concerned, the open sea is evidently one vacuum that nature does not abhor.

### 5.5 TRANS-OCEANIC DISPERSAL IN RELATION TO WIND CURRENTS

There are now several well-documented instances of migrant insects arriving at particular places on particular wind currents from sources hundreds or thousands of kilometres away. In nearly all of these the insects are large, and suddenly arrive in noticeable numbers in a well-defined area at a particular time; this enables meteorologists to backtrack the associated wind, and the insects on it, to a probable source. We give, in Fig. 5.3, some of the clearest examples; they are from the Atlantic and Arctic Oceans and are nearly all of large or conspicuous insects; other examples are to be found in Johnson (1969). Trajectories for small insects are rarely known, exceptions being the aphid *Cinara abieticola* (Cholod.) that flew evidently for more than 1000 km from Kola Peninsula to Spitzbergen (Elton, 1925) (Fig. 5.3), the journeys of the two leaf-hoppers (*Nilaparvata lugens* (Stal.) and *Sogatellafurcifera* (Horv.) over the sea from China to Japan (Kisimoto, 1971) and a highly probable transit of the grain aphid (*Macrosiphum miscanthi* (Takahashi)) from Victoria, Australia to Canterbury, New Zealand (Tomlinson, 1973).

Dealing now with the examples in Fig. 5.3; many thousands of the small Diamond-back Moth, *Plutella xylostella* (L.) (= *maculipennis* Curtis) were seen in the eastern regions of England and Ireland and at a weather ship 500 km south of Iceland in vast numbers on dates that enabled the probable course and origin to be determined by backtracking the winds to a probable source in the Baltic area, in flights of up to 3000 km taking 4–5 days. Most of this flight would be non-stop, for although it might be possible for moths to alight on the sea and to take off again, they would be unable to refuel (French and White, 1960).

There are now many examples of backtracks of the noctuid moth *Spodoptera exigua* (Hb.). Originating in Portugal, Spain and North Africa they fly regularly northwards to northern Europe, covering distances up to about 3000 km mostly over the sea (Hurst, 1963, 1964; French, 1965, 1966, 1968; Johnson, 1969).

Several crossings of the North Atlantic Ocean from west to east by migrating Lepidoptera are now recorded; for example the noctuid *Phytometra biloba* (Steph.) has been backtracked, giving a trajectory from North America to Britain (Fig. 5.3) and the Monarch Butterfly, *Danaus plexippus* (L.), which is often recorded arriving in Britain, almost certainly crosses in a similar manner.

Other examples of transoceanic transport of migrating insects associated with

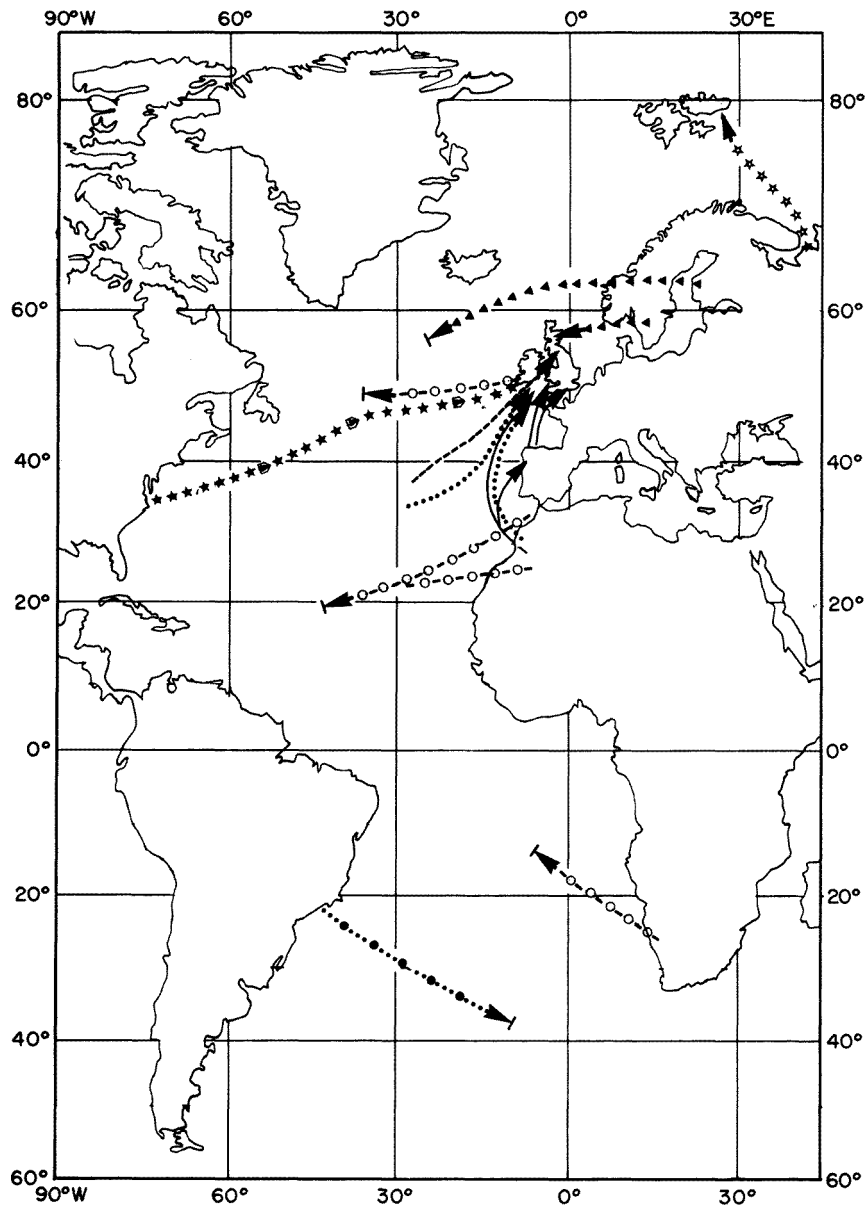

Fig. 5.3. Examples of trajectories of migrant insects over the Atlantic Ocean, as estimated from backtracking associated winds, ☆ ☆ ☆, *Cinara abieticola*; ◄◄◄, *Plutella xylostella*; ○-○-○-○, *Vanessa cardui*; ·····, *Vanessa brasiliensis*; ☆ ☆ ☆, *Phytometra biloba*; ---, *Hippotion celerio*; —, *Spodoptera exigua*; ·····, *Schistocerca gregaria*.

wind trajectories are the Desert Locust, *Schistocerca gregaria* (Forsk) from North Africa to Britain over a track similar to that for *S. exigua* (Rainey, 1963); the Silver-striped Hawk Moth, *Hippotion celerio* (L.) probably from the Azores to Britain (Johnson, 1969); the Painted Lady Butterfly, *Vanessa cardui* (L.) probably from Spain to mid-Atlantic (Williams, 1958) and the moth *Nomophila noctuella* (Schiff.) from North Africa over the eastern Atlantic Ocean to Britain (Hurst, 1963). All these, and other similar but less well documented examples, are described in detail in Johnson (1969). Most records of insects above the Atlantic Ocean indicate that they are there most often in seasons when depressions and hence strong winds are most frequent (Fig. 5.4); it seems likely that this happens over other oceans.

The main point in describing these trajectories, apart from their intrinsic interest, is this. Such conspicuous, easily identified insects are recorded especially by amateur entomologists who are alert for them. But, such insects are relatively few compared with the much smaller, inconspicuous ones among Diptera, Hymenoptera, Coleoptera and Hemiptera which do not attract so much attention. Table 5.3 shows that noctuids only account for 11.1% and sphingids or nymphalids less than 1% of insects caught among the Lepidoptera alone; and, as an Order, Lepidoptera are less than 2% of all the insects caught (Table 5.2)! It may be taken for granted that accompanying the Lepidoptera over the ocean are untold millions of small insects of great variety which go unrecorded when they reach land inconspicuously and are rarely recorded out at sea.

The importance of wind in the movements of large insect populations above the sea is well-established but little is known about the patterns of such movements. A recent discussion of trans-Atlantic transport (Johnson and Bowden, 1973) indicates that these patterns may be quite definite. For example, the complete absence of trans-Atlantic winds blowing right across from west to east between latitudes approximately 25°N and 25°S of the equator evidently makes it impossible for insects to cross these regions from the New to the Old World (Fig. 5.5). By contrast, most winds across these regions blow from Africa towards the New World but at the shortest distance (about 3000 km) between the two continents, the doldrums would severely limit the chances of a successful crossing. Distances increase to the south and to the north of these latitudes and though crossings are still unlikely because of long distances, vast numbers of insects are undoubtedly being blown in both directions in those regions according to season.

The map in Fig. 5.4 (adapted from Fig. 5 in Johnson and Bowden, 1973, and up-dated to include new records) indicates the numbers of insects, mainly Orthoptera, Odonata and Lepidoptera, that have been recorded over the Atlantic Ocean between the tropics of Cancer and Capricorn. As might be expected, coastal records predominate, particularly those among the shipping lanes between Europe and West and South Africa. There is a dearth of records off the South

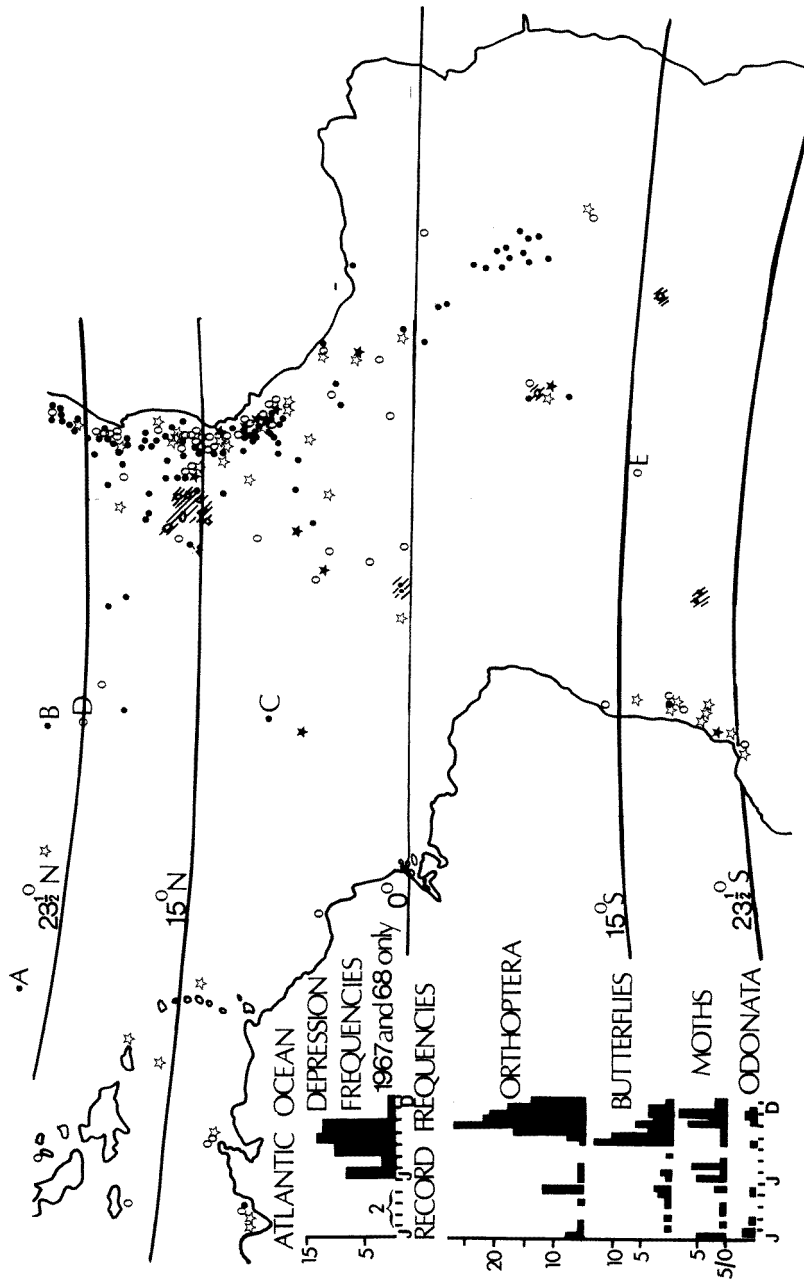

Fig. 5.4. Locations of insects recorded over the Atlantic Ocean between 25°N and 25°S and a comparison of frequencies of records with frequencies of depressions, over the Atlantic Ocean. A: *Schistocerca paranensis*; B,C: *S. gregaria*; D,E: *Vanessa cardui*; Orthoptera; o, Butterflies; ☆, Moths; ★, Odonata.

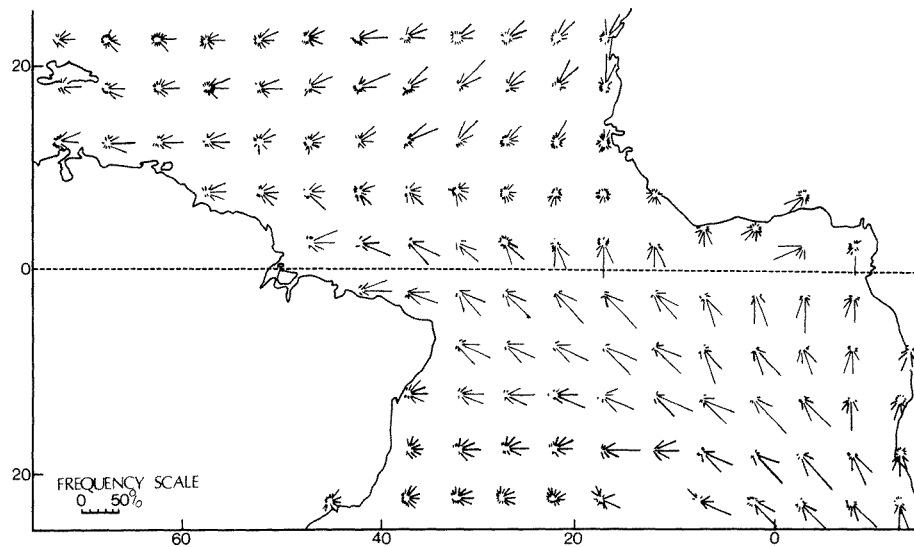

Fig. 5.5. Percentage frequencies of winds between 25°N and 25°S in October, for 67 years to the South and 29 years to the North of the Equator. Wind roses for the other months of the year are similar. Adapted from monthly meteorological charts of the Atlantic Ocean as reproduced in Johnson and Bowden, 1973.

American coast, which is not entirely caused by any difference in shipping density. The differences between the two sides of the Atlantic probably reflect differences in wind patterns.

*Schistocerca gregaria* (Forsk) is a strong flier and can remain airborne for three or four days (Rainey, 1963). There are several records of it more than 1500 km from the nearest land. There is no record of it having crossed the Atlantic Ocean, but two females identified as *Schistocerca paranensis* were seen over the Sargasso Sea at 25°20'N 42°30'W\* on 24 May 1906 (Fig. 5.4) (Weidner, 1969). If these were *S. paranensis* they could have come from South America, but Dirsh (1974)\*\* has shown that the differences between *paranensis* and *gregaria* are so slight that the two taxa should be considered as the same species. It is possible therefore that the Sargasso insects were African *gregaria*, identification having been influenced by the locality in which they were found. Swarms of desert locust are not uncommon near the West African coast between latitudes 10° N and 20° N during May and if this region was the source of the individuals recorded at 42°30' W their flight trajectory would be remarkably similar to that described

\* In Johnson and Bowden (1973) this latitude was misprinted as 62°30' W.

\*\* We have kept to the old nomenclature. According to Dirsh (1974) the two taxa should be called *Schistocerca americana paranensis* and *S. a. gregaria*.

by Prospero and Carlson (1970) for air-borne dust crossing the Atlantic, or to those described for African disturbances which cross the Atlantic and may develop into named hurricanes that affect the Caribbean area (Simpson et al., 1969). One can thus speculate that desert locusts do indeed cross the Atlantic from east to west, but that such crossings, if they occur, are very near the extreme limits of endurance and they are probably relatively infrequent, although they could have been happening for a very long time. There is a possibility now of an increased interest in this matter in view of Dirsh's amalgamation of African and American locusts into one species.

Ragge (1972) has discussed a series of reports of the cricket *Gryllus bimaculatus* Degeer off the West African coast and suggested that their migrations to sea were the result of unusually high population densities following good rains from July to October in western Senegal. In at least three cases, migrating crickets were associated with strongly developed temporary weather systems at the InterTropical Convergence Zone (I.T.C.Z.). *G. bimaculatus* was one of the many species of insects which Bowden and Gibbs (1973) found to be migrating in association with the I.T.C.Z. Thus, the fact that they were migrating close to the I.T.C.Z. over and near Senegal is not considered to be unusual.

One of the few instances in which the place of capture of an insect in relation to wind system has been decisive in establishing its specific identity related to a Lygaeid bug. Scudder (1968) recorded *Pachybrachius vinctus* Say in mid-Atlantic (22°01'-23°20' N; 39°15'-40°12' W). That species is widely distributed in South America, the West Indies and the southern United States but has not been recorded from the eastern hemisphere. However, the specimen in question was caught in the middle of the east-to-west trade wind zone where there is a total absence of long wind fetch from west to east. It thus seemed impossible that it could have been wind-borne from the western hemisphere; re-examination showed the specimen to be in fact *P. dubius* Reuter, known from Ghana to Senegal. This record clearly represents the same kind of trans-Atlantic travel as was reported for *Schistocerca* (Johnson and Bowden, 1973).

*Vanessa cardui* (L.) is one of the most widely distributed butterflies in the world, found in every continent except South America. A record of this insect at 23° N 41' W (Fig. 5.3) was shown by Williams (1958) to be associated with wind from North Africa or Spain, implying a journey half-way across the Atlantic Ocean, over 2000 km from North Africa and more than 3000 km from Spain. Williams (1958) also noted an old record of *V. cardui* about 1750 km due west of Ireland and 800 km east of Newfoundland on 4 August 1865. Because the species had been common on both sides of the Atlantic at times when either side could have been the source, Williams could not be certain from which continent the insects came. However, we now know that for a week before the date of the capture there was a combination of cyclonic and northerly weather patterns over Britain (Lamb, 1972) and at 51°33' N, 38°17' W, the point of capture, such weather patterns

would have produced an easterly flow; the probable source was, therefore, Ireland.

A swarm of *V. cardui* was recorded in October 1939, 1600 km west of St. Helena and 1750 km east of Bahia (Johnson and Bowden, 1973). The butterfly is very rare in South America but common in Africa. Wind charts for October for the south Atlantic suggest that the most likely source was south western Africa, over 3000 km distant. Preliminary analysis of some recent observations of migrant Lepidoptera, including *Heliothis armigera* (Hb.) on Ascension Island (Bowden, unpublished), indicates a close association between the arrival of moths on Ascension and movement of frontal systems from south western Africa out over the Atlantic. This also supports the idea that this part of Africa was the source of the *V. cardui* found in mid-Atlantic. We thus have the interesting situation in which *V. cardui* is common in countries on both sides of the North Atlantic Ocean (N. America and Europe) and that there are mid-ocean records; it is common in countries on only one side (Africa) and absent from those on the other (S. America) of the South Atlantic Ocean, where there are also mid-ocean records. The distance between Ireland and Newfoundland is less than 3000 km, so one may speculate that a North Atlantic crossing is within non-stop migrational capability of *V. cardui*, hence its occurrence in countries on both sides of the North Atlantic Ocean, but that a South Atlantic crossing is not feasible, hence its presence only in Africa. Johnson and Bowden (1973) suggested that the practical limit for its transoceanic flight is of the order of 3000–4000 km, a distance which would permit crossing of the North Atlantic Ocean but prohibit a crossing of the South Atlantic Ocean. Assuming that there are occasional periods of favourable winds, the crossing between West Africa and Brazil may be possible; but successful crossings, if any, have not resulted in successful establishment of *V. cardui* in South America.

The related species *V. virginiensis* Drury form *brasiliensis*, which occurs in South America was, however, found on Tristan da Cunha in April 1944 (Williams, 1958). The nearest point in South America, Cabo Frio, is over 3000 km distant, but in these southern latitudes strong westerly winds blow frequently in April and it is South American taxa that are, therefore, the most likely to be found on Tristan da Cunha. However, *V.v. brasiliensis* is unknown in Southern Africa, the exact reverse of the situation in *V. cardui*, so that the distance involved, at least 5000 km, may be the reason why the South American species is not found in South Africa and conversely (Fig. 5.3).

We have discussed individual examples in some detail because they illustrate the point that the presence of insects over the ocean is a direct consequence of events in terrestrial populations and of the associated meteorological conditions. Isolated records of a particular species at a particular spot in the oceans may seem to be no more than accidental, but when systematised in even the preliminary way we have attempted, definite patterns are revealed such as the close coincidence



of the average annual frequency of Atlantic depressions originating in Africa and the numbers of records of large insects at sea (Fig. 5.4). This is probably a causal association because the incidence of westward moving depressions over West Africa varies according to the position of the I.T.C.Z. The further north this is, the more disturbances there are and the larger is the area of land south of the I.T.C.Z. over which disturbances can form. The I.T.C.Z. also controls the length and to some extent the intensity of the rainy seasons; most insects increase in numbers during the rainy seasons, thus large numbers of migratory, or potentially migratory, insects are produced at the same time as there is the maximum chance of meridional transport across West Africa and out into the Atlantic Ocean.

It seems reasonable to suppose that similar relationships may exist in other equatorial and subtropical regions where meteorological features and climatic conditions are comparable with those of West Africa. Data appropriate for such an analysis do not exist, although the scanty information available for large insects over the Indian Ocean, mainly in unpublished records at Rothamsted, suggests a situation very similar to that in the inter-tropical Atlantic Ocean (Fig. 5.4). Yoshimoto and Gressitt (1960) comment that nearly all the specimens taken more than 800 km from land were trapped during stormy periods when strong westerly winds (i.e. from the Asian mainland) were blowing, but that no specimens were taken during what they referred to as local squalls. They further commented that these observations supported the theory that wind currents in stormy periods are the main means of natural transport of terrestrial arthropods to oceanic islands. The mere association of insects caught at sea with stormy periods if divorced from terrestrial events, is insubstantial support for any theory of dispersal.

We consider here that insects fly far out over the sea because the same meteorological conditions that allow disturbances to develop, which become the transporters of migrating insects, also provide the climatic conditions which favour the development of at least some migrating populations.

## 5.6 COLONIZATION OF OCEANIC ISLANDS

It is beyond the scope of this chapter to consider the colonization of oceanic islands in any detail; but it seems that the insects most likely to colonise such islands are those most commonly or most consistently found high in the air and over the oceans. A proper investigation of this subject requires data on quantitative relationships between the number of insects at terrestrial sources and those airborne over the land and over the oceans; as we have pointed out, such data are not available. However, a comparison of the detailed analyses given by Zimmerman (1948) of the Hawaiian insect fauna, which he considered to be largely Pacific in its generic affinities (95% Pacific, 5% American) with Table 5.3 (mainly

western Pacific captures) shows that 10 of the 12 Orders of insects which have endemic species in Hawaii appear in Table 5.3. Among the Homoptera and Heteroptera, certain tingids and representatives of all the families with Hawaiian endemics have been found in the air over the western Pacific. Similar comparisons can be made in all the orders with endemic species in Hawaii, e.g., there are representatives of the Chrysopidae and Hemerobiidae, two of the three families of Neuroptera with endemics in Hawaii. The most interesting and obvious discrepancy between Zimmerman's analyses and those shown in Table 5.3 is the predominance of the Agaontidae among airborne Hymenoptera, whereas this family is absent from Hawaii. (The agaontids are 'fig insects' which live inside fruits of *Ficus*, where they are the agents of pollination and caprification. *Ficus* is abundant in southeast Asia, so that the occurrence of Agaontidae in offshore aerial samples is not surprising; but *Ficus* is entirely absent from Hawaii.) As pointed out by Zimmerman (1948), certain characteristics of the habits and life histories of some insects may prevent their colonisation of particular islands. The Agaontidae provide a good example. Although capable of being blown to Hawaii, their complete dependence on one genus of plants precludes their establishment on these islands.

### 5.7 AERIAL TRANSPORT OF BIOMASS FROM LAND TO SEA

Insects blown out to sea must, in due course, provide a considerable amount of organic matter to the surface water. At a time of maximum diurnal insect activity in, say, August, an estimated 560 million aphids, or about 2200 million insects per km<sup>2</sup>, may be available over the land to be blown over the western part of the North Sea alone. How these are distributed over the sea depends on wind speeds and directions and heights of insect flights, and will obviously vary greatly from area to area and from time to time. We know of no published report of systematic attempts to measure such deposition, but some unpublished data, made available to us by Sir Alister Hardy (Oxford Univ., England) and by Lanna Cheng, are summarized below.

Hardy's sample was collected by a 1-metre ring net, towed for 15 minutes in the sea on 17 July 1937, in the middle of the North Sea (56°04' N, 03°20' E). A total of 187 insects were collected including, in order of abundance, members of the following orders: Homoptera (73%), Diptera (25%), Coleoptera (< 1%), Lepidoptera (< 1%), and Heteroptera (< 1%). The Aphididae constituted the single most abundant family and accounted for 72% of total insects found.

Cheng's samples were also collected by a 1-metre net, towed for 15 minutes in the sea in June and July 1974, up to 50 km off the Oregon coast (about 44°40' N, 124°30' W). A total of 723 insects were obtained from 34 neuston samples, including, in order of abundance, members of the following orders:

Homoptera (47%) - 4 families  
 Diptera (36%) - 23 families  
 Hymenoptera (10%) - 15 families  
 Neuroptera (4%) - 3 families  
 Coleoptera (2%) - 3 families  
 Heteroptera (< 1%) - 3 families  
 Psocoptera (< 1%) - 2 families  
 Lepidoptera (< 1%) - 1 family

The Aphididae, as in Hardy's sample, was the most abundantly represented family; it accounted for 96% of all the Homoptera and 45% of the total insects recorded. There was no predominant family of Diptera, but the following 6 families were well represented: Psychodidae (19%), Mycetophilidae (14%), Cecido-myiidae (14%), Chironomidae (11%), Ephydriidae (11%), and Ceratopogonidae (8%). The Pteromalidae (36%) were the most numerous Hymenoptera, the Hemerobiidae (74%) the most abundant Neuroptera, and the Coccinellidae (77%) the most abundant Coleoptera (Birch and Cheng, unpublished).

Although detailed analyses are not yet available, the abundance and composition of insect samples collected in the sea from other regions of the world differ from those reported above. For example, aphids were much less abundant in 25 neuston samples collected in the English Channel in April 1971 (about 50° N, 01° E, 05° W), whereas the Staphylinidae family, which was absent in the Oregon samples, was very abundant. In another 20 samples taken in March 1975, off the coast of Baja California (between 23°50' and 24°20' N and 110° W), where terrestrial insects were extremely abundant and associated with marine pleuston animals (Cheng and Lewin, 1975), Lepidoptera appeared to be about as abundant as Homoptera and Coleoptera. It is quite evident that until data from detailed analyses of seasonal samples become available it is impossible to make any useful generalizations on the relative abundance of different orders of insects at sea.

Insects vary greatly in weight. Since about 95% of the insects listed in Table 5.1 are in the size range of aphid, weighing, say, 0.5 mg, we estimate that 1 kg of insects can be found above an area of 1 km<sup>2</sup> over land in England, in the summer. Thus the weight of insects that are available to be blown out over the North Sea (51–56° N) from the 16-km strip of land shown in Fig. 5.1, is about 12 metric tons per day. This weight, estimated on small insects available during the maximum peak of flight alone, does not include larger insects, e.g., bees, moths, or those airborne outside the peak flight period.

Land insects collected from the surface of the sea by net tows in the eastern part of the Black Sea by Zaitsev (1970) include the following genera or species:

Homoptera - *Megamelus* sp., *Deltocephalus* sp., *Cicadella* sp., genera and spp. of Jassidae and Aphidoidea

Heteroptera - *Nabis fesus* (L.), *Pirates hybridus*, *Camptopus lateralis*, *Ceraleptus obtusus*, *Pyrrhocoris apterus*, *Stictopleurus* sp., *Aelia* sp.

Coleoptera - *Harpalus* sp., *Taphoxemus* sp., *Agonum* sp., *Phytonomus* sp., *Sitona* sp., *Apion* sp., *Phyllotreta nemorum* (L.), *Phyllotreta* sp., *Adonia variegata*, *Coccinella undecimpunctata* (L.), *C. quinquepunctata* (L.) *Adalia bipunctata* (L.), *Aphodius melanosticus*, genera and spp. of Staphylinidae

Diptera - *Caenia* sp., *Syrphus corollae* (F.), *S. ochrostoma*, *Syrphus* sp., *Drymeia* sp., *Fucellia* sp., genera and spp. of Sepsidae, Dolichopodidae, Mycetophidae and Scatophagidae

Hymenoptera - *Solenopsis* sp., *Tetramorium* sp., *Apanteles* sp., genera and spp. of Braconidae, and Ichneumonidae

There were also unrecognizable fragments of Lepidoptera, Neuroptera, Orthoptera and Arachnida. Of particular interest were the large numbers of the Colorado beetle, *Leptinotarsa decimlineata* (Say), which were blown in from the sea and landed in large numbers (approx. 18/m of beach) on the beach of the Odessa area in July 1966. Since many of these pest beetles were still alive, they had to be destroyed by aerial spraying (Zaitsev, 1970).

Similar invasions of the Channel Islands by Colorado Beetles were reported by Dunn (1949), Small and Thomas (1950, 1954) and Le Berre (1962). Sea currents that flow northward may be influenced by easterly winds and then carry the beetles that are deposited on the sea, after flying from France, to the beaches of the Channel Islands. Beetles that have recently emerged from hibernation (as distinct from those after oviposition) have an oily coating on the cuticle so that they can survive immersion in sea water for up to ten days and are still able to fly (Dunn, 1949). Other examples of insects, especially of Coleoptera, washed up on beaches are given by Tutt (1901, 1902).

Zaitsev (1970) has made some estimates on the biomass of land insects settling on the Black Sea (42–46° N) based on insect samples collected in surface net tows. He found that, on certain areas of the western part of the Black Sea, insects from the land could reach as many as 80 specimens per 100 m<sup>2</sup> and that as many as 10<sup>9</sup> insects with a total weight of about 10 metric tons could be found at any one time on the whole surface of the Black Sea during the summer. (This value, evidently based on an average weight of 10 mg per insect, seems to us unreasonably high.) His figure (2.5 g dry wt/km<sup>2</sup>) is about an order of magnitude higher than that estimated by Cheng (1975) (0.2 g dry wt/km<sup>2</sup>) for surface waters of the central north Pacific Ocean (28–30° N, 155° W) during the winter months. The numbers of land insects at sea evidently vary greatly with the season as well as with the closeness to land of the sampling localities.

In the more productive regions of the ocean, deposition of insects may only provide a minor additional source of nutrients. However, in areas of low productivity, e.g., the ocean gyres, the addition of insects may be of considerable importance.

## REFERENCES

- Bowden, J. and Gibbs, D.G. (1973) Light-trap and suction-trap catches of insects in the northern Gezira, Sudan, in the season of southward movement of the Inter-Tropical Front. *Bull. Entomol. Res.* 62, 571–596.
- Brown, W.L. (1954) The ant genus *Strumigenys* Fred Smith in the Ethiopian and Malagasy regions. *Bull. Mus. Comp. Zool., Harvard* 112, 1–34.
- Chen, L. (1973) Halobates. *Oceanogr. Mar. Biol. Annu. Rev.* 11, 223–235.
- Cheng, L. (1974) Notes on the ecology of the oceanic insect *Halobates*. *Mar. Fish. Rev.* 36, 1–7.
- Cheng, L. (1975) Marine pleuston - animals at the sea-air interface. *Oceanogr. Mar. Biol. Annu. Rev.* 13, 181–212.
- Cheng, L. and Lewin, R.A. (1975) Flatworms afloat. *Nature* 258, 518–519.
- Coad, B.R. (1931) Insects captured by airplane are found at surprising heights. *Yb. Agric. (1931) U.S. D.A.* 320–323.
- Dirsh, V.M. (1974) The genus *Schistocerca*. (, .)
- Dunn, E. (1949) Colorado Beetle in the Channel Islands, 1947 and 1948. *Ann. Appl. Biol.* 36, 525–534.
- Elton, C.S. (1925) The dispersal of insects to Spitzbergen. *Trans. Entomol. Soc. Lond. (1925)* 289–299.
- French, R.A. (1965) Long range dispersal of insects in relation to synoptic meteorology. *Proc. XII Int. Congr.-Entomol.* (, 1964) 419.
- French, R.A. (1966) Long distance movement of two migrant Lepidoptera in relation to synoptic weather conditions. *Proc. III Int. Congr. Biomet.* (, 1963) 565–569.
- French, R.A. (1968) Migration of *Laphygma exigua* Hübner (Lepidoptera: Noctuidae) to the British Isles in relation to large-scale weather systems. *J. Anim. Ecol.* 38, 199–210.
- French, R.A. and White, J.H. (1960) The Diamond-back Moth outbreak of 1958. *Plant Pathol.* 9, 77–84.
- Gressitt, J.L., Coatsworth, J. and Yoshimoto, C.M. (1962) Airborne insects trapped on 'Monsoon Expedition'. *Pac. Insects* 4, 319–323.
- Gressitt, J.L., Leech, R.E. and O'Brien, C.W. (1960) Trapping of air-borne insects in the Antarctic area. *Par. Insects* 2, 245–250.
- Gressitt, J.L., Leech, R.E., Sedlacek, J. and Wise, K.A.J. (1961) Trapping of air-borne insects in the Antarctic area. Part 2. *Pac. Insects* 3, 559–562.
- Guppy, H. (1917) Plants, seeds, and currents in the West Indies and Azores. (, .)
- Hardy, A.C. and Milne, P.S. (1937) Insect drift over the North Sea. *Nature* 139, 510–511.
- Harrell, J.C. and Holzapfel, E. (1966) Trapping air-borne insects on ships in the Pacific. Part 6. *Pac. Insects* 8, 33–42.
- Harrell, J.C. and Yoshimoto, C.M. (1964) Trapping air-borne insects on ships in the Pacific. Part 5. *Pac. Insects* 6, 274–282.
- Heatwole, H. and Levins, R. (1972) Biogeography of the Puerto Rican Bank: flotsam transport of terrestrial animals. *Ecology* 53, 112–117.
- Hurst, G.W. (1963) Small Mottled Willow Moth in England, 1962. *Met. Mag. Lond.* 92, 308–312.
- Hurst, G.W. (1964) Meteorological aspects of the migration to Britain of *Laphygma exigua* and certain other moths on specific occasions. *Agric. Met.* 1, 271–281.
- Johnson, C.G. (1969) The migration and dispersal of insects by flight. (, .)
- Johnson, C.G. and Bowden, H. (1973) Problems related to the trans-oceanic transport of insects, especially between the Amazon and Congo Areas. In: *Tropical Forest Ecosystems in Africa and South America: A Comparative Review.* (B.J. Meggers, E.S. Ayensu and W.D. Duckworth, Eds.) pp. 207–222.
- Kisimoto, R. (1971) Long distance migration of plant-hoppers, *Sogatella furcifera* and *Nilaparvata lugens*. *Proc. Symp. Rice Insects (1971)*, 201–216.

- Kluge, A.G. (1969) The evolution and geographical origin of the New World *Hemidactylus mabouia* - *brookii* complex (Gekkonidae, Sauria). Misc. Publ., Mus. Zool. Univ. Michigan 138, 1–78.
- Lamb, H.H. (1972) British Isles weather types and a register of the daily sequence of circulation patterns 1861–1971. Geophys. Mem. No. 116, (M. O. 845b) Met. Off., .
- Le Berre, J.R. (1962) Les bases scientifiques des avertissements agricoles. In: Dix années de collaboration franco-britannique pour la défense des îles anglo-normandes contre les invasions du Doryphore. Phytoma 142, 11–23.
- Meteorological Office (1959) Monthly meteorological charts of the Atlantic Ocean. M.O. 483, (Met. Off., .)
- Moore, L. and Legner, E.F. (1974) Have all the known cosmopolitan Staphylinidae been spread by commerce? Proc. Entomol. Soc. Wash. 76, 39–40.
- Newlands, G. (1973) Zoogeographical factors involved in the trans-Atlantic dispersal pattern of the genus *Opisthacanthus* Peters (Arachnida: Scorpionidae). Ann. Transv. Mus. 28, 91–98.
- Prospero, J.M. and Carlson, T.N. (1970) Radon-222 in the North Atlantic Trade Winds: its relationship to dust transport from Africa. Science 167, 974–977.
- Ragge, D.R. (1972) An unusual case of mass migration by flight in *Gryllus bimaculatus* Degeer (Orthoptera Gryllidae). Bull. del'IFAN 34, ser A, 869–878.
- Rainey, R.C. (1963) Meteorology and the migration of desert locusts. Tech. Note World Met. Org. 54, 1–115.
- Scudder, G.G.E. (1968) Air-borne Lygaeidae (Hemiptera) trapped over the Atlantic, Indian and Pacific Oceans, with the description of a new species of *Appoloniuss* Distant. Pac. Insects 10, 155–160.
- Simpson, R.H., Frank, N., Shideler, D. and Johnson, H.M. (1969) Atlantic Tropical disturbances of 1968. Mon. Weather Rev. 97, 240–255.
- Small, T. and Thomas, G.E. (1950) Colorado Beetle in Jersey: 1949 and 1950. Agriculture, Lond. 57, 582–586.
- Small, T. and Thomas, G.E. (1954) Colorado Beetle in Jersey. A study of the problem of seaborne invasions. Agriculture, Lond. 61, 118–122.
- Tomlinson, A.I. (1973) Meteorological aspects of trans-Tasman dispersal N. Z. Entomol. 5, 253–268.
- Tutt, J.W. (1901) Migration and dispersal of insects: Coleoptera. Entomol. Rec. J. Var. 13, 281–284, 317–320, 353–358.
- Tutt, J.W. (1902) Migration and dispersal of insects: Coleoptera. Entomol. Rec. J. Var. 14, 73–75.
- Udvardy, M.D.F. (1969) Dynamic Zoogeography with Special Reference to Land Animals (, .)
- Weidner, H. (1969) Beobachtungen wandernder Feldheuschrecken auf hoher See. Anz. Schadlingsk Pflanzenoch. 43, 118–121.
- Wheeler, W.M. (1916) Ants carried on a floating log from the Brazilian mainland to San Sebastian Island, Psyche 23, 180–183.
- Williams, C.B. (1931) The migration of Butterflies. (, .)
- Williams, C.B. (1958) Insect migration. (, .)
- Yoshimoto, C.M. and Gressitt, J.L. (1960) Trapping of air-borne insects on ships in the Pacific. Part 3. Pac. Insects 2, 239–243.
- Yoshimoto, C.M. and Gressitt, J.L. (1961) Trapping of air-borne insects on ships in the Pacific. Part 4. Pac. Insects 3, 556–558.
- Yoshimoto, C.M., Gressitt, J.L. and Mitchell, C.J. (1962a) Trapping of air-borne insects in the Pacific - Antarctic Area 1. Pac. Insects 4, 847–858.
- Yoshimoto, C.M., Gressitt, J.L. and Wolff, T. (1962b) Air-borne insects from the Galathea Expedition. Pac. Insects 4, 269–291.
- Zaitsev, Yu.P. (1970) *Marine Neustonology*. Nauk Dumka, 264 pp. (in Russian, transl. Israel Programme for Scientific Translations).
- Zimmerman, E.C. (1948) Insects of Hawaii, Vol. 1. Introduction. (, .)

## Other intertidal air-breathing arthropods

Vincent D. Roth Wynne L. Brown

<b>Contents</b>		
6.1	Introduction - Key to intertidal Arthropods	119
6.2	Class Chilopoda	120
6.3	Class Symphyla	122
6.4	Class Paupoda	123
6.5	Class Diplopoda	123
6.6	Class Arachnida - Key to intertidal Arachnids	124
	6.6.1 Order Scorpiones	124
	6.6.2 Order Palpigradi	125
	6.6.3 Order Pseudoscorpiones	126
	6.6.4 Order Acari	129
	6.6.5 Order Araneae - Key to spider families	136
References	147	

### 6.1 INTRODUCTION

This chapter provides a world-wide review of air-breathing intertidal arthropods (except Insecta) normally excluded or treated only in passing in marine invertebrate textbooks (e.g., Eales, 1961; Ricketts and Calvin, 1962; Light, 1967; Allen, 1969; Brusca, 1973). Gosner (1971), however, included chapters on mites, pseudo-scorpions, spiders and insects in his guide to marine and estuarine invertebrates. The phylum Arthropoda includes about 80% of the species of the Animal Kingdom and is found in a great variety of habitats. A few of the normally terrestrial arthropods have extended their habitats from the vegetated supra-littoral zones along the oceans and seas into the intertidal zones and even onto the open ocean.

Only those arthropods restricted to the littoral zone are included here. Species normally confined to the supralittoral but which may be found in the midlittoral zone occasionally, are mostly excluded. Species listed in island literature as 'from the beach' or 'at high tide level' are included, although they may not be truly littoral. Perhaps some of these records are indications of collecting habits rather than a true picture of the island fauna.

The terminology used here in reference to intertidal zonation follows that of Stephenson and Stephenson (1972).

## KEY TO INTERTIDAL ARTHROPODS

1.	Body elongate, worm-like. One pair of antennae	2
	Body short, not worm-like. One or two pair of antennae or antennae absent	4
2.	One pair of legs on most body segments	3
	Two pairs of legs on most body segments	Diplopoda (in part) (Fig. 6.2)
3.	Twelve pairs of walking legs, two clawed tarsi	Symphyla
	Fifteen to 173 pairs of legs, one clawed tarsus	Chilopoda (Fig. 6.1)
4.	Antennae absent	5
	Antennae present	7
5.	Small marine forms 25 mm or less in length	6
	Large marine forms, 100 mm or more in length (Horseshoe crabs)	Xiphosura
6.	Abdomen minute, cephalothorax large, segmented	Pycnogonida
	Abdomen normal, similar in size to cephalothorax or larger	Arachnida
7.	One pair of antennae, no abdominal gills in adults	8
	Two pairs of antennae, abdominal gills	Eucrustacea
8.	Body with 3 pairs of legs in the adult stage	Insecta
	Body with 8–13 pairs of legs, minute, usually 3 mm or less	9
9.	Short stout hairs covering body dorsally, about 3 mm in length	( <i>Polyxenus</i> sp.) Diplopoda (in part) (Fig. 6.3)
	Body without stout hairs covering body, 1 mm or less in length	Paupoda

## 6.2 CLASS CHILOPODA (CENTIPEDES)

Centipedes comprise a fairly homogenous group of predaceous arthropods characterized by the presence of fang-like first walking legs with poison glands opening at the tip, and by their elongated, many-segmented body with a single pair of legs on most segments (Fig. 6.1). They are commonly found in the soil, under rotting debris in moist habitats, but a few have been found in the upper littoral, on sandy beaches under driftwood and debris washed ashore or under damp or wet seaweed or in honeycombed limestone, rock crevices and even empty barnacle shells (Crossland, 1929).

Although centipedes are usually quite intolerant of saltwater a few can withstand submergence, e.g. *Hydroschendyla submarina* (Grube) for 12–36 hours (Kaestner et al., 1968) and *Strigamia maritima* (Leach) for up to 30 hours (Hennings, 1903).



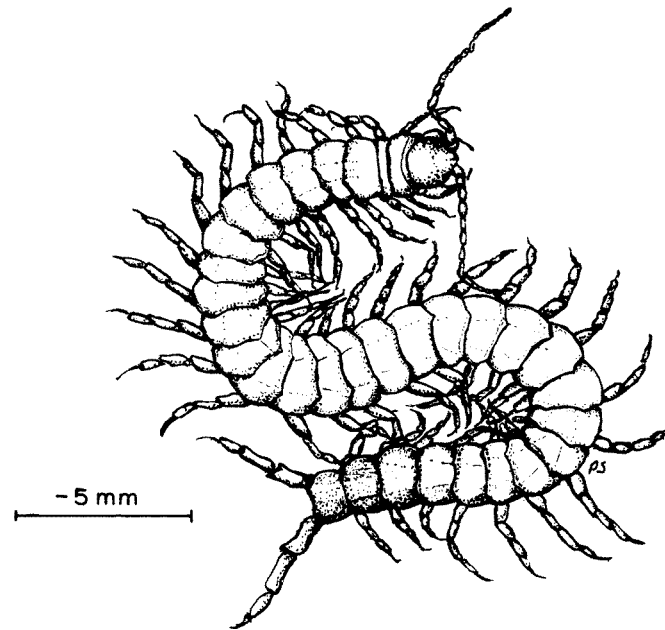

Fig. 6.1. Chilopoda (*Scolopendra* sp.)

Both species, like all other centipedes, are predators. *H. submarina* (Grube) is known to feed on leodicids and polychaete annelids whereas *S. maritima* (Leach) feeds upon *Sphaeroma* isopods, orchestioid amphipods, enchytraeid annelids, periwinkles (*Littorina*) and barnacles, *Balanus balanoides* (Kaestner et al., 1968).

Cloudsley-Thompson (1948) gave a historical review of the marine myriopoda and commented especially on the ability of some species to withstand submergence. Crabill (1960) discussed rafting as a means of dispersal of several intertidal species to the West Indian Islands. Brief descriptions of known littoral species are given below:

*Brachygeophilus* (?) *admarinus* Chamberlin (Crabill, personal communication): collected from under stones near the low tide mark in southeastern Alaska (Chamberlin, 1952).

*Clinopodes poseidonis* Verhoef: recorded by Silvestri (1903) from Naples, Italy as a genuine halophile.

*Halophilus dimidiatus angustus* (Latzel) was reported from the littoral zone in the Mediterranean area (Chamberlin, 1960), a questionable record (Crabill, personal communication).

*Hydroschendyla submarina* (Grube) is one of the best known marine centipedes found among coralline algae from the Mediterranean coasts of North Africa, Atlantic coasts of England, Europe and the Bermuda Islands. It has been reported

by Chamberlin (1920) from under stones, in honeycombed blocks of limestone and in fissures covered by high tides.

*Lionyx hedgpethi* Chamberlin: collected from under stones between the tide levels near Dillon Beach, Marin County, California (Chamberlin, 1960).

*Nyctunguis* sp. has been collected at the Monterey Peninsula, California from below the high tide line (Crabill, personal communication).

*Orphnaeus brevilabiatus* (Newport) was found coiled in protective cocoonlike structures in or on twigs floating or awash on beaches. Its ubiquitous occurrence throughout the islands and larger land masses of the tropics can perhaps be explained by its tolerance of saltwater (Crabill, personal communication).

*Pectiniunguis americanus* Chamberlin occurs under seaweed and driftwood on the coasts of the Gulf of Mexico, Florida, and Baja California. Another *Pectiniunguis* sp. is known from the littoral zone of the Galapagos Islands (Chamberlin, 1960).

*Strigamia maritima* (Leach), previously placed in the genera *Linotaenia* and *Scolioplanes*, is a well known species from the Mediterranean, the eastern Atlantic seaboard from Scandinavia to northern France, and the British Isles. Pocock (1900) reported this species to be common under a line of seaweed marking the high spring tide and was surprised 'to find specimens of all sizes swarming amongst the slimy decaying fronds and wriggling away into the darkness in company with hosts of scuttling woodlice and hopping sand shrimps while here and there was a cluster of them feeding on the remains of one of the crustaceans'. Eason (1964) reported this species from rock crevices, shingle banks and also found it in large numbers both below and above high tide marks.

*Tuoba* (*Nesogeophilus*), a genus known from New Zealand, Tasmania and South Australia, is partially if not completely littoral (Crabill, personal communication).

In addition to these Crabill (1960) recorded *Caritohallex minyrrhopus* Crabill, *Ballophilus riveroi* Chamberlin?, and *Schendylurus virgingordae* Crabill from wrack along the drift line in the West Indies.

### 6.3 CLASS SYMPHYLA

Symphylids are similar to centipedes in appearance but are usually much smaller, paler and characterized by three pairs of mouthparts, 12 pairs of walking legs and a pair of spinnerets on the last segment of the abdomen. They are usually found in damp soil, under deeply imbedded rocks and in leaf litter. They usually feed on rootlets of young plants but also scavenge. Michelbacher (1939, 1949) reported *Symphyella essigi* Michelbacher from the beach at the 'highest tide level' at Point Reyes, California.

## 6.4 CLASS PAUROPODA

Paupods are minute myriapods about a millimeter long, with a head, 12 body segments, 8–9 pairs of legs and usually covered with six large dorsal plates. They are predominately terrestrial and commonly found in decaying humus upon which they feed.

Because of their small size they were overlooked by marine biologists until 1935 when Bagnall discovered the first shore dwellers on the east coast of Scotland. Later he found four more species in the same area. *Thalassopauropus remyi* Bagnall was found under rocks deeply embedded in the sand well below the high water mark. Also collected, *Allopauropus thalassophilus* Remy and *A. danicus* (Hans.) were found under tree bark embedded in sand at high water mark, *A. littoralis* Bagnall at the high water mark and *A. stepheni* Bagnall on tidal flats under logs. *T. remyi* has also been collected from the Mediterranean coast of France (Bagnall, 1935a,b).

## 6.5 CLASS DIPLOPODA (MILLIPEDES)

Millipedes are characterized by their elongated, many segmented body with two pairs of legs on most segments (Fig. 6.2). Members of the Polyxenidae differ in being minute, having one or two pairs of legs per segment, having their body covered with numerous setae and possessing posterior tufts of hairs (Fig. 6.3). They are scavengers, feeding on decomposing animal and vegetable matter or herbivorous, feeding upon plant roots. Although most occur in moist terrestrial habitats, two species were reported by Silvestri (1903) to be genuine marine myriapods.

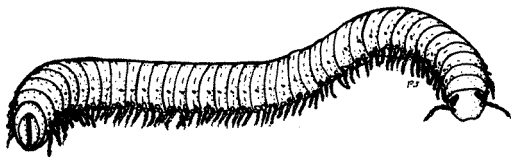

Fig. 6.2. Diplopoda (Spirobolid)  $\times 2$ .

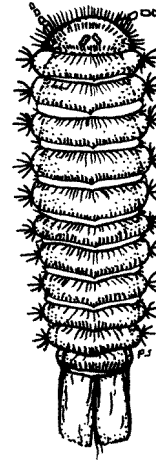

Fig. 6.3. Diplopoda (Polyxenid)  $\times 60$ .

*Polyxenus lapidicola* (Silvestri) (Polyxenidae) was collected from rock crevices at Protici near Naples, Italy.

*Thalassibates littoralis* (Silvestri) (Nemasomidae), also known as *Isobates littoralis*, lives under kelp on ocean beaches in Europe and the Mediterranean (Kaestner et al., 1968).

## 6.6 CLASS ARACHNIDA

The class Arachnida is a large diverse group of terrestrial arthropods most easily characterized by the absence of antennae and the presence of chelicerae, pedipalps, and four pairs of legs. They are normally predaceous, capturing most of their prey alive. The majority of marine forms are found in the upper littoral zone but a few have special adaptations enabling them to remain in habitats which are submerged once or twice a day.

### KEY TO INTERTIDAL ARACHNIDS

- |    |  |                             |
|----|--|-----------------------------|
| 1. | Abdomen broadly joined, tip of abdomen with or without telson  | 2                           |
|    | Abdomen petiolate, constricted at base. Abdomen with spinnerets  | Araneae                     |
| 2. | Telson absent  | 4                           |
|    | Telson present   | 3                           |
| 3. | Telson thread-like, microscopic, 1–2 mm in length  | Palpigradi (Fig. 6.5)       |
|    | Telson stout, terminating in a sting. Large, over 5 mm in length   | Scorpiones (Fig. 6.4)       |
| 4. | Flattened scorpion-like arachnids with long chelate pedipalps. Abdomen segmented, usually 2–5 mm in length           | Pseudoscorpiones (Fig. 6.6) |
|    | Not scorpion-like, sometimes with chelate pedipalps. Abdomen not segmented. Minute, usually less than 2 mm in length | Acari (Fig. 6.7)            |

#### 6.6.1 Order Scorpiones (Scorpions)

Scorpions are characterized by their enlarged chelate pedipalps, the long cauda (tail) terminated by the telson (sting) and the comb-like pectines attached to the ventral surface of the second abdominal segment (Fig. 6.4).

These normally nocturnal arthropods are usually found in rocky and sandy areas under stones and bark or in damp soil or caves. Several species are found in sand dunes along beaches or in the supra littoral zone (Kinzelbach, 1970).

Two diurnal species of *Vejovis* have been collected by Baja California, Mexico, in the intertidal zone. At a gravel (2–5-cm diameter pebbles) beach near Bahia de los Angeles in Baja California Norte, these scorpions have been seen moving at mid-day in and out of the rocks as the tide advanced. Two of the scorpions had isopods in their chelicerae (Roth, unpublished observations). Williams (1971)

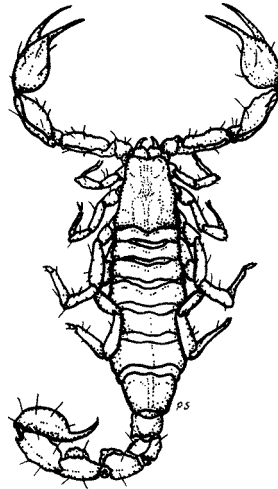

Fig. 6.4. Scorpiones (*Vejovis* sp.)  $\times 2$ .

found tiny scorpions in the high intertidal zone of Isla Danzante where they were stalking small insects in the fresh beach litter. These scorpions were active for about an hour during the hottest part of the afternoon.

Kinzelbach (1970) reviewed the literature on scorpions and provided the following list of seashore species: *Methobuthus confucius* (Simon) from China; *Euscorpius carpathicus* (L.), *E. flavicaudis* (DeGeere) and *Mesobuthus gibbosus* (Brulle) among amphipods under stones from the Mediterranean; and *Microbuthus fagi* (Vachon) under stones among halophile vegetation in West Africa.

#### 6.6.2 Order Palpigradi (*whipscorpions*)

Palpigrades are usually 1–2 mm in length, and characterized by the presence of three very unequal dorsal plates on the prosoma and the long, slender, many jointed flagellum at the tip of the petiolate abdomen (Fig. 6.5). They are extremely rare arachnids living in moist soil or caves. Three intertidal species have been recorded.

*Leptokoenia gerlachi* Conde was collected nearly at the limit of high water at 25 cm depth in the humid sand on Sarso Island in the Red Sea (Conde, 1965). The animals associated with it consisted of turbellarians, nematodes, polychetes, oligochetes, copepods and mites. The other two records were both from Madagascar. A *Eukoenia* sp. was netted from the water of a pit one meter from the sea near the southern tip of the island and an unidentified species was collected from beach sand at Cape Saint Marie.

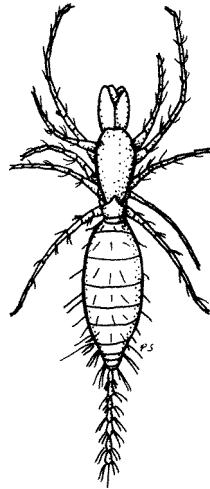

Fig. 6.5. Palpigradi  $\times 32$ .

### 6.6.3 Order Pseudoscorpiones

Pseudoscorpions are small flattened scorpion-like arachnids usually less than 5 mm long, characterized by their large chelate pedipalps and the absence of a telson (tail) (Fig. 6.6). They are found under rocks, in crevices in the littoral zone,

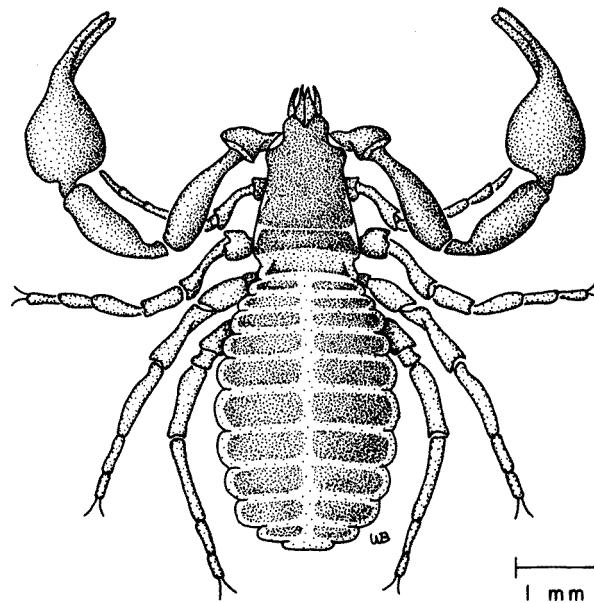

Fig. 6.6. Pseudoscorpiones (*Garypus sini* (Chamberlin)).

or under wrack and debris on the sandy shores and prey on small arthropods. Littoral pseudoscorpions of the Gulf of California have been reviewed by Lee (1972).

Representatives of eight families are found in the intertidal zone.

**CHELIFERIDAE:** One species *Dactylochelifer latereillei* (Leach) was found often at the base of tufts of the algae *Amophila* in Europe, Berland (1932).

**CHIERIDIIDAE:** *Apocheiridium pelagicum* (Redikorzev) has been collected in the littoral zone of Indo China from the Gulf of Siam to the Gulf of Tonkin. The first specimens were collected in plankton nets 200 miles at sea, hence the name *pelagicum* Dawydoff (1940) suggested that these specimens were transported by marine birds. They were later found living in reefs constantly submerged by the sea and some specimens were also collected from the interstices of a block of submerged *Padina*, a slightly calcareous alga.

**CHERNETIDAE:** *Epactiochernes tumidus* (Banks) is found on the coast of North Carolina and Florida along the drift line, just above the normal high tide line but may be submerged daily (Weygoldt, 1969; Muchmore, 1974). *E. tristis* (Banks) appears to be the northern form and is found on beaches from New York to Massachusetts (Muchmore, 1974).

*Dinocheirus carminis* (Chamberlin) is known from islands in the Gulf of California where it was collected from under wrack, stones and debris along rocky beaches (Chamberlin, 1923) and from the underside of algae-covered boulders in the lower intertidal zone.

*Parachernes litoralis* (Muchmore) was collected from the coast of North Carolina above the normal high tide line among driftwood (Weygoldt, 1969).

*Pselaphochernes litoralis* (Beier), known from the shores of the Adriatic Sea, is able to survive immersion in sea water for several days (Weygoldt, 1969).

**CHTHONIIDAE:** *Chthonius tetrachelatus* (Preyss), a common British species, was found enclosed in a silken cell on the undersurface of a rock on mud flats at the mouth of Wooten Creek. This locality is covered about seven times a month by high tides (Bristowe, 1923).

*Morikawia johnstoni* (Chamberlin) is found on islands in the Gulf of California under rocks regularly inundated by the sea (Lee, 1972).

*Paraliochthonius* is known from islands and ocean shores of the Mediterranean, West Indies, Mexico and the Pacific Ocean. While most species are recorded from islands there is little to indicate they are littoral except for the following three species: *P. puertoricensis* (Muchmore) taken from damp wrack on the beach of St. Croix, Virgin Islands (Muchmore, personal communication), *P. singularis* (Menozzi) from littoral zones of the Western Mediterranean (Muchmore, 1972),

and *P. takashimai* (Morikawa) collected under stones flooded at high tide in Japan (Morikawa, 1958; Muchmore, 1972).

**GARYPIDAE:** Some of the largest species of pseudoscorpions belong to *Garypus*, a genus well-represented in the intertidal zones. They occur along the Mediterranean Sea, in the West Indies, on the coasts of Florida, California, western Mexico and Japan, and are probably found on all tropical and subtropical shores.

*G. beauvoisi* (Savigny) (*G. litoralis* (L.) Koch) was found on the beaches of the Mediterranean Sea (Vachon, 1968) and under rocks and wrack constantly submerged by the sea (Berland, 1932).

*G. japonicus* (Beier) was reported as a seashore inhabitant in Japan (Morikawa, 1958, 1962).

*G. californicus* (Banks) was reported by Evans (1968) from California under stones and in cracks of rocks in the intertidal zone. It is also known from a sandy beach under dried kelp (Chamberlin, 1930).

*G. floridensis* (Banks) was reported from under driftwood on the ocean beach in Florida (Chamberlin, 1921).

*G. sini* (Chamberlin) and *G. pallidus* (Chamberlin) were collected together from islands in the Gulf of California where they occur under stones along rocky or sandy beaches in dome- or thimble-shaped nests made from silk and sand grains attached to the underside of stones or drift (Chamberlin, 1923). A third undescribed species was collected from the Gulf of California (Lee, 1972).

*Geogarypus nigrimanus* (Simon) was found in the littoral zone of the Mediterranean Sea (Berland, 1932) and *G. micronesiensis* (Morikawa) was listed as a seashore inhabitant of Micronesia (Morikawa, 1962).

**MENTHIDAE:** *Menthus lindahli* (Chamberlin) was collected from under stones along a rocky beach in Sonora but it doesn't appear to be confined to this habitat (Lee, 1972).

**NEOBISIIDAE:** *Halobisium occidentale* (Beier) from the California coast, lives in the spray zone just above high tide (Weygoldt, 1969), under boards, and logs in company with isopods, amphipods and marine worms (Chamberlin, 1930). *H. orientale* (Redikorzev) of Japan is listed as a seashore inhabitant (Morikawa, 1962).

*Neobisium maritimum* (Leach) from the British Isles and France is one of the best known marine pseudoscorpions. It is present in the outer region of deep crevices from the level of spring tide to the bottom of the *Fucus*—*Ascophyllum* zone (Gabbutt, 1962). It is known to feed on collembola (Glynne-Williams and Hobart, 1952). Silken nests are made within the crevices which hold bubbles of air when submerged (Gabbutt, 1966).

*Obisium submersum* (Bristowe) was collected in Singapore and an adjacent island, Palau Renggis from under stones below the tide level (Bristowe, 1931).



**OPIIDAE:** Two beach-dwelling species are reported from the Gulf of California. *Serianus litoralis* (Chamberlin), from under a stone beach on Monserrate Island and *S. serianus* (Chamberlin) from a beach at Cerralvo Island (Chamberlin, 1923, 1930). Two other species of this family, *Nipponorgarypus enoshimaensis* (Morikawa) and *Xenolpium oceanicum palauense* (Beier), are reported as seashore inhabitants from Japan (Morikawa, 1962).

#### 6.6.4 Order Acari (mites, ticks)

The order Acari contains a diverse assemblage of species not easily characterized. Essentially the marine and intertidal mites are small, ranging from 0.1—2.0 mm in length. The abdomen is unsegmented, lacking a postabdomen. The chelicerae are usually chelate or piercing and 2- or 3-segmented. They are similar to some members of the order Phalangida but the latter usually have a segmented abdomen.

Baker and Wharton's (1952) classification of mites is followed for the most part and the reader is referred to this book as well as to Krantz (1970) for detailed characteristics of the various families discussed.

Mites occupy a large variety of niches in the intertidal zone throughout the world. Some are parasites in or on marine vertebrates and invertebrates, others are scavengers, herbivores or predators. They are found throughout the intertidal zone in the interstices of beach sand, in the wrack on the drift line, on algae-covered rock, or even free-living. A complete review of the intertidal species and genera is not attempted here. Only those which live in the intertidal habitats that are submerged at least daily will be discussed.

**ACARIDAE:** *Caloglyphus* sp. has been collected at night from granite among barnacles at the supralittoral fringe on the Sonoran coast of Mexico.

*Pontoppidania littoralis* (Halbert) was collected from shingle beaches in Ireland in moist decaying seaweed slightly above the high tide mark.

One unidentified hypopus (a nymphal stage) has been taken from the gill of a mollusc (Baker and Wharton, 1952).

**AMERONOTHRIDAE:** *Ameronothrus marinus* (Banks) was found on the Atlantic coasts of New York and France on rocks in the intertidal zone, although it is usually restricted to estuaries and harbors where there is little wave action (Baker and Wharton, 1952). *A. bilineatus* (Mich.) and *A. spoofi* (Oudms.), both algivorous species restricted to littoral or estuarine situations are known from England (Evans et al., 1961).

**ANOETIDAE:** The hypopus of *Myianoetus* sp. is common on the tethinid fly, *Tethina spinulosa* Cole, found in the wrack of the Gulf of California shores.

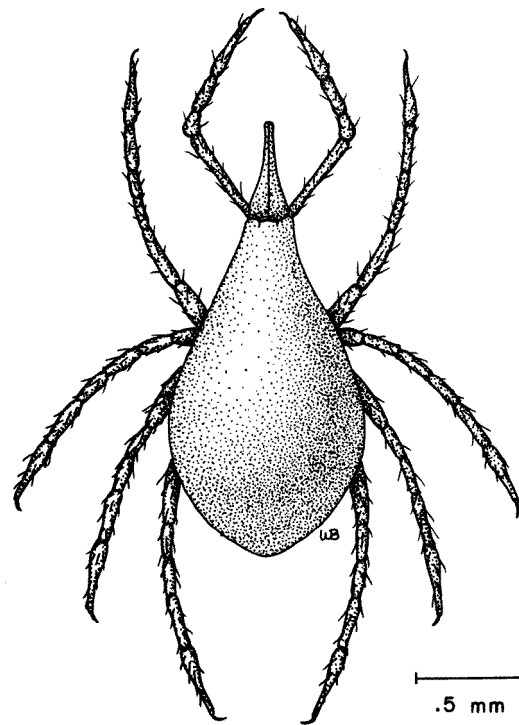

Fig. 6.7. Bdellidae, *Neomoligus littoralis* (L.).

**BDELLIDAE:** *Neomoligus littoralis* (L.) is one of the best known and most widely distributed of the intertidal mites. This relatively large (2.0 mm) bright red mite (Fig. 6.7) is characterized by the bulbous, thin-skinned body and long tapering chelicerae. It wanders, both day and night, on damp rocky shores and algae-covered boulders (Fig. 6.8) which may be covered twice daily in the Gulf of California. It has been seen attacking and feeding upon dipterous larvae and an oligochete worm (Evans et al., 1961).

**EUPODIDAE:** *Hylotydeus hydrodromus* (Berlesae and Trouessart) of the British Isles was collected from intertidal crevices where it is known to feed upon other mites (Glynne-Williams and Hobart, 1952; Kensler and Crisp, 1965). *Eupodes halophilus* (Halbert) is restricted to the lower intertidal zone in England (Evans et al., 1961). Another small (0.5 mm) greenish jumping mite, *Eupodes* sp., was collected off algae-covered rocks and in seaweed drifts on the Gulf of California.

**EVIPHIDIDAE:** *Thinoseius ramsayi* (Evans), *T. fucicola* (Halbert) and *T. spinosus* (Willmann) inhabit decaying seaweed and other tidal debris above the high water mark on rocky sea coasts in Europe. Other species are known from the Red Sea and New Zealand. *Thinoseius* sp., (Fig. 6.9) is common on the abdomen



Fig. 6.8. Habitat of bdellid, trombidid and teneriffid mites, and the spiders *Paratheuma interaesta* (Roth and Brown) and *Dictyna mineata* (Banks) found among the barnacles *Tetraclita squamosa* (Brugière) on the coast of Sonora on the Gulf of California.

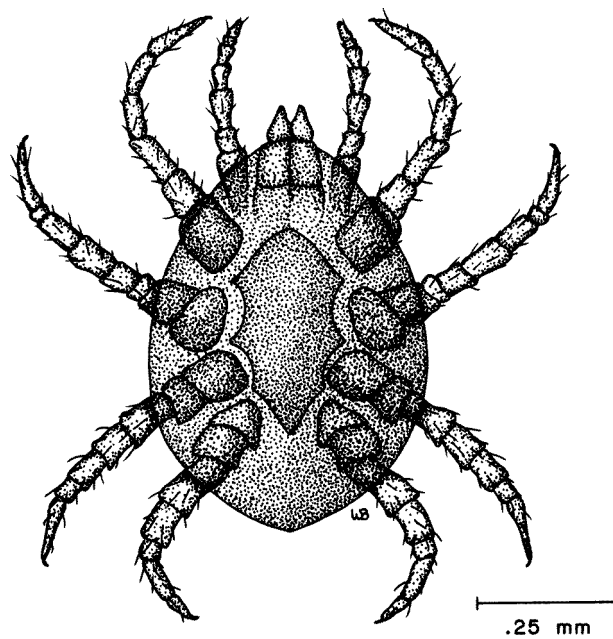

Fig. 6.9. Eviphididae, *Thinoseius* sp.

of anthomyid flies, *Fucellia tergina* (Zett.) on the shores of the Gulf of California. *T. brevisternalis* (Canaris), the Pacific kelp mite from the Pacific coast, has been found in all stages on partially decayed kelp (Volkinburg, 1969). The deutonymphs and rarely the adults are phoretic on amphipods of the genus *Orchestoidea* which they utilize for dispersal (Evans, 1969).

**EWINGIDAE:** Yunker (1970) records several species from salt water crabs of the genus *Coenobita*. Among them are: *Ewingia coenobitae* (Pearce) known from Florida, *Hoogstraalacarus tiwiensis* (Yunker) and *Askinasia aethiopicus* (Yunker) from Kenya, *A. sinusaribia* (Yunker) from Egypt and an undescribed species from Eustatius Islands, Carribean Sea (Evans et al., 1961).

**HALOLAE LAPIDAE:** *Halolaelaps marinus* (Brady) is restricted to the lower intertidal zone, below the *Fucus spiralis* zone, where it was collected beneath stones. *H. celticus* (Halbert) and *H. incisus* (Hyatt), also from the British Isles, are found in decaying wrack.

**HALACARIDAE:** This world-wide family with over 300 species contains the largest number of marine mites. Most are free-living, predators, or herbivores but a few are parasitic on marine invertebrates. They are found in a wide variety of habitats from sandy shores in the intertidal zone to depths exceeding 4000 metres in the oceans. The family Halacaridae is composed of the following seven subfamilies: (1) Halacarinae, a cosmopolitan group of mainly marine predators, is found from sandy beaches to abyssal depths. One species, *Halacarus anomalus* (Trouessart) (Chandrasekhara, 1970), has been collected from intertidal sands on the Indian coast; (2) Lohmanellinae, an almost cosmopolitan group, contains predaceous species; (3) Atacarinae is an arenicolous group found in the interstices of intertidal sands from many parts of the world including the North Sea, Alaska, Oregon and Mexico (Newell, 1951; Krantz, 1971); e.g. *Atacarus giganteus* (Krantz) from the Carribean coast of Quintana Roo, Mexico and *A. pygmaeus* (Schultz) from the Gulf of Kiel (Krantz, 1971); (4) Rhombognathinae is a cosmopolitan subfamily of mainly intertidal algivorous mites; (5) Simognathinae consists of marine forms, some predaceous, in widely scattered parts of the world; (6) Halixodinae contains one species, *Halixodes chitonis* (Brucker), a parasite of the mollusc *Amphineura* in New Zealand; and (7) Enterohalacarinae, represented by one species, *Enterohalacarus minutipalpus* (Viets.), an internal parasite collected from sea urchins in the Western Pacific.

Newell (1951) reported 29 species of marine mites of this family from Alaskan waters of which 19 belong to the genus *Copidognathus*. These were collected from mussels (*Mytilus*), barnacles (*Balanus*), calcareous algae, red algae, and sand and gravel down to about 700 metres. Other genera found in similar habitats include *Rhombognathus* and *Isobactrus*.

Krantz (1973) found more than 30 species of halacarid mites in *Mytilus* beds along the Oregon Coast, including four predatory species, *Agauopsis curvata* (Krantz), *A. newelli* (Krantz), *Halacarus magniporus* (Krantz) and *Thalassarachna raphidochela* (Krantz).

**HALARACHNIDAE:** Parasitic mites of the genus *Halarachne* infest the nasal passages of sea otters and earless seals and species of *Orthohalarachne* are known to infest eared seals and walrus (Kenyon et al., 1965).

**HYADESIDAE:** Species are known from tide pools, submerged algae and mussel beds in coastal Europe and the Americas. One species was collected from submerged coralline algae on the Caribbean coast of Mexico (Krantz, 1970). *Hyadesia fusca* (Lohmann) has been collected at the edges of rock crevices in the *Pelvetia* and *Spiralis/Fucus* zones and in rock pools containing *Enteromorpha* in the Orange Lichen zone in the North and Baltic Seas. One species is also found in mussel beds (*Mytilus californianus* (Conrad)) on the Oregon Coast (Krantz, personal communication). *Hyadesia* sp. is found among algae on reefs in the Gulf of California (Roth, unpublished).

**LAELAPIDAE:** These mites are usually parasitic on invertebrate hosts. *Aspidilaelaps* sp. (Krantz, 1970) and *Andregamasus* (Costa, 1965) are associated with hermit crabs in tropical regions. An unidentified species has been collected from under seaweed washed ashore on the Gulf of California.

**NANORCHESTIDAE:** *Nanorchestes amphibius* (Topsent and Trouessart) was found in minute cracks on rocks in the intertidal region in Europe. Specimens which may be this species have been found on the Oregon coast under similar conditions (Krantz, 1970).

**PACHYGNATHIDAE:** Krantz (1970) reported that species are known from the littoral zone but did not list them. One small (0.65 mm) whitish, slow-moving mite of this family was collected from the underside of boulders on rock shelves among chitons and sea cucumbers and on algae-covered pitted rhyolite in the Gulf of California.

**PARASITIDAE:** *Eugamasus inmanis* (Berl.) was collected from tidal drift in the British Isles where it was seen to feed voraciously on small oligochete worms. *Parasiticus kembersi* (Oudsm.) from the same region is a common inhabitant of decaying wrack (Evans et al., 1961).

**UROPODIDAE:** *Phaulodinychus minor* (Halbert) and *P. orchestridarum* (Barrois) are inhabitants of decaying wrack in the British Isles (Evans et al., 1961). *P. mitis*

(Leonardi) was found in a variety of intertidal habitats on the northwest Adriatic coast (Krantz, 1974).

**PONTARACHNIDAE:** *Pontarachna halei* (Womersley) was reported from South Australian littoral zones (Womersley, 1937). Several species of *Pontarachna* occur in marine waters off California, Japan, Formosa, South Africa and Europe. *Paralitarachna degiustii* (Cook) was collected in littoral waters surrounding Bimini, West Indies (Cook, 1974). *Litarachna denhami* (Womersley) was reported from Western Australian littoral zones (Womersley, 1937) and other species are known from coastal North Africa, Europe, Greenland and Japan.

**RHODACARIDAE:** *Hydrogamasus littoralis* (G. and R. Canestrini) was collected from crevices in the intertidal zone in Wales where it feeds on collembola (Glynne-Williams and Hobart, 1952). A similar undescribed species (Fig. 6.10) has been found in large numbers under granitic boulders and on algae-covered rocks in the Gulf of California in company with chitons, sea cucumbers and starfish.

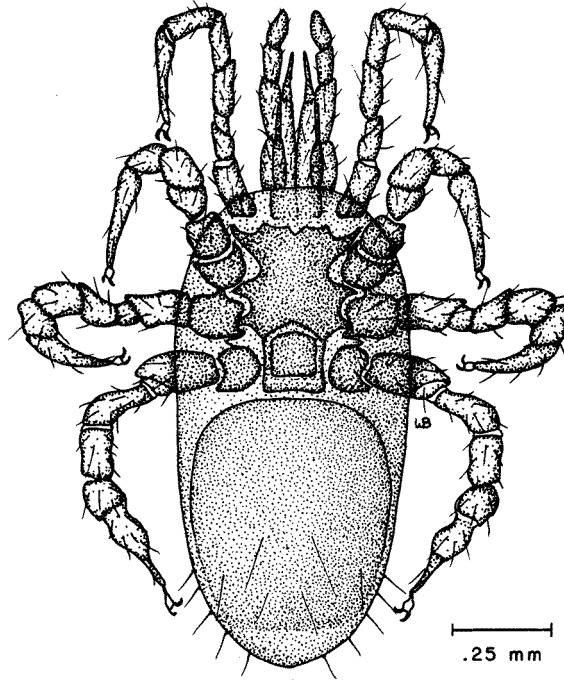

Fig. 6.10. Rhodacaridae, *Hydrogamasus* sp.

**TENERIFFIIDAE:** Teneriffids have been reported from intertidal sand banks (Krantz, 1970) and submerged rocks. *Teneriffia marina* (Hirst) was collected in

Malaya from under rocks which were submerged twice a day under as much as 1.5–2 m of water (Hirst, 1926). *T. quadripapillata* (Thorell) was collected on the beach of Teneriffe (McDaniel et al., 1975). Another undescribed species (Fig. 6.11) of this genus was collected in the Gulf of California. It is a red to orange—yellow spiny mite about 1.0 mm in length, slightly longer than wide. It occurs abundantly on damp sand, damp to dry boulders among barnacles in the splash zone and on algae-covered pitted rhyolite.

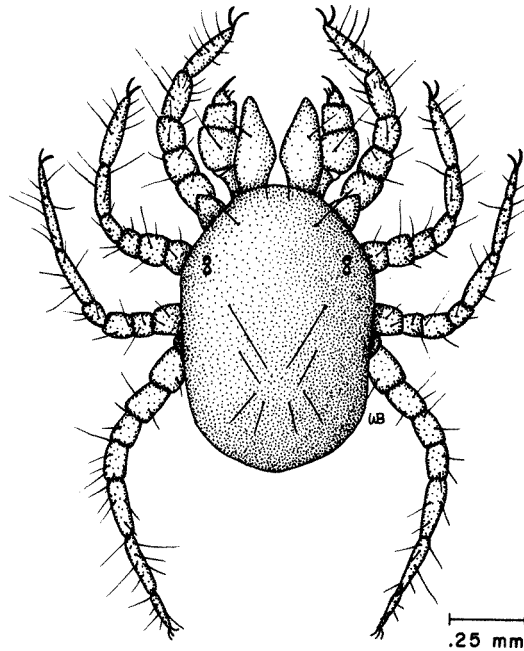

Fig. 6.11. Teneriffiidae, *Teneriffia* sp.

**TROMBICULIDAE:** Members of the genus *Vatacarus* are found in the nasal fossae, trachea and lungs of marine iguanas and sea snakes in the South Pacific. One species of the terrestrial genus *Eutrombicula*, *E. poppi* (Vercammen-Grandjean) has been found on a sea snake (*Platurus* sp.) in the Malaysian Seas (Vercammen-Grandjean, 1971).

**ERYTHRAEIDAE:** A large (1.6 mm) unidentified red mite (Fig. 6.12) belonging to this family is often seen moving actively over wet rocks at low tide and on algae-covered pitted rhyolite in the Gulf of California. Like other members of the family, it is covered with a velvet-like vestiture and is distinguished by having extrusible chelicerae, a palpal thumb-claw, and dilated tarsi on legs I. The larvae of various members of this family are known to parasitize arthropods.

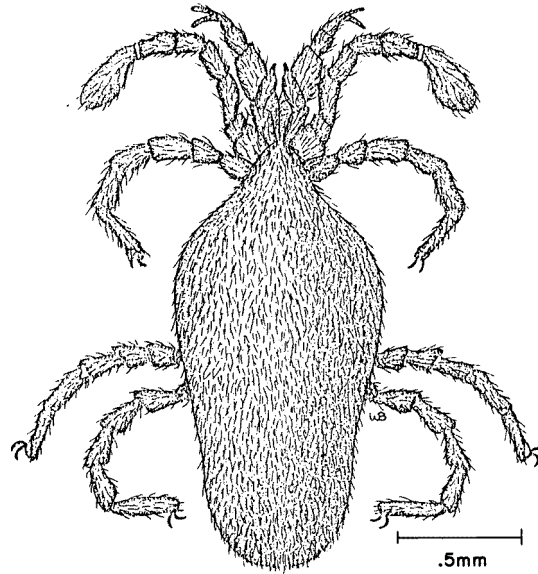

Fig. 6.12. Erythraeidae.

**VEIGAIIDA:** *Cyrtirolaelaps hirtus* (Berlese) was collected from intertidal crevices in Wales (Glynne-Williams and Hobart, 1952; Kensler and Crisp, 1965). An undescribed species of *Veigeia* (*Veigaia*) was found in and around the nests of the South African marine spiders *Desis* and *Amaurobioides* (Lamor, 1968).

#### 6.6.5 Order Araneae (spiders)

Spiders can be separated from all other arachnids by their petiolate, unsegmented abdomen, abdominal spinnerets, and the modification of the male palpi into sperm transfer organs. They have a world-wide distribution and inhabit a wide variety of habitats: soil, leaf litter, shrubs, trees, caves, swamps, edges of streams and ponds, or even below the surface of the water.

All spiders are predators, feeding mainly on terrestrial arthropods but a few of the larger species will feed on vertebrates such as small birds and reptiles and some aquatic pisaurids will capture fish, tadpoles and frogs (Bristowe, 1930). The few records on prey of intertidal spiders include insects of the intertidal zone, isopods, amphipods and other spiders.

Many spiders are adapted for life in the intertidal zone but surprisingly few have taken advantage of this habitat. There are many which live among halophilic plants and can withstand occasional submersion. Experiments and observations conducted by various researchers (Arndt, 1915; Bristowe, 1923; review by Cloudsley-Thompson, 1948; Roth, unpublished) show that many terrestrial



species never subjected to submergence can remain in air bubbles under water for more than 24 hours.

Intertidal spiders consist mainly of species which live in the upper intertidal and the supralittoral zones or among halophilic plants in saltmarshes where there is an abundance of animal life. A few live in the wrack or in the lower intertidal.

There are many references or implications in the literature to marine or intertidal spiders based upon misidentifications or erroneous interpretations. These include a mis-identified *Desis* (Zodariidae) (Butler, 1927) as well as *Cambridgea*, *Gohia*, *Cedicus*, *Pacificana*, *Huara* and *Swainsia*. Only the last genus is found in beach debris, the others are all terrestrial, found away from the beaches. Forster and Wilton (1973) list many terrestrial species whose range sometimes extends to the upper intertidal zone on New Zealand beaches.

The conservative classification of Petrunkevitch (1939) is followed for simplicity. The ecribellate genera *Litisedes* and *Mizaga*, placed in Dictynidae by Lehtinen (1968), are being treated here in the Agelenidae and the cribellate genus *Oramia* is left in the Dictynidae rather than in Agelenidae as proposed by Forster and Wilton (1973).

### KEY TO FAMILIES OF LITTORAL SPIDERS\*

- |     |   |  |
|-----|---|--|
| 1.  | Chelicerae diaxial, fangs opposing each other (Fig. 6.13) (some species with projecting chelicerae, <i>Desis</i> , <i>Gohia</i> , <i>Amaurobioides</i> and <i>Gasparia</i> with almost parallel fangs), two book lungs. Eyes in two or three rows | 2  |
|     | Chelicerae paraxial, fangs parallel (Fig. 6.14). Eyes compactly arranged on a low tubercle. Four book lungs   | Barychelidae   |
| 2.  | Spinnerets loosely or compactly arranged (Figs. 6.15 and 6.17)  | 3  |
|     | Spinnerets in a transverse row (Fig. 6.16)  | Hahniidae  |
| 3.  | Eyes in 3 rows (Figs. 6.19 and 6.20)  | 4  |
|     | Eyes in 2 rows (Fig. 6.21)  | 5  |
| 4.  | Anterior median eyes very large, posterior median eyes small  | Salticidae   |
|     | All anterior median eyes small, similar in size. Posterior eyes large, on anterior portion of carapace  | Lycosidae  |
| 5.  | Cribellum and calamistrum absent  | 6  |
|     | Cribellum and calamistrum present (Figs. 6.22 and 6.23)   | Dictynidae   |
| 6.  | Tarsi with three claws, no claw tufts, not scopulate  | 7  |
|     | Tarsi with two claws, claw tufts present, scopulate in many species   | 8  |
| 7.  | Tarsi with one (Fig. 6.24) or two rows of trichobothria, stout-legged spiders   | 9  |
|     | Tarsi lacking trichobothria. Thin-legged spiders  | Linyphiidae  |
| 8.  | Tarsi with one row of trichobothria   | Agelenidae, Europe and Japan<br>Desidae (in part, <i>Paratheuma</i> and <i>Myroninae</i> ), Gulf of California and New Zealand |
|     | Tarsi with two rows of irregularly arranged trichobothria   | Desidae  |
| 9.  | Posterior spinnerets compactly arranged (Fig. 6.15)   | 10   |
|     | Posterior spinnerets widely separated (Fig. 6.18)   | Gnaphosidae  |
| 10. | Tracheal spiracle at base of spinnerets   | Clubionidae  |
|     | Tracheal spiracle far anterior to spinnerets  | Anyphaenidae   |

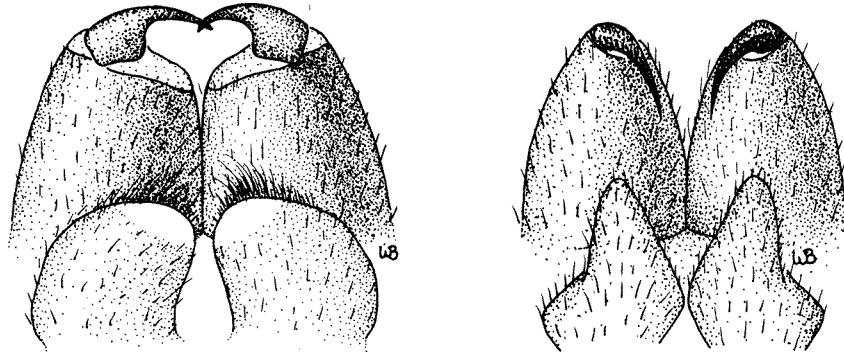

Fig. 6.13. Daxial chelicerae of *Zelotes synthetica* Chamberlin.

Fig. 6.14. Paraxial chelicerae.

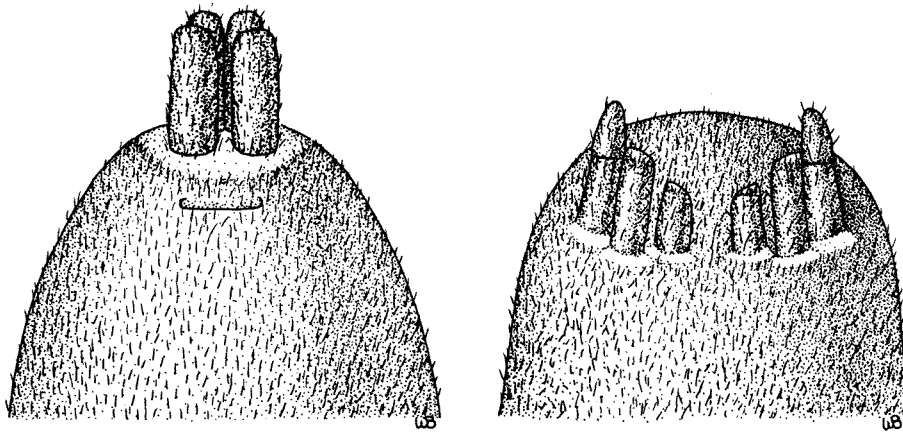

Fig. 6.15. Compactly arranged spinnerets of Clubionidae showing tracheal spiracle.

Fig. 6.16. Transversely arranged spinnerets (Hahnidae).

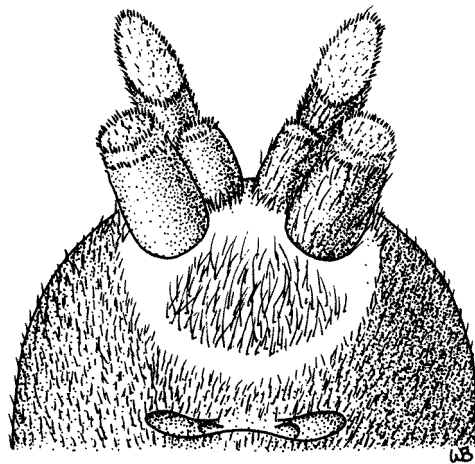

Fig. 6.17. Loosely arranged spinnerets of *Paratheuma* (Desidae).

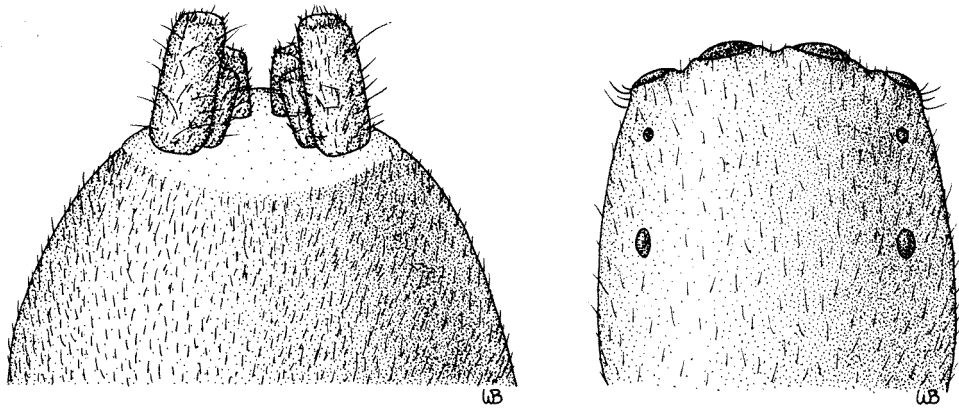

Fig. 6.18. Loosely arranged spinnerets of Gnaphosidae.

Fig. 6.19. Eyes in 3 rows (Salticidae).

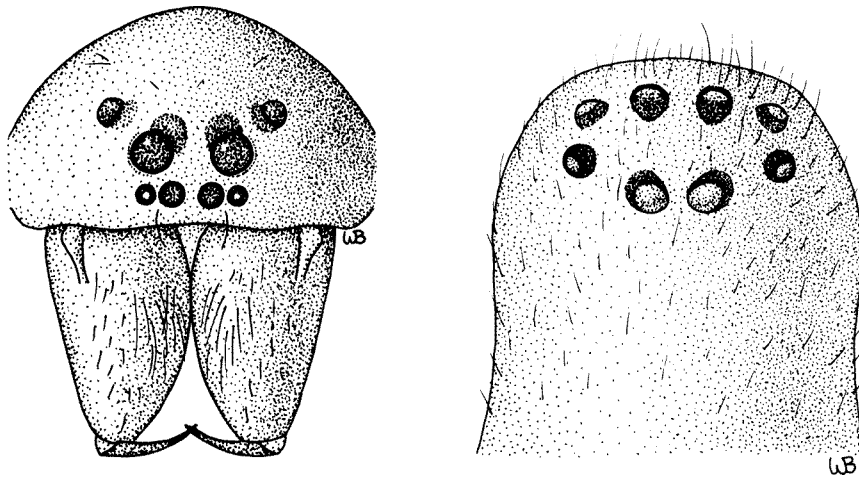

Fig. 6.20. Eyes in 3 rows (Lycosidae).

Fig. 6.21. Eyes in 2 rows (Gnaphosidae).

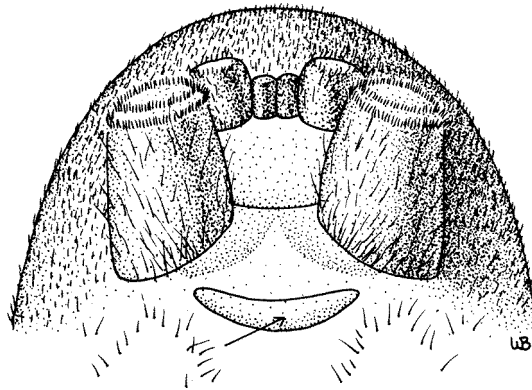

Fig. 6.22. Cribellum of *Dictyna mineata* (Banks).

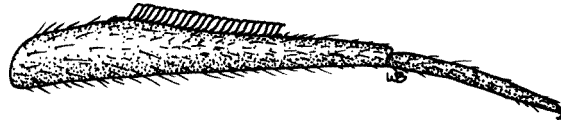

Fig. 6.23. Calamistrum on metatarsus IV of *Dictyna mineata*.



Fig. 6.24. Tarsal trichobothria in a single row (Agelenidae).

### *Family Barychelidae (trap-door spiders)*

The Barychelidae contains the only representatives of mygalomorph spiders found in the intertidal zone. They can be separated from all other spiders by the compactly arranged eyes, four book lungs, claw tufts and a rastellum (comb of stout setae) on the chelicera. Representatives of the family are known to make trap doors at the entrance to their burrows in the soil.

*Neodipolothele picta* (Vellard) was first collected on the beach at Icarahy, Brazil. Mello Leitão (1928) reported this spider in orifices of submerged rocks which were exposed only when the tide was out. It probably fed upon amphipods and isopods found in the same habitat. No mention was made of a trap door.

*Idioctis littoralis* (Abraham) was described from Malayan mangrove swamps which were covered daily at high tide. The spider lives in a burrow closed by an air-tight door and feeds on polychetes (Abraham, 1924). It was later reported from holes lined with web in rocks below the surface at high tide (Abraham, 1926).

### *Family Dictynidae*

Dictynids are small cribellate spiders found on vegetation, in leaf litter, occasionally under stones and debris on the ground, in cracks of bark on trees or rock. They are the only cribellates found in the intertidal and can be separated from all other littoral spiders by the presence of a cribellum and a calamistrum.

*Dictyna mineata* (Banks) is the commonest spider on the rocky shores of the Sonoran coast of the Gulf of California. It uses empty barnacle (*Tetraclita*) shells on vertical or almost vertical surfaces and occasionally crevices in the rocks as retreats. The spider places its cocoon in the upper half of the barnacle shell. At night or when the retreat is not submerged it emerges and spins a ladder-like web (Fig. 6.25) from the mouth of the opening to any adjacent rock 15–20 cm away with guide lines extending outward criss-crossed with supporting webs. It is often seen feeding on dolichopodids which are common on damp wave-washed rocks.

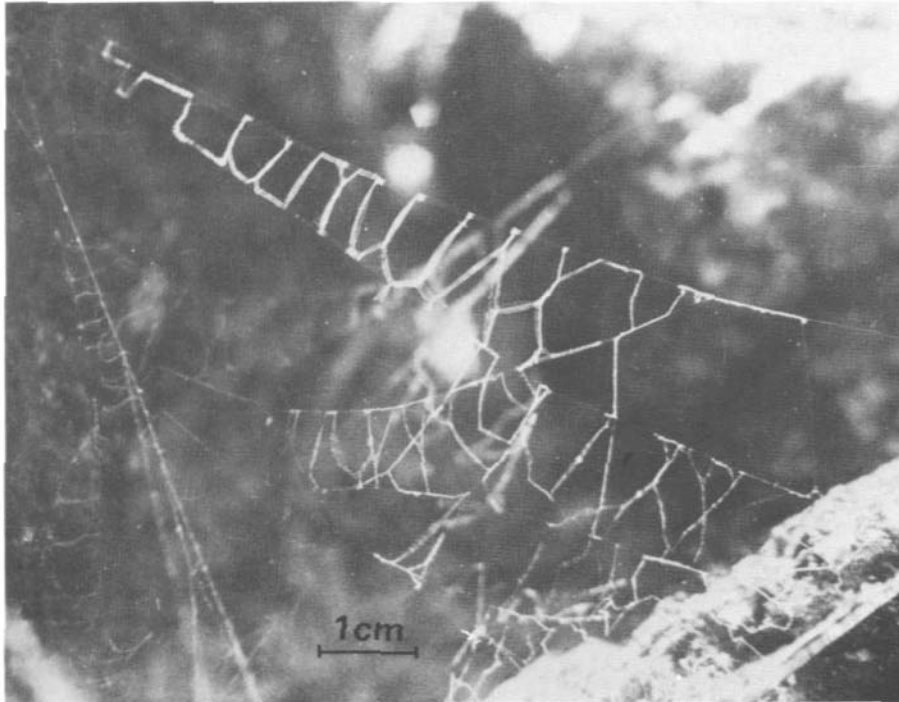

Fig. 6.25. Web of *Dictyna mineata* (Banks) (200 mm long).

*Oramia* is known from New Zealand and adjacent islands and contains both terrestrial and littoral spiders with some species found in both habitats (e.g. *O. crucifera* (Hogg)). Forster and Wilton (1973) found most species living in the spray zone on shingle beaches where they construct small snares amongst stones, and appear to feed mainly upon amphipods and kelp flies. The following littoral species are known:

*O. chathamensis* (Simon), New Zealand and Chatham Island, in kelp beds at the high water mark; *O. crucifera* (Hogg), Auckland Island; *O. littoralis* (Forster and Wilton), Dunedin, Otago; *O. marplei* (Forster), Auckland Island; *O. occidentalia* (Marples), Whero Island, Foveaux Strait; *O. rubrioides* (Hogg), Snares Island; *O. solanderensis* (Forster and Wilton), Solander Island.

#### *Family Linyphiidae (Micryphantidae, Erigonidae)*

The Linyphiidae are not easily characterized but can be separated from other three-clawed littoral spiders by their small size, slender legs and absence of tarsal trichobothria. Most are minute, only a few millimetres in length and found in damp leaf litter, loose soil, under rocks often adjacent to streams and in thick vegetation of marshes and swamps.

*Anacotyle setoensis* (Oi) was collected among gravel near flood tide level on the seashore in Japan (Oi, 1960).

*Cnephalocotes curtis* (Simon) and *Oedothorax fucus* (Blackwall) have been reported by Bristowe (1923) from England among halophytic plants and during high tide they shelter in crannies or cracks under stones where air is trapped.

*Erigone arctica* (White) and *E. longipalpis* (Sundevall) are occasionally found together on tidal estuaries of England and Europe. *E. arctica* is also found on the seashore among stones and seaweed (Locket and Millidge, 1953). Nielson (1932) found these spiders actively running in the morning or spinning their small snares close to stones, seaweed, or beneath stones lying close to the water in Sweden. The cocoons of *E. arctica* are deposited in large colonies in cavities on the lower side of stones. An undescribed species of *Erigone* (Fig. 6.26) was collected in air pockets under large boulders among chitons and sea cucumbers (Roth, unpublished).

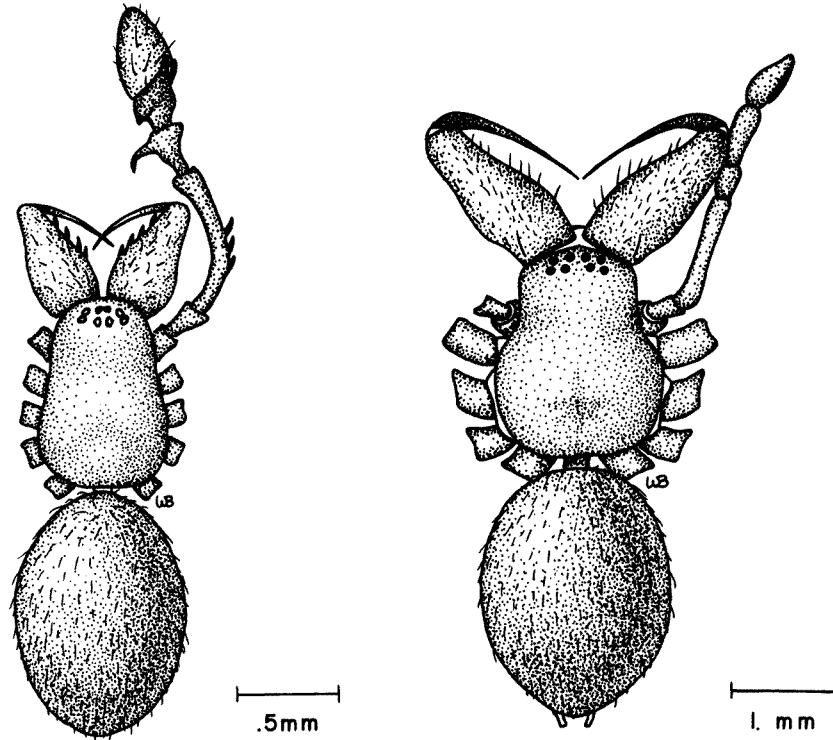

Fig. 6.26. *Erigone* sp. (Linyphidae), male.

Fig. 6.27. *Paratheuma interaesta* (Roth and Brown), male.

*Erigonopsis littoralis* (Hewitt) was reported from the interspaces of calcareous masses built by marine annelids in South Africa (Hewitt, 1915; Bristowe, 1930; Lamoral, 1968).

*Grammonota trivittata* (Banks) is known in saltmarshes from Georgia to Maine. It prefers marshes that are wet at all stages of the tide (Emerton, 1911). When the tide comes in it either retreats towards the tip of the *Spartina* blade, or remains under the pit found between the stem and the base of the blade.

*Halorates reprobis* (O. Pickard-Cambridge) was reported from England by Bristowe (1923) in sheltered crannies or under stones where air was trapped and also in France in *Fucus* which was submerged at high tide (Berland, 1924).

*Mynoglenes marrineri* (Hogg) and *M. insolens* (Simon) are relatively large linyphiids described from Auckland and Campbell Islands south of New Zealand. They were both found on the beach under kelp and stones at high water mark (Forster and Forster, 1973).

#### *Family Agelenidae (funnel-web spiders)*

Agelenids are cribellate, three-clawed spiders, lacking notched trochanters, with compactly grouped spinnerets and several tarsal trichobothria arranged in a straight row. They lack claw tufts and the tracheal spiracle is located near the spinnerets. Members of this family are best known by the large funnel-webs made by some members. Only two genera are known from the littoral zone.

*Litisedes shirahamaensis* (Oi) was reported from the gravels near the level of flood tide in Japan (Oi, 1960).

*Mizaga racovitzai* (Fage) (Desidiopsis) was recorded from the shores of the Mediterranean Sea and *M. chevreuxi* (Simon) from Dakar, Senegal, Africa (Roth, 1967). Fage (1909, 1925) and Seurat (1924) have found *M. racovitzai* on reefs formed by calcareous algae, *Lithothamnion* and *Lithophyllum*, and clumps of *Corallina* which are constantly beaten by waves and often completely submerged. The spider lives in tubular retreats which are closed by silken webs when submerged by the incoming tide.

#### *Family Desidae*

The family Desidae is very difficult to characterize taxonomically. Its two subfamilies can be easily separated. Desinae contains two genera, both with large chelicerae, which project forward, widely spaced spinnerets and a large colulus, whereas Myroninae has smaller vertical chelicerae, compactly arranged spinnerets and a small colulus.

The genus *Desis* is probably the best known of all marine spiders. Fourteen species have been found in marine habitats from the southwestern Pacific and Indian Oceans north to Japan. They include:

*Desis crosslandi* (Pocock), Zanzibar; *D. formidabilis* (O. Pickard-Cambridge), South Africa; *D. galapagoensis* (Hirst), Galapagos Islands; *D. gardineri* (Pocock), Indo-Malayan region; *D. hartmeyer* (Simon), Southwestern Australia; *D. inermis* (Gravely), Indo-Malayan region, Krusadai and Shingle Islands; *D. japonica*

(Yaginuma), Japan; *D. kenyonae* (Pocock), coast of Victoria, Australia; *D. marinus* (Hector), Chatham Island, New Zealand; *D. martensi* (L.) Koch, Java, Singapore, Con Son Island off Indochina; *D. maxillosa* (Fabr.), Vanikoro Island, Indochina, New Guinea; *D. ribeci* (Berland), New Caledonia, Loyalty Islands; *D. tangana* (Roewer), East Africa; *D. vorax* (L.) Koch, Samoa, Solomon Islands.

Probably a third of the species are synonyms. Further studies are required. The habitats of these spiders include rock crevices and holes made by the rock mussel *Lithodomus* (Robson, 1878), tube masses of the polychaete *Tubicola* (Pocock, 1898) and various shells (*Anomia*, *Patella*, *Amblychilepas*, *Crepicula*, *Diodora*, *Mytilus*, *Oxystele* and *Burnupena*) (Lamoral, 1968). They close their entrance with water-proof silk at high tide when submerged. Robson (1878) claimed that these spiders were active in water, but Workman (1896) and Pocock (1902) found them perfectly helpless when placed in water.

A second genus, *Paratheuma* (*Cortezia*), contains two intertidal species. *P. insulanus* (Banks), known only from females, was collected in Cuba, Haiti and the Bermuda Islands. *P. interaesta* (Roth and Brown) (Fig. 6.27) was collected from the rocky shores of Sonora where it lives at the upper intertidal zone among *Tetraclita squamosa* (Brugière) on vertical rock faces. These nocturnal spiders are active at low tide, dashing rapidly about the larger barnacles and taking refuge when the tide rises in air pockets in empty barnacle shells. They have been seen feeding on intertidal dolichopodids but rejected isopods in the laboratory (Roth and Brown, 1975).

The genera which belong to the subfamily Myroninae are almost all restricted to the beaches but live at or above the high tide zones which are seldom submerged. The following are all recorded by Forster (1970) from New Zealand:

*Gaspiria delli* (Forster); *G. kaiangaroa* (Forster); *G. littoralis* (Forster); *G. nelsonensis* (Forster); *Otago chathamensis* (Forster); *O. nova* (Forster); *O. wiltoni* (Forster).

*Myro marinus* (Goyen) (Habronestes) was found by Goyen (1890) on the under-surface of stones between high and low water mark, being submerged at high tide. It was found to hold a layer of air in the dense pubescence of the ventral abdominal surface during immersion. The cocoon was attached firmly to the underside of stones which remained largely submerged.

### *Family Hahniidae*

Hahniids are characterised by the transverse row of spinnerets (Fig. 6.16) and the advanced abdominal tracheal spiracle. They are usually found in soil and litter where they form tiny sheet webs.

Only one species of Hahniids is found in the intertidal zone, *Muizenbergia abrahami* (Hewitt). It was found at Muizenberg near Cape Town, South Africa in the crevices among calcareous masses built by marine annelids (Hewitt, 1915). They are nocturnal and utilize empty mollusc shells for refuge (Lamoral, 1968).



### *Family Lycosidae (wolf spiders)*

The lycosids are characterized by their very large posterior median eyes (Fig. 6.20), notched trochanters and three-clawed tarsi. Many species of wolf spiders inhabit aquatic and non-saline marshy habitats but a few venture onto the ocean beaches, estuaries and especially saltmarshes. They avoid submergence by moving ahead of the tide (*Arctosa* and *Lycosa* spp.), or hang onto vegetation with a bubble of air (*Pirata* spp.) or remain in their burrows (*Arctosa*).

Intertidal *Arctosa* include *A. littoralis* (Hentz) from Canada, United States and Central America; *A. perita* (Latreille) from Europe and North Africa (Berland, 1924), and an undescribed nocturnal species from the Gulf of Mexico where it was found in 20 cm deep burrows in damp sand, often plugging them with sand when not feeding or during the day. At night they crouch in or several cm away from the entrance of the burrow awaiting potential prey, such as amphipods and tenebrionid beetles (*Phaleria* spp.) (Roth and Brown, unpublished).

*Geolycosa pikei* (Marx) was reported by McCook (1888) from Coffin Beach at Annisquam Mass., where it made burrows very close to the high water mark.

Several species of *Lycosa* are known from the shoreline: *L. arenicola* (O. Pickard-Cambridge) from England (Locket and Millidge, 1951); *L. pullata* (Clerk) also from England (Bristowe, 1931); and *L. purbeckensis* (F.O. Pickard-Cambridge) from mud-flats which are flooded several times a month. Bristowe (1923) noted that this spider could walk down plant stems beneath the surface taking with it a bubble of air caught by means of its hairy body.

*Schizocosa avida* (Walckener), a widespread species in the United States and Canada, is known to forage among wrack (Arndt, 1915).

### *Family Gnaphosidae*

The gnaphosids are characterized by their widely-spaced posterior spinnerets and two-clawed tarsi with claw tufts. The chelicerae are relatively small. They are found in leaf litter and under debris in dry areas. A few have entered the upper edge of the intertidal zone. *Gnaphosa maritima* (Platnick and Shadab) is known from the gravel beaches of Southern California, Northern Baja, California and the west coast of the Gulf of California (Platnick and Shadab, 1975); *G. synthetica* (Chamberlin) is found in abundance under wrack on pebble beaches on the coast of Sonora and the Gulf coast of Baja California Norte, and *Zelotes monachus* (Chamberlin) from sandy beaches of the Gulf shores of Baja California (Chamberlin, 1924). Some immature *Zelotes* have been collected from under wrack in Sonora.

### *Family Clubionidae*

The Clubionids are characterised by their compact spinnerets, the position of the tracheal spiracles near the spinnerets (Fig. 6.15), and the two-clawed tarsi with claw tufts. They are essentially aboreal spiders, wandering about on trees,

shrubs and flowers. A few species are found at the upper edge of the intertidal zone: *Clubiona littoralis* (Banks), from saltmarshes on the Atlantic coast of North America (Arndt, 1915); *Neoanagraphis* sp. from a beach with large pebbles at Los Angeles Bay, Baja California; and *Tixococoba* sp. from under wrack at Punta Tepoca, Sonora.

### *Family Anyphaenidae*

The genus *Amaurobioides* (Amaurobioididae), recently placed in the Anyphaenidae by Platnick (1974), is the only littoral member of the family. They are relatively large spiders (6–10 mm in length) with large projecting chelicera but differ from desids by the presence of only two claws and claw tufts.

They are nocturnal, remaining in their nests in the daytime whether or not they are covered by the tide. At low tide at night they await prey from the nest entrance or roam about searching for prey. Their retreats are lodged mainly in crevices and holes of rock faces, in shells wedged under rocks which contain air spaces when submerged, or among shell grit accumulated between rocks just below the high tide level (Hickman, 1949; Lamoral, 1968; Forster, 1970). Immature specimens have been collected among wet seaweed exposed at low tide (Hewitt, 1917). Their food consist mainly of littoral isopods. Remnants of the isopod *Ligia* have been found in tubes of *A. littoralis* (Hickman).

Various species are known from South Africa (*A. africanus* Hewitt), Tasmania (*A. littoralis* Hickman), New Zealand (*A. maritimus* O. Pickard-Cambridge, *A. minor* Forster, *A. major* Forster, *A. pallidus* Forster, *A. pletus* Forster and *A. poharus* Forster); Stewart Island (*A. picunus* Forster); Campbell Island (*A. piscator* Hogg), and the southern tip of Chile (*A. boydi* Forster).

### *Family Salticidae (jumping spiders)*

The jumping spiders are characterized by very large and conspicuous anterior median eyes (Fig. 6.19). They are an active group of diurnal spiders, occasionally found on the ground, under rocks or in litter but usually on foliage in bright sunlight. A few species live on the rocks along the shores at the upper edge of the intertidal zone and wander out on the intertidal rocks or sand at low tide.

*Clynotis barresi* (Hogg) was reported by Forster (1955) from several localities in New Zealand. It was found on upper intertidal rocks and nests in deep rock crevices.

*Diplocanthopoda marina* (Abraham) was found on the beaches of Singapore (Bristowe, 1931). Abraham (1926) reported it from a rocky bank which was submerged at high tide and found the spider retreated into crevices in the rock enclosing itself in a silken chamber.

*Marpissa marina* (Goyen) (*Marpitusa*) was reported from cliffs and rocks just above, at or just below high water mark by Goyen (1892) in New Zealand. He

also reported another jumping spider (Goyen, 1890) which constructs a protective tube from the same area but was unable to determine the genus or species.

*Metaphidippus* sp. was collected from the wet sandy beaches at Oxnard, California. Specimens were only found on wet sand where they were almost indistinguishable from the sand until they moved.

Species of *Pellenes* are common in the desert but some extend their range to the edges of beaches, e.g. *P. polius* (Chamberlin), *P. ammophilus* (Chamberlin) and two unidentified species, all from the Gulf of California.

## REFERENCES

- Abraham, H.C. (1924) Some Mygalomorph spiders from the Malay Peninsula. Proc. Zool. Soc. Land. 1924, 1091–1124
- Abraham, H.C. (1926) A marine spider of the family Attidae. Proc. Zool. Soc. Land. 1926, 1357–1363.
- Allen, R.K. (1969) Common Intertidal Invertebrates of Southern California. (, ) 170 pp.
- Arndt, C.H. (1915) Some insects of the between tides zone. Proc. Indiana Acad. Sci. 1914, 323–333.
- Bagnall, R.S. (1935a) On *Thalassopauropus remyi* gen. et sp. n. an halophilous Pauropod, and on the genus *Decapauropus* Remy. Scottish Nat. Edinburgh 1935, 79–82.
- Bagnall, R.S. (1935b) Our shore-dwelling Pauropods. Scottish Nat., Edinburgh 1935, 143–145.
- Baker, E.W. and Wharton, G.W. (1952) An Introduction to Acarology (, ).
- Berland, L. (1924) Les Araignées de Tatihou (Manche). Ann. Sci. Nat. Bot. Zool. Ser. 10(7), 335–336.
- Berland, L. (1932) Les Arachnides. Encyclopédie Entomologique. (, .)
- Bristowe, W.S. (1923) A British semi-marine spider. Ann. Mag. Nat. Hist. Ser. (9) 12, 154–156.
- Bristowe, W.S. (1930) Notes on the biology of spiders. II. Aquatic spiders. Ann. Mag. Nat. Hist. Ser. (10) 6, 343–347.
- Bristowe, W.S. (1931) Notes on the biology of spiders. IV. Further notes on aquatic spiders, with a description of a new species of pseudoscorpion from Singapore. Ann. Mag. Nat. Hist. Ser. (10) 8, 457–465.
- Brusca, R.C. (1973) Common Intertidal Invertebrates of the Gulf of California. (, .)
- Butler, S. (1927) A marine spider. Victoria Nat. 44 (7), 175.
- Chamberlin, J.C. (1921) Notes on the genus *Garypus* in North America (Pseudoscorpionida-Cheliferidae). Can. Entomol. 53, 186–191.
- Chamberlin, J.C. (1923) New and little known Pseudoscorpions, principally from the islands and adjacent shores of the Gulf of California. Proc. Calif. Acad. Sci. (4) 12, 353–387.
- Chamberlin, J.C. (1930) A synoptic classification of the false scorpions, etc. Part II. Diplosphyronida. Ann. Mag. Nat. Hist. Soc. (10) 5, 1–48, 585–620.
- Chamberlin, R.V. (1920) The myriopod fauna of Bermuda Islands with notes on variation in *Scutigera*. Ann. Entomol. Soc. Am. 13, 271–285.
- Chamberlin, R.V. (1924) The spider fauna of the shores and islands of the Gulf of California. Proc. Calif. Acad. Sci. (4) 12 (28), 561–694.
- Chamberlin, R.V. (1952) A new geophiloid centipede from the littoral of Southeast Alaska. Proc. Biol. Soc. Wash. 65, 83–84.
- Chamberlin, R.V. (1960) A new marine centipede from the California littoral. Proc. Biol. Soc. Wash. 73, 99–102.
- Chandrasekhara, R.G. (1970) On some interstitial fauna in the marine sands on Indian Coast.

- Part 2. Occurrence of the salt water mite, *Halacarus anocalus* Trouessart in the intertidal sands on Indian coast. *Curr. Sci.* 39, 504–507.
- Cloudsley-Thompson, J.L. (1948) *Hydroschendyla submarina* (Grube) in Yorkshire: with an historical review of the marine Myriapoda. *Naturalist, Lond.* 827, 149–152.
- Cook, D.R. (1974) Water mite genera and subgenera. *Mem. Am. Entomol. Inst.* 21, 1–860, I–VII.
- Conde, B. (1965) Presence de Palpigrades dans le milieu interstitial littoral. *C.R. Acad. Sci. Paris* 261, 1898–1900.
- Costa, M. (1965) *Andregamasus* n. gen., a new genus of mesostigmatic mites associated with terrestrial hermit crabs. *Bull. St. Israel Sea Fish. Res. Stn.* 38, 6–14.
- Crabill, R.E. Jr. (1960) Centipedes of the Smithsonian-Bredin Expeditions to the West Indies. *Proc. US Nat. Mus.*, 3427 (111) 167–195.
- Crossland, C. (1929) Amphibious Centipedes. *Nature* 124, 794.
- Dawydoff, C. (1940) Quelques observations sur la biologie d'un Pseudoscorpion marin d'Indochine, *Apocheiridium pelagicum* Redikorzeff. *C. R. Acad. Sci. Paris* 210, 447–449.
- Eales, N.B. (1961) The Littoral Fauna of the British Isles (, .)
- Eason, E.H. (1964) Centipedes of the British Isles. (, .)
- Emerton, J.H. (1911) New spiders from New England. *Trans. Conn. Acad. Arts Sci.* 16, 385–407.
- Evans, W.G. (1968) Some intertidal insects from Western Mexico. *Pan-Pac. Entomol.* 44, 236–241.
- Evans, G.O. (1969) A new mite of the genus *Thinoseius* Halbert (Gamasina: Eviphidae) from the Chatham Islands, New Zealand. *Acarologia* 11 (3), 505–514.
- Evans, G.O., Sheals, J.G. and McFarlane, D. (1961) The Terrestrial Acari of the British Isles. Vol. 1 (, .)
- Fage, L. (1909) Un nouveau type d'araignée marine en Méditerranée, *Desidiopsis racovitzae* n. g., n. sp. *Arch. Zool. Exp.* 4 (9) 75–84.
- Fage, L. (1925) Remarques sur la distribution géographique des Araignées marines, *Desis, Desidiopsis*. *C. R. Assoc. Fr. Avancement Sci.* 48, 977–982.
- Forster, R.R. (1955) Spiders from the Subantarctic Islands of New Zealand. *Rec. Dominion Mus.* 2 (4) 167–203.
- Forster, R.R. (1970) The spiders of New Zealand, Part III. *Otago Mus. Bull.* 3, 1–184.
- Forster, R.R. and Forster, L.M. (1973) New Zealand Spiders. (, .)
- Forster, R.R. and Wilton, C.L. (1973) The spiders of New Zealand, Part IV. *Otago Mus. Bull.* 4, 1–309.
- Gabbutt, P.D. (1962) Nests of the marine false scorpion. *Nature* 196, 87–89.
- Gabbutt, P.D. (1966) The silken chambers of the marine pseudoscorpion *Neobisium maritimum* (Leach). *J. Zool. Soc. Lond.* 149, 337–343.
- Glynne-Williams, J. and Hobart, J. (1952) Studies on the crevice fauna of a selected shore in Anglesey. *Proc. Zool. Soc. Lond.* 122, 797–824.
- Gosner, K.L. (1971) Guides to Identification of Marine and Estuarine Invertebrates. (, .)
- Goyen, P. (1890) Descriptions of new species of New Zealand Araneae, with notes on their habits. *Trans. NZ Inst.* 22, 267–273.
- Goyen, P. (1892) On New Zealand Araneae. *Trans. NZ Inst.* 24, 253–257.
- Hennings, C. (1903) Zur Biologie der Myriopoden. I. Marine Myriopoden. *Biol. Zentralbl.* 23, 720–725.
- Hewitt, J. (1915) New South African Arachnida. *Ann. Natal Mus.* 3, 289–327.
- Hewitt, J. (1917) Descriptions of new South African Arachnida. *Ann. Natal Mus.* 3, 687–711.
- Hickman, V.V. (1949) Tasmanian littoral spiders with notes on their respiratory systems. Habits and taxonomy. *R. Soc. Tasmania* 1948, 31–43.
- Hirst, S. (1926) On some new genera and species of Arachnida. *Proc. Zool. Soc. Lond.* (1925, 1271–1280).

- Kaestner, A. et al. (1968) Invertebrate Zoology. Vol. II. (. .)
- Kensler, C.B. and Crisp, D.J. (1965) The colonization of artificial crevices by marine invertebrates. *J. Anim. Ecol.* 34, 507–516.
- Kenyon, K.W., Yunker, C.E. and Newell, I.M. (1965) Nasal mites (Halarachnidae) in the sea otter. *J. Parasitol.* 51, 960.
- Kinzelbach, R. (1970) Skorpione als Strandbewohner. *Nat. Mus. Frankfurt* 100 (8), 351–355.
- Krantz, G.W. (1970) A Manual of Acarology. (. .)
- Krantz, G.W. (1971) The mites of Quintana Roo. II. *Actacarus giganteus*, a new species of arenicolous mite (Prostigmata: Halacaridae) from the Caribbean Coast. *Ann. Entomol. Soc. Am.* 64 (3) 594–598.
- Krantz, G.W. (1973) Four new predatory species of Halacaridae (Acari: Prostigmata) from Oregon, with remarks on their distribution in the intertidal mussel habitat (Pelecypoda: Mytilidae). *Ann. Entomol. Soc. Am.* 66 (5) 975–985.
- Krantz, G.W. (1974) *Phaulodinychus mitis* (Leonardi, 1899) (Acari: Uropodidae) an intertidal mite exhibiting plastron respiration. *Acarologia* 16 (1) 11–20.
- Lamoral, B.H. (1968) On the ecology and habitat adaptations of two intertidal spiders, *Desis for midabilis* (O. P. Cambridge) and *Amaurobioides africanus* Hewitt, at The Island (Kommetjie, Cape Peninsula), with notes on the occurrence of two other spiders. *Ann. Natal Mus.* 20 (1) 151–193.
- Lee, V.F. (1972) Systematic Studies of the Littoral Chelonethida of the Gulf of California, Mexico. (. .)
- Lehtinen, P.T. (1967) Classification of the cribellate spiders and some allied families, with notes on the evolution of the suborder Araneomorpha. *Ann. Zool. Fenn.* 4, 199–468.
- Light, S.F. (1967) Intertidal Invertebrates of the Coastal California Coast. (. .)
- Locket, G.H. and Millidge, A.F. (1951) British Spiders. Vol. I. (. .)
- Locket, G.H. and Millidge, A.F. (1953) British Spiders. Vol. II. (. .)
- MacCook, H.C. (1888) The turret spider on Coffin's Beach. *Proc. Acad. Nat. Sci. Philadelphia.* 1888, 333–336.
- McDaniel, B., Morihara, D. and Lewis, J.K. (1975) The family Teneriffiidae Thor with quantitative data from Cottonwood, South Dakota, and a new species from Mexico. *Ann. Entomol. Soc. Am.*, submitted for publication.
- Mello-Leitão, C.F. de (1928) Novas notas arachnológicas VIII. Una pequena caranguejeira marinha. *Bol. Mus. Nac. Rio de Janeiro* 4 (3) 50–51.
- Michelbacher, A.E. (1939) Notes on Symphyla with descriptions of three new species of *Symphyella* from California. *Pan-Pac. Entomol.* 15, 21–28.
- Michelbacher, A.E. (1949) The ecology of Symphyla. *Pan-Pac. Entomol.* 25, 1–12.
- Morikawa, K. (1958) Maritime pseudoscorpions from Japan. *Mem. Ehime Univ. Sect. II (Sci.), Ser. B (Biol.)* 3 (1) 5–10
- Morikawa, K. (1962) Ecological and some biological notes on Japanese pseudoscorpions. *Mem. Ehime Univ. Sec. II (Sci.), Ser. B (Biol.)* 4 (3) 417–435.
- Muchmore, W.B. (1972) The pseudoscorpion genus *Paraliochthonius* (Arachnida, Pseudoscorpionida, Chthoniidae). *Entomol. News* 83, 248–256.
- Muchmore, W.B. (1974) Pseudoscorpions from Florida. 3. *Epactiochernes*, a new genus based upon *Chelanops tumidus* Banks (Chernetidae). *Florida Entomol.* 57 (4) 397–407.
- Newell, I.M. (1951) Further studies on Alaskan Halacaridae (Acari). *Am. Mus. Novitates* 1536, 1–56.
- Nielsen, E. (1932) The Biology of Spiders. Vol. 1. (. .)
- Oi, R. (1960) Seaside spiders from the environs of Seto Marine Biological Laboratory of Kyoto University. *Acta Arachnol.* 17 (1) 3–8.

- Petrunkévitch, A. (1939) Catalogue of American spiders. Trans. Conn. Acad. Arts Sci. 33, 133–338.
- Platnick, N. (1974) The spider family Anyphaenidae in America north of Mexico. Bull. Mus. Comp. Zool. 146 (4) 205–266.
- Platnick, N. and Shadab, M.U. (1975) A revision of the spider genus *Gnaphosa* (Araneae, Gnaphosidae) in America. Bull. Am. Mus. Nat. Hist. 155 (1) 1–66.
- Pocock, R.I. (1898) Descriptions of a new marine spider from South Africa collected by the Rev. N. Abraham, and presented to the Derby Museum. Bull. Liverpool Mus. 1, 75–78.
- Pocock, R.I. (1900) Marine centipede in Somerset. Zoologist 4 (4) 484–485.
- Pocock, R.I. (1902) On the marine spiders of the genus *Desis*, with description of a new species. Proc. Zool. Soc. Lond. 1902 (2) 98–106.
- Ricketts, E.F. and Calvin, J. (1962) Between Pacific Tides. (, .)
- Robson, C.H. (1878) Notes on a marine spider found at Cape Campbell. Trans. New Zealand Inst. 8 (31) 299–300.
- Roth, V.D. (1967) A redescription of the spider genus *Mizaga* Simon (Agelenidae), with new synonymy. Am. Mus. Novitates 2291, 1–7.
- Roth, V.D. and Brown, W. (1975) A new genus of Mexican intertidal zone spider (Desidae) with biological and behavioral notes. Am. Mus. Novitates 2568, 1–7.
- Seurat, L.G. (1924) Observations sur les limites, les facies et les associations animales de l'étage in tercotidal de la petite Syrte (Golfe de Gabes). Bull. Stn. Oceanogr. Salambo 3, 1–72.
- Silvestri, F. (1903) Fauna Napoletana, Miriapodi viventi sulla spiaggia del mare presso Portici (Napoli) Ann. Mus. Zool. Napoli, New Ser. 1 (12) 1–15.
- Stephenson, T.A. and Stephenson, A. (1972) Life between Tidemarks on Rocky Shores. (, .)
- Vachon, M. (1968) Ordre des Pseudoscorpions. In: Traité De Zoologie. Vol. VI. (, ), pp. 437–481.
- Van Volkinburg, D. (1969) *Thinoseius spinosus* found in new and unusual habitat (Acari: Eviphididae). Pan-Pac. Entomol. 45, 318–319.
- Vercammen-Grandjean, P.H. (1971) *Eutrombicula* (E) *poppi*, a new chigger from a sea snake (Acarina, Trombiculidae). Opusc. Zool. Münch. (114) 1–3.
- Weygoldt, P. (1969) The Biology of Pseudoscorpions. (, .)
- Williams, S.C. (1971) In search of scorpions. Pac. Discovery 24 (3) 1–10.
- Womersley, H. (1937) A new species of marine Hydrachnellae from South Australia. Trans. Proc. R. Soc. S. Australia 61, 173–174.
- Workman, T. and Workman, M.E. (1896) Malaysian Spiders. (, .) Parts 4–10, 25–80.
- Yunker, C.E. (1970) New genera and species of Ewingidae (Acari: Sarcoptiformes) from pagurids. Rev. Zool Bot. Africaines 81, 237–254.

# Littoral apterygotes (Collembola and Thysanura)

Els N.G. Jooisse

<b>Contents</b>		
7.1	Introduction	151
7.2	Systematics	153
	7.2.1 Collembola	153
	7.2.2 Thysanura	154
	7.2.3 Taxonomy of marine Apterygota - Key to families of common marine Apterygota	155
7.3	Biology	163
	7.3.1 Reproduction	163
	7.3.2 Moulting and growth	166
	7.3.3 Age and longevity	167
7.4	Physiology	168
	7.4.1 Respiration	168
	7.4.2 Osmoregulation and excretion	169
7.5	Ecology	170
	7.5.1 Habitat and distribution	170
	7.5.2 Specific adaptations to marine environments	174
	7.5.3 Population dynamics	177
	Acknowledgements	180
	References	180

## 7.1 INTRODUCTION

Apterygota are terrestrial invertebrates that belong to the class Hexapoda; Apterygota can be subdivided into four orders, Protura, Collembola, Diplura and Thysanura. Although the Apterygota share a common character with the Insecta in having six legs, they are not closely related in other ways. Members of Apterygota are all primitively wingless, i.e., none of their ancestors possessed wings, but the various orders do not share any close relationship among themselves

(Sharov, 1966). The Thysanura are considered to be descendants of primitive insects from which the Pterygotes evolved.

Apterygota are widely distributed throughout the polar temperate and tropical regions. They are found in diverse, but often moist, situations. They are mainly soil inhabitants, common in leaf litter and other decaying organic matter, but some are found in intertidal zones at the seashore or even on the surface of snow (Christiansen, 1964; Mani, 1968).

The Collembola are numerically the most important group, with which much of this chapter is concerned. The Thysanura are also included, but the Protura and Diplura do not possess marine members as far as we know, and will not be discussed.

Collembola, or springtails (Fig. 7.1), are small animals, rarely more than a few millimetres in length.

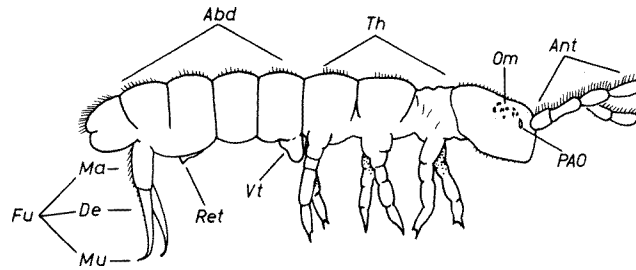

Fig. 7.1. Representative of the Collembola-Arthropleona. Ant = antenna; PAO = postantennal organ; Om = ocelli; Th = thorax; Abd = abdomen; Vt = ventral tube; Ret = retinaculum; Fu = furca; Ma = manubrium; De = dens; Mu = mucro (after Strenzke, 1955).

The common name for the group derives from their ability to jump when disturbed. This is facilitated by the possession of a springing organ carried on the fourth abdominal segment. It is folded forward on the ventral surface of the abdomen, and, when not in use, is held in place by the retinaculum on the third abdominal segment. However, in many Collembola the springing organ is often reduced.

Collembola are also characterized by the possession of a ventral tube, carried on the first abdominal segment which is always present. It was supposed to act as an adhesive organ, a collophore, thus the name Collembola (Lubbock, 1873). Later the ventral tube was thought to be a multifunctional organ, serving respiration, uptake of water, even copulation (Sedlag, 1952; Schaller, 1970), but since the work of Noble-Nesbitt (1963a), Eisenbeis (1974), Eisenbeis and Wichard (1974) and Verhoef (personal communication) the main function is considered to be the exchange of water and ions between the animal and its environment.

Thysanura or bristletails (Fig. 7.2) are easily recognized by the presence of three long cerciform processes on the posterior part of the abdomen. They are smooth



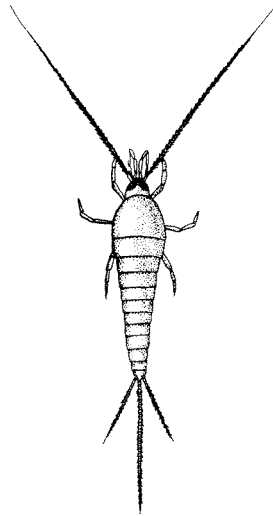

Fig. 7.2. Representative of Thysanura-Machilidae.

tapering insects with the body covered with glistening scales and a pair of long antennae on the head. The majority of species are larger than Collembola, up to 15 mm.

In this chapter, the biology, ecology and specific adaptations of only these members of apterygotes found in marine environments will be considered. The geographical covering is not as wide as desired mainly because most of the work has been done in the north temperate regions of Europe. For special sampling and preservation techniques of these small arthropods, the reader is referred to v. Törne (1965), Massoud (1967), Gisin (1968, 1970), Wallwork (1970) and Van der Kraan (1973).

## 7.2. SYSTEMATICS

### 7.2.1 Collembola

The order Collembola is divided into two suborders, the Symphypleona, with short, globular, indistinctly segmented body and the Arthropleona with elongate, cylindrical body and clearly visible segments. Only members of the Arthropleona are present in marine habitats.

The Arthropleona is subdivided into two sections, Poduromorpha and Entomobryomorpha. Marine members are found in the families Onychiuridae, Hypogastruridae and Neanuridae of the former section, and Isotomidae and Actaletidae of the latter section.

### *General morphology*

Fig. 7.1 illustrates the general external features of a common representative of the Arthropleona. The body is clothed with various types of hairs (setae), smooth, fringed, clavate, plumose or ciliated. Some species also possess scales. There is one pair of antennae, consisting of four true segments, but greatly varying in length. Sensory structures of great taxonomic importance frequently occur on the antenna, especially on the third and fourth segments. Eyes may be present in some groups; being clusters of one to eight ocelli on each side; they are absent in the Onychiuridae. In many species a pair of sensory structures, known as postantennal organs, are found between the antennae and the eyes. The mouth parts are sunken within the head (entognathous). The thorax has three segments, each with a pair of legs, of which the tarsi are fused to the tibia (tibiotarsus). The legs terminate in a claw which usually bears teeth, the number, form and position of which are used in taxonomy. An empodium is usually present (Fig. 7.11b).

The six-segmented abdomen bears a furca and a ventral tube. The furca is composed of a pair of appendages fused in their basal portion to form the manubrium, from which a bifid structure (dentes) extends distally to carry the mucrones (Fig. 7.12c). The structure of mucrones differ from species to species and is of taxonomic value.

#### *7.2.2 Thysanura*

The order Thysanura is divided into two families: Machilidae, members of which can be found in marine regions; and Lepismatidae, which occur in terrestrial habitats, and also in buildings.

### *General morphology*

The body of the Machilidae is clothed with scales. The antennae are long and filiform, often consisting of 30 or more segments. Compound eyes are developed, but additional ocelli are present. The mouth parts are ectotrophic and are the most primitive type found among insects.

The legs are usually three-segmented with paired tarsal claws. The coxae of the second and third pair of legs carry a small pair of movable unsegmented styli. The abdomen is composed of 11 segments, with the last segment prolonged to form a median appendage and bearing a pair of long slender cerci, consisting of more than 50 segments. Machilids are able to jump by using these long cerci (Willem, 1924; Paclt, 1956). The abdomen carries a variable number of styli like those found on the coxae. These are regarded as vestiges of limbs as ancestors of insects had limbs on all the segments of the body. In addition, 14—24 segmentally arranged protrusible coxal vesicles are present (Fig. 7.3) and are considered to be homologous to the ventral tube of Collembola.

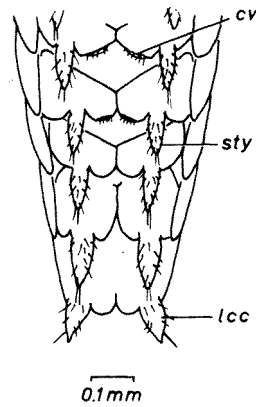

Fig. 7.3. The abdominal segments 3–7 of *Petrobius brevistylis* (1 st instar) as seen ventrally. cv = coxal vesicle; lcc = lateral caudal cercus; sty = stylet (after Delany, 1959).

### 7.2.3 Taxonomy of marine Apterygota

The most important genera of marine apterygotes are included in the key. No effort is made to present a complete list of marine species. The following references provide keys for specific identification: Palissa (1964): European Thysanura and Collembola; Womersley (1939): Australian Thysanura and Collembola; Massoud (1967): Neanuridae of the Australo-American regions; Gisin (1960): treatise of European Collembola; Stach (1947–1967): World Collembola; Salmon (1964–5): Index to Collembola of the World; Uchida (1971–2): Japanese Collembola; Maynard (1951): Collembola of New York State. Species lists of European marine Collembola can be found in Strenzke (1955) and Delamare Deboutteville (1953). A list of common marine Apterygota and their general habitats is given in Table 7.1.

Table 7.1 List of common marine Apterygota.

Order Collembola	Suborder Arthropleona	Section Poduromorpha	Family ONYCHIURIDAE
			<i>Onychiurus debilis</i> (Mon.) (Fig. 7.4) - sandy beaches along European coasts
			Family HYPOGASTRURIDAE
			<i>Hypogastrura gisini</i> (Strenzke) (Fig. 7.5) - in sandy sites along coasts of North and Baltic Seas
			<i>H. viatica</i> (Tullbg.) (Fig. 7.6) - cosmopolitan, in wrack and salt marshes
			<i>Xenylla humicola</i> (Fabr.) - presumably cosmopolitan in wrack and salt marshes
			<i>X. maritima</i> (Tullbg.) - presumably cosmopolitan in wrack and salt marshes

## Family NEANURIDAE

- Friesea acuminata* Denis (Fig. 7.7) - Mediterranean in sandy sites and littoral subsoil  
*F. fagei* Denis - under stones along Mediterranean coasts (for Japanese species see Uchida and Tamura 1966, 1967)  
*Pseudanurida* - several species in Suez region and Persian Gulf  
*Oudemansia* - species in India, Australia and China  
*Anurida* - important genus with at least 8 marine species  
*A. maritima* (Guérin) (Fig. 7.8) - well known along Atlantic coasts of Europe and America  
*Anuridella* - a genus with only marine members. Along rocky European coasts

## Section Entomobryomorpha Family ISOTOMIDAE

- Folsomia sexoculata* (Tullbg.) (Fig. 7.9) - in wrack and salt marshes  
*F. thalassophila* (Bagn.) - along Scottish and Irish coasts  
*Archisotoma* (Fig. 7.10) - seven marine species, in littoral subsoil and salt marshes (Poinsot, 1965)  
*Proisotoma crassicauda* (Tullbg.) - in wrack and under stones  
*P. schoetti* (Dalla Torre) - in wrack and under stones  
*Isotoma maritima* (Tullbg.) (Fig. 7.11) - in wrack and under stones  
*I. m. ssp. boneti* (Delamare Deboutteville) - in littoral subsoil, southern Europe (Poinsot, 1971)  
*Axelsonia littoralis* (Mon.) (Fig. 7.12) - in wrack and littoral subsoil, presumably cosmopolitan

## Family ACTALETIDAE

- Actaletes neptuni* (Giard) - on rocks in the intertidal zone of French coasts (Fig. 7.13)  
*A. calcarius* described by Bellinger (1962) - from the Caribbean

## Order Thysanura

- Petrobius maritimus* (Leach) - rocky shores of Atlantic coasts  
*P. brevistylis* (Carpenter) - rocky shores, Atlantic coasts  
*P. lohmanderi* (Agrell) - rocky shores, East Sweden

## KEY TO FAMILIES OF COMMON MARINE APTERYGOTA

- |    |   |                |
|----|---|----------------|
| 1. | Antennae with maximum of 6 segments. No cerci. Abdomen with 6 segments, sometimes with last few segments fused (Fig. 7.1) | Collembola 2   |
|    | Antennae with many segments. Abdomen with 3 long appendages. Abdomen with styli (Fig. 7.2)                                | Thysanura      |
| 2. | Body elongate, abdominal segments distinct, head prognathous  | Arthropleona 3 |
|    | Body globular, abdominal segments 1-4 fused, usually demarcated from the rest of the body, head hypognathous              | Symphyleona    |
| 3. | Pronotum with some setae, body generally stout, antennae short  | 4              |
|    | Pronotum small without setae, usually hidden under mesonotum, habitus slender, antennae rather long                       | 6              |
| 4. | Pseudocelli present (Fig. 7.4c), 3rd antennae with complex sense organ, eyes absent. Usually white                        | Onychiuridae   |
|    | Pseudocelli lacking   | 5              |

- |    |  |   |
|----|--|---|
| 5  | Chewing mouthparts, with well-developed molar plate (visible after clearing or squashing), not projected in a cone                   | Hypogastruridae (see key)                     |
|    | Mouthparts usually without molar plate, often projected in a cone  | Neanuridae (see key)                          |
| 6. | Body with smooth setae, sometimes ciliated. Abdominal segments 3 and 4 usually subequal, 4–6 sometimes fused. Furca often reduced    | Isotomidae (see key)                          |
|    | Abdominal segment 4 more than half total length of abdomen with long chitinous ridges; abdominal segments 5 and 6 fused              | Actaletidae                                   |
|    | Body often with scales (microscopic) or densely ciliated. Abdominal segment 4 mostly appreciably longer than 3. Furca well developed | other non-marine families of Entomobryomorpha |

### *Key to genera of Hypogastruridae*

- |    |   |                     |
|----|---|---------------------|
| 1. | Furca well developed, dentes with 3 or more setae. Eyes usually 8 on each side. Postantennal organ present. | <i>Hypogastrura</i> |
|    | Furca more or less reduced. Eyes 5 on each side. Postantennal organ absent. Empodium absent                 | <i>Xenylla</i>      |

### *Key to genera of Neanuridae*

- |    |   |                     |
|----|---|---------------------|
| 1. | Postantennal organ absent. Furca reduced or absent  | <i>Friesea</i>      |
|    | Postantennal organ present. Furca well developed  | 2                   |
| 2. | Sixth abdominal segment relatively small, never bilobed. Segmental tubercles absent. Maxillae with teeth (Fig. 7.14)    | 3                   |
|    | Sixth abdominal segment relatively long, bilobed. Large segmental tubercles present. Maxillae without teeth (Fig. 7.15) | 4                   |
| 3. | Without anal spines. Furca extending beyond the ventral tube  | <i>Pseudanurida</i> |
|    | With anal spines  | <i>Oudemansia</i>   |
| 4. | Mandibles with normal teeth (Fig. 7.16a) Tip of abdomen globular  | Anurida             |
|    | Mandibulae different (Fig. 7.16b)   | <i>Anuridella</i>   |

### *Key to genera of Isotomidae*

- |    |  |                    |
|----|--|--------------------|
| 1. | Tip of abdomen without spines. Furca present. Last 3 abdominal segments fused                                      | <i>Folsomia</i>    |
|    | Abdominal segments 5 and 6 fused, with 1–2 long thin hairs on each side (bothriotrichae). Manubrium with few hairs | <i>Archisotoma</i> |
|    | Abdominal segments 5 and 6 separated, without bothriotrichae   | 2                  |
| 2. | Dentes clumsy, with 2 or more hairs in front   | <i>Proisotoma</i>  |
|    | Front of manubrium with many hairs   | 3                  |
| 3. | Abdomen without bothriotrichae (Fig. 7.11)   | <i>Isotoma</i>     |
|    | At least abdominal segment 4 with 1–2 pairs of very thin smooth bothriotrichae. Claws with long teeth (Fig. 7.12)  | <i>Axelsonia</i>   |

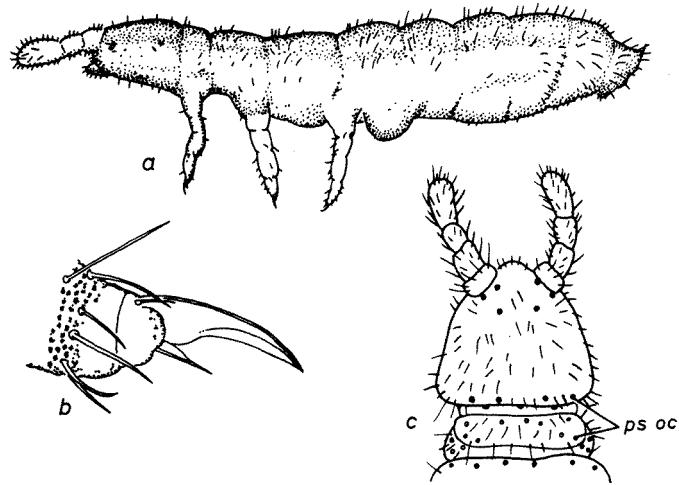

Fig. 7.4. *Onychiurus debilis*. (a) habitus (1.5 mm, white); (b) claw 3; (c) head of *Onychiurus* sp. with pseudocelli (ps oc) (after Strenzke, 1955).

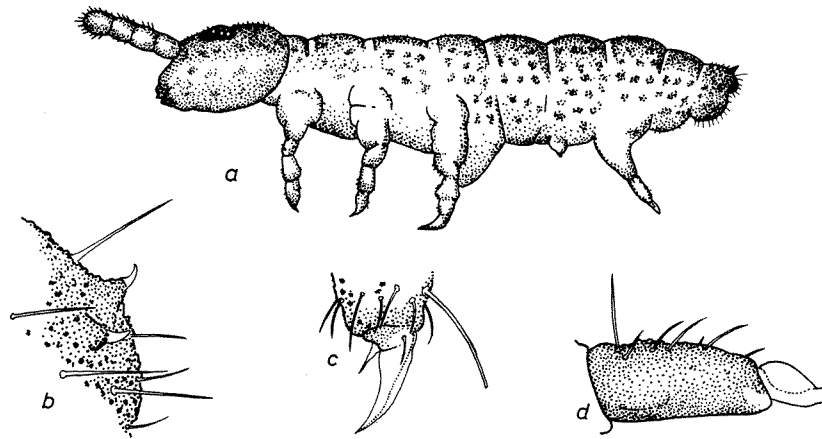

Fig. 7.5. *Hypogastrura gisini*. (a) habitus (0.8 mm, greyish-black); (b) anal spines; (c) claw; (d) dens and mucro (after Strenzke, 1955).



Fig. 7.6. *Hypogastrura viatica*. (a) habitus (1.9 mm, black-blue); (b) claw (after Strenzke, 1955).

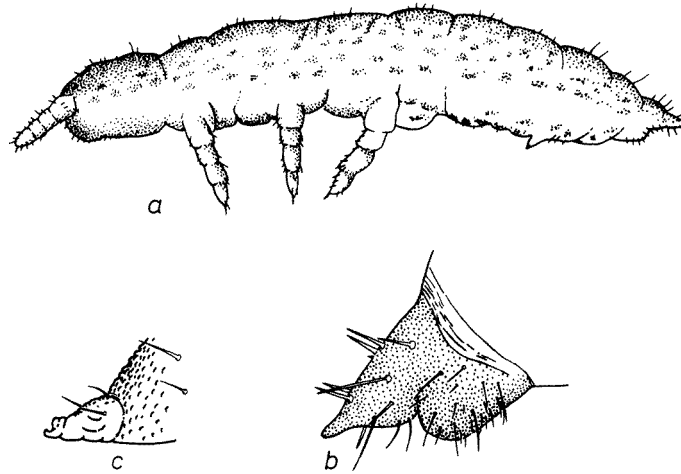

Fig. 7.7. *Friesea acuminata*. (a) habitus (1.5 mm, white); (b) abdominal segments 5 and 6; (c) dens and mucro (after Strenzke, 1955).

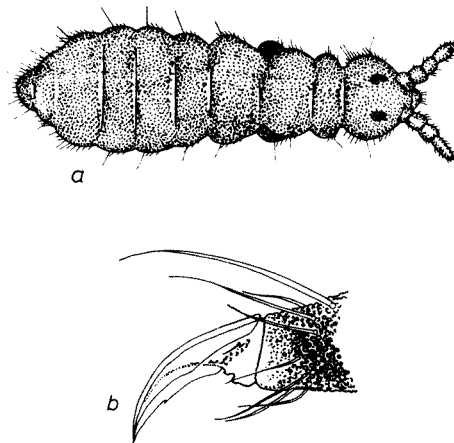

Fig. 7.8. *Anurida maritima*. (a) habitus (3 mm, black-blue); (b) claw 3 (after Strenzke, 1955).

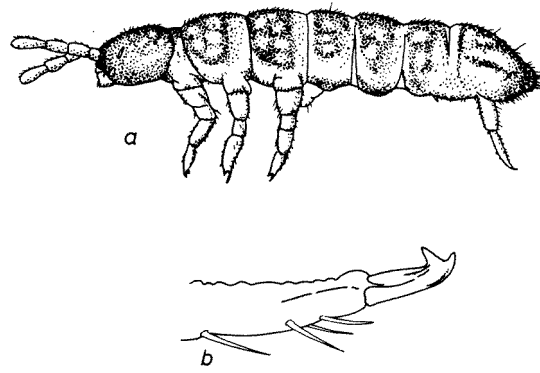

Fig. 7.9. *Folsomia sexoculata*. (a) habitus (2 mm, greyish-black); (b) dens and mucro (after Strenzke, 1955).

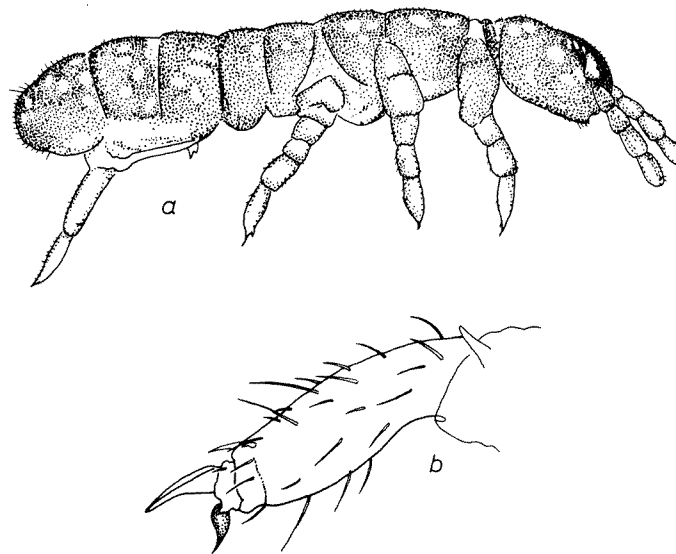

Fig. 7.10. *Archisotoma besselsi*. (a) habitus (1.5 mm, bluish-black with bright patches); (b) leg 3 (after Strenzke, 1955).



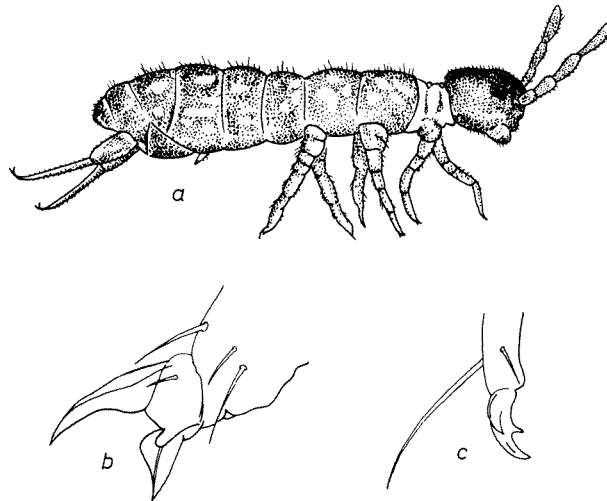

Fig. 7.11. *Isotoma maritima*. (a) habitus (2 mm, greyish-blue); (b) claw 3; (c) mucro (after Strenzke, 1955).

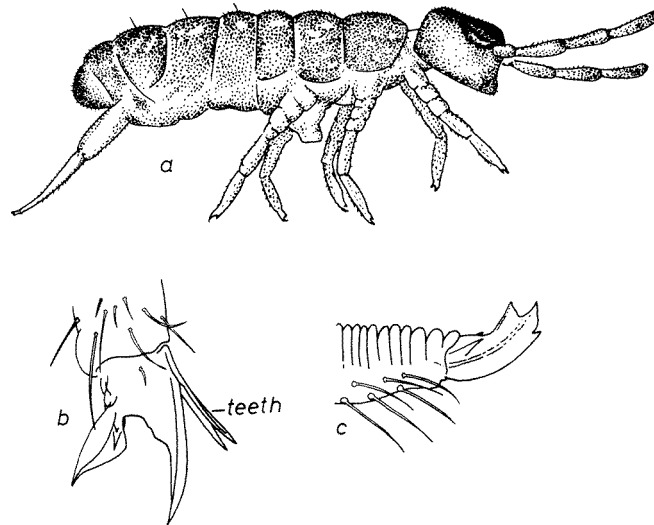

Fig. 7.12. *Axelsonia littoralis*. (a) habitus (2 mm, greyish-violet); (b) claw 3; (c) mucro (after Strenzke, 1955).

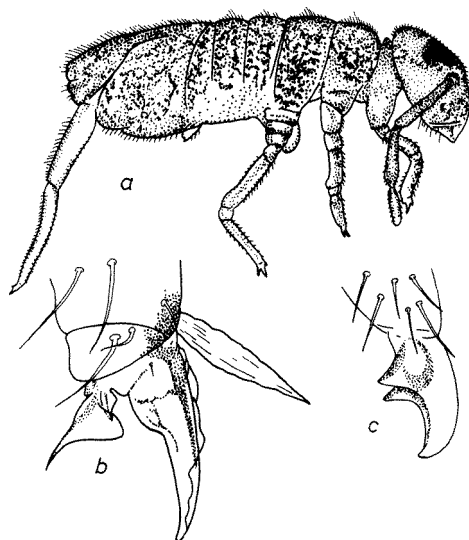

Fig. 7.13. *Actaletes neptuni*. (a) habitus (1.5 mm, grey-brown); (b) claw; (c) mucro (after Strenzke, 1955).



Fig. 7.14. (Left) Maxilla *Anuridella calcarata* (a) and *Anurida bonei* (b) (from Massoud, 1967).

Fig. 7.15. (Right) Maxilla *Pseudanurida* sp. (after Massoud, 1967).

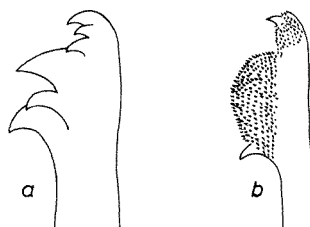

Fig. 7.16. Mandibulae *Anurida granaria* (a) and *Anuridella calcarata* (b) from Massoud, 1967).

## 7.3 BIOLOGY

### 7.3.1 Reproduction

The reproductive systems of Thysanura and Collembola are very different. In Thysanura, the female has 5–7 ovarioles on each side, which open one behind the other. In Collembola, the follicles are united in a common sac, the ovarioles lack separate envelopes. The testes of Collembola are simple sacs with short ducts which unite to form the ejaculating canal, whereas in *Petrobius* (Thysanura) they are single lobes, each discharging into a double vas deferens. The sexes are usually separate. The spermatozoa are produced and released in specialized packets (spermatophores) held together by proteinacious secretions of the accessory glands (Fig. 7.17). The spermatophores are different in size and structure for different species (Betsch-Pinot, 1974).

Parthenogenesis has been proposed as a method of reproduction both in Thysanura (Verhoeff, 1910; Agrell, 1944) and Collembola (Petersen, 1971).



Fig. 7.17. Spermatophore of *Orchesella cincta* (height 280  $\mu\text{m}$ , diam. sperm drop 40  $\mu\text{m}$ ).

In marine *Petrobius* the basic sex ratio does not depart significantly from unity. Davies and Richardson (1970) found an overall female-to-male ratio of 1.2:1 for *P. maritimus* and 1.7: 1 for *P. brevistylis*. The difference is mainly caused by the excess of females in late summer and autumn, suggesting that more females overwinter than males. This was confirmed by a 3:1 female to male ratio in individuals of more than 10 mm in size during March-May. However, in some localities they found very few males. The significance of these results has not yet been assessed.

Parthenogenesis is not known in marine Collembola. In *Anurida maritima* a sex ratio of about one was found in medium-sized (2–3 mm) individuals (Joosse, 1966). Among larger individuals (> 3 mm), however, the female-to-male sex ratio was 1.7:1, probably indicating a longer survival of the females.

The transfer of spermatophores in Collembola is accomplished in different ways (Mayer, 1957), usually without active participation of the male and independent of the presence of other individuals. In some species, however, an increased rate of spermatophore deposition can be noticed in the presence of a female. A volatile sex pheromone responsible for this phenomenon has been demonstrated in *Sinella curviseta* (Waldorf, 1974).

The typical aggregation behavior common in apterygota may play an important role in increasing the meeting chance between individuals and between females and spermatophores. Most species are forced to aggregate in sites with sufficient survival conditions by their high humidity requirements. However, among available sites only a few are chosen, suggesting an attraction between individuals, as has been observed in *Anurida maritima* (Morton, 1954; Joosse, 1966) and *Hypogastrura viatica* (van der Kraan, 1973). Laboratory studies on several other species of *Orchesella* and *Tomocerus* indicate that an aggregation pheromone may be present (Verhoef and Nagelkerke, personal communication).

Detailed information on the reproduction of marine Collembola is based on *A. maritima*. A general account can be found in Laboulbène (1864), Folsom (1902), Davenport (1903) and Imms (1906). The eggs of *A. maritima* are pale yellow when freshly laid. As development proceeds they darken and eventually become dark orange. In the north temperate regions the eggs are laid in August and can be found in groups in deep fissures in rocks (Glynne-Williams and Hobart, 1952; Morton, 1954) as well as in crevices around plant roots on saltmarshes (Joosse, 1966). The females lay their eggs in sites with available free water (Verhoef and Nagelkerke, personal communication). The eggs increase in size by water uptake of the chorion during the early stage of development and become more resistant to mechanical disturbances and dry conditions. They overwinter and hatch in April of the following year.

The number of eggs produced in the course of a lifetime varies greatly. Hale (1965)

estimated an average of about 70 eggs for some species of Collembola. This figure may be too low as culture conditions, e.g. contamination of the substrate, may have serious effects upon egg deposition.

An interesting account of the mating behavior of Thysanura has been given by Sturm (1952, 1956). The process in Machilidae seems to be more elaborate than in Lepismatidae. It is initiated by the male rushing to the side of the female and drumming her on the anterior region of her body with his long maxillary palpi. The female responds by raising her abdomen vertically and the two insects come to face each other (Fig. 7.18a). The male then draws out a thread from the penis with the free end attached to the substrate and the other remains in contact with the penis. Three or four spermatophores are deposited on the thread (Fig. 7.18b). After a series of complicated movements the spermatophores are transferred to the female (Fig. 7.18c,d).

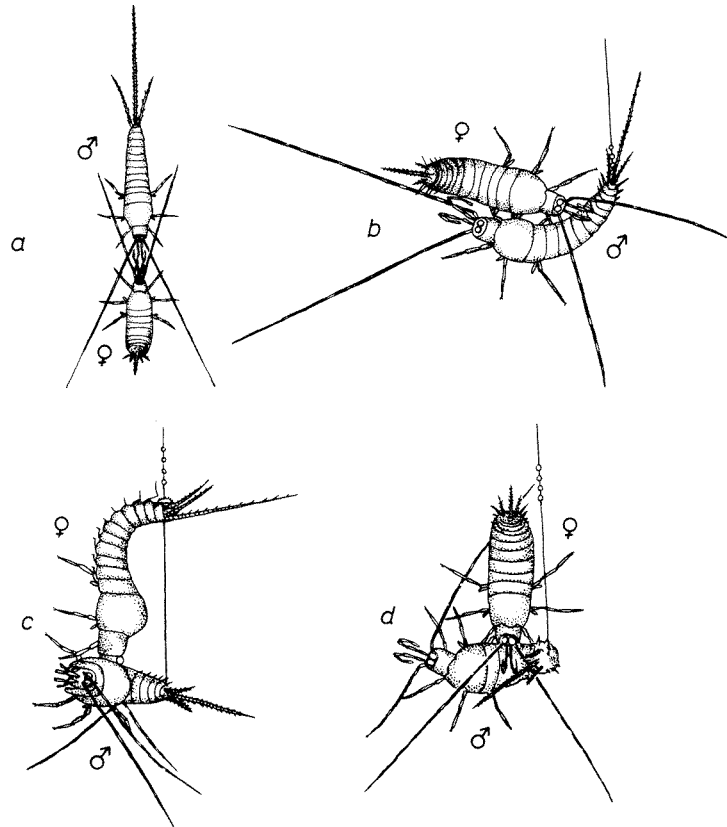

Fig. 7.18. Sexual behavior of a machilid (Thysanura) (after Sturm, 1952). For explanation see text.

The eggs of *Petrobius* possess a thick, shiny black shell. They are elongated, 1.0–1.3 mm in length, and laid in crevices of approximately 1–1.5 mm wide by insertion of the female ovipositor. Groups of up to one hundred eggs can be found in distinct clusters. The eggs are laid in autumn (October–November) and an average of about 12 eggs per fertile female was counted by Delany (1958). They hatch in the following spring (May–June) after a heavy winter mortality of about 57–79%. There are apparently two groups of females emerging each year; about 46% of the females do not have eggs. Probably one group hatches earlier or has a slightly more rapid growth and ultimately becomes the reproductive population of the generation.

Smith (1970) noticed aggregation of different machilids in favorable localities both in the laboratory and in the field. He suggested some trail marking substance may be involved.

### 7.3.2 Moulting and growth

The development of Apterygota is epimetabolic, which means differentiation occurs gradually during development. Apterygota are known to moult throughout their lives and are able to replace broken and injured appendages during this process (Sweetman, 1934; Paclt, 1956). At a certain size the animals become sexually mature and start to reproduce, but reproduction is again followed by a moult. Continuing in this way, with alternate moulting and reproduction, *Petrobius* can moult up to 50 times (Sweetman, 1952) after the adult stage has been reached. A similar number of moults has been recorded for Collembola (Lindenmann, 1950; Joosse et al., 1973).

Moulting is similar in Collembola and Thysanura. The individuals about to moult become motionless and do not feed (Thibaud, 1968; de With and Joosse, 1970; Joosse and Verhoef, 1974). During this time the cuticle is renewed. As in other insects there are two distinct layers in the cuticle, the laminated endocuticle and a thin epicuticle (Krzysztofowicz et al., 1972; Biliński, 1973). In places where mechanical forces are to be expected, as in legs, antennae and furca, an untanned exocuticle (mesocuticle) occurs between epi- and endocuticle (Lower, 1958). Moulting individuals are highly susceptible to drought as demonstrated by the high transpiration rate (Vannier, 1973a; Joosse and Verhoef, 1974) (Fig. 7.19).

During ecdysis the lining of the tracheae (when present), fore and hind gut and associated glands are cast off and renewed by the underlying hypodermal cells. The degenerated epithelium of the gut is excreted as a yellow dropping a few hours after the moult. In Collembola about 50 % of the total instar time is spent in preparation of these new structures (Joosse, 1975, 1976). Since the animals do not feed during moulting they must store food, probably in the form of lipids (Healey, 1965; Wallwork, 1975).

In general, moulting frequency in Collembola shows a linear relationship

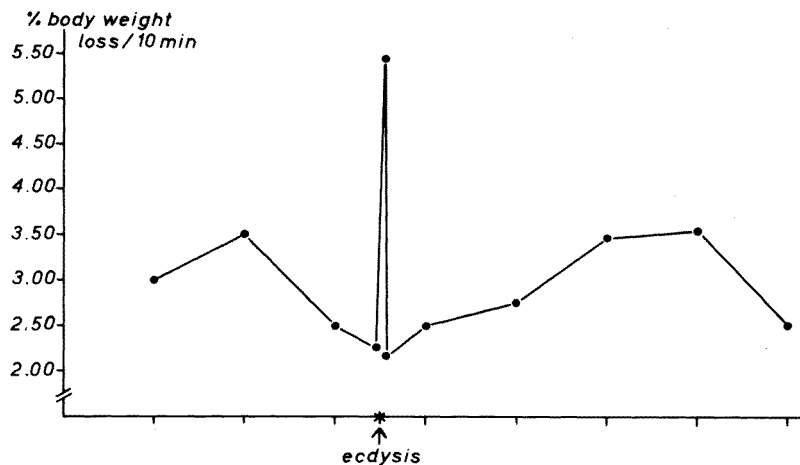

Fig. 7.19. Variation of transpiration during one moulting instar in *Orchesella cincta*.

with temperature (Joosse and Veltkamp, 1970). In most species no moulting or growth occurs below 3–5°C (Hale, 1965).

In *Petrobius brevistylis* and *P. maritima*, rapid growth occurs during the summer months in the field. Growth was far greater in juveniles than in adults but does not occur from late September to end of May (Delany, 1959a).

### 7.3.3 Age and longevity

Age in Apterygota is very difficult to interpret in terms of the conventional arthropod instar classes. Measurements of body lengths are often used, but body size is extremely plastic in response to environmental factors such as feeding conditions. Nevertheless, a relationship between body length and age (number of instars) can be determined approximately in the laboratory by means of Dyar's Rule (Dyar, 1890), which is expressed as  $y = K \cdot p^n$ , where  $y$  is the length of any measured part of the body after  $n$  ecdyses and  $K$  and  $p$  are constants,  $p$  being Dyar's progression factor (Maclagan, 1932; Agrell, 1948; Hale, 1965; Joosse and Veltkamp, 1970).

The number of rings of scales of the lateral caudal cerci are used in determining instar numbers in Thysanura (Delany, 1959a). At the time of hatching the cerci are very short (Fig. 7.3), but they increase in length with age.

The maximum longevity of *Petrobius* has not been established with certainty, although several studies suggest they can live for at least 16 months (Delany, 1959a). The average longevity of collembolan species is about 4 months (Agrell, 1941), but individuals of the winter generation survive for at least 6 months (Joosse, 1969; Joosse and Veltkamp, 1970). In the laboratory it is possible to

keep some species alive for more than one year (Strebel, 1932; Milne, 1960; Joosse and Veltkamp, 1970).

## 7.4 PHYSIOLOGY

### 7.4.1 Respiration

In Arthropleona (Collembola) there is no tracheal or other internal respiratory system, except in *Actaletes* where a very simple tracheal system is present in the head. Respiration is almost entirely cutaneous. Studies using scanning and transmission electron microscope (Hale and Smith, 1966; Massoud, 1969; Paulus, 1971; Krzystofowicz et al., 1972; Dalai and Malatesta, 1973; Lawrence and Massoud, 1973) have revealed hexagonal patterns on the cuticular surfaces of many Collembola (Fig. 7.20). Noble-Nesbitt (1963b) suggested that the wax layer is localized on the raised portion of the pattern, leaving the depressed areas wax-free and permeable

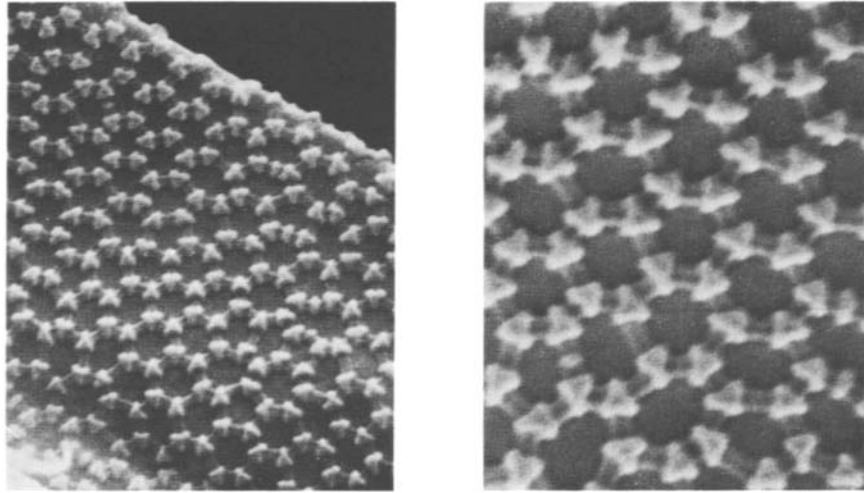

Fig. 7.20. Cuticle structure of *Orchesella cincta* ♂, abdomen (a  $\times$  16,000 and b  $\times$  36,000) SEM photos by Verhoef, Lab. d'Ecologie générale, Brunoy, France).

to air. Such an arrangement of a hydrophobic cuticle would permit the animal to respire while protecting it from danger of submersion. The air film trapped between the tubercles acts as a physical gill and allows the animal to respire when submerged (see Ch. 3).

Collembola are able to survive very low oxygen concentrations. Ruppel (1953) found *Orchesella villosa* surviving in air with 1.1% O<sub>2</sub> concentration and *Onychiurus*



*armatus* could survive in even lower O<sub>2</sub> concentrations. Zinkler (1966) demonstrated that the O<sub>2</sub> consumption of certain species did not decrease even at an O<sub>2</sub> concentration of 3%.

Ghiradelli and Radigan (1974) presented evidences for the presence of a wax layer covering the entire surface of certain species. The oxygen must then be obtained by a route other than diffusion through the cuticle, probably via the ventral tube. The respiration function of the ventral tube has been stressed by earlier authors (Nutman, 1941; Sedlag, 1952; Ruppel, 1953), but subsequent work by Noble-Nesbitt (1963a), Eisenbeis (1974), Eisenbeis and Wichard (1974) and Verhoef (personal communication) has indicated that its main function is regulation of water and ions. Measurements on transpiration rate (% water loss per unit of time) demonstrated that transpiration is very high in relatively dry air (Vannier, 1972, 1973b, 1974; Verhoef, personal communication). Under such conditions the ventral tube is retracted to prevent water loss. If water is given, the vesicles are everted by haemolymph pressure and water uptake can be demonstrated. Individuals kept in air with increased CO<sub>2</sub> content become very active (Joosse and Kapteyn, 1968) and although locomotory activity demands higher respiratory activity (Zinkler, 1966) the ventral tube remains closed and no increase in transpiration rate can be demonstrated (Verhoef, personal communication).

In Thysanura a simple tracheal system is developed. There are nine pairs of spiracles in the Machilidae. The tracheae associated with each spiracle remain unconnected with those of adjacent segments. No spiracular closing mechanisms have been found (Heeg, 1967).

Thysanura are better protected against water loss than Collembola. This is not due to the presence of scales which only play a minor role in reducing water loss (Beament et al., 1964), but the presence of a very resistant outer layer of the cuticle (Lower, 1958).

#### 7.4.2 Osmoregulation and excretion

The maintenance of salt and water balance in insects is performed by the osmo-regulatory and excretory systems. Osmoregulatory functions are performed mainly by the ventral tube in Collembola and by the coxal vesicles in Thysanura. Investigations on the ultrastructure (Eisenbeis, 1974; Krzysztofowicz et al., 1974) and histochemistry (Eisenbeis and Wichard, 1974) of the ventral tube have shown very active and specialized transport system for specific ions. The morphology and physiology of the coxal vesicles of the Thysanura have been studied by Weyda and Stys (1974) and Weyda (1974). They demonstrated water absorption by a specialized absorbing epithelium which was confirmed by ultrastructural studies (Bitsch and Palévody, 1973; Bitsch, 1974).

The main nitrogenous waste product in insects is uric acid. This is normally

discharged by the Malpighian tubules or stored in tissue cells until it is eliminated. In Collembola, Malpighian tubules are lacking. A great part of the waste product is stored in the gut cells in the form of granules (Prowazek, 1900; Boelitz, 1933; Toth, 1942), probably uric acid crystals. The excretory function of the gut has been stressed by Feustel (1958). Ultrastructural studies of the gut revealed a great number of mineral inclusions (Humbert, 1974; Krzysztofowicz et al., 1974). These are present even in newly hatched individuals and are eliminated by the periodic renewal of the gut lining at each moult (Thibaud, 1968).

Certain excretory functions may be performed by the cephalic nephridial glands, first described by Fernald (1890) in Collembola. These glands open via the mouth into an external open gutter which is connected with the ventral tube. The transport of excretory products to the ventral tube supports the function of the ventral tube in water and ion resorption (Noble-Nesbitt, 1963a).

Malpighian tubules are present in Thysanura. A comparison of the cytology and morphology of these structures with those of other insects do not suggest any important excretory function (Fain-Maurel and Cassier, 1974). Lison (1939) demonstrated excretion by particular cells (arthrocytes) connected with the Malpighian tubules. Much of the waste product is probably excreted via the epithelium of the gut. Gut epithelial cells with capacities to discharge a variety of mineral inclusions, e.g., P, Ca, Mg and Zn, have been described (Martoja, 1972; Cassier and Fain-Maurel, 1974).

Cephalic glands are also present in the Thysanura. Their morphology shows structures comparable to the segmental organs in other Arthropods, indicating an active filtration of the haemolymph and a resorption of water and salts can occur (Fain-Maurel and Cassier, 1974).

In both Thysanura and Collembola, uric acid can be stored in special urate cells of the fat-body.

## 7.5 ECOLOGY

### *7.5.1 Habitat and distribution*

Since Apterygota are originally terrestrial animals, they cannot survive in habitats that are continuously submerged. Thus they only occur in the intertidal and the supralittoral zone. In general, Collembola are found in the intertidal zone, but Thysanura only occur in the supralittoral zone.

### *Collembola*

Several species of Collembola are typical of rocky shores. When the tide comes in they find refuge in the small crevices of rocks or between algae. The microclimate in these crevices is very stable and the relative humidity is 100% at low

tide (Delamare Deboutteville and Bougis, 1951; Glynne-Williams and Hobart, 1952). The most characteristic species of this habitat region belong to the genera *Anurida*, *Anuridella* and *Actaetes*; they sometimes occur in very large numbers, often crowded to form solid masses. Glynne-Williams and Hobart (1952) found that *Anurida bisetosa* (now *A. maritima*) is limited to the upper intertidal zone in distribution, *A. thalassophila* is widely distributed about the mean tide level, and *Anuridella marina* and *Anurida denisi* are found in the lower intertidal (Delamare Deboutteville, 1953). Very few ecological data are available to explain this zonation. Differences in their ability to withstand submersion and competition are probably important factors.

The principal ecological factor is probably the presence of adequate food supply. Little is known about the feeding habits of marine Collembola, but all species found on intertidal rocks are carnivorous (Glynne-Williams and Hobart, 1952). Laboulbène (1864) and Folsom (1902) found that molluscs are eaten by *A. maritima*, and Imms (1906) found this species to feed on a variety of small marine animals. Dexter (1943) considered *Anurida* to be one of the most important scavengers on the seashore. Joosse (1966) found numerous individuals feeding on dead animals, especially *Corophium volutator*, but also *Hydrobia ulvae* and *Littorina*. *Actaetes neptuni*, found along the French rocky coasts of the North Sea (Strenzke, 1955) is also carnivorous (Willem, 1920, 1925).

A specialized Collembola fauna is found in the littoral subsoil of open beaches. This habitat has been carefully investigated by Davenport (1903), Dürkop (1935), Delamare Deboutteville (1953a,b), Brinck et al., (1955), Altner (1963) and Delamare Deboutteville and Massoud (1964). Several species are restricted to these areas. *Axelsonia littoralis* (presumably cosmopolitan); *Archisotoma besselsi* (holarctic, European Atlantic and Mediterranean coasts, California; Sukekane, personal communication); *Onychiurus debilis*, *Archisotoma pulchella* and *Isotoma maritima* from the European coasts; *Friesea acuminata*, *Anuridella calcarata*, *Isotoma maritima boneti* ssp. *boneti* and *Archisotoma interstitialis* along the French Mediterranean coast; *Hypogastrura gisini* and *Anuridella calcarata* from the North Baltic Sea coasts in Germany; the last species is also found along the English and Irish coasts (Strenzke, 1955), where it occurs together with *Archisotoma nigricans*.

The fragmentary knowledge about the distribution and biology of these and other species does not allow any conclusions to be drawn about their habitat requirements or factors determining their distribution. In addition to food, salinity may be an important limiting factor as shown for *Onychiurus debilis* by Delamare Deboutteville (1953) (Fig. 7.21).

Along coasts with gentle slopes where active sedimentation takes place, different types of habitats are developed. In tropical mangrove swamps, Schuster (1962, 1965) has found *Axelsonia tubifera*, a species only known from the South American coast, and also large numbers of *Pseudanurida sawayana* and *Anurida*

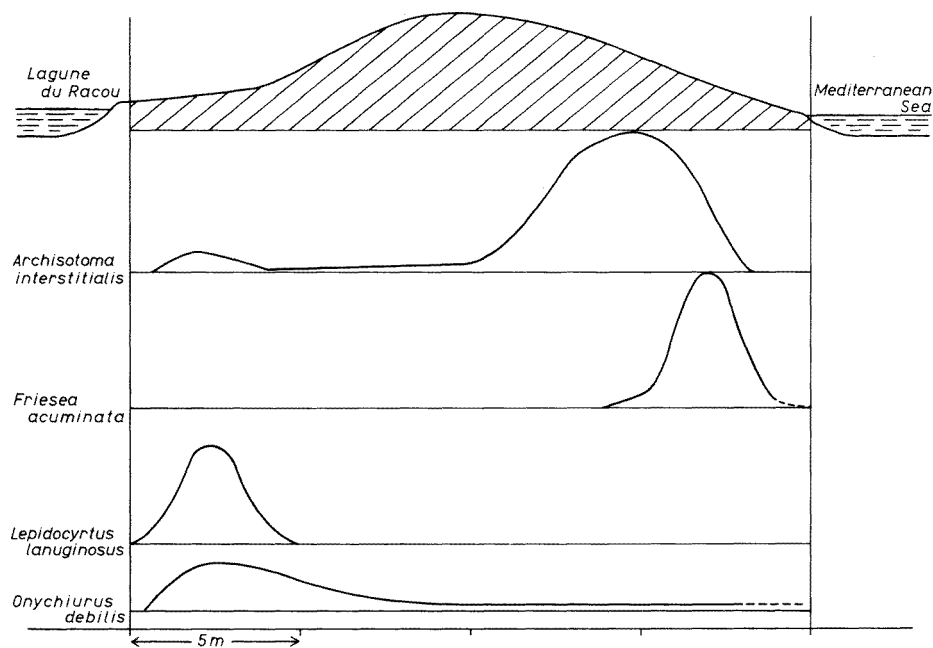

Fig. 7.21. Distribution of some thalassobiontic collembolan species at different distances from the Sea (after Delamare Deboutteville, 1953).

*maritima* in the upper intertidal zone. In cool temperate regions of abundant rainfall, there may be extensive marshland, extending into inland meadows. Studies on such regions are available for northern Europe: Linnaniemi (1907) on the Finnish coast; Dürkop (1935) and Strenzke (1949, 1954, 1955) on the salt-marshes of northern Germany, the latter studies devoted mainly to the taxonomy of the Collembola, and Rüppell (1967) and Weigmann (1971, 1973) on general ecology.

Coast habitats with muddy or sandy bottoms retain water of higher salinity as shown in the Wadden Zee of the North Sea where salinities vary from more than 30 to 18‰ near the rivers. The upper zones resemble terrestrial habitats in a number of ways. The salt gradient and difference in tidal activity causes the development of distinct floral and faunal zonation. In the *Puccinellietum maritimae* area, which is rather often submerged by seawater and has a salinity of 15‰, *Isotoma maritima*, *Archisotoma pulchella* and *Onychiurus debilis* are found. These species are considered to be obligatory thalassobiontics and are presumably resistant to submersion. *A. pulchella* is known to take refuge in crevices during high tides.

In the higher *Juncetum gerardi* (syn. *Festucetum rubrum litorale*) zone, which is less often submerged and has a salinity of about 12‰, *Folsomia sexoculata* is the dominant species. Further up the gradient where the salinity is about 5‰,

salt-tolerant ubiquitous species are found, e.g., *Xenylla humicola*, *Folsomia fimetaria*, *Isotomiella minor*, *Proisotoma minuta*, *Onychiurus armatus* and *Tullbergia quadrispina*.

The wrack is a characteristic habitat of several Collembola species (Dürkop, 1934; Backlund, 1945; Strenzke, 1961, 1963; Moeller, 1965). The important ecological factors of this habitat such as waves, rainfall, wind and violent fluctuations in temperatures have been discussed by Remmert (1960a,b, 1961). The various stages in decomposition of the algae presumably provide different types of food. The wrack cannot be considered as a typical marine habitat and many eurytopic species can be found (Moeller, 1965). Collembola usually inhabit the deeper regions of wrack where environmental fluctuations are somewhat stabilized and where the conditions resemble terrestrial habitats. *Folsomia sexoculata* and *Isotoma maritima* are found in fresh wrack. When decomposition proceeds, *Hypogastrura viatica* (often in enormous masses), *Xenylla humicola*, *Proisotoma schoetti* and *P. crassicauda* are frequently encountered. Since these species also occur in inland situations, especially in dung, presumably the decaying nitrogenous substrate attracts them. All wrack species are known to feed on plant debris.

The marine thysanuran *Petrobius* can be found in considerable numbers on stones and cliffs immediately above high-water mark in Europe. *Neomachilis halophila* (Benedetti, 1973) has been found in similar habitats in California. Although *Petrobius* is considered to be confined to coastal rocks, it has been recorded a short distance from the sea (Carpenter, 1913). *Petrobius maritimus* in fact occurs extensively inland in several widely separated districts on the west coast of Britain (Lack, 1932; Bitsch, 1958; Davies, 1966; Morgan, 1968; Davies and Richardson, 1970).

There has been much confusion in the identification of the species of *Petrobius*. Davies and Richardson (1970, 1973) have synonymized all European species to *P. maritimus* and *P. brevistylis*. A third species had been found, *P. lohmanderi* along the eastern coasts of Sweden (Hågvar, 1969).

In areas where the two main species occur together, a considerable degree of habitat separation can sometimes be noticed: *P. brevistylis* occupies sites with access to large continuous rock surfaces, while *P. maritimus* normally occupies the upper surfaces of smaller stones. The average population density is greater in *P. brevistylis* than in *P. maritimus*. For this reason *P. brevistylis* is considered to be the more successful species in Britain, and perhaps the extended distribution of *P. maritimus* inland is the result of competition between the two species (Davies and Richardson, 1970). Interspecific competition between *P. maritimus* and *P. brevistylis* appears to be reduced when conditions are favorable for both species (Davies and Richardson, 1973). Laboratory experiments on *P. maritimus*

have shown it may prefer fresh water to salt water (Willem, 1924). Moreover, this species feed on unicellular green algae and lichens which are more abundant in inland terrestrial habitats (Benedetti, 1973).

Adult Thysanura normally remain at rest during the day on the underside of rocks. They can be found motionless in local aggregations within the crevices. The size of these aggregates and their location appeared to vary with the age of the individuals. The juvenile stages which are also active during the day (Fig. 7.22)

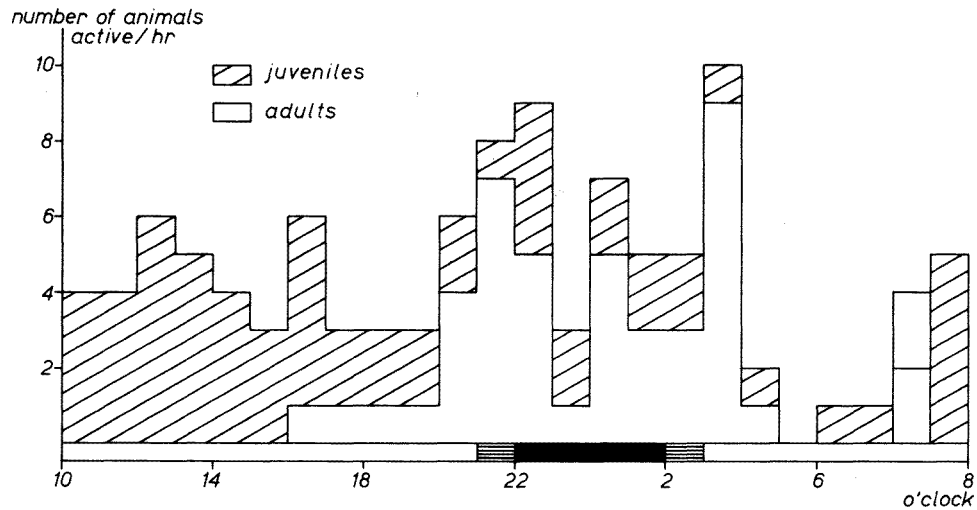

Fig. 7.22. Diurnal activity of *Petrobius brevistylis* (after Rüppell, 1967).

can be found in clusters of several hundred individuals on exposed rock surface. They respond to a variety of biological (presumably pheromones) and abiotic stimuli and have very little organization (Delany, 1959b).

### 7.5.2 Specific adaptations to marine environments

Little is known of the special adaptations of apterygotes to the marine environments. Some specific studies relating to such adaptations will be discussed in this section.

Morphological differences between marine and terrestrial species of Apterygota are not apparent. Massoud (1971) draws attention to the big lamellae on the mucro of *Pseudanurida* living in marine sandy substrates and on coral reefs, permitting them to walk on the water surface. Rapoport (1969) studied the relation of pigmentation of Collembola to their habitat and found a direct correlation with geographical location, both latitudinal and altitudinal (Fig. 7.23). Low temperatures favor melanin formation, resulting in more dark-colored populations.

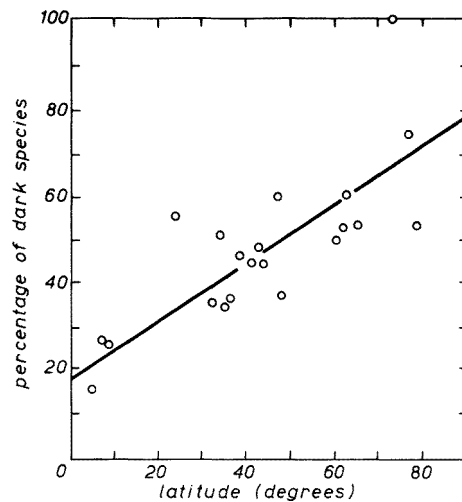

Fig. 7.23. Percentage of dark species of Collembola at different latitudes (after Rapoport, 1969).

About 80% of the species mentioned in this chapter are dark, often blue-black in color. The dark color may help in heat absorption. Several marine Collembola are known to be active only during the day: *Hypogastrura viatica*, *H. vernalis* (Rüppell, 1967) (Fig. 7.24), and also *Anurida maritima* (Imms, 1906; Joosse, 1966). Schuster (1965) found *Anurida* active also during the night in warmer regions of tropical Brasilia. These data seem to support the importance of dark coloration as an adaptation to the environment.

In general Apterygota are relatively resistant to low temperatures (Christiansen, 1964). Some forms are able to survive at temperatures as low as  $-50^{\circ}\text{C}$  and few are even active at temperatures below  $-5^{\circ}\text{C}$ , e.g., *Isotoma saltans* living on snow fields (An der Lan, 1963). There is no information on temperature tolerances in

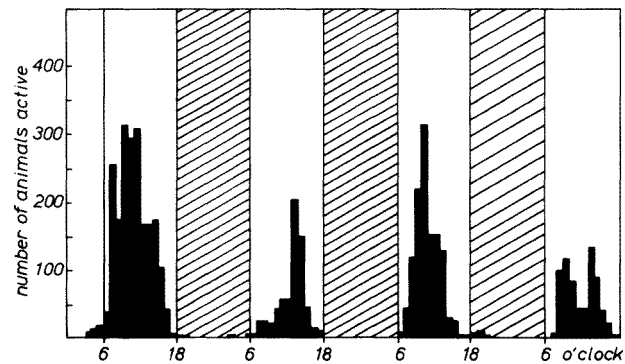

Fig. 7.24. Diurnal activity of *Hypogastrura vernalis* (after Rüppell, 1967).

marine Collembola. The bristletail *Petrobius maritimus* was found to be relatively inactive at about 0.5°C (Makings, 1973).

Weigmann (1973) studied the effects of salinity of the marine *Archisotoma pulchella*, the eurytopic *Isotoma viridis* and the terrestrial *Isotomurus palustris*. He found that the latter 2 spp. could not survive longer than a few days in fresh or saltwater, whereas *A. pulchella* could survive in water with salinities of 15–45‰ for about 17 days, but for only 2 days in freshwater.

The osmotic pressure of the haemolymph of terrestrial animals are usually in the range of 8–15‰ NaCl. Marine Collembola, which feed on hypertonic food, not only have to cope with the danger of losing water to the environment, but also gaining salts from it. Weigmann (1973) measured the osmotic pressure of the haemolymph of *A. pulchella* and *Isotoma viridis* in water of different salinities and found them able to osmoregulate to some extent. They were able to maintain their haemolymph osmotic pressure in hypotonic medium but not in hypertonic medium (Fig. 7.25). However, the osmoregulatory abilities of the two species were different. The thalassobiontic *A. pulchella* begins hypotonic regulation at salinity

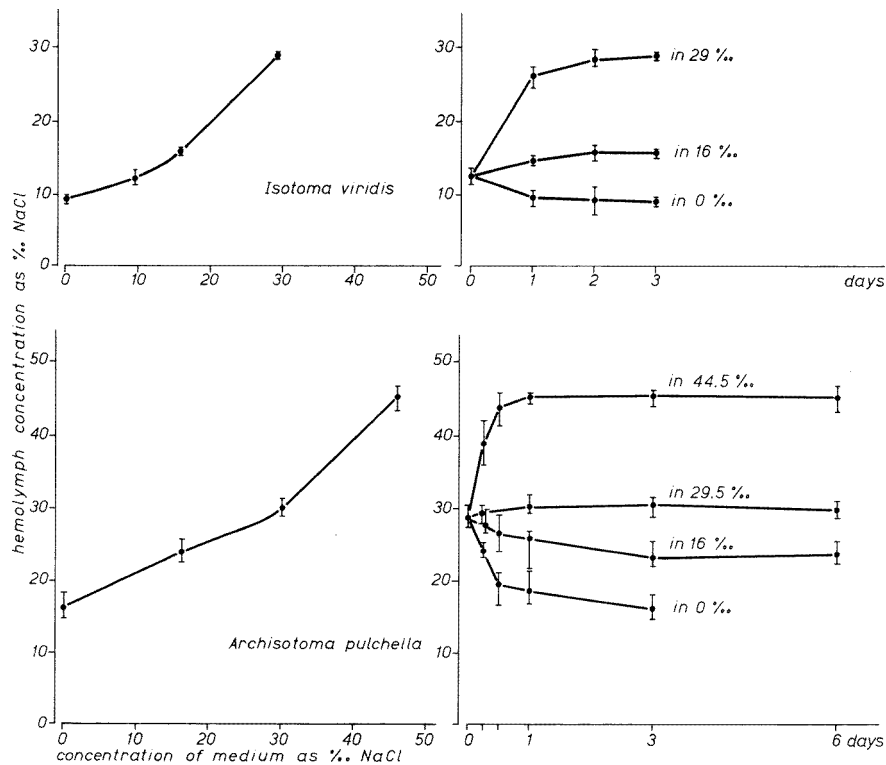

Fig. 7.25. Osmoregulation and osmotic resistance of *Archisotoma pulchella* and *Isotoma viridis* (after Weigmann, 1970).



levels equal to that of its natural habitat (30–33‰) whereas *I. viridis* has a normal salinity level of 12–15‰.

*Anurida maritima* and *Archisotoma pulchella* avoid submersion by a behavioral response (Strenzke, 1955). At low tide they can be found wandering over the substrate in search of food (Morton, 1954; Schuster, 1965; Joosse, 1966), but about one hour before the tide begins to rise, the animals move towards higher regions, where they withdraw into crevices or fissures around plant roots (Davenport, 1903). They may clump together in hundreds. Moulting and egg-laying takes place in these crevices where they are protected from submersion and wave action (Schuster, 1965; Joosse, 1966). Rainfall and darkening of the sky also induces these animals to hide in the crevices (Joosse, 1966).

In supralittoral zones, especially in saltmarshes irregular flooding by seawater or by rain may occur. Thousands of *Hypogastrura viatica* have been seen drifting about in a helpless condition, frequently blown together in dense masses on the surface of the water (Van der Kraan, 1973). This type of flooding may last for several weeks causing considerable population losses by drowning or by starvation. Laboratory experiments have shown that feeding after a temporary starvation period synchronizes the moulting as well as the reproductive rhythm (Joosse, 1971, 1976). Food limitation also tends to increase the longevity of the individuals and thus their chance to survive poor food conditions.

Mass migration of *Hypogastrura viatica* back to the original habitat usually occurs after the flood is over (Van der Kraan, 1971). This swarming behavior has been described for several other species (Willem, 1925; Davies, 1932; Sachsse, 1957) and has been reviewed by Paclt (1956). The animals move in large fronts of up to 40 m long and some 10 cm wide (Fig. 7.26), reaching a density of about 400/cm<sup>2</sup> (Fig. 7.27). They feed on the unicellular algae of the upper soil layer (Van der Kraan and Vreugdenhil, 1973) and when the food is grazed off completely, the front slowly moves forward leaving behind a bare substrate. After some days the animals disperse in clusters into the vegetation where they moult synchronously, leaving hundreds of white exuviae behind. Moulting is followed by reproduction. These reproduction peaks are thus a direct result of poor weather conditions. This system is considered to be an important mechanism for regenerating the population when many local populations become extinct (Joosse, 1976).

### 7.5.3 Population dynamics

Few studies have been carried out on population variations in marine Apterygota. Van der Kraan (1973) has investigated a population of saltmarsh *Hypogastrura viatica*. He found three generations per year and considerable fluctuations in numbers. Weigmann (1973) has some information on three other species. He found that *Folsomia sexoculata* has at least two generations a year, with a first

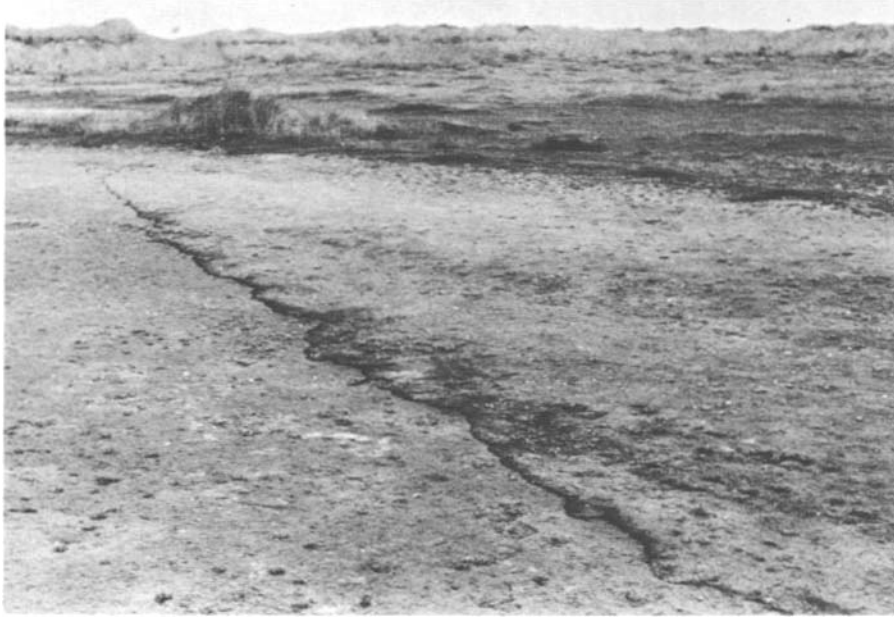

Fig. 7.26. Front of *Hypogastrura viatica* (about 40 m long) (photograph by C. van der Kraan).



Fig. 7.27. Density of *Hypogastrura viatica* in a front ( $400/\text{cm}^2$ ).

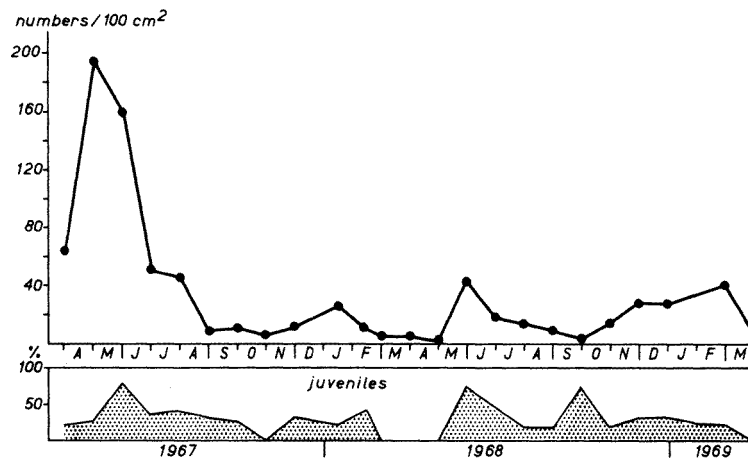

Fig. 7.28. Phenology of *Folsomia sexoculata* (from Weigmann, 1973).

maximum in May-June (Fig. 7.28); *Tullbergia krausbaueri* has two to three generations a year, with highest numbers in winter and *Isotoma viridis* also has three generations a year with a spring, summer and an autumn peak (Fig. 7.29).

The populations show considerable fluctuations in size, the causes of which are by no means completely understood. The various factors controlling birth, immigration, emigration and death have not been investigated in any detail. Presumably extreme changes of the environment cause considerable mortality (Weigmann, 1973) in some species or limit their food supply or living space (Van der Kraan, 1971, 1973).

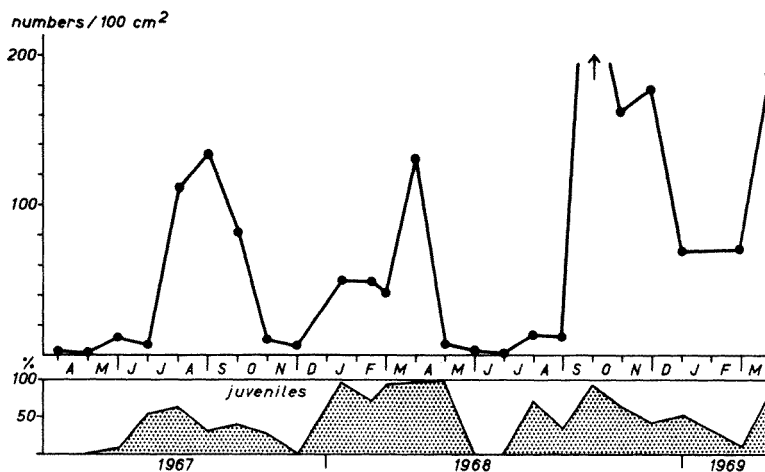

Fig. 7.29. Phenology of *Isotoma viridis* (from Weigmann, 1973).

Another important mortality factor is predation. Known predators of Collembola include a staphylinid beetle (*Micralymma marina*), a red mite (*Bdella longicornis* var. *littoralis*), a brown mite (*Hydrogamasus salinus*) a pseudoscorpion (*Neobisium maritimum*), a carabid beetle (*Aepopsis robinii*) and spiders (Erigonidae) (Glynne-Williams and Hobart, 1952; Remmert, 1960; Schuster, 1962). The most important predator of *Petrobius* are spiders of the genera *Zygiella* and *Amaurobius* (Delany, 1959a).

The role of predation as a regulatory factor has been studied in natural or semi-natural conditions in the laboratory (Sheals, 1955; Edwards, 1969; Ernsting and Joosse, 1974). However, predator-prey relationships are very complex and whether predation regulates Collembola populations in nature is not known. Often the number of predatory species is unknown and the different feeding activity of each predator adds to the complexity of the problem (Ernsting and Joosse, 1974).

A relatively simple system has been studied in a saltmarsh at Schiermonnikoog, The Netherlands (Vlijm, 1973), where a population of *Hypogastrura viatica* (Van der Kraan, 1971, 1973) has relatively few predators. One of the most important predators is the spider *Erigone arctica* (van Wingerden, 1973). The population density of *E. arctica* was clearly shown to be determined by the availability of *H. viatica*. This Collembola is also preyed upon by several other spiders (Linyphiidae: *Perimones britteni*, *Oedothorax retusus*, *Centromerita bicolor* and *Cornicularia kochi*) and Staphylinid beetles of the genus *Stenus*.

### ACKNOWLEDGEMENTS

I wish to thank Drs. W.N. Ellis for his taxonomic assistance, Drs. H.A. Verhoef for his constructive criticism of the text, and Mr. G.W.H. van den Berg for drawing the figures.

### REFERENCES

- Agrell, I. (1941) Zur Ökologie der Collembolen. Opusc. Entomol., Suppl. 3, 1–236.
- Agrell, I. (1944) Die schwedischen Thysanuren. Opusc. Entomol. 9, 23–36.
- Agrell, I. (1948) Studies on the postembryonic development of Collemboles. Ark. Zool. 41A, 1–35.
- Altner, H. (1963) Beiträge zur Systematik und Ökologie der Collembolen norwegischer Küsten. Sarsia 10, 35–55.
- An der Lan, H. (1963) Tiere im Ewigschnee-Gebiet. Umschau Wiss. Tech. 2, 49–52.
- Backlund, H. (1945) Wrackfauna of Sweden and Finland. Opusc. Entomol. Suppl. 5, 1–236.
- Beament, J.W.L., Noble-Nesbitt, J. and Watson, J.A.L. (1964) The waterproofing mechanism of arthropods. III. Cuticular permeability in the firebrat *Thermobia domestica* (Packard). J. Exp. Biol. 31, 331–340.
- Bellinger, P.F. (1962) A dimorphic species of *Actaletes* (Collembola). J. NY Entomol. Soc. 52, 88–91.

- Benedetti, R. (1973) Notes on the biology of *Neomachilis halophila* on a California sandy beach. (Thysanura: Machilidae). Pan-Pac. Entomol. 49(3) 246–249.
- Betsch-Pinot, M.C. (1974) Description du spermatophore d'*Isotoma viridis* Bourlet, 1839 (Isotomidae) et comparaison des spermatophores connus dans chaque groupe de Collembolés. Rev. Ecol. Biol. Sol 11, 541–552.
- Biliński, S. (1973) Structure of the thoracic cuticle in the firebrat - *Thermobia domestica* (Packard) (Apterygota, Thysanura). Bull. Entomol. Pol. 43, 793–797.
- Bitsch, J. (1958) Etudes d'une collection de Machilidae (Ins. Thys.) du British Museum. Remarques diverses. Entomologist 91, 255–262.
- Bitsch, J. (1974) Fonction et ultrastructure des vésicules exsertiles de l'abdomen des Machilides. Pedobiologia 14, 144–145.
- Bitsch, J. and Palévoidy, C. (1973) L'épithélium absorbant des vésicules coxales des Machilides (Insecta Thysanura). Z. Zellforsch. 143, 169–182.
- Boelitz, E. (1933) Beiträge zur Anatomie und Histologie der Collembolen. Darmkanal und Mitteldarmepithelregeneration bei *Tomocerus vulgaris* und *Sinella coeca*. Zool. Jb. (Anat.) 57, 375–432.
- Brinck, P., Dahl, E. and Wieser, W. (1955) On the littoral subsoil fauna of the Simrishamn Beach in Eastern Scania. K. Fysiogr. Sällsk. Lund Förh. 25(14) 109–129.
- Carpenter, G.H. (1913) The Irish species of *Petrobius*. Irish Nat. 22, 228–233.
- Cassier, P., Fain-Maurel, M.A. and Alibert, J. (1974) Relations entre la diversité des fonctions intestinales et la structure de l'épithélium mésentérique de *Petrobius maritimus* Leach (Insecte aptérygote, Thysanoure). Pedobiologia 14, 167–173.
- Christiansen, K. (1964) Bionomics of Collembola. Annu. Rev. Entomol. 9, 147–178.
- Dalai, R. and Malatesta, E. (1973) Ricerche sui Collemboli XIX. La fine struttura epicuticolare di *Podura* ed *Actaletes*. Redia 54, 135–139.
- Davenport, C.B. (1903) The Collembola of Cold Spring Beach, with special reference to the movements of the Poduridae. Cold Spring Harbor Monogr. 2, 1–32.
- Davies, L. (1966) *Petrobius maritimus* (Leach) (Thysanura) on certain Welsh mountains. Entomologist 99, 299–300.
- Davies, L. and Richardson, J. (1970) Distribution in Britain and habitat requirements of *Petrobius maritimus* (Leach) and *P. brevistylis* Carpenter (Thysanura). Entomologist 103, 97–114.
- Davies, L. and Richardson, J. (1973) Occurrence of the two *Petrobius* spp. (Thysanura) in different habitat types on Hirta, St. Kilda. Entomologist 106, 16–22.
- Davies, W.M. (1932) Swarming of Collembola in England. Nature 130, 94.
- Delamare Deboutteville, C. (1953a) Collembolés marins de la zone souterraine humide des sables littoraux. Vie Milieu 4, 290–319.
- Delamare Deboutteville, C. (1953b) La faune des eaux souterraines littorales en Algérie. Vie Milieu 4, 470–503.
- Delamare Deboutteville, C. (1960) Collembolés. In: Biologie des eaux souterraines littorale et continentale, 275–276.
- Delamare Deboutteville, C. and Bougis, P. (1951) Recherches sur le trottoir d'algues calcaires effectuées à Banyuls pendant le stage d'été 1950. Vie Milieu 11, 161–181.
- Delamare Deboutteville, C. and Massoud, Z. (1964) Collembolés marins interstitiels des plages de Madagascar. Vie Milieu suppl. 17, 381–392.
- Delany, M.J. (1959a) The life histories and ecology of two species of *Petrobius* Leach, *P. brevistylis* and *P. maritimus*. Trans. R. Soc. Edin. 63(3) 501–533.
- Delany, M.J. (1959b) Group formation in the Thysanura. Anim. Behav. 7, 70–75.
- Dexter, R.W. (1943) *Anurida maritima*: an important seashore scavenger. J. Ecol. Entomol. 36, 797.
- Dürkop, H. (1934) Die Tierwelt der Anwurfzone der Kieler Förde. Schr. Naturwiss. Ver. Schleswig-Holstein 20(2) 480–540.

- Dürkop, H. (1935) Collembolen der unterirdischen Feuchtzone am Meeresstrande der Kieler Bucht. Schr. Naturwiss. Ver. Schleswig-Holstein 21(1) 133–135.
- Dyar, H.G. (1890) The number of moults in lepidopterous larvae. *Psyche* 5, 420–422.
- Edwards, C.A. (1969) Soil pollutants and soil animals. *Sci. Am.* 220, 4.
- Eisenbeis, G. (1974) Licht- und elektronenmikroskopische Untersuchungen zur Ultrastruktur des Transportepithels am Ventraltubus arthropleoner Collembolen (Insecta). *Cytobiology* 9, 180–202.
- Eisenbeis, G. and Wichard, W. (1974) Histochemische Chloridnachweis im Transportepithel am Ventraltubus arthropleoner Collembolen. *J. Insect Physiol.* 21, 231–236.
- Ernsting, G. and Joosse, E.N.G. (1974) Predation on two species of surface dwelling Collembola. A study with radio-isotope labelled prey. *Pedobiologia* 14, 222–231.
- Fain-Maurel, M.A. and Cassier, P. (1974) Etude comparée de l'aptitude fonctionnelle des reins céphaliques et de l'appareil excréteur abdominal chez *Petrobius maritimus* Leach (Insecte aptérygote, Thysanoure). *Pedobiologia* 14, 173–176.
- Fernald, H.T. (1890) The relationships of Arthropods. *Stud. Biol. Lab. John Hopkins Univ.* 4, 431–513.
- Feustel, H. (1958) Untersuchungen über die Exkretion bei Collembolen. *Z. Wiss. Zool. (Leipzig)* 161, 209–238.
- Folsom, J.W. (1900) The development of the mouth-parts of *Anurida maritima* Quér. *Bull. Mus. Comp. Zool. Harvard Coll.* 36, 87–157.
- Ghiradella, H. and Radigan, W. (1974) Collembolan cuticle: wax layer and antiwetting properties. *J. Insect Physiol.* 20, 301–306.
- Gisin, H. (1960) Collembolenfauna Europas. *Genf. Nat. Hist. Mus.* 1–312.
- Gisin, H. (1968) A cavity-slide technique for preparing permanent fluid preparations of small organisms. *Rev. Ecol. Biol. Sol* 5, 581–583.
- Gisin, H. (1970) Liquides pour la fixation, l'étude, le montage de la conservation des Collembolen. *Rev. Ecol. Biol. Sol* 7, 45–49.
- Glynne-Williams, J. and Hobart, J. (1952) Studies on the crevice fauna of a selected shore in Anglesey. *Proc. Zool. Soc. Lond.* 122, 797–825.
- Hågvar, S. (1969) *Dilta* sp. (Thysanura) in Norway. *Norsk Entomol. Tidsskr.* 16(1) 39–40.
- Hale, W.G. (1965) Observations on the breeding biology of Collembola. *Pedobiologia* 5, 146–152, 161–177.
- Hale, W.G. and Smith, A.L. (1966) Scanning electron microscope studies of cuticular structures in the genus *Onychiurus* (Collembola). *Rev. Ecol. Biol. Sol* 3, 343–354.
- Handschin, E. (1929) Urinsekten oder Apterygota. In: (F. Dahl, Ed.). *Die Tierwelt Deutschlands* 16, 1–150.
- Healey, I.N. (1967) The population metabolism of *Onychiurus procampatus* Gisin (Collembola). In: (O. Graff and J.E. Satchell, Eds.). *Progress in Soil Biology.* , 127–137.
- Heeg, J. (1967) Studies on Thysanura I. The water economy of *Machiloides delanyi* Wygodzinsky and *Ctenolepisma longicaudata* Escherich. *Zool. Africana* 3(1) 21–41.
- Hinton, H.E. (1964) Spermtransfer in insects and the evolution of haemocoelic insemination. In: *R. Entomol. Soc. Lond. Symp.* 3, Insect Reproduction, (K.C. Higham, Ed.) 95–107.
- Humbert, W. (1974) Localisation, structure et genèse des concrétions minérales dans le mésentéron des Collembolen Tomoceridae (Insecta, Collembola). *Z. Morphol. Tiere* 78, 93–109.
- Imms, A.D. (1906) *Anurida*. *Liverpool Mar. Biol. Commun. Mem.* 13, 1–99.
- Joosse, E.N.G. (1966) Some observations on the biology of *Anurida maritima* (Guérin), (Collembola). *Z. Morphol. Ökol. Tiere* 57, 320–328.
- Joosse, E.N.G. (1969) Population structure of some surface dwelling Collembola in a coniferous forest soil. *Neth. J. Zool.* 19(4) 621–634.
- Joosse, E.N.G. (1971) Ecological aspects of aggregation in Collembola. *Rev. Ecol. Biol. Sol* 8, 91–97.

- Joosse, E.N.G. (1975) Feeding activity and availability of food in Collembola. In: Progress in Soil Zoology. (J. Vanék, Ed.) *Proc. Vth Int. Coll. Pedobiol.* 315–324.
- Joosse, E.N.G. (1976) The role of food in the population dynamics of *Orchesella cincta* (Linné) (Collembola). *Neth. J. Zool.* (In press.)
- Joosse, E.N.G., Brugman, F.A. and Veld, C.J. (1973) The effects of constant and fluctuating temperatures on the production of spermatophores and eggs in populations of *Orchesella cincta* (Linné), (Collembola, Entomobryidae) *Neth. J. Zool.* 23(4) 488–502.
- Joosse, E.N.G. and Kapteyn, J.M. (1968) Activity-stimulating phenomena caused by field-disturbance in the use of pitfall-traps. *Oecologia (Berl.)* 1, 385–392.
- Joosse, E.N.G. and Veltkamp, E. (1970) Some aspects of growth, moulting and reproduction in five species of surface-dwelling Collembola. *Neth. J. Zool.* 20(3) 315–328.
- Joosse, E.N.G. and Verhoef, H.A. (1974) On the aggregational habits of surface dwelling Collembola. *Pediobiologia* 14, 245–249.
- Kraan, C. van der (1971) Some aspects of field-dependent distribution in a population of *Hypogastrura viatica* Tullb. 1872. *Rev. Ecol. Biol. Sol.* 8, 99–102.
- Kraan, C. van der (1973) Populations-ökologische Untersuchungen an *Hypogastrura viatica* Tullb. 1872 (Collembola) auf Schiermonnikoog. *Faun. Ökol. Mitt.* 4, 197–206.
- Kraan, C. van der and Vreugdenhil, P.A. (1973) Presence and accessibility of food for *Hypogastrura viatica* Tullb. 1872 (Collembola-Hypogastruridae). *Neth. J. Zool.* 23(1) 125–129.
- Krzysztofowicz, A., Jura, C. and Biliński, S. (1974) Ultrastructure of midgut epithelial cells of *Tetradontophora bielensis*. *Pediobiologia* 14, 165–166.
- Krzysztofowicz, A., Klag, J. and Komorowska, B. (1972) The fine structure of the cuticle in *Tetradontophora bielensis* (Waga), Collembola. *Acta Biol. Cracov.* 15, 113–119.
- Laboulbène, A. (1864) Recherches sur *Anurida maritima*. *Ann. Soc. Entomol. France* 4, 705–720.
- Lack, D. (1932) Further notes on insects from St. Kilda in 1931. *Entomol. Mon. Mag.* 68, 139–145.
- Larink, O. (1968) Zur Biologie des küstenbewohnenden Machiliden *Petrobius brevistylis* (Thysanura, Insecta). *Helgol. Wiss. Meeresunters.* 18, 124–129.
- Lawrence, P.N. and Massoud, Z. (1973) Cuticle structures in the Collembola (Insecta). *Rev. Ecol. Biol. Sol.* 10, 77–101.
- Lindenmann, W. (1950) Untersuchungen zur postembryonalen Entwicklung schweizerischer Orchesellen. *Rev. Suisse Zool.* 57, 353–428.
- Linke, O. (1939) Die Biota des Jadebusenwattes. *Helgol. Wiss. Meeresunters.* 1, 201–348.
- Linnaniemi, W.M. (1907) Die Apterygotenfauna Finlands. I. Allgemeiner Teil. *Acta Soc. Sci. Fenn.* 34(7) 1–134.
- Lison, L. (1939) Excrétion intestinale et athrocytose discriminante chez *Machilis maritima* (Thys.). *C.R. Soc. Biol.* 132, 309–310.
- Lower, H.F. (1958) The integument of two Apterygota: *Ctenolepisma longicaudata* Esch (Thysanura) and *Sminthurus viridis* L. *J. Morphol.*, 103, 331–351.
- Lubbock, J. (1873) Monograph of the Collembola and Thysanura. *R. Soc. Lond.*, 1–276.
- Maclagan, D.S. (1932) An ecological study of the 'Lucerne flea' (*Sminthurus viridis* L.). *Bull. Entomol. Res.* 23, 101–145, 151–190.
- Makings, P. (1973) Activity of the sea-shore brittle-tail *Petrobius maritimus* (Leach) (Thysanura) at low temperatures. *J. Anim. Ecol.* 42, 585–598.
- Mani, M.S. (1968) Ecology and Biogeography of High Altitude Insects. ( ) 1–527.
- Martoja, R. (1972) Données histophysiologiques sur les accumulations minérales et puriques des Thysanoures (Insectes, Apterygotes). *Arch. Zool. Exp. Gen.* 113, 565–578.
- Massoud, Z. (1967) Monographie des Néanuridae, Collemboles Poduromorphes à pièces buccales modifiées. In: *Biologie de l'Amérique Australe* (C. Delamare Deboutteville and E. Rapoport, (Eds.), III, 1–399.

- Massoud, Z. (1969) Étude de l'ornamentation épicuticulaire du tégument des Collemboles au microscope électronique a balayage. C.R. Acad. Sci. Paris. 268, 1407–1409.
- Massoud, Z. (1971) Un élément caractéristique de la pedofaune: les Collemboles. In: La Vie dans les Sols; Aspects Nouveaux, Etudes Expérimentales. (P. Pesson, Ed.) 337–388.
- Mayer, H. (1957) Zur Biologie und Ethologie einheimischer Collembolen. Zool. Jb. (Syst. Ökol. Geogr.) 85, 501–570.
- Maynard, E.A. (1951) The Collembola of New York State. ( ), 1–339.
- Milne, S. (1960) Studies on the life histories of various species arthropleone Collembola. Proc. R. Entomol. Soc. Lond. 35, 133–140.
- Moeller, J. (1965) Ökologische Untersuchungen über die terrestrische Arthropodenfauna im Anwurf mariner Algen. Z. Morphol. Ökol. Tiere 55, 530–586.
- Morgan, M.J. (1968) Thysanura in Caernarvonshire. Entomologist 101, 73–75.
- Morton, J.E. (1954) The crevice faunas of the upper intertidal zone at Wembury. J. Mar. Biol. Assoc. U.K. 33, 187–224.
- Noble-Nesbitt, J. (1963a) A site of water and ionic exchange with the medium in *Podura aquatica* L. (Collembola, Isotomidae). J. Exp. Biol. 40, 701–711.
- Noble-Nesbitt, J. (1963b) Transpiration in *Podura aquatica* L. and the wetting properties of its cuticle. J. Exp. Biol. 40, 681–700.
- Nutman, S.R. (1941) Function of the ventral tube in *Onychiurus armatus* (Collembola). Nature 148, 168–169.
- Paclt, J. (1956) Biologie Der Primär Flügellosen Insekten. ( ) 1–258.
- Palissa, A. (1964) Apterygota-Urinsekten. Tierw. Mitteleuropas Bd. IV Lief. Ia, 1–407.
- Paulus, H.F. (1971) Einiges zur Cuticula-Struktur der Collembolen mit Bemerkungen zur Oberflächenskulptur der Cornea. Rev. Ecol. Biol. Sol. 8, 37–44.
- Petersen, H. (1971) Parthenogenesis in two common species of Collembola: *Tullbergia krausbaueri* (Börner) and *Isotoma notabilis* Schäffer. Rev. Ecol. Biol. Sol 8, 133–138.
- Poinsot, N. (1965) Révision du genre *Archisotoma* Linnaniemi 1912. Rev. Ecol. Biol. Sol 2, 453–459.
- Poinsot, N. (1971) Révision systématique et biogéographie d'*Isotoma maritima* Tullberg (Collembola). Nouv. Rev. Entomol. 1, 329–333.
- Prowazek, S. (1900) Bau und Entwicklung der Collembolen. Arb. Zool. Inst. Univ. Wien 12, 335–370.
- Rapoport, E.H. (1969) Gloger's rule and pigmentation of Collembola. Evolution 23, 622–626.
- Remmert, H. (1960a) Der Strandanwurf als Lebensraum. Z. Morphol. Ökol. Tiere 48, 461–516.
- Remmert, H. (1960b) Jahreszeit und Makroklima in ihrer Bedeutung für die Tierwelt des Strandanwurfes. Z. Morphol. Ökol. Tiere 49, 504–520.
- Remmert, H. (1961) Der Tagesgang im Strandanwurf und seine ökologische Bedeutung. Verh. Dtsch. Zool. Ges. Saarbrücken 1961, 438–445.
- Ruppel, H. (1953) Physiologische Untersuchungen über die Bedeutung der Ventraltubus und die Atmung der Collembolen. Zool. Jb. (Zool. Physiol.) 64, 430–469.
- Rüppell, G. (1967) Tagesrhythmische und langfristige Faunenverschiebungen im marinen Supralitoral. Z. Morphol. Ökol. Tiere 60, 338–375.
- Sachsse, J. (1957) Massenwanderungen von Collembolen. Nachrichtenbl. Bayer. Entomol. 6, 54–55.
- Salmon, J. T. (1964/1965) An index to the Collembola. Bull. R. Soc. N.Z. 7, 1–651.
- Schaller, F. (1970) Collembola (Springschwänze). In: Handboek der Zoologie. IV(2) 1–72.
- Schuster, R. (1962) Das marine Litoral als Lebensraum terrestrischer Kleinarthropoden. Int. Rev. Ges. Hydrobiol. 47(3) 359–412.
- Schuster, R. (1965) über die Ökologie und Artengliederung der Thalassobionten Collembolenfauna Brasiliens. Beitr. Neotrop. Fauna 4(3) 191–208.
- Sedlag, U. (1952) Untersuchungen über den Ventraltubus der Collembolen. Wiss. Z. Martin-Luther-Univ. Halle, Math.-Naturw. Reihe 1(1–2) 93–127.
- Sharov, A.G. (1966) Basic Arthropodan Stock. ( ) 1–271.



- Sheals, J.G. (1955) The effects of DDT and BHS on soil Collembola and Acarina. In: Soil Zoology (D.K.Mc.E. Kevan, Ed.) 241–253.
- Smith, E.L. (1970) Biology and structure of some California bristletails and silverfish (Apterygota: Microcoryphia, Thysanura). Pan-Pan. Entomol. 46, 212–225.
- Stach, J. (1947/60) The Apterygotam Fauna of Poland in relation to the World Fauna of this Group of Insects. I-VIII. (: .)
- Strebel, O. (1932) Beiträge zur Biologie, Ökologie und Physiologie einheimischer Collembolen. Z. Morphol. Ökol. Tiere 25, 31–153.
- Strenzke, K. (1949) Ökologische Studien über die Collembolen-gesellschaften feuchter Boden Ost-Holsteins. Arch. Hydrobiol. 42, 201–303.
- Strenzke, K. (1954) Verbreitung und Systematik der Collembolen der Deutschen Nord- und Ostseeküste. Veröff. Inst. Meeresforsch. Bremerhaven 3, 46–65.
- Strenzke, K. (1955) Thalassobionte und thalassophile Collembola. In: Die Tierwelt der Nord- und Ostsee 36, 1–52.
- Strenzke, K. (1961) Experimentell-biozönotische Untersuchungen über die Arthropoden-Sukzession des marinen Anwurfs. Verh. Dtsch. Zool. Ges. Saarbrücken, 446–455.
- Sturm, H. (1952) Die Paarung bei *Machilis* (Felsenspringer). Naturwissenschaften 39, 308.
- Sturm, H. (1956) Die Paarung von *Lepisma saccharina* L. (Silberfischen). Zool. Anz. Leipzig. Suppl. 19, 463–466.
- Sweetman, H.L. (1934) Regeneration of appendages and molting among the Thysanura. Bull. Brooklyn Entomol. Soc. 29, 158–161.
- Sweetman, H.L. (1952) The number of instars among the Thysanura as influenced by environment. IXth Int. Congr. Entomol. Amsterdam 1, 411–415.
- Thibaud, J.-M. (1968) Cycle du tube digestif lors de l'intermue chez les Hypogastruridae (Collemboles) épigés et cavernicoles. Rev. Ecol. Biol. Sol 5, 647–655.
- Törne, E. von (1965) Erfahrungen bei der Fixierung und Konservierung von kleinen terricolen Arthropoden. Mitt. Dtsch. Entomol. Ges. 24, 67–69.
- Toth, L. (1942) Der Darmkanal der Collembolen. Magy. Biol. Kutatóintéz. Munkai 14, 397–440.
- Uchida, H. (1971/1972) Tentative key to the Japanese genera of Collembola in relation to the world genera of this order. Sci. Rep. Hirosaki Univ. 18, 64–76; 19, 19–42; 19, 37–72.
- Uchida, H. and Tamura, H. (1966) On three marine Collembola in Hokkaido. J. Fac. Sci. Hokkaido Univ. 16(1) 23–30.
- Uchida, H. and Tamura, H. (1967) Eine neue litorale Collembolen-Art von Hokkaido. J. Fac. Sci. Hokkaido Univ. 16(2) 234–237.
- Vannier, G. (1973a) Étude de la transpiration chez un Insecte Collembole au cours de son exuviation. C.R. Acad. Sci. Paris 277, 2231–2234.
- Vannier, G. (1973b) Regulation du flux d'évaporation corporelle chez un Insecte Collembole vivant dans une atmosphère totalement desséchée. C.R. Acad. Sci. Paris 277, 85–88.
- Vannier, G. (1974) Variation du flux d'évaporation corporelle et de la résistance cuticulaire chez *Tetradontophora bielensis* (Waga), Insecte Collembole, vivant dans une atmosphère à regime hygrométrique variable. Rev. Ecol. Biol. Sol 11, 201–211.
- Verhoeff, K.W. (1910) über Felsenspringer, Machiloidea. 3. Aufsatz: Die Entwicklungsstufen. Zool. Anz. Leipzig 36, 385–399.
- Vlijm, L. (1973) Struktur und Funktion, ein Thema in der Erforschung von Lebensgemeinschaften. Faun.-ökol. Mitt. 4, 149–154.
- Waldorf, E.S. (1974) Sex pheromone in the springtail, *Sinella curviseta*. Environ. Entomol. 3(6), 916–918.
- Wallwork, J.A. (1970) Ecology of Soil Animals. (, ) 1–283.
- Wallwork, J.A. (1975) Calorimetric studies on soil invertebrates and their ecological significance. In: Progress in Soil Zoology (J. Vanek, Ed.) . 231–240.

- Weigmann, G. (1971) Collembolen und Oribatiden in Salzwiesen der Ostseeküste und des Binnenlandes von Norddeutschland (Insecta: Collembola - Acari: Oribatei). Faun.-ökol. Mitt. 4, 11–20.
- Weigmann, G. (1973a) Zur Ökologie der Collembolen und Oribatiden im Grenzbereich Land-See (Collembola, Insecta-Oribatei, Acari). Z. Wiss. Zool. 186(3/4) 295–391.
- Weigmann, G. (1973b) Zur Phänologie von Collembolen im Einflussbereich des Meeres. Faun.-ökol. Mitt. 4, 185–196.
- Weyda, F. (1974) Coxal vesicles of Machilidae. Pedobiologia 14, 138–141.
- Weyda, F. and Stys, P. (1974) Coxal setal organs of Machilidae. Acta Entomol. Bohemoslov. 7, 51–52.
- Willem, V. (1920) L'habitat et les allures du Collembole marin *Actaletes*. Bull. Sci. Acad. Belg. 6, 524–540.
- Willem, V. (1924) Observations sur *Machilis maritima*. I note. Bull. Biol. France Belg. 58, 306–320.
- Willem, V. (1925) Notes éthologiques sur divers Collemboles. Bull. Acad. Belg. Sci. 11, 617–636.
- Wingerden, W.K.R.E. van (1973) Dynamik einer Population von *Erigone arctica* White (Araneae, Micryphantidae) Prozesse der Natalität. Faun.-ökol. Mitt. 4, 207–222.
- With, N.D. de and Joosse, E.N.G. (1970) The ecological effects of moulting in Collembola. Rev. Ecol. Biol. Sol 8, 111–117.
- Womersley, H. (1939) Primitive insects of South Australia. Silverfish, springtails and their allies. () pp. 1–322.
- Zinkler, D. (1966) Vergleichende Untersuchungen zur Atmungsphysiologie von Collembolen (Apterygota) und anderer Bodenkleinarthropoden. Z. Vergl. Physiol. 52, 99–144.

## Water-striders (Hemiptera: Gerridae, Veliidae, etc.)

Nils Møller Andersen John T. Polhemus

<b>Contents</b>		
8.1	Introduction	187
8.2	Classification - Key to genera of marine water-striders	189
	8.2.1 Synopsis of families	191
	8.2.2 Phylogeny	197
8.3	Biology	199
	8.3.1 Life history and seasonality	199
	8.3.2 Feeding and food preferences	206
	8.3.3 Predators	208
	8.3.4 Adaptations	209
	8.3.5 Wing polymorphism	214
	8.3.6 Tidal influence	214
	8.3.7 Range of habitat and distribution	214
	8.3.8 Distribution and dispersal	218
References		221

### 8.1 INTRODUCTION

Of perhaps 1.5 million of insects only five species of *Halobates* or ocean skaters have been successful in colonizing the open ocean.

The oceanic insects, *Halobates*, have captured the imagination of seafarers since early times, certainly as early as ships plied the open oceans. Their wonder about these fleeting whitish specks is echoed in a note by Robert McLachlan (1871) . . . ‘Long before crossing the line, on the outward voyage, I was struck by small whitish creatures which often appeared coursing with great rapidity over the surface of the ocean; at length one was captured, and I well remember my astonishment on finding it was a spider-like insect. . . If these notes should be read

Table 8.1 Marine water-striders (semiaquatic Hemiptera-Heteroptera). Classification, number of marine species, habitat preferences and geographical distribution.

Family and subfamily	Genus	Marine species	Habitat preferences	Geographical distribution
Gerridae:				
Halobatinae	<i>Asclepios</i>	4	Coastal marshes and nearshore seas	India, Taiwan, Korea, Japan
	<i>Halobates</i> , group 1	37	Nearshore seas, mangroves, lagoons	Mainland coast and islands of tropical and subtropical Indian and Pacific Ocean
	<i>Halobates</i> , group 2	5	Open ocean	Atlantic, Indian, and Pacific Ocean, between 40°N and 40°S
Trepobatinae	<i>Stenobates</i>	1	Nearshore seas	Malacca Strait
	<i>Rheumatometroides</i>	1	Estuaries	Solomon Islands
Rhagadotarsinae	<i>Rheumatobates</i>	6	Mangrove swamps and nearshore seas	U.S.A. (Florida), Mexico, Costa Rica, Trinidad, Central America
Veliidae:				
Rhagoveliinae	<i>Trochopus</i>	3	Nearshore seas, estuaries, mangroves	U.S.A. (Florida), West Indies, Central America, Venezuela, Surinam
Microveliinae	<i>Husseyella</i>	3	Estuaries, mangroves	U.S.A. (Florida), Central America, Jamaica, Brazil
Haloveliinae	<i>Xenobates</i>	1	Intertidal zone of coral coasts	N. Guinea, Admiralty Islands*, Solomon Islands*
	<i>Halovelina</i>	11	Intertidal zone of coral and rocky coasts	Islands of tropical Indian and Pacific Ocean
Mesoveliidae:	<i>Mesovelina</i>	1	Estuaries	Costa Rica
	<i>Speovelina</i>	2	Coastal caves, intertidal zone of rocky coasts	Japan, Mexico
Hermatobatidae:	<i>Hermatobates</i>	9	Nearshore seas and intertidal zone of coral coasts	Islands of tropical Indian and Pacific Ocean, West Indies, Cuba*

\* Distributional records of undescribed species.

by any one of those “who go down to the sea in ships”, I would remind him that, if he can throw any light upon the life history of this most wonderful insect, . . . he will confer the utmost benefit upon natural science’.

In this chapter we will summarize what is known of the biology of these striking insects along with the more unnoticed water-striders of the coastal regions.

## 8.2 CLASSIFICATION

All water-striders belong to the infra-order Gerromorpha (Popov), Heteroptera as defined by Štys and Kerzhner (1975). On a world basis there are 8 families, about 106 genera, and approximately 1200 species of water-striders. Of these, only a small percentage, 13 genera with about 100 species, are found in marine environments (20‰ or more in salinity). Besides this, there are a number of freshwater species that can tolerate saline waters but we have arbitrarily decided not to consider them as truly marine forms.

The eight families are Hebridae, Macroveliidae, Madeoveliidae, Hydrometridae, Gerridae, Veliidae, Mesoveliidae, and Hermatobatidae. Of these, the last four families have true marine representatives. The classification of marine water-striders, number of marine species, habitat preferences, and geographical distribution are summarized in Table 8.1.

The artificial key given here will easily separate the marine water-striders into families, subfamilies and genera, but is not usable to separate families if freshwater species are included. The Gerridae and Veliidae are particularly difficult to delineate at the family level (China and Usinger, 1949). In the following section only a short synopsis for each family is given. For more complete treatment the reader may refer to the taxonomic literature cited.

### KEY TO THE GENERA OF MARINE WATER-STRIDERS (ADULTS)

1. Claws of all legs inserted before tips of tarsi (Fig. 8.27)	2
Claws of at least middle and hind legs inserted at tips of tarsi (Fig. 8.14)	10
2. Hind femur short, length less than width of body (Veliidae)	3
Hind femur long, length greater than width of body (Gerridae)	6
3. Middle tarsi deeply cleft, with leaf-like claws and fan of plumose hairs arising from base of cleft (Fig. 8.9) (Rhagoveliinae)	<i>Trochopus</i>
Middle tarsi not deeply cleft, with or without leaf-like claws, without plumose hairs	4
4. Middle tarsi with claws and ventral arolia modified into four broad leaf-like structures (Fig. 8.11) (Microveliinae)	<i>Husseyella</i>
Middle tarsi with normal, hook-shaped claws and bristle-like arolia (Fig. 8.7) (Haloveliinae)	5
5. Middle femora each with a row of long stout hairs on outer margin	<i>Xenobates</i>
Middle femora without conspicuous hairs	<i>Halovelia</i>

6.	Abdomen with seven visible pregenital sterna, without median metasternal scent gland opening (Rhagadotarsinae)	<i>Rheumatobates</i>
	Abdomen with six visible pregenital sterna, with metasternal scent gland opening	7
7.	Middle femur distinctly shorter than tibia, middle tibia without hair-fringe (Trepobatinae)	8
	Middle femur distinctly longer than tibia, middle tibia with hair-fringe (Fig. 8.29) (Halobatinae)	9
8.	Metasternal scent gland opening of male located on a conspicuous elevation at the anterior limit of the metasternum	<i>Stenobates</i>
	Metasternal scent gland opening of male not located on a conspicuous elevation	<i>Rheumatometroides</i>
9.	Hair fringe of middle leg confined to the tibia	<i>Asclepios</i>
	Hair fringe of middle leg present on tibia and first tarsal segment (Fig. 8.1)	<i>Halobates</i>
10.	Head at least three times as wide as long; claws of front legs inserted before tips of tarsi (Fig. 8.13) (Hermatobatidae)	<i>Hermatobates</i>
	Head obviously longer than wide; all claws inserted at tips of tarsi (Mesoveliidae)	11
11.	Eyes small, about one-fourth of head length; head not strongly declivant anterad of eyes, length greater than length of thorax on midline viewed from above	<i>Speovelia</i>
	Eyes larger, one-third or more of head length; head strongly declivant anterad of eyes, length less than length of thorax on mid-line viewed from above	<i>Mesovelia</i>

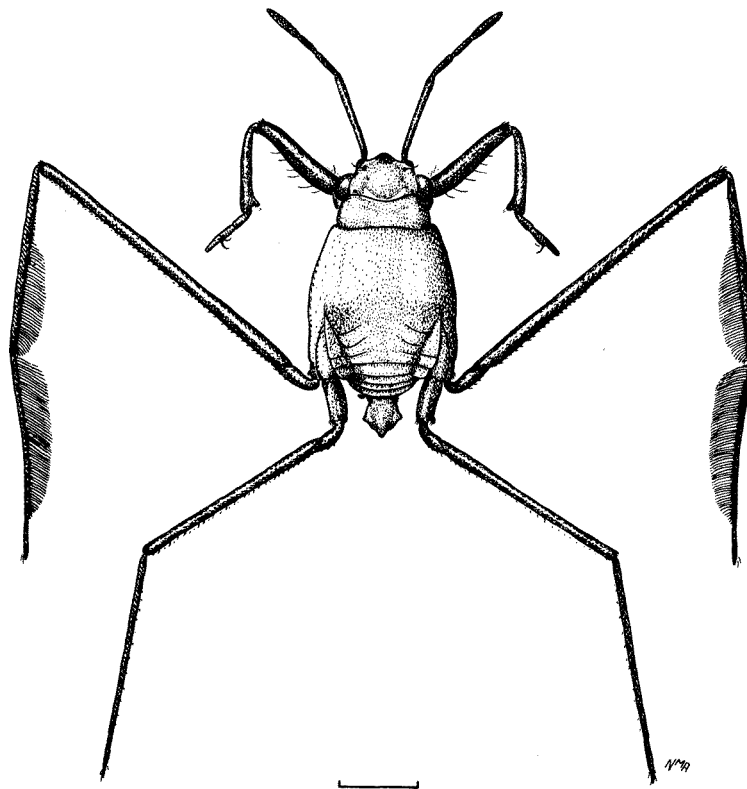

Fig. 8.1. *Halobates micans* Eschscholtz, male. Scale 1 mm.

### 8.2.1 Synopsis of families

**GERRIDAE:** The gerrids or pond-skaters are elongate or oval-bodied bugs. The antennae are 4-segmented and long. The eyes are large, globular, with a multitude of facets. The ocelli are absent. The middle thoracic segment is greatly lengthened and the points of insertion of the long, slender middle and hind legs widely separated from those of the front legs (Figs 8.1 and 2). The middle and hind coxae are inserted laterad on the body and rotated to an almost horizontal position (Fig. 8.3). The claws are inserted pre-apically on the last tarsal segment (Fig. 8.27, cl.). Most gerrids have a single, median scent gland opening on the metasternum (Fig. 8.2, mt). The body is covered by a velvety hair pile, and color ranges from black or grey to brown with the dorsum sometimes marked with light grey or yellow. All marine species known so far are wingless.

The family Gerridae contains 56 genera with about 450 species in eight subfamilies. The five genera with marine species are distributed among three subfamilies (see Table 8.1). The major works on higher classification are by Hungerford and Matsuda (1960), Matsuda (1960) and Andersen (1975).

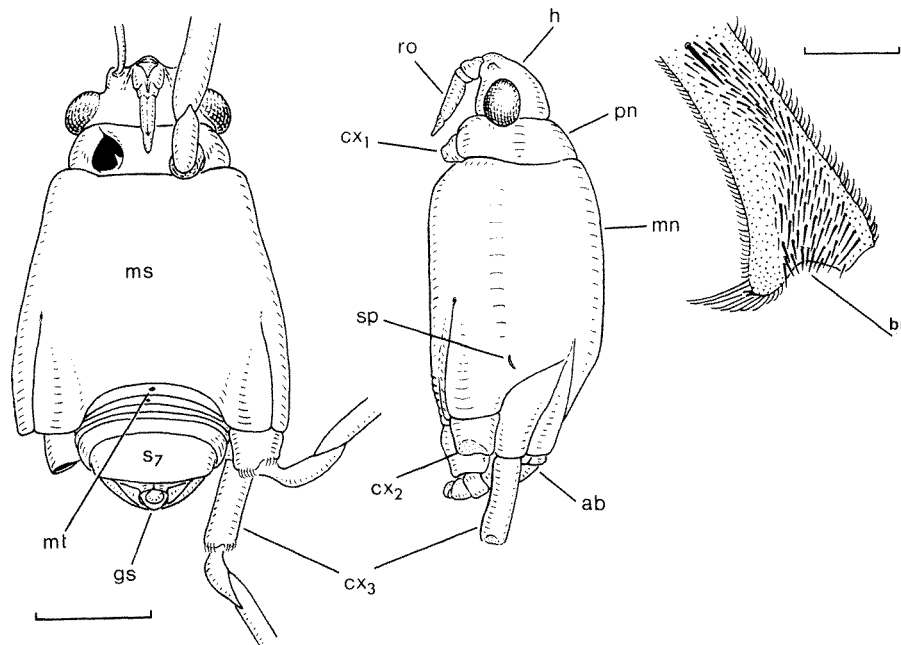

Fig. 8.2. Ventral view of female *Halobates*, legs of the right side removed. gs, genital segments; ms, mesosternum; mt, metasternum; s7, seventh abdominal sternum. Scale 1 mm.

Fig. 8.3. Lateral view of female *Halobates*. ab, abdomen; cx1, cx2, cx3, front, middle and hind coxa; h, head; mn, mesonotum; pn, pronotum; ro, rostrum; sp, second thoracic spiracle. Scale 1 mm.

Fig. 8.4. *Halobates*, apex of front tibia, inner view. br, grooming brush. Scale 0.2 mm.

The ocean skaters, *Halobates* (Fig. 8.1), is the major genus of marine gerrids containing 42 described species, of which all are truly marine and five are oceanic, living on the surface of the open ocean. They are medium-sized, 3.5–6.5 mm long, dull colored insects but owing to light interference in the hair pile of their body surface they appear greyish. The genus was described by the estonian naturalist Johann Friedrich Eschscholtz in 1922 together with three species, *micans*, *sericeus*, and *flaviventris*. The ocean skaters have been monographed by White (1883) and Herring (1961). Since then, four new species have been added: *H. trynae* (Herring, 1964), *esakii* (Miyamoto, 1967), *melleus* (Linnavuori, 1971), and *mangrovensis* (Schmidt and Mueller, 1973).

*Asclepios* is a nearshore relative of *Halobates* containing 4 species. The genus was described by Distant (1915) for *A. annandalei* from salt lakes near Calcutta. Esaki (1924a, 1930) later described three additional species.

*Stenobates* (Esaki, 1926, 1927) and *Rheumatometroides* (Hungerford and Matsuda, 1958) are closely related genera. Very little is known about these genera, each having only one species. The few records indicate that both species are marine, inhabiting estuaries and nearshore localities.

Most of the 29 species of *Rheumatobates* (Fig. 8.5) live in freshwater but 5 species are known to be euryhaline and 6 others can be considered exclusively

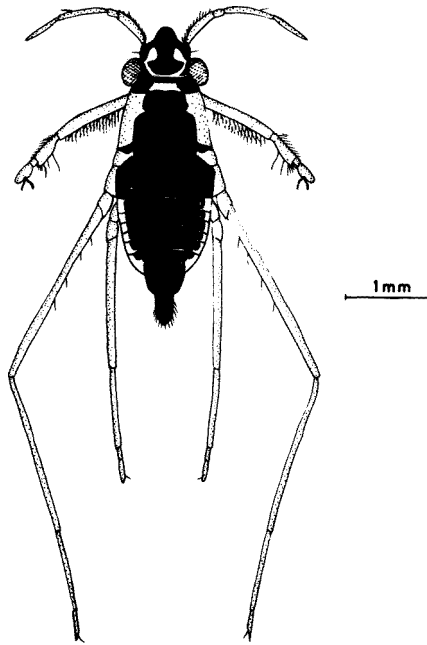

Fig. 8.5. *Rheumatobates aestuarius* Polhemus, female (from Cheng and Lewin, 1971).



marine. This genus belongs to the subfamily Rhagadotarsinae, unique among the gerrids in that females possess a well-developed ovipositor. The males of many species have curiously modified legs, antenna and abdomen. The marine species are 2–3.2 mm long. This genus demonstrates a progression of individual species preferences from strictly freshwater to marine environments. The genus was monographed by Hungerford (1954); 5 species have been added since, of which 3 are marine (Polhemus, 1969, 1975; Cheng and Lewin, 1971).

VELIIDAE: The marine veliids are small, wingless, oval bugs. The mesothorax is not as prolonged as in the gerrids and the middle and hind coxa not quite horizontal. The hind femora are short, less than the width of the body. There are channels extending laterally from the metasternal scent gland opening to the sides of the metathorax. In most other characteristics the veliids are very similar to the gerrids.

There are 30 genera with about 420 species; of these 4 genera and about 20 species are considered truly marine (see Table 8.1). The most recent papers on the higher classification of the Veliidae are those by China and Usinger (1949), and Polhemus and Chapman (1976a).

The genus *Halovelis* consists of 11 described species. These shore-dwelling bugs are rather small, 1.5–2.5 mm long, usually dull grey or black (Fig. 8.6). The pronotum is very short and the dorsum is without conspicuous markings. The middle legs are long and slender with two tarsal segments as in the other legs; the middle and hind tarsal claws are short and not quite spical (Fig. 8.7). The genus was revised by China (1957) who recognized 9 species but did not

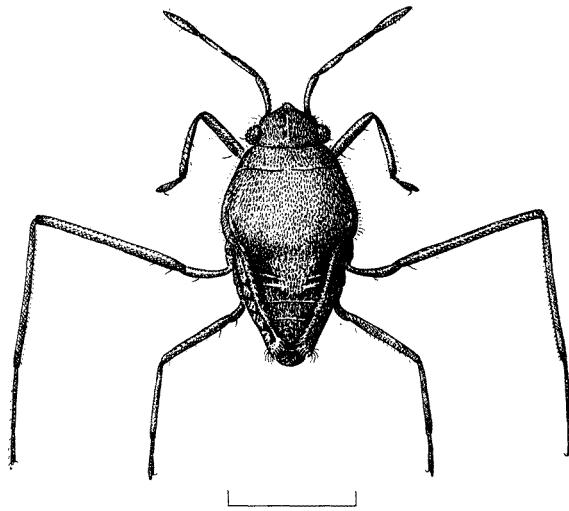

Fig. 8.6. *Halovelis septentrionalis* Esaki, female. Scale 1 mm.

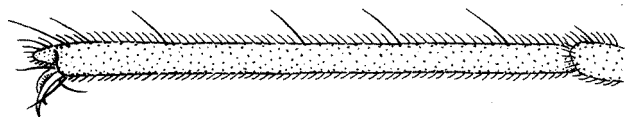

Fig. 8.7. *Halovelina*, tarsal segment prolonged.

include *H. pauliani* (Poisson, 1956), and since then Herring (1958a) described *H. danae*. The present authors have about 10 undescribed species, thus a further revision will be needed.

*Xenobates* is a close relative of *Halovelina*. The single species so far described (Esaki, 1926, 1927) was collected from a river but recent evidence indicates that this genus is marine, and found in habitats much the same as the preceding genus.

Three species of *Trochopus* are known. They are all marine, wingless, and 2–4 mm long (Fig. 8.8). This genus is a close relative of the freshwater *Rhagovelia* and both possess deeply cleft middle tarsus bearing a fan of plumose hairs which can be folded into the cleft (Fig. 8.9). They differ from *Rhagovelia* in having two,

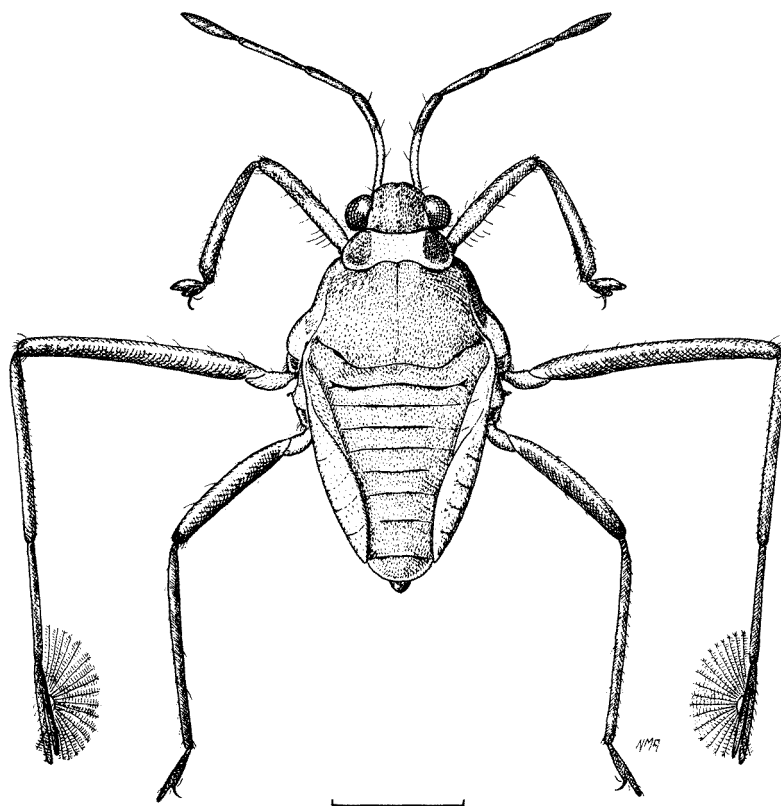

Fig. 8.8. *Trochopus plumbea* (Uhler), female. Scale 1 mm.

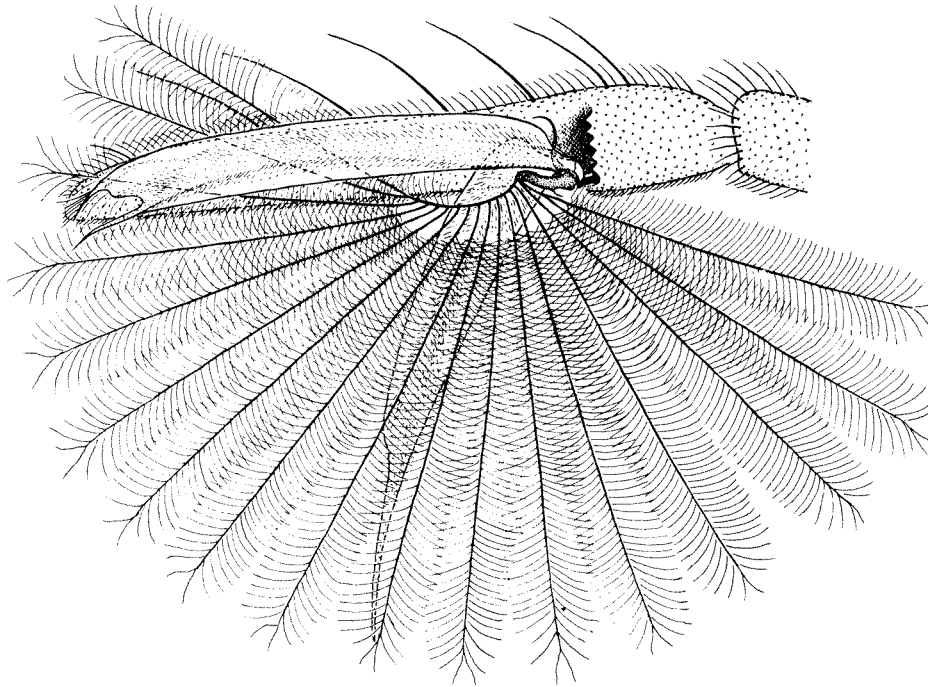

Fig. 8.9. *Trochopus*, fan of plumose hairs on last midtarsal segment; hind lobe of segment removed.

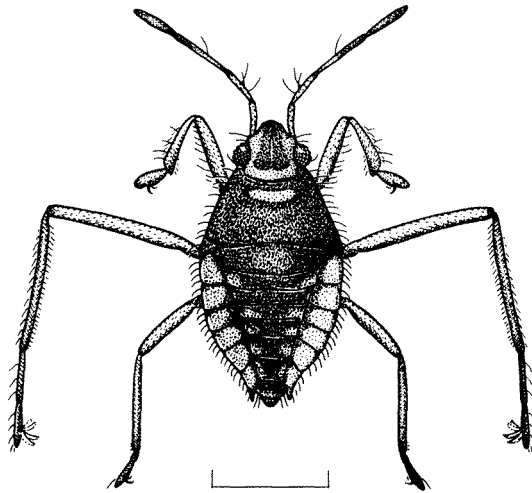

Fig. 8.10. *Husseyella turmalis* (Drake and Harris), female. Scale 1 mm.

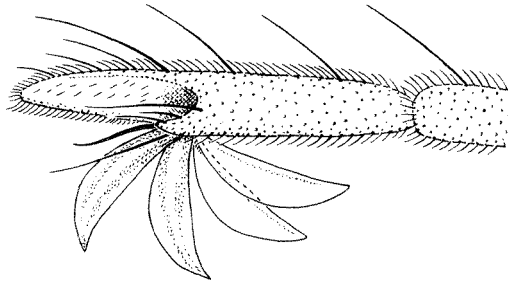

Fig. 8.11. *Husseyella*, leaf-like claws and arolium on last mid-tarsal segment.

not three, tarsal segments. *Trochopus* was reviewed by Drake and van Doesburg (1966).

*Husseyella* are small, 1.9–2.5 mm long, hairy water-striders with moderately long legs (Fig. 8.10). The most characteristic feature of this genus is the four blade-like structures arising from the middle tarsus (Fig. 8.11). Similar structures can be found in several freshwater veliids. The genus *Husseyella* was erected by Herring (1955) for the species *diffidens* (Drake and Harris) and *turmalis* (Drake and Harris), originally described as *Microvelia*. One additional species, *H. halophila* (Drake, 1958), has been described.

MESOVELIIDAE: The marine mesoveliids are elongate bugs, 2.5–4 mm with spiny legs, 3-segmented tarsi with apical claws (Fig. 8.12). They have both metasternal and dorsal abdominal scent glands and generally lack ocelli. The females have a saw-like ovipositor. Winged forms are unknown in truly marine species. They are yellow brown, with a greenish tinge when alive. The hair pile of the body is much sparser than in other families of water-striders.

This family contains 5–6 genera and about 30 species. Most mesoveliids are freshwater but some are terrestrial. Only *Speovelia* is restricted to coastal tidal areas but several freshwater *Mesovelia* can be found in marine habitats. Since the works of Horvath (1915, 1926), no one has made any comprehensive study of the family. China and Miller (1959) included it with the Macroveliidae but this proposal has been rejected by Polhemus and Chapman (1976b).

The genus *Mesovelia* contains about 20 species world-wide, but only one is known to be strictly halophilous, *M. halirrhya* (Polhemus, 1975). It is presently known only from the type locality, ponds bordering an estuary, regularly invaded by tidal water. The genus contains several freshwater species that invade the marine environment (Lindberg, 1948; Cobben, 1960; and others).

*Speovelia* is a strictly halophilous genus, containing only two species each known from a single locality. While the Japanese species, *S. maritima* (Esaki, 1929) was not observed on the surface of the water, the Mexican species, *S. mexicana* (Polhemus, 1975), was found running on tide pools.

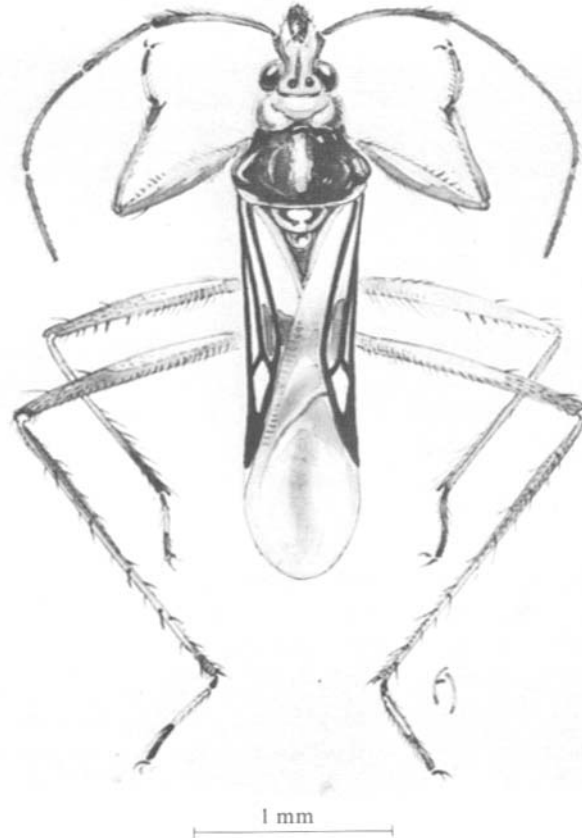

Fig. 8.12. *Mesovelia mulsanti* (White) male. (Courtesy University of California Press.)

**HERMATOBATIDAE:** This is an exclusively marine family of elongate oval, 3–4 mm long, hairy bugs with rather stout and short legs compared to other marine water-striders (Fig. 8.13). The head is widened and declivant, and the eyes granular with a reduced number of ommatidia. As in Mesoveliidae the adults have retained the dorsal abdominal scent gland. The front tarsal claws are inserted preapically, the middle and hind claws apically (Fig. 8.14). The abdomen of both sexes is modified with a high degree of fusion between segments. There are 10 known species including 2 undescribed species (China, 1956, 1957; Herring, 1965; Cheng, 1966c); some of the earlier literature has been reviewed by Cheng (1976a).

### 8.2.2 Phylogeny

The majority of water-striders are highly specialized insects adapted to a life on a very unusual substratum, the surface of water. Yet, the group contains several

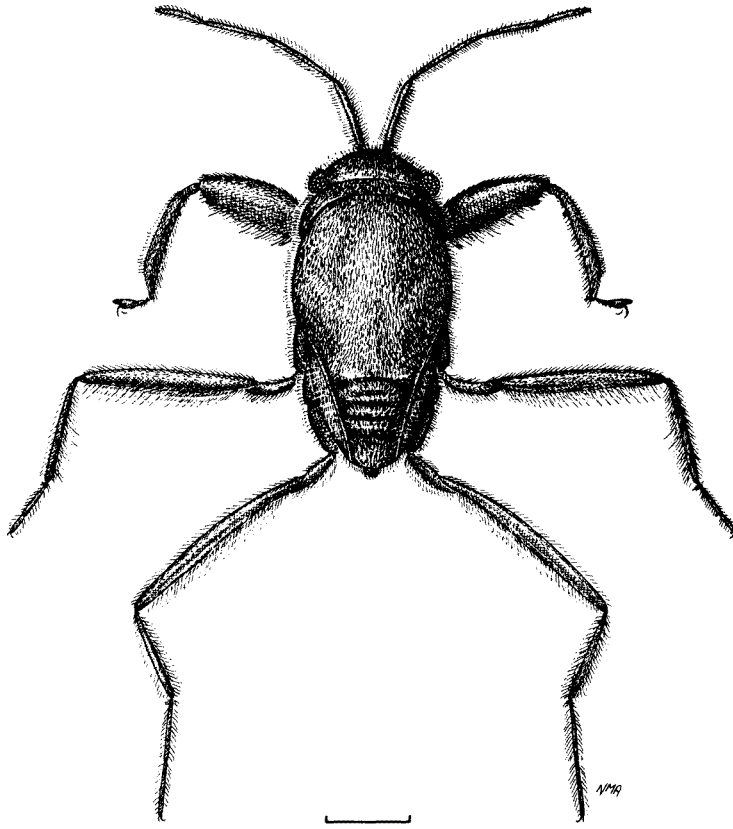

Fig. 8.13. *Hermatobates weddi* China, male. Scale 1 mm.

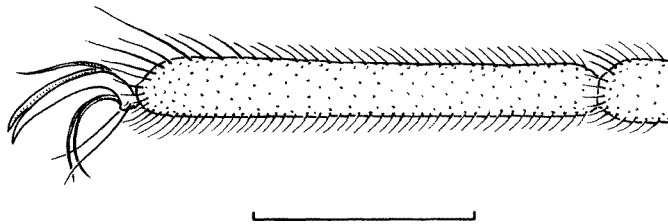

Fig. 8.14. *Hermatobates*, apical claws. Scale 0.2 mm.

relict forms, most of them living in the transitional zone between land and water (China, 1955). Recent evidence also suggests that the water-striders as a whole is a very ancient group (Cobben, 1968).

During the evolutionary history of water-striders invasion of the marine habitat has occurred at least 8 times, independent of each other. The isolated

position of the exclusively marine family Hermatobatidae, its several primitive features, and its present geographical distribution indicate that it probably represents the earliest colonizer of the marine environment (Andersen, unpublished).

Within the Gerridae and Veliidae, the marine environment has been successfully invaded several times. The present distribution of marine species belonging to these closely related families points to two centres of origin: one in the Indo-Malayan region and another on the shores of the Caribbean Sea. The wide geographical gap between these areas is probably best explained by continental drift and the relatively late formation of the Atlantic Ocean (Jaczewski, 1972).

*Halobates* probably evolved in Southeast and East Asia which are known to have a very rich gerrid fauna (Cheng and Fernando, 1969; Andersen, 1971). The more primitive sister group of *Halobates*, the coastal and saltmarsh *Asclepios*, is limited to that area. Also the closest freshwater relatives of the ocean skaters, the Metrocorini, are most abundantly represented there. Species of Metrocorini inhabit flowing waters and estuaries which likely are transitional habitats between freshwater and seawater. Herring (1961) considered the open ocean *Halobates* to be a monophyletic group. In our opinion, the characteristics peculiar to the oceanic species may well be a result of parallel evolution and the open ocean life acquired more than once. Contrary to the view of Jaczewski (1972) we believe that the colonization of the Atlantic Ocean by *H. micans* is relatively recent, probably post-pleistocene, and that the route of dispersal from the Indian and Pacific Ocean was around South Africa (see also Herring, 1961).

Other groups of marine water-striders which most probably originated in the Indo-Malayan and Papuan regions are *Stenobates-Rheumatometroides* and *Halovelia-Xenobates*; both have their closest freshwater relatives in that area (Matsuda, 1960; China and Usinger, 1949).

The Caribbean center of origin of marine water-striders contains at present three marine groups: *Trochopus*, which is derived from the stream-inhabiting *Rhagovelia*; *Husseyella*, derived from some microvelid ancestor; and *Rheumatobates* which contains both strictly freshwater and marine as well as euryhaline species. In *Rheumatobates*, the process of evolution towards the marine environment may still be active today, possibly with an additional center along the coast of the eastern tropic Pacific (see Fig. 8.33).

## 8.3 BIOLOGY

### 8.3.1 Life history and seasonality

As in other Heteroptera, the life history of water-striders includes the egg, five (rarely only four) nymphal instars, and the adult stage. Water-striders preferably

deposit their eggs at or slightly above the water-level but some gerrid species submerge completely to place their eggs below water. The structure of the egg shell, the gross embryology, and the eclosion in a great number of bugs have been studied thoroughly by Cobben (1968). In most species the elongate and sub-ovate eggs are deposited in an exposed horizontal position glued to the substratum by a gelatinous substance (Fig. 8.15). The egg shell is finely and densely porous with an inner spongy layer. The number of micropyles is generally

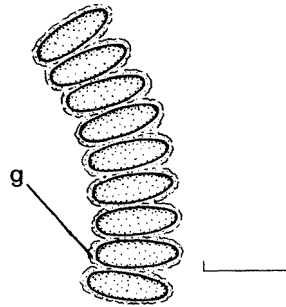

Fig. 8.15. *Halobates*, eggs laid in a row, presumably by a single female. g, gelatinous mass. Scale 1 mm.

low, only one in most gerrids (including *Halobates*) and *Halovelina*, 2–4 in most other veliids. During eclosion the shell is split open lengthwise by the embryonic egg burster (Fig. 8.16). This structure remains attached to the embryonic cuticle which is moulted immediately after eclosion.

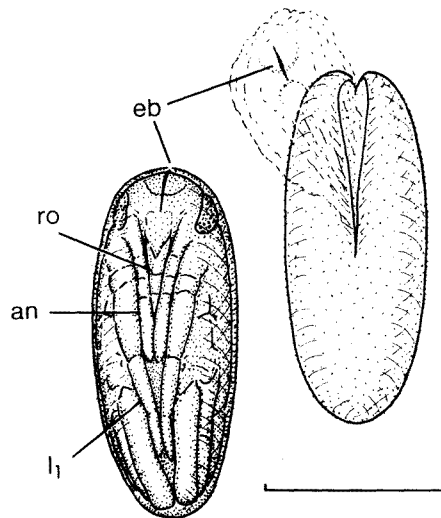

Fig. 8.16. (Right) *Halobates*, empty egg-shell with embryonic cuticle still attached. Scale 0.5 mm.

Fig. 8.17. (Left) *Halobates* sp., fully developed embryo egg, ventral view. Scale 0.5 mm.  $l_1$ , front leg; ro, rostrum; an, antenna; eb, egg-burster.



The mesoveliids deviate from other water-striders in having an elongate bottle-shaped egg which is embedded in the substrate by the well-developed female ovipositor. The shell is entirely solid without any cavities except for the single micropyle. During eclosion a lid-shaped structure opens at the anterior end of the egg. There is no egg burster.

The embryonic development of marine water-striders is probably similar to that of their freshwater relatives (see Cheng, 1966b; Cobben, 1968; Cheng and Fernando, 1971). In *Halobates* (Delsmann, 1926; Herring, 1961) the egg is deposited with its dorsal side against the substratum. During the early part of its development the egg content is yellowish or orange. Later, when the embryo becomes visible the egg becomes bright orange in color and the eyes appear as a pair of reddish spots. Appendages are light brown (Fig. 8.17). The long middle and hind legs are neatly folded around the end of the abdomen (Fig. 8.18).

The newly hatched nymph (Fig. 8.19) is very feeble, but after it has stretched out its legs and become tanned

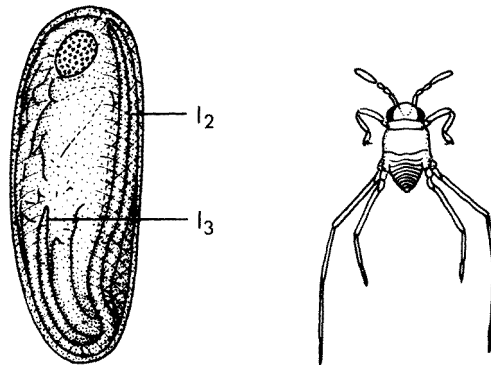

Fig. 8.18. (Left) *Halobates* sp., lateral view.  $l_2$ ,  $l_3$ , middle, and hind legs. Scale as 8.16.

Fig. 8.19. (Right) *Halobates* sp., newly hatched 1st instar nymph. Scale 1 mm.

(about 30 minutes after hatching) it becomes very active. When the eggs are submerged and hatched under water the nymphs may spend 1–2 hours trying to break through the surface film (Cheng, personal communication). The nymphs are rather similar to the adult in structure except for size, proportions of body-parts, lack of segmental differentiation of the tarsi, etc. The post-embryonic development includes five moults during which the old cuticle splits open along a dorsal Y-shaped suture on the thorax (Cheng, 1966b). The newly moulted adult is pale and soft. The so-called teneral development of the adult which includes the complete hardening and darkening of the cuticle may last for a few days or even longer (Andersen, 1973).

In most water-striders the male is slightly smaller than the female but in some cases this size difference is rather pronounced (e.g. *Trochopus* and *Halovelia*).

Mating is usually initiated by the male which lies upon the back of the female, grasping her with his front legs only (Gerridae) or with other legs as well (Veliidae). The male then attaches its genitalia to the female. In many water-striders the males remain in the riding position for quite a long time even though not engaged directly in copulation and are reluctant to release their hold even when roughly handled (e.g. *Halovelia*, Kellen, 1959; *Trochopus*, Cheng, personal communication).

The life history of individual marine water-striders is very little known. Kellen (1959) did not succeed in finding the eggs of *Halovelia marianarum* Usinger in the field but in the laboratory some were found deposited singly just above the water level in small holes in blocks of volcanic rocks. The incubation time was 18 days at an ambient temperature of 25°C which is more than twice the time required for most freshwater veliids (Cobben, 1968). The total duration of the post-embryonic development was about 40 days. Nymphs always moulted while resting on the sides of the rocks immediately above the water. A very distinct seasonal variation in abundance was observed in Tutuila Island, Samoa, with the peak frequency occurring from December to February.

In *Halobates* the coastal species probably lay their eggs in coral rocks near shore. Although Herring (1961) was not able to induce females of *H. hawaiiensis* Usinger, a coastal species, to deposit eggs on any floating material, hundreds of eggs were found in the cracks of a concrete tank in which these insects were held. Obviously, this egg-laying habit renders it almost impossible to find eggs deposited in the field. However, there exist numerous records of *Halobates* eggs found attached to all kinds of floating material, e.g. seaweed, cork (Fig. 8.20), *Spirula* and *Sepia* shells, floating timber, tar lumps, bits of coal, birdfeathers or even to the tailfeathers of a living seabird (Fig. 8.21). (Lundbeck, 1914; Herring, 1961; Savilov, 1967; Scheltema, 1968; Cheng, 1972, 1973c,e, 1974a). Many of these egg-bearing objects have been collected far from land and the eggs are most likely deposited by species of the open ocean group.

Lundbeck (1914) first pointed out that the eggs of *Halobates* could be divided into several groups on the basis of the structure of the surface of the shell. He found eggs dissected from the ovaries of female *H. micans*, *sericeus*, and *sobrinus*, to be smooth. In a few of the species examined by Herring (1961), e.g. the open ocean *H. germanus*, the shell is covered with a fine polygonal pattern. Both authors also found highly sculptured eggs attached to floating material some of which had branched, thorn-like processes, crenulations or finger-like projections (Figs 8.22 and 8.23; Cheng, unpublished).

The eggs of *Halobates* are large (1–1.2 mm) compared to size of female (rarely exceeds 5 mm). The number of mature or semi-mature eggs found in the body cavity of a gravid female may range from 10 to 40. To accommodate all these eggs, the abdomen is often expanded to nearly twice its normal length (Figs 8.24 and 8.25) and the thoracic cavity is also packed with eggs. The number of eggs laid

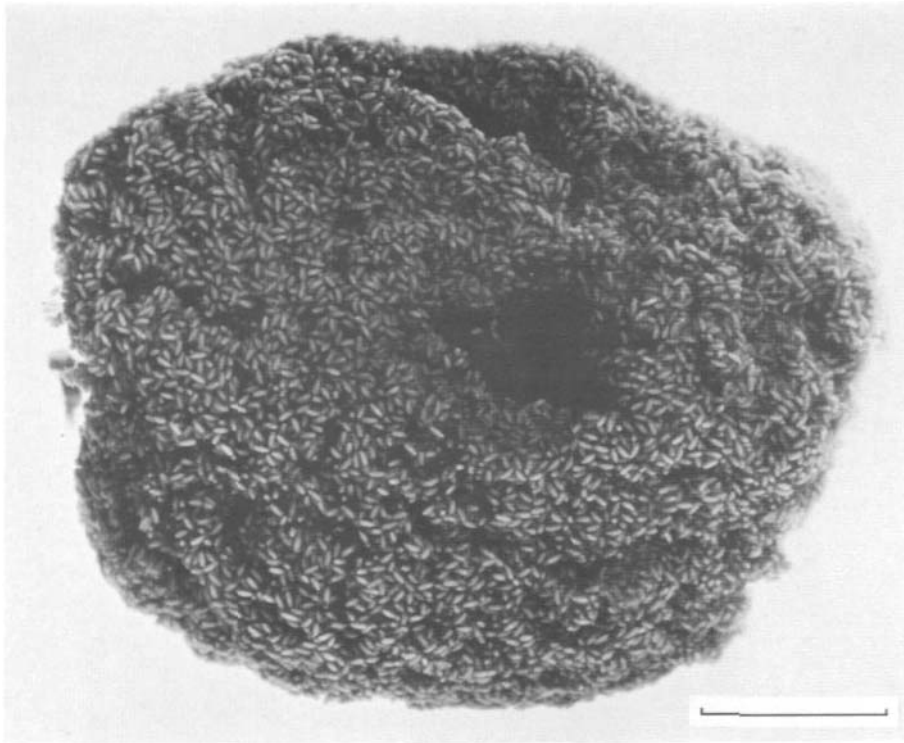

Fig. 8.20. *Halobates*-eggs in dense masses on a piece of cork from the Atlantic Ocean (14N, 27W; Zool. Mus., Copenhagen). The estimated number of eggs is about 100000. Scale 10 mm.

by a single female is difficult to estimate since the egg-masses attached to floating objects most certainly are the result of combined efforts of several females. For instance, the piece of cork depicted in Fig. 8.20 is completely covered by almost 10 layers of eggs on top of each other. The total number of eggs was estimated to be about 100,000! It is possible that a few thousand females may have been engaged in forming this astonishing concentration of eggs. This may indicate a rather high population density of ocean skaters in the area as well as a scarcity of floating materials available for oviposition. Relatively few eggs have been found on other floating objects. In freshwater gerrids one female may lay as many as 250 eggs during six weeks (Andersen, 1973). The fecundity of ocean skaters may be similar.

Some earlier authors believed that female *Halobates* may carry eggs on their abdomens for a short time until a suitable place of deposition was found (Walker, 1893; Lundbeck, 1914; etc.). The specimens in question were probably dead at the time of collection and other females have used their bodies for oviposition just as any floating object. This has been observed among ocean skaters left in a collecting tube overnight (Andersen, personal observation).



Fig. 8.21. Tail of seabird (common nody, *Anous stolidus* (L.)) with numerous *Halobates* eggs (Zool. Mus., Copenhagen). Scale 20 mm.

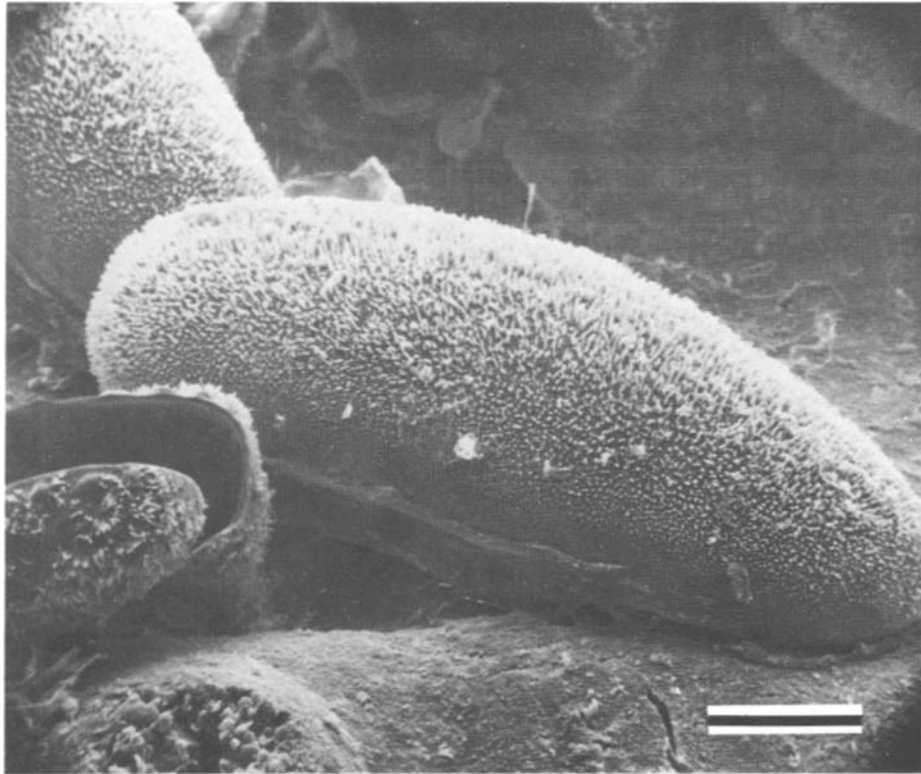

Fig. 8.22. *Halobates germanus* (White) surface structure of egg-shell. Whole mount. Scale 0.2 mm.

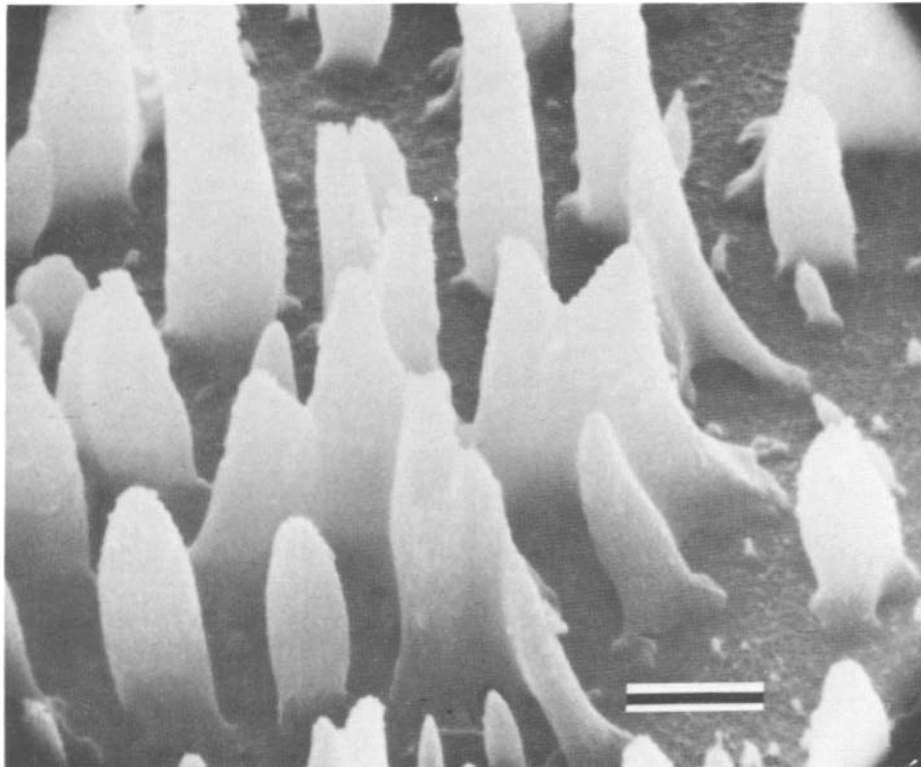

Fig. 8.23. *Halobates germanus* (White) surface structure of egg-shell. Details of shell surface, showing projections. Scale 3  $\mu\text{m}$  (scanning electron micrographs reproduced by courtesy of Dr. Cheng).

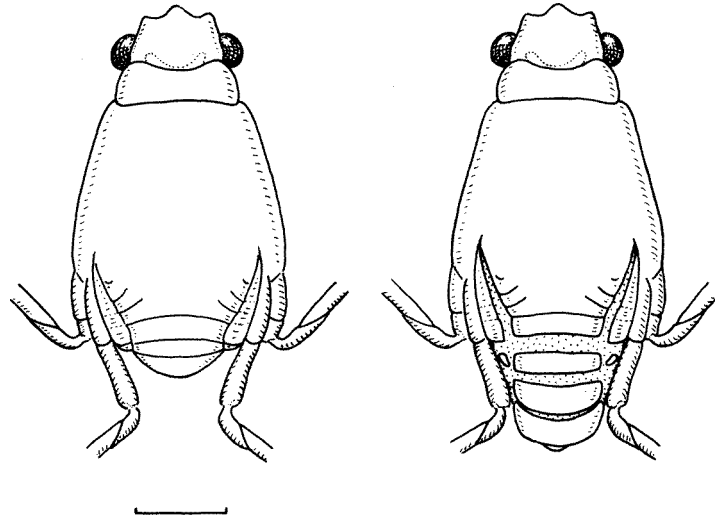

Fig. 8.24. (Left) *Halobates micans* Eschscholtz, female with abdomen contracted.

Fig. 8.25. (Right) *Halobates micans* Eschscholtz, female with abdomen expanded to accommodate mature eggs, membranous areas dotted. Scale 1 mm.

Ocean skaters have not so far been successfully reared in the laboratory. Herring (1961) estimated the period required for the total development from egg to adult to be about 56 days for *H. hawaiiensis*.

The nymphs are pale brown with dark brown patterning. The sexes are not distinguishable until they reach the final instar (Cheng, 1973e). Usinger (1938) was not able to observe any seasonal fluctuation in numbers while studying the coastal *H. hawaiiensis*. Cheng (1973e) was also unable to detect any distinct seasonality in the occurrences of *H. micans* in the Atlantic Ocean. Miyamoto and Senta (1960) reported variations in seasonal occurrence of *H. germanus* and *H. sericeus* in certain regions of the China and Japan Sea. The former appeared to prefer southern warmer areas while the latter was more abundant in colder northern waters.

### 8.3.2 Feeding and food preferences

All known water-striders are predacious fluid feeders. Their mouthparts are of the same piercing and sucking type found in other hemipterous insects. The rostrum or beak consists of a 4-segmented, sheath-like labium enclosing two pairs of long stylets, the outer mandibular and the inner maxillary pair (Cranston and Sprague, 1961; Cheng, 1966a). The rostrum is usually held in a horizontal position (Fig. 8.3) but when the insect is feeding it is swung forward (Fig. 8.26). The tip of the rostrum is equipped with sensory hairs which aid in the localization

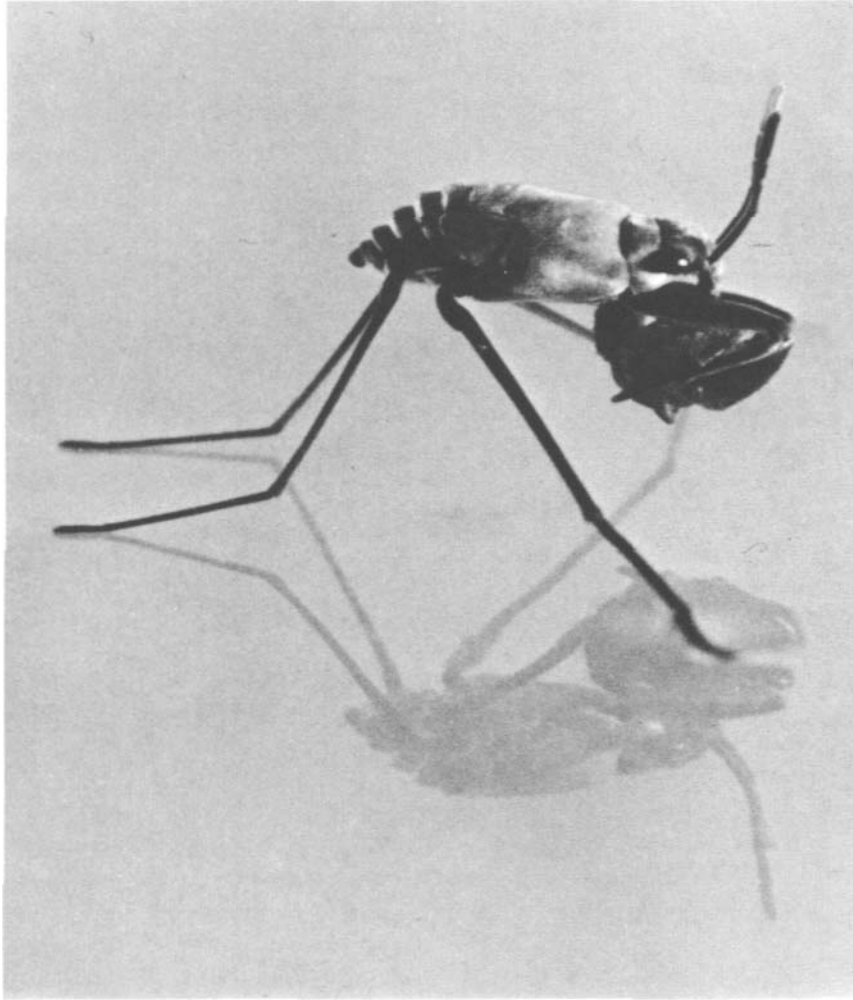

Fig. 8.26. *Halobates sericeus*, female, feeding on a *Drosophila* fly in the laboratory (from Cheng, 1974a).

of suitable spots for penetration of the prey (Cheng, 1974a). The mandibular stylets with their serrated apices are used for piercing the integument of the prey and also serve to anchor the mouthparts. The tissue of the prey is then liquified by salivary enzymes and sucked up by the food tube formed by the highly extensible maxillary stylets held together by hairs (Cheng 1966a, 1974a). The general structure of the salivary glands and the alimentary canal of water-striders have been described by Miyamoto (1961) and Cheng (1966a).

Water-striders are very sensitive to disturbances of the water surface and may locate potential prey as well as mates by the different ripples created by their

movements (Murphey, 1971; Wilcox, 1972). The characteristic feeding posture of *Halobates* is depicted in Fig. 8.26. The food preferences of individual species of marine water-striders are very little known. The coastal *Halovelia* has been reported to feed upon various intertidal organisms such as copepods, mites, springtails, chironomid midges of the genus *Clunio*, other small flies, and leaf-hoppers washed from the grass growing on the shore (Esaki, 1924b; Kellen, 1959). In the laboratory they will feed on almost any kind of freshly killed, soft-bodied insects. Small prey, such as midges, were sometimes carried to the side of a rock before being eaten, apparently to eliminate competition for food. Larger prey were often attacked by two or three individuals at once. Feeding periods varied greatly, but in general lasted for less than five minutes (Kellen, 1959).

Herring (1961) fed *Halobates hawaiiensis* with ant pupae, small flies and various other insects thrown onto the water. They were never observed to capture any organism beneath the surface film. It is possible that a substantial part of the diet of coastal water-striders is formed by land insects carried out to sea by wind and deposited on the water surface (see Ch. 5).

One of the puzzling questions about the open ocean species of *Halobates* is what they eat. During the 'Challenger' expedition, Tizard and co-workers (1885) found these insects feeding upon dead pelagic coelenterates such as the Portuguese man-o'-war, *Physalia*, the by-the-wind-sailor, *Verella*, and the jellyfish, *Porpita* (see also Savilov, 1967). Usinger and Herring (1957) discovered *H. sericeus* feeding on a small sea anemone in the field and Herring (1961) was able to keep some adults of this species alive for several weeks by feeding them on chopped pieces of sea anemones. Cheng (1974a) offered various organisms collected from the surface waters to *Halobates* and found them feeding on various planktonic crustaceans and fish larvae trapped on the surface film. She did not observe any insects feeding on pelagic coelenterates offered. Possibly, ocean-skaters could also feed on floating fish eggs, which, during some seasons, are found in great abundance in tropical and subtropical surface waters (Lee and Cheng, 1974).

### 8.3.3 Predators

Water-striders have very few known predators. The metasternal scent glands which discharge through a single midventral opening (Fig. 8.2) produce a volatile and in some cases rather unpleasant smelling fluid. These insects are therefore believed by many authors to be repugnant to potential predators. However, scent glands are absent in the nymphs (except in mesoveliids and *Hermobates*, which have an abdominal gland) and in some adult water-striders (e.g. *Rheumatobates*).

Ashmole and Ashmole (1967) analyzed stomach samples from eight species of seabirds collected on Christmas Island in the Central Pacific. Although fish and squid were the main food, *Halobates* was found eaten by the Phoenix petrel,



*Pterodroma alba* and the blue—grey noddy, *Procelsterna cerulea*. In the last species, ocean skaters constituted 16% by number (7% by volume) of the food items and occurred in 68% of the stomach samples. Cheng (1974a) examined 20 stomachs of three seabird species from various localities in the Pacific Ocean and found *Halobates* in 5 samples of the blue—grey noddy but not in any of the samples of the Phoenix petrel or the white tern, *Gygis alba*. The high lipid content of the ocean skaters suggests that they might be a rich source of food for surface-feeding fishes (Lee and Cheng, 1975).

Cannibalism has frequently been observed among *Halobates* kept in small aquaria (Usinger, 1938; Cheng, 1974a). How often it occurs in nature is not known.

### 8.3.4 Adaptations

The overall structure of water-striders deviates from the generalized insect plan in several ways. Most of these modifications are adaptations towards a life in the water—air interface and especially towards locomotion on the water surface and involve specializations in the thoracic skeleton and musculature, leg structure, and surface fine structures of body and legs (Andersen, 1976a,b).

In order to fully appreciate the various adaptations to a surface-dwelling life, we must first consider some of the properties of the water surface. The most important property is perhaps the surface tension which for seawater is about 78 dynes per cm at 20°C, slightly greater than freshwater. Since the water surface tends to minimize its energy by making its area as small as possible, it behaves like a stretched elastic membrane. When water is in contact with the surface of a solid, the water—air interface meets the solid—air interface at a definite angle which is constant for the substances concerned. This angle, measured in the water, is known as the contact angle. A high contact angle indicates that the surface of the solid is only wetted with difficulty. Such a surface is then hydrofuge.

When a water-strider is submerged in water it carries with it a large bubble of gas entangled in the hair coat of its body and appendages. This gas store makes the insect strongly buoyant and it will rise to the surface rapidly when released. Once on the surface, the water falls away leaving the insect dry. The causes of this resistance to wetting have been much discussed, but the most likely explanation is that the hairs of the insect have hydrofuge surfaces, either on account of their innate structure or due to a waxy layer (Holdgate, 1955). However, the hydrofuge property of the hair coat is not permanent. Upon prolonged exposure to water the hairs will finally become wetted and the submerged insect will have great difficulties in regaining an above-water position. If, on the other hand, the water-strider is allowed to groom and dry thoroughly in the air, the hair coat resumes its former unwettable condition (Andersen, 1976b). Grooming of the hair

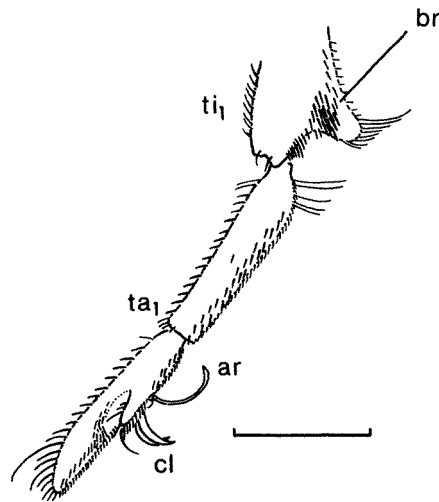

Fig. 8.27. *Halobates* front tarsus and apex of tibia, outer view. ar, arolium; br, grooming brush; cl, claws; ta<sub>1</sub>, front tarsus; ti<sub>1</sub>, front tibia; Scale 0.4 mm.

coat of body and legs is effected by specialized hair structures on the front tibiae (Figs 8.4 and 8.27).

The fine structure of the cuticular surface has recently been studied in a number of semiaquatic Hemiptera by scanning electron microscopy (Cheng, 1973b; Andersen, 1976a). In *Halobates* the hair coat of the body is comprised of at least two kinds of hairs inserted in sockets. The first kind is 20–30  $\mu\text{m}$  long, about 1  $\mu\text{m}$  wide at base and inclined at angles of 20–40° (Fig. 8.28a). These hairs are evenly distributed throughout the body surface at densities of 8000–12,000 per square mm, forming a regular hair-layer 6–10  $\mu\text{m}$  thick. The second kind is slightly longer, more erectly inserted, with densities of 4000–5000 per square mm (Fig. 8.28b). In addition, there is a velvety undercoat of hook-like microtrichia (Fig. 8.28c) which are 1.5  $\mu\text{m}$  high, 0.5  $\mu\text{m}$  wide at base, and 0.6–1.5  $\mu\text{m}$  wide at the apex. The base is often provided with slender outgrowths. The density of these microtrichia is very high,  $6\text{--}7 \times 10^5 \text{ mm}^{-2}$ . This undercoat is absent from the antennae and legs. All-water striders examined so far have basically the same type of cuticular surface structure as that described above. However, in *Halovelia* the microtrichia are simple pegs, less than 1  $\mu\text{m}$  high, 0.3  $\mu\text{m}$  wide, and spaced 0.2–0.5  $\mu\text{m}$  apart.

The function of the macro-hair layers of water-striders is without doubt to protect the insects from being wetted when occasionally submerged. The large bubble-of gas entangled between the hairs makes the insects buoyant and insures a rapid return to the water surface. It may also play a role in respiration during submergence. Perhaps a more important function is to provide an efficient protection against wetting by rain, spray or waves. The structure of these hairs appears to be well modified for this role (Thorpe, 1950).

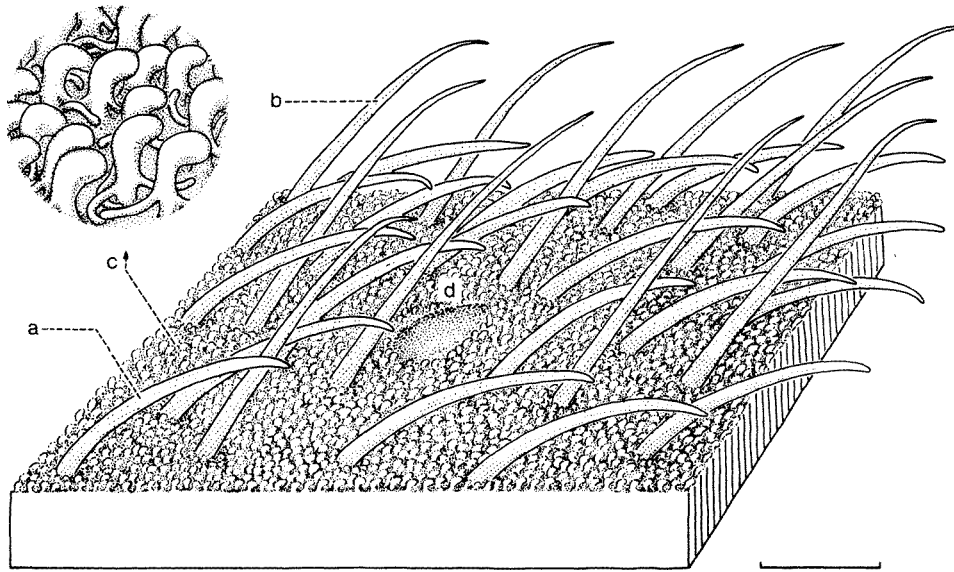

Fig. 8.28. Piece of the integument of *Halobates* sp. showing surface structures. Reconstruction based on scanning electron micrographs. (a) Inclined hair-type; (b) erect hair-type; (c) undercoat of microtrichia, above shown at higher magnification; (d) cuticular pit. Scale 10  $\mu\text{m}$

The micro-hair layer holds a very thin film of gas, the so-called *plastron*. It most probably aids in water protection but is unlikely to play any role in underwater respiration, at least in the adult insect, as the structure of the spiracles is not modified to ensure adequate connection between the extremely thin plastron and the tracheal system (Andersen, 1976a).

The thorax of the water-striders is well sclerotized, forming a rigid box which severely limits longitudinal deformations. Members of the Mesoveliidae (including *Speovelia*) have the most generalized thorax comparable to that of most terrestrial bugs, with thoracic segments of almost equal size. In the highly specialized *Halobates* the mesothorax is more than four times the length of prothorax and the middle legs are inserted far from those of the front legs.

The middle and hind legs are constructed to allow extremely wide movements. When resting, the body of the water-strider is elevated above the water, and only the distal segments are in contact with the water film. A water-strider weighing 10 mg requires a total line of contact of about 0.4 cm with the water surface just in order to be supported on the surface. Since many water-striders, including *Halobates*, are able to make vertical jumps from the water surface to a height of several cm (Hadden, 1931; Cheng, 1974a) the thrust produced by the legs may reach a magnitude of more than ten times the weight of the insect. The specialized long hairs on the legs of the water-strider ensures a corresponding

increase in the area of contact (Andersen, 1976b). The middle tibia and tarsus of *Halobates* is provided with a fringe of long hairs which in the open ocean species may reach a length of 0.5 mm (Fig. 8.1). In a few species of nearshore *Halobates*, and also in *Asclepios*, the hair-fringe is shorter and is limited only to the middle tibia (Miyamoto and Senta, 1960). The fine structure of this hair-fringe is shown in Fig. 8.29.

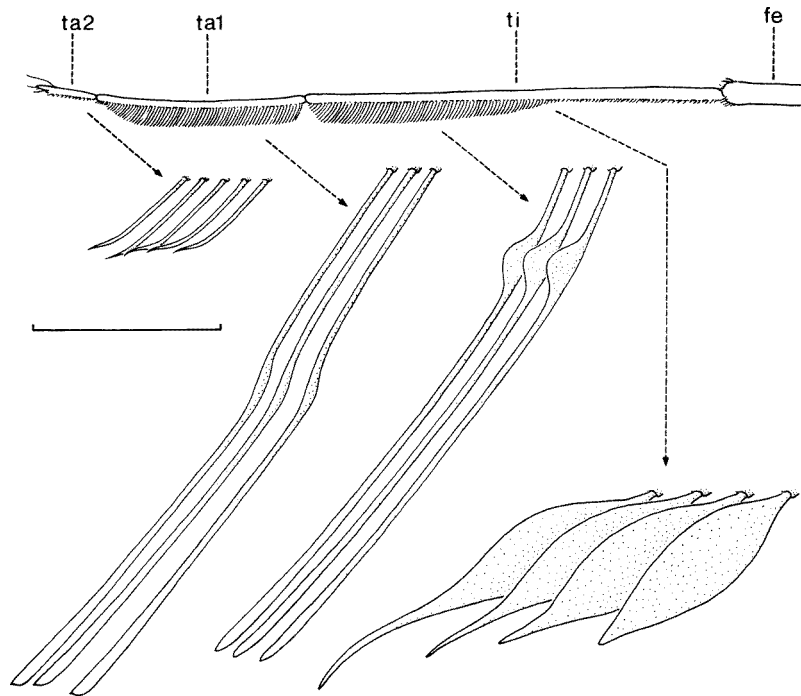

Fig. 8.29. Hair fringe of the middle leg of *Halobates flaviventris* Eschscholtz, including details of different parts of the fringe as seen by scanning electron microscopy. fe, femur; ti, tibia; ta1, first tarsal segment; ta2, second tarsal segment. Scale 80  $\mu\text{m}$  (from Andersen, 1976b).

Locomotion on the water surface is quite diversified within the semi-aquatic Hemiptera (Andersen, 1976b). Some species (e.g. the Mesoveliidae) run along the surface using all three pairs of legs. In the more specialized water-striders, including most marine species, the legs are adapted for different functions: the short and stout front legs support the body or grasp and hold the prey during feeding, or the female during copulation; the long and slender middle legs propel the body like oars beating in synchrony; the hind legs are used for steering and supporting the body when the middle legs are lifted off the surface and protracted. The exact movements of the legs during locomotion have been studied in some freshwater Gerrids by cinematographic analysis (Darnhofer-Demar, 1969;

Andersen, 1976b). The middle legs push against the anterior steep side of a surface wave generated by the insect itself. This requires that the legs are moved to the rear somewhat faster than the speed with which the wave spreads. The very long middle legs and the powerful leg muscles (Fig. 8.30) make it possible to obtain a very high angular speed, and this in turn is a prerequisite for the use of the water surface in the manner of

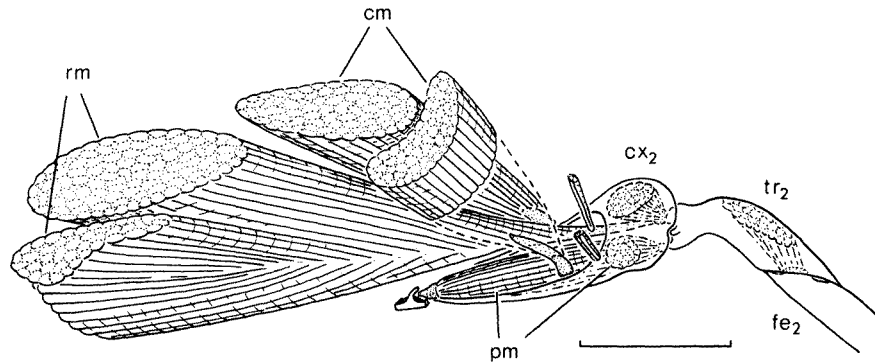

Fig. 8.30. *Halobates* basal segments of left middle leg with extrinsic and intrinsic muscles, cm, coxal rotator muscles; cx2, middle coxa; fe2, middle femur; pm, promotor muscles; rm, remotor muscles; tr2, middle trochanter. Scale 0.7 mm.

a starting block. By this jump-and-slide movement, the water-strider may achieve a body velocity of 80–130 cm/in a very short time. The following slide phase covers a distance which is 5–10 times longer.

The locomotion of *Halovelia* has been studied by Kellen (1959). When close to their hiding places in volcanic rocks they usually move about in a leisurely manner, describing small circular paths, each stroke of the middle legs moving the insect several cm in a jerky progression over the water. This pattern apparently is associated with the search for food. When skating at longer distances away from rocks and when disturbed, stroke frequency is increased and the progression over the water is very rapid and smooth for several cm at a time, interspaced with short stops. *Halovelia* is also able to run rapidly over the irregular surfaces of rocks using all three pairs of legs or to jump by using the middle legs alone.

The highly specialized swimming fan of *Trochopus* and other Rhagoveliinae (Fig. 8.9) is expanded in the water during the power stroke of the middle legs (Andersen, 1976b). The tarsal fan of *Husseyella* (Fig. 8.11) probably serves the same function.

Locomotion in the curious water-strider *Hermatobates* is very little known. They have well developed claws (Fig. 8.14) and Esaki (1947) reported that they are able to climb and walk rapidly on coral blocks. On the water surface its movements are dashing and very fast (Phillips, 1959).

### 8.3.5 *Wing polymorphism*

As far as we know, all true marine water-striders are always wingless. The permanent flightless condition of marine species follows a general trend within the semi-aquatic Hemiptera towards alary polymorphism. The selective advantage of wingless individuals most probably lies in their ability to utilize their food intake in the processes of reproductive development without the competition of highly-energy consuming processes of flight-muscle development (Andersen, 1973). In the ocean and other stable water-bodies there is little need of having winged individuals for dispersal (Cheng, 1975b).

### 8.3.6 *Tidal influence*

*Halovelia* which lives in the intertidal zone of coral and rocky coasts conceals itself at high tide in small air pockets trapped in the hole of submerged rocks. When the tide begins to ebb the insects emerge from the air pockets and move out to feed on nearby rocks. At low tide, when the rocks are left completely exposed, *Halovelia* again hides in the holes of the rocks. By staying close to the rocks, these water-striders reduce the risk of being swept out to sea by the ebbing tide (Kellen, 1959).

### 8.3.7 *Range of habitat and distribution*

Many freshwater semi-aquatic Hemiptera are known to extend their habitat ranges into saline waters, e.g. species of *Gerris*, *Limnogonus*, *Trepobates*, and *Rheumatobates* (Gerridae), *Microvelia* (Veliidae), *Hydrometra* (Hydrometridae), *Macrovelia* (Macroveliidae), and *Mesovelia* (Mesoveliidae), etc. (Lindberg, 1944, 1948; Johnsen, 1946; Berner and Sloan, 1954; Laird, 1956; Herring, 1958b; Remane and Schlieper, 1971; Andersen, 1975; etc.). The habitat types most frequently invaded are coastal water-bodies without continuous contact with the sea such as ditches and pools in saltmarshes, brackish ponds and lakes, coastal rock-pools, etc., but even estuaries, mangrove swamps, and brackish lagoons are occasionally inhabited by euryhaline water-striders. *Gerris thoracicus* Schummel, a common inland freshwater pond-skater of continental Europe, is confined to brackish-water habitats along the coast of the Baltic Sea region, probably because of the milder climate of these areas (Vepsäläinen, 1973). In Finland it may even be found in sheltered bays of the Baltic Sea itself, which in this area has salinities below 6‰.

The genus *Rheumatobates* contains both strictly freshwater (most species) and marine species (e.g. *R. aestuarius* Polhemus) as well as species invading brackish water (*R. clanis* Drake and Harris) and freshwater habitats (*R. vegatus* Drake and Harris).

The habitat requirements of marine water-striders are generally very little known. The majority of species are confined to coastal or nearshore habitats such as estuaries and tidal streams, mangrove swamps, sheltered bays, creeks and lagoons. The water of these habitats may range from almost fresh to extremely saline. Most of these habitats are influenced by tidal rhythm and species living in the intertidal zone show various adaptations towards reducing the risk of being swept out to sea by tidal currents. The most important factor determining the nearshore distribution seems to be the degree of disturbance of the water by currents, wave-actions and winds since water-striders prefer quiet waters. Other factors in habitat selection may be access to oviposition sites, shelter for the nymphs and the availability of food. In suitable habitats several species of marine water-striders are often found living together, as shown by a sample from offshore Onrust Island in the Java Sea comprising hundreds of individuals of no less than six species in three different families (Fig. 8.31).

Information on the habitats of individual species are few and scattered. Species

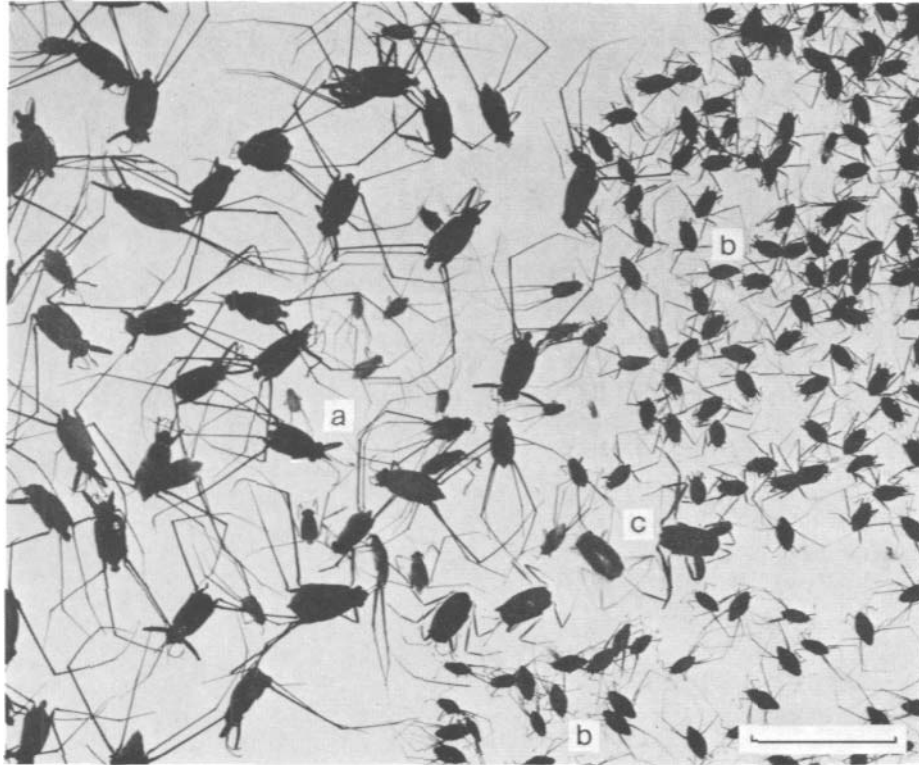

Fig. 8.31. Marine water-striders. Part of a sample collected by light offshore, Onrust Island, Java Sea (Zool. Mus., Copenhagen). The sample contains 2 species of *Halobates* (a), 3 species of *Halovelia* (b), and 1 species of *Hermatobates* (c). Scale 10 mm.

of *Rheumatobates* are found in estuaries and mangrove swamps in sheltered bays (Hynes, 1948; Herring, 1949, 1958b; Berner and Sloan, 1954; Polhemus, 1969; Cheng and Lewin, 1971; Polhemus, unpublished). One species of *Trochopus* has been captured in an upstream tributary of Suriname River at a considerable distance from the sea (Drake and van Doesburg, 1966), while *T. plumbea* commonly occurs close to the shore or in coastal streams and bays with mangrove (Cobben, 1960; Cheng, personal communication). Species of *Husseyella* are found in estuaries and tidal streams in mangrove swamps (Herring, 1955; Polhemus, unpublished observations).

A detailed account of the habitat of *Halovelina marianarum* was given by Kellen (1959). This species inhabits a rather restricted area on the edges of a lagoon entirely bordered by mangroves, old lava beds, and numerous volcanic rocks abundantly provided with small holes of a little less than 1 cm in diameter and about 1 cm deep, on the southern part of Tutuila Island, Samoa. The lagoon experiences a one meter tide when most of the scattered rocks are alternately submerged and exposed, but is protected from any appreciable amount of wave action by a fringing reef. *Halovelina* was found close to the edges of volcanic rocks at mean tide and rarely moved more than 2–3 m away from shore to open water. The older nymphs were frequently seen in company with adults while the earlier instars stayed quite close to the rocks seeking immediate protection in the holes when disturbed. *Xenobates* seems to live in similar habitats as *Halovelina* (Andersen, unpublished).

The habitats of *Hermatobates* are very little known. Esaki (1947) found a species inhabiting coral reefs off Ishigaki, Ryukyu Islands. The reefs were only exposed for a short time during low tide at which time these insects appeared on the surface of small tidal pools. During high tide they disappear, presumably submerged under water. Phillips (1959) found another species under similar conditions in Addu Atoll, Maldives Islands. Cheng (1976), however, recorded *Hermatobates* from open waters in Hawaii.

*Speovelia maritima* (Esaki) was described from the Senjojiki Cave near Seto in central Honshu, Japan (Esaki, 1929). The cave was narrow and not very deep and opened directly into the sea which filled it during high tide (Yusa, 1929). The mesoveliids were found resting quietly on the moist walls of the deepest part of the cave where it was totally dark and cold. The species has also been found in crevices in cliffs just above the wave zone along rocky coasts (Gagné and Howarth, 1975). *S. mexicana* (Polhemus) was collected from under rocks atop a gently sloping reef-like area (Polhemus, 1975). The insects were skimming on the surface of the water that was trapped by the reef after the tide had receded.

The majority of ocean skaters, *Halobates*, are confined to coastal habitats such as sheltered bays and lagoons protected by coral reefs often in the presence of mangroves. Members of the *Asclepios* have been recorded from similar habitats (Esaki, 1930). Nymphs of coastal *Halobates* can often be found in quiet waters



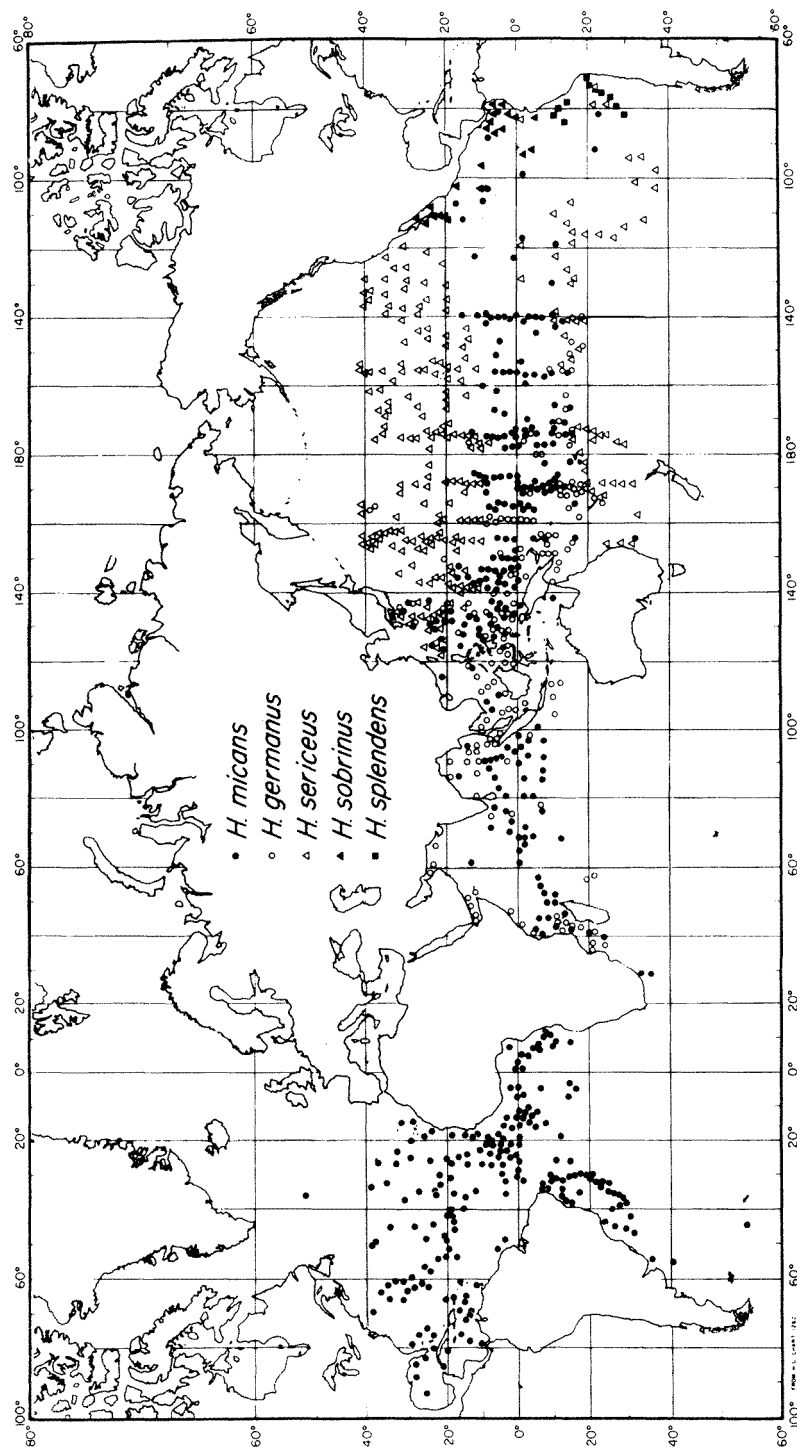

Fig. 8.32. Distribution of the five open-ocean species of *Halobates* (from Cheng, 1974a).

a few metres from shore in groups of several hundred individuals covering an area of some square metres and retreating to protected coves during stormy conditions (Usinger, 1938; Kellen, 1959; Phillips, 1959; Cheng and Fernando, 1969). Adults are less frequently seen unless attracted to light.

Five species of *Halobates* are commonly found in the open ocean, often at great distances away from land (see map, Fig. 8.32). They are occasionally swept to shore in heavy storms (Hadden, 1931; Usinger, 1938; Herring, 1961; Cheng, 1973c). How the ocean-skaters survive storms in the middle of the open ocean is not known. Savilov (1967) found large swarms at sea after strong storms and was also able to attract them by light when the sea state was as much as 6–7. Some earlier observers claimed that *Halobates* dives freely and stays submerged in rough weather (Walker, 1893). Henry (1932) and more recently Birket-Smith (personal communication) observed *Halobates* diving when pursued. On the other hand, some other authors were unable to induce any of these insects to dive, either in the field or in captivity (Delsman, 1926; Usinger, 1938; Cheng, 1974a). Nonetheless, it is safe to assume that if *Halobates* dives freely under water its buoyancy will force it to swim vigorously and continuously in order to stay submerged, this in turn will probably put a limit on the duration of submergence.

The ocean-skaters form part of the animal community at the air—water interface — the pleuston. The organisms associated with *Halobates* in this community as well as the chemical and physical characteristics peculiar to the surface of the sea have been reviewed by David (1965), Savilov (1968) and Cheng (1975a).

### 8.3.8 *Distribution and dispersal*

The marine water-striders are limited to the tropical regions of the world with only a few species occurring beyond the boundaries of this zone. Table 8.1 summarizes the distributional records of all genera. The coastal water-striders are usually very locally distributed and many species are endemic to particular islands or island groups.

Species of *Rheumatobates*, *Trochopus* and *Husseyella* are exclusively found in the Neotropical and southern Nearctic region and probably originated there. The occurrence of two different species of *Trochopus* on the Pacific and Gulf coasts of Central America suggests that the group evolved before the last closure of the Panama isthmus. The same distributional pattern is found in the marine species of *Rheumatobates* (Fig. 8.33).

Coastal species of all other genera of marine water-striders are confined to the Old World tropics with only a few species penetrating into the subtropics along the coast of East Asia. The only exceptions are *Hermatobates*, of which one species has been recorded from the West Indies (Herring, 1965) and an undescribed one collected from Cuba (Herring, personal communication) and *Speovelia*, of which one species has been collected from the Gulf of California (Polhemus, 1975).

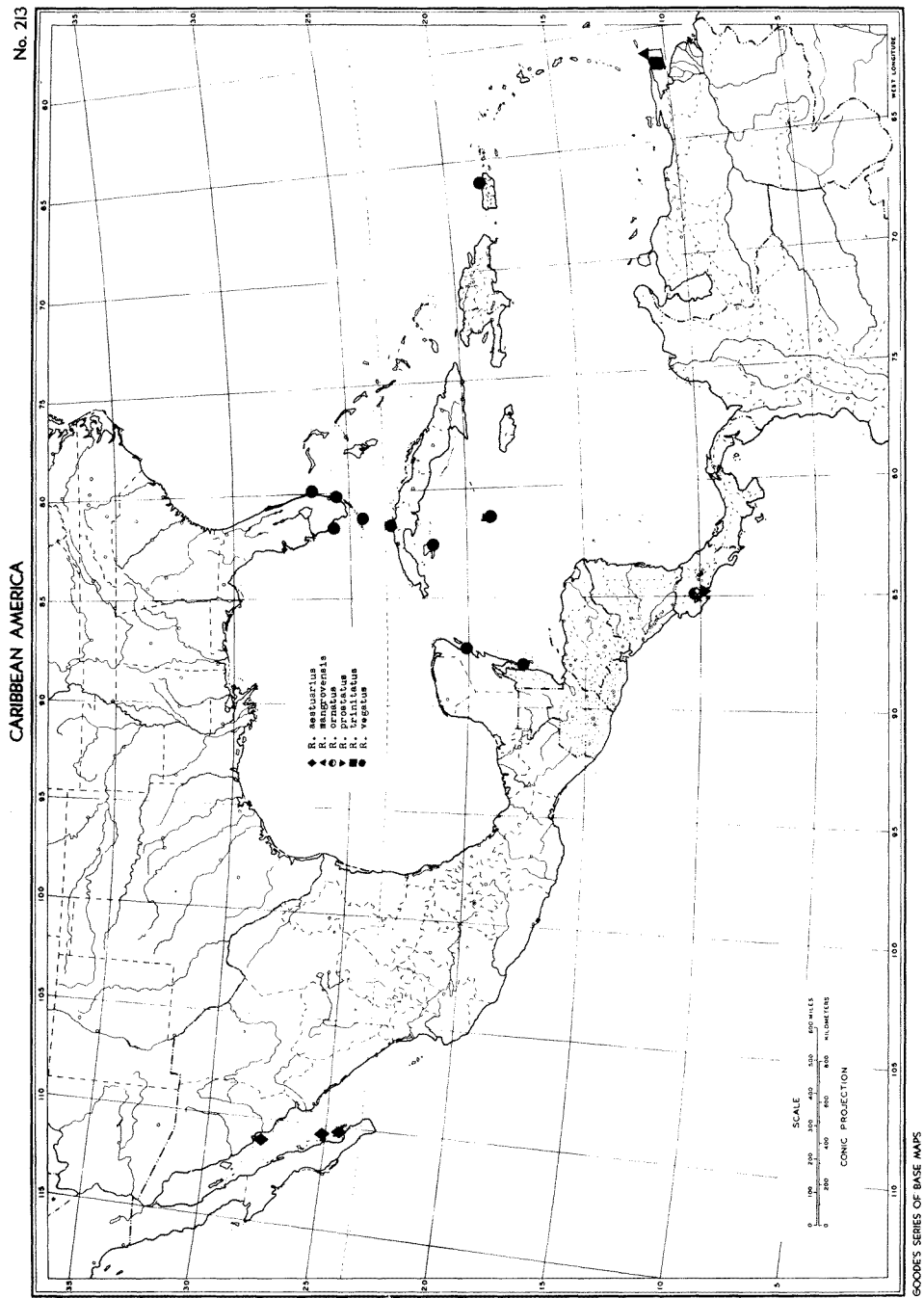

Fig. 8.33. Distribution of six marine species of *Rheumatobates*.

*Halovelina* and coastal species of *Halobates* are found generally between 20° N and 20° S from the Red Sea coast of Africa to the Marquesas Islands in the central Pacific Ocean. A few are found beyond these limits, off the coasts of Taiwan, Ryukyu Islands, Japan, along the east coast of Australia and the Galapagos Islands. The limits of distribution of single species are generally restricted and records indicating a wider distribution of some *Halovelina* need to be confirmed. However, a few coastal species of *Halobates* have undoubtedly a rather wide range, e.g. *H. flaviventris* (Erschscholtz), which occurs from the east coast of Africa to the New Hebrides in the southwest Pacific.

Our present knowledge of the distribution of the five open-ocean species of *Halobates* is derived mainly from samples collected during various oceanographic expeditions, and is shown in Fig. 8.32 (see also Herring, 1961; Savilov, 1967; Scheltema, 1968; Cheng, 1971, 1973a,c,e, 1974a,b,c,d).

*H. micans* (Eschscholtz) is by far the most widely distributed species and the only circumtropical species found in the Atlantic and Indian Ocean as well as the Pacific Ocean. It is the only species recorded from the Atlantic Ocean.

*H. germanus* (White) is found in the Indian and the eastern half of the Pacific Ocean.

*H. sericeus* (Eschscholtz) occurs in two separate areas, between 10 and 40° N and again between 10 and 35° S in the Pacific Ocean. The space between these two is occupied by *H. micans*. The replacement of one species by the other is normally rather abrupt and mixed swarms are only found in limited areas.

The two remaining open-ocean *Halobates* species are exclusively found in the eastern Pacific Ocean: *H. sobrinus* (White) between 5° S and 25° N, off the coasts of Central America and west to the Galapagos Islands, and *H. splendens* (Witlaczil) along the coast of South America from 10 to 30° S.

Our knowledge about what factors determine the distribution of *Halobates* on the open ocean is still inadequate. Savilov (1967) considered temperature, humidity, and rainfall to be important limiting factors in the Pacific Ocean. Cheng (1973c) added surface currents and winds. Interspecific competition may also be important (Herring, 1961). Finally, the access to floating material for oviposition may well prove to be an important regulating factor. Although flotsam is not generally common in the oceans it is often locally concentrated by convergences (David, 1965).

The population density of *Halobates* in some parts of the oceans is rather high. Savilov (1967) was able to collect 400–500 individuals in 10–15 minutes by attracting them to light at night. On the basis of samples collected in the eastern tropical Pacific, Cheng (1973b,d, 1974a) estimated the population density to be as high as 0.1 per square meter. This figure is even likely to be an underestimate, partly because many of the so-called surface samples were oblique tows taken beneath the sea surface, and partly because these agile insects are able to dodge approaching nets both by daylight and moonlight (Cheng, 1973d; Cheng and Enright, 1973).

## REFERENCES

- Andersen, N.M. (1971) Zoogeography and evolution of pacific freshwater Gerridae (Hemiptera-Heteroptera). Proc. 13th Int. Congr. Entomol., Moscow 1968 1, 469–470.
- Andersen, N.M. (1973) Seasonal polymorphism and developmental changes in organs of flight and reproduction in bivoltine pond-skaters (Hem. Gerridae). Entomol. Scand. 4, 1–20.
- Andersen, N.M. (1975) The *Limnogonus* and *Neogerris* of the Old World with character analysis and a reclassification of the Gerrinae (Hemiptera: Gerridae). Entomol. Scand. suppl. 7, 1–96.
- Andersen, N.M. (1976a) Fine structure of the body hair layers and morphology of the spiracles of semi-aquatic bugs (Hemiptera, Heteroptera, Gerromorpha) in relation to life on the water surface. (In press.)
- Andersen, N.M. (1976b) A comparative study of locomotion on the water surface in semi-aquatic bugs (Hemiptera, Heteroptera, Gerromorpha). Vidensk. Medd. Dan. Naturhist. Foren. 139. (In press.)
- Ashmole, N.P. and Ashmole, M.J. (1967) Comparative feeding ecology of sea birds of a tropical oceanic island. Bull. Peabody Mus. Nat. 24, 1–131.
- Berner, L. and Sloan, W.C. (1954) The occurrence of a mayfly nymph in brackish water. Ecology 35 (1) 98.
- Cheng, L. (1966a) Studies on the biology of the Gerridae (Hem. Heteroptera) I: Observations on the feeding of *Limnogonus fossarum* (F.). Entomol. Mon. Mag. 102, 121–128.
- Cheng, L. (1966b) Studies on the biology of the Gerridae (Hem. Heteroptera) II: The life history of *Metrocoris tenuicornis* Esaki. Entomol. Mon. Mag. 102, 273–282.
- Cheng, L. (1966c) A curious marine insect, *Hermatobates*. Malay. Nat. J. 19, 283–285.
- Cheng, L. (1971) Ocean-striders from Melanesia. Cah. ORSTOM, Sér. Océanogr. 9, 513–518.
- Cheng, L. (1972) Skaters of the seas. Oceans 5, 54–55.
- Cheng, L. (1973a) Some *Halobates* from the Pacific Ocean. Jap. J. Zool. 17, 11–15.
- Cheng, L. (1973b) Marine and freshwater skaters: differences in surface fine structures. Nature 242, 132–133.
- Cheng, L. (1973c) *Halobates*. Oceanogr. Mar. Biol. Annu. Rev. 11, 223–235.
- Cheng, L. (1973d) Can *Halobates* dodge nets? I: By daylight? Limnol. Oceanogr. 18, 663–665.
- Cheng, L. (1973e) The ocean strider *Halobates* (Heteroptera, Gerridae) in the Atlantic Ocean. Okeanologia 13, 683–690 (in Russian; english translation in Oceanology 13, 564–570).
- Cheng, L. (1974a) Notes on the ecology of the oceanic insect *Halobates*. Mar. Fish. Rev. 36, 1–7.
- Cheng, L. (1974b) *Halobates* (Heteroptera: Gerridae) from the seas around Nosy Bé, Malagasy. Cah. ORSTOM, Sér. Océanogr. 12, 113–116.
- Cheng, L. (1974c) The ocean-strider *Halobates* (Gerridae: Heteroptera). In Sym. Indian Ocean and Adjacent Seas. J. Biol. Assoc. India 15, 1–5.
- Cheng, L. (1974d) *Halobates* from the North-West African area. Res. Exp. Cient. B/O Cornide 3, 169–171.
- Cheng, L. (1975a) Marine pleuston-animals at the sea-air interface. Annu. Rev. Oceanogr. Mar. Biol. 13, 181–212.
- Cheng, L. (1975b) Identification sheet for pelagic *Halobates* - Insecta, Heteroptera, Gerridae. Conseil Int. Explorat. de la Mer.
- Cheng, L. (1976) The elusive sea-bug, *Hermatobates* (Heteroptera). (In press.)
- Cheng, L. and Enright, J.T. (1973) Can *Halobates* dodge nets? II: By moonlight? Limnol. Oceanogr. 18, 666–669.
- Cheng, L. and Fernando, C.H. (1969) Taxonomy of the Malayan Gerridae (Hemiptera: Heteroptera) with notes on biology and distribution. Oriental Insects 3, 97–160.
- Cheng, L. and Fernando, C.H. (1971) Life history and biology of the riffle bug *Rhagovelia obesa* Uhler (Heteroptera: Veliidae) in southern Ontario. Can. J. Zool. 49, 435–442.

- Cheng, L. and Lewin, R.A. (1971) An interesting marine insect, *Rheumatobates aestuarius* (Heteroptera: Gerridae), from Baja California, Mexico. *Pac. Insects* 13, 333–341.
- China, W.E. (1955) The evolution of the water bugs. In *Bull. Symp. Org. Evol. Natl. Inst. Sci. India* 7, 91–103.
- China, W.E. (1956) A new species of the genus *Hermatobates* from the Hawaiian Islands (Hemiptera-Heteroptera, Gerridae, Halobatinae). *Ann. Mag. Nat. Hist.* (12) 9, 353–357.
- China, W.E. (1957) The marine Hemiptera of the Monte Bello Islands, with descriptions of some allied species. *J. Linn. Soc. Lond., Zool.* 40, 342–357.
- China, W.E. and Miller, N.C.E. (1959) Check-list and keys to the families and subfamilies of the Hemiptera-Heteroptera. *Bull. Br. Mus. (Nat. Hist.) Entomol.* 8, 1–45.
- China, W.E. and Usisger, R.L. (1949) Classification of the Veliidae (Hemiptera) with a new genus from South Africa. *Ann. Mag. Nat. Hist.* (12) 2, 343–354.
- Cobben, R. (1960) The Heteroptera of the Netherlands Antilles. I. Foreword, Gerridae, Veliidae, Mesoveliidae. *Studies on the Fauna of Curçao and other Caribbean Islands* 11, 1–34.
- Cobben, R. (1968) Evolutionary trends in Heteroptera. Part 1. Eggs, architecture of the shell, gross embryology and eclosion. ( ) 475 pp.
- Cranston, F.P. and Sprague, I. (1961) A morphological study of the head capsule of *Gerris remigis* Say. *J. Morphol.* 108, 287–309.
- Darnhofer-Demar, B. (1969) Zur Fortbewegung des Wasserläufers *Gerris lacustris* L. auf der Wasseroberfläche. *Verh. Deutsch. Zool. Ges. Innsbruck 1968. Zool. Anz., suppl.* 32, 429–439.
- David, P.M. (1965) The surface fauna of the ocean. *Endeavour* 24, 95–100.
- Delsman, H.G. (1926) On the propagation of *Halobates*. *Treubia* 8, 384–388.
- Distant, W.L. (1915) A few undescribed Rhynchota. *Ann. Mag. Nat. Hist.* (8) 15, 503–507.
- Drake, C.J. (1958) New Neotropical Veliidae (Hemiptera). *Proc. Biol. Soc. Wash.* 71, 133–142.
- Drake, C.J. and Doesburg, P. van, Jr. (1966) Water-striders of the American Genus *Trochopus* (Hemiptera: Veliidae). *Studies on the Fauna of Suriname and Other Guyanas* 8, 65–76.
- Esaki, T. (1924a) On the genus *Halobates* from Japanese and Formosan Coasts. *Psyche* 21, 112–118.
- Esaki, T. (1924b) On the curious halophilous water-strider. *Halovelis maritima* Bergroth (Hemiptera, Gerridae). *Bull. Brooklyn Entomol. Soc.* 19, 29–34.
- Esaki, T. (1926) The water-striders of the subfamily Halobatinae in the Hungarian National Museum. *Anno. Hist. Nat. Mus. Natl. Hung.* 23, 117–164.
- Esaki, T. (1927) An interesting new genus and species of Hydrometridae (Hem.) from South America. *Entomologist* 60, 181–184.
- Esaki, T. (1929) A remarkable speo-halophilous water-strider (Heteroptera, Mesoveliidae). *Ann. Mag. Nat. Hist.* (10) 4, 341–346.
- Esaki, T. (1930) Marine water-striders from the Korean coast (Hemiptera, Gerridae). *Entomol. Mon. Mag.* 66, 158–161.
- Esaki, T. (1947) Notes on *Hermatobates haddonii* Carpenter (Hemiptera, Gerridae). *Mushi* 18, 49–51.
- Eschscholtz, J.F. (1822) *Entomographien*, ( ) 128 pp.
- Gagné, C. and Howarth, F.G. (1975) The cavernicolous fauna of Hawaiian lava tubes, 6. Mesoveliidae or water treaders (Heteroptera). *Pac. Insects* 16, 399–413.
- Hadden, F.C. (1931) The Pelagic *Halobates*. *Proc. Hawaii. Entomol. Soc.* 7, 457–459.
- Henry, G.M. (1932) Note on the diving powers of *Halobates*. *Spolia Zeylanica* 16, 353–354.
- Herring, J.L. (1949) A new species of *Rheumatobates* from Florida (Hemiptera, Gerridae). *Florida Entomol.* 32, 160–165.
- Herring, J.L. (1955) A new American genus of Veliidae (Hemiptera). *Florida Entomol.* 38, 21–25.
- Herring, J.L. (1958a) The marine water-striders of the 'Dana' Expeditions (Insecta: Hemiptera). *Dana Report* 44, 1–14.
- Herring, J.L. (1958b) Evidence for hurricane transport and dispersal of aquatic Hemiptera. *Pan-Pac. Entomol.* 34 (3) 174–175.

- Herring, J.L. (1961) The genus *Halobates* (Hemiptera: Gerridae). *Pac. Insects* 3, 223–305.
- Herring, J.L. (1964) A new species of *Halobates* from the Bay of Bengal (Hemiptera: Gerridae). *Entomol. Soc. Wash.* 66, 85–86.
- Herring, J.L. (1965) *Hermatobates*, a new generic record for the Atlantic Ocean, with descriptions of new species (Hemiptera: Gerridae). *Proc. U.S. Natl. Mus.* 117, 123–130.
- Holdgate, M.W. (1955) The wetting of insect cuticles by water. *J. Exp. Biol.* 32, 591–617.
- Horváth, G. (1915) Monographie des Mésoveliides. *Ann. Hist.-Nat. Mus. Natn. Hung.* 13, 535–556.
- Horváth, G. (1929) Mesoveliidae. In: *General Catalogue of the Hemiptera*, (G. Horváth and H.M. Parshley, Eds.) 2, , 15 pp.
- Hungerford, H.B. (1954) The Genus *Rheumatobates* Bergroth (Hemiptera-Gerridae). *Univ. Kansas Sci. Bull.* 36, 529–588.
- Hungerford, H.B. and Matsuda, R. (1958) A new genus of the Gerridae from the Solomon Islands. *Pan.-Pac. Entomol.* 34, 203–206.
- Hungerford, H.B. and Matsuda, R. (1960) Keys to subfamilies, tribes, genera and subgenera of the Gerridae of the world. *Univ. Kansas Sci. Bull.* 41, 3–24.
- Hynes, H.B.N. (1948) Notes on the aquatic Hemiptera-Heteroptera of Trinidad and Tobago, B.W.I., with description of a new species of *Martarega* B. White (Notonectidae). *Trans. R. Entomol. Soc. Lond.* 99, 341–360.
- Jaczewski, T. (1972) Geographical distribution of oceanic Heteroptera and the continental drift. *Bull. Acad. Sci. Pol., Sér. Biol.* 20, 415–417.
- Johnsen, P. (1946) The rock-pools of Bornholm and their fauna. *Vidensk. Medd. Dansk. Naturhist. Foren.* 109, 1–54.
- Kellen, W.R. (1959) Notes on the biology of *Halovelia marianarum* Usinger in Samoa (Veliidae: Heteroptera). *Ann. Entomol. Soc. Am.* 52, 53–62.
- Laird, M. (1956) Studies of Mosquitoes and Freshwater Ecology in the South Pacific. *Bull. R. Soc. New Zealand* 6, 1–213.
- Lee, R.F. and Cheng, L. (1974) A comparative study of the lipids of water-striders from marine, estuarine and freshwater environments: *Halobates*, *Rheumatobates*, *Gerris* (Heteroptera: Gerridae). *Limnol. Oceanogr.* 19, 958–965.
- Lindberg, H. (1944) Ökologisch-geographische Untersuchungen zur Insektenfauna der Felsen-tümpel an den Küsten Finnlands. *Acta Zool. Fenn.* 41, 1–178.
- Lindberg, H. (1948) Zur Kenntnis der Insektenfauna im Brackwasser des Baltischen Meeres. *Comment. Biol.* 10, 1–206.
- Linnavuori, R. (1971) Hemiptera of the Sudan, with remarks on some species of the adjacent countries. I. The aquatic and subaquatic families. *Ann. Zool. Fenn.* 8, 340–366.
- Lundbeck, W. (1914) Some remarks on the eggs and egg-deposition of *Halobates*. *Mindeskr. Japetus Steenstrup* 2 (27) 1–13.
- Matsuda, R. (1960) Morphology, evolution and a classification of the Gerridae (Hemiptera-Heteroptera). *Univ. Kansas Sci. Bull.* 41, 25–632.
- McLachlan, R. (1871) Notes on the hemipterous genus *Halobates*. *Entomol. Mon. Mag.* 7, 208–209.
- Miyamoto, S. (1961) Comparative morphology of alimentary organs of Heteroptera, with a phylo-genetic consideration. *Sieboldia* 2, 197–259.
- Miyamoto, S. (1967) Gerridae of Thailand and North Borneo taken by the Joint Thai-Japanese Biological Expedition 1961–62. *Nature and Life in Southeast Asia* 5, 217–257.
- Miyamoto, S. and Senta, T. (1960) Distribution, marine condition and other biological notes of marine water-striders, *Halobates* spp. in the south-western area of Kyushu and western area of Japan Sea. *Sieboldia* 2, 171–186 (in Japanese with English summary).
- Murphey, R. (1971) The water striders response to prey. *Fauna* 3, 33–36.
- Phillips, W.W.A. (1959) Notes on three species of marine Hemiptera taken in Addu Atoll, Maldive Islands, between October, 1958, and April, 1959. *Entomol. Mon. Mag.* 95, 246–247.

- Poisson, R. (1956) Contribution a l'étude des Hydrocorises de Madagascar (Heteroptera). 4e Mémoire. Mém. Inst. Sci. Madag. (E) 7, 243–265.
- Polhemus, J.T. (1969) A new *Rheumatobates* from Mexico (Hemiptera: Gerridae). J. Kansas Entomol. Soc. 42, 509–511.
- Polhemus, J.T. (1975) New estuarine and intertidal water-striders from Mexico and Costa Rica (Hemiptera: Gerridae, Mesoveliidae). Pan.-Pac. Entomol. 51, 243–247.
- Polhemus, J.T. (1976) Some notes on the ecology of semiaquatic Hemiptera at Tomales Bay, California (: ). (In press.)
- Polhemus, J.T. and Chapman, H.C. (1976a) Veliidae. In: The Semiaquatic and Aquatic Hemiptera of California. (A.S. Menke, Ed.) (In press.)
- Polhemus, J.T. and Chapman, H.C. (1976b) Mesoveliidae. In: The Semiaquatic and Aquatic Hemiptera of California (A.S. Menke, Ed.) (In Press.)
- Remane, A. and Schlieper, C. (1971) Biology of Brackish Water. (, ) 372 pp.
- Savilov, A.I. (1967) Oceanic insects of the genus *Halobates* (Hemiptera, Gerridae) in the Pacific. Oceanology 7, 252–260 (translation from Russian).
- Savilov, A.I. (1968) Pleuston of the Pacific Ocean. In: Biology of the Pacific Ocean. (L.A. Zenkevich, Ed.) Nauka, Moscow (in Russian, English translation by Nat. Tech. Inform. Serv. U.S. Dept. Commerce) pp. 264–353.
- Scheltema, R.S. (1968) Ocean Insects. Oceanus 14, 9–12.
- Schmidt, H.E. and Mueller, R. (1973) Marine water striders of the genus *Halobates* (Hemiptera: Gerridae) from the Red Sea and Gulf of Aden. Israel J. Zool. 22 (1) 1–12.
- Štys, P. and Kerzhner, I. (1975) The rank and nomenclature of higher taxa in recent Heteroptera. Acta. Entomol. Bohemoslov. 72, 65–79.
- Thorpe, W.H. (1950) Plastron respiration in aquatic insects. Biol. Rev. 25, 344–390.
- Tizard, T.N., Moseley, H.N., Buchanan, J.Y. and Murray, J. (1885) Narrative of the Cruise of H.M.S. Challenger with a general account of the Scientific results of the expedition. Rep. Sci. Res. H.M.S. 'Challenger' Narrative 1 (2) 512–514.
- Usinger, R.L. (1938) Biological notes on the pelagic water striders (*Halobates*) of the Hawaiian Islands, with description of a new species from Waikiki (Gerridae: Hemiptera). Proc. Hawaii Entomol. Soc. 10, 77–84.
- Usinger, R.L. and Herring, J.L. (1957) Notes on marine water-striders of the Hawaiian Islands (Hemiptera: Gerridae). Proc. Hawaii Entomol. Soc. 16, 281–283.
- Vepsäläinen, K. (1973) The distribution and habitats of *Gerris* Fabr. species (Heteroptera, Gerridae) in Finland. Ann. Zool. Fenn. 10, 419–444.
- Walker, J.J. (1893) On the genus *Halobates* Esch., and other marine Hemiptera. Entomol. Mon. Mag. 29, 227–232.
- White, F.B. (1883) Report on the pelagic Hemiptera. Voy. Challenger, Rep. Zool. 7, 1–82.
- Wilcox, R. Stimson (1972) Communication by surface waves. Mating behaviour of a water strider (Gerridae). J. Comp. Physiol. 80, 255–266.
- Yusa, H. (1929) An ecological note on *Speovelia maritima* Esaki. Ann. Mag. Nat. Hist. (10)4, 346–349.



## Shore bugs (Hemiptera: Saldidae, etc.)

John T. Polhemus

<b>Contents</b>		
9.1	Introduction	225
9.2	Systematics — Key to marine shore bugs	227
9.3	Phylogeny and evolution	243
9.4	Biology	246
	9.4.1 General life history	246
	9.4.2 Mating behaviour	247
	9.4.3 Feeding, food, predators and parasites	248
9.5	Ecology	249
	9.5.1 Adaptation to marine environment	249
	9.5.2 Respiratory adaptations	250
	9.5.3 Other adaptations	250
	9.5.4 Habitats	251
9.6	Distribution	253
	9.6.1 Dispersal	255
References		256

### 9.1 INTRODUCTION

The shore bugs are found in the littoral and intertidal zones of the marine environment. They are mostly inconspicuous insects, with dull colouring, and are shy, being quick to fly or hide when disturbed. They are quite common along the sea shores of the temperate zone and have been known since the late 1600s (Ray, 1710).

The majority of shore bugs belong to the family Saldidae, whose members are mostly freshwater species. Marine species have adapted to their environment

through behavioural rather than morphological modifications. Although many of them undergo considerable periods of submersion, they are basically land bugs with little if any adaptation to permit underwater respiration.

The marine shore bugs may be divided, by habitat, into littoral, saltmarsh, mangrove and reef intertidal forms. Each of these is successively more specialized, with the intertidal forms usually occurring in rather restricted habitats consisting of coral reef or porous volcanic rock. The separation of the species or species groups on the basis of habitat, like most biological phenomena, does not provide distinct divisions but rather a convenient way of examining their origins, adaptations, ecology and distribution.

Of the reef intertidal species, none are known to be euryhaline, but both the open shore and saltmarsh are commonly invaded by freshwater species and euryhaline species. On coastal marshes with gentle slopes which gradually change from saltwater to freshwater inland, it is particularly difficult to determine where the boundary lies.

Euryhaline and halophilous eurytopic species are rather common in the Saldidae. Of the approximately 230 species of living Saldidae, 8 are reef intertidal and strictly marine; 7 are halophilous shore-inhabiting forms, some of which also occur in inland saline habitats; 11 are coastal saltmarsh species; 17 are euryhaline, occurring in both inland and coastal habitats. The relationships of the species to each other and their limits of tolerance of saline concentrations are poorly understood. It is quite possible that the number of species in each category is incomplete.

While the overwhelming majority of marine shore bugs are s'aldids, a few ochterids such as *Ochterus aenifrons* (Champion) (Polhemus, personal observation), *O. perbosci* (Guerin) (Cobben, 1960b) and *O. americanus* (Uhler) (Chapman, 1959) do invade the edges of saltmarshes. As might be expected, these species are among the most generalized and dispersive of the Ochteridae, characteristic of most euryhaline shore bugs.

Although most members of Gelastocoridae or Toadbugs inhabit only freshwater biotopes, several species are found only on seashores, and one of them, *Nerthra rugosa* (Desjardins), has been found breeding in the intertidal zone (Todd, 1955, 1965; Polhemus, 1972a).

The shore bugs, being mostly secretive, inconspicuous and small, were rarely collected during many of the well known early expeditions to the Indo-Pacific region. However, over the past twenty years new marine genera of shore bugs have been regularly discovered (Brown, 1954; Drake, 1962; Polhemus and Evans, 1969; Cobben, 1970) and forms described earlier as unique or rare have been rediscovered and their habitats and ecology elucidated (Baudoin, 1955; Brown, 1959; Paulian, 1959; Schuster, 1965; Drake, 1968; Evans, 1968; Polhemus, 1972b). Lindberg's (1936) splendid study on the Hemiptera of the North and Baltic Seas was a forerunner of a number of comprehensive faunal surveys

(e.g. Lindberg, 1948; Rimes, 1951; Glynn-Williams and Hobart, 1952; Morton, 1954; Woodward, 1958; Cobben, 1960b; Wroblewski, 1966; and others mentioned earlier). All of these studies have not only enormously increased our knowledge of poorly known groups, but often resulted in the discovery of new taxa that are important to our understanding of the phylogeny, ecology and systematics of these insects. Surely many more species and genera of marine bugs await discovery, particularly in the Pacific and Indian Oceans where most of the faunal subregions have never been comprehensively surveyed, if at all, for marine insects.

## 9.2 SYSTEMATICS

The shore bugs collectively belong to two infra-orders. The Ochteridae and Gelastocoridae are the only littoral families of the infra-order Nepomorpha, and the Saldidae and Omaniidae belong to the infra-order Leptopodomorpha (Popov, 1971; see also Stys and Kerzhner, 1975). These four families contain 26 genera and about 360 species worldwide, of which 19 genera and about 59 species are marine (Table 9.1). The term ‘marine shore bugs’ used in this chapter includes those species found on saltmarshes or the sea shore accompanying

Table 9.1 Shore bugs of the world (excluding fossil forms).

Family	Worldwide		Marine	
	No. of genera	No. of species	No. of genera	No. of species
Gelastocoridae	2	98	1	4
Ochteridae	3	31	1	3
Omaniidae	2	4	2	4
Saldidae	19	228	15	51

clearly marine or littoral forms, or have been repeatedly observed along coastal habitats. Some species are only found on saltmarshes although certain species (e.g., *Saldula villosa* (Hodgden)) show a marked preference for freshwater micro-habitats within the marsh. A list of marine genera and species and their habitat preferences is given in Table 9.2.

The decision as to which species to consider marine is very difficult. The list may include some species that are only invaders, and undoubtedly some potentially marine species may have been omitted. I have included species from Europe primarily on the basis of works by Cobben (1959), Butler (1923), Lindberg (1936, 1948) and Wroblewski (1966), but also from a number of other sources. For the Pacific and Australian regions, I have relied on the literature which will be indicated under the various genera. For data on the New World fauna, I have relied

Table 9.2 Marine shore bugs.\*

Family/Subfamily	Genus	Distribution	Number of species in each habitat category				
			Freshwater or inland saline only	Euryhaline Marine			Intertidal
				Saltmarsh	Shore		
GELASTOCORIDAE	<i>Nerthra</i>	Worldwide	82	1	0	2	1
OCHTERIDAE	<i>Ochterus</i>	Worldwide	26	3	0	0	0
OMANIIDAE	<i>Omania</i>	Red Sea, Gulf of Aden	0	0	0	0	1
	<i>Corallocoris</i>	Pacific	0	0	0	0	3
SALDIDAE							
Aepophilinae	<i>Aepophilus</i>	Europe, North Africa	0	0	0	0	1
Chiloxanthinae	<i>Chiloxanthus</i>	Holarctic	8	1	1*	0	0
	<i>Enalosalda</i>	Sea of Cortez, Mexico	0	0	0	0	1
	<i>Paralosalda</i>	E. Tropical Pacific	0	0	0	0	1
	<i>Pelachoris</i>	Australia	0	0	1	0	0
	<i>Pentacora</i>	Worldwide	2	2	1	5*	0
	<i>Oligosaldina</i>	Fossil	0	0	0	3?	0
Saldinae	<i>Chartoscirta</i>	Palaearctic	6	2	0	0	0
	<i>Halosalda</i>	Palaearctic	0	0	2*	0	0
	<i>Ioscytus</i>	Nearctic	5	0	1*	0	0
	<i>Micracanthia</i>	Holarctic, South America	7	6	1	0	0
	<i>Orthophrys</i>	Morocco, Portugal	0	0	0	0	1
	<i>Pseudosaldula</i>	South America	12	0	0	2	0
	<i>Salda</i>	Holarctic, Australia	15	2	0	0	0
	<i>Saldula</i>	Worldwide	110	10	6	0	0
	<i>Salduncula</i>	Indio-Pacific	0	0	0	0	4
Saldoniinae	<i>Saldonia</i>	Fossil	0	0	0	1?	0

\* Includes species that are halophilous but eurytopic, being also found inland.

mostly on my own observations and those of specialists such as H.C. Chapman and R.T. Schuh who have generously supplied unpublished data and specimens. Artur Bahr of Kiel has also made available a large collection of coastal Saldidae from Western North America along with extensive collecting data.

In spite of three hundred years of study, the taxonomy of the Saldidae is not at all settled, and until methods other than the classical morphological approach are used, a satisfactory classification is not likely. The classification of the Ochteridae and Gelastocoridae are presently stable to at least the generic level. The comments following are directed primarily at the Saldidae and closely related Omaniidae.

Most hemipterists have agreed that the Saldidae probably represent the most primitive living Heteroptera, the Proto-Saldidae being the ancestral stock from which all modern Heteroptera derived. As might be expected, the saldids are generalized and hence many of them lack the salient morphological structures derived from specialization that are so often used to separate species and species groups. The key presented here is artificial, and is meant to be used only for the marine fauna; it does not represent a phylogenetic scheme. Further, the subfamily divisions are those of Cobben (1959) rather than Popov (1973).

## SALDIDAE

The saldids are oval or elongate—oval littoral or intertidal bugs having legs of moderate length fitted for walking, and with very large coxae which give them the ability to jump a considerable distance. The tarsi are three-segmented and the claws are apical and symmetrical, without arolia. They have a short, declivant head, ocelli, very large compound eyes with excavate inner margins, long four-segmented antennae and an episthognathous (backwardly directed) four-segmented rostrum (three visible). The hemelytra is divided into a clavus and corium, which is leathery, and either a semi-transparent membrane with distinct cells, or a more or less leathery membranous region with reduced or indistinct cells. Many species have well-developed flight wings. They are usually dull black or brown, but some species have conspicuous white, yellow or red markings (Figs 9.1–9.3).

General works on the higher classifications of Saldidae have been published by Uhler (1877), Reuter (1895, 1912), Drake and Hoberlandt (1950) and Cobben (1959). A recent work by Wroblewski (1966) gives many valuable data on European species. The last published monograph on New World Saldidae was by Uhler (1877); a modern monograph was completed by Hodgden (1949a) but unfortunately never published.

### *Genus Aepophilus*

The monotypic genus *Aepophilus* is strictly intertidal. It is unique within the Saldidae in that the hemelytra do not cover the abdomen, the larval organ is

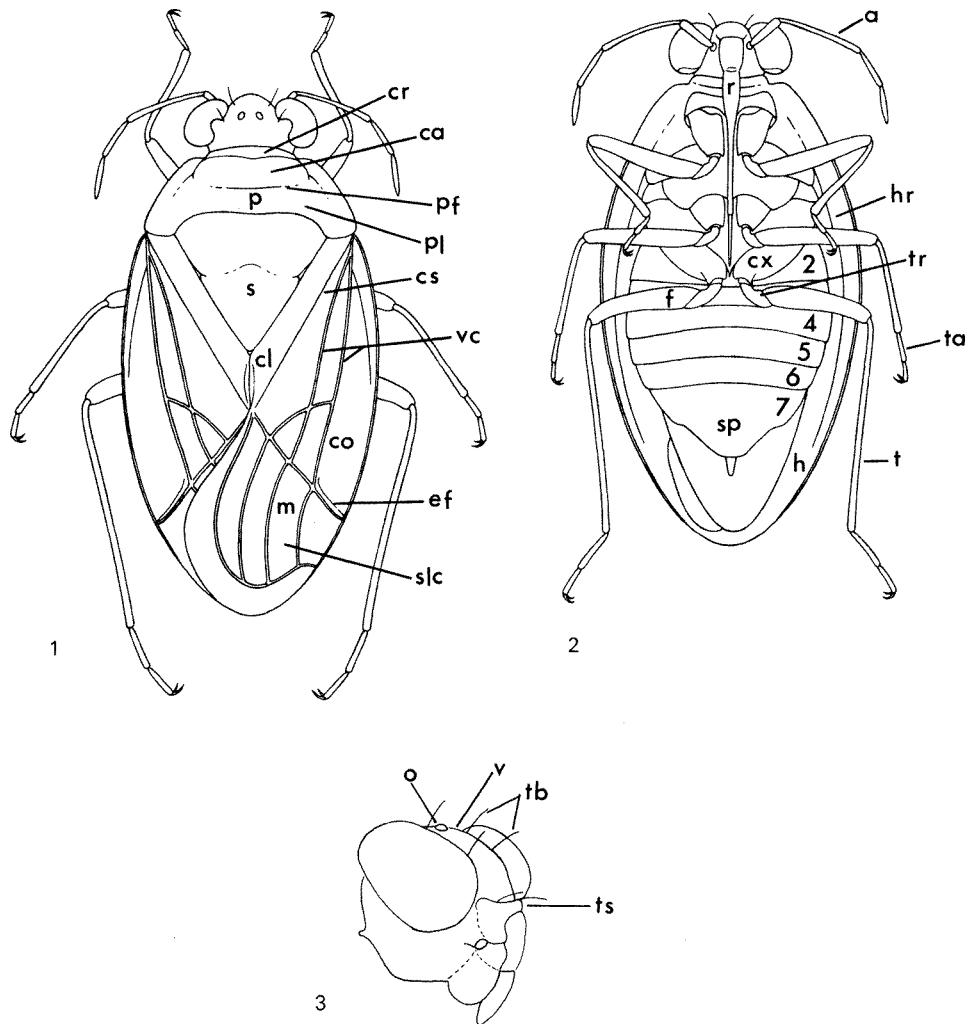

Figs. 9.1–3. *Saldula pallipes* (Fabricius), structures.

Fig. 9.1. Dorsal view. Fig. 9.2. Ventral view. Fig. 9.3. Head. Abbreviations: a, antennae; ca, callus; cl, clavus; co, corium; cr, collar; cs, claval suture; cx, coxae; ef, embolar fracture; f, femur; h, hemelytra; hr, hypocostal ridge; m, membrane; o, ocelli; p, pronotum; pf, pronotal furrow; pl, posterior lobe; r, rostrum; s, scutellum; sic, sublateral cell; sp, female subgenital plate; t, tibia; ta, tarsi; tb, trichobothria; tr, trochanter; ts, transverse swelling; v, vertex; vc, veins of the corium.

absent (Cobben, 1959), and the head lacks ocelli, post clypeus and maxillary plates. The eyes are small, not globose and prominent as in other saldids.

*Aepophilus bonnairei* was first described by Signoret (1879 in a work by Puton, 1879), who placed it in the Hydrometridae, a treatment followed by Saunders (1892).

It was Bergroth (1899) who pointed out that its affinities were much closer to the Saldidae and Ceratocombidae, and on his suggestion Lethierry and Severin placed it as a family between these two in their catalogue (1896). Leston (1956) was the first to include these bugs in the Saldidae, as a tribe, and Cobben (1959) concurred, except that he gave it subfamily rank. Concerning habitat, ecology and biology, the early British works of Keys and others were summarized by Butler (1923), and the early French works were summarized by Lienhart (1913); other works of interest are by Miall (1895), Alluaud (1926), China (1927), Renouf (1932), Baudoin (1939, 1955), Glynn-Williams and Hobart (1952), Morton (1954), King and Ratcliffe (1970) and Wollaston (1942).

### *Genus Chiloxanthus*

*Chiloxanthus* is a genus having mostly freshwater forms but *C. arcticus* (J. Sahlberg) is a euryhaline Holarctic species and *C. pilosus* (Fallen) is found only around saline habitats along the sea and inland in Europe (Linnavouri, 1953), and as far east as Mongolia (Hoberlandt, 1971) and Kamchatka (Cobben, 1960a). *Chiloxanthus* is characterized by the short sublateral cell of the membrane, and most members are quite large compared to other saldids. The marine species are usually black with light yellowish-brown markings.

The genus *Chiloxanthus* was described by Reuter (1891) as a subgenus of *Acanthia*, now known as *Saldula*; in 1895 he monographed the Old World *Acanthia* and listed four species in *Chiloxanthus*, then in 1912 gave it generic rank. The taxonomy of the marine species has been treated by Linnavouri (1953) and Cobben (1960a), and the former and Usinger (1960) gave some habitat and biological notes. Distributional data has been given by Sahlberg (1920) and Drake and Hoberlandt (1950) in addition to the works cited above.

### *Genus Enalosalda*

The monotypic genus *Enalosalda* belongs to the subfamily Chiloxanthinae. The hemelytra are leathery, the claval suture is lost, being evident only as a dark line, and the membrane is poorly differentiated with the cells much reduced and variable in number. The color varies from light yellowish-brown mottled with brownish markings to rather heavily marked (Fig. 9.4).

*Enosalda* was erected by Polhemus (Polhemus and Evans, 1969) to hold the species described by Van Duzee in 1923 as *Orthophrys mexicanus*, which was later transferred to *Pentacora* by Drake and Hoberlandt (1950). Lattin and Cobben (1968) showed that it definitely belonged in the Chiloxanthinae and provisionally left it in *Pentacora*. They noted that it might represent a new genus but they only had the female type. Polhemus rediscovered the species and published a full characterization and discussion of the genus along with some biological and habitat notes (Polhemus, 1972b).

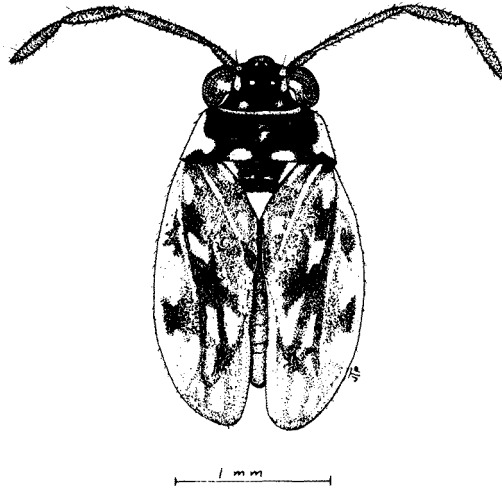

Fig. 9.4. *Enalosalda mexicana* (Van Duzee).

### *Genus Paralosalda*

*Paralosalda* is another monotypic genus in the subfamily Chiloanthinae, and is the only one with four well-developed cells in the membrane instead of the usual five (Fig. 9.5). They are black, with yellow and leucine markings. The ocelli are rather widely spaced, which seems to be typical of intertidal saldids.

*Paralosalda innova* Polhemus and Evans, was collected by Evans from seven locations in the intertidal zone of the eastern tropical Pacific, from Costa Rica to Columbia. Extensive ecological notes are given along with the description by Polhemus and Evans (1969).

### *Genus Pelachoris*

*Pelachoris* is also a monotypic marine shore form found in Southern Australia. The distinguishing characteristics of the genus (from *Pentacora* particularly, see below) as given by Drake (1962) are the deeply notched female subgenital plate, broad pronotal callus and shallowly excavated posterior pronotal margin. Aside from the strongly raised callus, these characters are shared with *Pentacora malayensis* (Dover), so either the latter should be placed in *Pelachoris* or more likely, *Pelachoris* should be made a synonym of *Pentacora*. The single species, *P. leucographa* (Rimes), is blackish-brown with striking leucine markings. Along with his description, Rimes (1951) gave some ecological and biological notes.

### *Genus Pentacora*

The genus *Pentacora* contains 7 species found in coastal marine habitats, 2 of these being euryhaline. Most *Pentacora* species are very quick flyers, taking to wing at the slightest disturbance, which makes them rather difficult to capture.



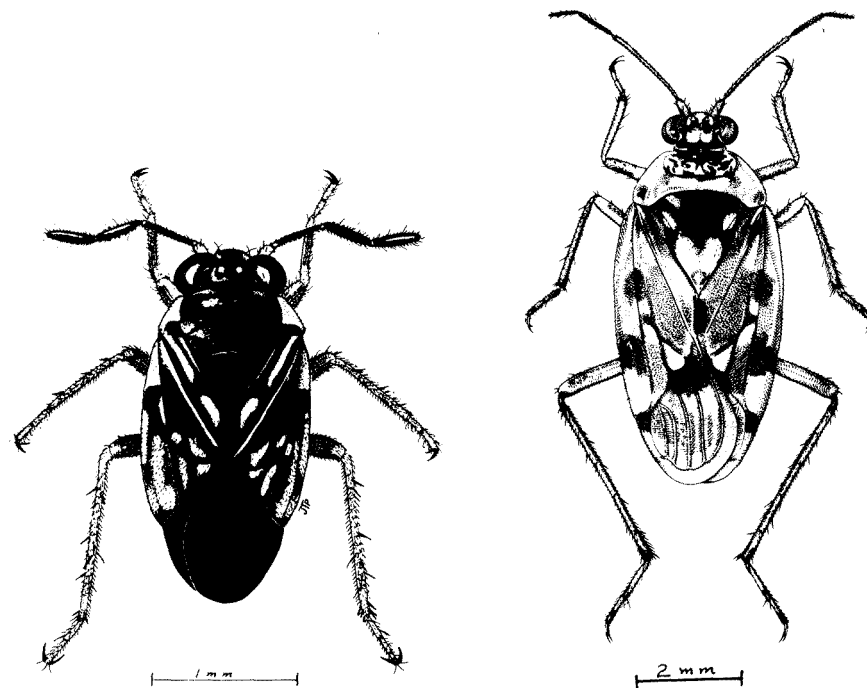

Fig. 9.5. (Left) *Paralosalda innova* Polhemus and Evans.

Fig. 9.6. (Right) *Pentacora signoreti* (Guerin).

Some species are extremely variable in color, ranging from extremely pale to melanistic, depending on the substrate on which they are found (Fig. 9.6). The distinguishing characteristic of this genus is the 5-celled membrane with the sublateral cell longer than the lateral cell, which will separate this genus from all but *Pelachoris* (see above) within the Chiloxanthinae.

*Pentacora* was erected by Reuter (1912) in his major work on saldid genera. Since the monograph of Uhler (1877), the most important publications on the taxonomy of the marine species are Stål (1873), Bergroth (1893), Torre-Bueno (1923), Dover (1929), Blöte (1947), Hodgden (1949b), Drake and Hoberlandt (1950), Drake (1949a, 1955), and Cobben (1959). Additional distribution and habitat data have been given by Chapman (1958, 1959) and Cobben (1960b).

### *Genus Halosalda*

The genus *Halosalda* is strictly halophilous, but *H. lateralis* (Fallén) can also be found in inland saline habitats (Cobben, 1960a; Wroblewski, 1966). Most specimens are brachypterous with the membrane reduced and coriaceous, but macropterous forms have a semi-transparent membrane. The shining dorsal surface is characteristic of this genus.

*Halosalda* was described by Reuter (1912) for a single species, *H. lateralis*, for which a number of varieties have been proposed. Cobben (1960a) considers one of these, *H. concolor* (Puton), to be a good species; his publication is adequate for the taxonomy of the genus. Biological and distribution notes have been given by Butler (1923), Sahlberg (1920) and Southwood and Leston (1959).

### Genus *Ioscytus*

*Ioscytus* is a New World genus occurring primarily on inland alkali and freshwater habitats. *I. politus* (Uhler) has been found in the mid-tidal region of a saltmarsh, but its usual habitat is on inland alkali soils (Fig. 9.7). This genus is characterized by a strongly raised callus set off by a sulcus set with deep pits, and the presence of stridulatory structures, consisting of a strigil on the ventral costal ridge and a plectrum on the hind femur. While some workers question whether *Ioscytus* should be considered separate from the genus *Saldula*, only one of the many *Saldula* species studied, *S. (Macrosaldula) variabilis* (Herrich-Schaeffer), has an evident stridulatory mechanism, which is of the same form as in *Ioscytus*.

The genus *Ioscytus* was erected by Reuter (1912) for the species *I. politus* (Uhler) and its variety *I. politus flavicosta* Reuter. No monograph of the genus is available; *politus* was described by Uhler (1877) from San Diego, California,

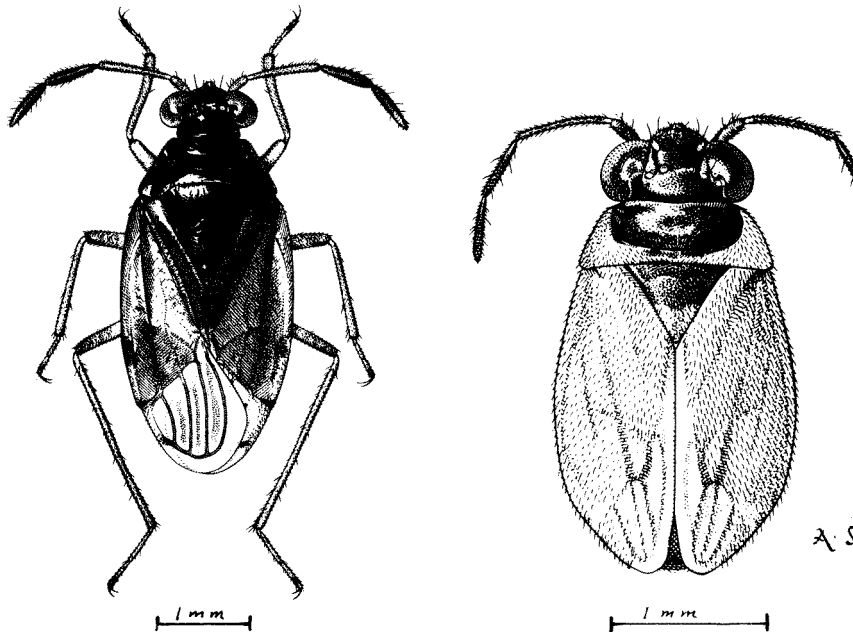

Fig. 9.7. (Left) *Ioscytus politus* (Uhler).

Fig. 9.8. (Right) *Orthophrys pygmaeum* (Reuter).

but no habitat data was given. Notes on habitats for this species have been published by Chapman (1962).

### *Genus Micracanthia*

*Micracanthia* is considered by Cobben (1960a) to be a subgenus of the large genus *Saldula*, however it can usually be distinguished by its small size, narrow anterior lobe of the pronotum and a distinct tendency for the veins of corium to be obsolete. There is only one species, *M. hungerfordi* (Hodgden) from the northeastern U.S., that is restricted to saltmarshes; 6 other species are euryhaline, being found in saltmarshes or along the edge of saltwater lagoons as well as in freshwater habitats. The remaining 7 species are so far known only from freshwater.

Reuter (1912) erected *Micracanthia* to hold 3 species, one being the euryhaline *M. humilis* (Say). No monograph is available, and the primary taxonomic works dealing with the species occurring in salty habitats are those of Uhler (1877), Reuter (1884), Champion (1900), Blatchley (1928), Hodgden (1949b), Drake (1952), and Cobben (1960b). Distribution, habitat and biology data have been given by Drake and Chapman (1952), Lindberg (1936), Chapman (1958, 1959), and Reuter (1895).

### *Genus Orthophrys*

*Orthophrys* is a monotypic genus known only from intertidal locations in Portugal and Morocco. This genus is easily distinguished from other genera in the subfamily Saldinae by the straight posterior margin of the pronotum and reduced, leathery membrane (Fig. 9.8). It is remarkably similar to *Enalosalda* from Mexico, which belongs to another subfamily, and the habitats are very similar indicating a parallel evolution in the two genera.

The genus was described by Horvath (1911) to hold the species *pygmaeum* (Reuter). Other works dealing with this genus are by Reuter (1900; description of *pygmaeum*), Drake (1958), Lattin and Cobben (1968) and a splendid work on the ecology of *O. pygmaeum* by Baudoïn (1955).

### *Genus Pseudosaldula*

The genus *Pseudosaldula* is restricted to the high mountains and southern latitudes of South America, where one species, *P. paralia* (Torres), is known from the sea shore at Tierra del Fuego, Argentina, the southern tip of the Americas, and another, *P. cobbeni* China, from the shore of Chiloe Island, South Chile. This genus may be easily separated from the other Saldinae by the presence of five instead of four cells in the membrane.

This genus was proposed by Cobben (1961) to hold a number of species formerly placed in *Pentacora*. Drake (1962) described a new genus *Oreokora* which is a synonym of *Pseudosaldula*, and provided a check list of the species. While it is

not stated, *P. bergi* (Haglund) probably is from the sea shore; *P. paralia* seems to be inseparable from it, and is most likely a synonym, as they both occur at Tierra del Fuego.

The taxonomic works concerning the sea shore species, in addition to those given above, are by Torres (1954) and China (1962). Nothing has been published concerning the ecology or biology of this genus.

### Genus *Salda*

The genus *Salda* is worldwide in distribution and primarily an inhabitant of freshwater shores and meadows. The type species of the genus *S. littoralis* (L.) is, however, euryhaline and quite commonly found both in saltmarshes and freshwater habitats. *Salda littoralis* and another euryhaline species, *S. buenoi* (McDunnough) (Fig. 9.9), may be separated from other Saldinae by the character of the inner cell of the membrane given in the key. (Not all members of the genus can be so separated, as some freshwater *Salda* would key to *Saldula*.)

*Salda* was erected in 1803 by Fabricius to hold all of the saldid species known at that time, thus rejecting the use of the generic name *Acanthia*, which he restricted to the bed bugs (Cimicidae). *S. littoralis* was described by Linnaeus (1758), and was named type species of the genus by Blanchard (1848). References to this genus and species in Europe are multitudinous, but the taxonomic works of Cobben (1959, 1960a) are adequate. Some useful taxonomic works on New World *Salda* are by McDunnough (1925), and Drake and Hottes (1950). The

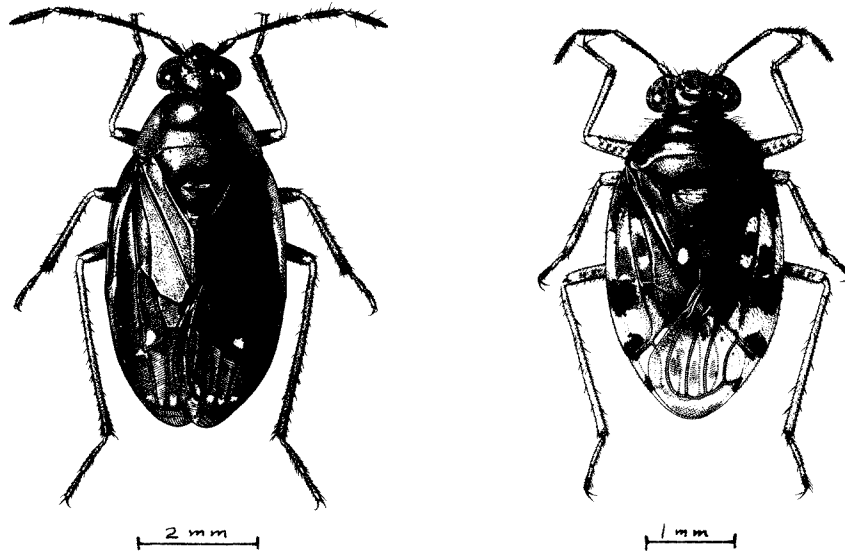

Fig. 9.9. (Left) *Salda buenoi* (McDunnough).

Fig. 9.10. (Right) *Saldula pexa* Drake.

biology of *S. littoralis* has been given by Jordan and Wendt (1938), with other biological notes by Butler (1923), and Southwood and Leston (1959). The distribution of this species is Holarctic, but many earlier U.S. records belong to the recently described *S. coloradensis* Polhemus (see Polhemus, 1967, for notes on distribution of *S. littoralis* and other species in the New World).

### *Genus Saldula*

The genus *Saldula* is by far the largest genus in the Saldidae, containing species not otherwise assignable (Fig. 9.10). Its generic limits therefore are in dispute, with Cobben (1960a) of the opinion that *Halosalda* and *Micracanthia* are nothing more than subgenera, but on the other hand Benedek (1968) and Dethier (1974) indicating that the subgenus *Macrosaldula* contains recognizable subgroups; there is considerable evidence that *Saldula* as it stands is not a natural group, and generic-subgeneric changes will certainly be made within the near future. For the present, however, the characters given in the key will separate the genus from other marine saldids.

While this worldwide genus contains mostly freshwater species, about 15 are euryhaline or confined to saltmarshes, mostly in the temperate and arctic regions, and 4 of the seashore species are Holarctic; some species undergo periods of tidal submersion, but none have been found in reef intertidal habitats.

*Saldula* was proposed by Van Duzee (1914) to replace the now obsolete *Acanthia* (Hemming and Noakes, 1958). The work of Cobben (1960a) is adequate for most European species; additional useful notes on some shore species are given by Lindskog (1974). The taxonomic works are numerous and scattered; publications useful in dealing with the marine species are by Stål (1873), Douglas (1874), Blatchley (1926), Cobben (1960a,b), Drake (1949b, 1950), Drake and Hoberlandt (1950), Drake and Hottes (1950, 1955), Hodgden (1949b), Polhemus and Chapman (in press), Rimes (1951), Usinger (1956), and Wagner (1950). Biological, ecological and habitat information, as well as some taxonomic data have been given by Brown (1943, 1948), Butler (1923), Chapman (1958, 1959), Ekblom (1926), Lane and Gustafson (1969), Lindberg (1936, 1958), Lindskog (1968, 1974), Renouf (1932), Sahlberg (1920), Southwood and Leston (1959), Stock (1972), Wiley (1922) and Wroblewski (1966).

### *Genus Salduncula*

*Salduncula*, containing four species, is a strictly intertidal genus of the Indio-Pacific region. It is distinguished from other Saldinae by the wide spaced ocelli, the lack of a distinct transverse swelling [postclypeus of Cobben (1960)] on the fore part of the head below the eyes, and the very weakly raised callus of the pronotum (Fig. 9.11). Species of this genus have well developed wings, but specimens collected from the Tokara Islands were reported unable to jump or fly (Miyamoto, 1963).

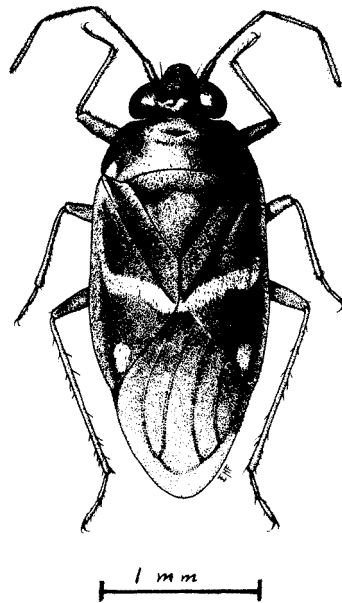

Fig. 9.11. *Salduncula swezeyi* (Usinger).

The genus *Salduncula* was proposed by Brown (1954) to hold *S. seycellensis* Brown. Later, Drake (1957) described *S. woodwardi* from Samoa, and in 1961 transferred *Saldula swezeyi* (Usinger) to this genus. Miyamoto (1963) added *S. decempunctata* from the Tokara Islands and gave some ecological notes. Additional works on taxonomy can be found in Usinger (1946) and notes on distribution and other habitat information can be found in Kellen (1958), Brown (1959) and Miyamoto (1964).

### *Genus Chartoscirta*

The genus *Chartoscirta* was proposed by Stål (1868) as a subgenus of *Salda* to hold the four common European species. While most authors reported this genus from freshwater habitats, Brown (1943) found *C. cincta* (Herrich-Schaeffer) around slightly saline brackish waters, and Southwood and Leston (1959) found *C. elegantula* (Fallén) occurring between tide marks. The genus can easily be distinguished from other marine Saldinae by the deep pitted furrow between the pronotal lobes, reaching the lateral margins of the pronotum, which are concave. In the four species studied, a stridulatory mechanism is present, with the strigil on the costal margin and the plectrum on the hind femur in the form of a raised ridge.

The only other genus having a pronotal structure similar to *Chartoscirta* is *Saldoidea* Osborn, but the latter has in addition, paired conate structures which

are lacking in *Chartoscirta*; *Saldoida* is not considered marine, in spite of a record of *S. slossoni* Osborn collected 'from the edge of a saltmarsh' by Chapman (1958). *Chartoscirta* is restricted to the Old World.

In addition to the works cited above, the key provided by Cobben (1960a) is useful in separating the European species, and sparse biological notes have been provided by Butler (1923).

## OMANIIDAE

The omaniids have been given the name intertidal dwarf bugs by Cobben (1970) when he proposed a new family for them. They are very similar to the Saldidae, the most obvious differences being their small size (less than 2 mm), convex dorsum, rather short abdomen, and the distinct collar-like vertex region of the head; only the last of these is truly diagnostic. Cobben listed 27 characters in which the two families differ. While many of these require dissection to assess, the dorsal abdominal spiracles, greater number of setae on the head and compound eyes (8 and 3, respectively), and the plate-shaped ovipositor (vs. lacinate) are readily visible. In addition the hemelytra are shield-like, with no indication of a membrane; the flight wings are absent, and the scutellum correspondingly reduced. Omaniids are typically grey or bluish, without conspicuous markings. All members of the family are intertidal on reefs, and are distributed widely in the Indo-Pacific region and the Red Sea.

The recent work on Omaniidae by Cobben (1970) is comprehensive, covering morphology, systematics, phylogeny and distribution. The earlier works will be covered in the generic synopses.

### *Genus Omania*

This monotypic genus was founded by Horvath (1915) on a single specimen from Oman, and until recent years a paucity of material has prevented a comprehensive diagnosis of this genus. The primary character separating *Omania* from *Corallocoris* is the shape of the collar of the vertex region of the head, as indicated in the key. Also, the hemelytra in the former have no sutures, while in *Corallocoris* there are two longitudinal hemelytral sutures.

*Omania coleoptrata* Horvath is known from localities in the Red Sea and northern Arabian Sea, with a recent record from the coast of Pakistan (leg. A. Hamid). It was first collected in 1902 by Biro, and the next specimen was collected by Dollfus on the Sanai Peninsula in 1928. The latter was described by China (1938) as a new genus and species, *Dollfusella minutissima*, but synonymized with *O. coleoptrata* by Poisson and Poisson (1943). Additional captures from the Red Sea, along with habitat notes, have been described by Linnavouri (1964) and Schuster (1965).

### *Genus Corallocoris*

Cobben (1970) proposed the genus *Corallocoris* to hold three Indio-Pacific species. *Corallocoris marksae* (Woodward) has a wide distribution and is known from Samoa, Australia, New Caledonia and Singapore (Cobben, 1970). *C. nauruensis* (Herring and Chapman) was collected from Nauru Island on the equator, and *C. satoi* (Miyamoto) from the Tokara Islands.

Fortunately, excellent publications are available on the taxonomy (Cobben, 1970) and biology (Woodward, 1958; Kellen, 1960) of this genus. Other works include Drake (1961), Herring and Chapman (1967) and Miyamoto (1963, 1964).

## GELASTOCORIDAE

The Gelastocoridae, commonly known as Toad Bugs, are littoral to dry land bugs in general. They are stout, medium-sized bugs, with a triangular head in front view, closely fitting between the antero-lateral angles of the pronotum. Their eyes are large, kidney-shaped and projecting; ocelli are usually present. The antennae are short, four-segmented and hidden in a pit beneath the eyes. Prey are grasped with the raptorial front legs, not possessed by any other shore bugs.

Several species of the genus *Nerthra* are apparently restricted to marine shores. The peculiar disjunct distribution of *Nerthra rugosa* (Desjardins), described from a seashore (China, 1962), was noted by Todd (1955) in his monograph of the family; all localities were coastal but detailed collecting records were absent except for Matecumbe Key, Florida, where the species was found in debris near the surf. Later, 6 specimens, one adult and 5 nymphs, were collected in algae from two intertidal localities on the Brazilian coast by Schuster (Todd, 1965), adding to the known distribution of Mauritius, the Indo-Australian region, the Pearl Islands of Panama, and Florida. This and some other *Nerthra* species have fused wing covers and cannot fly. They may disperse by rafting. *N. macrothorax* (Montrouzier), which has a wide, disjunct distribution, has been found burrowing in rotten *Pandanus* (screw pine) logs (Todd, 1959, 1960), lending credence to the rafting hypothesis. *N. spangleri* Polhemus is restricted to the mud flats around coastal lagoons or small inlets on the west coast of Mexico (Polhemus, 1972a), being found under pieces of detritus or stones, where they make a small burrow and await their prey. *Nerthra manni* Todd, a typically freshwater species, is occasionally found with *N. spangleri*.

The primary taxonomic work is the monograph of Todd (1955), and the only biological notes on the genus *Nerthra* were given by Kevan (1942).

## OCHTERIDAE

The ochterids are moderate-sized (3–5 mm long) shore bugs, brown or blackish in coloration, without prominent markings. They are oval, have strongly convex eyes and two ocelli. The antennae are short, 4-segmented and largely hidden under



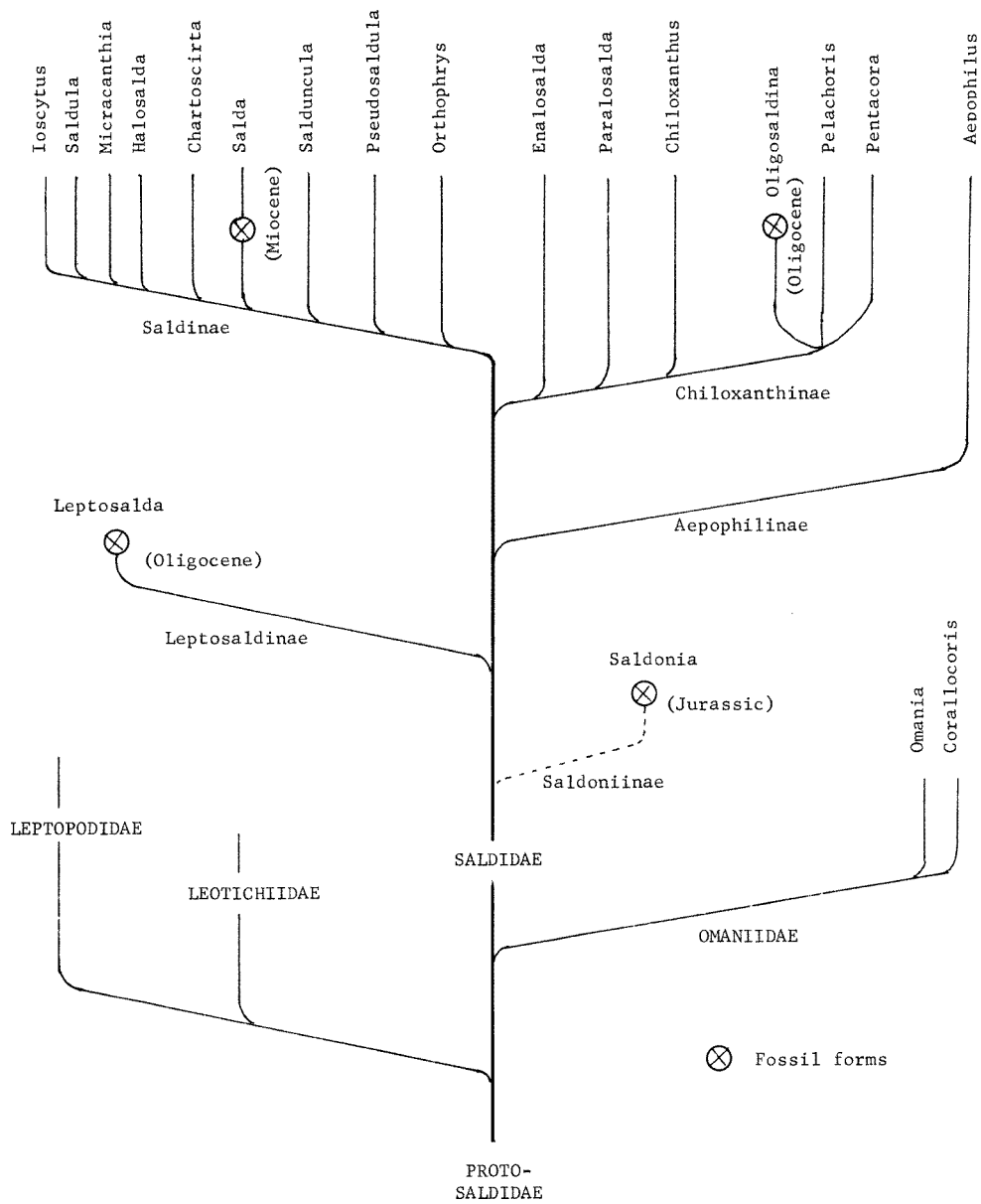

Fig. 9.12. Relationships of marine Saldidae and allied forms.

the head, but not in a pit. The fore legs are slender, and modified for running, not grasping. The rostrum is 4-segmented (three visible) and very long, reaching backward to the posterior coxae.

There are three genera of ochterids but only three species of the genus *Ochterus* occur in saltmarshes: *O. aenifrons* (Champion), *O. perbosci* (Guerin) and *O. americanus* (Uhler). Nothing is known of the exact salinity where any of these were found, but the first two were found with *Pentacora signoreti* (Guerin) and *P. sphacelata* (Uhler), respectively, both salid species restricted to saline habitats.

The latest monograph of the Ochteridae of the New World is by Schell (1943). Biological data on *Ochterus* can be found in Bobb (1951).

## KEY TO MARINE SHORE BUGS

- |  |                                     |
|--|-------------------------------------|
| 1. Antennae short, inconspicuous, hidden under head  | 2                                   |
| Antennae long, exposed, protruding from head   | 3                                   |
| 2. Tarsal formula 2 :2 :2; antennae concealed in pit beneath eyes (Gelastocoridae)   | <i>Nerthra</i>                      |
| Tarsal formula 2 :2 :3; antennae beneath eyes, but free, not concealed in pit beneath eyes. (Ochteridae)   | <i>Ochterus</i>                     |
| 3. Length of adults less than 2.0 mm; head with collar-like structure on posterior portion of vertex. (Omaniidae)  | 4                                   |
| Length of adults more than 2.0 mm; head without collar-like structure on posterior portion of vertex. (Saldidae)   | 5                                   |
| 4. Collar-like structure of head demarcated from remainder of vertex by a broadly arcuate line   | <i>Corallocoris</i> (Fig. 9.13a, b) |
| Collar-like structure of head demarcated from remainder of vertex by a line which forms a sharp angle anteromedially   | <i>Omania</i>                       |
| 5. Head without ocelli; hemelytra reduced to small triangles; scutellum reduced to a thin wedge (Aëphophilinae)  | <i>Aëphophilus</i>                  |
| Head with ocelli; hemelytra covering abdomen; scutellum approximating an equilateral triangle  | 6                                   |
| 6. Hemelytra with long embolar fracture reaching at least to level of posterior end of claval suture (fracture lost in <i>Enalosalda</i> ). Female subgenital plate truncate, usually square; if produced caudad-medially, membrane has 5 cells (Chiloxanthinae)   | 7                                   |
| Hemelytra with short embolar fracture, not reaching forward more than half-way from beginning of fracture on costal margin to level of posterior end of claval suture (fracture lost in <i>Orthophrys</i> ). Female subgenital plate produced caudad medially. Membrane usually with 4 cells (except 5 in <i>Pseudosaldula</i> ) | 11                                  |
| 7. Posterior margin of pronotum not indented, almost straight. Clavus, corium and membrane not clearly demarcated. Embolar fracture lost or evident as a faint brown line  | <i>Enalosalda</i> (Fig. 9.4)        |
| Posterior margin of pronotum indented. Clavus, corium and membrane demarcated. Embolar fracture present  | 8                                   |
| 8. Membrane with 4 well-developed cells  | <i>Paralosalda</i> (Fig. 9.5)       |
| Membrane with 5 well-developed cells   | 9                                   |
| 9. Sublateral cell of membrane short, only half as long as lateral cell  | <i>Chiloxanthus</i>                 |
| Sublateral cell of membrane subequal in length to lateral cell   | 10                                  |

10.	Female subgenital plate with deep median notch. Distribution only Australian	<i>Pelachoris</i>
	Female subgenital plate with or without deep median notch. If notch present, distribution Malaysian or New World	<i>Pentacora</i> (Fig. 9.6)
11.	Posterior margin of pronotum not indented, almost straight	<i>Orthophrys</i> (Fig. 9.8)
	Posterior margin of pronotum clearly indented	12
12.	Membrane with 5 cells; distribution southern South America	<i>Pseudosaldula</i>
	Membrane with 4 cells	13
13.	Membrane with first (inner) cell protruding anteriorly half its length beyond second cell	<i>Salda</i> (Fig. 9.9)
	Membrane with all cells of subequal length, or with first cell protruding anteriorly much less than half its length beyond second cell	14
14.	Hemelytra completely shining, with many large pits on surface	<i>Halosalda</i>
	Hemelytra dull or faintly shining, without obvious large pits on surface	15
15.	Callus of pronotum very prominent, set off from posterior lobe by a row of deep pits in a prominent furrow	16
	Callus of pronotum more or less prominent, not set off from posterior lobe by a row of deep pits in a furrow	17
16.	Pronotal furrow reaching lateral margins, which are concave	<i>Chartoscirta</i>
	Pronotal furrow not reaching lateral margins, which are convex or straight	<i>Ioscytus</i> (Fig. 9.7)
17.	Callus of pronotum raised only slightly on each side of median pit; weakly differentiated from posterior lobe, not set off by suture or depression	<i>Salduncula</i> (Fig. 9.11)
	Callus of pronotum broadly raised, set off from posterior lobe by a suture or depression	18
18.	Veins of corium obsolete. Size small, usually less than 3.5 mm. Anterior edge of pronotum narrower than collar	<i>Micracanthia</i>
	Veins of corium more or less distinct. Size larger, usually more than 3.5 mm; if less, then anterior edge of pronotum wider than collar	<i>Saldula</i> (Fig. 9.10)

### 9.3 PHYLOGENY AND EVOLUTION

The fossil record for Saldidae is poor (and for the three other families of marine shore bugs no fossils are known). At present, one extinct species of Saldidae is known from the middle Jurassic of the Mesozoic era (Popov, 1973), and seven from the upper Oligocene or Miocene of the Cenozoic. The latter were reviewed by Popov (1973) except for the extinct subfamily Leptosaldinae described by Cobben (1971) from Chiapas Amber. These authors are in sharp disagreement concerning the primitive and derived states of a number of characters. They also disagree as to whether the Saldidae are the oldest living family of Heteroptera, and therefore, whether the various families within the suborder arose from a proto-saldid ancestor (Popov) or gerromorphan ancestor (Cobben).

The marine Saldidae and Omaniidae provide a much wider variety of character states than the freshwater and inland forms, especially in some intertidal species which exhibit extensive loss phenomena along with adaptations to the marine environment (e.g., *Aëpophilus*, Omaniidae). Cobben (1965, 1970) considers *Aëpophilus* to be the most primitive living saldid, particularly on the basis of the male and female genitalia, and this may be true; certainly the extreme reduction

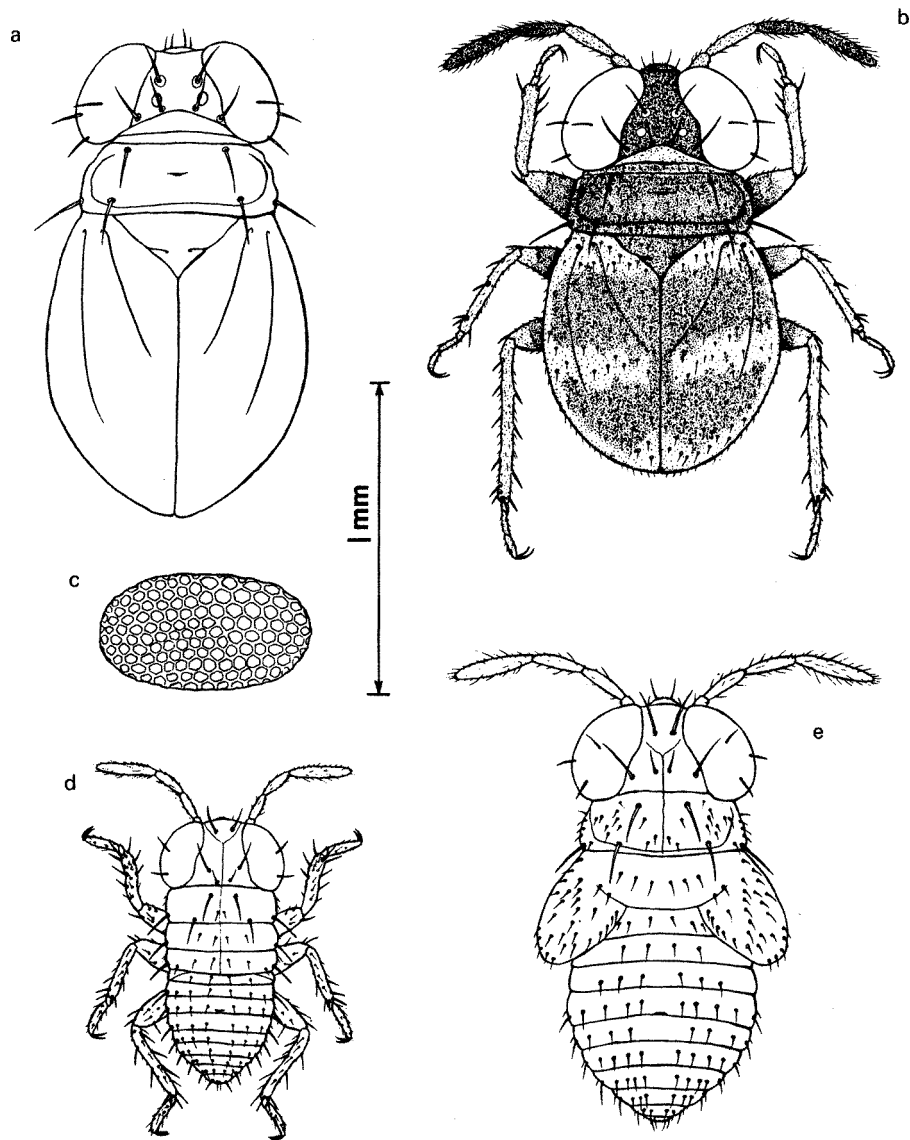

Fig. 9.13. *Corallocoris marksae* (Woodward), egg, nymphs and adults, (a) Dorsal view of ♀ (b) view of ♂: (c) Egg; (d) Dorsal view of 1<sup>st</sup> instar nymph; (e) Dorsal view of 5th instar nymph.

of wings and compound eyes, and loss of ocelli indicate a long isolation from the remainder of the known species, and the low intertidal habitat obviating competition from other saldid species would permit retention of primitive characters. On the other hand, the evidence of a social mode of living (Keys, 1895) and the development of a plastron-like modification of the cuticle which may permit

underwater respiration (King and Ratcliffe, 1970) suggest that in some respects this species may be the most highly specialized of the Saldidae.

The same arguments given above also apply to the Omaniidae, which has developed dorsal spiracles which probably extract oxygen from a bubble captured under the elytra if the bug becomes submerged under water.

Parallel evolution and loss phenomena in a restrictive niche are seen in *Orthophrys* and *Enalosalda*, which are remarkably similar in general facies and mid tidal habitat, but belong to different subfamilies; both of the land masses on which these bugs occur (Gibraltar area and Western Mexico, respectively) have existed in essentially their present form since at least the Cretaceous (Durham and Allison, 1960; Wilson et al., 1971). All of these specialized bugs represent evolutionary dead-ends, with the potential of existing unchanged over a long period in stable habitats, but facing extinction if their habitat is substantially altered.

The intertidal genus *Paralosalda* presents a different picture. The habitat of this genus along the coastline of Central America has been the scene of considerable changes until the Pliocene (Stuart, 1966). The single known species of *Paralosalda* has well-developed flight wings and is quite generalized in structure, although it is quite separated from the remainder of the subfamily to which it belongs.

The last intertidal genus, *Salduncula*, occurs on some truly ancient land forms (Madagascar, Seychelles, Japan, Australia), and some apparently dating only from the Tertiary (Guam, Samoa). It too has well-developed flight wings and appears to be rather more dispersive than some of the other intertidal genera. It apparently diverged from the main stem of the Saldinae long ago.

The shore and saltmarsh inhabiting genera are, as a group, more generalized and dispersive than the intertidal forms. They constitute a more homogenous group with an almost continuous spectrum of species and genera rather than the striking phenetic dissimilarities apparent in the intertidal genera. With the exception of the warm-adapted *Pentacora* and secondarily cold-adapted *Chiloxanthus* (Cobben, personal communication), they are primarily cold-adapted species, subject to the more hostile environment of the temperate and arctic zones, and to the changing conditions of the shores and marshes. During recent geologic periods they have been subjected to considerable climatic changes manifested in continental glaciation, so it is not surprising that they constitute a rather adaptable, vagile assemblage.

The works of Cobben and Popov cited previously summarize the earlier views on the phylogeny of the Heteroptera, including the work of China (1955) who presented an interesting diagram of the evolutionary trends. Without intending to propose at this time a new phylogeny for the Saldidae and other shore bugs, the relationships of the marine saldids to each other, to closely related families, and to fossil forms are shown in Fig. 9.12. The salient point to be conveyed by this diagram is the multiple origin and diversity of the marine shore bugs, especially

the intertidal genera. It is worth noting that the Oligocene *Oligosaldina* (Staatz and Wagner, 1950) bears a remarkable resemblance to the modern *Pelachoris*, and may indeed be synonymous with it. (Further, the latter is very likely synonymous with *Pentacora*, at least no more than a subgenus.) The fragmentary remains of the single specimen of *Saldonia* (Popov, 1973) do not permit it to be placed with any certainty.

## 9.4 BIOLOGY

### 9.4.1 General life history

In spite of repeated attempts by a number of workers to establish the life histories of Saldidae, only a few have succeeded. Saldidae are rather difficult to rear, requiring constant attention to humidity in particular. Omaniidae has been reared, but the marine-associated Ochteridae and Gelastocoridae have not.

Cobben (1968) has given a comprehensive study and review of literature on saldid eggs, including three intertidal species. The eggs vary from about 0.60 to 1.20 mm in length, being about 2.5 times longer than wide. While littoral saldids ordinarily insert their tapered eggs in plant tissues by means of the well-developed ovipositor, those species ordinarily associated with bare rocky substrates have eggs that are equally blunt at both ends and are evidently glued superficially on the substrate. Eggs of *Orthophys* and *Enalosalda* are of the usual shape indicating insertion into a soft substrate, but the eggs of *Aëpophilus* are kidney-shaped and probably are laid semi-exposed in crevices (Cobben, 1968).

The ovipositor of Omaniidae is vestigial, being reduced to a plate-like structure (Woodward, 1958; Cobben, 1970). Cobben (1970) also discussed the eggs earlier described by Kellen (1960, see Fig. 9.13c), which are probably laid in an exposed position in the cavities of volcanic rocks.

Maturation of most saldid eggs studied requires from five to nine days. Hatching is initiated by means of an egg burster on the head of the embryo, which ruptures the egg at the anterior pole. The shell then splits open longitudinally and the nymph emerges. Successful maturation and hatching can occur either in moist air or under water. The nymphs require about 16 days to pass through five instars to the imago stage, the time being temperature-dependent (Polhemus, personal observations; Wiley, 1922; Rimes, 1951; Cobben, 1968; Stock, 1972). *Salda littoralis* has a longer development time, taking about 40 days from egg hatching to adult (Jordan and Wendt, 1938).

Kellen (1960) studied the life history of *Corallocoris* in Samoa and found eggs hatching in 16 days, the early instar nymphs requiring an average of 5–7 days per stadium, with the last instar requiring 6–10 days (Fig. 9.13d,e).

While *Aëpophilus* has been much studied, the complete life history has not been

worked out. The maturation time is seemingly long, as specimens require four months to pass through several instars in the laboratory (Keys, 1914). Apparently adult *Aëpophilus* guard the brood (Keys, 1895; Lienhart, 1913). Although parental care is well documented in other Heteroptera (Hussey, 1934) it is not known in other Saldidae.

In the colder regions, saldids overwinter in the egg stage or in the adult stage, while in the warmer climates they breed at various times and are found as adults all year long. As far as can be determined, all of the species of Saldinae that occur commonly or solely in marine habitats overwinter as adults, but *Salda littoralis* may also overwinter in the egg stage depending on geographical location (Southwood and Leston, 1959). Some species of *Saldula* that are euryhaline but found occasionally in the marine habitat, overwinter as eggs (e.g., *Saldula variabilis*). I have not seen any northern records for *Pentacora* before mid-June, so apparently this genus overwinters in the egg stage. Intertidal saldids are found as adults all year long, and apparently breed throughout the year but have preferred breeding periods (Southwood and Leston, 1959; Kellen, 1960).

The life histories of the gelastocorids and ochterids are quite different from the saldids and omaniids. The eggs are laid on plants or sand, or in the sand, as these bugs do not have ovipositors. The maturation times for nymphal instars vary from about 10–30 days for *Ochterus banksi* Barber, with the fourth instar requiring exposure to cold to progress (Bobb, 1951), which of course would not be the case with the warm-adapted marine shore species. No life history data is available for *Nerthra* except for fragmentary observations by Kevan (1942), and the only life history for the family is for *Gelastocoris oculatus* (Fabricius), provided by Hungerford (1922).

#### 9.4.2 Mating behaviour

Pre-mating courtship behaviour in Australian marine saldids has been described by Rimes (1951), who also noted that the female tries to insert her rostrum into the male's body if he is unsuccessful in a mating attachment attempt.

Saldids and omaniids copulate side by side, with a grasping plate on the posterior margin of the first visible paratergal plate and a set of pegs or spines on the anterior margin of the second visible paratergal plate of the male that grasps a modified region on the edge of the hemelytra of the female. This, coupled with the locking of the genitalia, allows the mated pair to jump or walk without uncoupling. These structures were first described as stridulatory by Drake and Hottes (1951) but later correctly diagnosed as coupling organs by Leston (1957) and Cobben (1957), with the latter providing good figures of the locking mechanism. Both papers also provide reviews of the literature on saldid copulation. The position of the modified region of the female hemelytra has been used as a subspecies character for *Pentacora signoreti yucatana* Hodgden (1949b).

The males of both gelastocorids and ochterids have assymetrical genitalia, and mating takes place with the male astride the female, but to one side.

#### 9.4.3 Feeding, food, predators and parasites

As far as we know, saldids and other shore bugs feed on fly larvae, worms, any disabled or sluggish animals in the surface layers of damp earth or algae. Members of *Nerthra* have raptorial front legs which enable them to capture and feed on more active prey.

Although the precise method of prey location by Ochteridae is not known, Saldidae locate subsurface prey by chemoreceptors located on the antenna (Polhemus, unpublished observation) and probably locate surface prey by a combination of chemoreception and visual means. When the trail or track of subsurface prey is detected, the antenna are lowered toward the ground in a response rather similar to that seen in prey detection by parasitic Hymenoptera (Vinson, 1968). The trail is followed until the prey is approached, whereupon the beak is lowered and repeated probing of the substrate begins. When prey is encountered, the rostrum is inserted and undoubtedly a protease enzyme is injected to immobilize the organism and liquify the body contents before they can be sucked up as in several other predaceous Heteroptera studied (Picado, 1937, 1939; DeCarlo, 1959; Cheng, 1967). Ekblom (1926) noted that a fly larva died within a few minutes after being attacked by a saldid.

There are few observations on feeding behavior in nature. Ekblom (1926) saw *Saldula saltatoria* (L.) feed on fly larva both above ground and in the soil; Lindskog (1968) made similar observations on the same species but added enchytraeid worms and chironomid midges as important food sources. I have reared saldids from egg to adult with nothing more in the terrarium than the damp earth from their habitat. When individuals are crowded in a terrarium, the soil organisms can be augmented with almost any soft-bodied organisms, which are readily accepted, including planarians, beetle larvae, disabled saldid nymphs, caddis fly larva, various dead flies (Hungerford, 1920; Schuh, 1967), mirids and jassids (Wiley, 1922) and katydids (Usinger, 1956). Rimes (1951) noted that Australian marine shore species feed on eggs of their own kind, as well as shore flies in nature, but will feed on *Drosophila* in the laboratory. Stock (1972) described *Saldula palustris* (Douglas) feeding on a third instar nymph of its own species and an amphipod.

While the above notes apply generally to saltmarsh and marine shore as well as euryhaline species, Wroblewski (1966) suggested that species restricted to saline habitats are perhaps specialized to feed on organisms found only in these places.

The food of intertidal saldids are even less known. *Aëpophilus* has been seen feeding on marine worms in nature (Glynn-Williams and Hobart, 1952) and



these were noted to be the prevalent organism in their habitat (Morton, 1954). Keys (1914) reared *Aëpophilus* through several nymphal instars to adults over a period of four months by simply using 'a suitable stone, well covered with muddy slime, etc., from the habitat', keeping it wet with unpolluted seawater, and changing it every few days. China (1927) thought that these bugs fed on the algae covering the rocks of the *Fucus* zone, but it seems much more likely that worms in the algae were actually the food source. Glynne-Williams and Hobart (1952) offered a variety of foods including *Fucus* to *Aepophilus*, but found them to feed only on pieces of marine worm; these authors also discussed possible food of *Aepophilus*.

Evans (1968) studied the ecology of *Enalosalda mexicana*, but was not able to observe feeding. He concluded that the main source of food for this species must be stranded copepods or other plankton or remains of macroscopic animals cast up by the tide. I have observed hundreds of specimens of the same species under various conditions, and have never observed feeding.

The food of *Paralosalda* is probably the same as that of *Enalosalda*, but again, Evans was not able to observe them feeding (Polhemus and Evans, 1969). Kellen (1960) observed *Corallocoris* probing the surface of the volcanic rocks and algae with their beaks, and Woodward (1958) suggested that these bugs feed on small arthropods such as Collembola and mites that are common in their habitat. Neither author was able to observe feeding in nature, but Kellen succeeded in rearing complete generations on rock and wet algae collected from the natural habitat, with small psychodid and tendepidid larvae added as additional food.

Predators on Saldidae include ants, spiders and their own kind (Stock, 1972). Shore birds may take some saldids, and would certainly take many except for the agility of these insects.

Only a few parasites have been noted on Saldidae. Red mites infest *Pentacora* spp., and in Death Valley a population of *P. saratogae* Cobben was so heavily infested that many specimens were unable to fly because the mites interfered with their wings. *Saldula palustris* and *S. saltatoria* have been found infested with mermenthid nematodes (Stock, 1972; Wroblewski, 1966).

## 9.5 ECOLOGY

### *9.5.1 Adaptation to marine environment*

The adaptations of shore bugs to the marine environment are largely through physiological and behavioral means rather than through morphological modifications, although there are notable exceptions (e.g. *Aepophilus*, Omaniidae).

### 9.5.2 Respiratory adaptations

Certain species of saldids which inhabit mid-tidal marshes prefer submersion at high tide. These shore bugs utilize bubble respiration in the adult stage, relying on a film of air trapped in the pilosity covering their bodies, called the plastron by Thorpe (1950). Typically, they cling to the vegetation while the water rises over them and remain quiescent or move about slowly until the tide recedes, whereupon they resume their activities after a recovery period. If they become dislodged and washed to the surface, they struggle until they encounter a stalk of vegetation, then climb down beneath the water again. The nymphs of these species are also submerged at high tide but are thought to survive by cuticular respiration (Stock, 1972).

This type of submergence behavior was first observed in *Saldula palustris* and *Halosalda lateralis* in England (Mason, 1889) and in a *Salda* sp. by Arndt (1915). Later observations by Southwood and Leston (1959) and the extensive study of this behavior by Brown (1948), primarily on *S. palustris* (as *S. pallipes*), were summarized by Stock (1972), who studied *S. palustris* in Oregon. The following species also undergo submersion for varying periods: *Chiloxanthus pilosus*, *Chartoscirta cocksii*, *Salda littoralis*, *S. buenoi*, *Saldula saltatoria*, *S. setulos* (Puton), and *S. pilosella* (Thomson).

A different type of respiratory adaptation was observed in intertidal saldids and omaniids. Typically these species hide themselves in a tiny pocket or crevice which traps an air bubble and protects them from wave action (China, 1938; Woodward, 1958; Kellen, 1960; Herring and Chapman, 1967; Polhemus and Evans, 1969; Polhemus, 1972).

The abdominal spiracles in Omaniidae are found on the membranous dorsal surface, thus the trapped air under the elytra permits bubble respiration in the same manner as that of true aquatic insects such as Naucoridae and Notonectidae. This could explain their presence in interstices in a gravel bed at high tide level in Singapore (Cobben, 1970).

*Aëpophilus* on the other hand has apparently developed a cuticular plastron around the spiracles from which the air film cannot be removed by ordinary means (King and Ratcliffe, 1970). Plastrons of a similar nature have been seen on many insect eggs (Hinton, 1969; Ch. 3). Theoretically they enable the organisms to extract oxygen from the water indefinitely.

### 9.5.3 Other adaptations

The most generalized method of coping with the tidal rhythm is through opportunism as shown clearly by *Pentacora signoreti* which runs rapidly and is also quick and powerful flier, enabling it to retreat before the advancing tide in a manner very reminiscent of the tiger beetles (Uhler, 1884). Many of the euryhaline saldids and ochterids fall in this category.

A somewhat more specialized approach is exhibited by a number of saltmarsh species which climb the stalks of vegetation as the tide rises, returning to the substrate to feed at low tide. In this category belong *Ioscytus politus*, *Micracanthia hungerfordi*, *M. husseyi* Drake and Chapman, euryhaline *Saldula* and those saltmarsh *Saldula* that prefer the edges rather than the mid-tidal zone (R.T. Schuh, personal communication; Polhemus, unpublished; Drake and Chapman, 1952).

In spite of the adaptations permitting the shore bugs to survive submersion, many of them are quite helpless when placed on the surface of the water (Keys, 1890; China, 1927; Herring and Chapman, 1967). Baudoin (1955) and Miyamoto (1955) have shown that these bugs can, by manipulating their legs and arching their bodies, deform the meniscus of the water and propel themselves up the slope at the water's edge. In this way they can gain access to vegetation or a rough substrate and resume their normal walking locomotion.

#### 9.5.4 Habitats

The habitats of marine shore bug fauna can be conveniently divided into four major categories: (a) reefs, (b) saltmarshes, (c) mangroves, (d) beaches and dunes.

##### (a) Intertidal reefs

Reefs may be composed of either rocks or corals. Rocky reefs are found worldwide, but coral reefs are restricted to the tropical seas where the minimum sea temperature is 20°C (Ekman, 1953). While shore bugs may be found on either type of reef, they are more common on volcanic rock, which is typically riddled with pockets and crevices in which the bugs can take refuge.

*Aëpophilus bonnairei*, probably the most ancient living saldid, lives at the lowest intertidal level, in crevices of the *Fucus* zone. The remainder of the intertidal shore bugs occur in the mid-tidal zone with the exception of *Corallocoris marksae* which also invades the upper tidal region in Malaysia (Cobben, 1970). *Orthophrys pygmaeum* and *Aëpophilus bonnairei* are found in the same reef along the Iberian peninsula and Morocco, but occupy different habitats, the former being mid- and the latter being low-intertidal. *Corallocoris* spp. and *Salduncula* also occur in the same areas (Woodward, 1958; Kellen, 1960; Miyamoto, 1963) in Samoa and the South-West Islands; these bugs are very different in size and almost certainly utilize different prey.

##### (b) Saltmarshes

Saltmarshes are found primarily in the temperate and arctic zones, being largely replaced in the tropical and subtropical regions by mangroves, although occasionally a mixture of marsh and mangrove will occur (Chapman, 1960). Extensive salt flats are found in the tropics and some of them have large areas covered with *Salicornia*. Laird (1956) studied 12 saltmarshes in connection with his work on

South Pacific Mosquito ecology. Although he recorded many families of Heteroptera, he did not find any shore bugs.

In an extensive saltmarsh lying inland from Progreso, Yucatan, *Pentacora signoreti* occurs as a subspecies, *P. signoreti yucatanana* Hodgden, which is puzzling as the nominate form was described from nearby Cuba. This species was found at the edge of the marsh around brackish pools in the limestone substrate along with *Ochterus aenifrons* and *Saldula palustris*.

The saltmarshes of the U.S. temperate zone harbor primarily *Saldula*, *Micracanthia* and the nearly ubiquitous *Pentacora*. Five species of *Saldula* and one species of *Ioscytus* were found in a steep saltmarsh fed by three freshwater streams at Tomales Bay, California. *Saldula comatula* Parshley and *S. pallipes* are typically freshwater species and only invade the upper part of the marsh; *S. luctuosa* (Stal), *S. villosa* (Hodgden) and *S. notalis* Drake are apparently restricted to the saltmarsh proper, but appear to have distinct habitat preferences within the marsh (Polhemus, unpublished).

Where the gradients of the marshes are shallower (e.g., east coast U.S. and most European localities), the number of species coexisting in a given marsh is usually lower, and the partitioning is more evident. Nonetheless, in a Connecticut saltmarsh (Harkness State Park), four species were found; *Micracanthia hungerfordi*, *Saldula palustris*, *Pentacora sphacelata* and *P. hirta* (Say), occupying different substrates or in different vegetative cover, except for *Pentacora* (R.T. Schuh, personal communication). In Europe, *Halosalda lateralis* and *Saldula palustris* commonly occur in the same marsh, but the former at high tidal and the latter at mid-tidal zones.

Fresh water invaders are common at the edges of saltmarshes, adding to the complexity, so that of all of the marine biomes inhabited by shore bugs, the saltmarsh exhibits the greatest complexity and diversity. A 'typical' fauna is most difficult to characterize.

### (c) Mangroves

In contrast to the saltmarsh biome, the mangrove biome has the least complicated shore bug fauna as they are almost absent there. The only common seldid inhabitant of mangroves is the ubiquitous *Pentacora sphacelata*. Dover (1929) described a closely related species, *P. malayensis*, from 'pools in mangrove swamp about half a mile from the sea beach'.

### (d) Beaches and dunes

The beaches and dunes also have a depauperate shore bug fauna in comparison with the saltmarshes. The most usual inhabitants are *Pentacora* species, with *P. signoreti* being the most common on the open beaches. Along the sparsely vegetated margins of pools and ponds behind the dunes, *P. sphacelata* is often found and sometimes *Saldula* and *Micracanthia* species occur here also.

## 9.6 DISTRIBUTION

The distributions of intertidal saldids and omaniids are shown in Figs 9.14 and 9.15. Several striking features are immediately apparent: the intertidal saldids are warm adapted, the New World species are all chiloxanthine and restricted to the Pacific coast, and the Old World species (except *Aëpophilus*) all belong to the subfamily Saldinae and their distribution corresponds with the Mesozoic Tethys Sea.

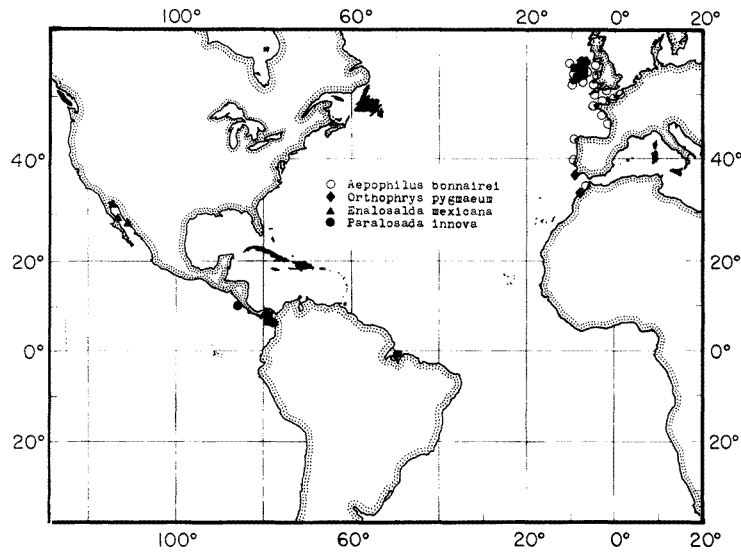

Fig. 9.14. Distribution of American-Atlantic intertidal Saldidae.

Ekman (1953), in his zoogeography of the sea, dwelled at some length on the present marine fauna of the Indio-Pacific, Mediterranean and eastern Atlantic somewhat north and south of Gibraltar being derived from a previous Tethyan fauna, with the changes being largely loss of species rather than new invasions. This hypothesis fits the distribution of the Old World intertidal saldids and omaniids rather well, and leads also to the conclusion that the Saldinae had their early dispersal center in the Old World.

The occurrence of only Chiloxanthinae in the New World, along with the association of *Enalosalda* with a rather ancient mountainous seacoast (50 My), suggests that the center of dispersal of the subfamily Chiloxanthinae was in North America. Within this subfamily, the genus *Pentacora* is only weakly represented outside of North and Central America. *Pentacora sphacelata*, for instance, is evidently a recent arrival in the Gibraltar area of Europe and North Africa, and as yet not widely established (Wagner, 1953; Cobben, 1959). *Chiloxanthus* is typically a European genus, with only two holarctic species reaching arctic

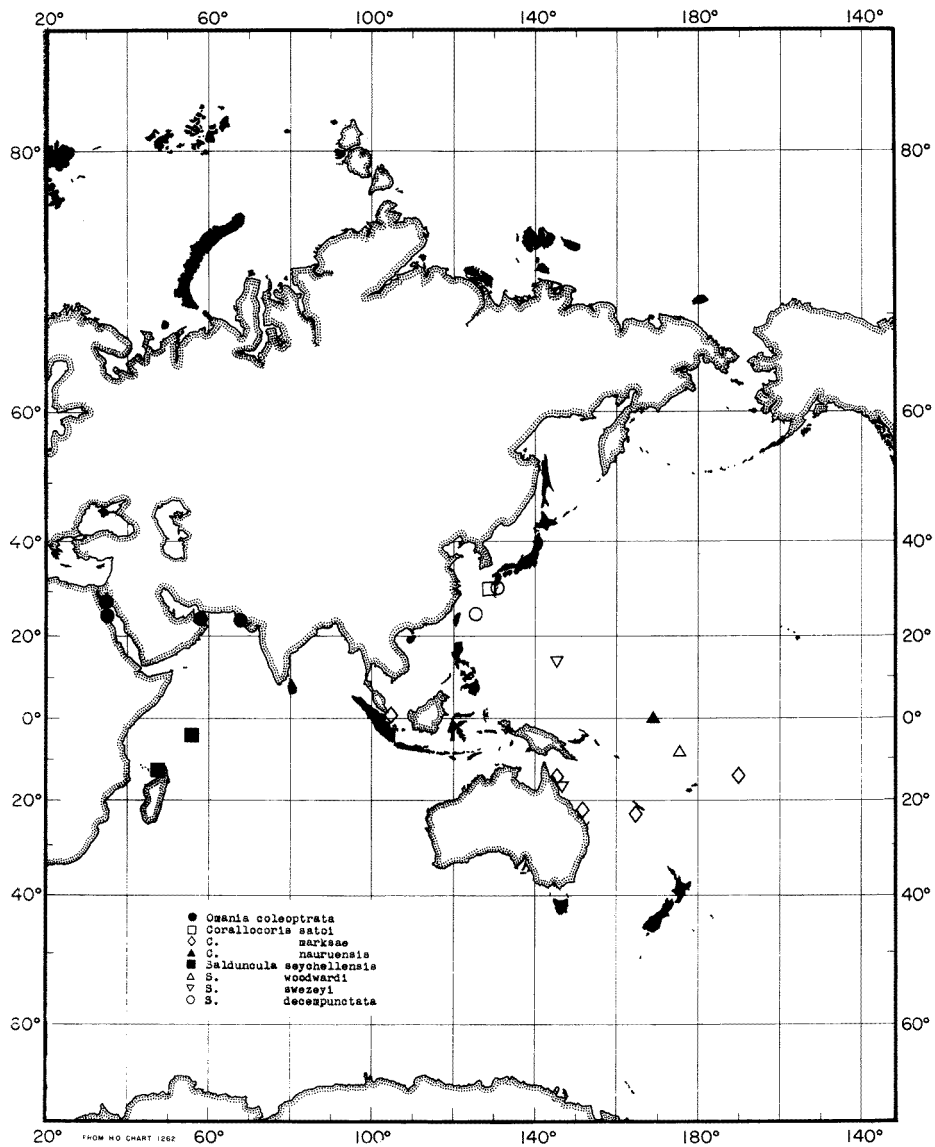

Fig. 9.15. Distribution of Indo-Pacific intertidal Saldidae and Omaniidae.

America, and perhaps derived from the parent Chloxanthine stock before the break up of Pangaea. The European fossil *Oligosaldina*, which was almost certainly a seashore genus (Rott, Germany), would seem to be a relic derived from the *Pentacora* branch that most likely became extinct during the Pleistocene when continental glaciers and colder temperatures rendered its habitat unsuitable, and the east-west mountain ranges of Europe blocked southward migration.

The saltmarsh species are primarily distributed throughout the temperate and arctic regions of the northern hemisphere, and Australia. A few exceptions occur, such as the populations of *Saldula palustris*, along with some *Micracanthia* in the tropical Caribbean. The majority of the species belong to the Saldinae; many of them are euryhaline and many of them are highly dispersive. The unsettled state of the taxonomy of this group and the large proportion of misidentifications in the literature before the 1950s (and since), make it almost impossible to plot the species distributions with any accuracy. Table 9.2 gives the general distribution of the marine shore bugs; widespread species such as *Saldula saltatoria*, *S. pallipes* (Fabricius), *S. opacula* (Zetterstedt), and *Salda littoralis* are euryhaline but commonly found in marshes.

The mangrove biome species, as pointed out previously, are primarily *Pentacora*. The dune and beach species are also largely *Pentacora*, and the distribution of the species of this genus is worldwide, but with very few recorded localities in the Old World. Those Saldinae that occur on beaches usually also occur in the marshes. A notable exception to this is seen in the two *Pseudosaldula* species that occur on beaches in southern South America.

### 9.6.1 Dispersal

The dispersal mechanisms of flightless intertidal saldids are unknown and can only be guessed; rafting or storm transport (Herring, 1958) seem most likely. Omaniids, however, can rapidly colonize a new habitat, for they were found in large numbers on rocks piled up in front of a newly constructed sea wall in Pakistan (Hamid, personal communication). Many intertidal shore bugs are tropical Pacific species, and the distribution patterns and dispersal in this region has been reviewed by Usinger (1963).

The littoral forms are all known to occur in the fully winged form capable of strong flight, although in some saltmarsh species (e.g., *Halosalda lateralis*) flightless forms are predominant. The winged forms of these saldids often fly and have been taken in light traps (Benedek, 1970) as well as on ships anchored offshore (Drake and Viado, 1952; Polhemus, 1968). The evidence for haloarctic dispersal of insects and a review of the dispersal routes has been given by Lindroth (1968). It seems most likely that the primary route of interchange between the Nearctic and Palearctic has been by the Bering Strait, and considerable evidence exists that a substantial exchange of species has taken place across this route (Oman and Krombein, 1968).

In summary, the distribution of marine shore bugs is essentially worldwide, with the rather small but diverse and interesting intertidal fauna occurring in the warmer regions, and a much larger saltmarsh fauna of more generalized species occurring primarily in the temperate and arctic regions of the northern hemisphere, and Australia. The absence of a substantial saltmarsh fauna in the

southern hemisphere stems primarily from a lack of suitable habitats. The paucity of intertidal saldids, most or all of which are archaic, in the Atlantic seems best explained by continental drift, and the relative youth of that ocean, which mostly lacks old stable land masses adjacent to warm seas. A parallel is seen in the distribution of the marine water-striders, which Jaczewski (1972) attributed to continental drift.

## REFERENCES

- Alluaud, C. (1926) Observations sur la faune entomologique intercotidale. Bull. Soc. Zool. Fr. 51, 152–154.
- Arndt, C.H. (1915) Some insects of the between tide zones. Proc. Indiana Acad. Sci. 1914, 323–333.
- Baudoin, R. (1939) Sur l'habitat d'*Aëpophilus bonnairei* Signoret en deux stations des côtes de France. Bull. Soc. Zool. Fr. 64, 18–20.
- Baudoin, R. (1955) La physico-chimie des surfaces dans la vies des arthropodes aeriens, des miroirs d'eau, des rivages marins et la zone intercotidale. Bull. Biol. Fr. Belg. 89, 16–164.
- Benedek, P. (1968) Notes on *Saldula* Van Duzee, 1914, in the Carpathian Basin (Heteroptera, Saldidae). Ann. Hist. Nat. Mus. Natl. Hung. 60, 147–148.
- Benedek, P. (1970) The semiaquatic heteroptera in the Carpathian Basin with notes on the distribution and the phenology of the species. Faun. Abh. 3, 27–49.
- Bergroth, E. (1893) On two halophilous Hemiptera. Entomol. Mon. Mag., 29, 277–279.
- Bergroth, E. (1899) Note on the genus *Aepophilus*, Sign. Entomol. Mon. Mag., 2nd series, 10, 282–283.
- Blanchard, E. (1848) Type designation: *Cimex littoralis* L. as type of *Salda*. In: Dictionnaire Universel d'Histoire Naturelle (A.D. d'Orbigny, Ed.) , 11, 313.
- Blatchley, W.S. (1926) Heteroptera or True Bugs of Eastern North America. ( ) 1116 pp.
- Blatchley, W.S. (1928) Notes on the Heteroptera of Eastern North America with descriptions of new species -I. J. N.Y. Entomol. Soc. 36, 1–23.
- Blöte, H.C. 1947 (1945) Two new saldids from Celebes. Tijdschr. Entomol. 88, 547–548.
- Brown, E.S. (1943) A contribution towards an ecological survey of the aquatic and semi-aquatic Hemiptera-Heteroptera (water bugs) of the British Isles. Trans. Soc. Br. Entomol. 8, 169–230.
- Brown, E.S. (1948) The ecology of Saldidae (Hemiptera-Heteroptera) inhabiting a salt marsh, with observations on the evolution of aquatic habits in insects. J. Anim. Ecol. 17, 180–188.
- Brown, E.S. (1954) A new genus and species of Saldidae (Hemiptera-Heteroptera) from the Seychelles. Ann. Mag. Nat. Hist. (12) 7, 854–856.
- Brown, E.S. (1959) *Salduncula*, an intertidal saldid in Madagascar (Hemiptera). Le Naturaliste Malgache. 11 (2) 73–76.
- Bobb, M.L. (1951) Life history of *Ochterus banksi* Barber (Hemiptera: Ochteridae) Bull. Brooklyn Entomol. Soc. 46 (4) 92–100.
- Butler, E.A. (1923) A Biology of the British Hemiptera-Heteroptera. ( ) 696 pp.
- Champion, G.C. (1897–1901) Insecta, Rhynchota. Hemiptera-Heteroptera, yol. II. In: Biologia Centrali-Americana. xvi + 416 pp., pls. 1–22, 34–39.
- Chapman, H.C. (1958) Notes on the identity, habitat and distribution of some semi-aquatic Hemiptera of Florida. Florida Entomol. 41 (3) 117–124.
- Chapman, H.C. (1959) Distributional and ecological records for some aquatic and semi-aquatic Heteroptera of New Jersey. Bull. Brooklyn Entomol. Soc. 54 (1) 8–12.



- Chapman, H.C. (1962) The Saldidae of Nevada (Hemiptera). *Pan-Pac. Entomol.* 38 (3) 147–159.
- Chapman, V.J. (1960) *Salt Marshes and Salt Deserts of the World.* ( ) 392 pp.
- Cheng, L. (1967) Studies on the biology of the Gerridae (Hemiptera, Heteroptera). I. Observations on the feeding of *Limnogonus fossarum* (F.). *Entomol. Mon. Mag.* 102, 121–129.
- China, W.E. (1927) *Notes on the biology of Aëpophilus bonnairei* Sign. *Entomol. Mon. Mag.* 63, 238–241.
- China, W.E. (1938) A new genus and species of Acanthiidae (Saldidae) from the Sinai Peninsula. *Mem. Inst. Egypte, Cairo.* 37, 255–258.
- China, W.E. (1955) The evolution of the water bugs. *Symposium on Organic Evolution, Bull. Nat. Inst. Sci. India* 7, 91–103.
- China, W.E. (1962) Hemiptera-Heteroptera collected by the Royal Society Expedition to South Chile 1958–1959. *Ann. Mag. Nat. Hist.* 13 (5) 705–723.
- Cobben, R.H. (1957) Beitrag zur Kenntnis der Uferwanzen (Hemiptera, Heteroptera Fam. Saldidae). *Entomol. Ber., Amst.* 17, 245–257.
- Cobben, R.H. (1959) Notes on the classification of Saldidae with the description of a new species from Spain. *Zool. Meded., Leiden* 36, 303–316.
- Cobben, R.H. (1960a) Die Uferwanzen Europas Hemiptera Heteroptera Saldidae. In: Wolfgang Stichel, *Illustrierte Bestimmungstabellen der Wanzen II. Europa.* 3, 209–263.
- Cobben, R.H. (1960b) The Heteroptera of the Netherlands Antilles. III. Saldidae. *Studies on the Fauna of Curacao and Other Caribbean Islands*, 11, 44–61.
- Cobben, R.H. (1961) A new genus and four new species of Saldidae (Heteroptera). *Entomol. Ber., Amst.* 21, 96–107.
- Cobben, R.H. (1965) The functional morphology of the lepto-podoid phallus: a case of rectilinear evolution in Saldidae (Hemiptera-Heteroptera). *Proc. XII Int. Congr. Entomol. 1964 (1965): Section 2: Morphology, etc.:* 162–163.
- Cobben, R.H. (1968) *Evolutionary Trends in Heteroptera, Part I. Eggs, Architecture of the Shell, Gross Embryology and Eclosion.* ( ) 475 pp.
- Cobben, R.H. (1970) Morphology and taxonomy of intertidal dwarf-bugs (Heteroptera: Omaniidae Fam. Nov.). *Tijdschr. Entomol.* 113 (2) 61–90.
- Cobben, R.H. (1971) A fossil shore bug from the tertiary amber of Chiapas, Mexico (Heteroptera, Saldidae). *Univ. Calif. Publ. Entomol.* 63, 49–56. In: (Petrunkevitch, A., Ed.) *Studies of Fossiliferous Amber Arthropods of Chiapas, Mexico*, pt. 2.
- DeCarlo, J.A. (1959) Hemipteros cryptocerata. Efectos de sus picaduras. *Prim. J. Entomoepid. Arg., Sextas Ses. Cient.* 715–719.
- Dethier, M. (1974) Les Saldoidea de la collection Cerutti. *Bull. Soc. Entomol. Suisse*, 47 (1–2) 97–107.
- Douglas, J.W. (1874) British Hemiptera - additional species. *Entomol. Mon. Mag.* 11, 9–12, 142–144.
- Dover, C. (1929) *Papers on Malay aquatic biology*, 8. On Saldidae (Hemiptera) in the Malay Peninsula. *J. Fed. Malay States Mus.* 14 (3/4) 398.
- Drake, C.J. (1949a) Some American Saldidae (Hemiptera). *Psyche* 56 (4) 187–193.
- Drake, C.J. (1949b) Concerning North American Saldidae (Hemiptera). *Ark. Zool.* 42B (3) 1–4.
- Drake, C.J. (1950) Concerning North American Saldidae (Hemiptera). *Bull. Brooklyn Entomol. Soc.* 45 (1) 1–7.
- Drake, C.J. (1952) Alaskan Saldidae. *Proc. Entomol. Soc. Wash.*, 54 (3) 145–148.
- Drake, C.J. (1955) Two new species of shore-bugs (Hemiptera: Saldidae: Leptopodidae). *Proc. Biol. Soc. Wash.* 68, 109–112.
- Drake, C.J. (1957) A new saldid from Samoa (Hemiptera). *Proc. R. Soc. Queensl.* 68 (6) 29–30.
- Drake, C.J. (1958) An unrecorded saldid from Portugal (Hemiptera: Saldidae). *Rev. Fac. Cienc. Lisboa*, 2<sup>a</sup> serie-C, 6 (2) 145–148.

- Drake, C.J. (1961) Insects of Micronesia. Hemiptera: Saldidae. Insects of Micronesia, (, ) 7 (6) 287–305.
- Drake, C.J. (1962) Synonymic data and two new genera of shore-bugs (Hemiptera: Saldidae). Proc. Biol. Soc. Wash. 75, 115–124.
- Drake, C.J. and Chapman, H.C. (1952) A new species of *Micracanthia* from Florida (Hemiptera: Saldidae). Florida Entomol. 35 (4) 147–150.
- Drake, C.J. and Hoberlandt, L. (1950) Catalogue of genera and species of Saldidae (Hemiptera). Acta Entomol. Mus. Nat. Prague 26 (376) 1–12.
- Drake, C.J. and Hottes, F.C. (1950) Saldidae of the Americas (Hemiptera). Great Basin Nat., 10 (1–4) 51–61.
- Drake, C.J. and Hottes, F.C. (1951) Stridulatory organs in Saldidae (Hemiptera). Great Basin Nat., 11 (1–2) 43–47.
- Drake, C.J. and Hottes, F.C. (1955) Concerning Saldidae (Hemiptera) of the western hemisphere. Biol. Entomol. Venezolana 11 (1–2) 1–12.
- Drake, C.J. and Viado, G.B. (1952) Saldoidea of the Philippines (Hemiptera). Philippine J. Sci. 80 (3) 339–342.
- Durham, J.W. and Allison, E.C. (1960) The geologic history of Baja California and its marine faunas. Syst. Zool. 9 (2) 47–91.
- Ekblom, T. (1926) Morphological and biological studies of the Swedish families of Hemiptera-Heteroptera, Part I. The families Saldidae, Nabidae, Lygaeidae, Hydrometridae, Veliidae and Gerridae. Zool. Bidr. Uppsala 10, 31–179.
- Ekman, S. (1953) Zoogeography of the Sea. (, ) 417 pp.
- Evans, W.G. (1968) Some intertidal insects from western Mexico. Pan-Pac. Entomol. 44 (3) 236–241.
- Fabricius, J.C. (1803) Systema Rhyngotorum Secundum Ordines, Genera, Species Adjectis, Locis, Observationibus, Descriptionibus. () 314 pp.
- Glynn-Williams, J. and Hobart, J. (1952) Studies on the crevice fauna of a selected shore in Anglesey. Proc. Zool. Soc. Lond. 122, 797–824.
- Hemming, F. and Noakes, D. (1958) Official index of rejected and invalid generic names in zoology. Int. Trust Zool. Nomencl., Lond., pp. 93–94.
- Herring, J.L. (1958) Evidence for hurricane transport and dispersal of aquatic Hemiptera. Pan-Pac. Entomol. 34 (3) 174–175.
- Herring, J.L. and Chapman, H.C. (1967) A new species of *Omania* from Micronesia (Hemiptera: Saldidae). Proc. Entomol. Soc. Wash., 69 (4) 354–359.
- Hinton, H.E. (1969) Respiratory systems of insect egg shells. Annu. Rev. Entomol. 14, 343–368.
- Hoberlandt, L. (1971) Results of the zoological explorations by Dr. Z. Kaszab in Mongolia. 191. Heteroptera (2): Saldidae. Acta Faun. Entomol. Mus. Nat., Prague 14 (165) 143–152.
- Hodgden, B.B. (1949a) A Monograph of the Saldidae of North and Central America and the West Indies. (PhD Dissertation, Univ. Kansas, Lawrence) 511 pp.
- Hodgden, B.B. (1949b) New Saldidae from the western Hemisphere (Hemiptera). J. Kans. Entomol. Soc. 22 (4) 149–165.
- Horvath, G. (1911) Miscellanea Hemipterologica I-V. Ann. Mus. Nat. Hung. 9, 327–338, 1 pl.
- Horvath, G. (1915) Novus genus peculiare Acanthiidarum. Ann. Mus. Nat. Hung. 13, 598–599.
- Hungerford, H.B. (1920) The biology and ecology of aquatic and semi-aquatic Hemiptera. Univ. Kans. Sci. Bull. 11, 1–328, pls. 1–30.
- Hungerford, H.B. (1922) Life history of the toad bug (Heteroptera). Univ. Kans. Sci. Bull. 14, 143–171, 2 pls.
- Hussey, R.F. (1934) Observations on *Pachycoris torridus* (Scop.) with remarks on parental care in other Hemiptera. Bull. Brooklyn Entomol. Soc., 29 (4) 133–145.
- Jaczewski, T. (1972) Geographical distribution of oceanic Heteroptera and the continental drift. Bull. Acad. Pol. Sci., Ser. Sci. Biol. (2), 20 (6) 415–417.

- Jordan, K.H.C. and Wendt, A. (1938) Zur Biologie von *Salda littoralis* L. (Hemiptera, Heteroptera). Stettin. Entomol. Ztg. 99, 273–292.
- Kellen, W.R. (1959) Notes on the biology of *Halovelvia marianarum* Usinger in Samoa (Veliidae: Heteroptera). Ann. Entomol. Soc. Am. 52 (1) 53–62.
- Kellen, W.R. (1960) A new species of *Omania* from Samoa, with notes on its biology (Heteroptera: Saldidae). Ann. Entomol. Soc. Am. 53 (4) 494–499.
- Keys, J.H. (1890) *Aëpophilus bonnairei*. Entomol. Mon. Mag. 26, 247.
- Keys, J.H. (1895) Some remarks on the habits of *Aëpophilus bonnairei* Sign. Entomol. Mon. Mag. 31, 135–137.
- Keys, J.H. (1914) Some further remarks on *Aëpophilus bonnairei* Sign. Entomol. Mon. Mag. 50, 284–285.
- Kevan, D.K.M. (1942) Some observations on *Mononyx nepaeformis* (Fabricius). Proc. R. Entomol. Soc. Lond. (A) 17 (10–12) 109–110.
- King, P.E. and Ratcliffe, N.A. (1970) The surface structure of the cuticle of an intertidal hemipteran. *Aëpophilus bonnairei* (Signoret). Entomol. Mon. Mag. 106 (1268–70) 1–2, illus.
- Laird, M. (1956) Studies of mosquitoes and freshwater ecology in the South Pacific. Bull. R. Soc. N. Z. 6, , 213 pp.
- Lane, R.S. and Gustafson, J.F. (1969) Salt marsh insects (note). Pan-Pac. Entomol. 45 (1) 78–79.
- Lattin, J.D. and Cobben, R.H. (1968) The systematic position of *Orthophrys mexicanum* Van Duzee (Hemiptera Heteroptera: Saldidae). Entomol. Ber., Amst. 28, 130–135.
- Leston, D. (1956) Systematics of the marine-bug. Nature 178, 427–428.
- Leston, D. (1957) The stridulatory mechanisms in terrestrial species of Hemiptera-Heteroptera. Proc. Zool. Soc. Lond. 128 (3) 369–386.
- Lethierry, L. and Severin, G. (1896) Catalogue Général des Hémiptères. Vol. 3, () 275 pp.
- Lienhart, R. (1913) *Habitat et Géonémie d' Aëpophilus bonnairei* Signoret. Ann. Sci. Nat. Zool. (9) 17, 257–268.
- Lindberg, H. (1936) Halophile und halobionte Hemiptera. In: Der Tierwelt der Nord- und Ostsee. (Grimpe, G., Ed.) . Teil Xle4, , 30, 103–124.
- Lindberg, H. (1948) Zur Kenntnis der Insekten Fauna im Brackwasser des Baltischen Meeres. Soc. Sci. Fenn., Commentat. Biol. 10 (9) 3–206.
- Lindberg, H. (1958) Hemiptera Heteroptera from Newfoundland collected by the Swedish-Finnish Expedition of 1949 and 1951. Acta Zool. Fenn. 96, 1–25.
- Lindroth, C.H. (1968) Distribution and distributional centers of North Atlantic insects. Bull. Entomol. Soc. Am. 14 (2) 91–95.
- Lindskog, P. (1968) The relations between transpiration, humidity reaction, thirst and water content in the shorebug *Saldula saltatoria* L. (Heteroptera: Saldidae). Ark. Zool., series 2, 20 (20) 465–493.
- Lindskog, P. (1974) Distributional and systematic notes on *Saldula fucicola* (J. Sahlb.) and some other shore bugs of Eastern Fennoscandia (Heteroptera, Saldidae). Not. Entomol. 54, 33–56.
- Linnaeus, C. (1758) Systemae Naturae. 10th edn., vol. I, () 824 pp.
- Linnavouri, R. (1953) Hemipterological studies. I. *Chiloxanthus arcticus* J. Sahlb. (Het.-Saldidae) a valid species. Ann. Entomol. Fenn. 19 (3) 107.
- Linnavouri, R. (1964) Hemiptera of Egypt, with remarks on some species of the adjacent Eremian region. Ann. Zool. Fenn. 1, 306–356.
- Mason, J.E. (1889) Aquatic habits of *Salda*. Entomol. Mon. Mag. 25, 236–237.
- McDunnough, J. (1925) Notes on *Saldula obscura* Prov. with description of a new species (Hemiptera). Can. Entomol. 57, 257–260.
- Miall, L.C. (1895) The Natural History of Aquatic Insects. (, ) 395 pp.
- Miyamoto, S. (1955) On a special mode of locomotion utilizing surface tension at the water-edge in some semi-aquatic insects. Kontyû (Tokyo), 23, 45–52.

- Miyamoto, S. (1963) New halophilous saldids from the Tokara Islands. *Sieboldia* 3 (1) 39–50.
- Miyamoto, S. (1964) Semi-aquatic Heteroptera of the South-West Islands, lying between Kyushu and Formosa. *Sieboldia* 3 (2) 193–219.
- Morton, J.E. (1954) The crevice faunas of the upper intertidal zone at Wembury. *J. Mar. Biol. Assoc. U.K.* 33, 187–224.
- Oman, P. and Krombein, K.V. (1968) Systematic entomology: distribution of insects in the Pacific. *Science* 161, 78–79.
- Paulian, R. (1959) A zoological survey of Madagascar. *Nature* 184, 1387–1388.
- Picado, C. (1937) Estudio experimental sobre o veneno de *Lethocerus delpontei* DeCarlo. *Mem. Inst. Butantan* 10, 303–310.
- Picado, C. (1939) Étude expérimentale du venin de *Lethocerus delpontei* DeCarlo. *Trav. Stn. Zool. Wimereux* 13, 553–562.
- Poisson, R. and Poisson, A. (1943) Sur la synonymie de *Dolfusella minutissima* China 1938 et *Omania coleoprata* Horváth 1915 (Hem. Acanthiidae). *Bull. Soc. Entomol. France* 48, 123.
- Polhemus, J.T. (1967) Notes on North American Saldidae (Hemiptera). *Proc. Entomol. Soc. Wash.* 69 (1) 24–30.
- Polhemus, J.T. (1968) A report on the Saldidae collected by the Galapagos International Scientific Project 1964 (Hemiptera). *Proc. Entomol. Soc. Wash.* 70 (1) 21–24.
- Polhemus, J.T. (1972a) Notes on the genus *Nerthra*, including the description of two new species (Hemiptera: Gelastocoridae). *Proc. Entomol. Soc. Wash.* 74 (3) 306–309.
- Polhemus, J.T. (1972b) Notes concerning Mexican Saldidae, including the description of two new species (Hemiptera). *Great Basin Nat.* 32 (3) 137–153.
- Polhemus, J.T. and Chapman, H.C. (in press) Saldidae. In: *The Semi-aquatic and Aquatic Hemiptera of California*. (A.S. Menke, Ed.) *Bull. Calif. Insect. Surv.* (, ).
- Polhemus, J.T. and Evans, W.G. (1969) A new genus of intertidal Saldidae from the Eastern Tropical Pacific with notes on its biology (Hemiptera). *Pac. Insects* 11 (3–4) 571–578.
- Popov, Y.A. (1971) Historical development of Hemiptera infraorder Nepomorpha (Heteroptera). *Trudy Paleont. Inst., Acad. Sci. USSR* 129, 1–230. (In Russian).
- Popov, Y.A. (1973) First discovery of an Hemiptera of the family Saldidae (Heteroptera) in the Mesozoic of Siberia. *Rep. Acad. Sci. USSR* 209 (3) 703–705 (in Russian).
- Ray, J. (1710) *Historia Insectorum*. () 398 pp.
- Renouf, L.P.W. (1932) Some air-breathing arthropods of the littoral region of the coast of County Cork, I.F.S. *Ann. Mag. Nat. Hist.* 10 (10) 262–267.
- Reuter, O.M. (1884) Entomologiska meddelanden från Societas pro Fauna et Flora Fennica sammanträden åren 1882 och 1883. *Entomol. Tidskr* 5, 163–171.
- Reuter, O.M. (1891) De Skandinaviskt-Finska *Acanthia* (*Salda*) Arterna af *saltatoria* - Gruppen. *Medd. Soc. Fauna Flora Fenn.* 17, 144–160.
- Reuter, O.M. (1895) Species Palaearcticae generis *Acanthia* Fabr., Latr. *Acta Soc. Sci. Fenn.* 21 (2) 1–58, 1 pl.
- Reuter, O.M. (1900) Quelques Hémiptères du Maroc. *Bull. Soc. Entomol. France* 1900, 186–189.
- Reuter, O.M. (1912) Zur generischen Teilung der paläarktischen und nearktischen Acanthiaden. *Ofv. Finska Vet.-Soc. Forh.* 54 (Afd. A, 12) 1–24.
- Rimes, G.D. (1951) Some new and little-known shore-bugs (Heteroptera-Saldidae) from the Australian region. *Trans. R. Soc. S. Aust.* 74 (2) 135–145, 2 pls.
- Sahlberg, J. (1920) *Enumeratio Hemipterorum Heteropterorum faunae Fennicae. Editio secunda aucta et emendata. Bidr. Känn. Finlands Nat. Folk.* 79 (2) 1–227.
- Saunders, E. (1892) *The Hemiptera-Heteroptera of the British Islands*. (, ) 350 pp.
- Schell, D.V. (1943) The Ochteridae (Hemiptera) of the Western Hemisphere. *J. Kans. Entomol. Soc.* 16 (1–2) 29–47.

- Schuh, T. (1967) The shore bugs (Hemiptera: Saldidae) of the Great Lakes region. *Contr. Am. Entomol. Inst.* 2 (2) 1–35.
- Schuster, R. (1965) Faunistische studien am Roten Meer (im winter 1961/62). *Zool. Jb. Syst.* 92, 327–343.
- Signoret, M. (1879) Genre *Aëpophilus*. Sig. In: *Synopsis des Hemipteres-Heteropteres de France 2<sup>e</sup> partie*. Tingides, Phymatides, Aradides, Hebrides, Hydrometrides. (Puton, A., Ed.) pp. 144–146, .
- Southwood, T.R.E. and Leston, D. (1959) *Land and Waterbugs of the British Isles*. ( . ) 436 pp.
- Stål, C. (1868) *Synopsis Saldarum Sueciae*. *Ofv. Svenska Vet.-Ak. Förh.*, 25 (6) 387–393.
- Stål, C. (1873) *Enumeratio Hemipterorum, Enumeratio Acanthiidarum Extraeuropaeorum*. *Fam. Acanthiidae Stål*. *K. Sv. Vet. Akad. Handl.*, 11 (2) 148–149.
- Statz, G. and Wagner, E. (1950) Geocorisae (Landwanzen) aus den oberoligocänen Ablagerungen von Rott. *Palaeontographica, Abt. A.*, 98 (5–6) 97–136.
- Stock, M.W. (1972) *Biological studies on Saldula palustris (Douglas) with emphasis on factors influencing wing pigmentation*. (Ph.D. Dissertation, ) 172 pp.
- Stuart, L.C. (1966) The environment of the Central American cold-blooded vertebrate fauna. *Copeia* 1966 (4) 684–689.
- Stys, P. and Kerzhner, I. (1975) *Acta Entomol. Bohem.* 72, 71.
- Thorpe, W.H. (1950) Plastron respiration in aquatic insects. *Biol. Rev.* 25, 344–390.
- Todd, E.L. (1955) A taxonomic revision of the family Gelastocoridae (Hemiptera). *Univ. Kans. Sci. Bull.* 37 (Pt.1,11) 277–475.
- Todd, E.L. (1959) Results of the Archbold Expeditions. The Gelastocoridae of Melanesia (Hemiptera). *Nova Guinea, new ser.*, 10 (1) 61–94.
- Todd, E.L. (1960) Notes on *Nerthra macrothorax* (Montrouzier). *Proc. Entomol. Soc. Wash.*, 62 (2) 116.
- Todd, E.L. (1965) A note on the occurrence of *Nerthra rugosa* (Desj.) in Brazil. *Proc. Entomol. Soc. Wash.*, 67 (2) 111.
- Torre-Bueno, J.R. de la (1923) Aquatic and semi-aquatic Hemiptera (except Corixidae) and Reduviidae. In: *Guide to the Insects of Connecticut. Part IV. The Hemiptera or sucking insects of Connecticut*. (Britton, W.E., Ed.) *Conn. State Geol. Nat. Hist. Surv. Bull.* 34, pp. 391–665, 674–692.
- Torres, B.A. (1954) Una nueva especie de Saldido de Tierra del Fuego (Hemiptera-Saldidae). *Univ. Nac. Eva Peron, Notas del Museo*, 17 (149) 87–93.
- Uhler, P.R. (1877) Report upon the insects collected by P.R. Uhler during the explorations of 1875, including the monographs of the families Cydnidae and Saldae, and the Hemiptera collected by A.S. Packard, Jr., M.D. *Bull. U.S. Geol. Geog. Surv.* 3, 355–475.
- Uhler, P.R. (1884) Order IV. Hemiptera. In: *Standard Natural History, II*. (J.S. Kingsley, Ed.) ( ) pp. 204–296.
- Usinger, R.L. (1946) Heteroptera of Guam. In: *Insects of Guam-II*. Bernice P. Bishop Museum, *Bull.* 189, 11–103.
- Usinger, R.L. (1956) *Aquatic Insects of California, with Keys to North American Genera and California Species*. ( . ) 508 pp.
- Usinger, R.L. (1960) Observations on the biology of *Chiloxanthus stellatus* (Curtis) and *C. arcticus* (Sahlberg). *Pan-Pac. Entomol.* 36 (4) 189–190.
- Usinger, R.L. (1963) Animal distribution patterns in the Tropical Pacific. *Pac. Basin Biogeogr. Symp.*, Tenth Pac. Sci. Congr., Honolulu 1961. pp. 255–261.
- Van Duzee, E.P. (1914) Nomenclatural and critical notes on Hemiptera. *Can. Entomol.*, 46 (11) 377–389.
- Van Duzee, E.P. (1923) Expedition of the California Academy of Sciences to the Gulf of California in 1921. XI. The Hemiptera (true bugs, etc.) *Proc. Calif. Acad. Sci.*, fourth series, 12 (11) 123–200.

- Vinson, S.B. (1968) Source of a substance in *Heliothis virescens* (Lepidoptera: Noctuidae) that elicits a searching response in its habitual parasite *Cardiochiles nigriceps* (Hymenoptera: Braconidae). *Ann. Entomol. Soc. Am.* 61, 8–10.
- Wagner, E. (1950) Notes on Saldidae. *Acta Entomol. Mus. Nat. Pragae*, 26 (371) 1–4.
- Wagner, E. (1953) *Pentacora iberica* n.sp., eine neue Spanische Saldidenart (Hemipt. Heteropt.). *EOS* 29(2–4) 281–282.
- Wiley, G.O. (1922) Life history notes on two species of Saldidae (Heteroptera). *Univ. Kans. Sci. Bull.* 14 (9) 301–311.
- Wilson, T. et al. (1971) Continents adrift. Readings from *Scientific American* (, ) 172 pp.
- Wollaston, G.H.B. (1942) *Aëpophilus bonnairei* Sign. (Hem.-Aëpophilidae) in North Devon. *Entomol. Mon. Mag.* 78, 204.
- Woodward, T.E. (1958) A remarkable new intertidal saldid. *Univ. Queensl. Pap., Entomol.* 1, 101–110.
- Wroblewski, A. (1966) Shorebugs (Heteroptera, Saldidae) of Poland. *Bull. Entomol. Pol.* 36 (12) 220–302.

## Water-boatmen of saline waters (Hemiptera: Corixidae)

Geoffrey G.E. Scudder

<b>Contents</b>		
10.1	Introduction	263
10.2	Systematics	265
	10.2.1 Synopsis	265
	10.2.2 Marine members	265
	10.2.3 General morphology - Key to genera	268
10.3	Biology	272
	10.3.1 Life history, reproduction, seasonality	272
	10.3.2 Food	273
	10.3.3 Predators	274
	10.3.4 Parasites and symbionts	275
10.4	Ecology	276
	10.4.1 Special adaptations	276
	10.4.2 Range of habitat and distribution	279
	10.4.3 Population dynamics	282
10.5	Conclusion	282
	Acknowledgements	283
	References	283

### 10.1 INTRODUCTION

Water-boatmen of the family Corixidae are reported to be typically freshwater insects in most entomological textbooks and they certainly are common in freshwater. However, it is in the coastal and inland saline environments that the family becomes very conspicuous and it is found abundantly in many parts of

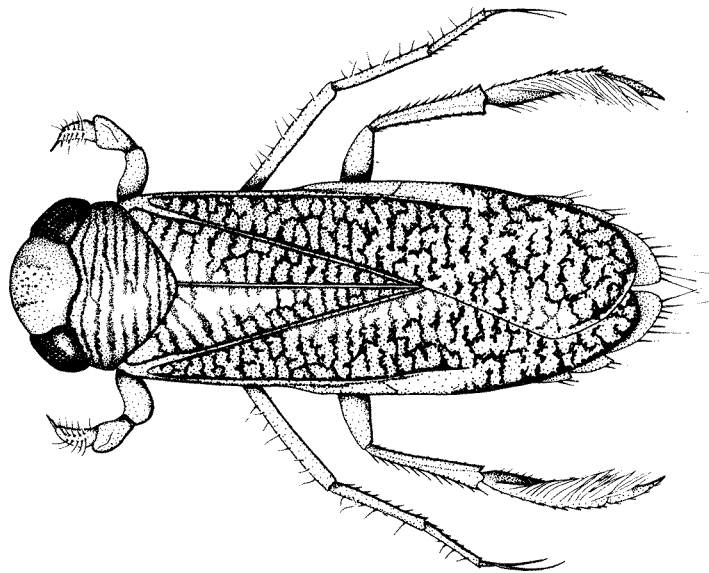
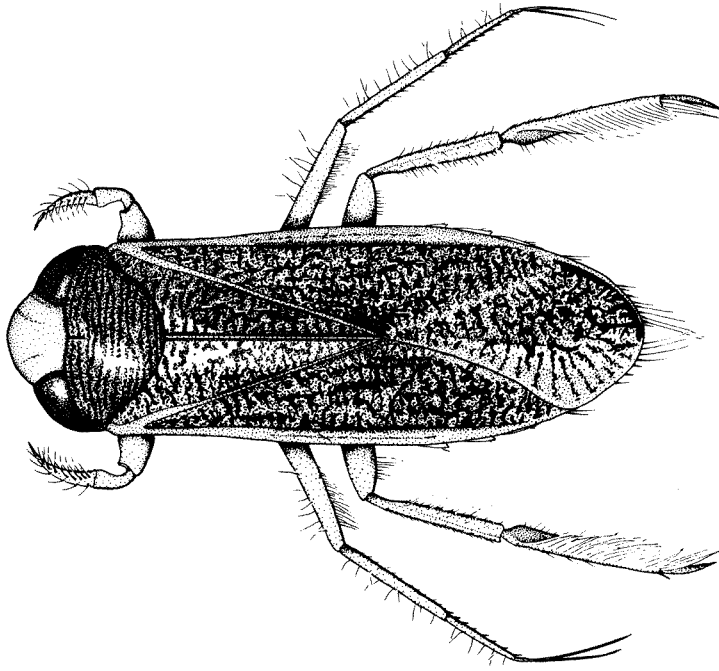

Fig. 10.1. (Left) *Cenocorixa expleta* (Uhler) adult, dorsal view. Scale line = 2.00 mm.

Fig. 10.2. (Right) *Trichocorixa verticalis* (Fieber) adult, dorsal view. Scale line = 2.00 mm.



the world. In spite of this abundance, it is only recently that the saline species have been studied in any detail.

Since all known species of marine and inland saline Corixidae belong to familiar freshwater genera, much of the information on the general biology of freshwater forms probably also applies to those of saline habitats.

## 10.2 SYSTEMATICS

### 10.2.1 Synopsis

Typical examples of adult water-boatmen are illustrated in Figs 10.1 and 10.2. They are oval-shaped, streamlined fully aquatic Hemiptera with short antennae hidden from above; they do not normally swim upside-down like the Notonectidae. Body usually dark above, often mottled or cross-banded with yellow, brown or black on the pronotum and leathery hemelytra. Rostrum short, triangular and broadly attached to head. Forelegs short, armed terminally with a flattened, scoop-like pala, fringed ventrally with stiff bristles; middle legs long and slender with two tarsal claws; hind legs long and flattened and fringed with hairs.

### 10.2.2 Marine members

Twelve genera of Corixidae have been recorded from saline waters. All known saline species together with their distribution are given in Table 10.1. In this study, only genera which occur in water with a salinity of over 3‰ are considered.

Table 10.1 Records of occurrences of Corixidae in saline waters

Subfamily CYMATINAE	
Genus <i>Cymatia</i> Flor	
1. <i>C. americana</i> Hussey	Saskatchewan (Swanson, 1975)
2. <i>C. bonsdorffi</i> (Sahlberg)	Baltic (Lindberg, 1948)
3. <i>C. coleoptera</i> (Fabricius)	Baltic (Lindberg, 1948)
4. <i>C. rogenhoferi</i> (Fieber)	Europe (Hoberlandt, 1948; Josifov, 1961; Karg, 1966)
Subfamily MICRONECTINAE	
Genus <i>Micronecta</i> Kirkaldy	
1. <i>M. annae</i> Kirkaldy	Australia (Knowles & Williams, 1973)
2. <i>M. gracilis</i> Hale	Australia (Ettershank et al., 1966; Knowles & Williams, 1973)
3. <i>M. jenkinsae</i> Hutchinson	Kenya (Hutchinson, 1932; Jenkin, 1936)
4. <i>M. meridionalis</i> (Costa)	Europe (Josifov, 1961)

5. *M. plicata* (Costa) Suez Canal (Thorpe, 1926)  
 6. *M. robusta* Hale Australia (Knowles & Williams, 1973)  
 7. *M. scutellaris* (Stal) (= *M. proba* Distant) Africa (Hutchinson, 1932; Jenkin, 1936; Hynes, 1955);  
 India (Baid, 1959, 1968); Sri Lanka (Fernando, in  
 litt.)
- Subfamily CORIXINI  
 Tribe GLAENOCORIXINI
- Genus *Dasycorixa* Hungerford  
 1. *D. rawsoni* Hungerford Canada (Brooks & Kelton, 1967; Scudder, 1969b)
- Tribe AGRAPTORIXINI
- Genus *Agraptocorixa* Kirkaldy  
 1. *A. eurynome* (Kirkaldy) Australia (Knowles & Williams, 1973)  
 2. *A. hirtifrons* (Hale) Australia (Knowles & Williams, 1973)  
 3. *Agraptocorixa* as *Porocorixa* sp. near *eurynome*. Australia (Ettershank et al., 1966)
- Tribe CORIXINI
- Genus *Arctocorixa* Wallengren  
 1. *A. carinata* (Sahlberg) Baltic (Lindberg, 1948; Pajunen, 1970b, c; Pajunen &  
 Jansson, 1969a, 1969b)
- Genus *Callicorixa* B. White  
 1. *C. audeni* Hungerford Canada (Scudder, 1965, 1969b; Swanson, 1975)  
 2. *C. praeusta* (Fieber) Europe (Butler & Popham, 1958; Karg, 1966; Savage,  
 1971b)  
 3. *C. producta* (Reuter) Baltic (Lindberg, 1948; Pajunen, 1970b; Pajunen &  
 Jansson, 1969a, b)
- Genus *Cenocorixa* Hungerford  
 1a. *C. bifida bifida* (Hungerford) Canada (Brooks & Kelton, 1967; Swanson, 1975)  
 b. *C. bifida hungerfordi* Lansbury British Columbia, Washington (Scudder, 1965, 1969a,  
 b; Jansson & Scudder, 1974)  
 2. *C. dakotensis* (Hungerford) Canada (Rawson & Moore, 1944; Brooks & Kelton,  
 1967; Swanson, 1975)  
 3. *C. expleta* (Uhler) North America (Edmondson, 1966; Brooks & Kelton,  
 1967; Hammer et al. 1975; Scudder, 1965, 1969a,b;  
 Jansson & Scudder, 1974; Swanson, 1975)  
 South Dakota (Applegate, in litt.)
4. *C. utahensis* (Hungerford)
- Genus *Corisella* Lundblad  
 1. *C. decolor* (Uhler) U.S.A. (Schwarz, 1891; Hungerford, 1948; Usinger,  
 1956)  
 2. *C. inscripta* (Uhler) California (Usinger, 1956)  
 3. *C. tarsalis* (Fieber) Saskatchewan (Swanson, 1975)
- Genus *Corixa* Geoffroy  
 1. *C. affinis* Leach Europe (Butler & Popham, 1958; Banks, 1949;  
 Hoberlandt, 1948; Josifov, 1961; Poisson, 1924;  
 Southwood & Leston, 1959; Stichel, 1955)

2. *C. panzeri* (Fieber)  
 3. *C. punctata* (Illiger)
- Genus *Hesperocorixa* Kirkaldy  
 1. *H. laevigata* (Uhler)  
 2. *H. sahlbergi* (Fieber)
- Genus *Sigara* Fabricius  
 1. *S. assimilis* (Fieber)  
 2. *S. australis* (Fieber)  
 3a. *S. concinna* (Fieber)
- b. *S. concinna amurensis* Jaczewski  
 4. *S. conocephala* Hungerford  
 5. *S. decoratella* Hungerford  
 6. *S. dorsalis* (Leach)  
 7. *S. falleni* (Fieber)
8. *S. gebleri* (Fieber)  
 9. *S. jeistanensis* Distant  
 10a. *S. lateralis lateralis* (Leach)
- b. *S. lateralis kilimandjaronis* (Kirkaldy)  
 11. *S. mayri* (Fieber)  
 12. *S. meridionalis* (Wallengren)  
 13. *S. samani* Hoberlandt  
 \*14. *S. selecta* (Fieber)
15. *S. siberica* Jaczewski  
 \*16. *S. stagnalis* (Leach) (= *S. lugubris* Fieber)
17. *S. striata* (Linnaeus)
18. *S. substriata* Distant  
 19. *S. vehusta* (Douglas & Scott)  
 20. *S. weymarni* Hungerford
- Genus *Trichocorixa* Kirkaldy  
 1. *T. beebei* Sailer  
 2. *T. borealis* Sailer  
 3. *T. louisianae* Jaczewski  
 4. *T. naias* Sailer
- Europe (Hoberlandt, 1948; Sutton, 1947a)  
 Europe (Banks, 1949; Butler & Popham, 1958; Southwood & Leston, 1959)
- British Columbia (Scudder, 1965, 1969b)  
 Europe (Nicol, 1935, 1936; Butler & Popham, 1958)
- Europe (Josifov, 1961); Siberia (Kanyukova, 1973)  
 Australia (Knowles & Williams, 1973)  
 Europe (Banks, 1949; Hoberlandt, 1948; Josifov, 1961; Karg, 1966; Nieser, 1966; Pearce & Walton, 1939; Savage, 1971b); Siberia (Kanyukova, 1973)  
 Mongolia (Jaczewski & Wroblewski, 1975)  
 South Dakota (Applegate, in litt.)  
 Canada (Brooks & Kelton, 1967)  
 England (Popham, 1964; Savage, 1971b)  
 England (Butler & Popham, 1958; Popham, 1964; Savage, 1971b)  
 Mongolia (Jaczewski & Wroblewski, 1975)  
 India (Baid, 1959, 1968)  
 Europe (Banks, 1949; Butler & Popham, 1958; Gessner, 1957; Hoberlandt, 1948; Nieser, 1966; Poisson, 1924; Savage, 1971b)  
 Kenya (Hutchinson, 1932; Jenkin, 1936)  
 Turkey (Hoberlandt, 1948)  
 Africa (Hutchinson, 1929, 1930; Harrison, 1962)  
 Turkey (Hoberlandt, 1948)  
 Europe (Banks, 1949; Butler & Popham, 1958; Green, 1968; Howes, 1939; Nieser, 1966; Southwood & Leston, 1959; Stichel, 1955)  
 Siberia (Kanyukova, 1973)  
 Europe (Banks, 1949; Butler & Popham, 1958; Claus, 1937; Green, 1968; Lindberg, 1948; Pearce & Walton, 1939; Poisson, 1924; Savage, 1971b; Southwood & Leston, 1959; Stichel, 1955)  
 Europe (Banks, 1949; Butler & Popham, 1958; Hoberlandt, 1948; Karg, 1966; Josifov, 1961; Lindberg, 1948; Poisson, 1924; Savage, 1971b)\*\*  
 India (Baid, 1959, 1968)  
 France (Poisson, 1924)  
 Mongolia (Jaczewski & Wroblewski, 1975)
- Galapagos Is. (Howmiller, 1969)  
 Saskatchewan (Tones & Hammer, 1975)  
 U.S.A. (Sailer, 1948; Wilson, 1958)  
 Saskatchewan (Tones & Hammer, 1975)

5. <i>T. reticulata</i> (Guerin-Meneville)	U.S.A. (Barlow, 1958; Carpelan, 1957; Cole, 1968; Davis, 1966; Hutchinson, 1931; Polhemus & Hendrickson, 1974; Sailer, 1948; Usinger, 1956)
6a. <i>T. verticalis californica</i> Sailer	California (Usinger, 1956); Oregon (Jansson, in litt.); British Columbia (Scudder, 1975b)
b. <i>T. verticalis interiores</i> Sailer	Saskatchewan (Rawson & Moore, 1944; Sailer, 1948; Hammer et al., 1975; Tones, 1975; Tones & Hammer, 1975; Swanson, 1975)
c. <i>T. verticalis saltoni</i> Sailer	California (Usinger, 1956)
d. <i>T. verticalis verticalis</i> (Fieber)	U.S.A. (Hutchinson, 1931, 1937; Gunter & Christmas, 1959; Sailer, 1948; Usinger, 1956; Wilson, 1958)
e. <i>T. verticalis verticalis</i> var. <i>sellaris</i> (Abbott)	U.S.A. (Pearse, 1932; Sailer, 1948)

\* Predominantly marine species.

\*\* Some of these records may refer to *S. dorsalis*.

### 10.2.3 General morphology

#### Head

The general morphology of Corixidae is depicted in Figs 10.3–10.7. Briefly, the head is triangular with relatively large compound eyes and short 3- or 4-jointed antennae somewhat hidden beneath the lateral margins (Figs 10.3 and 10.5). The frons is rather flat or concave in the male, usually somewhat convex in the

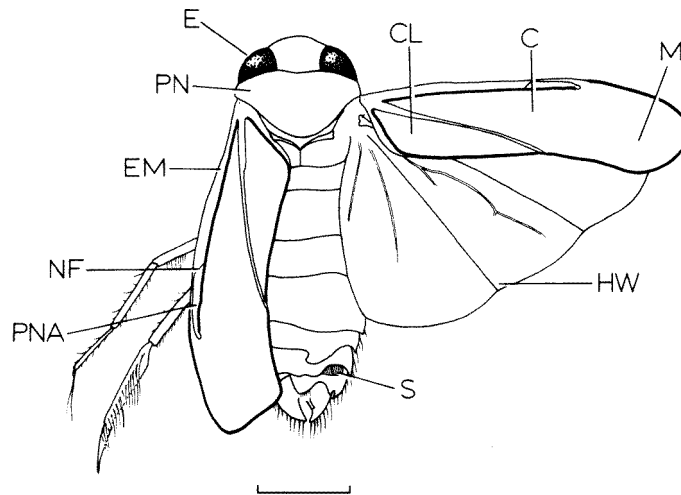
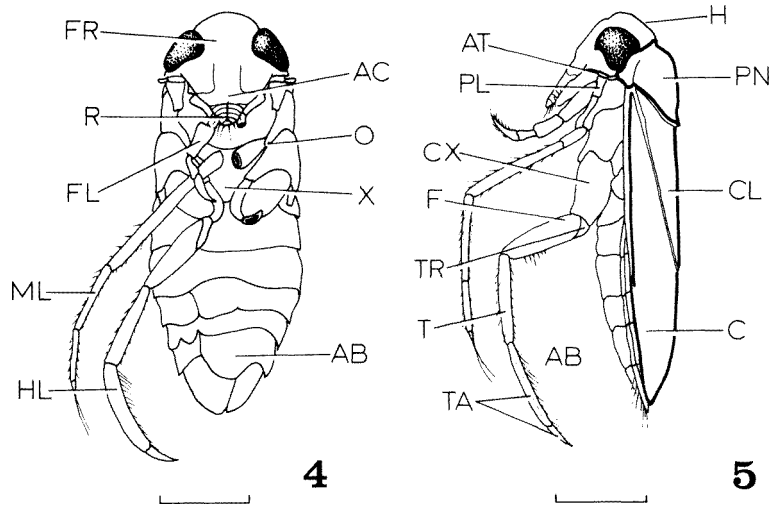
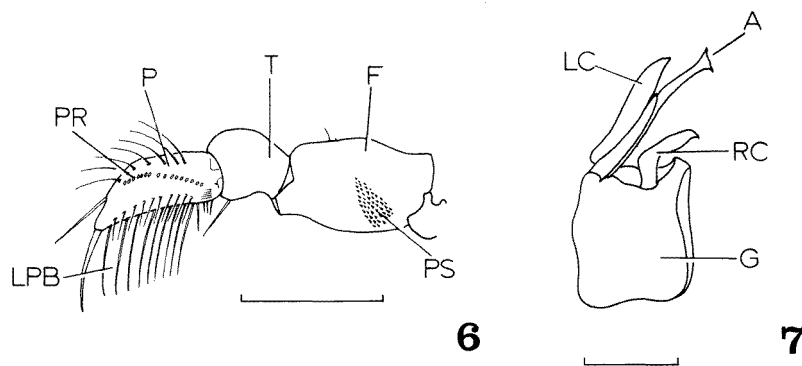

Fig. 10.3. Dorsal view of Corixid adult to show general structure. Scale line = 2.00 mm. C, corium; CL, clavus; E, compound eye; HW, hind wing; EM, embolium; M, membrane; NF, nodal furrow; PN, pronotum; PNA, post-nodal area; S, strigil.



Figs. 10.4 and 10.5. Views of Corixid adult to show general structure; 4, Ventral view; 5, Side view. Scale lines = 2.00 mm. AB, abdomen; AC, anteclypeus; AT, antenna; C, corium; CL, clavus; CX, coxa; F, femur; FL, fore leg; FR, frons; H, head; HL, hind leg; ML, middle leg; O, osteole of scent gland; PN, pronotum; R, rostrum; T, tibia; TA, tarsus; TR, trochanter; X, metaxyphus.



Figs. 10.6 and 10.7. *Cenocorixa expleta*. Adult male parts to show general structure; 6, Anterior view of right fore leg; 7, Genital capsule. Scale lines = 1.00 mm. A, aedeagus; F, femur; G, genital capsule; LC, left clasper; LPB, lower palmar bristles; P, pala; PR, peg row; PS, pars stridens; RC, right clasper; T, tibia.

female, and is continuous with the postclypeus. The rostrum or labium is triangular and not elongate as in most other Heteroptera.

In a number of Corixidae, the edge of the maxillary plate is produced into a sharp edge that constitutes a plectrum for stridulation (Jansson, 1972).

## Thorax

In the nymphs the prothoracic segment is little more than a ring-like support for the forelegs, but in the adults the extensive pronotum overlies much of the dorsal thorax. The variation in coloration, structure and texture of the pronotum is important taxonomically. Functionally, it provides a protective shield for the important air store normally retained beneath it. The prothoracic epimeron, or prothoracic lobe, is variable in shape and useful in identification of genera.

The prothorax is attached to the mesothorax by a flexible ball-and-socket joint, much like that between the head and prothorax. This allows a wide range of movements between the two segments and undoubtedly facilitates locomotion and feeding, as well as respiration, as the most anterior pair of spiracles is located between the lateral membrane of these segments.

The pteronotum is usually hidden by the pronotum and wings when the insect is at rest, except in the Micronectinae, where the mesoscutellum is exposed when the wings are in repose. The only structure of note on the mesothorax is the opening of the scent gland located at the caudo-lateral margin of the mesoepimeron (Fig. 10.4).

## Legs (Figs 10.4 and 10.5)

There is pronounced division of labour in the legs, the forelegs being concerned with feeding and stridulation, the middle legs with clinging, and the hind legs with locomotion (Bueno, 1916; Short, 1953). While this adaptive division of labour may be an oversimplification (Leston, 1955), the different functions are clearly reflected in the different structure of the three pairs of legs.

The fore femur may bear a patch of highly modified stridulatory pegs on the inner face. These form a *pars stridens* and insects stridulate by rubbing them against the sharp edges of the maxillary plate of the head (Jansson, 1972). The fore tarsus is highly modified to form a scoop-like structure called a *pala* which is greatly variable in shape and bears dorsally and ventrally rows of palmar bristles. In the male, the anterior surface of the *pala* bears in addition one or two rows of sclerotized pegs. The shape of the *pala*, the number of palmar bristles and the character of the peg row(s) in the male are important taxonomic characters. It should be noted that the palal pegs in the male Corixid are not concerned with stridulation, although this is often stated to be the case. Popham (1961) found that the pegs were used to clasp the hemelytral ridges of the female in mating.

The mesothoracic legs are elongate and terminate in a pretarsus of two slender claws which are usually used like a pair of tongs to anchor the buoyant insect while away from the water surface or while not swimming. The hind legs are flattened, oar-like and provided with dense rows of hairs. The coxal and coxal-pleural articulation of the hind legs are particularly highly modified to provide locomotive power with all the niceties of 'feathering' necessary in the use of oars

under water (Griffith, 1945). Further, it is obvious that these modifications for life under water, render the legs almost useless for progress on land (Bueno, 1916).

#### Wings

The forewing of Corixidae is a typical hemelytron with corium, clavus and membrane (Fig. 10.3), although the latter is not always easily separated from the corium owing to the patterning being continuous over the two. The costal margin of the forewing forms a groove-like embolium which ends distally in a distinct nodal furrow. If the pruinose costal groove extends beyond this furrow the distal part is then termed the post-nodal area.

#### Abdomen

While the anterior pregenital segments of the abdomen in the male are rather regular in shape, the posterior terga and sterna, especially segments VI and VII, are very variable in outline and structure and provide valuable taxonomic characters. These segments are asymmetrical and turn either to the right (dextral) or to the left (sinistral) when viewed from above, and are usually constant in a genus. However, reversals are known to occur and to be quite frequent in some species (Peters, 1949).

This asymmetry is associated with flexure of the abdomen in the coupling of the sexes during mating and is best indicated by the position of the so-called 'strigil', a structure usually made up of rows of comb-like teeth on the hind margin of tergum VI. It is present in all saline Corixidae, except *Callicorixa*, and is not concerned with stridulation, but seems to serve to grip the female venter in copulation (Larsen, 1938). However, Mitis (1936) suggested that in the Micro-nectinae the strigil might be concerned with producing underwater sounds by rubbing it against the edge of tergum V.

The eighth abdominal segment in the male is divided also into asymmetrical halves as a modification for copulation. The genital capsule (segment IX) bears a curved and flexible aedeagus, and a pair of unequal claspers or parameres on its margin.

The abdomen of the female is quite symmetrical. The various segments form a regular series of undivided terga and sterna. Only tergum VIII is divided in the middle. A distinct ovipositor is absent since eggs are usually deposited on the surface of underwater objects, and not inserted into plant tissue.

#### Key to genera

In the Corixidae, only males can be identified with certainty. Identification of females is usually done by association with known males. The key below necessarily relies heavily on characters found only in the male.

## KEY TO GENER'A OF CORIXIDAE FROM SALINE WATERS

1.	Rostrum with transverse sulcations	2
	Rostrum without transverse sulcations	<i>Cymatia</i> Flor
2.	Antennae 3-jointed	<i>Micronecta</i> Kirkaldy
	Antennae 4-jointed	3
3.	Eyes protuberant; frons of both sexes concave and hirsute	<i>Dasycorixa</i> Hungerford
	Eyes not protuberant; frons of female not concave	4
4.	Pronotum and hemelytra unicoloured	<i>Agraptocorixa</i> Kirkaldy
	Pronotum and hemelytra with transverse black markings	5
5.	Strigil present in male	6
	Strigil absent in male	<i>Callicorixa</i> White
6.	Male with abdominal strigil on the left when abdomen viewed from above	7
	Male with abdominal strigil on the right when abdomen viewed from above	8
7.	Small shiny insects, less than 5.6 mm in length	<i>Trichocorixa</i> Kirkaldy
	Large insects, over 8.00 mm in length and not shiny	<i>Corixa</i> Geoffroy
8.	Male with 2 distinct rows of pegs, one above other on triangular pala; lateral lobe of prothorax with sides tapering to a narrowly rounded apex	<i>Corisella</i> Lundblad
	Male with single row of pegs on pala, or if with double rows then these not arranged one above the other; pala not triangular	9
9.	Infraocular portion of gena broad; lateral lobe of pronotum quadrate or trapezoidal in shape	<i>Hesperocorixa</i> Hungerford
	Infraocular portion of gena not broad; lateral lobe of pronotum narrower than long	10
10.	Hemelytral pattern reticulate; frons and hemelytra hairy	11
	Hemelytral pattern not reticulate; frons and hemelytra not hairy	<i>Sigara</i> Fabricius
11.	Pronotum with a well-defined longitudinal median carina extending from anterior to posterior margin	<i>Arctocorixa</i> Wallengren
	Pronotum with a poorly defined median longitudinal carina confined to the anterior third	<i>Cenocorixa</i> Hungerford

## 10.3 BIOLOGY

*10.3.1 Life history, reproduction, seasonality*

Species in tropical waters appear to breed all the year round (Peters and Spurgeon, 1971; Peters and Ulbrich, 1973) e.g. *Sigara meridionalis* of the Cape Province of South Africa (Harrison, 1962). In temperate regions, species show a characteristic seasonality in their breeding (Bobb, 1953; Crisp, 1962b; Young, 1965b; Green, 1968; Jansson and Scudder, 1974; Martin, 1970; Pajunen, 1970b; Savage, 1971a; Sokol'skaya and Zhiteneva, 1973; Tones, 1975).

In most temperate genera, the species overwinter as adults and mating takes place in the spring (Popham, 1947). However, Poisson (1935) reported that *Micronecta* overwinters in the larval stage, and also found that *Corixa affinis* may pass the winter as an egg. Tones (1975) has recently found that *Trichocorixa verticalis interiores* in Saskatchewan, overwinters in the egg stage. Eggs are usually



laid underwater on plants or other objects in the spring and there is either one single generation or a partial second generation, but a partial third generation has also been reported (Kanyukova, 1973; Jansson and Scudder, 1974). The factors that determine the number of generations in the different species have not been elucidated in detail.

Davis (1966) found that the preferred oviposition site of *Trichocorixa reticulata* in a saline pool in Trinidad was the underside of a small mangrove stump, but a few eggs were laid on immersed dead leaves and twigs. Stones are the substrate used for oviposition by *T. v. interiores* in Saskatchewan (Tones, 1975).

Eggs of Corixidae are usually somewhat top-shaped with a short button-like disc, but in *Agraptocorixa* and *Cymatia* the stalk may be of considerable length (Hungerford, 1948). While most eggs are attached by a stalk, those of *Micronecta* are placed horizontally and are without a stalk. Generally the eggs are deposited singly and well-spaced, but clumping may occur and at times the numbers may be so great that they can be gathered and used as human food (Hungerford, 1948).

The incubation period of the eggs varies according to temperature (Poisson, 1923, 1924; Sutton, 1947a; Banks, 1949; Scudder, 1966; Martin, 1970). Species also seem to differ in their response to temperature (Sokol'skaya and Zhiteneva, 1973). In *T. v. interiores*, Tones (1975) has shown that the eggs, which are laid in August when the water temperature is high, do not develop immediately but require a period of diapause.

Studies by Poisson (1924), Banks (1949) and Davis (1965, 1966) show that high salinity can retard the absorption of water or may even destroy the eggs. Davis (1966) found that the eggs of *T. reticulata* not only could tolerate a very high water temperature (37.8–39.5°C) but could also tolerate an extremely wide range of salinities which may be sufficiently high to withdraw most of the water from the unhatched young. Such tolerance, however, probably only exists in the genus *Trichocorixa*.

All saline Corixidae appear to have five larval (nymphal) instars. There are very few studies on larval development, but it is clear that temperature effects the speed of post-embryonic growth. The lack of study on larval stages in general is partly due to the inability to identify them to species. Only recently have keys to some of the genera and species of larval Corixidae become available (Cobben and Pillot, 1960; Scudder, 1966; Jansson, 1969). To date, only Pajunen and Sundback (1973) have studied the effect of temperature on the development of Corixidae in detail.

### 10.3.2 Food

Until recently Corixidae were believed to be primarily herbivorous as shown by the work of Hungerford (1919) who found these insects could pierce cells of

filamentous algae and suck out the contents. He also noted that they could gather food by sweeping the flocculent bottom material of the habitat into the mouth with the palae, having found oligochaetes, nematodes, rotifers and protozoans in the gut. However, Hungerford (1917, 1919, 1948) concluded that Corixidae were largely herbivorous, consume very little animal matter, and do this along with the plant matter. Only the genus *Cymatia* was regarded as pre-daceous.

There is now a large body of evidence suggesting that most genera of Corixidae may be predaceous (Sutton, 1947b, 1951; Zwart, 1965; Scudder, 1966; Jansson, 1969; Pajunen, 1970c; Jansson and Scudder, 1972; Peters and Ulbrich, 1973; Sokol'skaya and Zhiteneva, 1973; Reynolds, 1974, 1975). Using serological techniques Reynolds (1974) has shown that a predatory and scavenging habit was dominant in *Callicorixa audeni*, *Cenocorixa bifida*, *C. expleta* and *Hesperocorixa laevigata* found in saline lakes of British Columbia. Levels of feeding on plant material was negligible. The guts of over half of the specimens tested showed these insects had fed on Chironomidae and Zygoptera, with smaller numbers showing evidence of feeding on Ephemeroptera, Amphipoda and planktonic crustaceans. Similar study of the gut contents of *Trichocorixa verticalis interiores* in the saline lakes of Saskatchewan shows Chironomidae to be a main food (Reynolds and Swanson, personal communication).

There is no doubt that certain Corixidae do utilize bottom ooze containing protozoans, rotifers, diatoms, etc. and may also feed on the cell contents of filamentous algae (Reynolds, 1975). Corixidae are extremely abundant in many inland saline habitats, and may constitute one of the important predators in this environment. However, certain saline species seem to feed mainly on algae, diatoms, etc. (Pearse, 1932; Kanyukova, 1973; Reynolds, 1974). Sokol'skaya and Zhiteneva (1973) found that the saliva of *Sigara lateralis* and *S. striata* was toxic and induced irreversible changes in the blood of fish fry, making these insects pests of fish culture in the Rostov district.

### 10.3.3 Predators

Corixidae are subject to predation in all stages of the life cycle. The predators recorded include both invertebrates and vertebrates.

Davids (1973) found both nymphs and adults of the water mite *Hydrachna conjecta* (Koenike) feeding on corixid eggs. While the short stalked eggs of *Sigara striata* were heavily preyed upon, those of *Cymatia coleoprata* (Fab.) with long stalks, were rarely eaten.

Eggs may also be preyed upon by the Corixidae themselves (Crisp, 1960; Young, 1965b; Pajunen, 1970c). Crisp (1960) points out that the intensity of egg cannibalism might be expected to vary with the density of adults and eggs and the availability of adult food. This has been confirmed in *Cenocorixa* (Scudder,

unpublished). Crisp (1960) and Pajunen (1970c) suggest that egg cannibalism could be a mechanism for population regulation.

Larval and adult Corixidae are preyed upon by a wide variety of predators such as Notonectidae, Naucoridae, larval Belostomatidae and larval Dytiscidae. There has been no intensive study of invertebrate predators of Corixidae in saline environments.

Predation by fish has been recorded a number of times (e.g. Frost and Macan, 1948; Fernando, 1956; Macan, 1965). Some of the original reports suggest that fish predation is not very significant, but Macan (1965) showed that fish could have a pronounced effect. Popham (1942, 1943a, 1944) showed that fish predation might vary according to the cryptic coloration of the insect species. Fish are uncommon in inland saline habitats, but may be an important predator in inshore marine environments.

Salamanders have been noted as predators by Griffith (1945) and predation by water fowl and waders has been recorded a number of times (Hutchinson, 1930; Griffith, 1945; Munro, 1945). Flying Corixidae may fall prey to birds (Fernando, 1959), or bats (Walton, 1943).

Corixidae, like other Heteroptera, produce odoriferous secretions from mid-dorsal abdominal glands in the larva and metathoracic glands in the adult. These have generally been thought to have a defensive function (Remold, 1963). Pinder and Staddon (1965a, 1965b) have shown that a main constituent of the adult secretion in *Sigara falleni* is trans-4-oxohex-2-enal. The secretions of male and female were not distinguishable, and no difference could be found between the secretions of *S. falleni* and *Corixa punctata*. They point out that while the secretion may act as a defense against predators, it might have other functions, such as preventing the settling of micro-organisms.

#### 10.3.4 Parasites and symbionts

The most important ectoparasites of Corixidae are larval water mites. There are numerous records of these attached to various parts of the body (e.g. Fernando, 1958, 1959; Harris, 1970; Davids, 1973; Harris and Harrison, 1974; Martin, 1975), but none are recorded from the marine environment.

There are evidently few internal parasites of Corixidae and there are no symbionts, although protozoans and nematodes have been found in some species (Poisson, 1935; Banks, 1939; Crisp, 1962b; Martin, 1970). Cestode cysts have been recorded in *Sigara falleni*, epiphytic algae sometimes occur on the dorsum and colonies of peritrich ciliates and suctorian protozoans can occur on the legs (Martin, 1970).

## 10.4 ECOLOGY

## 10.4.1 Special adaptations

*Respiration*

The first two larval instars of Corixidae have a closed tracheal system and they respire exclusively through the integument. In the third instar, the tracheal system becomes open and they are then able to use atmospheric air, taken in at the water surface, as well as oxygen dissolved in the water by means of a 'physical gill' (Ege, 1918). These external air stores, which adhere to the body of the submerged insect, are either in the form of a thin layer of air retained by a fine pile of hairs on the integument, or partially concealed air bubbles trapped between parts of the body (Fig. 10.8). These various air stores are in continuity with one and another through

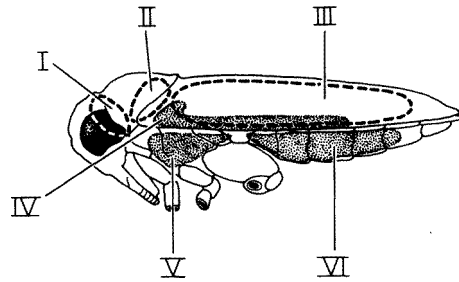

Fig. 10.8. Side view of adult Corixid showing general position of external air stores. I, air bubble between head and pronotum; II, air bubble between pronotum and mesonotum; III, subalar air bubble, between wings and abdominal dorsum; IV, air film on upper (exposed) surface of hemelytron; V, ventral thoracic air film on ventro-lateral areas of thorax; VI, ventral abdominal air film on abdominal venter.

a complex series of interconnections described in detail for *Hesperocorixa* by Parsons (1970).

Corixidae are periodically forced to renew the air stores at the surface. They do so by taking air into the intersegmental ventrally continuous spaces between the head and prothorax, and between the prothorax and mesothorax; the other external air stores are filled from these (Ege, 1918; Botjes, 1932; Popham, 1959, 1960; Rahn and Paganelli, 1968).

Corixids usually remain at the bottom of water bodies, holding onto various objects by their middle legs, occasionally coming to the water surface, and then darting back to the bottom (Buono, 1916). Their extreme lightness as a result of the adhered air bubbles compels them to anchor themselves in order to remain under water. Their dependence on external air stores, which need to be renewed periodically, necessarily restricts them to rather shallow inshore waters.

The maintenance of salt and water balance is of vital importance for survival in saline environments. In general, this ability is related to (i) permeability of the integument; (ii) ability to modify uptake of ions from the external medium, and (iii) ability to modify composition of the urine.

Staddon (1964, 1966) has shown that adult *Corixa dentipes* (Thomson) normally lose water via the rectum and gain water by drinking: in freshwater they can also gain (or lose) water by osmotic uptake through the integument. *C. dentipes* has a marked cuticular permeability and this probably prevails in most Corixidae. Although drinking was negligible in *C. dentipes* kept in deionized water (Staddon, 1966), considerable drinking does occur in *Cenocorixa bifida* and *C. expleta* in saline waters (Scudder, 1965). The ability to control such drinking is an essential requirement for a fully saline corixid.

Studies on variations in haemolymph composition relative to changes in external salinity have been undertaken in *Agraptocorixa* (Knowles and Williams, 1973), *Cenocorixa* (Scudder, 1971a; Scudder et al., 1972), *Corisella* (Frick and Sauer, 1974b), *Sigara* (Claus, 1937) and *Trichocorixa* (Tones and Hammer, 1975). All species studied to date have some regulatory capacity (see Fig. 10.9). It is evident that only *Trichocorixa verticalis interiores* can regulate over a wide range of salinities. Studies on ionic balance in *Cenocorixa* (Scudder et al., 1972) and *Corisella* (Frick et al., 1972) show a similar regulatory ability.

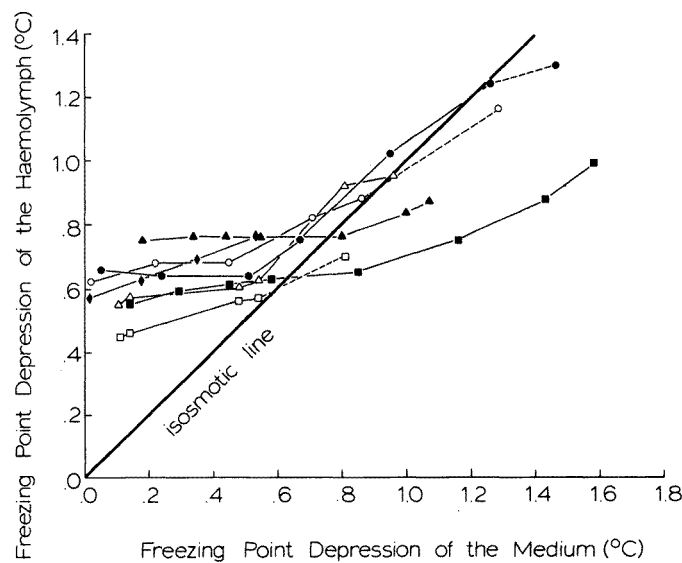

Fig. 10.9. Comparison of osmoregulatory ability of various Corixidae in saline waters. □, *Agraptocorixa hirtifrons*; ○, *Cenocorixa bifida hungerfordi*; ●, *Cenocorixa expleta*; ◆, *Corisella edulis*; △, *Sigara australis*; ▲, *Sigara stagnalis*; ■, *Trichocorixa verticalis interiores*. (Redrawn from Tones and Hammer, 1975.)

Komnick and Wichard (1975) found variation in the distribution of chloride cells on the exposed body surface of *Hesperocorixa* and *Micronecta* during development and assumed that they were concerned with ionic regulation. The specialized labial epidermis in all Corixidae (except Cymatinae) may also be involved with ionic regulation (Jarial et al., 1969). Although the detailed functioning of the Malpighian tubules has not been described, it is evident that salinity can influence certain secretory activity of these tubules which have four distinct parts (Jarial and Scudder, 1970; Frick and Sauer, 1974a). There is also evidence for a neurosecretory involvement in osmotic and ionic balance, at least in *Cenocorixa bifida* (Jarial and Scudder, 1971).

Since the fluid secreted by the Malpighian tubules appears to be isosmotic with the haemolymph, the insect must modify its urine in order to colonize saline habitats successfully. Studies on *Cenocorixa bifida* and *C. expleta* (Scudder et al., 1972), *Corisella edulis* (Champion) (Frick and Sauer, 1974c) and *Corixa dentipes* (Staddon, 1964) show that they all produce a urine hyposmotic to the haemolymph, even when in saline conditions. This suggests that these typically freshwater species have a limited ability to enter and survive in saline environments. However, species of *Trichocorixa*, *T. beebei*, *T. reticulata* and *T. verticalis*, which occur in highly saline waters must have a well-developed capacity to produce a hyperosmotic urine. So far *Trichocorixa* is the only genus reported from the sea.

Although Corixidae are aquatic in all their life stages, the adults have a marked tendency to leave water and disperse by flight. Such aerial dispersal has been reported in many saline species, but is not universal because some species have reduced wings or flight muscles. Species of *Cymatia* and *Micronecta* have reduced and non-functional wings and *C. americana* is restricted to permanent water bodies with sufficient depth to permit winter survival (Applegate, 1973). A number of species of *Cenocorixa* and *Sigara* also have non-flying morphs (Young, 1961, 1964, 1965a; Acton and Scudder, 1969; Scudder, 1964, 1971b, 1975a), although these can develop flight musculature later if conditions become suitable (Scudder and Meridith, 1972).

In the tropics, dispersal of Corixidae has been reported as cyclic and related to lunar cycles and atmospheric conditions (Richard-Vindard, 1967). In temperate regions dispersal also takes place in fine weather, either in the day or night (Popham, 1964). There are two main dispersal periods during the year (Young, 1966): a spring dispersal for overwintered adults, and a late summer and fall dispersal for new generation adults. The spring dispersal serves to distribute the species to suitable habitats prior to egg laying, and the fall dispersal probably relieves high population density or to distribute species to areas where they can overwinter (Brown, 1954).

The high dispersal potential of Corixidae allows them to utilize almost all

available habitats, including temporary ones. Pajunen and Jansson (1969b) and Pajunen (1970c) have noted a pronounced propensity to disperse in *Arctocorisa carinata* and *Callicorixa producta* in rock pool environments and interpreted this as an adaptation to the heterogeneity and temporary nature of the habitats (see also Brown, 1951, 1954; Southwood, 1962). Differences in dispersal potential of species in saline environments have been reported (Macan, 1939; Brown, 1951; Poisson et al., 1958; Richard, 1961), but whether these differences persist in temporary and permanent saline habitats has not been established. Scudder (1969b) found that *Cenocorixa bifida* was unable to survive all year round in a high salinity lake in British Columbia. The lake is regularly recolonized each fall, and the insect could produce one generation there each spring before the temperature-salinity combination rose above its tolerance.

Just how far corixids are able to travel is not known. Popham (1952) thought dispersal was unlikely to last more than one hour at 22°C in *Sigara striata*, but the majority of species could survive in air for 2–3.5 hours (Popham, 1951). Thus, *Corixa punctata* and *Sigara distincta* (Fieber), flying at 3.9–6.4 km per hour, are unlikely to disperse more than 9.6–12.8 km on a windless day, but, on the other hand, they may be able to travel 65–90 km per day (Popham, 1964). Pajunen (1970a), however, estimated the flight speed of small Corixidae to be in the order of 1 metre per second in still air.

Wind is probably more important in dispersal than the actual activity of the insects themselves (Popham, 1952). Very slow winds of 8–16 km per hour are sufficient to blow Corixidae off course (Popham, 1943b).

It seems possible that air currents could disperse Corixidae over considerable distances, enabling certain saline species to utilize somewhat isolated areas (Hoberlandt, 1951). Corixidae are attracted to any shiny surface such as car tops, greenhouses (Popham, 1964) or freshly watered streets (Lange, 1905), and do not seem able to select appropriate water bodies prior to alighting (Popham, 1964). This behavior implies that the mortality as a result of emigration and dispersal must be high in these insects.

While dispersal of Corixidae is usually by flight, Hutchinson (1931) noting that *Trichocorixa reticulata* is widely distributed in the Pacific, suggested that this species may have travelled with the North Equatorial Current from California to Hawaii, and then to China. Owing to their external air stores, these insects are lighter than water and able to float. It is quite possible that *Trichocorixa verticalis californicus* has also been carried by ocean currents from California to coastal areas of British Columbia (Scudder, 1975b).

#### *10.4.2 Range of habitat and distribution*

The Corixidae are capable of utilizing virtually all aquatic habitats and seem to be ecologically adaptable to a wide range of environmental conditions. They can

subsist on a variety of food organisms and lack of food is rarely likely to be a limiting factor.

The most important habitat requirements are availability of oviposition sites, water depth and salinity. These insects have to surface periodically in order to replenish the external air stores (Hutchinson, 1933), since the lifetime of a compressible gas gill is greatly reduced at depths (Rahn and Paganelli, 1968). Corixidae are unable to exist in deep water without a substratum within easy reach of the surface (Hutchinson, 1930). Rawson and Moore (1944) have taken larvae at a depth of 10 m, but they do not seem to occur in the open regions of large lakes (Hutchinson, 1933).

*Trichocorixa verticalis* is the only species recorded from offshore waters (Gunter and Christmas, 1959). Whether it has been carried out by ocean currents or can live and reproduce in the sea is not known. From the physiological point of view, only *Trichocorixa* can be regarded as truly saline. However, it should be noted that not all species of this genus occur in saline environments.

Corixidae are world wide in distribution and saline species have been recorded in most of the zoogeographic areas (Table 10.1). They have no difficulty in colonizing available water bodies and presumably they can survive in any region in which a little water exists during the driest season of the year (Hutchinson, 1933).

The earliest fossil records of Corixidae are from the Upper Jurassic of Kazak-hastan (Popov, 1971). Continental drift seems insufficient in interpreting the current zoogeography of the family. More recent geological events, such as glaciations and climatic changes are likely to be more important (Hutchinson, 1933; Brown, 1945).

Very little is known about the role of temperature and other climatic factors in determining the distribution of Corixidae (Hutchinson, 1933). The adults are liable to desiccation should they stay out of water too long or the temperature be too high for cuticular wax stability (Holdgate, 1956; Oloffs and Scudder, 1966). However, while ambient dry air temperatures between 30 and 35°C are critical for *Cenocorixa expleta* (Oloffs and Scudder, 1966), species must differ. Davis (1966) recorded *Trichocorixa reticulata* living successfully in high salinity at a temperature between 37.8 and 39.5°C in Jamaica.

The effect of salinity on the distribution is better known, e.g. distribution in relation to salinity of the environment (Lindberg, 1948; Butler and Popham, 1958; Scudder, 1969a; Savage, 1971b; Knowles and Williams, 1973; Hammer et al., 1975; Swanson, 1975), and there have been some experimental studies on salinity effects on adults (Claus, 1937; Scudder, 1969a, 1969b; Scudder et al., 1972; Knowles and Williams, 1973; Tones and Hammer, 1975) as well as eggs (Banks, 1949; Davis, 1966). Fig. 10.9 summarizes the distribution of various species in habitats with known salinities, and also indicates the probable upper salinity tolerance of each species listed. It should be pointed out that the eggs



may have a different limit of salinity tolerance to that of the adult (Banks, 1949), and species do not breed everywhere they occur.

Although *Trichocorixa* is the only genus found regularly in the marine environment, little experimental research has been carried out to date. Tones and Hammer (1975) have recorded *T. verticalis interiores* in athalassic waters up to 66‰ and *T. beebei* has been recorded in Arcturus Lake on Genovesa Island, Galapagos, in water with a salinity of 49.9‰, and in Tagus Crater Lake on Isabela Island where the salinity may reach 80‰ (Howmiller, 1969).

*Trichocorixa verticalis* has been taken in plankton tows in the waters of Delaware Bay (salinity 24.9–29.4‰) in association with typical marine organisms, (Hutchinson, 1931) and 16–32 km offshore of Louisiana and Mississippi (salinity 26.1–32.3‰) (Gunter and Christmas, 1959).

*Trichocorixa reticulata* has been taken in plankton tows in the Colorado River delta at the extreme northern end of the Gulf of California (salinity 37–44‰) (Polhemus and Hendrickson, 1974). Other records include those by Davis (1966)

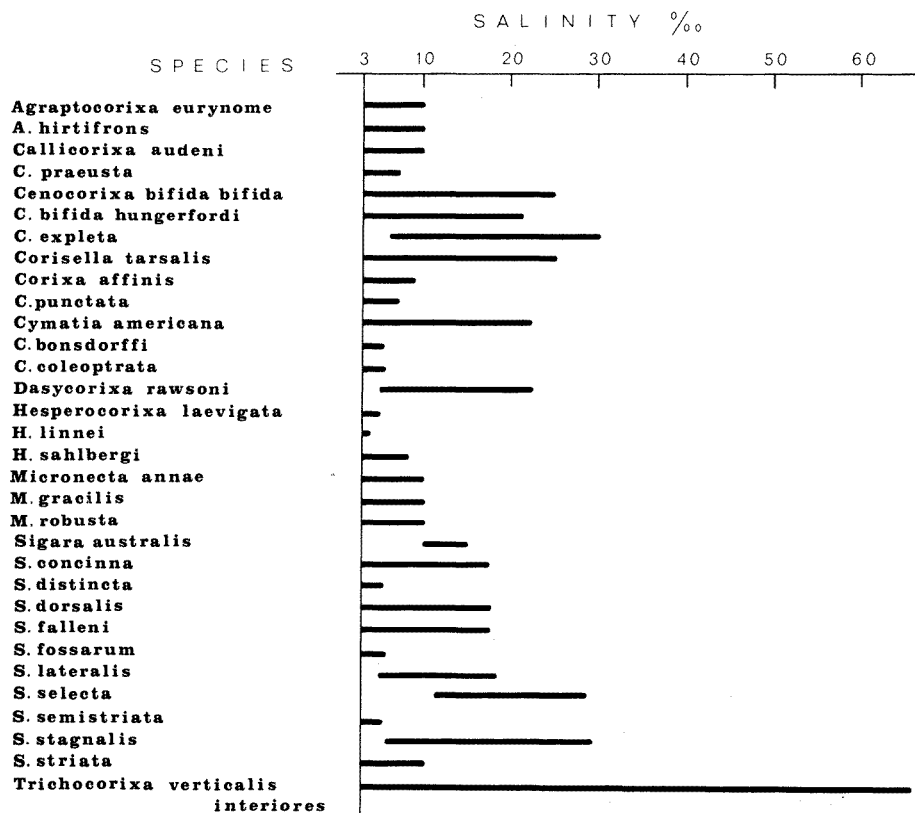

Fig. 10.10. Diagram showing general salinity tolerance of some saline Corixidae.

in Jamaica (salinity 37–44‰) and Barlow (1958) in shore pools of the Salton Sea where the salinity can reach 62‰. The highest recorded salinity tolerance of this species is from the Alviso salt ponds in San Francisco Bay area where it breeds in a series of five salt-producing ponds with a mean annual salinity of 94‰ and a maximum of 153‰ (Carpelan, 1957).

### 10.4.3 Population dynamics

There has been no study of the population dynamics of saline Corixidae. This is in part owing to (i) the usual inaccessibility of their habitats; (ii) the difficulty of sampling in inshore areas; and (iii) the very patchy distribution that prevails in most habitats. While some marking and recapture experiments have been carried out (Pajunen and Jansson, 1969a, b), most workers still rely on sweep net sampling with all of its obvious limitations.

Tones and Hammer (1975) found *Trichocorixa verticalis interiores* in the littoral area of Big Quill Lake in Saskatchewan with a maximum density of 1978 adults per m<sup>2</sup>.

A study of *Cenocorixa* in the saline lakes of British Columbia suggested that *C. expleta* may be excluded from the lower salinity lakes by competitive interaction with *C. bifida* (Scudder et al., 1972). Similarly, Ettershank and co-workers (1966) believed that the absence of Corixidae in the saline lakes of southwestern Victoria and southeastern South Australia may be due to the presence of Crustacea.

Both intraspecific and interspecific interactions must undoubtedly influence the distribution and population dynamics of species. Istock (1973), using enclosure experiments, claims that interspecific competition exists in Corixidae, and he believes that ecological homologues exist at least in the genera *Hesperocorixa* and *Sigara*.

## 10.5 CONCLUSION

In saline habitats, Corixidae seem to be part scavengers and part predators; certainly they are not always general detritus feeders as stated by Bay (1974). While they are frequently among the most abundant of littoral organisms in saline lakes, in some instances at least they appear to be the top carnivore with an important regulatory role in the ecosystem (Reynolds, 1975).

Why these insects have not been more successful in truly marine environment is not clear. While food, and osmotic and ionic regulation seem not to be the limiting factors for *Trichocorixa*, other physiological and biological requirements are obviously involved and require further studies.

## ACKNOWLEDGEMENTS

The preparation of this article was supported by a grant from the National Research Council of Canada. I am indebted to the following for their assistance: Dr. R.L. Applegate, Dr. C.H. Fernando, Dr. A. Jansson, Dr. L.A. Kelton, Mr. I. Lansbury, Dr. J.D. Reynolds, Miss S.M. Swanson, Mrs. P.I. Tones and Prof. A. Wroblewski.

## REFERENCES

- Acton, A.B. and Scudder, G.G.E. (1969) The ultrastructure of the flight muscle polymorphism in *Cenocorixa bifida* (Hung.) (Heteroptera, Corixidae). *Z. Morphol. Tiere* 65, 327–335.
- Applegate, R.L. (1973) Corixidae (water boatmen) of the South Dakota Glacial Lake District. *Entomol. News* 84, 163–170.
- Baid, I.C. (1959) Some preliminary notes on the insect life in Sambhar Lake. *J. Bombay Nat. Hist. Soc.* 56, 361–363.
- Baid, I.C. (1968) The arthropod fauna of Sambhar Salt Lake, Rajasthan, India. *Oikos* 19, 292–303.
- Banks, C.J. (1939) On the occurrence of nematodes in *Corixa geoffroyi* Leach (Hemiptera, Corixidae). *J. Soc. Br. Entomol.* 1, 217–219.
- Banks, C.J. (1949) The absorption of water by the eggs of *Corixa punctata* Illig. (Hemiptera, Corixidae) under experimental conditions. *J. Exp. Biol.* 26, 131–136.
- Barlow, G.W. (1958) Daily movements of desert pupfish, *Cyprinodon macularius* in shore pools of the Salton Sea. *Ecology* 39, 580–587.
- Bay, E.C. (1974) Predator - prey relationships among aquatic insects. *Annu. Rev. Entomol.* 19, 441–453.
- Bobb, M.L. (1953) Observations on the life history of *Hesperocorixa interrupta* (Say) (Hemiptera: Corixidae). *Virginia J. Sci. (n.s.)* 4, 111–115.
- Botjes, J.O. (1932) Die Atemregulierung bei *Corixa geoffroyi* Leach. *Z. Vergl. Physiol.* 17, 557–564.
- Brooks, A.R. and Kelton, L.A. (1967) Aquatic and semiaquatic Heteroptera of Alberta, Saskatchewan, and Manitoba (Hemiptera). *Mem. Entomol. Soc. Can.* 51, 1–92.
- Brown, E.S. (1945) The Corixidae of the Faeroe Islands, with observations on the geographical distributions of Corixidae in neighbouring parts of the world. *Proc. Zool. Soc. Lond.* 114, 490–506.
- Brown, E.S. (1951) The relation between migration rate and type of habitat in aquatic insects, with special reference to certain species of Corixidae. *Proc. Zool. Soc. Lond.* 121, 539–545.
- Brown, E.S. (1954) Report on Corixidae (Hemiptera) taken in light-traps at Rothamsted Experimental Station. *Proc. R. Entomol. Soc. Lond. (A)* 29, 17–22.
- Bueno, J.R. de la Torre- (1916) Aquatic Hemiptera. A study in the relation of structure to environment. *Ann. Entomol. Soc. Am.* 9, 353–365.
- Butler, P.M. and Popham, E.J. (1958) The effects of the floods of 1953 on the aquatic insect fauna of Spurn (Yorkshire). *Proc. R. Entomol. Soc. Lond. (A)* 33, 149–158.
- Carpelan, L.H. (1957) Hydrobiology of the Alviso salt ponds. *Ecology* 38, 375–390.
- Claus, A. (1937) Vergleichend-physiologische Untersuchungen zur Oekologie der Wasserwanzen, mit besonderer Berücksichtigung der Brackwasserwanze *Sigara lugubris* (Fieb.). *Zool. Jb.* 58, 365–432.
- Cobben, R.H. and Pillot, H.M. (1960) The larvae of Corixidae and an attempt to key the last larval instar of the Dutch species (Hem., Heteroptera). *Hydrobiologia* 16, 323–356.
- Cole, G.A. (1968) Desert limnology. In: *Desert Biology*. (G.W. Brown, Ed.) 1, 423–486.

- Crisp, D.J. (1960) A study of egg mortality in *Corixa germani* Fieb. (Hem., Corixidae). Entomol. Mon. Mag. 96, 131–132.
- Crisp, D.T. (1962a) Estimates of the annual production of *Corixa germani* (Fieb.) in an upland reservoir. Arch. Hydrobiol. 58, 210–223.
- Crisp, D.T. (1962b) Observations on the biology of *Corixa germani* (Fieb.) (Hemiptera Heteroptera) in an upland reservoir. Arch. Hydrobiol. 58, 261–280.
- Davids, C. (1973) The water mite *Hydrachna conjecta* Koenike, 1895 (Acari, Hydrachenllae), bionomics and relation to species of Corixidae (Hemiptera). Neth. J. Zool. 23, 363–429.
- Davis, C.C. (1965) A study of the hatching process in aquatic invertebrates. XII. The eclosion process in *Trichocorixa naias* (Kirkaldy) (Heteroptera, Corixidae). Trans. Am. Microscop. Soc. 84, 60–65.
- Davis, C.C. (1966) Notes on the ecology and reproduction of *Trichocorixa reticulata* in a Jamaican salt-water pool. Ecology 47, 850–852.
- Edmondson, W.T. (1966) Pacific Coast and Great Basin. In: Limnology in North America (D.G. Frey, Ed.) pp. 371–392.
- Ege, R. (1918) On the respiratory function of the air stores carried by some aquatic insects (Corixidae, Dytiscidae, Notonecta). Z. Allg. Physiol. 17, 81–125.
- Ettershank, G., Fuller, M. and Brough, E.J. (1966) Hemiptera from saline waters in inland Australia. Aust. J. Sci. 29, 144–145.
- Fernando, C.H. (1956) On the food of four common freshwater fish of Ceylon. Ceylon J. Sci. (C) 7, 201–217.
- Fernando, C.H. (1958) Water mites (Hydracarina) parasitic on insects with notes on the dispersal of small freshwater invertebrates. J. Bombay Nat. Hist. Soc. 55, 379–381.
- Fernando, C.H. (1959) The colonization of small freshwater habitats by aquatic insects. 2. Hemiptera (The water-bugs). Ceylon J. Sci. (Biol. Sci.) 2, 5–32.
- Frick, J.H., Drew, W.A. and Sauer, J.R. (1972) Sodium and chloride regulation in two adult aquatic hemipterans, *Corisella edulis* Champion and *Bueno margaritacea* Torri-Bueno. Comp. Bio-chem. Physiol. 41A, 239–248.
- Frick, J.H. and Sauer, J.R. (1974a) The effects of salinity on the uptake of indigo carmine by the Malpighian tubules of *Corisella edulis* Champion. Comp. Biochem. Physiol. 47A, 391–394.
- Frick, J.H. and Sauer, J.R. (1974b) Osmoregulation in the adult water boatman, *Corisella edulis* Champion. Comp. Biochem. Physiol. 47A, 789–797.
- Frick, J.H. and Sauer, J.R. (1974c) Water balance in the adult water boatman, *Corisella edulis* Champion. Comp. Biochem. Physiol. 48A, 105–113.
- Frost, W.E. and Macan, T.T. (1948) Corixidae (Hemiptera) as food for fish. J. Anim. Ecol. 17, 174–179.
- Gessner, F. (1957) Van Gölü. Zur Limnologie des grossen Soda-Sees in Ostanatolien (Türkei). Arch. Hydrobiol. 53, 1–22.
- Green, J.W. (1968) The Biology of Estuarine Animals. (, .)
- Griffith, M.E. (1945) The environment, life history and structure of the water boatman, *Ramphocorixa acuminata* (Uhler) (Hemiptera, Corixidae). Kans. Univ. Sci. Bull. 30, 241–365.
- Gunter, G. and Christmas, J.Y. (1959) Corixid insects as part of the offshore fauna of the sea. Ecology 40, 724–725.
- Hammer, U.T., Haynes, R.L., Heseltine, J.M. and Swanson, S.M. (1975) The saline lakes of Saskatchewan. Verh. Int. Verein. Theor. Angew. Limnol. 19, 589–598.
- Harris, D.A. (1970) The larval ecology of two species of *Hydrachna* (Acari, Hydrachnidae) parasitic upon Corixidae (Hemiptera - Heteroptera). (M.Sc., , .)
- Harris, D.A. and Harrison, A.D. (1974) Life cycles and larval behavior of two species of *Hydrachna* (Acari, Hydrachnidae), parasitic upon Corixidae (Hemiptera - Heteroptera). Can. J. Zool. 52, 1155–1165.

- Harrison, A.D. (1962) Hydrobiological studies on alkaline and acid still waters in the western Cape Province. *Trans. R. Soc. S. Afr.* 36, 213–244.
- Hoberlandt, L. (1948) Results of the zoological scientific expedition of the National Museum in Praha to Turkey. 2. Hemiptera - Heteroptera. 1. The aquatic and semiaquatic Heteroptera of Turkey. *Sb. Entomol. Odd. Nar. Mus. Praze* 26 (352) 1–74.
- Hoberlandt, L. (1951) Hemiptera - Heteroptera collected by Mr. J. Houska in Israel. *Sb. Entomol. Odd. Nar. Mus. Praze* 27, 5–34.
- Holdgate, M.W. (1956) Transpiration through the cuticles of some aquatic insects. *J. Exp. Biol.* 33, 107–118.
- Howes, N.H. (1939) The ecology of a saline lagoon in south-east Essex. *J. Linn. Soc. Zool.* 40, 383–445.
- Howmillier, R. (1969) Studies on some inland waters of the Galapagos. *Ecology* 50, 73–80.
- Hungerford, H.B. (1917) Notes concerning the food supply of some water bugs. *Science* 45, 336–337.
- Hungerford, H.B. (1919) The biology and ecology of aquatic and semiaquatic Hemiptera. *Kans. Univ. Sci. Bull.* 11, 1–228.
- Hungerford, H.B. (1948) The Corixidae of the Western Hemisphere. *Kans. Univ. Sci. Bull.* 32, 1–827.
- Hutchinson, G.E. (1929) A revision of the Notonectidae and Corixidae of South Africa. *Ann. S. Afr. Mus.* 25, 359–474.
- Hutchinson, G.E. (1930) Report on Notonectidae, Pleidae, and Corixidae (Hemiptera), Mr. Omer-Cooper's Investigation of the Abyssinian Fresh Waters. *Proc. Zool. Soc. Lond.* 1930, 437–466.
- Hutchinson, G.E. (1931) On the occurrence of *Trichocorixa* Kirkaldy (Corixidae, Hemiptera - Heteroptera) in salt water and its zoo-geographical significance. *Am. Nat.* 65, 573–574.
- Hutchinson, G.E. (1932) Reports on the Percy Sladen Expedition to some Rift Valley Lakes in Kenya in 1929. II. Notonectidae, Pleidae, and Corixidae from the Rift Valley Lakes in Kenya. *Ann. Mag. Nat. Hist.* (10)9, 323–329.
- Hutchinson, G.E. (1933) The zoogeography of the African aquatic Hemiptera in relation to past climatic change. *Int. Rev. Hydrobiol.* 28, 436–468.
- Hutchinson, G.E. (1937) A contribution to the limnology of arid regions, primarily founded on observations made in the Lahontan Basin. *Trans. Conn. Acad. Arts Sci.* 33, 49–132.
- Hynes, H.B.N. (1955) Biological notes on some East African aquatic Heteroptera. *Proc. R. Entomol. Soc. Lond.* (A) 30, 43–86.
- Istock, C.A. (1973) Population characteristics of a species ensemble of waterboatmen (Corixidae). *Ecology* 54, 535–544.
- Jaczewski, T. and Wroblewski, A. (1975) Further notes on aquatic Heteroptera from Mongolia. *Bull. Entomol. Polon.* 45, 51–61.
- Jansson, A. (1969) Identification of larval Corixidae (Heteroptera) of Northern Europe. *Ann. Zool. Fenn.* 6, 289–312.
- Jansson, A. (1972) Mechanisms of sound production and morphology of the stridulatory apparatus in the genus *Cenocorixa* (Hemiptera, Corixidae). *Ann. Zool. Fenn.* 9, 120–129.
- Jansson, A. and Scudder, G.G.E. (1972) Corixidae (Hemiptera) as predators: rearing on frozen brine shrimp. *J. Entomol. Soc. B. C.* 69, 44–45.
- Jansson, A. and Scudder, G.G.E. (1974) The life cycle and sexual development of *Cenocorixa* species (Hemiptera, Corixidae) in the Pacific Northwest of North America. *Freshwater Biol.* 4, 73–92.
- Jarial, M.S. and Scudder, G.G.E. (1970) The morphology and ultrastructure of the Malpighian tubules and hindgut in *Cenocorixa bifida* (Hung.) (Hemiptera, Corixidae). *Z. Morphol. Tiere* 68, 269–299.
- Jarial, M.S. and Scudder, G.G.E. (1971) Neurosecretion and water balance in *Cenocorixa bifida* (Hung.) (Hemiptera, Corixidae). *Can. J. Zool.* 49, 1369–1375.
- Jarial, M.S., Scudder, G.G.E. and Teraguchi, S. (1969) Observations on the labium of Corixidae (Hemiptera). *Can. J. Zool.* 47, 713–715.

- Jenkin, P.M. (1936) Reports on the Percy Sladen Expedition to some Rift Valley Lake in Kenya in 1929. III. Summary of the ecological results. *Ann. Mag. Nat. Hist.* (10)18, 133–181.
- Josifov, M. (1961) Die halobionten und halophilan Heteropteren an der Schwarzmeerküste. *Isr. Zool. Inst. Sof.* 10, 5–37.
- Kanyukova, E.V. (1973) K faune i biologii vodnykh klopov (Heteroptera) zapadnoi Sibiri. *Entomol. Obozr.* 52, 814–820.
- Karg, J. (1966) Pluskwiaki różnoskrzydłe (Heteroptera) wód okolic Gliwic i Rybnika. *Fragm. Faun.* 12, 281–307.
- Knowles, J.N. and Williams, W.D. (1973) Salinity range and osmoregulatory ability of Corixids (Hemiptera: Heteroptera) in south-east Australian inland waters. *Aust. J. Mar. Freshwater Res.* 24, 297–302.
- Komnick, H. and Wichard, W. (1975) Histochemischer Nachweis von Chloridzellen bei Wasserwanzen (Hemiptera: Hydrocorisae) und ihre feinstruktur bei *Hesperocorixa sahlbergi* Fieb. (Hemiptera: Corixidae). *Int. J. Insect Morphol. Embryol.* 4, 89–105.
- Lange, D. (1905) A remarkable flight of *Corisa 'water boatmen'*. *Can. Entomol.* 37, 364.
- Larsen, O. (1938) Untersuchungen über den Geschlechtsapparat der aquatilen Wanzen. *Opusc. Entomol. Suppl.* 1, 1–388.
- Leston, D. (1955) Miscellaneous biological notes on British Corixidae and Notonectidae (Hem.). *Entomol. Mon. Mag.* 91, 92–95.
- Lindberg, H. (1948) Zur Kenntnis der Insektenfauna im Brackwasser des Baltischen Meeres. *Commentat. Biol.* 10, 1–206.
- Macan, T.T. (1939) Notes on the migration of some aquatic insects. *J. Soc. Br. Entomol.* 2, 1–6.
- Macan, T.T. (1965) Predation as a factor in the ecology of water bugs. *J. Anim. Ecol.* 34, 691–698.
- Martin, N.A. (1970) The distribution and ecology of the Corixidae (Hemiptera - Heteroptera) in Leicestershire. *Trans. Leicester Lit. Phil. Soc.* 64, 101–121.
- Martin, N.A. (1975) Observations on the relationship between *Eylais* and *Hydrachna* (Acari: Hydracarina) and *Sigara* spp. (Insecta: Hemiptera: Corixidae). *N. Z. J. Zool.* 2, 45–50.
- Mitis, H. von (1936) Zur Biologie der Corixiden Stridulation. *Z. Morph. Oköl. Tiere* 30, 479–495.
- Munro, J.A. (1945) The birds of the Cariboo Parklands, British Columbia. *Can. J. Res. (D)* 23, 17–103.
- Nicol, E.A.T. (1935) The ecology of a salt marsh. *J. Mar. Biol. Assoc. U.K.* 20, 203–261.
- Nicol, E.A.T. (1936) The brackish-water lochs of North Uist. *Proc. R. Soc. Edin.* 56, 169–195.
- Nieser, N. (1966) Waterwantsen van Walcheren en Zuid-Beveland. *Zeepaard* 26(4) 63–84.
- Oloffs, P.C. and Scudder, G.G.E. (1966) The transition phenomenon in relation to the penetration of water through the cuticle of an insect, *Cenocorixa expleta* (Uhler). *Can. J. Zool.* 44, 621–630.
- Pajunen, V.I. (1970a) A case of mass flight of *Sigara nigrolineata* (Fieb.) (Heteroptera, Corixidae). *Ann. Zool. Fenn.* 7, 191–192.
- Pajunen, V.I. (1970b) Phenology of the arrest of ovarian maturation in rock pool corixids (Heteroptera, Corixidae). *Ann. Zool. Fenn.* 7, 270–272.
- Pajunen, V.I. (1970c) Adaptation of *Arctocorisa carinata* (Sahlb.) and *Callicorixa producta* (Reut.) populations to a rock pool environment. In: *Dynamics of Populations*. (P.J. den Boer and G.R. Gradwell, Eds.). *Proc. Adv. Study Inst. Dynamics Numbers Popul.* (Oosterneck, 1970) 148–158.
- Pajunen, V.I. and Jansson, A. (1969a) Seasonal changes in the sex ratio of rock pool corixids (Heteroptera, Corixidae). *Ann. Zool. Fenn.* 6, 219–226.
- Pajunen, V.I. and Jansson, A. (1969b) Dispersal of the rock pool corixids *Arctocorisa carinata* (Sahlb.) and *Callicorixa producta* (Reut.) (Heteroptera, Corixidae). *Ann. Zool. Fenn.* 6, 391–427.
- Pajunen, V.I. and Sundbäck, E. (1973) Effect of temperature on the development of *Arctocorisa carinata* (Sahlb.) and *Callicorixa producta* (Reut.) (Hemiptera, Corixidae). *Ann. Zool. Fenn.* 10, 372–377.

- Parsons, M.C. (1970) Respiratory significance of the thoracic and abdominal morphology of the three aquatic bugs *Ambrysus*, *Notonecta* and *Hesperocorixa* (Insecta, Heteroptera). *Z. Morphol. Tiere* 66, 242–298.
- Pearce, E.J. and Walton, G.A. (1939) A contribution towards an ecological survey of the aquatic and semi-aquatic Hemiptera-Heteroptera (water bugs) of the British Isles. *Trans. Soc. Br. Entomol.* 6, 149–180.
- Pearse, A.S. (1932) Animals in brackish water ponds and pools at Dry Tortugas. *Publ. Carnegie Inst.* 435, 125–142.
- Peters, W. (1949) Some transformations in asymmetry among Corixidae. *J. Morphol.* 84, 525–534.
- Peters, W. and Spurgeon, J. (1971) Biology of the water-boatman *Krizousacorixa femorata* (Heteroptera: Corixidae). *Am. Midl. Nat.* 86, 197–207.
- Peters, W. and Ulbrich, R. (1973) The life history of the water-boatman *Trichocorixella mexicana* (Heteroptera: Corixidae). *Can. Entomol.* 105, 277–282.
- Pinder, A.R. and Staddon, B.W. (1965a) The odoriferous secretion of the water bug, *Sigara falleni* (Fieb.) *J. Chem. Soc.* 530, 2955–2958.
- Pinder, A.R. and Staddon, B.W. (1965b) Trans-4-oxohex-2-enal in the odoriferous secretion of *Sigara falleni* (Fieb.) (Hemiptera-Heteroptera). *Nature* 205, 106–107.
- Poisson, R. (1923) Accouplement, ponte et eclosion chez les Hémiptères aquatiques. *Bull. Biol. Fr. Belg.* 57, 89–97.
- Poisson, R. (1924) Contribution a l'étude des Hemipteres Aquatiques. *Bull. Biol. Fr. Belg.* 58, 49–305.
- Poisson, R. (1935) Les Hémiptères aquatiques, Sandaliorrhyncha Börn, de la fauna Française. *Arch. Zool. Exp. Gen.* 11, 455–563.
- Poisson, R., Richard, G. and Richard, G. (1958) Contribution a l'étude de l'essaimage des Corixidae (Hémiptères Hétéroptères Aquatiques). *Vie et Milieu* 8, 243–252.
- Polhemus, J.T. and Hendrickson, J.R. (1974) The occurrence of *Trichocorixa reticulata* in the Gulf of California (Hemiptera: Corixidae). *Pan-Pac. Entomol.* 50, 52.
- Popham, E.J. (1942) The variation in the colour of certain species of *Arctocorisa* (Hemiptera, Corixidae) and its significance. *Proc. Zool. Soc. Lond.* 111(A) 135–172.
- Popham, E.J. (1943a) Further experimental studies on the selective action of predators. *Proc. Zool. Soc. Lond.* 112, 105–117.
- Popham, E.J. (1943b) Observations on the migration of Corixidae (Hemiptera, Heteroptera). *Entomologist* 76, 117–122.
- Popham, E.J. (1944) A study of the changes in the aquatic insect population, using minnows as predators. *Proc. Zool. Soc. Lond.* 114, 74–81.
- Popham, E.J. (1947) Ecological studies on the mating habits of certain species of Corixidae and their significance. *Proc. Zool. Soc. Lond.* 116, 692–706.
- Popham, E.J. (1951) A study of the changes of the water bug fauna of North Surrey from 1946–1950, with special reference to the migration of Corixidae. *J. Soc. Br. Entomol.* 3, 268–273.
- Popham, E.J. (1952) Notes on Corixid bionomics (Hemiptera Heteroptera). *Entomologist* 85, 73–77.
- Popham, E.J. (1959) Respiration of Corixidae (Hemiptera-Heteroptera). *Nature* 183, 914.
- Popham, E.J. (1960) On the respiration of aquatic Hemiptera Heteroptera with special reference to the Corixidae. *Proc. Zool. Soc. Lond.* 135, 209–242.
- Popham, E.J. (1961) The function of the paleal pegs of Corixidae (Hemiptera: Heteroptera). *Nature* 190, 742.
- Popham, E.J. (1964) The migration of aquatic bugs with special reference to the Corixidae (Hemiptera, Heteroptera). *Arch. Hydrobiol.* 60, 450–496.
- Popov, Y.A. (1971) Historical development of Hemiptera Infraorder Nepamorpha (Heteroptera). *Trudy Paleontol. Inst.* 129, 1–228 (In Russian).

- Rahn, H. and Paganelli, C.V. (1968) Gas exchange in gas gills of diving insects. *Resp. Physiol.* 5, 145–164.
- Rawson, D.S. and Moore, J.E. (1944) The saline lakes of Saskatchewan. *Can. J. Res. (D)* 22, 141–201.
- Remold, H. (1963) Scent-glands of land bugs, their physiology and biological function. *Nature* 198, 764–768.
- Reynolds, J.D. (1974) Aspects of the ecology of two species of *Cenocorixa* (Corixidae: Hemiptera) in allopatry and sympatry. (Ph.D. diss. , .)
- Reynolds, J.D. (1975) Feeding in Corixids (Heteroptera) in small alkaline lakes of central B.C. *Verh. Int. Verein. Theor. Angew. Limnol.* 19, 3073–3078.
- Richard, G. (1961) Observations nouvelles sur les migrations d'insectes hétéroptères Corixidae. *Verh. Int. Verein. Theor. Angew. Limnol.* 14, 995–998.
- Richard-Vindard, G. (1967) Quelques observations sur les vols migratoires de Corixidae en pays tropicaux. *Verh. Int. Verein. Theor. Angew. Limnol.* 16, 1691.
- Sailer, R.I. (1948) The genus *Trichocorixa* (Corixidae, Hemiptera). *Kans. Univ. Sci. Bull.* 32, 289–407.
- Savage, A.A. (1971a) Some observations on the annual cycle of *Sigara concinna* (Fieber) (Hemiptera - Heteroptera). *Entomologist* 104, 230–232.
- Savage, A.A. (1971b) The Corixidae of some inland saline lakes in Cheshire, England. *Entomologist* 104, 331–344.
- Schwarz, E.A. (1891) Preliminary remarks on the insect fauna of the Great Salt Lake, Utah. *Can. Entomol.* 23, 235–241.
- Scudder, G.G.E. (1964) Wing muscle polymorphism in *Cenocorixa*. *Am. Zool.* 4, 331.
- Scudder, G.G.E. (1965) The distribution and physiology of some lake Corixidae. *Proc. XII Int. Congr. Entomol.* 410–411.
- Scudder, G.G.E. (1966) The immature stages of *Cenocorixa bifida* (Hung.) and *C. expleta* (Uhler) (Hemiptera: Corixidae). *J. Entomol. Soc. B.C.* 63, 33–40.
- Scudder, G.G.E. (1969a) The distribution of two species of *Cenocorixa* in inland saline lakes of British Columbia. *J. Entomol. Soc. B.C.* 66, 32–41.
- Scudder, G.G.E. (1969b) The fauna of saline lakes on the Fraser Plateau in British Columbia. *Verh. Int. Verein. Theor. Angew. Limnol.* 17, 430–439.
- Scudder, G.G.E. (1971a) The osmoregulation and distribution of two species of *Cenocorixa* (Hemiptera). *Proc. XIII Int. Congr. Entomol.* 1, 555–556.
- Scudder, G.G.E. (1971b) The postembryonic development of the indirect flight muscles in *Cenocorixa bifida* (Hung.) (Hemiptera: Corixidae). *Can. J. Zool.* 49, 1387–1398.
- Scudder, G.G.E. (1975a) Field studies on the flight muscle polymorphism in *Cenocorixa* (Hemiptera: Corixidae). *Verh. Int. Verein. Theor. Angew. Limnol.* 19 3064–3072.
- Scudder, G.G.E. (1975b) The first record of marine Corixidae (Heteroptera) in British Columbia. (.)
- Scudder, G.G.E., Jarial, M.S. and Choy, J. (1972) Osmotic and ionic balance in two species of *Cenocorixa* (Hemiptera). *J. Insect Physiol.* 18, 883–895.
- Scudder, G.G.E. and Meredith, J. (1972) Temperature-induced development in the indirect flight muscles of adult *Cenocorixa* (Hemiptera: Corixidae). *Dev. Biol.* 29, 330–336.
- Short, J.R.T. (1953) On the musculature of the legs of *Corixa punctata* (Illig.) Hemiptera. *Proc. R. Entomol. Soc. Lond. (A)* 28, 31–35.
- Sokol'skaya, N.P. and Zhiteneva, L.D. (1973) A contribution to the biology of Corixidae (Heteroptera), pests of fish culture in the Rostov District. *Zool. Zh.* 52, 1330–1334.
- Southwood, T.R.E. (1962) Migration of terrestrial Arthropods in relation to habitat. *Biol. Rev.* 37, 171–214.
- Southwood, T.R.E. and Leston, D. (1959) Land and Water Bugs of the British Isles. (.)



- Staddon, B.W. (1964) Water balance in *Corixa dentipes* (Thoms.) (Hemiptera, Heteroptera). J. Exp. Biol. 41, 609–619.
- Staddon, B.W. (1966) The permeability to water of the cuticles of some adult water bugs. J. Exp. Biol. 44, 69–76.
- Stichel, W. (1955) Illustrierte Bestimmungstabellen der Wanzen II. Europa (Hemiptera - Heteroptera Europae). Heft 2–3, 33–96.
- Sutton, M.F. (1947a) The life-history of *Corixa panzeri* Fieb. Proc. Linn. Soc. Lond. 158, 51–62.
- Sutton, M. (1947b) Feeding mechanism of water-bugs. Nature 160, 122.
- Sutton, M.F. (1951) On the food, feeding mechanism and alimentary canal of Corixidae (Hemiptera, Heteroptera). Proc. Zool. Soc. Lond. 121, 465–499.
- Swanson, S.M. (1975) The distribution of Corixidae (Hemiptera) in the saline lakes of Saskatchewan. .
- Thorpe, W.H. (1926) Cambridge Expedition to the Suez Canal, 1924. XXXII. Report on the Brackish Water Insects. Trans. Zool. Soc. Lond. 22, 447–449.
- Tones, P.I. (1975) Life cycle of the waterboatman, *Trichocorixa verticalis interiores* Sailer with special reference to diapause. .
- Tones, P.I. and Hammer, U.T. (1975) Osmoregulation in *Trichocorixa verticalis interiores* Sailer (Hemiptera, Corixidae) - an inhabitant of Saskatchewan saline lakes, Canada. Can. J. Zool. 53, 1207–1212.
- Usinger, R.L. (Ed.) (1956) Aquatic Insects of California, with Keys to North American Genera and California Species. (, )
- Walton, G.A. (1943) The water-bugs (Rhynchota-Hemiptera) of North Somerset. Trans. Soc. Br. Entomol. 8, 231–290.
- Wilson, C.A. (1958) Aquatic and semiaquatic Hemiptera of Mississippi. Tulane Stud. Zool. 6(3) 115–170.
- Young, E.C. (1961) Degeneration of flight-musculature in the Corixidae and Notonectidae. Nature 189, 328–329.
- Young, E.C. (1964) Notes on Corixidae (Hem.) in northern Scotland. Entomol. Mon. Mag. 99, 68–71.
- Young, E.C. (1965a) The incidence of flight polymorphism in British Corixidae and description of the morphs. J. Zool. 146, 567–576.
- Young, E.C. (1965b) Flight muscle polymorphism in British Corixidae: ecological observations. J. Anim. Ecol. 34, 353–390.
- Young, E.C. (1966) Observations on migration in Corixidae (Hemiptera: Heteroptera) in southern England. Entomol. Mon. Mag. 101, 217–229.
- Zwart, K.W.R. (1965) On the influence of some food substances on survival of Corixidae (Heteroptera). Proc. XII Int. Congr. Entomol. 411–412

## Marine caddis flies (Trichoptera: Philanisidae)

J.P. Leader

<b>Contents</b>		
11.1	Introduction	291
11.2	Systematics	292
11.3	General morphology	292
	11.3.1 Adult	292
	11.3.2 Larva	294
	11.3.3 Pupa	295
11.4	Biology	296
	11.4.1 Life history	296
	11.4.2 Food	298
	11.4.3 Predators and parasites	298
11.5	Ecology	298
	11.5.1 Respiratory adaptations	298
	11.5.2 Osmotic and ionic regulation	299
References		301

### 11.1 INTRODUCTION

The Order Trichoptera, or caddis flies, comprises a relatively small group, about 5000 species, of small to medium-sized, hairy, moth-like insects. The adults are short-lived and often obscurely coloured, and their habit of remaining concealed during daylight hours, flying at dawn or dusk, means that they are infrequently encountered. Thus, the Order is more popularly known from its aquatic larval stages, caddis worms, many of which construct and inhabit cases made of stones, sticks, vegetable matter, or occasionally mollusc shells.

Adult caddis flies may be distinguished from the Lepidoptera, which they

closely resemble, chiefly by the structure of the mouthparts, and the wing venation. Larval caddis flies differ from immature Lepidoptera in that they bear no abdominal prolegs, other than those on the terminal abdominal segment, and do not possess spiracles. Pupal Trichoptera are also aquatic, usually with stout biting mandibles, which are used in escaping from the pupal retreat, and generally have strong hairy fringes on the legs and abdomen to assist in swimming to the water surface prior to the final ecdysis.

Only two species of Trichoptera are known to occur in water having a salt concentration much greater than that of freshwater. All other caddis larvae investigated live in water having a salinity less than 1 ppt NaCl, and die rapidly if exposed to concentrations higher than this (Sutcliffe, 1961b). Larvae of *Limnephilus affinis* (Curtis) are found in saltmarsh pools on the coasts of Britain (Sutcliffe, 1960), and are capable of tolerating salinities up to 24 ppt NaCl (75% seawater). Larvae of the marine caddis fly, *Philanisus plebeius* (Walker) (McLachlan, 1882; Hudson, 1904) are found in rock pools on the coasts of New Zealand, the Chatham Islands and the southeast coast of Australia. These two species show qualitatively and quantitatively different mechanisms of adaptation to the problems associated with survival in a saline habitat. This account will be concerned largely with the adaptations shown by the larval stages of *Philanisus plebeius*; reference will be made to differences between *Philanisus* and *Limnephilus affinis* where appropriate.

## 11.2 SYSTEMATICS

The Family Philanisidae was erected by Mosely and Kimmins (1953) to accommodate the single species *Philanisus plebeius* (Walker). It closely resembles the Sericostomatidae in wing venation, number of spurs on the legs, and the morphology of the maxillary palps of the male; but differed from it in that the male maxillary palp was 5- rather than 3-jointed. Recent studies (Ross, 1967; Riek, 1970) using other morphological characters in determining systematic relationships within the Trichoptera, such as the distribution of scutal warts and bristles of the adults and the immature stages, have justified the isolation of the unique species *Philanisus plebeius* in the Family Philanisidae.

## 11.3 GENERAL MORPHOLOGY

### 11.3.1 Adult (Fig. 11.1)

The adults are light yellow-brown, clothed with tawny hairs with yellow hairy antennae which are longer than the body. The maxillary palps of the male are of characteristic shape (Fig. 11.2).

The genitalia of the male and female are illustrated in Figs 11.3–11.5. The males are 6–9 mm long with wing lengths of 5–7 mm; females are 7–10 mm long with wing lengths of 6–10 mm.

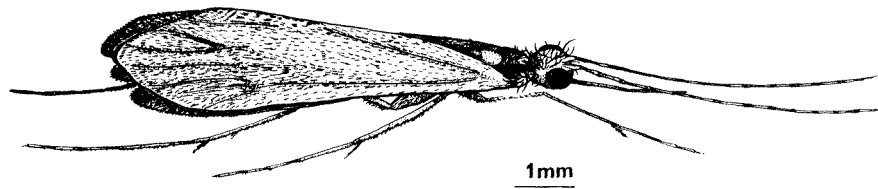

Fig. 11.1. Adult *Philanisus plebeius*.

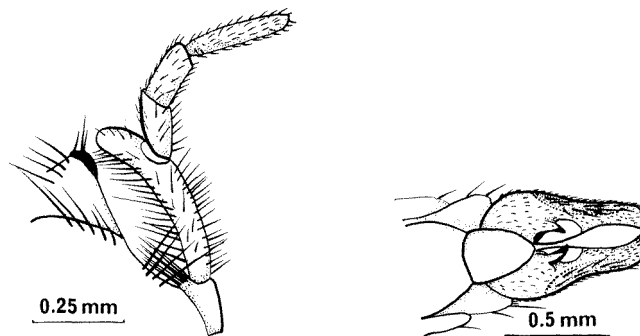

Fig. 11.2. (Left) Maxillary palps of *Philanisus plebeius* (adult male).

Fig. 11.3. (Right) Genitalia of adult *Philanisus plebeius* (male, ventral).

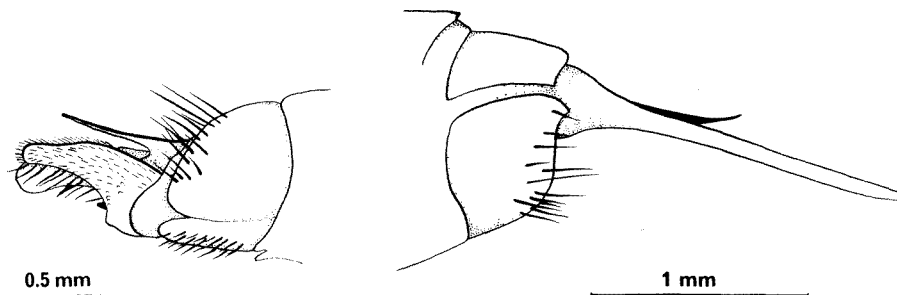

Fig. 11.4. (Left) Genitalia of adult *Philanisus plebeius* (male, lateral).

Fig. 11.5. (Right) Genitalia of adult *Philanisus plebeius* (female, lateral).

### 11.3.2 Larva (Fig. 11.6)

The larva is pale green in colour with brown sclerotized portions. Eruciform, abdomen cylindrical and slightly tapering.

There are many large bristles on the anterior surface of head, particularly near the dorsal apotome. The antennae are one-jointed, small and inconspicuous. Eyes are low down on the antero-lateral part of the head, black, surrounded by a ring of clear cuticle. The mandibles (Fig. 11.7) are symmetrical, deep brown, with a few blunt teeth on the inner edge, an inner bunch of short bristles, and a few longer bristles on the outer face. The maxillae and labium (Fig. 11.8) are short and fleshy; maxillary palp is large and closely adpressed to the maxillary lobe, which bears three spines on its inner border. Labium with a large fleshy lobe overlying the small labial palps.

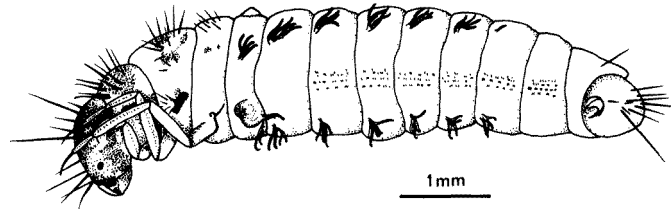

Fig. 11.6. Larva of *Philanisus plebeius*.

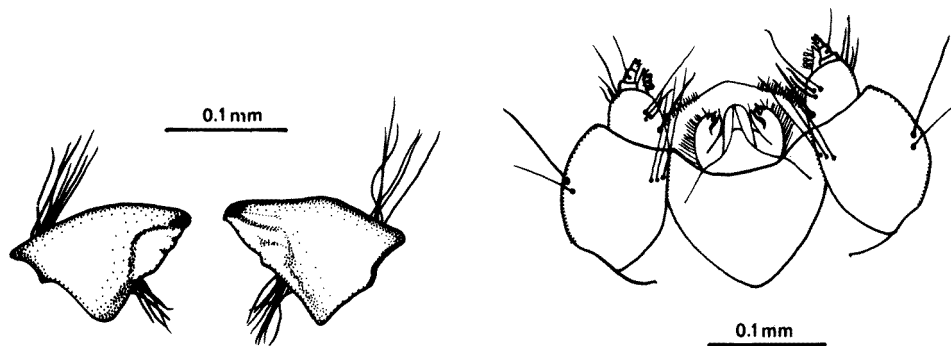

Fig. 11.7. (Left) Mandibles of the larva of *Philanisus plebeius*.

Fig. 11.8. (Right) Maxillae and labium of the larva of *Philanisus plebeius*.

The pronotum is entirely sclerotized, dark brown with white spots, bearing bristles mainly projecting forwards. Meso- and meta-nota pale, with dark brown regions bearing bristles. Meso- and meta-sterna unsclerotized, green.

Legs are pale brown; claws and base of tarsi darker. Anterior leg short and thick; coxa, trochanter and femur about equal size. Median leg more slender and

longer; posterior leg longest. All legs bear numerous bristles and spines particularly ventrally.

Abdomen pale green; first segment with three low humps. Small bundles of tracheal gills occur in two rows on abdominal segments 1–7, the dorso-lateral series and the ventral series. The lateral fringe of bristles found frequently on other caddis larvae is represented in *Philanisis* only by a series of small inconspicuous bristles on segments 3–8. The anal prolegs (Fig. 11.9) are short, 2-segmented, with a stout strongly sclerotized claw bearing a small spine on the outside.

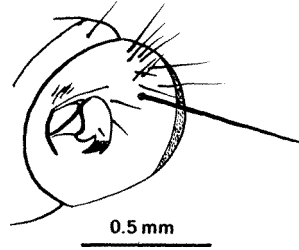

Fig. 11.9. Anal pro-legs of the larva of *Philanisis plebeius*.

### 11.3.3 Pupa (Fig. 11.10)

The early pupa is pale green, exarate, decticious; although in later pupae the colour and markings of the pharate adult can be clearly seen. Pupal mandibles are symmetrical, long, with many fine teeth on the inner face. Labrum with many stout, anteriorly directed bristles. Antennae and wings reaching to mid-abdomen. Abdomen with sclerotized hook-bearing plates on segments 2–6; plate 2 with 5–7 small teeth, all others with three teeth. Tip of abdomen terminates in a conical tube from which emerges a pair of outwardly curving projections. Length of pupa, 5–10 mm.

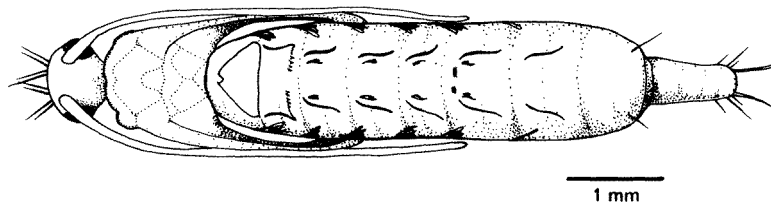

Fig. 11.10. Pupa of *Philanisis plebeius*.

## 11.4 BIOLOGY

### 11.4.1 Life history

The biology of *Philaniscus* has been described by Hudson (1904). He noted that in Wellington Harbour, New Zealand, the adult insect appears about January; although larvae may be found throughout the year. In the Auckland region (latitude 37° S), adults fly at all times of the year on sunny days, and may be taken in a light trap during nights when there is little wind. In general, adults captured during the winter months are smaller, however most adults are captured between January and March, which probably represents the main flight period. Adults of both sexes remain close to the tidal fringe, sheltering in cracks and crevices on the lee side of rocks. When disturbed by a shadow or a puff of wind, they run rapidly over the rocks or fly erratically close to the ground, making capture difficult. Mating takes place at all times of day with little preamble. Generally pairing of the sexes occurs when one insect running over the rocks, meets a member of the opposite sex sheltering in a crevice. After brief foreplay, involving touching of the antennae, and perhaps release of a pheromone from the scent scales of the male maxillary palps, the two mate and separate rapidly.

Unlike most Trichoptera, where the eggs are laid in batches of one hundred or more enclosed within a gelatinous matrix, *Philaniscus* probably deposits its eggs singly. Although no eggs have been seen in the field, gravid females can often be seen landing on the edge of tide pools and inserting the ovipositor beneath the surface for a few seconds, then flying a short distance to another site and repeating the process. Dissection of gravid females captured during this behaviour reveals a string of eggs in the oviduct, separated from each other and lacking the thick gelatinous coat.

Young larvae make a case soon after hatching, using any material readily available. The early case is made mainly of silk secreted by the larvae, to which is attached small flat sand grains; later, as the larvae grows, the case is enlarged by the addition of other material. Typically the larva selects pieces of a coralline alga, *Corallina officinalis*, biting off suitable lengths and arranging them in a semispiral fashion to give the case the appearance of a dorsally crested cornucopia (Fig. 11.11). In areas where the coralline growth is sparse, the larva may construct a case chiefly of flat grains of sand, and the case may then be straight and square in cross-section, not unlike that made by larvae of the Family Lepidostomatidae. In mid-summer, larvae may sometimes be found in large numbers in rock pools near the high-water mark, where they feed on growths of the soft brown alga, *Ectocarpus confervoides*, and use this material also for case construction. The case then is curved, weak and flexible.

The duration of the larval development may depend markedly upon the ambient temperature and the availability of food. Small larvae (cases about

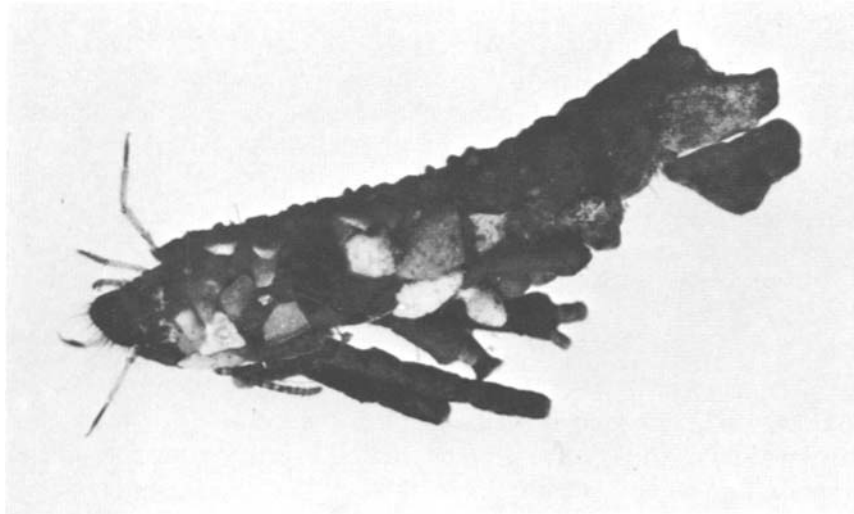

Fig. 11.11. Case and larva of *Philanisus plebeius* (photograph by G.W. Batt).

1 mm long) complete their development in the laboratory at 20–21°C, producing medium-sized adults in about six weeks. On the other hand, full grown larvae may be kept in the laboratory for several weeks without pupation taking place if the temperature is held near 10°C. The onset of pupation may also be delayed by starvation. In the field the size of larvae at pupation, and hence the size of the adults, is quite variable. This fact, together with the presence of larvae of all sizes at all times, makes the number of larval instars difficult to determine.

When about to pupate, the larva crawls to the base of the coralline stems on which it is feeding, and attaches the case to the substrate at both ends with silk. Pupal cases never have a dorsal crest of coralline so it is presumed that this is removed. The anterior end of the case is then sealed with loosely woven silk and the larva adopts a prepupal resting position before ecdysis. Cases opened in the laboratory indicate that this stage lasts at least 24 hours. The total period spent within the pupal case is 5–7 days at 20°C. At the end of this period the pharate adult bites through the anterior portion of the case with its pupal mandibles, swims to the surface and rapidly undergoes a final ecdysis. The adult is capable of flight immediately after emergence, and can, if prevented from reaching land, ecdyse and fly from open water. It is not known whether emergence is synchronized to tidal movements.

The length of adult life appears to be only a few days. They succumb rapidly to dehydration after capture, a fact which led Riek (1970) to suggest that they remain near the intertidal region to take advantage of the high humidity there.



### 11.4.2 Food

The adult has never been seen to feed, although its mouthparts, as with most other Trichoptera, suggest that it might be capable of imbibing liquids. The normal diet of the larva is the coralline alga, *Corallina officinalis*, which grows densely in the intertidal region of the New Zealand rocky coast. However, they will feed on other algae (e.g., *Ectocarpus confervoides*). They have occasionally been seen to attack and eat each other if over-crowded.

### 11.4.3 Predators and parasites

Larvae of *Philanisus plebeius* appear to have few predators, although they have been recorded in the stomach contents of fish. It is not entirely clear whether this was adventitious, since they are generally found together with coralline algae. The larva has an adequate defence against most invertebrate predators by retreating into its protective case. Adults probably form a component of the diet of insectivorous birds (e.g., fantail, *Rhipidura fuliginosa placabilis*).

No parasites have been recorded from marine caddis larvae.

## 11.5 ECOLOGY

*Philanisus plebeius* larvae are found in intertidal rock pools, generally on sheltered coasts, although they may be found in a wide range of situations where coralline algae occur. They cling to the fronds tightly if an attempt is made to dislodge them, either by touch or with a water current. Consequently the patchy distribution which the larvae show on a shore is probably not a consequence of tidal flow. Nonetheless, during the summer months some larvae may crawl or be swept far from their original location by tidal activity. They may be carried below the low tide level, where they have been found by divers (Russell, personal communication), or left stranded by the tide on drained sheets of coralline on rock faces. Under these circumstances they may be exposed to high temperatures (up to 40°C) at the northern end of its range, or low temperatures (down to 0°C) at the southern end. Similarly it may be left in seawater concentrated by evaporation or diluted by rainfall.

### 11.5.1 Respiratory adaptations

Leader (1971) found that the respiratory activity was at a maximum in normal well oxygenated seawater at 20°C. When temperature, salinity or oxygen concentration was changed the respiratory activity was reduced. Under these conditions, uptake of oxygen was normally achieved by passing a current of water

over the abdominal gills by means of rhythmic undulations of the abdomen. Under adverse conditions the larva was found to grip any available substrate with its legs and contract the abdomen, so that the case was drawn tightly against the substrate. Respiratory activity ceased almost completely. The larva was capable of remaining in this position for many hours. Thus, temporary adverse conditions of low oxygen concentration or extremes of salinity could be avoided. Wilcox (1969) found a similar mechanism to exist in the larva of the leptocerid caddis fly, *Triplectides obsoleta* (McLachlan). This normally freshwater larva is sometimes found in estuaries in New Zealand, in regions where freshwater is replaced by saline water as the tide flows in. It has been shown experimentally that the larva is rapidly killed if removed from its case and immersed in saline water (7.5 ppt NaCl). Nevertheless the insect can tolerate this concentration in the field, presumably by withdrawing into its case and building up an oxygen debt.

Shutting itself within the case also provides a possible mechanism for with-standing high temperatures. When the animal is emerged, the larval case is left full of water. Evaporation of water through the surface of the case might be expected to keep the animal cool when exposed to heat. Larvae have been found to withstand temperatures up to 40°C for periods up to two hours when out of water, a temperature which is lethal if they are immersed.

### 11.5.2 Osmotic and ionic regulation

In addition to these short term survival mechanisms, the larva is capable of regulating the osmotic strength and ionic composition of its haemolymph to a marked degree (Fig. 11.12). Leader (1972) found that the haemolymph of larvae taken from seawater has an osmotic pressure equivalent to a 202 mM sodium chloride solution. This is only slightly higher than that of typical freshwater caddis larvae and contains a higher proportion of sodium and chloride ions. The body surface is likewise no more permeable to water than that of typical freshwater caddis larvae. Shaw and Stobart (1963) predicted that the permeability of the cuticle of marine insects to water would prove to be an order of magnitude less than that of related freshwater forms, and this has been shown to hold for mosquito larvae (Nicolson and Leader, 1974). Hinton (1953) however, pointed out that no insect, or for that matter any other animal, has evolved a membrane which is permeable to oxygen and at the same time impermeable to water. Thus *Philanisus* larvae, which takes up dissolved oxygen through the body surface via the abdominal tracheal gills, may be limited to the degree of reduction of water permeability which can be achieved. Air-breathing dipterous larvae found in the marine environment face no such limits as they possess relatively impermeable cuticle.

When *Philanisus* larvae are prevented from imbibing seawater by means of a neck ligature, about 10% of the body weight may be lost per day through

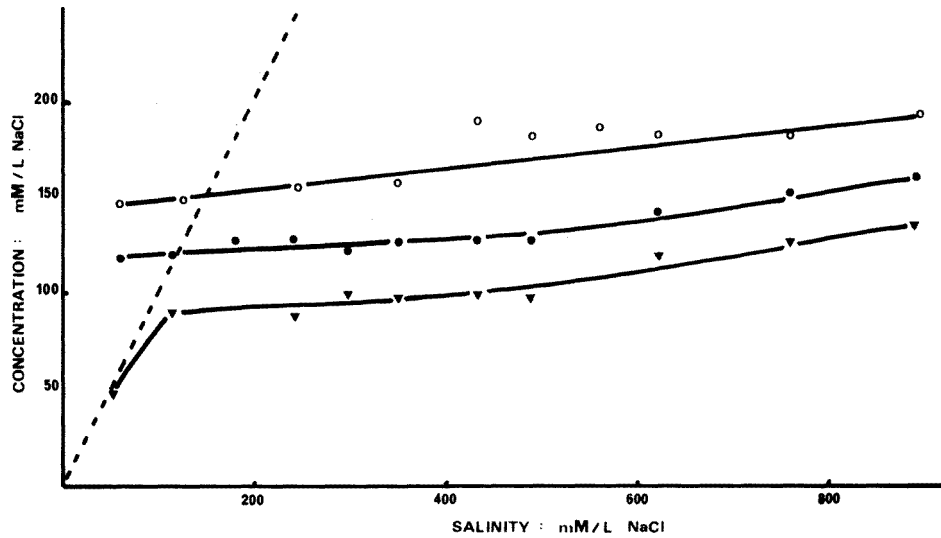

Fig. 11.12. The relation between the salinity of the external medium and the concentration of ions in the haemolymph of the larva of *Philanisus plebeius*. ○, osmotic pressure of the haemolymph (expressed as an equivalent mM solution of NaCl); ●, Na<sup>+</sup> concentration (mM/l); ▼, Cl<sup>-</sup> concentration (mM/l). Each point represents the mean of values of 5–18 larvae. Haemolymph values in normal (606 mM/l) sea water: osmotic pressure = 202 ± 19 mM/l; Na<sup>+</sup> = 166 ± 23 mM/l; Cl<sup>-</sup> = 144 ± 16 mM/l.

the outward loss of water by osmosis. Larvae without a ligature have been shown to imbibe a quantity of seawater equivalent to about 25% of the body weight per day. It has often been postulated that hypo-osmotic regulation is generally achieved by oral intake of the medium, and excretion of a hypertonic urinary fluid, the difference in concentration of the two fluids providing a small quantity of 'osmotically free' water which replaces that lost by osmosis across the body surface (Smith, 1969). Although *Philanisus* excretes a rectal fluid which is hypertonic to the haemolymph, the fluid is still hypotonic to the medium. Thus, it becomes necessary to postulate for this animal an extra-renal site of ion excretion, since otherwise the haemolymph concentration would rapidly rise. Such a site must lie on the general body surface. Larval Trichoptera are known to have ion-permeable areas on the body surface (Nuske and Wichard, 1971, 1972; Wichard and Komnick, 1973) although a role for these in ion transport has yet to be demonstrated.

Measurements of the electrical potential across the body surface of *Philanisus* in seawater indicates that both sodium and chloride ions are far from being in electrochemical equilibrium, and it is necessary therefore to postulate that both these ions are subject to active transport out of the body. Interestingly, such a mechanism seems to be reversible in this insect, since larvae transferred to dilute

solutions of seawater are capable of hyperosmotic regulation. Although the rectal fluid in these animals is hypotonic to the haemolymph, it is hypertonic to the medium. In this situation there must be an active inward transport of ions across the body surface.

It is of interest to compare the mechanism of ionic and osmotic regulation of *Philaniscus plebeius* with that of *Limnephilus affinis*, found in saltmarsh pools on the coast of Britain where it may be exposed periodically to high salinities. The osmoregulatory capacity of this insect was investigated by Sutcliffe (1961a,b, 1962). He found that in marked contrast to other trichopteran larvae tested by him, *Limnephilus* was capable of survival in salinities up to 24 ppt NaCl. The osmotic pressure of the haemolymph increased markedly as the external salinity increased, although an increasing proportion of this was accounted for by organic components. At high salinities, the sodium and chloride concentrations of the haemolymph were maintained at a lower level than in the medium. The larvae were found to imbibe the medium and excrete a fluid which was slightly hypertonic to the medium, though differing widely in composition. The body wall was very permeable to water, but highly impermeable to ions. In contrast to *Philaniscus* it appears that *Limnephilus* was able to endure high salinities by tolerating an increased osmotic pressure of the haemolymph. At salinities above 24 ppt NaCl however, this capacity is exceeded and the larva rapidly dies.

The adaptations shown by *Limnephilus affinis* can be considered as a relatively simple mechanism for overcoming osmotic problems posed by an environment which can be expected to undergo violent fluctuations in salinity after heavy rainfall or during long dry periods. In marked contrast to this, *Philaniscus plebeius* cannot survive in freshwater long enough to complete its development. Those changes which have permitted invasion of a marine habitat are not completely reversible.

The small number of Trichoptera found in saline waters may emphasize the osmoregulatory problems associated with the necessary requirement of a permeable surface for uptake of dissolved oxygen. This small group well deserves further study, in particular with regard to the behavioural modifications associated with survival in a marine habitat.

## REFERENCES

- Hinton, H.E. (1953) Some adaptations of insects to environments that are alternately dry and flooded, with some notes on the habits of the Stratiomyidae. *Trans. Soc. Br. Entomol.* 11, 209–227.
- Hudson, G.V. (1904) *New Zealand Neuroptera.* ( )
- Leader, J.P. (1971) Effect of temperature, salinity, and dissolved oxygen concentration upon respiratory activity of the larva of *Philaniscus plebeius* (Trichoptera). *J. Insect Physiol.* 17, 1917–1924.
- Leader, J.P. (1972) Osmoregulation in the larva of the marine caddis fly, *Philaniscus plebeius* (Walk.) (Trichoptera). *J. Exp. Biol.* 57, 821–838.

- McLachlan, R. (1882) On a new caddis fly from New Zealand. J. Linn. Soc. (Zool.) 17, 417–422.
- Mosely, M.E. and Kimmins, D.E. (1953) The Trichoptera (caddis-flies) of Australia and New Zealand. (, )
- Nicolson, S.W. and Leader, J.P. (1974) The permeability to water of the cuticle of the larva of *Opifex fuscus* (Hutton) (Diptera, Culicidae). J. Exp. Biol. 60, 593–603.
- Nuske, H. and Wichard, W. (1971) Die Analpapillen der Kocherfliegenlarven. I. Feinstruktur und histochemischer Nachweis von Natrium und Chlorid bei *Philopotamus montanus* Donovan. Cytobiologie 4, 480–486.
- Nuske, H. and Wichard, W. (1972) Die Analpapillen der Kocherfliegenlarven. II. Feinstruktur des ionentransportierenden und respiratorischen Epithels bei Glossosomatiden. Cytobiologie 6, 243–249.
- Riek, E.F. (1970) Trichoptera. In: The Insects of Australia. (, )
- Ross, H.H. (1967) The evolution and past dispersal of the Trichoptera. Annu. Rev. Entomol. 12, 169–206.
- Smith, P.G. (1969) The ionic relations of *Artemia salina* (L.). I. Measurement of electrical potential difference and resistance. J. Exp. Biol. 51, 727–738.
- Shaw, J. and Stobart, R.H. (1963) Osmotic and ionic regulation in insects. Adv. Insect Physiol. 1, 315–399.
- Sutcliffe, D.W. (1960) Osmotic regulation in the larvae of some euryline Diptera. Nature 187, 331–332.
- Sutcliffe, D.W. (1961a) Studies on salt and water balance in caddis larvae (Trichoptera). I. Osmotic and ionic regulation of body fluids in *Limnephilus affinis* Curtis. J. Exp. Biol. 38, 501–519.
- Sutcliffe, D.W. (1961b) Studies on salt and water balance in caddis larvae (Trichoptera). II. Osmotic and ionic regulation of body fluids in *Limnephilus stigma* Curtis and *Anabolia nervosa* Leach. J. Exp. Biol. 38, 521–530.
- Sutcliffe, D.W. (1962) Studies on salt and water balance in caddis larvae (Trichoptera). III. Drinking and excretion. J. Exp. Biol. 39, 141–160.
- Wichard, W. and Komnick, H. (1973) Fine structure and function of the abdominal chloride epithelia in caddisfly larvae. Z. Zellforsch. Mikrosk. Anat. 136, 579–590.
- Wilcox, C.R. (1969) The Physiological Ecology of *Triplectides obsoleta*. (M.Sc. thesis, , )

## Saltmarsh mosquitoes (Diptera: Culicidae)

George F. O'Meara

12.1	Introduction	303
12.2	Systematics	304
	12.2.1 General characteristics of mosquitoes	304
	12.2.2 Genera of tideland mosquitoes	305
	12.2.3 Special systematic problems of cryptic species	305
12.3	Larval habitats	307
12.4	Oviposition behaviour	307
12.5	Life history and ecology	308
	12.5.1 The egg	308
	12.5.2 Larvae and larval feeding patterns	311
	12.5.3 Pupae	315
	12.5.4 Adult behaviour	316
12.6	Medical and economic importance	322
12.7	Control	322
	12.7.1 Mosquito control problems in Florida	322
	12.7.2 Recent developments of control measures	326
References		327

### 12.1 INTRODUCTION

In coastal areas such as saltmarshes and mangrove swamps, many species of adult mosquitoes are often found but collections of mosquito larvae and pupae from habitats that are occasionally flooded by tides and rains yield far fewer species. Although less than 5% of some 2500 described mosquito species regularly breed in brackish waters, they represent a rather diverse group of species. Our

knowledge of the different life histories of these mosquitoes is somewhat limited since most studies have been confined to species which are of medical or economic importance. However, basic research on tideland mosquitoes has made considerable contributions to mosquito control endeavours in many areas. Several of the standard techniques currently used for mosquito control were originally developed for reducing the densities of tideland species. Ongoing research on the development of improved methods for physical, chemical and biological control of mosquitoes continues to utilize tideland mosquitoes as the test species. Large-scale control programs have been carried out against certain saltmarsh mosquitoes and in some cases these efforts have drastically altered the ecology of the tidelands. Escalating costs and increasing concern over the total environment have created a dire need for cheaper and safer methods for controlling these insects.

This chapter will stress the differences in behaviour, development and physiology among tideland mosquitoes. The treatment is by no means complete but rather it highlights some of the contrasting patterns and suggests areas where additional research is needed. Control methodologies are described with particular emphasis given to the relative effectiveness and ecological consequences of each technique. Prospects for the development of new techniques are also evaluated. Because I am most familiar with the biology of tideland mosquitoes of the southeastern portion of the United States, a disproportionate share of the information in this chapter will pertain to *Aedes sollicitans* (Walker) and *Aedes taeniorhynchus* (Wiedemann), two of the more serious pest species of this region.

In this chapter, the tidelands are defined as littoral lands that are overflowed by the tide but normally exposed during low water conditions. Portions of salt-marshes, mangrove swamps and rocky shores can be grouped together as tidelands.

## 12.2 SYSTEMATICS

### *12.2.1 General characteristics of mosquitoes*

Mosquitoes belong to the family Culicidae of the dipteran suborder Nematocera. Their larvae are always aquatic and can be distinguished from all other dipteran larvae by the possession of a complete head capsule and the presence of only one pair of functional spiracles, located on the dorsal portion of the eighth abdominal segment. As adults, mosquitoes can be distinguished from other dipterous insects by their characteristic venation and scaling on the wings. Scales are also frequently present on the thorax, abdomen, head and legs. Although mosquitoes have elongated sucking mouthparts, the males are not blood-suckers and some species even have non-hematophagous females. Detailed

descriptions of larval and adult mosquitoes can be found in any general entomological textbook. They will not be given here.

### 12.2.2 Genera of tideland mosquitoes

There are nine major genera of mosquitoes with tideland species: *Aedes*, *Anopheles*, *Culex*, *Deinocerites*, *Opifex*, *Aedeomyia*, *Uranotaenia*, *Psorophora* and *Culiseta*; seven of which also contain freshwater species. Thus, identification keys to mosquito species normally treat both types together. Furthermore, once mosquitoes reach the adult stage both freshwater and tideland species are often found in the same habitat. Numerous regional keys have been developed for distinguishing both larval and adult mosquitoes. Although the taxonomy and systematics of Culicidae have been studied far more extensively than most other insect families, our knowledge on the world wide mosquito fauna is still far from complete.

### 12.2.3 Special systematic problems of cryptic species

The delimitation of species in mosquitoes is often a complicated and difficult task because of the frequent occurrence of sibling and cryptic species. Studies involving hybridizations and cytogenic and isozyme analyses have been highly successful in detecting and characterizing species complexes, especially in tideland groups. The development of induced copulation techniques has enabled investigators to hybridize highly eurygamous species in the laboratory (McDaniel and Horsfall, 1957). Hybridizations from both induced and free mating experiments have uncovered several sterility barriers. The *Anopheles gambiae* complex comprises 6 separate species, including 2 saltwater forms: *An. melas* (Theobald) on the west coast of Africa and *An. merus* (Donitz) in East Africa and nearby islands (White, 1974). When *An. melas* and *An. merus* are crossed to each other or to the freshwater species the hybrid males are sterile, while hybrid females are normally fertile. Some mating combinations give normal sex ratios and others produce progenies with a preponderance of males. Three sibling species have been isolated in the *Aedes mariaae* complex: *A. mariaae* (Sergent and Sergent), *A. zammitii* (Theobald) and *A. phoeniciae* (Coluzzi and Sabatini). Morphologically the species are very similar and they occur in coastal rockpool along the Mediterranean Sea, albeit each species has its own distinct, non-overlapping distribution. Hybrid offspring of both sexes are sterile in crosses involving *A. phoeniciae* and two other members of the complex, but only the F<sub>1</sub> hybrid males are sterile in crosses between *A. mariaae* and *A. zammitii* (Coluzzi and Sabatini, 1968; Coluzzi et al., 1971). Bryan (1973a,b) utilized cross-mating experiments to characterize and to distinguish the members of the *Anopheles punctulatus* complex, which has one member, *An. farauti* (Laveran), breeding in both fresh and brackish water. *An.*



*farauti* populations from New Guinea and Australia are not conspecific (Bryan, 1970). Cross-matings between these populations produce sterile males and females in the F<sub>1</sub> generation (Bryan, 1973c). Similar hybridization experiments have assessed the degree of genetic affinity between members of the so-called *Anopheles crucians* complex. Kreutzer and Kitzmiller (1971) crossed and back-crossed the freshwater form *An. crucians* (Wiedemann) with the tideland form *An. bradleyi* (King) and obtained completely sterile F<sub>1</sub> hybrid males with atrophied testes. The hybrid females, although fertile, produced very few adult offspring.

Not all interspecific hybridization experiments have encountered post-mating barrier which tend to isolate the species. For example, in the hybridization of *Aedes sollicitans* and *Aedes nigromaculis* (Ludlow) by Fukuda and Woodard (1974), the F<sub>1</sub>, F<sub>2</sub> and backcross progeny were fully viable and fertile. Somewhat similar results were obtained by O'Meara et al. (1974) for offspring of crosses involving *A. sollicitans* and *Aedes mitchellae* (Dyar). However, the hatch rate was less than 50% in most of the backcross progenies. Adults of *A. sollicitans* sometimes occupy the same general habitat as *A. mitchellae* and *A. nigromaculis*. Since hybrids have never been found in nature, there must exist some type of pre-copulatory mechanism for isolation.

Coluzzi and Bullini (1971) have devised a novel method for demonstrating pre-copulatory barriers to gene flow in the *Aedes mariaae* complex. Under laboratory caged conditions, *A. mariaae* and *A. zammitii* freely mate and produce some fertile offspring. By utilizing natural occurring enzyme variants as markers, they were able to demonstrate the essential absence of hybridization between the species under field conditions and the presence of very efficient pre-copulatory mechanisms of isolation.

Our knowledge on the systematic and phylogenetic relationships among various Anopheline groups has been greatly expanded by cytogenetic studies of the polytene chromosomes, especially those found in the salivary glands of young 4th instar larvae. The banding patterns of these giant chromosomes have been used as cytotaxonomic characters to identify sibling species which cannot be readily identified by other methods (Coluzzi and Sabatini, 1968, 1969; Bryan and Coluzzi, 1971; Kreutzer and Kitzmiller, 1971). For some members of the genus *Anopheles*, adult females can be classified in a similar fashion by utilizing the ovarian nurse cell chromosomes (Coluzzi, 1968). Hybrids of cryptic species are particularly favorable material for determining the degree of chromosomal homology. Unfortunately, the genus *Anopheles* appears to be rather exceptional because attempts to obtain adequate polytene chromosome preparations in other mosquitoes have all ended in failure. There are surely many more undiscovered sibling species among both tideland and freshwater mosquito groups and the detection of these cryptic species must await the development of improved cytogenetic techniques.

### 12.3 LARVAL HABITATS

Within the tidelands, the aquatic stages of each mosquito species is normally confined to a distinctive localized habitat. *A. taeniorhynchus* and *A. sollicitans*, two rapidly developing species, breed in temporary pools found in natural depressions in both saltmarshes and mangrove swamps. Certain Anopheline species tend to occur in brackish pools which are somewhat more permanent. Several species, especially members of the genus, *Deinocerites*, breed almost exclusively in crabholes. In Florida, *D. cancer* breeds in the holes of the land crab, *Cardisoma crassum* (Smith). Along the southeastern coast of Texas, *D. pseudus* (Dyar and Knab) is often found in association with *D. mathesoni* (Belkin and Hogue) in crabholes, but each species appears to have a preference for different size holes. *D. pseudus* prefers holes 5 cm or larger in diameter, commonly those of land crabs *Cardisoma guanhumii* (Latreille) and *Gecarcinus lateralis* (Fremenville), while *D. mathesoni* is more frequently found in holes 2–3 cm in diameter made by the fiddler crab *Uca subcylindrica* (Stimpson) (Peyton et al., 1964). *Opifex fuscus* (Hutton), *Aedes australis* (Erichson), *Aedes mariaae* and several other species occur in coastal rockpools often above the level of high tides, but the water is kept brackish by sea spray. *Aedes dasyorrrhus* (King and Hoogstraal) is one of very few species whose larval habitat is essentially confined to brackish water tree holes of mangrove swamps (Belkin, 1962).

In addition to natural habitats, some marine Culicidae also utilize certain man-made environments. Dredging and related operations in river deltas have produced hydrological spoil areas where saltmarsh mosquitoes can breed on a massive scale. When the water-soil mixture is pumped onto coastal lands, it eventually dries leaving a terrain with a vast network of cracks and fissures. In the spoil areas near Savannah, Georgia and Charleston, South Carolina, *Aedes sollicitans* deposits its eggs in the moist lower regions of the fissures. Rainwater will partially fill these fissures and thus hatch the eggs. The salty nature of these habitats is often retained because dredging operations often repeatedly dump fresh spoil material on these sites. The occurrence of *A. taeniorhynchus* in spoil areas is quite limited, even though this species shares many natural habitats with *A. sollicitans*. Clearly, it is not the salinity of the specific aquatic habitat but rather the type of oviposition site selected by the female that determines the distribution of mosquitoes in the tidelands.

### 12.4 OVIPOSITION BEHAVIOUR

Tideland mosquitoes differ from freshwater species in their ability to survive and develop in brackish waters, and the propensity of the adult females to oviposit in or near such aquatic habitats. However, in the laboratory many tideland species

can be satisfactorily reared in either fresh or seawater. Yet, in the field, most tideland species are rarely found in freshwater sites, probably due to specific habitat selections made by females during oviposition.

The results of oviposition site selection tests with inorganic salts have been somewhat inconclusive. McGaughey and Knight (1967) noted that in the laboratory females of *Aedes taeniorhynchus* lay eggs as readily on freshwater as on saltwater substrate. They attributed this lack of selection to an alteration in the normal pre-oviposition flight behavior (Nielsen and Nielsen, 1953) brought about by the confinement in the unnatural laboratory environment. Petersen (1969) and Petersen and Chapman (1970) found the kinds and concentrations of salts present in the substrate to be more important as a repelling factor than as an attractant in the location of suitable oviposition sites. McGaughey (1968) found a positive oviposition response in *A. taeniorhynchus* to sulfates. The response was most noticeable when the ambient relative humidity was less than 80%. Hudson and McLintock (1967) found females of the freshwater species, *Culex tarsalis* (Coquillett), to select water containing pupae, exuviae, and emerging adults of their own species for oviposition in preference to distilled water. The attractant was presumably a non-volatile material since boiled samples of emergence water retained their attractiveness. However, Ikeshoji and Mulla (1970a) have isolated volatile, ether-extractable oviposition attractants for four species; *Culex pipiens quinquefasciatus* (Say), *Culex tarsalis*, *Aedes nigromaculis* (Ludlow) and *Aedes taeniorhynchus*. The attractant for each species was isolated from water where adults had recently emerged and in which pupae or larvae were present. It was found to be species specific and in certain cases actually repelled females of other species. Obviously, the survival of the eggs can be greatly enhanced if the female mosquito can detect and distinguish chemicals associated with specific habitats which have successfully provided the requirements for the development of its own species.

## 12.5 LIFE HISTORY AND ECOLOGY

The characteristic life stages in every mosquito species are the egg, larva, pupa and adult. For each stage there are distinctive developmental patterns, contrasting morphologies and diverse ecological requirements among the tideland species. Biological variation occurs both within and between species.

### *12.5.1 The egg*

The external morphology of the egg, particularly the size, the shape, and the chorionic sculpturing can be used as diagnostic characters for distinguishing most mosquito groups (Craig and Horsfall, 1960). Even closely related sibling

species can sometimes be identified, especially if the chorion is examined with a scanning electron microscope (Horsfall et al., 1970; Brust, 1974). Once the female begins to deposit its eggs the process ordinarily continues uninterrupted until the rest of the fully matured eggs in the ovary have been laid. A possible exception to this pattern occurs in *D. cancer* which, at least in the laboratory, lays only a portion of the total egg batch each day. Eggs are fertilized either at the time of egg laying or shortly thereafter. Newly deposited eggs have a pale translucent shell, which usually darkens and attains a black or brownish coloration within a few hours. For some species, e.g. *D. cancer*, little if any pigment is deposited into the shell and the egg is somewhat translucent throughout the process of embryogenesis. Several genera, most notably *Culex*, lay their eggs in rafts containing 100 or more eggs glued together in definite patterns. The rafts float with the long axis of each egg approximately perpendicular to the surface of the water. *Anopheles* eggs are frequently laid individually on the surface of the water where they float in a horizontal fashion. The sides of each Anopheline egg is equipped with specialized structures that give the egg added buoyancy. The eggs of *Aedes* are normally laid on moist substrate. If the habitat is flooded these eggs usually do not float to the surface.

Only a few studies have been performed on mosquito embryology and the more detailed examinations have been confined to freshwater species (Ivanova-Kazas, 1947; Idris, 1960; Guichard, 1971; Horsfall et al., 1973). Nevertheless, preliminary observations on embryonic development in *Aedes sollicitans* indicate a pattern similar to that found in freshwater species (Decoursey and Webster, 1952). The rate of embryonic development varies from species to species. Some can complete the entire process in less than 24 hours while others require almost 6 days. Of course the external temperature greatly influences the rates of all developmental processes. In general, the lower the temperature the slower the rate of development.

### *Factors affecting the hatching process*

Eclosion from the egg shell may occur immediately after the primary larva has been formed or it may be delayed for as long as a year or more. Among those species that require an external hatching stimulus, the egg stage can last longer than all the other stages combined. Very few tideland mosquitoes are univoltine, i.e. all eggs deposited during the breeding season overwinter with eclosion occurring the following year. Univoltine species have only one generation per year, while multivoltine mosquitoes produce several generations in a year with the specific number being determined primarily by rainfall patterns, the height and frequency of tidal waters and the overall duration of the breeding season. Numerous multivoltine species, including *A. taeniorhynchus* and *A. sollicitans* exhibit a facultative type of embryonic diapause whereby overwintering eggs do not hatch even when submerged. Short daylight photoperiods can induce embryonic

diapause but the effect can be masked by elevated temperatures (Anderson, 1968). Anderson (1970) found that the photoperiod could control embryonic diapause in a Connecticut strain of *A. sollicitans* but not in a Florida strain. The former exhibited a long-day, short-day induction curve with critical photoperiod between 14:10 and 13:11 (Light:Dark cycle). The stages sensitive to the photoperiod included the late larval instars, the pupa and the adult of the parental generation and the developing and fully formed embryo. Conversely, the diapausing condition can be terminated by long-day photoperiods applied to the fully developed embryo. It remains to be determined how the light cycle information is received and transmitted by the various life forms. Almost nothing is known about the neural or hormonal regulation of embryonic diapause, although larval and adult diapause have been studied in great detail (Clay and Venard, 1971; Spielman, 1974). In certain cases, inhibition of eclosion appears to be the result of interactions between maternal and embryonic factors. For example, a lethal trait is associated with the bleached-eye mutant of *A. taeniorhynchus* whereby fully formed *bl* embryos fail to hatch (O'Meara, 1975). However, reduced hatchability occurs in *bl* mosquitoes only when the maternal parent possesses the *bl/bl* genotype. The *bl* embryos from heterozygous (*bl/+*) females and normal embryos from *bl* females are not affected. Nearly all eggs laid by *bl* females are rescued by *bl*<sup>+</sup>-bearing sperm. The sex of the offspring does not influence hatchability.

*Anopheles melas* differs from the freshwater members of the *An. gambiae* complex and most other anopheline mosquitoes in actively preferring damp soil to free water for oviposition. Giglioli (1964, 1965) has pointed out the evident advantages of this behavior for the survival of *An. melas* during the dry season throughout its west African distribution. He found at least some of the eggs laid on damp soil to survive desiccation and be stimulated to hatch on the next flooding spring tide, when relatively permanent water became available to allow development to the adult stage. On the other hand, if *An. melas* oviposited on surface waters during the neap tide of the dry season, high mortality would follow because these eggs would proceed to hatch within a few days and the larval stages would encounter lethal salt concentrations. Moreover, the habitat would probably dry up before maturation was completed.

In the saltmarshes of Florida, *Anopheles atropos* (Dyar and Knab) exhibits an even more exceptional form of delayed hatching. Although the eggs are deposited on surface waters, eclosion does not necessarily follow immediately after completion of embryogenesis. Hatching is staggered over a period of several weeks, and variable hatching patterns are found even within individual egg batches.

Flooding is not always a prerequisite for eclosion of eggs laid on moist soil or vegetation. Some species show a propensity for hatching when the eggs are only partially enveloped in a film of water. Crabhole mosquitoes can hatch on moist substrate and crawl downward to their aquatic habitat (Haeger and Phinizee, 1959).

Owing to the variable levels of dormancy or diapause, submergence may trigger hatching of only a portion of the viable egg population.

### *Egg mortality*

Mortality in the egg stage results from the combined effects of desiccation, predation and parasitism. Resistance to desiccation is a well known attribute of mosquito eggs. The degree of resistance varies greatly from one species to another. Within species, freshly laid eggs are generally more susceptible to desiccation than eggs containing fully matured embryos. Female mosquitoes are particularly adept at locating and depositing their eggs in suitable oviposition sites. Natural selection undoubtedly continues to further refine and improve this behavior. The danger of lethal desiccation is greatest for those eggs which must undergo long periods of diapause, although predation appears to cause higher levels of mortality than desiccation.

In the field, 50% or more of the eggs of *Aedes taeniorhynchus* may at times be eliminated by predators (J.H. Frank, personal communication). Eggs disappear from the saltmarsh throughout the year but the mortality rates fluctuate with the season. Although the major predators have not been positively identified, judging by their general feedings habits, fiddler crabs and certain types of beetles are likely to be important predators. Eggs of *A. taeniorhynchus* and *A. sollicitans* frequently become covered with fungi or molds if left for a few weeks in the laboratory. These microbial growths do inhibit eclosion. Trans-ovarial transmission of parasites from parent to offspring is extremely common in tideland mosquitoes. Both viral and protozoan infections have utilized this pathway. Many of the parasites are harmless to the embryo and only become fatal in the later stages of larval development.

### *12.5.2 Larvae and larval feeding patterns*

The larva is the major growth stage in the mosquito life cycle. All mosquito larvae moult four times and by far the greatest increase in mass occurs during the fourth instar.

Mosquito larvae are basically omnivores. The few species that are predaceous on other mosquito larvae are rarely found in the tidelands. Surtees (1959) has classified non-predaceous larvae as either filter feeders or browsers. Both Surtees (1959) and Pucat (1965) have noticed intermediate types. Some species show a shift from filter feeding to browsing as they progress from early to later instars. Browsing larvae are usually bottom feeders. They swim over the substrate and abrade solid material. Food particles are manipulated and broken down into smaller sizes by the combined action of the serrated mouthbrushes and mandibular claws and setae before they can be swallowed. Compared to the browsers, the filter feeders have relatively longer and finer mouthbrushes. These brushes are used to set up strong water currents which can sweep small food particles into the oral cavity and into the digestive tract. Anophelines are almost exclusively

filter feeders and they are particularly adept at gathering floating food particles from the water surface. Other mosquitoes filter feed on suspended particles as they swim or when hanging from the surface by their siphon.

### *Larval respiration*

All mosquito larvae must breathe air. Some dissolved oxygen for respiration can be obtained by diffusion through the cuticle. However, as larval development advances, it relies to a progressively greater extent on aerial oxygen. Larvae of a few freshwater species can puncture the roots and stems of aquatic plants and obtain their air supply from the air pockets within the plants. Nevertheless, the majority of species, including all tideland forms, must come to the surface for air. Browsers must interrupt their feeding to fulfill this requirement whereas filter feeders often breathe and feed simultaneously. The amount of time a larva can stay completely submerged depends on the species and the environmental conditions of the habitat. Daily fluctuations in temperature and dissolved gases tend to create cyclic breathing patterns. Cooler night-time temperatures tend to reduce the need for air breathing due to decreases in metabolic rates and oxygen consumption. At certain times of the day photosynthetic activities of plants in the water increase the levels of dissolved oxygen and thus improve the efficiency of cuticular respiration, thereby lessening the need for aerial respiration. CO<sub>2</sub> levels in the water also show cyclic daily fluctuations. Higher CO<sub>2</sub> levels tend to increase the reliance of the mosquito on aerial respiration.

### *Developmental rates*

Many of the factors which regulate respiration also influence the rate of larval development. Certain freshwater species spend weeks in the larval stage and a few even hibernate as diapausing larvae. Few, if any, tideland mosquitoes truly hibernate as larvae. Most of them cannot afford to develop slowly since their aquatic habitats are usually very temporary. Again the crabhole-breeding *Deinocerites* are exceptions to this general pattern and frequently spend two or more weeks in the larval stage. *Aedes sollicitans* clearly exemplifies rapid larval development. Under favorable conditions, field populations of this species often require less than five days for development from egg to pupa. When sympatric field populations of *A. sollicitans* and *A. taeniorhynchus* are hatched at the same time, *A. sollicitans* invariably become pupae 1 or 2 days ahead of *A. taeniorhynchus*. Moreover, the total mass accumulated by *A. sollicitans* during the larval stage far exceed the levels attained by *A. taeniorhynchus*. If larvae are excessively crowded, or if food levels are suboptimal, then the duration of the larval period is often extended. These conditions can cause a considerable reduction in the ultimate size of not only the larvae but all succeeding stages.

Among tideland mosquitoes there are both stenothermic and eurythermic species. *Aedes sollicitans* can develop successfully over a wide temperature range

(15–38°C). At the lower part of this range the speed of larval development is slower but often the total mass accumulated by the larvae is enhanced.

Linley and Evans (1971) found that the preferred average temperature of *Aedes taeniorhynchus* larvae increased with age from 31.8°C in the first instar to 34.6°C in the early fourth instar. These temperatures are considerably higher than those selected by certain freshwater species (Ivanova, 1940; Omardeen, 1957). A preference for higher temperatures would tend to shorten developmental time, an obvious advantage to *A. taeniorhynchus* since it normally occurs in extremely temporary aquatic habitats.

Several studies have uncovered evidence for the existence of growth-retardant substances produced by mosquito larvae (Moore and Fisher, 1969; Peters et al., 1969; Ikeshoji and Mulla, 1970b). These substances can affect the survival and developmental rates of not only the species producing the retardant but also other species in the same habitat. Other substances produced either by newly hatched larvae or their discarded egg shell seem to regulate further egg hatching. In *Aedes* mosquitoes, hatching in diapause eggs may induce hatching in companion diapausing eggs by lowering the threshold response to a given stimulus, whereas hatching in the prediapause state depresses hatching further (Gillett, 1959). These chemical interactions have been investigated only in freshwater species, but are also quite likely to occur in tideland mosquitoes.

### *Locomotion*

Mosquito larvae can move about by the propulsion generated by their mouth parts. However, for rapid locomotion they usually jerk and twist their abdomen. Larvae respond to change in light intensities, to vibrations, and to differences in temperature.

Both freshwater and tideland mosquitoes exhibit several types of aggregation formations in larval populations. Nielsen and Nielsen (1953) and Nayar and Sauerman (1968) have noticed 2 types of aggregation formations in *Aedes taeniorhynchus*. One is called the cluster type while the other is termed the ball type. Larvae in a cluster type of aggregation are grouped together in a single layer. These clusters contain larvae which exhibit very little activity. The ball type of aggregation has the appearance of a multi-layered cluster. The larvae that comprise the ball swim actively and constantly. Several investigators have concluded that aggregations in mosquitoes occur only in the daytime (Bickley, 1972). Hocking (1953) considered aggregations to be the result of mutual orientation of larvae toward their shadows. Developmental synchrony is increased by the formation of aggregations (Nayar and Sauerman, 1968).

### *Larval predators and parasites*

Of the numerous predators of mosquito larvae in the tidelands, fish seem to have the greatest impact. Harrington and Harrington (1961) identified 6 common



species of larvivoracious fishes in a subtropical saltmarsh in Florida. The extent to which these fishes fed on mosquito larvae rather than on other food items varied with the relative abundance of prey species. During their peak abundance, mosquitoes contributed to the total food volumes as follows: Gulf killifish (*Fundulus grandis* (Baird and Girard)), 94.8%; marsh killifish (*Fundulus confluentus* (Goode and Bean)), 85.5%; eastern mosquito fish (*Gambusia affinis holbrooki* (Girard)), 78.7%; rainwater killifish (*Luciana parva* (Baird and Girard)), 72.8%; sheepshead killifish (*Cyprinodon v. variegatus* (Lacépède)), 57.3%; sailfin molly (*Mollienesia latipinna* (LeSueur)), 52.3%. When mosquito larvae and pupae are less abundant the fish shift to other food items and some, like the marsh killifish, show a preference for neonate *Gambusia* (Harrington and Harrington, 1972). The second most important predators are probably other insects. Bay's (1974) review on insect prey-predator relations include several studies on mosquito larvae as prey. Unfortunately, nearly all the work on this subject has been confined to freshwater species.

Mosquito larvae are attacked by both internal and external parasites. Field-collected larvae are frequently covered with various protozoans, but fatal infections of ectoparasites are relatively rare and these organisms are often commensal rather than parasitic. Larvae succumb to infections from numerous endoparasites such as viruses, bacteria, protozoa, fungi and nematodes. These pathogens undoubtedly play an important role in the natural regulation of mosquito populations. Pathogens have several ways of getting into mosquito larvae. Some like the mermithid nematodes have a preparasitic stage which penetrates through the abdominal cuticle (Petersen et al., 1967); others are ingested by the larvae during the feeding process. The mosquito iridescent virus (MIV) can be effectively transmitted orally to *A. taeniorhynchus* larvae. Ingestion of MIV by early instars can lead to death in the 4th instar larvae. If infections are not acquired until the later stages of development, the larvae survive to produce infected adults. Transovarial transmission occurs from the infected female to its eggs. Although the infected eggs hatch, the resulting larvae normally die in the 4th instar (Linley and Nielsen, 1968a,b). Several species of Microsporidia of the genus *Thelohania* have been described from mosquito larvae (Kellen et al., 1965). These protozoan infections are also transmitted transovarially. *Thelohania* kills both male and female 4th instar larvae of *A. sollicitans* and *A. taeniorhynchus* (Chapman et al., 1966). Similar infections in other mosquito hosts are often restricted to male larvae. Preoral transmission has not been observed in most of the susceptible *Aedes* mosquitoes and Chapman et al. (1973) suggest that *Thelohania* might only be transmitted transovarially.

Although many organisms parasitize tideland mosquito larvae, the rates of infection in most natural mosquito populations tend to be relatively low. Inactivation of the parasite by environmental conditions and the inherent resistance within the mosquito are the two major factors which tend to suppress infection

rates. Once outside the mosquito, MIV quickly begins to lose its infectivity. Fukuda and Clark (1975) have shown that not all the larvae of *A. taeniorhynchus* from an infected egg batch develop patent infections of MIV, thus indicating the presence of resistant individuals in the population. The fungus, *Coelomomyces psorophorae* (Couch), infects over a dozen mosquito species, including *A. taeniorhynchus*, while *Aedes australis* is parasitized by another fungus, *C. opifex* (Pillai and Smith). The rates of infection of *C. psorophorae* seldom exceed 5% in field populations of *A. taeniorhynchus* (Lum, 1963). Dehiscence of *C. opifex* sporangia, a necessary part of the disease transmission cycle, is inhibited by high concentrations of sea salts (Pillai and O'Loughlin, 1972). On the other hand, Roberts et al. (1973) have increased the percent dehiscence of *C. psorophorae* sporangia from *A. taeniorhynchus* with certain amines and amino acids. Obviously, knowledge on how the rates of infectivity of fungi or other pathogens can be artificially increased will be useful in biological control of mosquitoes.

### 12.5.3 Pupae

Mosquito pupae do not feed and this stage invariably lasts only a few days. Hibernation or aestivation can occur in the egg, larval, or adult stages but not in the pupal stage. This pattern contrast sharply with many other insect groups which hibernate or diapause in the pupal stage. Another distinctive characteristic of the mosquito pupa is its ability to move about rapidly. However, if undisturbed, they normally remain motionless at the surface of the water. The necessary buoyancy is provided by an air bubble trapped between the thoracic appendages on the underside of the cephalothorax. A pair of float hairs on the dorsal side of the first abdominal segment and the air trumpets of the cephalothorax also help to keep the pupae at the surface.

Pupation in some mosquitoes follows a diurnal rhythm. In *A. taeniorhynchus* this phenomenon has been studied extensively both in the laboratory and in the field (Nielsen and Haeger, 1954; Pausch and Provost, 1965a,b; Nayar, 1967; Provost and Lum, 1967; Lum et al., 1968). Although adult emergence occurs in a diurnal rhythm, it is only a reflection of the previous pupation rhythm. The interval between the 2 rhythms is a function of temperature and not photoperiod. Under light regimes with alternating light and dark phases, pupation in *A. taeniorhynchus* follows a diurnal period of approximately 22.2 hours. The period of the pupation rhythm is unaffected by temperature but may be lengthened by food deficiency. The peak of daily pupation occurs between noon and midnight at a time determined by temperature, diet and the time of hatching. Occasionally, the first pupation represents an 'advance peak' which occurs later in the day but precedes the next day's peak by less than the regular 22.2 hour period. Males comprise the predominant sex of these advance peaks.

Among mosquito species the males often pupate ahead of females, and male

pupae tend to be smaller than female pupae, but the magnitude of these differences varies greatly from species to species. The diurnal rhythm has a synchronizing effect on the mosquito brood. The second or main peak of pupation can encompass over 80% of the total brood. The sharpness of the individual pupation peaks is influenced primarily by the temperature and to a lesser extent by the availability of food for the larvae. At 32°C, 95% of pupation occurs within an 8 1/2-hour interval, whereas at 22°C the pupation rhythm essentially disappears. Nayar (1968) demonstrated that the pupation in *A. taeniorhynchus* is in fact an endogenous circadian rhythm. Provost (1974a) has described some of the significant ecological relationships between this rhythm and the migratory flight behavior in *A. taeniorhynchus*. The mass twilight exodus associated with migrations are dependent to a large extent on the synchronization and timing of pupation brought about by the interaction of temperature and photoperiod.

#### *12.5.4 Adult behaviour*

Much of what is known about adult mosquitoes in the field has been derived from specimens taken in various types of traps. It is essential to know the advantages and limitations of the sampling devices if we are to accurately interpret field collections. For example, bait traps will normally attract only blood-thirsty female mosquitoes. Moreover, some species are more reluctant to enter traps than others. In contrast, vehicle aspirators and truck traps (Bidlingmayer, 1966; Bidlingmayer and Edman, 1967) readily collect mosquitoes in all physiological stages. Nevertheless, the truck trap only captures mosquitoes flying at certain heights in open areas. And the vehicle aspirator picks up only the adult mosquitoes which are resting on the ground or low-lying vegetation. To effectively evaluate wild mosquito populations, it is necessary to simultaneously use sampling techniques that operate on different principles. During an extensive trapping study over a 3-year period in a coastal region of Florida, Bidlingmayer (1974) found that both environmental factors and the physiological stages of the mosquitoes could greatly influence what was taken in collections. Increased levels of lunar illumination have been shown to increase the level of flight activity in saltmarsh *Aedes* (Bidlingmayer, 1964). Thus, truck traps, and to a lesser extent suction and bait traps, collect a much greater number of mosquitoes on full-moon nights than on moonless nights. In contrast, light trap collections are reduced at full moon (Provost, 1959) even though mosquitoes are most active during this time. Wind velocity, temperature, humidity, and trap location can also influence the kinds of samples taken with the various types of traps (Provost, 1959; Bidlingmayer, 1967; Dow and Gerrish, 1970). For many mosquito species, blood-fed or gravid females exhibit different activity patterns from the rest of the population. In *A. taeniorhynchus*, these females have peak activity at the crepuscular periods, and respond to lunar illumination more readily than the rest of the population.

Thus, the time of collection, both during the day and the lunar month, can affect the composition of the sample. However, despite their limitations, mosquito traps are valuable providing essential information on the population dynamics and behaviour patterns of wild populations (Gillies, 1974).

### *Ovarian development and autogeny*

Female mosquitoes are noted for their blood-feeding activities. Usually a blood-meal is a prerequisite to egg maturation, but more than 40 species of mosquitoes are able to produce at least the initial egg batch without a blood-meal. This capacity is called autogeny, while the term anautogeny applies to those cases where a blood-meal is always necessary. Autogeny also occurs in other hemato-phagous Diptera, such as tabanids and ceratopogonids (see Ch. 13).

Females of *Deinocerites cancer*, *Culiseta subochrea* (Edwards) and *Aedes australis* seem to be uniformly autogenous. Populations of *Opifex fuscus* in the northern part of New Zealand are also autogenous, but populations of the same species found in the southern part are often completely anautogenous. Rioux et al. (1973) found an autogenous population of *Aedes detritus* (Haliday) in Tunisia and a totally anautogenous population in France. Females of *Anopheles amictus hilli* (Woodhill and Lee) are autogenous, whereas those of the freshwater subspecies, *Anopheles amictus amictus* (Edwards) are not. Although autogeny is rarely found in *Aedes sollicitans*, it is relatively common in many populations of *Aedes taeniorhynchus*. In fact, most *A. taeniorhynchus* populations contain some autogenous as well as anautogenous females. In general, tropical and subtropical populations of *A. taeniorhynchus* have higher rates of autogeny than do temperate populations. There are some exceptions, e.g., in some Panama strains less than 1% of the females are autogenous. In peninsular Florida, O'Meara and Evans (1973) found a clinal variation among populations of *A. taeniorhynchus* in which both the frequency and the fecundity of autogenous females increased along a north to south gradient.

The size of the initial egg batch of some autogenous species can be enhanced if the female takes a blood-meal, but they are usually reluctant to do so while developing their eggs. After egg laying, however, females normally become avid blood-feeders.

It is difficult to distinguish autogenous and anautogenous females until the second or third day after emergence. Unlike the ceratopogonids where autogenous ovarian development is essentially complete in the pupal stage, all mosquitoes emerge with their ovaries at Stage I and little if any yolk is present in each follicle. In the absence of a blood-meal, the rate of ovarian development varies from one species to the next and even within species. In *A. taeniorhynchus*, which exhibits obligate as well as facultative autogeny, egg development is usually completed by the fifth day after emergence in the former, whereas in the latter it is arrested at Stage II for several days. Females can thus require as many as 12 days to fully

mature their eggs. Temperature also affects the rate of egg development irrespective of whether the females are blood-fed or not.

The occurrence of autogeny and the size of the autogenous egg batch are regulated by one or more than one genes depending on the species (O'Meara and Edman, 1975). Larval as well as adult nutrition was found to influence autogenous reproduction in some species (O'Meara and Krasnick, 1970). Lea (1963, 1964, 1967, 1970) has found that anautogenous *A. taeniorhynchus* requires a blood-meal to trigger the release of egg-development hormone which is produced and stored in the corpus cardiacum. This triggering mechanism is not required by autogenous females. Several questions about the physiological regulation of egg development still remain unanswered, e.g. What factors regulate the number of eggs that mature, either with or without a blood-meal? What causes the delay in the onset of egg development in facultatively autogenous females?

The absence of suitable hosts and the inhibition of host-seeking by harsh climatic conditions appear to be major factors selecting for autogeny in many freshwater species inhabiting severe climatic regions of the arctic and temperate zones (Corbet, 1964, 1967; Downes, 1965; Smith and Brust, 1970). Yet for many tideland species the distribution of autogeny cannot be readily attributed to specific ecological factors.

Improved serological techniques for determining blood-feeding patterns have made it possible to determine potential hosts of mosquitoes in the field. Although several species of vertebrates occur in and near the mangrove swamps of subtropical regions, many of them are seldom fed upon by tideland *Aedes* mosquitoes. Obviously some hosts are not accessible for reasons unrelated to their densities. Certain vertebrates also show highly effective anti-mosquito behavior (Edman and Kale, 1971; Webber and Edman, 1972). Such defenses often become more pronounced when attacks from mosquitoes become more intensified (Edman et al., 1972a). Besides active defenses, other types of host behavior can also help to avoid mosquito attack. O'Meara and Edman (1975) found that autogenous *A. taeniorhynchus* are abundant in some populations because suitable hosts are either unavailable or available only during a very limited basis.

### *Blood-feeding patterns*

A variety of basic blood-feeding patterns have been found in tideland mosquito species (Tempelis, 1975). *Uranotaenia lateralis* (Ludlow) feeds primarily on fish. In Malaya this mosquito feeds on the fish known as 'Mudskipper' (Gobiidae). Member of the genus *Deinocerites* are versatile blood-feeders. In Panama, Tempelis and Galindo (1970) found *D. pseudus*, *D. epitedeus* (Knab) and *D. cancer* to feed on all 4 classes of terrestrial vertebrates. Certain *Deinocerites* species show a strong affinity for reptiles, but they tend to be opportunistic rather than preferential feeders. When reptiles and amphibians were relatively less common, there was a noticeable increase in the rate of feedings on other vertebrates such

as mammals (Martin et al., 1972, 1973). In both Panama and Florida, *Deinocerites cancer* feeds primarily on birds (Tempelis and Galindo, 1970; Edman, 1974).

In general, tideland *Aedes*, like the freshwater relatives feed mostly on mammals. Frequently, rabbits serve as the predominant host for *A. taeniorhynchus* and *A. sollicitans*, although in some habitats the majority of the blood-meals are taken from cattle, horses or deer. Relatively few *A. sollicitans* or *A. taeniorhynchus* succeed in obtaining human blood-meals, and birds account for less than 20% of their blood. Only rarely does either species feed on amphibians or reptiles. In a study of British mosquitoes, Service (1971) found nearly 50% of the engorged *Aedes detritus* with bovine blood and another 33% had human blood.

Along the West Coast of Africa, *Culex thalassius* (Theobald) utilizes a wide range of hosts, including mammals and birds. Snow and Boreham (1973) using precipitin tests on 492 engorged *C. thalassius* females, found approximately 60% had fed on mammals, with cow and dog predominating; 38% had fed on birds and 2.7% on reptiles.

Within the *Anopheles gambiae* complex, the saltwater species, *An. melas* and *An. merus* show contrasting blood-feeding patterns. Although both species may feed on man if other hosts are not available, the human blood index for *An. melas* is often much greater than the rate found in *An. merus*, which is more regularly zoophagic. *An. melas* also readily feed on domestic animals such as goats, sheep, dogs and cattle. The malaria vectors, *Anopheles farauti* and *An. sundaicus* (Roden-walldt) feed predominantly on primates but bovine and canine blood-meals are not uncommon. To date no seasonal shifts have been noted in the blood-feeding patterns of tideland mosquitoes.

### *Sugar feeding*

Male and female mosquitoes obtain sugar from several sources, including flowers, extra-floral nectaries, honey-dew and fruit juices. Van Handel (1972) has devised a simple yet effective test to determine if a mosquito has fed on sugar. Free fructose or the fructose component of sucrose is found in all plant sugars. Since unfed and blood-fed mosquitoes do not contain this particular sugar, the presence of fructose in a field-collected mosquito clearly indicates a prior sugar meal. Using this method, Bidlingmayer and Hem (1973) found a great deal of variation among Florida mosquitoes. However, within each species the feeding rates for males and females were similar. A relatively high rate of sugar feeding was detected in *A. taeniorhynchus* taken at the edge of the saltmarsh where sugar sources are plentiful. Both *A. taeniorhynchus* and *A. sollicitans* have been observed to feed on the flowers and the extra-floral nectaries of mangrove trees (Haeger, 1955).

A positive correlation between carbohydrate intake and survival and flight potential was found for *A. taeniorhynchus* females (Nayar and Sauerman, 1971). *A. sollicitans* and *A. taeniorhynchus* females can apparently synthesize and accumulate small amounts of glycogen and large quantities of triglycerides from sugar.

Males, on the other hand, do not possess the ability to accumulate triglycerides (Van Handel and Lum, 1961). Unfed and blood-fed mosquitoes fly on glycogen only. Sugar-fed mosquitoes accumulate glycogen and fat during flight, and thus do not use glycogen as a substrate so long as sugar is available (Nayar and Van Handel, 1971). Long distance flight capabilities have been well documented for some tideland mosquito species (Provost, 1952, 1957). Migratory exodus occasionally observed in recently emerged *A. taeniorhynchus* can occur in the absence of sugar feeding, provided adequate glycogen reserves were carried over from the pupal stage. Nevertheless, the limited storage capacity for glycogen (Lea and Van Handel, 1970) would make sugar feeding an essential prerequisite for most of the flight activities, especially following the utilization of the initial reserves of glycogen.

### *Mating*

Sexual maturity in newly emerged males does not occur until the terminalia rotate a minimum of 135°. The time required for this process is greatly affected by temperature (Provost et al., 1961). At 25°C the average *A. taeniorhynchus* male attains sexual maturity approximately 18 hours after emergence. Terminalia rotation is much quicker in *Deinocerites cancer*, and in *Opifex fuscus* this process takes less than 5 hours, possibly the shortest time period required among tideland species.

Females of several species, including *A. taeniorhynchus*, exhibit posteclosion refractoriness to insemination. Lea and Evans (1972) found that young, tethered *A. taeniorhynchus* females attracted males, but insemination was prevented by the active rejection behavior of these refractory virgin females. Edman et al. (1972b) found similar behavior in the field. Insemination usually takes place soon after sunset and most females were 30–40 hours old before they were inseminated. Lea (1968) was able to extend the post-emergence refractory period by allatectomy and Gwadz et al. (1971) have shortened it by treating pupae and adults with juvenile hormone analogues.

There is no delay in the onset of sexual receptivity in females of *Deinocerites cancer* or *Opifex fuscus*. Mating often occurs at emergence since males search for and actually capture female pupae by the pupal horns with their tarsal claws. Mating can even be initiated before the female is completely out of the pupal skin (Provost and Haeger, 1967). The duration of coitus is usually 40–50 minutes in *D. cancer*, 20–30 minutes in *O. fuscus* and less than 10 seconds in *A. taeniorhynchus*. Apparently all female mosquitoes are monogamous (Craig, 1967; Gwadz and Craig, 1970). Once inseminated, females usually become refractory to a second insemination for life. In contrast, a male mosquito will mate with several females.

Lack of mating under laboratory caged conditions is one of the major factors preventing establishment of experimental colonies of many species. For example, *A. sollicitans* rarely mates when confined in room-sized cages; wild *A. taeniorhynchus*

display a similar behavior, but in most populations there are enough stenogamous individuals so that laboratory colonies can be initiated. Stenogamy (ability to mate in small cages) is a female-dependent trait and has been most thoroughly studied in *A. taeniorhynchus* (Haeger and O'Meara, 1970; O'Meara and Evans, 1974).

### *Flight*

Distinctive flight patterns are associated with dispersal, migration and swarming. In general, only males display swarming activities. There are several types of swarms and each is characterized by definite formalized movements which are restricted to a certain space (Nielsen and Nielsen, 1962). *A. taeniorhynchus* swarms close to or above prominent vertical objects such as tree tops, buildings, etc., whereas *A. sollicitans* forms marker swarms above more or less horizontal surfaces with contrasting light and dark patterns. The main external factor inducing the formation of swarms is the light conditions during the daily crepuscular periods. Although some authors have applied a sexual function to swarming, mosquitoes often mate in the absence of or prior to swarming (Nielsen and Haeger, 1960). For most mosquito species the biological functions and the survival value associated with swarming are poorly understood.

Migratory flight, as defined by Provost (1974a), is performed by only a few mosquito species, in which migration is the first sustained flight of young adults who have not matured their first batch of eggs. Migrating mosquitoes have no equivalent return flight. Migration has been observed in *A. taeniorhynchus* and *A. sollicitans*. It is not known why some broods migrate and others of the same species do not. In the laboratory, Nayar and Sauerman (1969) have produced migratory and nonmigratory phases of *A. taeniorhynchus* by varying the larval densities. In the field, migrations of *A. taeniorhynchus* have been studied with marking, release and recapture experiments (Bidlingmayer and Schoof, 1957; Elmore and Schoof, 1963; Provost, 1952 and 1957). These studies have revealed that both males and females can participate in migratory flights but females tend to migrate greater distances, the maximum being approximately 50 km. Migration may occur either at twilight or during the night. The twilight exodus is a mass phenomenon, performed by 6–24-hours old mosquitoes some of which may have sugar fed. In contrast, the nighttime exodus is not a mass departure and it occurs throughout the night as non-fed individuals attain the age threshold for spontaneous flight. If the wind is less than 3–5 km/h the mosquitoes take off into the wind; if the wind is over 5 km/h they take off down-wind. Migratory broods tend to be more common during the summer than in the spring or fall. Provost (1974a) postulates that temperature may have an important role in determining the seasonal distribution of migratory broods.

While migratory flights transport a population from one place to another, appetential flights for vegetative functions such as feeding, mating, and ovipositing



tend to disperse or scatter populations. The degree of dispersal is influenced both by internal and external factors. Obviously, the biological suitability of a particular environment will greatly influence the amount of flying. Most tideland mosquitoes which venture out into other habitats in search of blood-meals, must return to the tidelands if they are to deposit their eggs in a suitable site. Breeding for most tideland species seldom occurs in freshwater habitats (Service, 1972).

## 12.6 MEDICAL AND ECONOMIC IMPORTANCE

Several tideland anopheline species are involved in the transmission of malaria, probably the most widespread disease transmitted to man by mosquitoes (White, 1974; Belkin, 1962). To a much lesser extent, tideland mosquitoes are also vectors of filariasis. For example, *Aedes vigilax* (Skuse) is the principal vector of non-periodic filariasis in New Caledonia, whereas *Culex annulirostris* (Skuse) a species that occurs in both fresh and brackish waters, is the major vector of periodic filariasis in some parts of New Guinea. A few species, such as certain members of the *Anopheles punctulatus* complex are efficient vectors of both malaria and filariasis. Domestic animals also acquire diseases from tideland mosquitoes. *Aedes sollicitans* and *Aedes taeniorhynchus* transmit dog heartworm. The same two species appear to be important vectors of the epidemic form of Venezuelan Encephalitis (VE), a disease of both man and horses (Sudia, 1972). *Deinocerites pseudus* and *Culex iolambdis* (Dyar) have been implicated in the maintenance of enzootic foci of VE (Work, 1972). Many other viruses that cause diseases in man and animals have been isolated from tideland mosquitoes.

Besides transmitting diseases, tideland mosquitoes are well known as pests of humans in many coastal areas. Moreover, agricultural endeavors have endured economic losses because of the pestiferous nature of saltmarsh mosquitoes. In the saltmarsh areas of Texas, beef cattle production during the summer months is often economically impractical due to the annoyance caused by hordes of blood-thirsty mosquitoes (Sanders et al., 1968).

## 12.7 CONTROL

### *12.7.1 Mosquito control problems in Florida*

At the present time, several techniques are used to control tideland mosquitoes. Each method has definite limitations. Moreover, the effectiveness of most techniques varies from one location to the next. To fully appreciate mosquito control problems it is necessary to take a historical point of view. A brief historical

account of mosquito control in Florida is given to illustrate various problems encountered in control measures. The detailed development of various solutions has been well documented in the Proceedings of the Florida Anti-Mosquito Association.

The initial organized mosquito control efforts in Florida were directed at freshwater species involved in the transmission of malaria. The eradication of this disease was achieved by: (1) suppressing the vector population using both chemical and physical methods, (2) reducing the malaria reservoir in human populations using quinine treatments, and (3) screening houses to prevent the inhabitants from being bitten by the vector. These programs were highly successful in breaking the transmission cycle. Obviously, permanent mosquito control was not necessary for malaria eradication.

When the first Florida Mosquito Control District (Indian River County) was created in 1925, permanent control of pest species, especially saltmarsh varieties was the primary objective. A combination of factors made the attainment of permanent control an elusive goal. During the 1930s, hand-dug and dynamited ditches were constructed on thousands of acres of saltmarshes and mangrove and mangrove swamps. Previous work in New Jersey had already demonstrated the usefulness of ditches which enabled tidal action to both flush and drain mosquito pools and also provided access routes for mosquito-eating fish. However, when the ditching system was applied to Florida's mangrove swamps and scrub marshes, it proved to be relatively ineffective in certain locations. Unlike the situation in New Jersey where mosquito breeding was confined to only a small area in the upper zone of the tidelands, mosquitoes bred throughout the entire mangrove swamp with the exception of the narrow red mangrove zone. Therefore a much more extensive ditching system was necessary to control mosquitoes in mangrove swamps. Moreover, many of Florida's ditching systems constructed prior to 1940 were in areas that did not receive enough tidal action to adequately flush the ditches. The maintenance on established ditches was often neglected due to a lack of funds or manpower during the Depression and World War II. Where ditches silted in, mosquitoes and sandflies returned, and the production of pest insects often exceeded the levels encountered before the tide-lands had been ditched.

After the war, there was a great expansion in mosquito control activities and presently there are 32 districts in Florida alone. Chemical methods became the principal means for controlling mosquitoes. Some districts continued ditching practices, whereas others used no physical methods for permanent control. With DDT and war surplus planes readily available, massive spraying programs were conducted on the tidelands and adjacent residential areas. At first these spraying programs were extremely successful. However, DDT-resistant mosquito populations rapidly developed, first in *Aedes sollicitans* and later in *Aedes taeniorhynchus*. By 1949, resistance to DDT was well-established in *A. sollicitans*, which suddenly

became the dominant species. This species will actively seek a blood-meal both at night and during the daytime even in open sunlit areas, while *A. taeniorhynchus* feeds primarily during the crepuscular periods. Increasing the insecticide dosage or frequency of spraying did little to solve the resistance problem. Replacing DDT with other insecticides such as BHC (benzene hexachloride) and chlordane were only short-term solutions.

During the past 15–20 years, a renewed emphasis on permanent control by physical modification of the tidelands and restricting synthetic organic insecticide usage to adulticide operations have been major features of saltmarsh mosquito control in Florida. Old ditches have been refurbished and many new ones have been constructed. Where ditching has been shown to be impractical or ineffective, they have been replaced by water impoundments. Some impoundments are flooded by natural precipitation and run-off from upland sites, while others use a gate system to catch and hold abnormally high tides. At times, it is necessary to add either freshwater from wells or brackish water pumped from the estuary. Since saltmarsh *Aedes* seldom lay eggs on the water surface, impoundments serve to reduce the availability of suitable egg-laying sites. Furthermore, at least during the breeding season, water level fluctuations can be essentially eliminated, thus many of the eggs which are laid do not receive the hatching stimulus. Finally, the constant presence of many mosquito-eating fish also help to reduce mosquito densities.

Many of Florida's mosquito impoundments are on private property. The landowners can require the local mosquito district to remove the water and often exercise this right when they are attempting to sell their property. Once drained, the diked area can quickly revert back to a major mosquito breeding site by a rapid influx of mosquitoes from uncontrolled habitats. In the Florida Bay region, particularly within the confines of the Everglades National Park, there are thousands of acres of tidelands where mosquito breeding occurs in the absence of any type of control activity. Another problem associated with impoundments is the massive die-off of trees, especially the black mangrove *Avicennia nitida* (Jacquin), as a result of submerging the plant's pneumatophores for extended periods (Fig. 12.1). Possibly this could be avoided by filling and draining the impoundments more frequently but it will most likely increase the cost of mosquito control. Moreover, a growing public awareness of the important relationships between the tidelands and the estuarine ecosystem have often caused delay or permanently prevented not only new construction but also the maintenance of ditches, dikes and water-control structures. Therefore, many districts are now beginning to place a greater reliance on chemical methods for the suppression of mosquito populations.

In Florida, Malathion and Dibrom are the insecticides commonly used in adulticide programs in residential areas. Because treatments with these organo-phosphorus insecticides reaches only a relatively small portion of the total mosquito population, the development of resistance has been averted in most

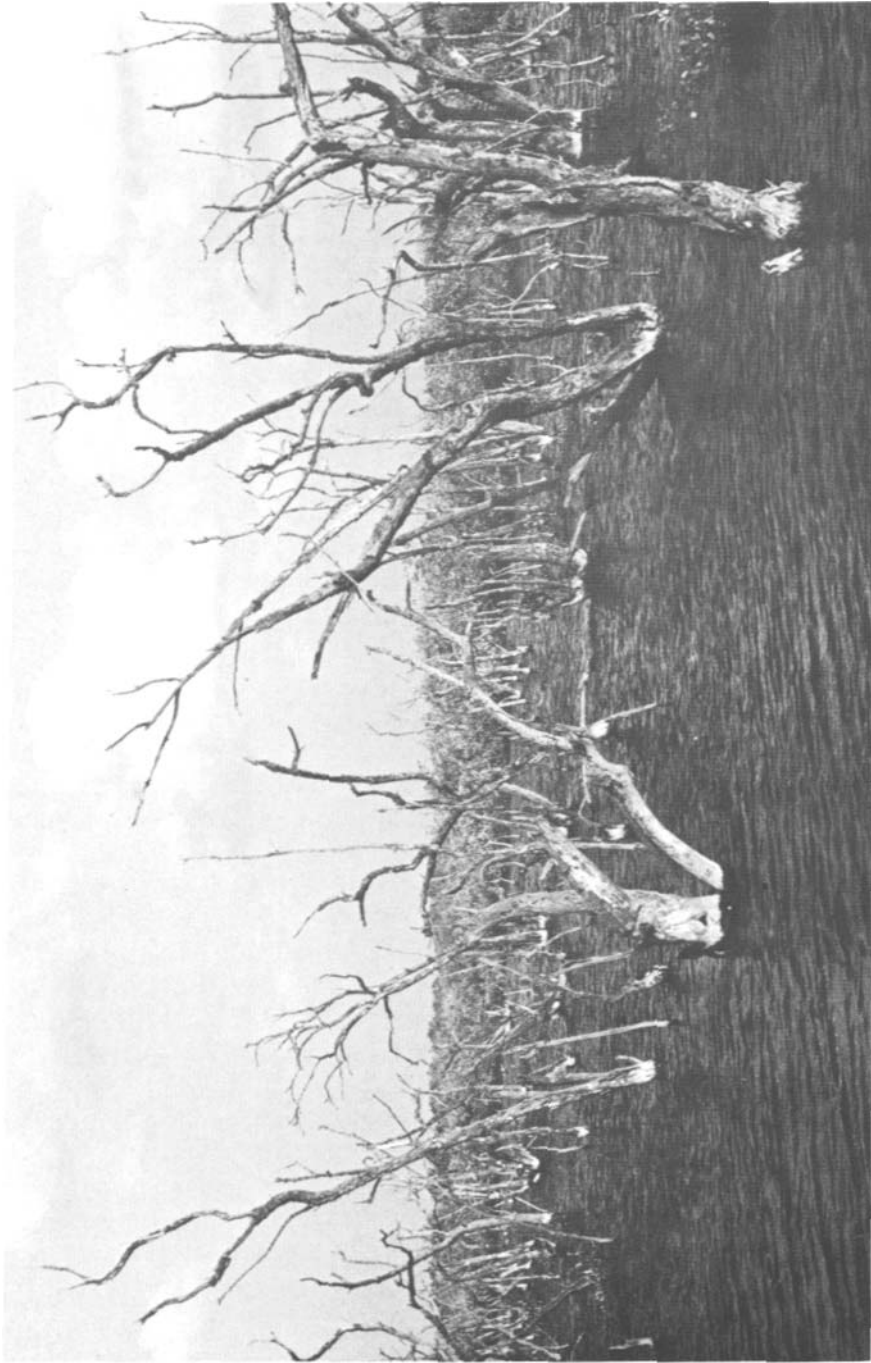

Fig. 12.1. The effects of mosquito control impoundments on the mangrove forest.

areas. However, it is far more economical to concentrate control efforts on the larval stage since adulticide programs only provide temporary relief. Following the curtailment of synthetic organic larvicide usage, diesel oil and granular paris green (aceto-arsenite of copper, a stomach poison) became the standard larvicides in Florida. Diesel oil, especially when mixed with spreading agents acts as a barrier between the air-water interface and rapidly suffocates the larvae. Over grassy saltmarshes the oil can be easily dispensed from aircraft. However, airplane applications of diesel oil to mangrove swamps are often not effective, since much of the oil does not penetrate through the tree tops. Tideland vegetation does not appear to interfere with the application of granular paris green larvicide (Rogers and Rathburn, 1960). Despite the extensive usage of these two compounds for more than 50 years, mosquitoes have developed little if any resistance to them. When applied at the recommended dosage, neither larvicide appears to have detrimental side effects on non-target organisms. Nevertheless, the escalation in oil prices and the frequent shortages in the availability of paris green are causing a return to the usage of synthetic organic larvicides. Whenever these compounds have been used on a widespread basis, the development of resistant mosquito populations has been a chronic problem.

All mosquito control operations in the tidelands exert some adverse effects on non-target organisms to varying degrees. The major challenge facing future control efforts will be the development of more efficient techniques with few if any undesirable side effects on the tideland ecosystem. Only through multi-disciplinary research can we expect to achieve the level of understanding necessary for the development and application of scientifically sound as well as economically feasible management practices (Ferrigno et al., 1969; Lynch and Langford, 1971; La Salle and Knight, 1973; Dukes et al., 1974; La Salle, 1974; Provost, 1974b; De Bord et al., 1975).

### *12.7.2 Recent developments of control measures*

Presently, only a few chemicals are available for the control of mosquitoes and this number is decreasing rapidly as a result of escalating costs, shortages of raw materials, governmental restrictions, and the development of resistant insect populations. There is an urgent need for newer, safer, more effective chemicals such as synthetic growth inhibitors (Schaefer and Wilder, 1973; Mulla et al., 1974, 1975; Steelman et al., 1975).

The integration of biological, chemical and physical methods into tideland mosquito control programs will definitely enhance their effectiveness. Additional research is needed on a variety of basic biological and chemical problems before we can determine the effectiveness of various predators, parasites, and pathogens as regulatory agents.

Pal and LaChance (1974) have evaluated the feasibility of using genetic techniques

for controlling mosquitoes and other blood-sucking arthropods. The sterile male release methods are probably the best developed genetic control approaches (Paterson et al., 1975). Both ionizing radiation and chemicals can be used to induce dominant lethals or other forms of sterility. Additional genetic mechanisms with potential for control include cytoplasmic incompatibility (Yen and Barr, 1971), hybrid sterility (Davidson et al., 1967), chromosomal translocations (Rai et al., 1974), conditioned lethals and meiotic drive (Hickey and Craig, 1966). Among tideland mosquitoes, most investigations on genetic control have been applied to the *Anopheles gambiae* complex (Davidson, 1969).

We have to overcome many problems before genetic techniques can be successfully applied to mosquito control programs. For example, the lethality associated with chromosomal translocations, hybrid sterility, and certain forms of cytoplasmic incompatibility is usually restricted to the very early larval stages which appear to have strongly density-dependent population-regulating factors. Some of the mortality achieved by current genetic control methods may be counterbalanced by an increase in the survival rates of the remainder of the population. We need to devise genetic techniques that cause mortality in the later developmental stages, thus complementing the population reduction brought about by density-dependent factors.

## REFERENCES

- Anderson, J.F. (1968) Influence of photoperiod and temperature on the induction of diapause in *Aedes atropalpus* (Diptera: Culicidae). *Entomol. Exp. Appl.* 11, 321–330.
- Anderson, J.F. (1970) Induction and termination of embryonic diapause in the salt marsh mosquito, *Aedes sollicitans* (Diptera: Culicidae). *Conn. Exp. Stn Bull.* 711, 5–22.
- Bay, E.C. (1974) Predator-prey relationships among aquatic insects. *Annu. Rev. Entomol.* 19, 441–453.
- Belkin, J.N. (1962) The Mosquitoes of the South Pacific (Diptera, Culicidae). Vol. 1. ( ) 608 pp.
- Bickley, W.E. (1972) Some aspects of the behavior of mosquito larvae (Diptera: Culicidae). *J. Wash. Acad. Sci.* 62, 261–264.
- Bidlingmayer, W.L. (1964) The effect of moonlight on the flight activity of mosquitoes. *Ecology* 45, 87–94.
- Bidlingmayer, W.L. (1966) Use of the truck trap for evaluating adult mosquito populations. *Mosquito News* 26, 139–143.
- Bidlingmayer, W.L. (1967) A comparison of trapping methods for adult mosquitoes: species response and environmental influence. *J. Med. Entomol.* 4, 200–220.
- Bidlingmayer, W.L. (1974) The influence of environmental factors and physiological stage on flight patterns of mosquitoes taken in vehicle aspirator and truck, suction, bait and New Jersey traps. *J. Med. Entomol.* 11, 119–146.
- Bidlingmayer, W.L. and Edman, J.D. (1967) Vehicle mounted aspirators. *Mosquito News* 27, 407–411.
- Bidlingmayer, W.L. and Hem, D.G. (1973) Sugar feeding by Florida mosquitoes. *Mosquito News* 33, 535–538.

- Bidlingmayer, W.L. and Schoof, H.F. (1957) The dispersal characteristics of the salt-marsh mosquito, *Aedes taeniorhynchus* (Wiedemann), near Savannah, Georgia. *Mosquito News* 17, 202–212.
- Brust, R.A. (1974) Reproductive isolation within the *Aedes atropalpus* group, and description of eggs. *J. Med. Entomol.* 11, 459–466.
- Bryan, J.H. (1970) A new species of the *Anopheles punctulatus* complex. *Trans. R. Soc. Trop. Med. Hyg.* 64, 28.
- Bryan, J.H. (1973a) Studies on the *Anopheles punctulatus* complex. I. Identification by proboscis morphological criteria and cross-mating experiments. *Trans. R. Soc. Trop. Med. Hyg.* 67, 64–69.
- Bryan, J.H. (1973b) Studies on the *Anopheles punctulatus* complex II. Hybridization of the member species. *Trans. R. Soc. Trop. Med. Hyg.* 67, 70–84.
- Bryan, J.H. (1973c) Studies on the *Anopheles punctulatus* complex III. Mating behaviour of the F<sub>1</sub> hybrid adults from crosses between *Anopheles farauti* No. 1 and *Anopheles farauti* No. 2. *Trans. R. Soc. Trop. Med. Hyg.* 67, 85–91.
- Bryan, J.H. and Coluzzi, M. (1971) Cytogenetic observations on *Anopheles farauti* Laveran. *Bull. WHO* 45, 266–267.
- Chapman, H.C., Gorham, J.R. and Fukuda, T. (1973) *Thelohania* (Nosematidae: Microsporidia) in *Aedes* mosquitoes of Alaska. *Mosquito News* 33, 465–466.
- Chapman, H.C., Woodard, D.B., Kellen, W.R. and Clark, T.B. (1966) Host-parasite relations of *Thelohania* associated with mosquitoes in Louisiana (Nosematidae: Microsporidia). *J. Invert. Pathol.* 8, 452–456.
- Clay, M.E. and Venard, C.E. (1971) Diapause in *Aedes triseriatus* (Diptera: Culicidae) larvae terminated by molting hormones. *Ann. Entomol. Soc. Am.* 64, 968–970.
- Coluzzi, M. (1968) Cromosomi politenici delle cellule nutrici ovariche nel complesso *gambiae* del genere *Anopheles*. *Parassitologia* 10, 179–184.
- Coluzzi, M. and Bullini, L. (1971) Enzyme variants as markers in the study of pre-copulatory isolating mechanisms. *Nature* 231, 455–456.
- Coluzzi, M. and Sabatini, A. (1968) Divergenze morfologiche e barriere di sterilita nel complesso *Aedes mariae* (Diptera, Culicidae). *Riv. Parassitol.* 29, 49–70.
- Coluzzi, M. and Sabatini, A. (1969) Cytogenetic observations on the salt water species, *Anopheles merus* and *Anopheles melas*, of the *gambiae* complex. *Parassitologia* 11, 177–187.
- Coluzzi, M., Bullini, L. and Bianchi Bullini, A.P. (1971) Phosphoglucosomutase polymorphism in *Aedes phoeniciae* Coluzzi & Sabatini of the *Ae. mariae* complex (Dipt., Culicidae). *Bull. Entomol. Res.* 61, 327–330.
- Corbet, P.S. (1964) Autogeny and oviposition in arctic mosquitoes. *Nature* 203, 669.
- Corbet, P.S. (1967) Facultative autogeny in arctic mosquitoes. *Nature* 215, 662–663.
- Craig, G.B., Jr. (1967) Mosquitoes: female monogamy induced by male accessory gland substance. *Science* 156, 1499–1501.
- Craig, G.B., Jr. and Horsfall, W.R. (1960) Eggs of Floodwater mosquitoes. VII. Species of *Aedes* common in the southeastern United States (Diptera: Culicidae). *Ann. Entomol. Soc. Am.* 53, 11–18.
- Davidson, G. (1969) The potential use of sterile hybrid males for the eradication of member species of the *Anopheles gambiae* complex. *Bull. WHO* 40, 221–228.
- Davidson, G., Paterson, H.E., Coluzzi, M., Mason, G.F. and Micks, D.W. (1967) The *Anopheles gambiae* complex. In: *Genetics of Insect Vectors of Disease*. (J.W. Wright and R. Pal, Eds.), pp. 211–250.
- De Bord, D.V., Carlson, G.A. and Axtell, R.C. (1975) Demand for and cost of coastal salt marsh mosquito abatement. *Tech. Bull. No. 232 N. C. Agric. Exp. Stn* 85 p.
- Decoursey, J.D. and Webster, A.P. (1952) A method of clearing the chorion of *Aedes sollicitans* (Walker) eggs and preliminary observations on their embryonic development. *Ann. Entomol. Soc. Am.* 45, 625–632.

- Dow, R.P. and Gerrish, G.M. (1970) Day-to-day change in relative humidity and the activity of *Culex nigripalpus* (Diptera: Culicidae). *Ann. Entomol. Soc. Am.* 63, 995–999.
- Downes, J.A. (1965) Adaptations of insects in the arctic. *Annu. Rev. Entomol.* 10, 257–274.
- Dukes, J.C., Axtell, R.C. and Knight, K.L. (1974) Additional studies of the effects of saltmarsh impoundments on mosquito populations. (Report No. 102, ) 38 pp.
- Edman, J.D. (1974) Host-feeding patterns of Florida mosquitoes IV. *Deinocerites*. *J. Med. Entomol.* 11, 105–107.
- Edman, J.D. and Kale, H.W., II. (1971) Host behavior: Its influence on the feeding success of mosquitoes. *Ann. Entomol. Soc. Am.* 64, 513–516.
- Edman, J.D., Webber, L.A. and Kale, H.W., II. (1972a) Effect of mosquito density on the interrelationship of host behavior and mosquito feeding success. *Am. J. Trop. Med. Hyg.* 21, 487–491.
- Edman, J.D., Haeger, J.S., Bidlingmayer, W.L., Dow, R.P., Nayar, J.K. and Provost, M.W. (1972b) Sexual behavior of mosquitoes. 4. Field observations on mating and insemination of marked broods of *Aedes taeniorhynchus*. *Ann. Entomol. Soc. Am.* 65, 848–852.
- Elmore, C.M., Jr. and Schoof, H.F. (1963) Dispersal of *Aedes taeniorhynchus* Wiedemann near Savannah, Georgia. *Mosquito News* 23, 1–7.
- Ferrigno, F., MacNamara, L.G. and Jobbins, D.M. (1969) Ecological approach for improved management of coastal wetlands. *Proc. N.J. Mosquito Exterm. Assoc.* 56, 188–202.
- Fukuda, T. and Clark, T.B. (1975) Transmission of mosquito iridescent virus (RMIV) by adult mosquitoes of *Aedes taeniorhynchus* to their progeny. *J. Invert. Pathol.* 25, 275–276.
- Fukuda, T. and Woodard, D.B. (1974) Hybridization of *Aedes sollicitans* (Walker) and *Aedes nigro-maculis* (Ludlow) by induced copulation. *Mosquito News* 34, 71–76.
- Giglioli, M.E.C. (1964) Tides, salinity, and breeding of *Anopheles melas* Theo. 1903, during the dry season in Gambia. *Riv. Malariol.* 43, 245–263.
- Giglioli, M.E.C. (1965) Oviposition by *Anopheles melas* and its effect on egg survival during the dry season in Gambia, West Africa. *Ann. Entomol. Soc. Am.* 58, 885–891.
- Gillett, J.D. (1959) Control of hatching in the prediapause eggs of *Aedes* mosquitoes. *Nature* 184, 1621–1623.
- Gillies, M.T. (1974) Methods for assessing the density and survival of blood-sucking Diptera. *Annu. Rev. Entomol.* 19, 345–362.
- Guichard, M. (1971) Etude in vivo du développement embryonnaire de *Culex pipiens*. Comparaison avec *Calliphora erythrocephala* (Diptera). *Ann. Soc. Entomol. Fr. (N. S.)* 7, 325–341.
- Gwadz, R.W. and Craig, G.B., Jr. (1970) Female polygamy due to inadequate semen transfer in *Aedes aegypti*. *Mosquito News* 30, 355–360.
- Gwadz, R.W., Lounibos, L.P. and Craig, G.B., Jr. (1971) Precocious sexual receptivity induced by a juvenile hormone analog in females of the yellow fever mosquito, *Aedes aegypti*. *Gen. Comp. Endocrinol.* 16, 47–51.
- Haeger, J.S. (1955) The non-blood feeding habits of *Aedes taeniorhynchus* (Diptera: Culicidae) on Sanibel Island, Florida. *Mosquito News* 15, 21–26.
- Haeger, J.S. and O'Meara, G.F. (1970) Rapid incorporation of wild genotypes of *Culex nigripalpus* (Diptera: Culicidae) into laboratory-adapted strains. *Ann. Entomol. Soc. Am.* 63, 1390–1391.
- Haeger, J.S. and Phinzee, J. (1959) The biology of the crabhole mosquito, *Deinocerites cancer* Theobald. *Proc. Fla. Anti-Mosquito Assoc.* 34–37.
- Harrington, R.W., Jr. and Harrington, E.S. (1961) Food selection among fishes invading a high subtropical salt marsh: from onset of flooding through the process of a mosquito brood. *Ecology* 42, 646–665.
- Harrington, R.W., Jr. and Harrington, E.S. (1972) Food of female Marsh Killifish, *Fundulus confluentus* Goode and Bean, in Florida. *Am. Midl. Nat.* 87, 492–502.



- Hickey, W.A. and Craig, G.B., Jr. (1966) Distortion of sex ratio in populations of *Aedes aegypti*. *Can. J. Genet. Cytol.* 8, 260–278.
- Hocking, B. (1953) Notes on the activities of *Aedes larvae*. *Mosquito News* 13, 77–81.
- Horsfall, W.R., Voorhees, F.R. and Cupp, E.W. (1970) Eggs of Floodwater Mosquitoes. XIII. Chorionic sculpturing. *Ann. Entomol. Soc. Am.* 63, 1709–1716.
- Horsfall, W.R., Fowler, H.W., Jr., Moretti, L.J. and Larsen, J.R. (1973) Bionomics and Embryology of the Inland Floodwater Mosquito *Aedes vexans*. ( ) 211 pp.
- Hudson, A. and McLintock, J. (1967) A chemical factor that stimulates oviposition by *Culex tarsalis* Coquillett (Diptera, Culicidae). *Anim. Behav.* 15, 336–341.
- Idris, B.E.M. (1960) Die Entwicklung im normalen Ei von *Culex pipiens* L. (Diptera). *Z. Morphol. Okol. Tiere* 49, 387–429.
- Ikeshoji, T. and Mulla, M.S. (1970a) Oviposition attractants for four species of mosquitoes in natural breeding waters. *Ann. Entomol. Soc. Am.* 63, 1322–1327.
- Ikeshoji, T. and Mulla, M.S. (1970b) Overcrowding factors of mosquito larvae. *J. Econ. Entomol.* 63, 90–96.
- Ivanova, L.V. (1940) The influence of temperature on the behavior of the *Anopheles maculipennis* larvae. *Med. Parasitol., Moscow* 9, 58–70.
- Ivanova-Kazas, O.M. (1947) Stages of the embryonic development of *Anopheles maculipennis*. *C.R. Acad. Sci. USSR, Moscow* 56, 325–327.
- Kellen, W.R., Chapman, H.C., Clark, T.B. and Lindegren, J.E. (1965) Host-parasite relationships of some *Thelohania* from mosquitoes (Nosematidae: Microsporidia). *J. Invert. Pathol.* 7, 161–166.
- Kreutzer, R.D. and Kitzmiller, J.B. (1971) Hybridization between *Anopheles crucians* and *Anopheles bradleyi*. *Evolution* 25, 195–206.
- LaSalle, R. (1974) The influence of slope and frequency of flooding of a breeding depression on mosquito populations in salt marshes. *Proc. Calif. Mosquito Control Assoc.* 42, 43–47.
- LaSalle, R.N. and Knight, K.L. (1973) The effects of ditching on the mosquito populations in some sections of Juncus salt marsh in Carteret County, North Carolina. ( Rep. No. 82, ) 162 pp.
- Lea, A.O. (1963) Some relationships between environment, corpora allata, and egg maturation in aedine mosquitoes. *J. Insect Physiol.* 9, 793–809.
- Lea, A.O. (1964) Studies on the dietary and endocrine regulation of autogenous reproduction in *Aedes taeniorhynchus* (Wied.). *J. Med. Entomol.* 1, 40–44.
- Lea, A.O. (1967) The medial neurosecretory cells and egg maturation in mosquitoes. *J. Insect Physiol.* 13, 419–429.
- Lea, A.O. (1968) Mating without insemination in virgin *Aedes aegypti*. *J. Insect Physiol.* 14, 305–308.
- Lea, A.O. (1970) Endocrinology of egg maturation in autogenous and anautogenous *Aedes taeniorhynchus*. *J. Insect Physiol.* 16, 1689–1696.
- Lea, A.O. and Evans, D.G. (1972) Sexual behavior of mosquitoes. I. Age dependence of copulation and insemination of the *Culex pipiens* complex and *Aedes taeniorhynchus* in the laboratory. *Ann. Entomol. Soc. Am.* 65, 285–289.
- Lea, A.O. and Van Handel, E. (1970) Suppression of glycogen synthesis in the mosquito by a hormone from the medial neurosecretory cells. *J. Insect Physiol.* 16, 319–321.
- Linley, J.R. and Evans, D.G. (1971) Behavior of *Aedes taeniorhynchus* larvae and pupae in a temperature gradient. *Entomol. Exp. Appl.* 14, 319–332.
- Linley, J.R. and Nielsen, H.T. (1968a) Transmission of mosquito iridescent virus in *Aedes taeniorhynchus*. I. Laboratory experiments. *J. Invert. Pathol.* 12, 7–16.
- Linley, J.R. and Nielsen, H.T. (1968b) Transmission of a mosquito iridescent virus in *Aedes taeniorhynchus*. II. Experiments related to transmission in nature. *J. Invert. Pathol.* 12, 17–24.
- Lum, P.T.M. (1963) The infection of *Aedes taeniorhynchus* (Wiedemann) and *Psorophora howardi* Coquillett by the fungus *Coelomomyces*. *J. Insect Pathol.* 5, 157–166.

- Lum, P.T.M., Nayar, J.K. and Provost, M.W. (1968) The pupation rhythm in *Aedes taeniorhynchus* (Wiedemann) (Diptera: Culicidae). III. Factors in developmental synchrony. *Ann. Entomol. Soc. Am.* 61, 889–899.
- Lynch, E.E. and Langford, G.S. (1971) Construction practices for mosquito control and wetland conservation. *Proc. N. J. Mosquito Exterm. Assoc.* 58, 174–179.
- Martin, D.H., Chaniotis, B.N. and Tesh, R.B. (1973) Host preferences of *Deinocerites pseudus* Dyar and Knab. *J. Med. Entomol.* 10, 206–208.
- Martin, D.H., Eddy, G.A., Sudia, W.D., Reeves, W.C., Newhouse, V.F. and Johnson, K.M. (1972) An epidemiological study of Venezuelan equine encephalomyelitis in Costa Rica, 1970. *Am. J. Epidemiol.* 95, 565–578.
- McDaniel, I.N. and Horsfall, W.R. (1957) Induced copulation of aedine mosquitoes. *Science* 125, 745.
- McGaughey, W.H. (1968) Role of salts in oviposition site selection by the black salt-marsh mosquito, *Aedes taeniorhynchus* (Wiedemann). *Mosquito News* 28, 207–217.
- McGaughey, W.H. and Knight, K.L. (1967) Preoviposition activity of the black salt-marsh mosquito, *Aedes taeniorhynchus* (Diptera: Culicidae). *Ann. Entomol. Soc. Am.* 60, 107–115.
- Moore, C.G. and Fisher, B.R. (1969) Competition in mosquitoes. Density and species ratio effects on growth, mortality, fecundity, and production of growth retardant. *Ann. Entomol. Soc. Am.* 62, 1325–1331.
- Mulla, M.S., Darwazeh, H.A. and Norland, R.L. (1974) Insect growth regulators: Evaluation procedures and activity against mosquitoes. *J. Econ. Entomol.* 67, 329–332.
- Mulla, M.S., Magori, G. and Darwazeh, H.A. (1975) Effects of the insect growth regulator Dimilin or TH 6040 on mosquitoes and some nontarget organisms. *Mosquito News* 35, 211–216.
- Nayar, J.K. (1967) Endogenous diurnal rhythm of pupation in a mosquito population. *Nature* 214, 828–829.
- Nayar, J.K. (1968) The pupation rhythm in *Aedes taeniorhynchus*. IV. Further studies of the endogenous diurnal (circadian) rhythm of pupation. *Ann. Entomol. Soc. Am.* 61, 1408–1417.
- Nayar, J.K. and Sauerman, D.M., Jr. (1968) Larval aggregation formation and population density interrelations in *Aedes taeniorhynchus*, their effects on pupal ecdysis and adult characteristics at emergence. *Entomol. Exp. Appl.* 11, 423–442.
- Nayar, J.K. and Sauerman, D.M., Jr. (1969) Flight behavior and phase polymorphism in the mosquito *Aedes taeniorhynchus*. *Entomol. Exp. Appl.* 12, 365–375.
- Nayar, J.K. and Sauerman, D.M., Jr. (1971) The effects of diet on lifespan, fecundity and flight potential of *Aedes taeniorhynchus* adults. *J. Med. Entomol.* 8, 506–513.
- Nayar, J.K. and Van Handel, E. (1971) The fuel for sustained mosquito flight. *J. Insect Physiol.* 17, 471–481.
- Nielsen, E.T. and Haeger, J.S. (1954) Pupation and emergence in *Aedes taeniorhynchus* (Diptera: Culicidae). *Bull. Entomol. Res.* 45, 757–768.
- Nielsen, E.T. and Haeger, J.S. (1960) Swarming and mating in mosquitoes. *Entomol. Soc. Am. Misc. Publ.* 1, 71–95.
- Nielsen, E.T. and Nielsen, A.T. (1953) Field observations on the habits of *Aedes taeniorhynchus*. *Ecology* 34, 141–156.
- Nielsen, H.T. and Nielsen, E.T. (1962) Swarming of mosquitoes, laboratory experiments under controlled conditions. *Entomol. Exp. Appl.* 5, 14–32.
- Omardeen, T.A. (1957) The behaviour of larvae and pupae of *Aedes aegypti* (L.) in light and temperature gradients. *Bull. Entomol. Res.* 48, 349–357.
- O'Meara, G.F. (1975) Lethal traits associated with the bleached-eye color mutant of *Aedes taeniorhynchus*. *Ann. Entomol. Soc. Am.* 68, 157–162.
- O'Meara, G.F. and Edman, J.D. (1975) Autogenous egg production in the salt-marsh mosquito, *Aedes taeniorhynchus*. *Biol. Bull.* 149, 384–396.

- O'Meara, G.F. and Evans, D.G. (1973) Blood-feeding requirements of the mosquito: Geographical variation in *Aedes taeniorhynchus*. *Science* 180, 1291–1293.
- O'Meara, G.F. and Evans, D.G. (1974) Female-dependent stenogamy in the mosquito, *Aedes taeniorhynchus*. *Anim. Behav.* 22, 376–381.
- O'Meara, G.F. and Krasnick, G.J. (1970) Dietary and genetic control of the expression of autogenous reproduction in *Aedes atropalpus* (Coq.) (Diptera: Culicidae). *J. Med. Entomol.* 7, 328–334.
- O'Meara, G.F., Knight, J.W. and Evans, D.G. (1974) Experimental hybridization between *Aedes sollicitans* (Walker) and *Aedes mitchellae* (Dyar). *Mosquito News* 34, 457–461.
- Pal, R. and LaChance, L.E. (1974) The operational feasibility of genetic methods for control of insects of medical and veterinary importance. *Annu. Rev. Entomol.* 19, 269–291.
- Patterson, R.S., Sharma, V.P., Singh, K.R.P., LaBrecque, G.C., Seetheram, P.L. and Grover, K.K. (1975) Use of radio-sterilized males to control indigenous populations of *Culex pipiens quinque-fasciatus* Say: Laboratory and field studies. *Mosquito News* 35, 1–7.
- Pausch, R.D. and Provost, M.W. (1965a) The dispersal of *Aedes taeniorhynchus*. IV. Controlled field production. *Mosquito News* 25, 1–8.
- Pausch, R.D. and Provost, M.W. (1965b) The dispersal of *Aedes taeniorhynchus*. V. A controlled synchronous emergence. *Mosquito News* 25, 9–14.
- Peters, T.M., Chevone, B.I. and Callahan, R.R. (1969) Interactions between larvae of *Aedes aegypti* (L.) and *Culex pipiens* L. in mixed experimental populations. *Mosquito News* 29, 435–438.
- Petersen, J.J. (1969) Oviposition response of *Aedes sollicitans*, *Aedes taeniorhynchus* and *Psorophora confinnis* to seven inorganic salts. *Mosquito News* 29, 472–483.
- Petersen, J.J. and Chapman, H.C. (1970) Chemical characteristics of habitats producing larvae of *Aedes sollicitans*, *Aedes taeniorhynchus* and *Psorophora confinnis* in Louisiana. *Mosquito News* 30, 156–161.
- Petersen, J.J., Chapman, H.C. and Woodard, D.B. (1967) Preliminary observations on the incidence and biology of a mermithid nematode of *Aedes sollicitans* (Walker) in Louisiana. *Mosquito News* 27, 493–198.
- Peyton, E.L., Reinert, J.F. and Peterson, N.E. (1964) The occurrence of *Deinocerites pseudes* Dyar and Knab in the United States, with additional notes on the biology of *Deinocerites* species of Texas. *Mosquito News* 24, 449–458.
- Pillai, J.S. and O'Loughlin, I.H. (1972) *Coelomomyces opifexi* (Pillai and Smith). Coelomomyce-taceae: Blastocladales. II. Experiments in sporangial germination. *Hydrobiologia* 40, 77–86.
- Provost, M.W. (1952) The dispersal of *Aedes taeniorhynchus*. I. Preliminary studies. *Mosquito News* 12, 174–190.
- Provost, M.W. (1957) The dispersal of *Aedes taeniorhynchus*. II. The second experiment. *Mosquito News* 17, 233–247.
- Provost, M.W. (1959) The influence of moonlight on light-trap catches of mosquitoes. *Ann. Entomol. Soc. Am.* 52, 261–271.
- Provost, M.W. (1974a) The dispersal and migration of mosquitoes. (Proc. Mosquito Seminar and Work Conference, ) p. 4–39.
- Provost, M.W. (1974b) Salt marsh management in Florida. (Proc. Tall Timbers Conf. on Ecol. Anim. Control by Habitat Mgmt, 1973, p. 5–17.
- Provost, M.W. and Haeger, J.S. (1967) Mating and pupal attendance in *Deinocerites cancer* and comparisons with *Opifex fuscus* (Diptera: Culicidae). *Ann. Entomol. Soc. Am.* 60, 565–574.
- Provost, M.W. and Lum, P.T.M. (1967) The pupation rhythm in *Aedes taeniorhynchus* (Diptera: Culicidae). I. Introduction. *Ann. Entomol. Soc. Am.* 60, 138–149.
- Provost, M.W., Lum, P.T.M. and Branch, N. (1961) Rotation of male terminalia in *Aedes taeniorhynchus* (Diptera: Culicidae) as affected by temperature. *Ann. Entomol. Soc. Am.* 54, 896–900.
- Pucat, A.M. (1965) The functional morphology of the mouthparts of some mosquito larvae. *Quaest. Entomol.* 1, 41–86.

- Rai, K.S., Lorimer, N. and Hallinan, E. (1974) The present status of genetic methods for controlling *Aedes aegypti*. In: The Use of Genetics in Insect Control. (R. Pal and M.J. Whitten, Eds.) , , pp. 119–132.
- Roberts, D.W., Shapiro, M. and Rodin, R.L. (1973) Dehiscence of *Coelomomyces psorophorae* sporangia from *Aedes taeniorhynchus*: Induction by amines and amino acids. *J. Invert. Pathol.* 22, 175–181.
- Rogers, A.J. and Rathburn, C.B., Jr. (1960) Airplane application of granular paris green mosquito larvicide. *Mosquito News* 20, 105–110.
- Rioux, J.A., Croset, H., Gabinaud, A., Papierok, B. and Belmonte, A. (1973) Monofactorial inheritance of autogeny in *Aedes (Ochlerotatus) detritus* (Dipt., Culicidae). *C. R. Acad. Sci. Paris Ser. D.* 276, 991–994.
- Sanders, D.P., Rieme, M.E. and McNeill, J.C., IV. (1968) Saltmarsh mosquito control in relation to beef cattle production. A preliminary report. *Mosquito News* 28, 311–313.
- Schaefer, C.H. and Wilder, W.H. (1973) Insect developmental inhibitors. 2. Effects on target mosquito species. *J. Econ. Entomol.* 66, 913–916.
- Service, M.W. (1971) Feeding behaviour and host preferences of British mosquitoes. *Bull. Entomol. Res.* 60, 653–661.
- Service, M.W. (1972) An inland freshwater population of the salt marsh mosquito, *Aedes detritus* (Haliday) *J. Entomol. Ser. A* 46, 117–121.
- Smith, S.M. and Brust, R.A. (1970) Autogeny and stenogamy of *Aedes rempeli* (Diptera: Culicidae) in Arctic Canada. *Can. Entomol.* 102, 253–256.
- Snow, W.F. and Boreham, P.F.L. (1973) The feeding habits of some West African *Culex* (Dipt., Culicidae) mosquitoes. *Bull. Entomol. Res.* 62, 517–526.
- Spielman, A. (1974) Effect of synthetic juvenile hormone on ovarian diapause of *Culex pipiens* mosquitoes. *J. Med. Entomol.* 11, 223–225.
- Steelman, C.D., Farlow, J.E., Breaud, T.P. and Schilling, P.E. (1975) Effects of growth regulators on *Psorophora columbiae* (Dyar and Knab) and non-target aquatic insect species in rice fields. *Mosquito News* 35, 67–76.
- Sudia, W.D. (1972) Arthropod vectors of epidemic Venezuelan equine encephalitis. In: *Venezuelan Encephalitis*. Sept. 1971. (Publ. No. 243) pp. 157–161.
- Surtees, G. (1959) Functional and morphological adaptations of the larval mouthparts in the subfamily culicinae (Diptera) with a review of some related studies by Montschadsky. *Proc. R. Entomol. Soc. Lond. (A)* 34, 7–16.
- Tempelis, C.H. (1975) Host-feeding patterns of mosquitoes, with a review of advances in analysis of blood meals by serology. *J. Med. Entomol.* 11, 635–653.
- Tempelis, C.H. and Galindo, P. (1970) Feeding habits of five species of *Deinocerites* mosquitoes collected in Panama. *J. Med. Entomol.* 7, 175–179.
- Van Handel, E. (1972) The detection of nectar in mosquitoes. *Mosquito News* 32, 458.
- Van Handel, E. and Lum, P.T.M. (1961) Sex as regulator of triglyceride metabolism in the mosquito. *Science* 134, 1979–1980.
- Webber, L.A. and Edman, J.D. (1972) Anti-mosquito behaviour of Ciconiiform birds. *Anim. Behav.* 20, 228–232.
- White, G.B. (1974) *Anopheles gambiae* complex and disease transmission in Africa. *Trans. R. Soc. Trop. Med. Hyg.* 68, 278–298.
- Work, T.H. (1972) Summary of the workshop-symposium. In: *Venezuelan Encephalitis*. Sept. 1971. (Publ. No. 243.) pp. 410–416.
- Yen, J.H. and Barr, A.R. (1971) New hypothesis of the cause of cytoplasmic incompatibility in *Culex pipiens* L. *Nature* 232, 657–658.

## **Biting midges of mangrove swamps and salt-marshes (Diptera: Ceratopogonidae)**

John R. Linley

<b>Contents</b>		
13.1	Introduction	335
13.2	General morphology	337
	13.2.1 Adult	340
	13.2.2 Larva	344
	13.2.3 Pupa	344
13.3	Systematics	344
13.4	Biology	346
	13.4.1 Habitats	346
	13.4.2 Life history	350
	13.4.3 Predators and parasites	360
13.5	Ecology	361
	13.5.1 Special adaptations	361
	13.5.2 Habitat requirements	362
13.6	Special considerations	362
	13.6.1 Midges as disease vectors and pests	362
	13.6.2 Control	363
	13.6.3 Concluding remarks	364
	Acknowledgements	365
	References	365

### 13.1 INTRODUCTION

Members of the Ceratopogonidae are small to very small (length 1.5–4.0 mm) two-winged flies in the Order Diptera (Nematocera). The family is world-wide in its distribution and includes representatives in most habitats where wet or damp substrates suitable for the larvae are found. Larval ceratopogonids are seldom

wholly aquatic or terrestrial, but occupy an intermediate ecotone (Kettle, 1962), in which moisture is always present. Such habitats include river and stream banks, mangrove swamps, estuaries and saltmarshes, bogland, lakeshores, dung, rotting fruit and other vegetable matter, crabholes, bromeliads, tree-holes and even fungi. Feeding habits among the adults render the group economically important and of considerable scientific interest. Three genera, *Culicoides*, *Leptoconops* and *Lasiohelea* are almost exclusively hematophagous and feed on vertebrate blood, principally that of mammals and birds. Some entomophagous species of the genus *Forcipomyia* suck the blood of other insects, including dragonflies, lacewings, caterpillars and stick insects. Remarkable photographs of grossly swollen *F. obesa* Costa Lima taking blood from a stick insect are to be seen in Wirth (1971). While such species are parasitic, representatives of the genera *Palpomyia*, *Ceratopogon* and *Serromyia* are predatory on other small insects of approximately their own size. The prey is captured in flight and killed as the body fluids are sucked out.

It is, of course, the blood-sucking ceratopogonids, particularly of the genus *Culicoides* (Fig. 13.1) that are most familiar. Common names include 'gnats', 'no-see-ums', 'midges', 'sandflies', 'brûlots' (French Canada), 'arabis' (France), 'jejenes' (Cuba) and 'punkies'. Although widely used in the United States and West Indies, the term 'sandflies' is potentially confusing since it is used also in reference to blood-sucking members of the Psychodidae, another family of very small flies.

Ceratopogonids are economically important in several respects. Some are vectors of pathogenic organisms, among which causative agents of animal diseases are the most important. Others are serious pests of man and animals and may affect the use of land over very extensive areas. Marine species are particularly important as pests, to the point of having serious effects on the regional economy in coastal areas (Linley and Davies, 1971). Less well known is the beneficial role of certain midges as pollinators of crop plants such as cacao (Posnette, 1944; Kaufmann, 1975) and Para rubber (Warmke, 1951, 1952).

It is most practical to regard as marine those species whose pre-adult stages are passed in marine environments. There are 3 important genera in this sense – *Culicoides*, *Leptoconops* and *Dasyhelea*. Of these, *Culicoides* is the most important economically and contains the greatest number of species. Arnaud and Wirth (1964), adding to an earlier compilation by Arnaud (1956), listed approximately 800 world species at that time. The number has now risen to about 1000, of which 50–60 may, at least rarely, be associated with marine habitats. *Leptoconops* comprises a total of about 70 species, as listed in the most recent systematic treatment of the genus (Wirth and Atchley, 1973), in which five subgenera are recognized. In this article, the subgenus will be given only at the first reference to a particular species, but not subsequently. There are 9 species of marine *Leptoconops*, some of considerable economic importance. *Dasyhelea*, a difficult genus

taxonomically, contains over 300 species, but very little work has been done on the immature stages. Consequently, the larval habitats are very poorly known and the extent to which this genus is marine remains an open question. Very probably, marine representation among *Dasyhelea* is considerable (Wirth, 1976).

No simplified key to the three marine genera is given for two reasons. Firstly, although these genera are the most important with marine representatives, the omission of others indicates our lack of knowledge rather than reality. There are doubtless many as yet unrecognized marine species of genera that would not appear in the key. Secondly, the recognition of ceratopogonid genera is not a simple matter and cannot be made so. Correct diagnosis depends upon experience with the characters of the group and working familiarity with the various genera represented in a given locality. At the present time, a complete and comprehensive revision of the genera of the world is in preparation by W.W. Wirth, N.C. Ratana-worabhan and F.S. Blanton. Since publication is not anticipated for some years, these authors have released a synoptic treatment (Wirth et al., 1974), which incorporates the best keys available.

### 13.2 GENERAL MORPHOLOGY

The following generalized and condensed description of adult structure in *Culicoides*, as representative of Ceratopogonidae, is drawn from more complete accounts by Carter et al. (1920), Wirth (1952a), Wirth and Blanton (1959) and Atchley (1967, 1970). The illustrations (Figs 13.1 and 13.2) accompanying the morphological description are for *Culicoides furens* (Poey), economically one of the most important marine species. More detailed studies of the head and mouthparts have been made by Jobling (1928) and Gad (1951), anatomy of the genitalia by Pomerantzev (1932), and anatomy and histology of the alimentary tract by Megahed (1956). Two electron microscopic studies have been made of the antennal and palpal sensilla in *Culicoides* (Rowley and Cornford, 1972; Chu et al., 1975). Gutsevich (1948) has given an account of the anatomy of *Leptoconops (Holoconops) borealis* (Gutsevich).

The most complete account of the anatomy and morphology of immature *Culicoides* was that of Lawson (1951) on *C. nebeculosus*. Good general descriptions are to be found in Carter et al. (1920) and Atchley (1970) for *Culicoides*, while for *Leptoconops*, the best descriptions of the immatures are for the marine species *L. (Leptoconops) irritans* (Noé) (Clastrier, 1971), *L. (Holoconops) kerteszi* (Kieffer) (Clastrier, 1972) and *L. (Styloconops) spinosifrons* (Carter) (Laurence and Mathias, 1972). Painter (1926) has given an account of the larva and pupa of *L. (Holoconops) bequaerti* (Kieffer), a major pest on beaches from Texas to Panama and through the West Indies. The publications of Keilin (1921), Goetghebuer (1925), Thienemann (1926)

and Vattier (1965) may be consulted for more detailed information on immature *Dasyhelea*. Other contributions to the pre-imaginal stages of marine species are given in Table 13.1.

Table 13.1 Major taxonomic references, or ones dealing largely with marine species, by zoogeographic region, for the 3 marine genera of Ceratopogonidae.

Region	Genus	Reference	Specific area, if any	
Nearctic	<i>Culicoides</i>	Battle and Turner (1971)	Virginia	
		Foote and Pratt (1954)	Eastern U.S.	
		Jamback (1965)	N.Y. State	
		Johannsen (1952)	Northeastern U.S.	
		Jorgensen (1969)	Washington State	
		Linley and Kettle (1964) <sup>a</sup>		
		Linley (1965a) <sup>a</sup>		
		Williams (1951b) <sup>a, b</sup>		
		Wirth (1951)	Alaska	
		Wirth (1952a)	California	
		Wirth (1952b) <sup>a, b</sup>		
		Wirth (1969)	N. America	
		<i>Leptoconops</i>	Painter (1926) <sup>a</sup>	
			Smith and Lowe (1948) <sup>a</sup>	
Wirth and Atchley (1973) <sup>c</sup>	N. America			
Neotropical	<i>Dasyhelea</i>	Johannsen (1943)	Americas	
	<i>Culicoides</i>	Forratini (1957)	Entire region	
Forratini and Rabello (1956) <sup>a</sup>				
Forratini et al. (1956) <sup>a</sup>				
Forratini et al. (1960) <sup>a</sup>				
Fox (1942) <sup>a</sup>				
Hogue and Wirth (1968) <sup>a, b</sup>				
Macfie (1948)		Mexico (Chiapas State)		
Ortiz and Leon (1955)		Ecuador		
Painter (1926) <sup>a</sup>		Honduras		
Wirth and Blanton (1973)		Amazon Basin		
Wirth and Blanton (1959)		Panama		
Wirth and Blanton (1974)		West Indies, Gulf Coast of U.S., Central America		
<i>Leptoconops</i>		Wirth and Williams (1957)	Bermuda	
	Cavalieri and Chiossone (1966)	Entire region		
	Painter (1926) <sup>a</sup>	Honduras		
<i>Dasyhelea</i>	Ingram and Macfie (1931)	Patagonia, Chile		
	Wirth and Williams (1957)	Bermuda		
Palaeartic	<i>Culicoides</i>	Arnaud (1956)	Japan, Korea, Ryukyu Islands	



		Boorman (1974)	Cyprus
		Campbell and Pelham-Clinton (1960)	Britain
		Clastrier (1957)	Algeria
		Dzhafarov (1964)	Russia (Transcaucasia)
		Glukhova (1968) <sup>a</sup>	
		Goetghebuer (1920)	Belgium
		Gutsevich (1960)	Russia
		Kettle and Lawson (1952) <sup>a</sup>	Britain
		Kremer (1965)	France
		Kremer et al. (1961)	France
		Kremer et al. (1965)	Poland
		Navai (1970)	Iran
		Remm (1956)	Russia (Estonia)
		Skierska (1973)	Poland
		Tokunaga (1940)	Japan
	<i>Leptoconops</i>	Clastrier (1971) <sup>a, b</sup>	
		Clastrier (1972) <sup>a, b</sup>	
		Clastrier (1973)	France
		Dzhafarov (1961)	Russia (Transcaucasia)
		Dzhafarov (1962a) <sup>a</sup>	
		Gutsevich (1960)	Russia
	<i>Dasyhelea</i>	Edwards (1926)	Britain
		Goetghebuer (1920)	Belgium
		Tokunaga (1940)	Japan
		Zilahi-Sebess	Hungary
Ethiopian	<i>Culicoides</i>	Callot et al. (1967)	Angola
		Carter et al. (1920) <sup>a</sup>	Ghana
		Clastrier (1958, 1959a, 1960)	Congo, Senegal
		Clastrier and Wirth (1961)	Nigeria, Gambia
		De Meillon (1961)	Madagascar
		Fiedler (1951)	S. Africa
		Khamala and Kettle (1971)	East Africa
		Nevill (1969) <sup>a</sup>	S. Africa
	<i>Leptoconops</i>	De Meillon and Hardy (1953)	Entire region
		Laurence and Mathias (1972) <sup>a, b</sup>	
	<i>Dasyhelea</i>	Carter et al. (1920) <sup>a</sup>	Ghana
		Clastrier (1959b)	French West Africa
Oriental	<i>Culicoides</i>	Causey (1938)	Thailand
Micronesian		Delfinado (1961)	Philippines
		Hubert and Wirth (1961)	Okinawa
		McDonald and Lu (1972)	Taiwan
		McDonald et al. (1973)	Okinawa
		Sen and Das Gupta (1959)	India
		Tokunaga (1962a)	New Guinea
		Tokunaga and Murachi (1959)	Micronesia
		Wirth and Hubert (1961)	Taiwan
	<i>Leptoconops</i>	Chanthawanich and Delfinado (1967)	Entire Region
		Laurence and Mathias (1972) <sup>a, b</sup>	

	<i>Dasyhelea</i>	Tokunaga (1940)	Micronesia, Manchuria, N. China, Mongolia
		Tokunaga (1962b)	Ryukyu Islands
Australian	<i>Culicoidea</i>	Tokunaga and Murachi (1959)	Micronesia
		Lee and Reye (1953, 1955, 1962)	Australia
		Wirth and Arnaud (1969)	Polynesia
	<i>Leptoconops</i>	Smee (1966)	Australia
	<i>Dasyhelea</i>	Williams (1944) <sup>a, b</sup>	Hawaii

<sup>a</sup> Immature stages only or some descriptions of immatures included.

<sup>b</sup> Exclusively marine spp.

<sup>c</sup> Contains listed world spp. to date under the most recent classification.

### 13.2.1 Adult

The head is subspherical, somewhat flattened anteriorly in line with the anterior part of the proboscis, which is attached beneath the head. Dorsally, the post-occiput is broad and the vertex undifferentiated with scattered setae. The 2 compound eyes are kidney-shaped and may or may not be contiguous in the mid-dorsal line. There is rarely any interommatidial pubescence. The ocelli are poorly developed. The antennal bases are mounted in the upper region of the fronto-clypeus, while the clypeal region is convexly swollen at the base of the proboscis. The well-developed mouthparts (Jobling, 1928; Gad, 1951) are adapted for ingestion of liquid food and, in the female, are especially designed for piercing and sucking. The female labium is fleshy and unsheaths a strong, distally toothed labrum, a pair of distally toothed mandibles, a pair of maxillae (= laciniae) and the tubular hypopharynx, which also has a distal array of teeth. The maxillary palps are composed of 5 units, the third being swollen to varying degrees and bearing a specialized sense organ (similar to that of *C. hollensis*, Fig. 13.3a) of specific form. The male mouthparts are similar to those of the female but much less strongly developed and without distal teeth.

Each antenna (Fig. 13.1) is divided into 15 units, customarily but incorrectly referred to as segments. The basal unit, or scape, is usually obscured by the globular pedicel, which is especially large in the male and contains the scolo-pophorous sensilla of Johnston's organ. The remaining antennal flagellum consists of 13 flagellomeres of various relative lengths (Wirth, 1952a; Wirth and Blanton, 1959; Atchley, 1970) bearing a variety of sensory hairs and other sensilla (e.g. Fig. 13.3b; Chu et al., 1975). In the male, flagellomeres 1–10 ('segments' 3–12) bear long erectile verticils.

The thorax, which may be adorned with distinctive markings, is covered with small hairs and is convexly arched dorsally to extend slightly over the head (Fig. 13.1). Sublaterally, near the humeral corners on each side, is a small humeral pit of presumed sensory function. The scutellum is transverse and carries a number

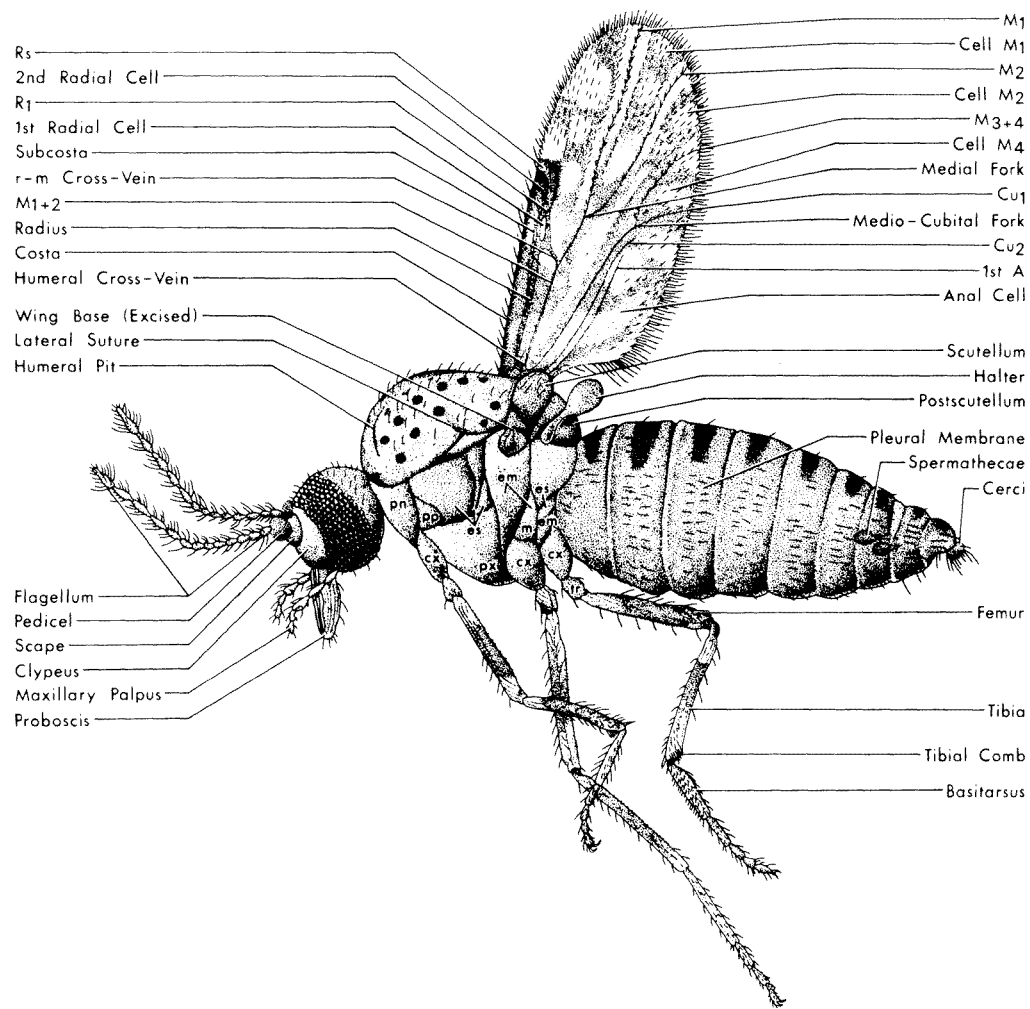

Fig. 13.1. *Culicoides furens*; lateral view of adult female, left wing and right legs removed. cx, coxa; em, epimeron; es, episternum; m, meron; pn, pronotum; pp, propleuron; px, precoxale; tr, trochanter. (Redrawn after T.M. Evans.)

of bristles and hairs. The postscutellum is arched and bare. The pleural regions are bare and are composed of a number of sclerites (Fig. 13.1), among which are found an anterior and posterior spiracle. The legs are slender with the femur sometimes slightly swollen. Grooming organs, consisting of combs of spinose hairs, are found at the inner apices of the fore and hind tibiae (Fig. 13.2a), while the setae on the inner surface of the first hind tarsomere also appear to function as cleaning organs (Linley and Cheng, 1974). The wings are covered with dense microtrichia, among which macrotrichia may be present in variable

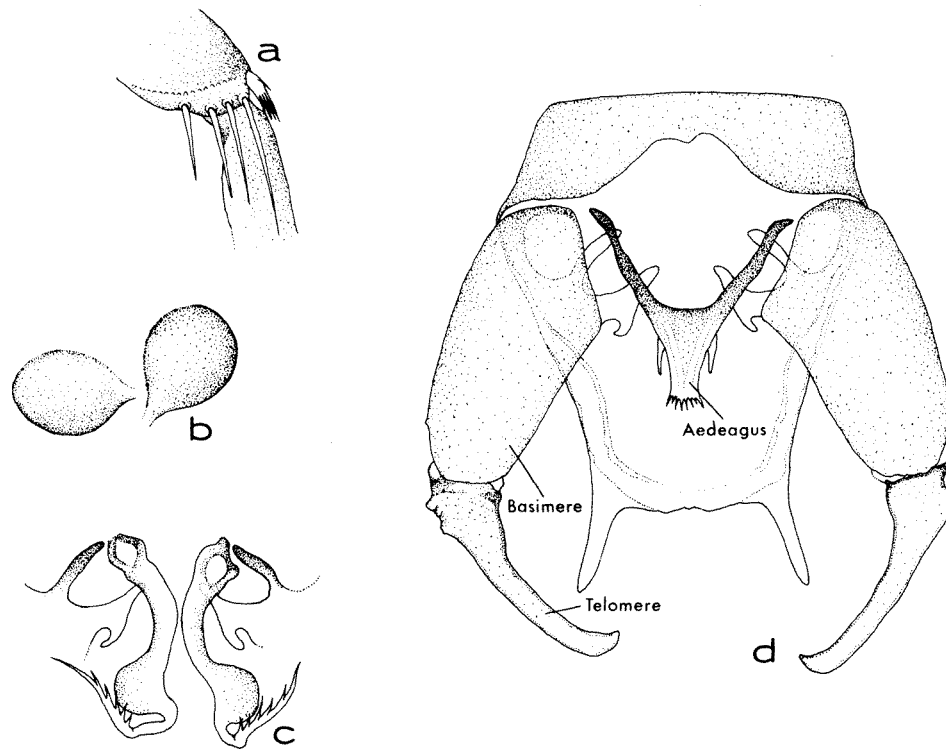

Fig. 13.2. *Culicoides furens*; taxonomically important features in the adult anatomy. (a) hind tibial comb; (b) spermathecae; (c) claspettes; (d) male genitalia (claspettes excised). (Redrawn after Wirth and Blanton, 1959.)

numbers. More or less distinct patterns of light and dark markings, of great taxonomic importance, are often present. The wing venation is usually designated (Fig. 13.1) according to the Tillyard modification of the Comstock–Needham system.

The abdomen of the female is relatively broad and markedly tapered posteriorly (Fig. 13.1). Internally, the usually spherical or pyriform sclerotized spermathecae (Fig. 13.2b) may vary in number. A more complete account of the female abdomen, particularly the terminal portion, is given by Atchley (1970) and Pomerantzev (1932). The male abdomen is narrower than that of the female and tapers posteriorly to the ninth segment, upon which the genitalia, of extreme taxonomic significance, are mounted. The ninth segment, a scleroma consisting of the fused tergum and sternum, may be rotated through as much as  $180^\circ$  by the male prior to copulation. The claspers, or gonopods, are composed of 2 units (Fig. 13.2d). Of these, the basimeres are considerably larger and arise laterally at the base of the tergum; the telomeres are usually slightly swollen basally and are bare or nearly so distally, where they may end in the form of weakly developed hooks.

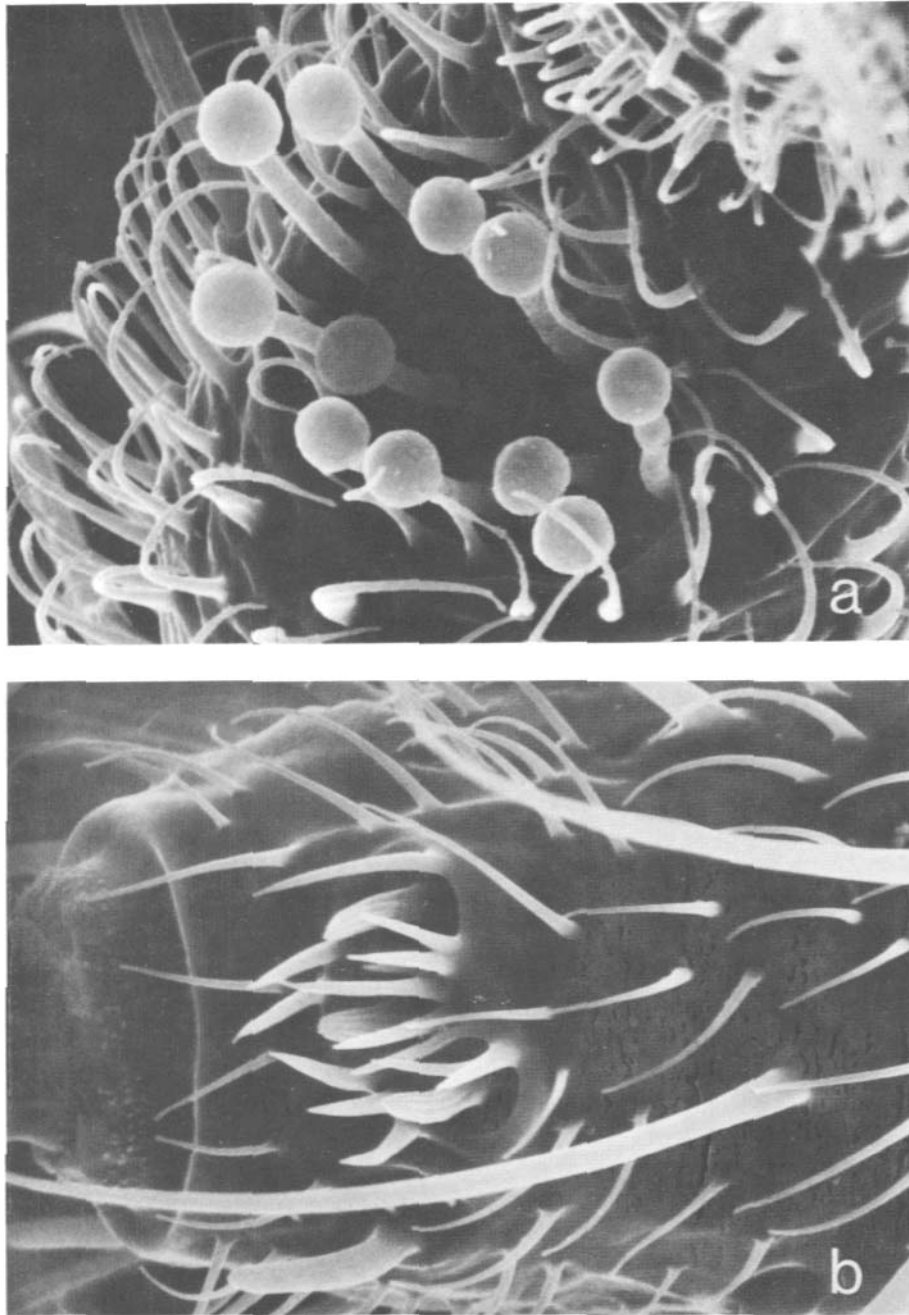

Fig. 13.3 *Culicoides hollensis*, female. (a) Bulb-shaped sensilla in the sensory pit on the third palpal segment.  $\times 6000$ . (b) Antennal sensory pit with three sensory pegs and, just below, a sensillum basiconium.  $\times 4500$ .

The aedeagus is quite variable in form (Atchley, 1970), but is often Y-shaped (Fig. 13.2d). The sclerotized claspettes are highly variable and often complex in shape (Fig. 13.2c). The structure and anatomy of the male genitalia in *C. nubeculosus* (Meigen) are given by Pomerantzev (1932). *Leptoconops* and *Dasyhelea* are similar to *Culicoides*, but considerations of space preclude comparative morphological treatment. The reader is referred to Carter (1921), Smee (1966), and Wirth and Atchley (1973) for detailed diagnostic accounts of *Leptoconops*, and to Carter et al. (1920) and Ratanaworabhan (1969) for *Dasyhelea*.

### 13.2.2 Larva

Larvae of *Culicoides* are elongate and cylindrical (Fig. 13.4a). They are about 1 mm long, transparent when newly hatched and grow through 4 instars to reach a length of 5–7 mm when mature. There are 3 thoracic and 9 abdominal segments, all well defined. More mature larvae are white or cream in colour, with yellow or amber head capsules (Fig. 13.4b). The larvae lack appendages and swim quite well in a characteristic way involving very rapid but shallow lateral flexions of the body. They move freely and easily through particulate matter. *Dasyhelea* larvae are similar, except that the head capsule tends to be larger and darker and the movements take the form of slow bending motions, from side to side. *Leptoconops* larvae are of the same approximate size as in the other 2 genera and, like them, are cylindrical, without appendages and colourless in the first instar (Fig. 13.4d and e). As they grow they assume an opalescent white or distinct pink-orange colour. There are 12 segments, but these are subdivided to produce an appearance of 21–23 segments. Movements consist of slow, writhing flexions of the body, often culminating in characteristic coiling of the body to form a complete circle.

### 13.2.3 Pupa

The pupae of all 3 genera are 2–4 mm long and superficially resemble those of many other Nematocera (Fig. 13.4c and f). The head is small, the thorax rigid and humped in the mesothoracic region, the abdomen elongate and capable of considerable movement. Numerous tubercles with various complements of spines adorn the 3 body regions.

## 13.3 SYSTEMATICS

The order Diptera, in which the Ceratopogonidae constitute but a single family, is one of the largest and most widely distributed orders of Insecta. 'A Catalog of the Diptera of America North of Mexico' (Stone et al., 1965) lists more than

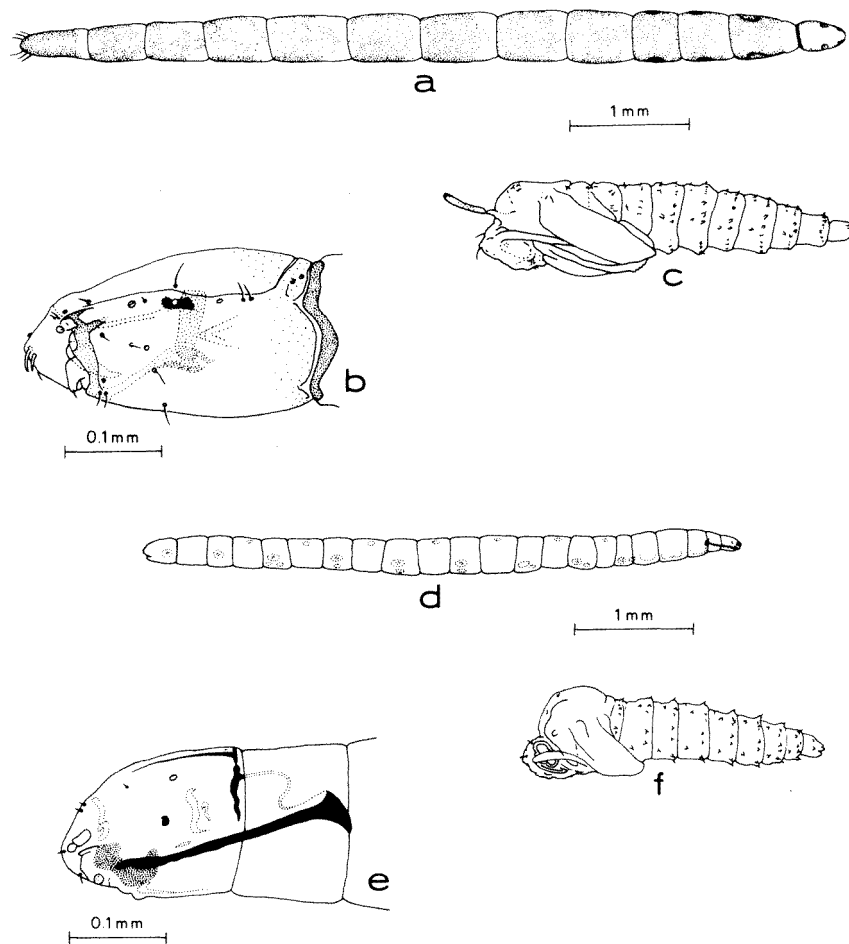

Fig. 13.4. Immature stages of *Culicoides nubeculosus* (a, b, c) and *Leptoconops spinosifrons* (d, e, f). (a, d) Dorsal and lateral views, respectively, of 4th instar larvae; (b, e) enlarged lateral views of larval head capsules; (c, f) lateral views of pupae. (b and c redrawn after Lawson, 1951; d, e and f after Laurence and Mathias, 1972.)

25,000 species in over 100 families, for this region alone. It is my view that information for preliminary diagnosis of a specimen down to family cannot be usefully abstracted from a complete family key. Many such keys are available (e.g., Borror and DeLong (1964) for the United States); the investigator should consult one appropriate to this region of work.

Ceratopogonid taxonomy is a complex subject owing primarily to (i) the intrinsic taxonomic difficulties of the group and, (ii) the assimilation over the last 15 years of many species new to science, with consequent re-evaluation of taxa at several different levels of rank. It is beyond the scope of this article to trace the

taxonomic history of the family as a whole, or with special reference to the marine genera. Those interested in such information will find synopses and important bibliography in Atchley (1967), Battle and Turner (1971) and Ratanaworabhan (1969) for *Culicoides*, in Smee (1966) and Wirth and Atchley (1973) for *Leptoconops*, and in Ratanaworabhan (1969) for *Dasyhelea*.

Below the family level, Ceratopogonidae are divided into 4 subfamilies – Leptoconopinae, Forcipomyiinae, Dasyheleinae and Ceratopogoninae. A key to these is given by Wirth (1962). Within subfamilies, groups of genera are often assembled into tribes, the genera may be reduced further to subgenera, and these again to groups of closely allied species designated by the specific name of the type species (e.g. *furens* group).

There also exists the problem of dealing with the immature stages. Juvenile ceratopogonids are quite likely to be collected in soil or sand samples from coastal habitats. Although scattered descriptions and very few complete treatments of the immatures appear in the literature, the juvenile stages are very poorly known. Further, their taxonomic characters are extremely limited and in some instances usable only after considerable preparative work. Although I have listed major references dealing with the immatures (Table 13.1), for reliable specific identification it is advisable to rear larvae or pupae to the adult stage. Provided the larvae are fairly well grown, rearing is easily done by keeping the insects in a small quantity of the natural substrate.

To afford easy access to important and recent taxonomic literature relating to marine ceratopogonids, I have assembled relevant citations by genus according to zoogeographic region (Table 13.1), indicating also the specific areas covered and which contributions deal with the immature stages.

## 13.4 BIOLOGY

### 13.4.1 Habitats

Along the Atlantic and Gulf coasts of the United States and in the Bahamas, *Culicoides melleus* (Coquillett) larvae are found (Fig. 13.5a) in the intertidal zone on sheltered beaches (Goulding et al., 1953; Jamnback et al., 1958; Jamnback and Wall, 1958; Wall and Doane, 1960; Linley and Adams, 1972a). This habitat may be shared with *Leptoconops (Holoconops) linleyi* (Wirth and Atchley) (personal observations), except that the *Leptoconops* larvae are probably more confined to the area washed by waves at high tide. No species is known to occur where the sand is subject to heavy wave action. In several West Indian territories *C. phlebotomus* (Williston), a large and pestiferous species, breeds most densely in open sandy expanses adjacent to streams or rivers as they traverse beaches to enter the sea (Wirth and Blanton, 1974). Larvae are typically found where high





Fig. 13.5. (a) Larval habitat of *Culicoides melleus*. The larvae are confined to sand in the intertidal zone. (b) Larval habitat of *Culicoides furens* in shaded mud beneath mangrove.

tidal water mingles with freshwater and floods over the sand (Williams, 1964; Davies, 1973). *C. phlebotomus* also breeds in supratidal sand moistened by seepage (Painter, 1926). In Australia sandy, intertidal soils in coastal and estuarine localities are inhabited by *C. subimmaculatus* (Lee and Reye) and *C. molestus* (Skuse) (Reye, 1964). Where clean sand is washed by gentle wave action, larvae of *Leptoconops* (*Styloconops*) *australiensis* (Lee) may be found.

Virtually pure sand, or sandy soils in the supratidal zone and above, are exploited by several marine *Leptoconops*. *L. bequaerti* breeds in damp, sandy depressions, very often behind the storm crest of the beach (Painter, 1926; Davies and Linley, 1965). This species will also invade man-made breeding areas (Linley, 1968a). In territories bordering the Indian Ocean, *L. spinosifrons* occupies the same niche (Laurence, 1966; Duval, 1971; Laurence and Mathias, 1972). The sand is very often bare and open to full sun, although sparse vegetation may be present and shaded sands are also productive. Somewhat similar, but more diverse in its choice of breeding grounds, is the widely distributed species *L. kerteszi* (Wirth and Atchley, 1973). In California, larvae occurred in damp sand just above high tide at the mouths of streams entering the sea (Smith and Lowe, 1948) and in saline sand bordering a creek draining to the inland Salton Sea (Fouk, 1966). Rioux and Descous (1965) found a species they referred to as *kerteszi* in sand bordering a lagoon on the Mediterranean coast of France. However, Clastrier (1973) has recently redescribed *Leptoconops* from this region as 3 new species and the distinctions, if any, between their respective breeding sites are not presently clear. *L. kerteszi* in coastal Grosseto Province, Italy, was found between the sandy shore and inland clay soil (Majori et al., 1970). In sandy soils further from the sea are found *L. irritans* in calcareous, halomorphic soil which cracks poly-gonally on drying (Rioux et al., 1968; Bettini et al., 1969), and *L. (Leptoconops) nipponensis* (Tokunaga) in sandy farm soil near the coast in Japan (Ishigami, 1959).

Wet mud in mangrove swamps, rich in organic water, constitutes a major breeding place for some of the economically most important *Culicoides* (Fig. 13.5b). *C. furens*, found in the mangrove swamps of Nearctic and Neotropical regions, is probably the world's first ranked midge pest. This species ranges along the east coast of the United States, through Central America and the West Indies to northern South America. It has also been reported from Baja California, Mexico (Cheng and Hogue, 1974). Typically, its larval stages are completed in mangrove swamp mud (Myers, 1935; Blanton et al., 1955; Breeland, 1960; Williams, 1962, 1964; Davies, 1967a). However, larvae may also occur in unshaded intertidal mud (Woke, 1954), around banks of saline pools and ditches (Painter, 1926; Bidlingmayer, 1957; Williams, 1962; Linley, 1966a; Linley et al., 1970a) and even (but very rarely) in freshwater situations (Williams, 1964). On the east coast of the United States, *C. furens* is found also in saltmarshes dominated by the sea grass *Spartina alterniflora* (Loisel), a habitat it shares with *C. hollensis* (Melander and Brues), but in the same marshes *C. bermudensis* (Williams) is associated

with another grass *Distichlis spicata* (L.) Greene (Hair et al., 1966; Kline, 1974). *C. barbosai* (Wirth and Blanton) breeds in mangrove swamps (Breeland, 1960; Davies, 1967a). *C. guyanensis* (Floch and Abonnenc) is also found in this habitat (Breeland, 1960; Williams, 1964), but in addition may occur in saline ditches along with *C. maruim* (Lutz) (Forattini et al., 1957) and in spoil used to fill swamps (Altman et al., 1970). *C. bermudensis* occurs around saltwater pools (Jones, 1961) and, together with species of *Dasyhelea*, in mud covered by mangroves (Williams, 1957). Mangrove swamp breeders in other parts of the world include *C. austeni* (Carter, Ingram and Macfie) and *C. obscuripennis* (Clastrier and Wirth) in West Africa (Murphy, 1961; W.W. Wirth, personal communication), *C. peliliouensis* (Tokunaga) which is a major pest in the Palau Islands (Tokunaga and Esaki, 1936; Dorsey, 1947), *C. belkini* (Wirth and Arnaud) in French Polynesia (Wirth and Arnaud, 1969) and *C. furens* and *Dasyhelea* spp. in San José Island, Baja California, Mexico (Cheng and Hogue, 1974; Wirth, 1976).

Saltmarshes and tidal flats provide 2 other major coastal habitats found throughout the world. Some Nearctic inhabitants of such environments have already been mentioned. Another interesting one is *C. tristriatulus* (Hoffman). Larvae of this large, bloodsucking midge were found by Williams (1951a) in vegetated salt flats near Valdez, Alaska, in soil covered by 80–90% of all high tides and inundated by an average of 18 inches (45 cm) of water (maximum 7 ft. or 2.1 m) for 6 or more hours a day. Some breeding occurred also in the tidal overflow zones of snow-fed streams entering the sea. Also found in situations subject to tidal influence are the Palaearctic halophilic species *C. maritimus* (Kieffer) and *C. halophilus* (Kieffer) in vegetated areas of saltmarsh (Kettle and Lawson, 1952; Kettle, 1962; Skierska, 1973), and *C. salinarius* (Kieffer) and *C. circumscriptus* (Kieffer) from bare intertidal mud (Kettle, 1962). The last two have also been taken as immatures from coastal rock pools in Russia (Ivanov and Glukhova, 1967). In Poland, Skierska (1973) has recorded *C. picturatus* (Kremer and Dedit), *C. machardy* (Campbell and Pelham-Clinton) and *C. vistulensis* (Skierska) from coastal salt meadows. *C. miharai* (Kinoshita) inhabits intertidal mud in Korea (Fujito, 1943). One of the very few accounts of a marine *Dasyhelea* is that of Williams (1944), who described the immature stages and biology of *D. calvescens* (Macfie), a breeder in coastal splash pools and saltwater canals in Hawaii.

In contrast to the very extensive coastal habitats, several species of *Culicoides* exploit crabholes. *Culicoides reticulatus* (Lutz) and *C. insignis* Lutz (an occasional crabhole breeder) are recorded from Brazil (Lutz, 1913; Forattini et al., 1958). *C. cancer* (Hogue and Wirth) occurs on the Pacific coast of Costa Rica (Hogue and Wirth, 1968) and *C. arubae* (Fox and Hoffmann) in the Dutch West Indies (Fox, 1942; Fox and Hoffman, 1944). *C. arubae* is also only a facultative crabhole breeder, having been collected in large numbers from saltwater pools protected from tidal action along the Texas Gulf coast (Jones, 1961). Larvae of *C. furens* were found in burrows of the saltmarsh crab *Sesarma sulcatum* (Cheng and Hogue, 1974).

### 13.4.2 Life history

#### Eggs and oviposition

The eggs of *Culicoides* and *Leptoconops* are about 0.25 mm long and banana-shaped, with rounded ends. When newly laid they are white, quickly changing to dark brown on exposure to air. The chorion in *Culicoides* eggs is often covered with poorly to well organized longitudinal rows of sucker or peg-like structures, the ansulae (Hill, 1947; Parker, 1950; Becker, 1961). *Dasyhelea* eggs are similar in shape and color, but are sharply bent in the middle so that the 2 halves are in contact or almost so (Keilin, 1921; Williams, 1944). Each egg is enveloped in a gelatinous material, which, in *D. calvescens*, is fused with that of other eggs to form a small globular mass (Williams, 1944).

Fertilization takes place at oviposition and embryogenesis proceeds immediately. The larval eyespots are easily visible just before hatching. Hatching usually occurs as soon as embryonic development is complete, but diapause of the egg for several months is known in at least 2 non-marine *Culicoides* (Parker, 1950; Jobling, 1953). The duration of the egg stage is, predictably, dependent upon temperature, as indicated for *C. melleus* in Fig. 13.6. Eclosion in this and other species is usually spread over more than 1 day, especially at lower temperatures. At

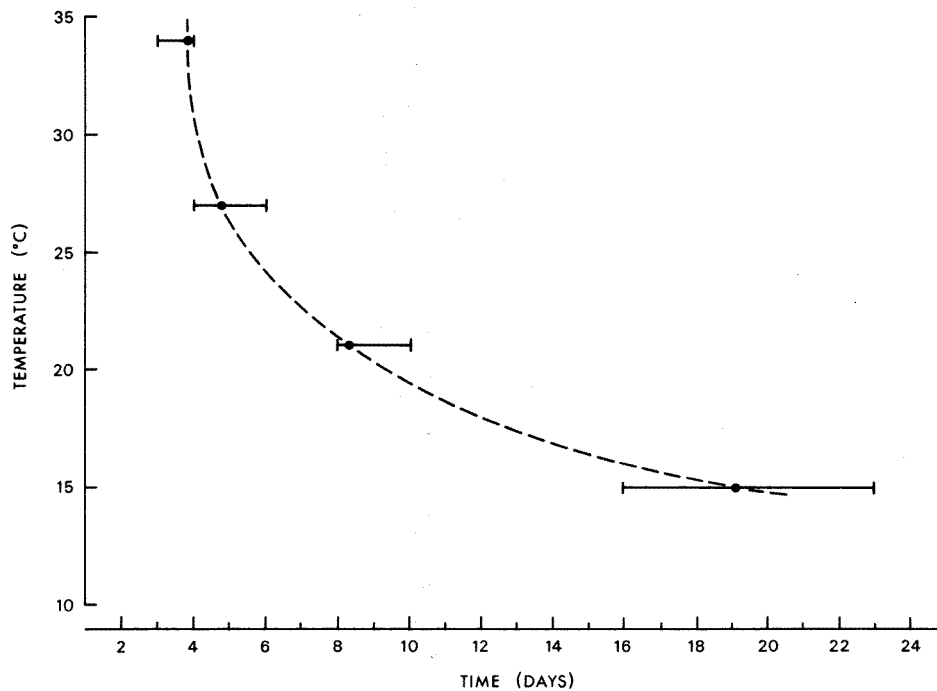

Fig. 13.6. Relationship of temperature to duration of the egg stage in *Culicoides melleus*. Solid circle indicates mean period to hatching; horizontal line indicates range.

29.4°C most *C. furens* eggs hatched on day 3, most *barbosai* eggs on days 5–6 (Linley, 1966b) and most eggs of *L. becquaerti* on day 5 (Linley, 1965b). Eggs of *C. halophilus* hatched (Parker, 1950) after 5 or 6 days at 19.0°C and those of *L. kerteszi* (Rees et al., 1971) in 2.5–4 days at 30.0°C. With the possible exception of species with diapausing eggs, ceratopogonid ova appear to possess little ability to withstand adverse environmental conditions. Exposure to even moderately dry atmospheres (60–80% R.H.) causes ova of *C. furens*, *C. barbosai* and *L. becquaerti* on a dry substrate to collapse before hatching. Similar results are recorded by Parker (1950) for other species, but he also found the diapausing (?) egg of *C. griseus* (Edwards), a non-marine species, resistant to desiccation.

As with other Nematocera, female Ceratopogonidae undoubtedly oviposit at particular periods in the day, probably in response to light stimuli. As yet, however, no experimental studies have been done. Direct observations of the timing of oviposition or the behavior under natural conditions have been impossible. Gravid females of many species have been induced to oviposit in the laboratory by decapitation (Linley, 1965b, 1966b), but the precise physical or chemical factors that naturally release the inhibition controlling egg laying are unknown. Thus, fully gravid females in the laboratory may retain their eggs for many days and lay only reluctantly (Dyce and Murray, 1967). Egg fertility in batches obtained in the laboratory tends to be highly variable; it averaged about 75% in *L. becquaerti* (Linley, 1965b).

When the eggs hatch, they split around a small cap at one end and longitudinally down the egg to a point just short of half its length (photographs in Dyce and Murray, 1967). The characteristic appearance of eclosion so formed is useful for distinguishing eggs that have hatched from dead ones that collapse after splitting along the entire length. Little is known of the conditions required for successful eclosion. Linley (1966b) found that free water around the eggs, but not necessarily covering them, was required for successful hatching of *C. furens*.

With rare exceptions, the most remarkable being *C. denningi* (Foote and Pratt) (Fredeen, 1969), it is probably true that larval ceratopogonids do not undertake extensive movement or migration during the larval stage. The gravid female must therefore oviposit on (or in) or very close to the appropriate substrate. For inter-tidal species, this requirement poses some interesting problems. From the distribution of minute first instar larvae, capable of only very limited movement, Linley and Adams (1972a) inferred that *C. melleus* females oviposit on the upper intertidal portion of the beach (e.g. Fig. 13.5a). These areas are accessible at times dictated by tidal cycles, shifting constantly from day to day. *C. melleus* females and those of other intertidal species, for example *L. australiensis*, *C. subimmaculatus*, *C. ornatus* (Taylor) and *C. peliliouensis* may oviposit in synchrony with tidal rather than diurnal cycles, a situation that would raise questions concerning the mechanisms involved in achieving this synchrony. Even at the point of oviposition, females are selective with respect to physical irregularities of the soil or

sand surface. *C. melleus* females in the laboratory preferred to deposit eggs in small holes, but also laid around surface debris (Linley and Adams, 1972a). *C. furens* similarly favoured depressions in filter paper or wet soil (Linley, 1968b).

At hatching, the larvae possess very limited nutritional reserves and must obtain food almost immediately. Once advanced to later instars, however, both *Culicoides* and *Leptoconops* larvae are able to sustain 2 or 3 weeks of total starvation. Linley (1968a) found that most mortality occurred in the first instar in groups of *L. becquaerti* larvae reared in the field. The exact nature of food contributing to larval nutrition in nature is difficult to determine because food intake in many (but not all) instances appears to be rather indiscriminate. Also, what is ingested may change as the larvae grow, especially if the species is predaceous. Becker (1958a) used an assay based on larval phototactic response to investigate feeding in *C. circumscriptus*. Although the exact nature of the food was not determined, he concluded that the larvae were mainly selective detritus feeders, with requirements for constituents obtained both at and below the natural habitat surface. *C. circumscriptus* larvae were also predatory under certain conditions, but not primarily so. Dead insect flesh was eaten only when other food was not available. In contrast, larval *C. furens* probably rely predominantly on living food. They consume small nematodes and annelids readily in the laboratory (Linley, 1966a) and can be reared to adults on a diet which includes nematodes as the primary constituent (Linley, 1968b, 1969a). Small invertebrates, suitable as prey, are abundant in natural habitats of this species. *C. melleus* is also a predator of protozoa, motile algae and small invertebrates. Its breeding areas in Florida are rich in such organisms (Linley and Adams, 1972a).

While predaceous *Culicoides* larvae presumably seize individual prey organisms, those of *Leptoconops* evidently subsist by browsing on the algal, fungal and bacterial microflora. As they feed, their mandibles alternately sweep food into the mouth. Sandy habitats harbouring *Leptoconops* are often deficient in organic matter (Laurence and Mathias, 1972), but the microflora may be surprisingly rich on close examination. Subsurface algae, visible without microscopic examination, were present in 61 % of the breeding sites supporting *L. becquaerti* larvae in Jamaica (Davies and Linley, 1965). Essentially similar breeding places of *L. spinosifrons* in the Seychelles Islands, assayed by Laurence and Mathias (1972), yielded 310,000–5560,000 bacteria, 6000–580,000 actinomycete spores and 10–8000 mold spores per gram of wet sand. Larval guts contained recognizable fungal mycelium, bacteria, and occasional diatoms. Rees et al. (1971) reared a laboratory colony of *L. kerteszi* larvae in a medium of oolitic sand, alfalfa meal and ground dog biscuits, but it is not known whether the *Leptoconops* obtained nourishment directly from the organic constituents, or both from these and indirectly from bacterial growth. As far as is known, *Dasyhelea* larvae are also

of a browsing habit. Their sluggish movements, at least, do not seem to adapt them for a predatory way of life. Their food is probably similar to that taken by *Leptoconops*.

The time required for larval development is greatly variable from species to species and depends upon food supply, competition and temperature. Under natural conditions, development may require from 2–3 weeks to many months. The most rapid growth known to me was of *C. melleus*, which reached the pupal stage from hatching in 9 days at 27.0°C. The larvae in this instance were reared in natural sand containing food in the form of enormous numbers of *Euglena* spp. and other minute organisms. At the same temperature under controlled food conditions varying from extreme abundance to scarcity, *C. furens* completed development from egg to adult in periods ranging from 20–34 days (Linley, 1969a), including a pupal stage of 3 days (Davies, 1967b). Emergence was most synchronous on the quantitatively richer diets and males tended to emerge slightly before females, although emergence periods of the two sexes overlapped to a large extent. In the field, complete generations of *C. furens* were sampled in 4–6 weeks during the Florida summer (Linley et al., 1970a), so that the larval stage alone probably occupied 3–5 weeks. During the cooler months, larval development was retarded beyond the simple effect of lowered temperature because the individuals grew to larger size and stored reserves necessary to yield adults capable of producing greater numbers of eggs autogenously (see below; Linley et al., 1970b). A similar cycle of events occurs in *C. melleus* (Linley and Hinds, 1976).

At higher latitudes, the larvae may grow over periods of many weeks, or the population may overwinter in a larval stage of many months duration. In Alaska, for example, *C. tristriatulus* females oviposit in late July and August and the larvae hatching about 2 weeks later do not appear as adults until the following June (Williams, 1951a). Rees et al. (1971) recorded a larval stage of 21–23 days for *Leptoconops kerteszi* maintained on an artificial medium at the rather high temperature of 30.0°C. In general, however, the development of *Leptoconops* larvae in nature is rather slow, taking at least several weeks and often many months. In the warm climate of Jamaica, Linley (1968a) reared different numbers of *L. becquaerti* larvae in equal quantities of sand under natural conditions. The larval stage ranged most frequently from 4–8 weeks in duration, but lasted as long as 10–15 weeks under the least favorable conditions. *L. kerteszi* larvae required 8–10 months to complete growth in California (Smith and Lowe, 1948) and probably about the same period in Italy (Majori et al., 1970), as did *L. irritans* in Italy and France (Rioux et al., 1968; Bettini et al., 1969).

Development through the immature stages is probably continuous in many Ceratopogonidae, but there are exceptions about which little is known in detail. Williams (1969) discovered what he interpreted as a possible larval and/or pupal diapause in *C. phlebotomus* from Trinidad. From a single collection of sand drained to dampness and separated into 2 dishes, he obtained adults (within

12 hours) only when the sand was again flooded. Since the floodings were done on the eleventh and twentieth days after collection, and adults appeared so quickly in each case, this result could not have been due to coincidence between floodings and completion of development in 2 cohorts of pupae. It is reasonable to infer that a pupal diapause may exist in this species, controlled by response to sand moisture content or some related factor. Williams (1969) considered that extreme wetness of the sand was necessary to allow pupae to move to the surface before adult emergence. A possibly similar phenomenon, but involving the larvae, was observed in *L. becquaerti* in Jamaica. Davies (1966) obtained a clear association between adult emergence and rainfall 2 weeks previously. Moreover, the number of adults emerging was greater the longer the dry period preceding rain. Since the interval between rain and emergence was too brief for complete larval development from the egg, Linley (1969b) suggested that development was arrested in the third instar under dry conditions and only continued to completion following response to some factor influenced by heavy rain. This interpretation also accommodated the fact that third instar individuals were numerically dominant in the larval populations (Linley, 1969b).

As the larvae approach pupation, the anterior 3 thoracic segments become enlarged and movement is reduced. It is not known whether pupation can be deferred if conditions are unfavorable, although the work of Bidlingmayer (1957) suggests that larval *C. furens* may possess this adaptation. The behavior and requirements of mature larvae at pupation and the behavior of pupae will be discussed later under special ecological adaptations. The pupal stage is usually of a few to several days duration, depending upon temperature (Williams, 1951a; Davies, 1967b; Rees et al., 1971). Emergence of the adult is rapid, taking less than 2 minutes in *C. melleus* (personal observations). Under natural conditions, there is a daily rhythm of emergence. Most *C. furens* adults appeared from 0700–1100 h (Linley, 1966a) or 0800–1200 h (Cheng and Hogue, 1974), and most *L. becquaerti* from 0300–0700 h (Linley, 1968a).

A number of attempts have been made to discover where the adult flies rest and at what heights. Bidlingmayer (1961), using a non-attractive (power aspirator) method of sampling, obtained reliable data for *C. furens*. Females were about equally distributed between ground and arboreal sites up to 4.3 m above the ground, while males in the same habitat were twice as numerous in the trees. Essentially the same results were obtained concurrently with sticky panels, suggesting that these probably are a reliable tool for studying resting sites. Castle (1965) used sticky panels to examine vertical distribution of *C. barbosai* in a Jamaican mangrove swamp. He collected about 75 % of both sexes from 0.3–1.5 m elevations and detected a slight preference for the 0.6 m elevation. Unlike *C. furens*, a slightly larger proportion of *C. barbosai* females was found at the 4.3 m level as



compared to males. Breeland and Smith (1962) and Henry and Adkins (1975) used light traps to study the vertical distribution of *Culicoides*. However, since their traps collected only in the dark, the distributions obtained probably bear little relationship to resting behavior and may instead reflect the heights at which the insects were flying. Even this interpretation must be viewed cautiously because the attraction of traps at different levels would not be equal, but would depend on surrounding vegetation. In a South Carolina saltmarsh, with scattered trees up to 8 m, *C. melleus* and *C. furens* of both sexes were far more abundant (Henry and Adkins, 1975) in traps at 8 and 14 m than at 1.5 and 18 m. *C. furens* adults in Panama were similarly stratified (Breeland and Smith, 1962).

The resting behavior of *Leptoconops* adults is quite different. They apparently place themselves on or just beneath the surface of sand or sandy soil actually on the breeding sites or adjacent to them. *L. spinosifrons* rests on the sand in the area where breeding occurs (Duval, 1971). Linley (1965b) observed gravid *L. becquaerti* females burrowing in sand in the laboratory and later (1968c) collected both males and females from damp to quite wet sand on the breeding sites. Foulk (1968a) studied similar behavior in *L. kerteszi*. He found adults on the surface of dry, shaded sand during the day, then observed them burrowing up to 4 mm below the surface at night. Morning emergence took place when sand temperatures reached about 18°C. The burrowing habit is known in only 2 species, but is probably common within the genus. Most species of *Leptoconops* breed in relatively pure sand or sandy soil. Moreover, in many of them (including *L. kerteszi*), the hind tibiae are armed with several long and exceedingly stout spines (e.g. Chanthawanich and Delfinado, 1967; Wirth and Atchley, 1973). These would seem well adapted for assisting the insects to push their way into sand, and for grooming off adherent sand grains occasionally seen on the body (Linley, 1965b).

As a matter of some importance to control, dispersal of adult midges from the breeding grounds has been of considerable interest. *Culicoides* are weak flyers. If they achieve considerable dispersal it is usually attributed to the effect of wind. In Florida, Bidlingmayer (1961) found female *C. furens* at a maximum of only 1.2 km away from the parent saltmarsh and males, with 1 exception, no further than 91 m away. Breeland and Smith (1962) in Panama ascribed dispersal of *furens* up to 3.2 km from the source of breeding to the effect of wind, and they also concluded that movement against the prevailing wind occurred up to 2.4 km. Williams (1962) recorded movement of *C. furens* up to 6.4 km in the U.S. Virgin Islands. *Leptoconops* are swifter and stronger flyers than *Culicoides*, but still remain relatively close to the breeding areas. Numbers of *L. becquaerti* males declined by a factor of 0.5 for every 137 m downwind of the place of origin (Davies, 1966), while females were reduced to 0.3 of the source level within 182 m and were infrequently caught beyond 0.8 km.

Biting midges take 2 kinds of food as adults. The first, also the only food taken by males, is sugar. In nature, sugars are probably obtained from plant nectars, which are rich in glucose, fructose and sucrose (Van Handel et al., 1972). Sugars are particularly important to the survival of males. A large proportion of newly emerged *C. barbosai* males survived up to 7 days when supplied with honey and 1 individual lived 12 days. All individuals in a comparable group kept without honey were dead within 3 days (Linley, 1966b). In females, sugar feeding brings on preliminary maturation of the ovaries (Linley, 1966b), but access to honey during egg development did not increase the fecundity of *L. bequaerti* females (Linley, 1966c).

In addition to sugar, females require a source of protein in order to mature eggs. Females of some species emerge from the pupa with sufficient protein reserves carried over from the larval stage. They mature the first batch of eggs without additional nourishment and are said to be autogenous. Autogeny is encountered in several marine *Culicoides* and *Leptoconops* (see below) and may be extremely widespread or universal in *Dasyhelea*, in which the piercing mouthparts are reduced. With rare exceptions, female *Culicoides* and *Leptoconops* obtain protein from the blood-meal. Even in autogenous species, the females will usually seek blood once the first oviposition is completed.

With respect to biting behavior, marine species of both *Culicoides* and *Leptoconops* are the most thoroughly investigated. *C. barbosai*, *C. furens* and *L. bequaerti* were studied in Jamaica by determining the landing rate on human bait (Kettle and Linley, 1967a, 1969a). *C. barbosai* preferred the arm to the leg during the day (collectors seated) by a factor of  $\times 1.44$ , while in the same experiments, *C. furens* favored the leg ( $\times 1.55$ ) and so did *L. bequaerti* ( $\times 4.29$ ). The tendency of *C. furens* to select the leg increased significantly (to  $\times 3.68$ ) at night (Kettle and Linley, 1969b) and a similar though less pronounced change occurred in the behavior of *C. barbosai*. These changes were interpreted as being due to the females flying at lower elevations at night. In addition to limb preferences, substantial differences were found between catches from different spatial positions on the study sites, and between individual collectors. Collectors probably smell differently and differ in skin color. It is generally true that flight of adult ceratopogonids is quickly inhibited by wind. *C. barbosai* and *C. furens* are little affected by wind speeds below 3.2 km per hour and *C. barbosai* less so than *C. furens* (Kettle, 1969a). Activity of both species declines rapidly as wind speed increases. The biting rate of *C. barbosai* is reduced by 90 % for an increase in wind speed of 9.6–12.8 km per hour and *C. furens* by the same proportion for an increase of 7.8 km per hour from a windless condition. *Leptoconops bequaerti* is remarkable in that it sustains activity in wind speeds up to 16–24 km per hour. Wind velocity must increase by 14.4 km per hour to reduce numbers of biting *L. bequaerti* by 90% (Kettle, 1969a). Temperature below 21.1°C was positively correlated with activity of

*C. barbosai* and *C. furens*; it had no effect from 21.1–23.9°C; and was negatively correlated above 23.9°C. The biting rate of *L. becquaerti* was doubled (Kettle and Linley, 1967b) for an increase of 3.2°C throughout the normal range in which the insect is active. Light intensity showed little correlation with the activity of any of the 3 species, but was considered very important as a probable phase-setting factor governing onset and termination of activity periods. Humidity was not found to affect biting rate.

The daily cycle of activity in most *Culicoides* follows a crepuscular pattern, with peaks of activity at dawn and dusk and continuing, in some instances, at reduced levels throughout the night. *C. barbosai* and *C. furens* are typical in this respect (Kettle, 1969b). In both species the peak at sunrise was greater than at sunset, possibly because less favorable meteorological conditions prevail at the end of the day. Female *C. barbosai* continued to attack at a low, steady level throughout the night, but *C. furens* showed 2 nocturnal peaks, one in the early evening and another after midnight. *Culicoides hollensis*, an economically important marine species along the east coast of the United States, is unusual in that its activity occurs during the day, with maxima 3–4 h after sunrise and 2–3 h before sunset (Kline, 1974). Unlike *Culicoides*, *Leptoconops* are diurnal in habit, withoutbursts of activity usually occurring early or late in the day, or both. *L. becquaerti* bites in the greatest numbers from 0800–0900 h in the morning, then diminishes quickly to a low level that is sustained before it gradually builds to an afternoon peak from about 1530–1730 h (Kettle and Linley, 1967b). *L. kerteszi* behaves very similarly (Foulk, 1969), but *L. spinosifrons* may show a bimodal curve of activity (Duval, 1971) or a pronounced outburst only in the afternoon (Laurence and Mathias, 1972).

Before females may deposit viable eggs, mating must occur. Reproduction without involvement of the male is rare in Ceratopogonidae. Parthenogenesis is known in only 2 species (both *Culicoides*) and one of them, *C. bermudensis*, is marine (Williams, 1961). Males of *bermudensis* were, in fact, not found in Bermuda (Williams, 1956), but were described from Florida (Beck, 1956). Another possible but not proven instance of parthenogenesis was reported by Becker (1961) in *C. circumscriptus*.

It is the usual pattern in Ceratopogonidae for mating to occur as females approach male swarms. Swarms may consist of a few to many thousands of insects individually maintaining position at a particular place by visual orientation to a specific marker (Downes, 1955). Females possibly respond to the same markers and as they approach the swarms are perceived auditorily by the males, whose antennae function as directional hearing organs. The males grapple with the females in flight and achieve genital union. Copulation may last only a few seconds or united pairs may seek a resting place almost immediately and remain together

for many minutes. Behavioral and physiological details in this form of sexual activity are, unfortunately, poorly known owing to observational and experimental difficulties. Existing knowledge of sexual behavior in its various forms in the different ceratopogonid genera has been discussed by Downes (1958a,b, 1960, 1968). In addition to behavior involving swarms, some species mate without flight, displaying so-called 'truncated' behavioral patterns (Downes, 1969). *C. melleus* behaves in this way and, as a result of recent work, its sexual behavior and physiology are known in considerable detail. Various aspects of this work have included a general study of the behavior (Linley and Adams, 1972b), the mechanism of sperm transfer (Linley and Adams, 1971) and the amounts of sperm transferred (Hinds and Linley, 1974; Linley and Hinds, 1974, 1975a), sperm utilization (Linley, 1975b) and sperm loss (Linley and Hinds, 1975b), female receptivity (Linley and Adams, 1974), behavioral interaction between sexually experienced males and females (Linley and Mook, 1975), behavior after copulation (Linley, 1975a) and seasonal change in male and female reproductive potential (Linley and Hinds, 1976).

The ability of the female to produce an initial batch of eggs autogenously, that is, without taking a blood-meal or its analogue, occurs in many marine species. *Dasyhelea* are suspected of being universally autogenous. *C. bermudensis*, already mentioned as parthenogenetic, produces its eggs autogenously (Williams, 1961). Newly emerged *C. barbosai* from 2 breeding areas were found to be autogenous while proportions of autogenous *C. furens* females were found to vary substantially between different breeding sites (Linley, 1965c). At Vero Beach, Florida, emerging *C. furens* were collected continuously for over a year and all were autogenous. The fecundity of these females fluctuated considerably with temperature-related seasonal changes in size, such that larger females emerging in the cool months matured many more eggs (Linley et al., 1970b). Similar events occur in a *C. melleus* population from a breeding area only a few miles away (Linley and Hinds, 1976). Apart from these more closely studied cases, a number of other marine *Culicoides* are also reported to be autogenous - *C. circumscriptus* (Glukhova, 1958), *C. austeni* (Murphy, 1961), *C. waringi* Lee and Reye (Dyce and Murray, 1967) and *C. marmoratus* Skuse (Kay, 1973).

In the genus *Leptoconops*, *L. kerteszi* is autogenous (Majori et al., 1970; Rees et al., 1971) and *L. irritans* is thought to be (Bettini et al., 1969). Populations of *L. becquaerti* in Jamaica were found to be autogenous, but on close examination (Linley, 1968c), males and females emerging from any one site were found to fall into 2 size groups, with only the small females autogenous. Eggs from autogenous females gave rise to female progeny only of the same type. Although this might suggest the existence of 2 species, isolated perhaps by their respective mating habits (Linley, 1968c), morphological difference between the 2 forms, other than size, was limited to the number of mandibular teeth (Wirth and Atchley, 1973). Autogenous *L. becquaerti* are interesting also in that the ovaries are well advanced

in development at the time of emergence (Linley, 1968c), more so than in *Culicoides* (Linley, 1965c; Dyce and Murray, 1967). Some of the reproductive adaptations of Ceratopogonidae show close parallels with certain arctic Diptera (Linley, 1969a).

While maturing eggs autogenously or after a blood-meal, females are presumed to remain in protected resting places probably very close to the breeding sites (Castle, 1965). As blood is digested, a large number of oocytes develop concurrently (Linley, 1965b, 1966b), reaching maturity in about 48 h at 27.0°C. The total number of eggs produced depends upon temperature and varies considerably with species. At 25.0°C, *C. furens* females matured 99 eggs (range 21–112) and *L. bequaerti* 85, but *C. barbosai*, apparently because of limited blood intake, produced only 13 (range 6–26). *C. circumscriptus* females (Becker, 1961) matured a large average number of 252 eggs (range 45–401).

For a number of species found in intertidal habitats, correlations between tidal water levels and adult midge density have been demonstrated. In the Western Caroline Islands, maximum numbers of *C. peliliouensis* appeared a few days after each neap tide (Dorsey, 1947), when it was presumed that with lower tidal amplitudes, pupation occurred as large areas of swamp remained relatively dry. During spring tide periods, adult *peliliouensis* almost disappeared. Similar patterns associated with tidal cycles have been recorded in several other species, for example *C. austeni* (Murphy, 1961), *C. ornatus* and *C. subimmaculatus* (Reye and Lee, 1962) and *C. furens* (Davies, 1967a). In interpreting seasonal abundance of *C. furens* based on biting rate determinations in Jamaica, Kettle (1972) was unable to reconcile his observations with those of Davies (1967a). Kettle found *C. furens* most abundant at new moon (i.e. spring tide) and least abundant at full moon. In other words, biting *C. furens* were apparently most numerous at every alternate spring tide (new moon), while most *C. furens* were emerging (Davies, 1967a) at every neap tide, during the first and last lunar quarters. (Moonlight itself could not have affected the biting rate data since the experiments were done in the early morning.) This inconsistency could be partly explained if females of the population studied by Kettle were actually autogenous and did not, as he assumed, come to bite very soon after emergence. The time required for egg maturation and oviposition in autogenous females would just about bring Davies' peaks (autogenous (?) females emerging) into phase with Kettle's (now parous females biting?). However, even if this were the correct explanation, the low biting rate at full moon remains an anomaly. In the same swamps, but confined to the seaward portions more affected by tides, emergence of another species, *C. barbosai*, showed an inverse correlation with tidal water level, but over much longer periods than the lunar cycle (Davies, 1967a). The implied response of this species to long-term changes in the mean sea level was borne out by biting rate studies (Kettle, 1972).

Among *Leptoconops*, emergence of *L. spinosifrons* occurs 10–12 days after the breeding zone in the upper part of the beach has been inundated by the highest tides (Duval, 1971).

Patterns of seasonal emergence are largely governed by temperature (hence climate) and its influence on growth of the immature stages. In tropical regions, emergence tends to be more or less continuous even if its magnitude varies because of environmental effects. The generations in such populations presumably overlap, as for example in *C. furens* and *C. barbosai* (Kettle, 1972) and *L. becquaerti* (Kettle and Linley, 1967b; Linley, 1969b) in Jamaica, *C. furens* in Trinidad (Tikasingsh, 1972) and *C. peliliouensis* in the Palau Islands (Dorsey, 1947). The progressive change in phenology with passage from warm to colder climates is well illustrated by *C. furens* in the United States. In Florida where there is a defined cool but not severely cold period, emergence is greatly suppressed in the cool months and distinct generations, probably 6, occur in the year (Linley et al., 1970a). In Louisiana, adults are not found in winter and perhaps 5 generations make up the April–November summer population (Khalaf, 1967, 1969). A more limited season, from May to September, is evident in North Carolina (Kline, 1974) and further north, in Connecticut, adults are present only from mid-June to mid-September, sufficient time for perhaps 3 generations (Lewis, 1959). While some temperate species may be multivoltine, others, such as *C. circumscriptus* complete 2 generations per year (Becker, 1961; and possibly Dzhafarov, 1962b) and higher latitude species, such as *C. tristriatulus*, has only 1 generation (Williams, 1951a). *C. hollensis* is bivoltine but is rather unusual in that it passes through only one distinct generation in the relatively long summer period that prevails through most of its range (Khalaf, 1966, 1969; Kline, 1974). In North Carolina, *C. melleus* appears throughout the summer in barely distinguishable generations, but there is a general decline in the adult population as the season progresses (Kline and Axtell, 1975). Although some *Leptoconops* species may complete several generations a year (e.g. Kettle and Linley, 1967b; Duval, 1971), the relatively long period of larval growth usually allows only 1 generation. This is so in *L. kerteszi* (Smith and Lowe, 1948) and *L. irritans* (Rioux et al., 1968; Bettini et al., 1969). There are no data on seasonal cycles in marine *Dasyhelea*.

#### 13.4.3 Predators and parasites

The upsurge of effort in recent years to detect biological control agents for use against insects led Bacon (1970) to review known parasites and predators of the Ceratopogonidae. None of the organisms listed seemed to hold promise for control purposes and more detailed work by Yaseen (1971) in Trinidad also proved discouraging. However, the Trinidad study remains the only one yet done specifically to survey the natural enemies of midges. With regard to marine species, Bacon's review refers to parasitism of larval *C. salinarius* by bacteria

(Becker, 1958b), and of adult *C. phlebotomus* by a fungus (Ciferri, 1929), *C. salinarius* by a protozoan (Becker, 1958b), and *C. circumscriptus* (Glukhova, 1967) and *L. kerteszi* (Whitsel, 1965) by mermithid nematodes. Adult *C. circumscriptus* and *C. maritimus* were also hosts to a mite (Vercammen-Grandjean, 1957; Becker, 1958b). Predators included an annelid, other Diptera (Painter, 1926) and possibly a tiger beetle (Foulk, 1968b). Additional records since Bacon's review include Foulk's (1968a) observations of *L. kerteszi* as potential prey of ant lions and as host of larval *Microtrombidium* mites, and Mirzaeva's (1971) note on larval *C. machardy* parasitized by mermithid nematodes.

## 13.5 ECOLOGY

### 13.5.1 Special adaptations

Among morphological adaptations, the form of the larva is obviously important. Lacking appendages and bearing only the most minute hairs, ceratopogonid larvae are well designed for movement through particulate and relatively abrasive media. Movement of ceratopogonid larvae is normally accomplished by undulatory flexions of the body, but Laurence and Mathias (1972) observed that mandibular movements of *L. spinosifrons* larvae helped propel them through the sand as feeding progressed. Leading in the direction of movement, the sclerotized, streamlined head is suited to its task of pushing through sand or soil. A modification possibly of special significance to life in sand is the presence in *C. melleus* larvae of 3 ventral longitudinal sclerotized bands (Wirth, 1952b). These were thought to be unique to this species but they are also present, together with 2 dorsal bands, in the Australian sand-dwelling species *C. molestus* and *C. sub-immaculatus*. The larval head capsules in all these species are otherwise very lightly sclerotized and may be adapted for temporary deformation as the animals push through mineral particles (D.S. Kettle and M. Elson, personal communication).

A number of behavioral adaptations are important for life in an intertidal habitat. In *C. furens*, the mature larvae cannot pupate under water. They seek and, if necessary, swim to places of support where contact can be maintained with air (Linley, 1966a). The pupae may survive up to 24 h when forced to remain under water, but when flooded they normally free themselves from their burrows and float to the surface. *C. circumscriptus* (Becker, 1961) and *C. tristriatulus* (Williams, 1951a) are similar in this respect and so is the Australian species *C. henryi* (Lee and Reye), a breeder in algal mats in tidal pools (Dyce and Murray, 1967). In other species, such as *C. melleus*, pupation of submerged larvae is possible, the pupae withstand drowning for up to 4 days, and they do not float or attempt to free themselves from the sand on flooding (Linley and Adams, 1972a). In fact, simulated wave action in water covering submerged *C. melleus* pupae causes

them to burrow more deeply. In several of the intertidal species the pupae are remarkably adept at digging vertically through sand (Linley and Adams, 1972a; Dyce and Murray, 1967), an ability of considerable value in the event of burial under wave-pushed sand or perhaps for protection from surface predators. *L. kerteszi* pupae are also capable of digging through sand (Rees et al., 1971).

### 13.5.2 Habitat requirements

Several workers have measured physical, chemical and biological factors in the larval habitat (Davies and Linley, 1965; Rioux and Descous, 1965; Rioux et al., 1968; Majori et al., 1971). Attempts have been made to associate these factors with the presence or absence of larvae in the habitat. While such efforts have yielded useful information on the conditions that exist in a particular habitat, they have produced relatively little evidence of correlation between larval abundance and specific single factors or combinations of them. Majori et al. (1971) performed physical and chemical analyses of soil from habitats of *L. irritans*, *L. (Leptoconops) bezzii* (Noé) and *L. kerteszi*. They characterized soils favored by *L. irritans* and *L. bezzii* as clay-silt, and by *L. kerteszi* as almost pure sand, but no correlations between breeding and chloride content were found.

For marine *Culicoides*, Kline (1974) has recently reported on the distribution of *C. bermudensis*, *C. furens* and *C. hollensis* in a North Carolina saltmarsh. Multiple regression techniques revealed significant relationships between abundance and various physical and chemical factors in the soil. Calcium concentration was significantly related to the distribution of *C. bermudensis*, zinc concentration to numbers of *C. hollensis*, and manganese, magnesium and calcium concentrations and the percentage of time the soil was flooded to numbers of *C. furens*. Areas occupied by different plants in a habitat may be thought of as showing boundaries within which certain physical and chemical conditions are integrated. It was interesting, therefore, to find that the 3 species in Kline's study were closely associated with certain marsh plants. *C. bermudensis* was confined to areas dominated by *Distichlis spicata* and *Juncus roemerianus* (Scheele), *C. hollensis* to areas of tall-form *Spartina alterniflora* and *C. furens* to short-form *Spartina* zones.

## 13.6 SPECIAL CONSIDERATIONS

### 13.6.1 Midges as disease vectors and pests

The most recent review of Ceratopogonidae as vectors of human and animal diseases is that of Kettle (1965). Very limited involvement of marine species was recorded up to that time and little has been added since. *C. austeni*, a marine species, was reported by Kettle from the original sources as a vector of filarial



nematodes. More recent studies (Khamala and Kettle, 1971; W.W. Wirth, personal communication) have concluded, however, that this vector species, a breeder in banana litter, is *C. hortensis* (Khamala and Kettle). A non-pathogenic filarial parasite of man, *Mansonella ozzardi* (Manson), undoubtedly is transmitted by *C. furens* (Buckley, 1933, 1934). Although not directly incriminated, *C. arubae* (particularly) and also *L. kerteszi* are suspected as possible vectors permitting movement of Venezuelan Equine Encephalitis from South and Central America into Texas (Jones et al., 1972). Among economically important animal diseases, the protozoan *Akiba* (= *Leucocytozoon* of authors) *caulleryi* causes a serious disease of poultry in S.E. Asia and Japan. Its principal vector is *C. arakawae* (Arakawa), but Morii and Kitaoka (1968) obtained transmission from a single bite of infected *C. circumscriptus* and warned that this species could be an important vector in areas where the insect is abundant.

As pests of man and animals, particularly in existing or potential coastal resort areas, midges have been and remain the cause of untold economic loss. For many small territories, such as resort islands in the Caribbean, biting midges are not merely a limited nuisance, but a significant factor in the economy. The relationship of midges to tourism in Florida and the Caribbean area has been discussed by Linley and Davies (1971). Similar problems exist in many other parts of the world (e.g. Dorsey, 1947; Reye, 1964; Rioux et al., 1968; Duval, 1971; Laurence and Mathias, 1972).

### 13.6.2 Control

Before the advent of DDT, the first attempts to control *C. furens* by environmental methods were made in Florida. On the apparent initial success of Hull et al. (1939), Hull and Shields (1943) and Platts et al. (1943) surrounded saltmarshes with dikes and pumped the enclosed areas to dryness. They attained some measure of control, as repeated somewhat later in Panama (Blanton et al., 1955), but subsequent experience indicated that control was not so effective during periods of heavy rain (Rogers, 1962). With the appearance of insecticides, early applications of DDT were made to control both adult and larval saltmarsh *Culicoides* (Madden et al., 1946; Dorsey, 1947; Trapido, 1947; Bruce and Blakeslee, 1948) and *Leptoconops kerteszi* (Rees and Smith, 1950, 1952). Subsequently, other compounds were laboratory and field tested (Goulding et al., 1953; Labrecque and Goulding, 1954; Clements and Rogers, 1968; Fox et al., 1968). Some of the more recent programs against *C. melleus* have, in the light of growing concern for the environment, attempted to assess the side effects of larvicidal treatments (Wall and Doane, 1965; Wall and Marganian, 1971). While some of these programs achieved some effect, the threat that resistance would develop in the population always existed (e.g. Smith et al., 1959). Growing environmental objections remain in most cases, and treatment of very large areas such as mangrove swamps is

extremely costly and impractical for other reasons. The effect of tidal flushing, for example, may also quickly render treatment ineffective.

Starting in the early 1950s, large areas of saltmarsh and mangrove swamp in Florida were impounded, that is, surrounded by earth dikes and kept permanently flooded. The technique involved is briefly described by Linley and Davies (1971). Primarily, impounding was done for its dramatic control effect against saltmarsh mosquitoes, but it also reduces *C. furens* breeding about 95% (Rogers, 1962; MacLaren et al., 1967). The application and economics of the method in the control of biting midges are fully discussed by Linley and Davies (1971). Imposing such changes in natural swamp or marsh areas profoundly affects the ecology, but in ways that may be used advantageously (Provost, 1968). Where very large areas must be controlled, this method is preferable to use of pesticides.

For control of *Leptoconops spinosifrons*, Duval (1971) recommended insecticidal treatment coincident with periods during which he deduced that young larvae would be hatching into the sand. For *L. bequaerti*, Linley and Davies (1971) preferred the environmental method of redistributing sand on the breeding site so as to preserve surface dryness, a condition that prevents breeding. Foulk (1966) successfully used drainage to control *L. kerteszi* in California.

Thermal aerosols (fogs) have often been applied against adults. While there presumably is some benefit, its effect may be extremely temporary. Travis (1949) claimed 90% control with DDT, but also observed that reinfestation from untreated areas began as soon as the fog cleared. Protection for 24–48 h was obtained with DDT against *C. furens* (Bruce and Blakeslee, 1948), while Rees (1958) obtained control of *L. kerteszi* for 4 h up to several days depending upon other factors affecting the influx of biting adults. On reviewing these results, and from personal experience, Linley and Davies (1971) concluded that routine fogging probably renders poor control for the cost involved.

At the level of the individual home owner, some protection indoors (midges pass easily through conventional mosquito screens) may be obtained by treating screens with insecticide. Jamnback (1961, 1963) investigated this method and concluded that 6 % malathion or propoxur (Baygon) in ethanol remained potent for about 1 month. Davies (1965) conducted further tests and found that dichlorvos gave better results than malathion, but this result is not consistent with recent findings of R.C. Axtell and J.C. Dukes (personal communication), who affirm the superiority of malathion.

### *13.6.3 Concluding remarks*

The demonstrated importance and potential of biting Ceratopogonidae as vectors of disease has brought these insects to prominence during the past decade. A number of marine species continue to exert a major influence on the economy and quality of life in coastal areas, particularly in tropical and subtropical parts

of the world. The coastal habitats exploited by some of the most important pest species are vast and constitute a valuable natural resource (e.g. Gosselink et al., 1974). This fact notwithstanding, marshes and swamps continue to produce enormous numbers of midges and the realist must accept that the public at large will continue to demand effective control. The best hope of realizing this objective, with responsible regard for environmental quality, is through the manipulation of life processes not yet understood.

### ACKNOWLEDGEMENTS

I am most grateful to Dr. W.W. Wirth of the Systematic Entomology Laboratory (USDA), U.S. National Museum, for sending important references and for comments on taxonomic sections of the text. Photomicrographs appearing in Fig. 13.3 were supplied by courtesy of Dr. R.C. Axtell, Dep. Entomology, North Carolina State University. The illustrations have been most carefully and skillfully rendered by Mr. John Stark, to whom I express my thanks.

### REFERENCES

- Altman, R.M., Keenan, C.M. and Boreham, M.M. (1970) An outbreak of *Culicoides guyanensis* in the Canal Zone. *Mosquito News* 30, 231–235.
- Arnaud, P.H. Jr. (1956) The Heleid genus *Culieoides* in Japan, Korea, and Ryukyu Islands (Insecta: Diptera). *Microentomology* 21, 84–207.
- Arnaud, P.H. and Wirth, W.W. (1964) A name list of world *Culicoides*. 1956–1962. *Proc. Entomol. Soc. Wash.* 66, 19–32.
- Atchley, W.R. (1967) The *Culicoides* of New Mexico (Diptera: Ceratopogonidae). *Kans. Univ. Sci. Bull.* 46, 937–1022.
- Atchley, W.R. (1970) A biosystematic study of the subgenus *Selfia* of *Culicoides* (Diptera: Ceratopogonidae). *Kans. Univ. Sci. Bull.* 49, 181–336.
- Bacon, P.R. (1970) The natural enemies of the Ceratopogonidae - a review. *Tech. Bull. Commonw. Inst. Biol. Control* 13, 71–82.
- Battle, F.V. and Turner, E.C. (1971) A systematic review of the genus *Culicoides* (Diptera: Ceratopogonidae) of Virginia. *Insects of Virginia No. 3, Res. Div. Bull. No. 44*, 1–129.
- Beck, E.C. (1956) A new species of *Culicoides* from Florida with additional distribution data from the genus (Diptera: Heleidae). *Fla Entomol.* 39, 133–138.
- Becker, P. (1958a) The behaviour of larvae of *Culicoides circumscriptus* Kieffer (Dipt., Ceratopogonidae) towards light stimuli as influenced by feeding, with observations on the feeding habits. *Bull. Entomol. Res.* 49, 785–802.
- Becker, P. (1958b) Some parasites and predators of biting midges, *Culicoides* Latreille (Diptera, Ceratopogonidae). *Entomol. Mon. Mag.* 94, 186–189.
- Becker, P. (1961) Observations on the life cycle and immature stages of *Culicoides circumscriptus* Kieffer (Diptera: Ceratopogonidae). *Proc. R. Soc. Edin.* 67, 363–386.
- Bettini, S., Majori, G., Finizio, E. and Pierdominici, G. (1969) *Ricerca sui Ceratopogonidi nel*

- Grossetano: Nota I - Identificazione dei focolai di *Leptoconops irritans* Noé 1907. Riv. Parassitol. 30, 227–238.
- Bidlingmayer, W.L. (1957) Studies on *Culicoides furens* (Poey) at Vero Beach. Mosquito News 17, 292–294.
- Bidlingmayer, W.L. (1961) Field activity studies of adult *Culicoides furens*. Ann. Entomol. Soc. Am. 54 149–156.
- Blanton, F.S., Graham, O.H. and Keenan, C.M. (1955) Notes on *Culicoides furens* (Poey) at Fort Kobbe, Canal Zone. Mosquito News 15, 13–18.
- Boorman, J.P.T. (1974) *Culicoides* (Diptera, Ceratopogonidae) from Cyprus. Cah. O.R.S.T.O.M., Sér. Entomol. Méd. Parasitol. 12, 7–13.
- Borror, D.J. and DeLong, D.M. (1964) An Introduction to the Study of Insects. (revised ed.). ( ), pp. 1–819.
- Breeland, S.G. (1960) Observations on the breeding habitats of some *Culicoides* and other Heleidae in the Panama Canal Zone (Diptera). Mosquito News 20, 161–167.
- Breeland, S.G. and Smith, J.P. (1962) Observations on the importance of flight range in the control of *Culicoides* in the Panama Canal Zone. Mosquito News 22, 147–154.
- Bruce, W.G. and Blakeslee, E.B. (1948) Control of salt marsh sandflies and mosquitoes with DDT insecticides. Mosquitoes News 8, 26–27.
- Buckley, J.J.C. (1933) A note on the development of *Filaria ozzardi* in *Culicoides furens* Poey. J. Helminthol. 11, 257–258.
- Buckley, J.J.C. (1934) On the development in *Culicoides furens* Poey of *Filaria* (Mansonella) *ozzardi* Manson 1897. J. Helminthol. 12, 99–118.
- Callot, J., Kremer, M. and Molet, B. (1967) Ceratopogonides (Dipteres) de la Région Ethiopienne et particulièrement d'Angola. Publ. Cult. Co. Diam. Angola, 37–44.
- Campbell, J.A. and Pelham-Clinton, E.C. (1960) A taxonomic review of the British species of *Culicoides* Latreille (Diptera: Ceratopogonidae). Proc. R. Soc. Edin. 67, 181–302.
- Carter, H.F. (1921) A revision of the genus *Leptoconops*, Skuse. Bull. Entomol. Res. 12, 1–28.
- Carter, H.F., Ingram, A. and Macfie, J.W.S. (1920) Observations on the Ceratopogonine midges of the Gold Coast with descriptions of new species. Ann. Trop. Med. Parasitol. 14, 187–210.
- Castle, T.A. (1965) A study of the resting habits of *Culicoides barbosai* in a selected area of the Bogue Swamp. Rep. Min. Health, Jamaica, Aug. 1965, pp. 1–7.
- Causey, O.R. (1938) *Culicoides* of Siam with descriptions of new species. Am. J. Hyg. 27, 339–416.
- Cavaliere, F. and Chiossone, I.F. (1966) Datos sobre la familia Dipteros hematofagos Leptoconopidae en la Argentina, con la descripción de *Leptoconops* (*Leptoconops*) *casali* sp. n. y la redescrpcion de *L. (L.) petrocchae* Shannon y Del Ponte 1929. Physis, B. Aires 26, 43–57.
- Chanthawanich, N. and Delfinado, M.D. (1967) Some species of *Leptoconops* of the Oriental and Pacific Regions (Diptera: Ceratopogonidae). J. Med. Entomol. 4, 294–303.
- Cheng, L. and Hogue, C.L. (1974) New distribution and habitat records of biting midges and mangrove flies from the coasts of southern Baja California, Mexico (Diptera: Ceratopogonidae, Culicidae, Chironomidae, and Phoridae). Entomol. News 85(7 & 8) 211–218.
- Chu, I.-W., Axtell, R.C. and Kline, D.L. (1975) Antennal and palpal sensilla of the sand fly *Culicoides furens* (Poey) (Diptera: Ceratopogonidae). Int. J. Insect Morphol. Embryol. 4, 131–149.
- Ciferri, R. (1929) Sur un *Grubyella* parasite de Simulides, *Grubyella ochoterrenai* n. sp. Ann. Parasitol. Hum. Comp. 7, 511–523.
- Clastrier, J. (1957) Notes sur les Ceratopogonides. II. Quelques *Culicoides* d'Algérie à ailes tachétees. Arch. Inst. Pasteur Algér. 35, 404–444.
- Clastrier, J. (1958) Notes sur les Ceratopogonides. IV. Ceratopogonides d'Afrique occidentale française. Arch. Inst. Pasteur Algér. 36, 192–258.
- Clastrier, J. (1959a) Notes sur les Ceratopogonides. VI. Ceratopogonides d'Afrique occidentale française. Arch. Inst. Pasteur Algér. 37, 167–197.

- Clastrier, J. (1959b) Notes sur les Ceratopogonides. VII. Ceratopogonides de l'Afrique Occidentale française. Arch. Inst. Pasteur Algér. 37, 340–383.
- Clastrier, J. (1960) Notes sur les Ceratopogonides. IX. Ceratopogonides de la République du Congo. Arch. Inst. Pasteur Algér. 38, 79–105.
- Clastrier, J. (1971) Isolement et description de la larve de *Leptoconops (Leptoconops) irritans* Noé, 1905 (Diptera, Ceratopogonidae). Ann. Parasitol. Hum. Comp. 46, 737–748.
- Clastrier, J. (1972) Description de la larve et de la nymphe de *Leptoconops (Holoconops) Kerteszi* Kieffer, 1908 (Diptera, Ceratopogonidae). Ann. Parasitol. Hum. Comp. 47, 309–324.
- Clastrier, J. (1973) Le genre *Leptoconops*, sous-genre *Holoconops* dans le Midi de La France (Dipt. Ceratopogonidae). Ann. Soc. Entomol. Fr. 9, 895–920.
- Clastrier, J. and Wirth, W.W. (1961) Notes sur les Ceratopogonides. XIV. Ceratopogonides de la Région Ethiopienne. Arch. Inst. Pasteur Algér. 39, 302–337.
- Clements, B.W. and Rogers, A.J. (1968) Tests of larvicides for control of salt-marsh sand flies (*Culicoides*), 1967. Mosquito News 28, 529–534.
- Davies, J.B. (1965) An assessment of the effectiveness of chemically treated screens in reducing the biting of sandflies (*Culicoides* spp. Ceratopogonidae) using carbon dioxide baited sticky traps. Rep. Min. Health, Jamaica, Dec. 1965. pp. 1–6.
- Davies, J.B. (1966) Studies in the flight and dispersal of *Leptoconops bequaerti* Kieffer by means of wind traps. Rep. Min. Health, Jamaica, Feb. 1966. pp. 1–48.
- Davies, J.B. (1967a) The distribution of sandflies (*Culicoides* spp.) breeding in a tidal mangrove swamp in Jamaica and the effect of tides on the emergence of *C. furens* Poey and *C. barbosai* (Wirth and Blanton). W. Indian Med. J. 16, 39–50.
- Davies, J.B. (1967b) A review of research into the biology and control of the biting sandflies of Jamaica, with recommendations for future control measures. Rep. Min. Health, Jamaica, Jan. 1967. pp. 1–47.
- Davies, J.B. (1973) Sandflies breeding near Las Cuevas and Maracas beaches. J. Trin. Fld Nat. Club 1973, 53–67.
- Davies, J.B. and Linley, J.R. (1965) Observations on the breeding sites of the sandfly *Leptoconops bequaerti* in the Montego Bay area of Jamaica, with a note on one breeding site in Honduras. Caribb. J. Sci. 5, 117–128.
- Delfinado, M.D. (1961) The Philippine biting midges of the genus *Culicoides* (Diptera: Ceratopogonidae). Fieldiana, Zool. 33, 629–675.
- De Meillon, B. (1961) The Madagascan Ceratopogonidae. Rev. Entomol. Moçamb. 4, 37–64.
- De Meillon, B. and Hardy, F. (1953) New records and species of biting insects from the Ethiopian Region. IV. J. Entomol. Soc. Sth. Afr. 16, 17–35.
- Dorsey, C.K. (1947) Population and control studies of the Palau gnat on Peleliu, western Caroline Islands. J. Econ. Entomol. 40, 805–814.
- Downes, J.A. (1955) Observations on the swarming flight and mating of *Culicoides* (Diptera: Ceratopogonidae). Trans. R. Entomol. Soc. Lond. 106, 213–236.
- Downes, J.A. (1958a) Assembly and mating in the biting Nematocera. Proc. × Int. Congr. Entomol., Montreal, 1956, 2, 425–434.
- Downes, J.A. (1958b) The genus *Culicoides* (Diptera: Ceratopogonidae) in Canada; an introductory review. Proc. × Int. Congr. Entomol., Montreal, 1956, 3, 801–808.
- Downes, J.A. (1960) Feeding and mating, and their interrelationship in the insectivorous Ceratopogoninae (Diptera). Proc. XI Int. Congr. Entomol., Vienna, 1960, 1, 618.
- Downes, J.A. (1968) Notes on the organs and processes of sperm transfer in the lower Diptera. Can. Entomol. 100, 608–617.
- Downes, J.A. (1969) The swarming and mating flight of Diptera. Annu. Rev. Entomol. 14, 271–298.
- Duval, J. (1971) Étude écologique du Cératopogonide halophile *Styloconops spinosifrons* (Carter, 1921)

- (Diptera) des plages de Nossi-Bé en vue d'une lutte rationnelle au moyen d'insecticide. Cah. O.R.S.T.O.M., Sér. Entomol. Méd. Parasitol. 9, 203–220.
- Dyce, A.L. and Murray, M.D. (1967) Autogeny in *Culicoides waringi* Lee and Reye and *Culicoides mackerrasi* Lee and Reye (Diptera: Ceratopogonidae) from Australia with notes on breeding places and behaviour. J. Aust. Entomol. Soc. 6, 119–126.
- Dzhafarov, S.M. (1961) Contribution to the systematics of blood sucking flies of the genus *Leptoconops* Skuse in Transcaucasia and descriptions of new species. Akad. Nauk. Azerb. SSR, Izv., Ser. Biol. Med. Nauk, 1, 67–76. (In Russian.)
- Dzhafarov, S.M. (1962a) Morphology of preimaginal phases of *Leptoconops bezzii muganicus* Dzhaif. of blood sucking sandflies (Diptera, Heleidae). Zool. Zh. 41, 241–246. (In Russian.)
- Dzhafarov, S.M. (1962b) New species of bloodsucking midges (Diptera, Heleidae) from the valley of the Kura river, Transcaucasia. Entomol. Rev., Wash. 41, 121–131.
- Dzhafarov, S.M. (1964) Blood-sucking midges (Diptera: Heleidae) of Transcaucasia. Akad. Sci. Azerb. SSR, Press Baku. 1–141. (In Russian.)
- Edwards, F.W. (1926) On the British biting midges (Diptera: Ceratopogonidae). Trans. R. Entomol. Soc. Lond. 74, 389–426.
- Fiedler, O.G.H. (1951) The South African biting midges of the genus *Culicoides*. Onderstepoort J. Vet. Res. 25, 3–33.
- Foot, R.H. and Pratt, H.D. (1954) The *Culicoides* of the eastern United States (Diptera: Heleidae). Publ. Hlth Monogr. No. 18. pp. 1–53.
- Forattini, O.P. (1957) *Culicoides* da região neotropical (Diptera: Ceratopogonidae). Arch. Fac. Hig. Saúde Públ. Univ. S. Paulo 2, 161–526.
- Forattini, O.P. and Rabello, E.X. (1956) As formas imaturas de *Culicoides guyanensis* Floch e Abonnenc 1942 et de algumas espécies de *Stilobezzia*. Rev. Bras. Entomol. 6, 43–50.
- Forattini, O.P., Rabello, E.X. and Pattoli, D. (1956) Nota sobre a larva e pupa de *Culicoides in-signis* Lutz, 1913 (Diptera: Ceratopogonidae). Rev. Bras. Entomol. 4, 195–198.
- Forattini, O.P., Rabello, E.X. and Pattoli, D. (1957) A brief note on breeding places of *Culicoides* in São Vicente, Brazil. Mosquito News 17, 312–313.
- Forattini, O.P., Rabello, E.X. and Pattoli, D. (1958) *Culicoides* da região neotropical (Diptera, Ceratopogonidae). II - Observações sobre biologia em condições naturais. Arch. Fac. Hig. Saúde Públ. Univ. S. Paulo 12, 1–52.
- Forattini, O.P., Rabello, E.X. and Pattoli, D. (1960) Sobre as formas imaturas de *Culicoides reticulatus* Lutz e de *Stilobezzia panamensis* Lane e Forattini (Diptera: Ceratopogonidae). Rev. Bras. Entomol. 9, 1–4.
- Fouk, J.D. (1966) Drainage of a desert spring creek for control of *Leptoconops Kerteszi* (Diptera: Ceratopogonidae). Mosquito News 26, 230–235.
- Fouk, J.D. (1968a) The resting behavior of the desert ceratopogonid, *Leptoconops Kerteszi*. J. Med. Entomol. 5, 223–229.
- Fouk, J.D. (1968b) Indirect evidence of ceratopogonid predation by a tiger beetle. J. Med. Entomol. 5, 353–354.
- Fouk, J.D. (1969) Attack activity of two species of gnats in southern California. Ann. Entomol. Soc. Am. 62, 112–116.
- Fox, I. (1942) The respiratory trumpet and anal segment of the pupae of some species of *Culicoides* (Diptera: Ceratopogonidae). Puerto Rico J. Publ. Hlth Trop. Med. 17, 412–425.
- Fox, I. and Hoffman, W.A. (1944) New Neotropical biting sandflies of the genus *Culicoides* (Diptera: Ceratopogonidae). Puerto Rico J. Publ. Hlth Trop. Med. 20, 108–111.
- Fox, I., Rivera, G.A. and Umpierre, C.C. (1968) Toxicity of various insecticides to *Culicoides furens* larvae in Puerto Rico. Mosquito News 28, 68–71.
- Fredeen, F.J.H. (1969) *Culicoides (Selfia) denningi*, a unique riverbreeding species. Can. Entomol. 101, 539–544.

- Fujito, T. (1943) On the ecological study of a sandfly (*Culicoides miharai*, Kinoshita). J. Chosen Med. Assoc. 33, 75–84. (In Japanese, English summary.)
- Gad, A.M. (1951) The head-capsule and mouthparts in the Ceratopogonidae. Bull. Soc. Fouad I. Entomol. 44, 17–75.
- Glukhova, V.M. (1958) On the gonotrophic cycle in midges of the genus *Culicoides* (Diptera: Heleidae) of the Karelian ASSR. Parazitol. Sb. 18, 239–254. (In Russian, English summary.)
- Glukhova, V.M. (1967) On parasitism in blood-sucking midges (Diptera, Ceratopogonidae) by nematodes of the superfamily Merimitoidea. Parazitologiya 1, 519–520. (In Russian, English summary.)
- Glukhova, V.M. (1968) Systematic review of larvae of the genus *Culicoides* (Diptera, Ceratopogonidae). Parazitologiya 2, 559–567. (In Russian, English summary.)
- Goetghebuer, M. (1920) Ceratopogoninae de la Belgique. Mém. Mus. Hist. Nat. Belg. 8, (fasc. 3) 1–116.
- Goetghebuer, M. (1925) Notes biologiques et morphologiques sur *Dasyhelea bilineata* Goetgh. Encycl. Entomol. (B) 1, 121–124.
- Goulding, R.L., Curran, R.F. and Labrecque, G.C. (1953) Insecticides for the control of salt-marsh sandflies in Florida. J. Econ. Entomol. 46, 37–43.
- Gosselink, J.G., Odum, E.P. and Pope, R.M. (1974) The value of the tidal marsh. (, , special bulletin) pp. 1–30.
- Gutsevich, A.V. (1948) Contribution to the anatomy of *Leptoconops borealis* Gutz. (Diptera: Heleidae). Akad. Nauk SSSR Zool. Inst., Otdel Parazitol. 10, 151–164. (In Russian.)
- Gutsevich, A.V. (1960) Bloodsucking sandflies (Diptera: Heleidae) of the fauna of the U.S.S.R. Akad. Nauk SSSR Zool. Inst. Opredeliteli po Faune SSSR 72, pp. 1–130. (In Russian.)
- Hair, J.A., Turner, E.C. and Messersmith, D.L. (1966) Larval habitats of some Virginia *Culicoides* (Diptera: Ceratopogonidae). Mosquito News 26, 195–204.
- Henry, L.G. and Adkins, T.R. (1974) Vertical distribution of biting midges in coastal South Carolina. Ann. Entomol. Soc. Am. 68, 321–324.
- Hill, M.A. (1947) The life-cycle and habits of *Culicoides impunctatus* Goetghebuer and *Culicoides obsoletus* Meigen, together with some observations on the life-cycle of *Culicoides odibilis* Austen, *Culicoides pallidicornis* Kieffer, *Culicoides cubitalis* Edwards and *Culicoides chiopterus* Meigen. Ann. Trop. Med. Parasitol. 41, 55–115.
- Hinds, M.J. and Linley, J.R. (1974) Changes in male potency with age after emergence in the fly, *Culicoides melleus*. J. Insect Physiol. 20, 1037–1040.
- Hogue, C.L. and Wirth, W.W. (1968) A new central American sand fly breeding in crab holes (Diptera, Ceratopogonidae). Contr. Sci. Los Angeles County Mus. No. 152, pp. 1–7.
- Hubert, A.A. and Wirth, W.W. (1961) Key to the *Culicoides* of Okinawa and the description of two new species (Diptera: Ceratopogonidae). Proc. Entomol. Soc. Wash. 63, 235–239.
- Hull, J.B. and Shields, S.E. (1943) Diking as a measure for sand fly control in salt marshes. J. Econ. Entomol. 36, 405–409.
- Hull, J.B., Dove, W.E. and Platts, N.G. (1939) Experimental diking for control of sand fly and mosquito breeding in Florida salt-water marshes. J. Econ. Entomol. 32, 309–312.
- Ingram, A. and Macfie, J.W.S. (1931) Diptera of Patagonia and South Chile based mainly on material in the British Museum (Natural History). Part II. Fasc. 4. Ceratopogonidae. London Br. Mus. (Nat. Hist.), 155–232.
- Ishigami, K. (1959) On the morphology and ecology of the biting black gnat *Leptoconops nipponensis* Tokunaga (Ceratopogonidae). J. Yonago Med. Assoc. 10, 179–203.
- Ivanov, K.S. and Glukhova, V.M. (1967) New data on the bloodsucking midges (Diptera, Ceratopogonidae) of the coastal zone of the Maritime Territory. Entomol. Rev., Wash. 46, 478–481.
- Jamnback, H.A. (1961) The effectiveness of chemically treated screens in killing annoying punkies, *Culicoides obsoletus*. J. Econ. Entomol. 54, 578–580.

- Jamnback, H.A. (1963) Further observations on the effectiveness of chemically treated screens in killing biting midges, *Culicoides sanguisuga* (Diptera: Ceratopogonidae). J. Econ. Entomol. 56, 719–720.
- Jamnback, H.A. (1965) The *Culicoides* of New York State (Diptera: Ceratopogonidae). Bull. N.Y. St. Mus. Sci. Serv. No. 399, pp. 1–154.
- Jamnback, H.A. and Wall, W.J. (1958) A sampling procedure for *Culicoides melleus* (Coq.) (Diptera: Heleidae) with observations on the life histories of two coastal *Culicoides*. osquito News 18, 85–88.
- Jamnback, H.A., Wall, W.J. and Collins, D.L. (1958) Control of *Culicoides melleus* (Coq.) (Diptera: Heleidae) in small plots, with brief descriptions of the larvae and pupae of two coastal *Culicoides*. Mosquito News 18, 64–70.
- Jobling, B. (1928) The structure of the head and mouthparts of *Culicoides pulicaris* L. Bull. Entomol. Res. 18, 211–236.
- Jobling, B. (1953) On the bloodsucking midge *Culicoides vexans* Staeger, including the description of its eggs, and the first-stage larva. Parasitology 43, 148–159.
- Johannsen, O.A. (1943) A generic synopsis of the Ceratopogonidae of the Americas, a bibliography, and a list of the North American species. Ann. Entomol. Soc. Am. 43, 763–791.
- Johannsen, O.A. (1952) A guide to the insects of Connecticut. Part IV. The Diptera or true flies. Fasc. 5: midges and gnats. Family Heleidae (= Ceratopogonidae). Bull. Conn. St. Geol. Nat. Hist. Surv. No. 18, 149–175.
- Jones, R.H. (1961) Observations on the larval habitats of some North American species of *Culicoides* (Diptera: Ceratopogonidae). Ann. Entomol. Soc. Am. 54, 702–710.
- Jones, R.H., Potter, H.W. and Rhodes, H.A. (1972) Ceratopogonidae attacking horses in south Texas during the 1971 VEE epidemic. Mosquito News 32, 507–509.
- Jorgensen, N.M. (1969) The systematics, occurrence, and host preference of *Culicoides* (Diptera: Ceratopogonidae) in southeastern Washington. Melanderia 3, 1–47.
- Kaufmann, T. (1975) Cocoa pollination by males of *Forcipomyia squamipennis* (Diptera: Ceratopogonidae) in Ghana. Trop. Agric., Trin. 52, 71–75.
- Kay, B.H. (1973) Seasonal studies of a population of *Culicoides Marmoratus* (Skuse) (Diptera: Certopogonidae) at Deception Bay, Queensland. J. Aust. Entomol. Soc. 12, 42–58.
- Keilin, D. (1921) On the life-history of *Dasyhelea obscura*, Winnertz (Diptera, Nematocera, Ceratopogonidae), with some remarks on the parasites and hereditary bacterial symbiont of this midge. Ann. Mag. Nat. Hist. 8, 576–592.
- Kettle, D.S. (1962) The bionomics and control of *Culicoides* and *Leptoconops* (Diptera, Ceratopogonidae = Heleidae). Annu. Rev. Entomol. 7, 401–418.
- Kettle, D.S. (1965) Biting ceratopogonids as vectors of human and animal diseases. Acta Trop. 22, 356–362.
- Kettle, D.S. (1969a) The biting habits of *Culicoides furens* (Poey) and *C. barbosai* Wirth and Blanton. II. Effect of meteorological conditions. Bull. Entomol. Res. 59, 241–258.
- Kettle, D.S. (1969b) The biting habits of *Culicoides furens* (Poey) and *C. barbosai* Wirth and Blanton. I. The 24-h cycle, with a note on differences between collectors. Bull. Entomol. Res. 59, 21–31.
- Kettle, D.S. (1972) The biting habits of *Culicoides furens* (Poey) and *C. barbosai* Wirth and Blanton. III. Seasonal cycle, with a note on the relative importance of ten factors that might influence the biting rate. Bull. Entomol. Res. 61, 565–576.
- Kettle, D.S. and Lawson, J.W.H. (1952) The early stages of British biting midges *Culicoides* Latreille (Diptera: Ceratopogonidae) and allied genera. Bull. Entomol. Res. 43, 421–467.
- Kettle, D.S. and Linley, J.R. (1967a) The biting habits of *Leptoconops bequaerti*. I. Methods; standardization of technique; preferences for individuals, limbs and positions. J. Appl. Ecol. 4, 379–395.
- Kettle, D.S. and Linley, J.R. (1967b) The biting habits of *Leptoconops bequaerti*. II. Effect of meteorological



- conditions on biting activity; 24 hour and seasonal cycles. *J. Appl. Ecol.* 4, 397–420.
- Kettle, D.S. and Linley, J.R. (1969a) The biting habits of some Jamaican *Culicoides*. I. *C. barbosai* Wirth and Blanton. *Bull. Entomol. Res.* 58, 729–753.
- Kettle, D.S. and Linley, J.R. (1969b) The biting habits of some Jamaican *Culicoides*. II. *C. furens* (Poey). *Bull. Entomol. Res.* 59, 1–20.
- Khalaf, K.T. (1966) The seasonal incidence of *Culicoides* in Southern Louisiana (Diptera: Ceratopogonidae). *Ann. Entomol. Soc. Am.* 59, 881–883.
- Khalaf, K.T. (1967) Seasonal incidence and population densities of *Culicoides* in the coastal areas of Louisiana (Diptera: Ceratopogonidae). *J. Kans. Entomol. Soc.* 40, 472–477.
- Khalaf, K.T. (1969) Distribution and phenology of *Culicoides* (Diptera: Ceratopogonidae) along the Gulf of Mexico. *Ann. Entomol. Soc. Am.* 62, 1153–1161.
- Khamala, C.P.M. and Kettle, D.S. (1971) The *Culicoides* Latreille (Diptera: Ceratopogonidae) of East Africa. *Trans. R. Entomol. Soc. Lond.* 123, 1–95.
- Kline, D.L. (1974) Coastal *Culicoides* of North Carolina: species composition, seasonal incidence, and distribution within salt marsh habitats. (Ph.D. Thesis, N. Carolina State Univ., 1974), pp. 1–161.
- Kline, D.L. and Axtell, R.C. (1975) *Culicoides melleus* (Coq.) (Diptera: Ceratopogonidae). Seasonal abundance and emergence from sandy intertidal habitats. *Mosquito News.* 35, 328–334.
- Kremer, M. (1965) Contribution a l'étude du genre *Culicoides* Latreille particulièrement en France. (Doctoral thesis, ) pp. 1–299.
- Kremer, M., Vermeil, C. and Callot, J. (1961) Sur quelques nematocères vulnérants des eaux salées continentales de l'est de la France. *Bull. Assoc. Philomath. Als. Lorr.* 11, 1–8.
- Kremer, M., Doby, J.M. and Shierska, B. (1965) Captures de *Culicoides* (Dipteres nematocères Ceratopogonides) dans le nord et l'est de la Pologne. *Acta Parasitol. Pol.* 13, 109–116.
- Labrecque, G.C. and Goulding, R.L. (1954) Tests with granulated BHC and dieldrin for controlling sandfly larvae. *Mosquito News* 14, 20–22.
- Laurence, B.R. (1966) *Leptoconops* biting on the beaches of the Indian Ocean. *Trans. R. Soc. Trop. Med. Hyg.* 60, 21–22.
- Laurence, B.R. and Mathias, P.L. (1972) The biology of *Leptoconops (Styloconops) spinosifrons* (Carter) (Diptera, Ceratopogonidae) in the Seychelles Islands, with descriptions of the immature stages. *J. Med. Entomol.* 9, 51–59.
- Lawson, J.W.H. (1951) The anatomy and morphology of the early stages of *Culicoides nubeculosus* Meigen (Diptera: Ceratopogonidae = Heleidae). *Trans. R. Entomol. Soc. Lond.* 102, 511–570.
- Lee, D.J. and Reye, E.J. (1953) Australasian Ceratopogonidae (Diptera: Nematocera). Part VI. Part VI. Australasian species of *Culicoides*. *Proc. Linn. Soc. N.S.W.* 77, 369–394.
- Lee, D.J. and Reye, E.J. (1955) Australasian Ceratopogonidae (Diptera: Nematocera). Part VII. Notes on the genera *Alluaudomyia*, *Ceratopogon*, *Culicoides* and *Lasiohelea*. *Proc. Linn. Soc. N.S.W.* 79, 233–246.
- Lee, D.J. and Reye, E.J. (1962) Australasian Ceratopogonidae (Diptera: Nematocera). Part X. Additional Australian species of *Culicoides*. *Proc. Linn. Soc. N.S.W.* 87, 352–363.
- Lewis, F.B. (1959) Abundance and seasonal distribution of the common species of Ceratopogonidae (Diptera) occurring in the state of Connecticut. *Can. Entomol.* 91, 15–28.
- Linley, J.R. (1965a) Descriptions of the pupae of *Culicoides barbosai*, *C. insignis*, and *C. borinqueni* (Diptera: Ceratopogonidae). *Ann. Entomol. Soc. Am.* 58, 57–63.
- Linley, J.R. (1965b) The ovarian cycle and egg stage in *Leptoconops bequaerti* (Kieff.) (Diptera: Ceratopogonidae). *Bull. Entomol. Res.* 56, 37–56.
- Linley, J.R. (1965c) Autogeny in Jamaican 'sandflies' (Ceratopogonidae). *Proc. XII Int. Congr. Entomol.*, 1964. 800–801.
- Linley, J.R. (1966a) Field and laboratory observations on the behavior of the immature stages of *Culicoides furens* Poey (Diptera: Ceratopogonidae). *J. Med. Entomol.* 2, 385–391.

- Linley, J.R. (1966b) The ovarian cycle in *Culicoides barbosai* Wirth and Blanton and *C. furens* (Poey) (Diptera: Ceratopogonidae). Bull. Entomol. Res. 57, 1–17.
- Linley, J.R. (1966c) Effects of supplementary carbohydrate feeding on fecundity and life-length in *Leptoconops bequaerti* (Kieff.) Bull. Entomol. Res. 57, 19–22.
- Linley, J.R. (1968a) Studies on the larval biology of *Leptoconops bequaerti* (Kieff.) (Diptera: Ceratopogonidae). Bull. Entomol. Res. 58, 1–24.
- Linley, J.R. (1968b) Colonization of *Culicoides furens*. Ann. Entomol. Soc. Am. 61, 1486–1490.
- Linley, J.R. (1968c) Autogeny and polymorphism for wing length in *Leptoconops bequaerti* (Kieff.) (Diptera: Ceratopogonidae). J. Med. Entomol. 5, 53–66.
- Linley, J.R. (1969a) Studies on larval development in *Culicoides furens* (Poey) (Diptera: Ceratopogonidae). I. Establishment of a standard rearing technique. Ann. Entomol. Soc. Am. 62, 702–711.
- Linley, J.R. (1969b) Seasonal changes in larval populations of *Leptoconops bequaerti* (Kieff.) (Dipt., Ceratopogonidae) in Jamaica, with observations on the ecology. Bull. Entomol. Res. 59, 47–64.
- Linley, J.R. (1975a) Termination of copulation and associated behaviour in *Culicoides melleus* (Dipt., Ceratopogonidae). Bull. Entomol. Res. 65, 143–156.
- Linley, J.R. (1975b) Sperm supply and its utilization in doubly inseminated flies, *Culicoides melleus*. J. Insect Physiol. 21, 1785–1788.
- Linley, J.R. and Adams, G.M. (1971) Form and function of the spermatophore in *Culicoides melleus* (Coq.) (Dipt., Ceratopogonidae). Bull. Entomol. Res. 60, 427–430.
- Linley, J.R. and Adams, G.M. (1972a) Ecology and behaviour of immature *Culicoides melleus* (Coq.) (Dipt., Ceratopogonidae). Bull. Entomol. Res. 62, 113–127.
- Linley, J.R. and Adams, G.M. (1972b) A study of the mating behaviour of *Culicoides melleus* (Coquillett) (Diptera: Ceratopogonidae). Trans. R. Entomol. Soc. Lond. 124, 81–121.
- Linley, J.R. and Adams, G.M. (1974) Sexual receptivity in *Culicoides melleus* (Diptera: Ceratopogonidae). Trans. R. Entomol. Soc. Lond. 126, 279–303.
- Linley, J.R. and Cheng, L. (1974) The grooming organs of *Culicoides* (Diptera: Ceratopogonidae). Mosquito News 34, 204–206.
- Linley, J.R. and Davies, J.B. (1971) Sandflies and tourism in Florida and the Bahamas and Caribbean area. J. Econ. Entomol. 64, 264–278.
- Linley, J.R. and Hinds, M.J. (1974) Male potency in *Culicoides melleus* (Coq.) (Diptera, Ceratopogonidae). Bull. Entomol. Res. 64, 123–128.
- Linley, J.R. and Hinds, M.J. (1975a) Quantity of the male ejaculate influenced by female unreceptivity in the fly, *Culicoides melleus*. J. Insect Physiol. 21, 281–285.
- Linley, J.R. and Hinds, M.J. (1975b) Sperm loss at copulation of *Culicoides melleus* (Diptera: Ceratopogonidae). J. Entomol. (A). 50, 37–41.
- Linley, J.R. and Hinds, M.J. (1976) Seasonal change in size, female fecundity and male potency of *Culicoides melleus* (Diptera: Ceratopogonidae). J. Med. Entomol. (In press).
- Linley, J.R. and Kettle, D.S. (1964) A description of the larvae and pupae of *Culicoides furens* Poey and *Culicoides hoffmani* Fox (Diptera: Ceratopogonidae). Ann. Mag. Nat. Hist. 7, 129–149.
- Linley, J.R. and Mook, M.S. (1976) Behavioural interaction between sexually experienced *Culicoides melleus* (Coquillett) (Diptera: Ceratopogonidae). Behaviour 54, 97–110.
- Linley, J.R., Evans, F.D.S. and Evans, H.T. (1970a) Seasonal emergence of *Culicoides furens* (Diptera: Ceratopogonidae) at Vero Beach, Florida. Ann. Entomol. Soc. Am. 63, 1332–1339.
- Linley, J.R., Evans, H.T. and Evans, F.D.S. (1970b) A quantitative study of autogeny in a naturally occurring population of *Culicoides furens* (Poey) (Diptera: Ceratopogonidae). J. Anim. Ecol. 39, 169–183.
- Lutz, A. (1913) Contribuição para o estudo das ‘Ceratopoginas’ hematofagas do Brasil (parte sistematica). Mems Inst. Oswaldo Cruz 5, 45–73.

- Macfie, J.W.S. (1948) Some species of *Culicoides* (Diptera: Ceratopogonidae) from the state of Chiapas, Mexico. *Ann. Trop. Med. Parasitol.* 42, 67–87.
- MacLaren, J.P., Hawkins, J.L., Murdoch, W.P. and Bush, R.G. (1967) *Culicoides* control in the Canal Zone by water management. *Mosquito News* 27, 513–519.
- Madden, A.H., Lindquist, A.W., Longren, O.M. and Knipling, E.F. (1946) Control of adult sandflies by airplane spraying with DDT. *Fla Entomol.* 29, 5–10.
- Majori, G., Bettini, S., Finizio, E. and Pierdominici, G. (1970) Ricerche sui Ceratopogonidi nel Grossetano: Nota IV - Identificazione dei focolai di *Leptoconops (Holoconops) kerteszi* Kieffer, 1908. *Riv. Parassitol.* 31, 279–284.
- Majori, G., Bernardini, F., Bettini, S., Finizio, E. and Pierdominici, G. (1971) Ricerche sui Ceratopogonidi nel Grossetano: Nota V - Caratteristiche geologiche dei focolai di *Leptoconops* spp. *Riv. Parassitol.* 32, 277–291.
- McDonald, J.L. and Lu, L.C. (1972) Female *Culicoides* of Taiwan with description of new species (Diptera, Ceratopogonidae). *J. Med. Entomol.* 9, 396–417.
- McDonald, J.L., Bolinguit, T. and Lu, L.C. (1973) Female *Culicoides* of Okinawa with descriptions of new species (Diptera: Ceratopogonidae). *J. Med. Entomol.* 10, 633–648.
- Megahed, M.M. (1956) Anatomy and histology of the alimentary tract of the female of the biting midge *Culicoides nubeculosus* Meigen (Diptera: Heleidae = Ceratopogonidae). *Parasitology* 46, 22–47.
- Mirzaeva, A.G. (1971) Parasitism of nematodes of the superfamily Mermitoidea in larvae of midges of the genus *Culicoides*. *Parazitologiya* 5, 455–457. (In Russian.)
- Morii, T. and Kitaoka, S. (1968) Influence of temperature on the sporogony of *Akiba caulleryi* in three *Culicoides* species. *Natl. Inst. Anim. Hlth Q.*, Tokyo 8, 210–216.
- Murphy, D.H. (1961) Biological species confused under the name *Culicoides austeni* (Carter, Ingram and Macfie). *Nature* 192, 186–187.
- Myers, J.G. (1935) The sand fly pest (*Culicoides*). *Trop. Agric., Trin.* 12, 71–73.
- Navai, Sh. (1970) Ceratopogonidae (Diptera) of Iran V. *Culicoides* from Mazandaran. *Mosquito News* 30, 6–8.
- Nevill, E.M. (1969) The morphology of the immature stages of some South African *Culicoides* species (Diptera: Ceratopogonidae). *Onderstepoort J. Vet. Res.* 36, 265–284.
- Ortiz, A. and Leon, L.A. (1955) Los *Culicoides* (Diptera: Ceratopogonidae) de la República del Ecuador. *Boln Infs Cient. Nac.*, Quito No. 67, 564–590.
- Painter, R.H. (1926) The biology, immature stages, and control of the sandflies (biting Ceratopogonidae) at Puerto Castilla, Honduras. *Rep. Un. Fruit Co. Med. Dep. N.Y.*, 1926, 245–262.
- Parker, A.H. (1950) Studies on the eggs of certain biting midges (*Culicoides* Latreille) occurring in Scotland. *Proc. R. Entomol. Soc. Lond. (A)* 25, 43–52.
- Platts, N.G., Shields, S.E. and Hull, J.B. (1943) Diking and pumping for control of sand flies and mosquitoes in Florida salt marshes. *J. Econ. Entomol.* 36, 409–412.
- Pomerantzev, B.I. (1932) Beitrage zur Morphologie und Anatomie der Genitalien von *Culicoides* (Diptera: Nematocera). *Mag. Parasitol.* 3, 183–214. (In Russian, German summary.)
- Posnette, A.F. (1944) Pollination of cacao in Trinidad. *Trop. Agric., Trin.* 21, 115–118.
- Provost, M.W. (1968) Managing impounded salt marsh for mosquito control and estuarine resource conservation. *Louisiana St. Univ. Marsh and Estuary Symp.*, 1967, 163–171.
- Ratanaworabhan, N.C. (1969) An illustrated key for the genera of Ceratopogonidae (Diptera) of the World. (Ph.D. Thesis, Univ. Florida, 1969) pp. 1–261.
- Rees, D.M. (1958) Report on the results of control methods applied to biting gnats in the vicinity of Salt Lake City, Utah (Diptera: Ceratopogonidae). *Proc. × Int. Congr. Entomol.*, Montreal, 1956, 3, 741–744.
- Rees, D.M. and Smith, J.V. (1950) Effective control methods used on biting gnats in Utah during 1949 (Diptera: Ceratopogonidae). *Mosquito News* 10, 9–15.

- Rees, D.M. and Smith, J.V. (1952) Control of biting gnats in north Salt Lake City, Utah (Diptera: Heleidae). *Mosquito News* 12, 49–52.
- Rees, D.M., Lawyer, P.G. and Winget, R.N. (1971) Colonization of *Leptoconops kerteszi* Kieffer by anautogenous and autogenous reproduction (Diptera: Ceratopogonidae). *J. Med. Entomol.* 8, 266–271.
- Remm, H.J. (1956) The biting midge fauna of the genus *Culicoides* Latr. (Diptera, Heleidae) of Estonia. *Entomol. Obozr.* 35, 172–183. (In Russian.)
- Reye, E.J. (1964) The problems of biting midges (Diptera: Ceratopogonidae) in Queensland. *J. Entomol. Soc. Queensl.* 3, 1–16.
- Reye, E.J. and Lee, D.J. (1962) The influence of the tide cycle on certain species of *Culicoides* (Diptera: Ceratopogonidae). *Proc. Linn. Soc. N.S.W.* 87, 377–387.
- Rioux, J.A. and Descous, S. (1965) Détection du biotype larvaire de *Leptoconops (Holoconops) kerteszi* Kieffer, 1908 (Diptera: Ceratopogonidae) dans le 'Midi' Méditerranéen. *Ann. Parasitol. Hum. Comp.* 40, 219–230.
- Rioux, J.A., Descous, S., Corre, J.J., Croset, H. and Tour, S. (1968) Ecologie de *Leptoconops irritans* Noé, 1905 en Moyenne Camargue. Localisation et dynamique des biotypes larvaires. *Terre Vie* 22, 458–469.
- Rogers, A.J. (1962) Effects of impounding and filling on the production of sand flies (*Culicoides*) in Florida salt marshes. *J. Econ. Entomol.* 55, 521–527.
- Rowley, W.A. and Cornford, M. (1972) Scanning electron microscopy of the pit of the maxillary palp of selected species of *Culicoides*. *Can. J. Zool.* 50, 1207–1210.
- Sen, P. and Das Gupta, S.K. (1959) Studies on Indian *Culicoides* (Ceratopogonidae: Diptera). *Ann. Entomol. Soc. Am.* 52, 617–630.
- Skierska, B. (1973) Faunistic-ecological investigations on blood-sucking midges (Diptera: Ceratopogonidae = Heleidae) of the Polish coastal area. *Biol. Inst. Med. Morsk. Gdansk* 24, 113–133.
- Smee, L. (1966) A revision of the subfamily Leptoconopinae Noé (Diptera: Ceratopogonidae) in Australasia. *Aust. J. Zool.* 14, 993–1025.
- Smith, L.M. and Lowe, H. (1948) The black gnats of California. *Hilgardia* 18, 157–183.
- Smith, C.N., Davis, A.N., Weidhaas, D.E. and Seabrook, E.L. (1959) Insecticide resistance in the salt marsh sandfly *Culicoides furens*. *J. Econ. Entomol.* 52, 352–353.
- Stone, A., Sabrosky, C.W., Wirth, W.W., Foote, R.H. and Coulson, J.R. (1965) A catalog of the Diptera of America north of Mexico. *Agric. Handb. Agric. Res. Serv. U.S. No. 276*, 1–1696.
- Thienemann, A. (1926) Dipteren aus den Salzgewässern von Oldesloe. (Mit einer Bestimmungstabelli der Larven und Puppen der Gattung *Dasyhelea*.) *Mitt. Geogr. Ges. Naturh. Mus. Lübeck* (2) 31, 102–126.
- Tikasinh, E.S. (1972) Seasonal and diurnal activities of four species of Trinidadian *Culicoides* (Diptera: Ceratopogonidae). *Mosquito News* 32, 447–452.
- Tokunaga, M. (1940) Biting midges from Japan and neighbouring countries, including Micronesian Islands, Manchuria, North China and Mongolia (Diptera: Ceratopogonidae). *Tenthredo* 3, 58–165.
- Tokunaga, M. (1962a) Biting midges of the genus *Culicoides* from New Guinea (Diptera: Ceratopogonidae). *Pac. Insects* 4, 457–516.
- Tokunaga, M. (1962b) Biting midges of the Ryukyu Islands (Diptera: Ceratopogonidae). *Pac. Insects* 4, 153–217.
- Tokunaga, M. and Esaki, T. (1936) A new biting midge from the Palau Islands, with its biological notes. *Mushi* 9, 55–58.
- Tokunaga, M. and Murachi, E.K. (1959) Diptera: Ceratopogonidae. *Insects Micronesia* 12, 103–434.
- Trapido, H. (1947) DDT residual spray control of sandflies in Panama. *J. Econ. Entomol.* 40, 472–475.

- Travis, B.V. (1949) Studies of mosquito and other biting insect problems in Alaska. *J. Econ. Entomol.* 42, 451–457.
- Van Handel, E., Haeger, J.S. and Hanson, C.W. (1972) The sugars of some Florida nectars. *Am. J. Bot.* 59, 1030–1032.
- Vattier, G. (1965) *Dasyhelea adami* sp. n. (Diptera: Ceratopogonidae). Morphology and biology. *Bull. Soc. Pathol. Exot.* 57, 1159–1171. (In French, English summary.)
- Vercammen-Grandjean, P.H. (1957) Un nouveau Trombiidae larvaire parasite de divers *Culicoides* originaires d'Écosse: *Evansiella culicoides* n.g., n. sp. (Acarina). *Ann. Mag. Nat. Hist.* 12, 283–286.
- Wall, W.J. and Doane, O.W. (1960) A preliminary study of the bloodsucking Diptera on Cape Cod, Massachusetts. *Mosquito News* 20, 39–44.
- Wall, W.J. and Doane, O.W. (1965) Control of *Culicoides melleus* (Coq.) (Diptera: Heleidae) with granular insecticides and the effect on other fauna. *Mosquito News* 25, 191–196.
- Wall, W.J. and Marganian, V.M. (1971) Control of *Culicoides melleus* (Coq.) (Diptera: Ceratopogonidae) with granular organophosphorus pesticides, and the direct effect on other fauna. *Mosquito News* 31, 209–214.
- Warmke, H.E. (1951) Studies on pollination of *Hevea brasiliensis* in Puerto Rico. *Science, N.Y.* 113, 646–648.
- Warmke, H.E. (1952) Studies on natural pollination of *Hevea brasiliensis* in Brazil. *Science, N.Y.* 116, 474–475.
- Whitsel, R.H. (1965) A new distribution record and an incidence of mermithid nematode parasitism for *Leptoconops kerteszi* Kieffer (Diptera: Ceratopogonidae). *Mosquito News* 25, 66.
- Williams, F.X. (1944) Biological studies in Hawaiian water-loving insects. Part III. Diptera or flies. D. Culicidae, Chironomidae and Ceratopogonidae. *Proc. Hawaii. Entomol. Soc.* 12, 149–180.
- Williams, R.W. (1951a) Observations on the bionomics of *Culicoides tristriatulus* Hoffman with notes on *C. alaskensis* Wirth and other species at Valdez, Alaska, summer 1949. *Ann. Entomol. Soc. Am.* 44, 173–183.
- Williams, R.W. (1951b) The immature stages of *Culicoides tristriatulus* Hoffman (Diptera, Heleidae). *Ann. Entomol. Soc. Am.* 44, 430–440.
- Williams, R.W. (1956) The biting midges of the genus *Culicoides* found in the Bermuda Islands (Diptera: Heleidae). I. A description of *C. bermudensis* n. sp. with a key to the local fauna. *J. Parasitol.* 42, 297–300.
- Williams, R.W. (1957) Observations on the breeding habitats of some Heleidae of the Bermuda Islands (Diptera). *Proc. Entomol. Soc. Wash.* 59, 61–66.
- Williams, R.W. (1961) Parthenogenesis and autogeny in *Culicoides bermudensis* Williams. *Mosquito News* 21, 116–117.
- Williams, R.W. (1962) Observations on the bionomics of *Culicoides furens* (Poey) on St. John, U.S. Virgin Islands (Diptera, Ceratopogonidae). *Mosquito News* 22, 155–157.
- Williams, R.W. (1964) Observations on habitats of *Culicoides* larvae in Trinidad, W.I. (Diptera: Ceratopogonidae). *Ann. Entomol. Soc. Am.* 57, 462–466.
- Williams, R.W. (1969) Add water - 'instant' *Culicoides*. *Ann. Entomol. Soc. Am.* 62, 929–930.
- Wirth, W.W. (1951) The genus *Culicoides* in Alaska (Diptera: Heleidae). *Ann. Entomol. Soc. Am.* 44, 75–86.
- Wirth, W.W. (1952a) The Heleidae of California. *Univ. Calif. Publ. Entomol.* 9, 95–211.
- Wirth, W.W. (1952b) The immature stages of two species of Florida salt marsh sandflies (Diptera, Heleidae). *Fla Entomol.* 35, 91–99.
- Wirth, W.W. (1962) A reclassification of the *Palpomyia-Bezzia-Macropeza* groups, and a revision of the North American Sphaeromiini (Diptera: Ceratopogonidae). *Ann. Entomol. Soc. Am.* 55, 272–287.

- Wirth, W.W. (1969) North America *Culicoides* of the *pulicaris* Group (Diptera: Ceratopogonidae). Fla Entomol. 52, 207–243.
- Wirth, W.W. (1971) A review of the 'stick-ticks', Neotropical biting midges of the *Forcipomyia* subgenus *Microhelea* parasitic on walking stick insects (Diptera: Ceratopogonidae). Entomol. News 82, 229–245.
- Wirth, W.W. (1976) New species and records of intertidal biting midges of the genus *Dasyhelea* Kieffer from the Gulf of California (Diptera: Ceratopogonidae). Pac. Insects. (In press.)
- Wirth, W.W. and Arnaud, P.H. (1969) Polynesian biting midges of the genus *Culicoides* (Diptera: Ceratopogonidae). Pac. Insects 11, 507–520.
- Wirth, W.W. and Atchley, W.R. (1973) A review of the North American *Leptoconops* (Diptera: Ceratopogonidae). Grad. Stud. Texas Tech. Univ. No. 5, pp. 1–57.
- Wirth, W.W. and Blanton, F.S. (1959) Biting midges of the genus *Culicoides* from Panama (Diptera: Heleidae). Proc. U.S. Natl. Mus. 109, 237–82.
- Wirth, W.W. and Blanton, F.S. (1973) A review of the Maruins or biting midges of the genus *Culicoides* (Diptera: Ceratopogonidae) in the Amazon Basin. Amazoniana 4, 405–470.
- Wirth, W.W. and Blanton, F.S. (1974) The West Indian sandflies of the genus *Culicoides* (Diptera: Ceratopogonidae). U.S. Dep. Agric. Tech. Bull. No. 1474, pp. 1–98.
- Wirth, W.W. and Hubert, A.A. (1961) New species and records of Taiwan *Culicoides* (Diptera: Ceratopogonidae). Pac. Insects 3, 11–26.
- Wirth, W.W. and Williams, R.W. (1957) The biting midges of the Bermuda Islands, with descriptions of five new species. Proc. Entomol. Soc. Wash. 59, 5–14.
- Wirth, W.W., Ratanaworabhan, N.C. and Blanton, F.S. (1974) Synopsis of the genera of Ceratopogonidae (Diptera). Ann. Parasitol. Hum. Comp. 49, 595–613.
- Woke, P.A. (1954) Observations on Central American biting midges (Diptera, Heleidae). Ann. Entomol. Soc. Am. 47, 61–74.
- Yaseen, M. (1971) Investigations into the possibilities of biological control of sandflies (Diptera: Ceratopogonidae) (Final Report). Rep. Commonw. Inst. Biol. Contr., pp. 1–14.
- Zilahi-Sebess, G. (1940) Heleiden aus Ungarn. Folia Entomol. Hung. 5, 10–133. (In Magyar, German summary.)

## Non-biting midges of marine habitats (Diptera: Chironomidae)

Hiroshi Hashimoto

<b>Contents</b>		
14.1	Introduction	377
14.2	Systematics — Key to genera of marine Chironomids	380
	14.2.1 Subfamily Chironominae	380
	14.2.2 Subfamily Orthoclaadiinae	381
	14.2.3 Subfamily Clunioninae	382
14.3	General morphology	389
14.4	Biology	393
	14.4.1 Life history	393
	14.4.2 Reproduction	397
	14.4.3 Seasonality	400
	14.4.4 Food	402
	14.4.5 Predators	402
14.5	Ecology	405
	14.5.1 Special adaptations	405
	14.5.2 Habitat requirements	409
	14.5.3 Distribution	411
References		412

### 14.1 INTRODUCTION

Chironomidae is a big family consisting of about 120 genera and over 5000 species. The larvae, commonly known as blood worms, are used as aquarium fish food. Some larvae are used as indicators of water pollution. The adults are known as harlequin flies and often hover in swarms over streams and ponds, mostly living for only a few hours or a few days.

Table 14.1 List of marine chironomids and their distribution

SUBFAMILY: Chironominae		SUBFAMILY: Orthocladiinae	
<i>Tanytarsus</i> (van der Wulp, 1874)		<i>Thalassomyia</i> (Strenzke & Remmert, 1957)	
<i>T. magnihamatus</i> Tokunaga — Japan, Micronesia		( <i>Camptocladus thalassophilus</i> Goetghebuer — Europe)	
<i>T. pelagicus</i> Tokunaga — Japan, Micronesia		( <i>C. pacificus</i> Saunders — North America)	
<i>T. boadlae</i> Tokunaga — Japan		( <i>C. marinus</i> Saunders — North America)	
<i>T. halophilae</i> Edwards — Samoa, Micronesia		( <i>C. clavicornis</i> Saunders — North America)	
<i>T. maritimus</i> Edwards — Samoa, Micronesia		( <i>Spaniotoma nemalione</i> Tokunaga — Japan)	
<i>Pontomyia</i> (Edwards, 1926)			
<i>P. natans</i> Edwards — Samoa, Japan, Australia			
<i>P. pacifica</i> Tokunaga — Japan			
<i>P. oceana</i> Tokunaga — Palau			
<i>P. cottoni</i> Womersley — Australia			
SUBFAMILY: Clunioninae Tribe: Clunionini			
<i>Clunio</i> (Haliday, 1855)		Tribe: Telmatogetonini	
<i>C. marinus</i> Haliday — Europe		<i>Thalassomyia</i> (Schiner, 1856)	
<i>C. africanus</i> Hesse — Africa		<i>T. africana</i> Edwards — Africa	
<i>C. pacificus</i> Edwards — Japan, Marianas, Samoa		<i>T. frauenfeldi</i> Schiner — Mediterranean	
<i>C. tsushimensis</i> Tokunaga — Japan, Hawaii		<i>T. japonica</i> Tokunaga & Kômyo — Japan	
<i>C. setoensis</i> Tokunaga — Japan		<i>T. setoipennis</i> Wirth — Hawaii	
<i>C. aquilonius</i> Tokunaga — Japan		<i>T. pilipes</i> Edwards — Samoa	
<i>C. takahashii</i> Tokunaga — Japan		<i>T. longipes</i> Johnson — Samoa	
		<i>T. sabroskyi</i> Tokunaga — Micronesia	



- C. purpureus* Hashimoto — Japan  
*C. littoralis* Stone & Wirth — Hawaii  
*C. vagans* Stone & Wirth — Hawaii  
*C. brevis* Stone & Wirth — Hawaii  
*C. tuthilli* Tokunaga — Micronesia  
*C. marshalli* Stone & Wirth — North America  
*C. californiensis* Hashimoto — North America  
*C. schmitti* Stone & Wirth — South America  
*C. fuscipennis* Wirth — South America  
*C. brasiliensis* Oliveira — South America  
*C. martini* Hashimoto — Australia  
*Belgica* (Jacobs, 1900)  
*B. antarctica* Jacobs — Antarctic  
*Tethymyia* (Wirth, 1949)  
*T. aptena* Wirth — California  
*Eremoptera* (Kellogg, 1900)  
*E. browni* Kellogg — California  
*E. murphyi* Schaeffer — South Georgia Island
- T. martima* Wirth — Micronesia, New Caledonia  
*T. bareni* Wirth — California  
*Telmatogeton* (Schiner, 1866)  
*T. japonicus* Tokunaga — Japan, Hawaii, North America, Australia  
*T. pacificus* Tokunaga — Japan, Hawaii  
*T. pusillum* Edwards — Marquesus, Mariana, Micronesia  
*T. macswaini* Wirth — North America  
*T. latipennis* Wirth — North America  
*T. simplicipes* Edwards — South America  
*T. trochanteratum* Edwards — South America  
*T. atlanticum* Oliveira — South America  
*T. nanum* Oliveira — South America  
*T. sancti-pauli* Schiner — Africa  
*T. minor* Kieffer — Africa  
*T. australicus* Womersley — Australia  
*Paraclunio* (Kieffer, 1911)  
*P. trilobatus* Kieffer — Pacific coast of North America  
*P. alaskensis* Coquillett — Pacific coast of North America  
*P. spinosus* Hashimoto — Pacific coast of North America  
*Psammathiomya* (Deby, 1899)  
*P. pectinata* Deby — England, France  
*Haliorytus* (Eaton, 1875)  
*H. amphibius* Eaton — Subantarctic region  
*H. magellanica* Jacobs — Subantarctic region  
*H. macquariensis* Brundin — Subantarctic region

Most of the members of Chironomidae are terrestrial with aquatic or terrestrial larvae, but about 12 genera with 50 species are marine and restricted to intertidal zones. A few species are found in the open sea. The marine species are probably polyphyletic; most are of terrestrial origin but a few are freshwater. Unlike their freshwater relatives, larvae of marine chironomids lack anal gills and prothoracic respiratory horns are absent in the pupae. In addition, the antennae, palpi and eye facets are highly reduced in the adults of most genera. The wings, halteres and legs are also degenerated or modified in some specialized genera. The emergence habit, locomotion and reproductive behaviour are also different from those of land species. Such morphological and ecological specializations are adaptations to the littoral life.

(Since this article was received I was sent a pre-print of a pertinent review on the adaptations of chironomids to intertidal environments to be published in *Annu. Rev. Entomol.* vol. 21, by Dr. D. Neumann. Ed.)

## 14.2 SYSTEMATICS

Chironomidae is divided into 6 subfamilies, but marine members are found in only three, namely Chironominae, Orthocladiinae and Clunioninae, which can be distinguished using the key on p. 388. Table 14.1 lists the known marine genera and species.

### 14.2.1 Subfamily Chironominae

Chironominae can be separated from other subfamilies by the following characters: length of front basitarsus longer than or subequal to length of front tibia; dististyle of male hypopygium immovable and always extended caudad. There are only two genera containing marine species.

1. *Tanytarsus* (van der Wulp) Most members of *Tanytarsus* are associated with inland waters, but five species are marine. The antennae 14-segmented, plumose in the male, but 6-segmented and not plumose in the female. Maxillary palpi 4-segmented in both sexes. Wings fully developed. Pupa: abdominal tergites each with a pair of tuberculous patches; last segment with lateral swimming hairs. Prothoracic respiratory horns absent. Larva: body reddish yellow. Antennae 5-segmented, relatively long. Anal gill absent.
2. *Pontomyia* (Edwards) (*Fig. 14.1*) This genus is exclusively marine. There is remarkable sexual dimorphism. Male: long filiform antennae; wings modified into peculiar oar-like organs; halteres are present; front legs very long, without tarsal claws; middle legs short with distinct claws; hind legs long, extended caudad with only vestiges of claws. Female: body almost vermiform, without

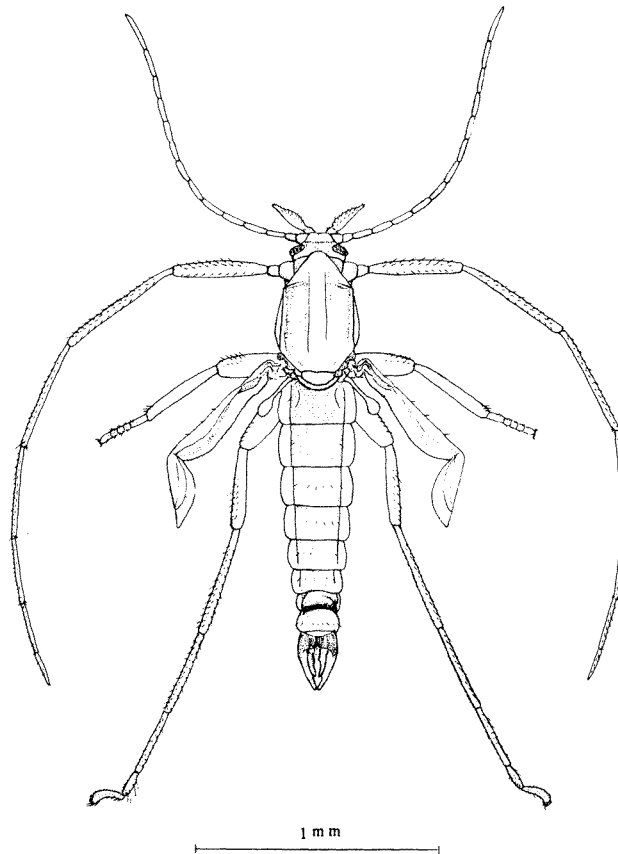

Fig. 14.1. *Pontomyia cottoni* (Womersley). Male imago.

antennae, palpi, wings, halteres or front legs. Pupa of *Pontomyia* closely resembles that of *Tanytarsus* but can be distinguished by the absence of latero-caudal spines on the penultimate segment of the abdomen and sparse swimming hairs. Larva of *Pontomyia* is also similar to that of *Tanytarsus* but differs in the paler colouration and markedly narrow and slender 8th abdominal segment.

In this subfamily, some seashore or halobiotic species are known, particularly in the genus *Chironomus* (e.g. *C. salinarius* (Kieffer), *C. halophilus* (Kieffer), *C. enteromorphae* (Tokunaga)), but the larvae of these species are rather euryhaline and their habitats are not always restricted to the tidal zone.

#### 14.2.2 Subfamily Orthoclaadiinae

Antennae as a rule plumose, with 14 segments in the male, not plumose, with 5–7 segments in the female. Pronotum never divided into separate lobes, postscutellum

with median keel or furrow; anepisternal suture well developed reaching forward to close the base of fore-coxa. Front tibia regularly longer than basitarsus. Dististyles of the male hypopygium movable and always folded inward, with single terminal spine. Only one genus is truly marine.

1. *Thalassosmittia* (Strenzke and Remmert) Wings fully developed. Antennae with 10–14 segments in the male but 6 segments in the female. Palpi 4-segmented. Hind tibia with only one spur. Last abdominal tergite of male with anal point. Basistyle of male hypopygium with 1–2 lobes and dististyle nearly cylindrical. Pupal prothoracic respiratory horns absent. Larva greyish or purplish in color, without anal gill. This genus was set up unifying the former 5 marine species, *Camptocladius thalassophilus* (Goetghebuer), *C. pacificus* (Saunders), *C. marinus* (Saunders), *C. clavicornis* (Saunders) and *Spaniotoma nemalione* (Tokunaga) (Strenzke and Remmert, 1957).

In addition, several non-specialized halobiotic species are known in *Trichocladius*, *Orthocladius*, *Cricotopus*, etc.

### 14.2.3 Subfamily Clunioninae

Clunioninae can be separated from Orthoclaudiinae by the following features: Antennae never plumose. Pronotum completely divided into lateral lobes; postscutellum without median keel or furrow; episternal suture absent or, if present, almost vestigial. Male hypopygium generally inverted. This subfamily is usually subdivided into two tribes, Clunionini and Telmatogetonini (Wirth, 1949).

#### Tribe Clunionini

Eyes pubescent; wings reduced except in male *Clunio*. Second segment of hind tarsus not longer than third, fourth segment of all tarsi cylindrical, fifth never trilobed; claws always simple. Basistyles of male hypopygium moderate to large in size, dististyles triangular in shape. Female abdomen rounded, without ovipositor. Pupa (Fig. 14.2a): prothoracic respiratory horns absent; last abdominal segment bare and bilobed. Larva (Fig. 14.3a): antennae 5-segmented; premandible with 3 or 4 teeth. There are four marine genera.

1. *Clunio* (Haliday) (Fig. 14.4) This genus is remarkably sexually dimorphic. Male: antennae 11-segmented. Palpi unsegmented. Third segment of hind tarsus longer than second or fourth segment, mostly with distinct incision on its hind edge. Hypopygium turned through 100 to 180°. Female: antennae with less than 7 segments, palpi vestigial; wings and halteres absent; legs short, often vestigial. There are 18 marine species.

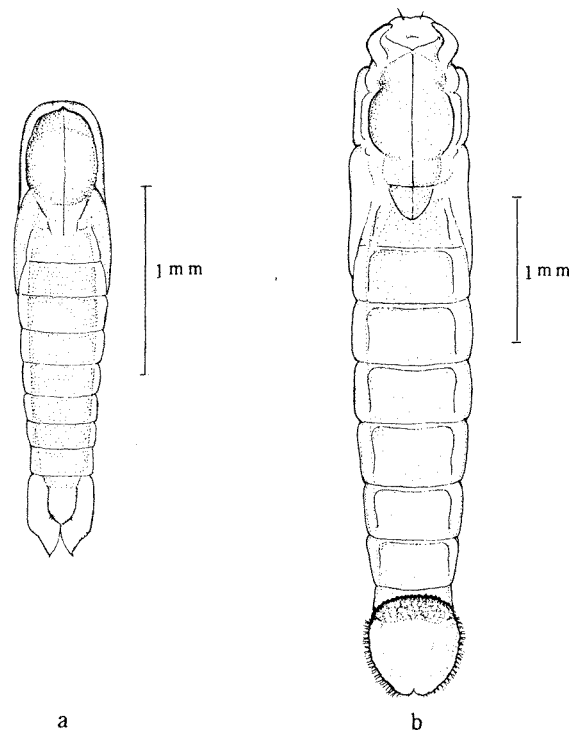

Fig. 14.2. Pupae of *Clunio tsushimensis* (a) and *Telmatogeton japonicus* (b).

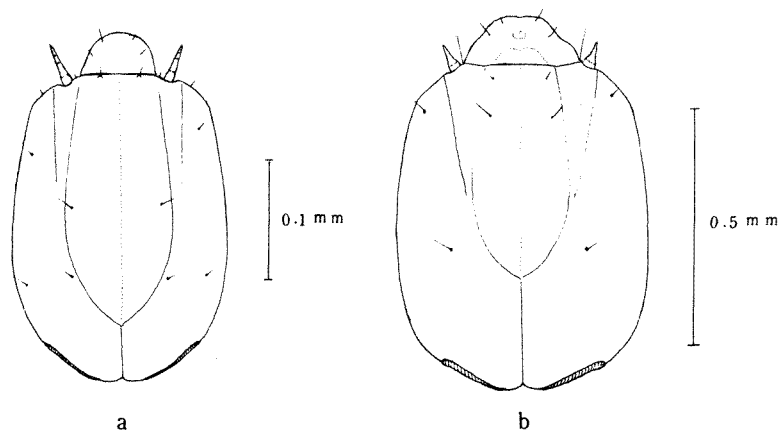

Fig. 14.3. Head capsules of the larvae of *Clunio tsushimensis* (a) and *Telmatogeton japonicus* (b).

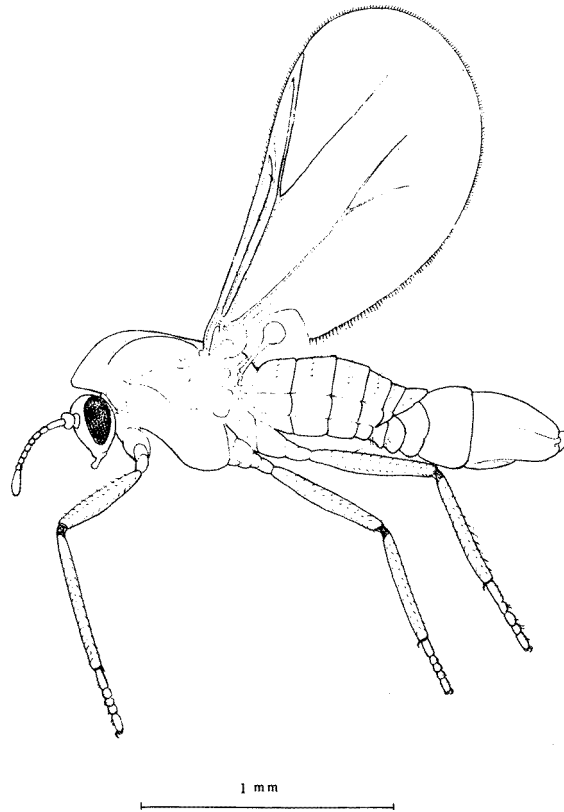

Fig. 14.4. *Clunio californiensis* (Hashimoto). Male imago.

2. *Belgica* (Jacobs) (Fig. 14.5) There is no sexual dimorphism. Antennae short, 4-segmented, without hairs, palpi 4-segmented. Wings atrophied into small finger-like projections; legs well developed. Male hypopygium turned through 30 to 100°. Only one species, *B. antarctica* (Jacobs), is known.
3. *Tethymyia* (Wirth) This genus resembles *Belgica*, but differs in having 7-segmented antennae, 1-segmented palpi and more vestigial wings. Only one species, *T. aptena* (Wirth), is known from California, North America.
4. *Eretmoptera* (Kellogg) (Fig. 14.6) This genus, with 2 known species, is brachypterous in both sexes. Antennae short, 6-segmented in the male, 4-segmented in the female. Palpi 3- or 4-segmented in both sexes. Hypopygium turned through 90 to 100°.

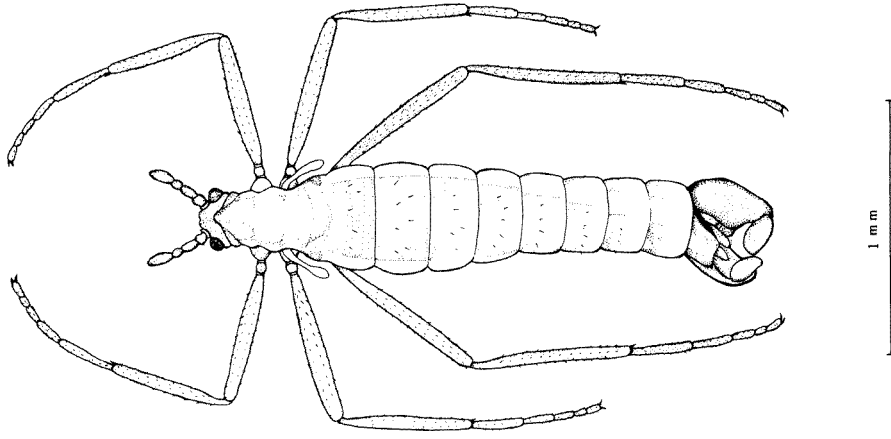

Fig. 14.5. *Belgica antarctica* (Jacobs). Male imago.

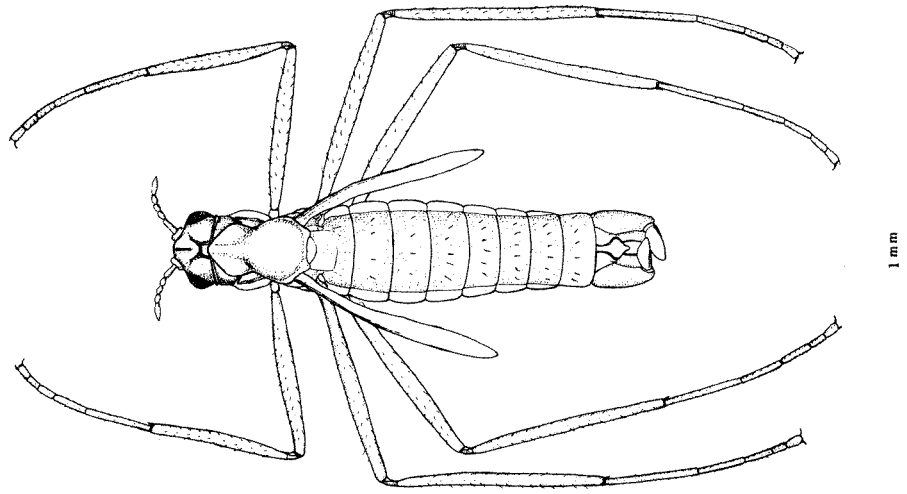

Fig. 14.6. *Eretmoptera browni* (Kellogg). Male imago.

Adult: Antennae 7-segmented, palpi 1- to 4-segmented; eyes bare; wings fully developed or reduced in both sexes. Legs with second segment of hind tarsi longer than the third, the fourth cordate, and the fifth trilobed; tarsal claws simple or cleft in the male. Male hypopygium relatively small. Female with long and tapering cerci. Pupa (Fig. 14.2b): prothoracic respiratory horns present; last abdominal segment modified into a large disc-like shield. Larva (Fig. 14.3b): antennae short, 4-segmented; premandibles with 5–7 teeth.

*Thalassomyia* (Schiner) (Fig. 14.7) Antennae 7-segmented; palpi 4-segmented. Wings and legs fully developed; male hypopygium rotated through 100 to 180°. There are 9 known species.

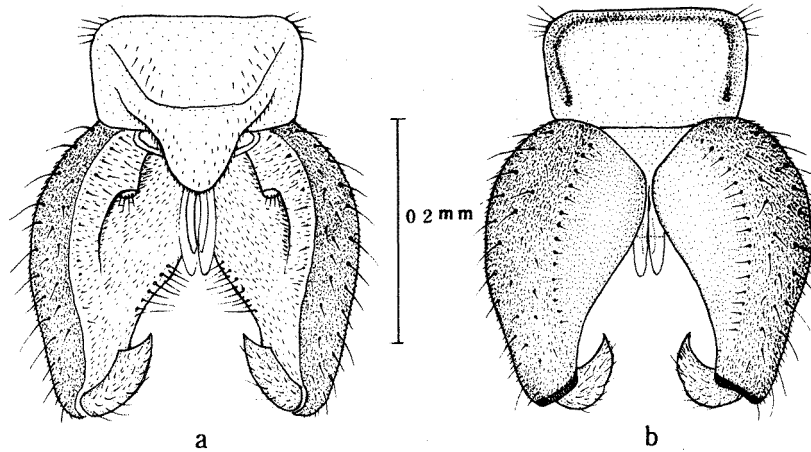

Fig. 14.7. *Thalassomyia japonica* (Tokunaga and Komyo). Male hypopygium. (a) Dorsal view; (b) ventral view.

*Telmatogeton* (Schiner) (Fig. 14.8) This genus is related to *Thalassomyia*, but differs in having 2-segmented palpi and deeply trilobate last tarsal segment. 12 marine species are known.

*Paraclunio* (Kieffer) (Fig. 14.9) This genus closely resembles *Telmatogeton*, but is distinguished by its very thick and robust femora bearing a blunt spine at the inner posterior end. 3 species are known from the Pacific coast of North America.

*Psammathiomyia* (Deby) This genus is brachypterous in both sexes. Antennae 7-segmented, palpi 2-segmented. Hypopygium rotated through 90°. Only one species, *P. pectinata* (Deby) is known from England and France.



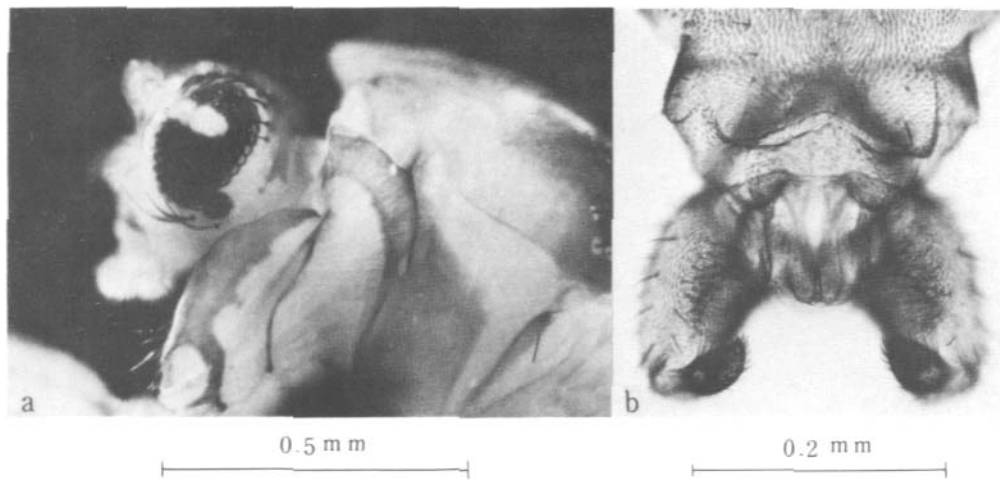
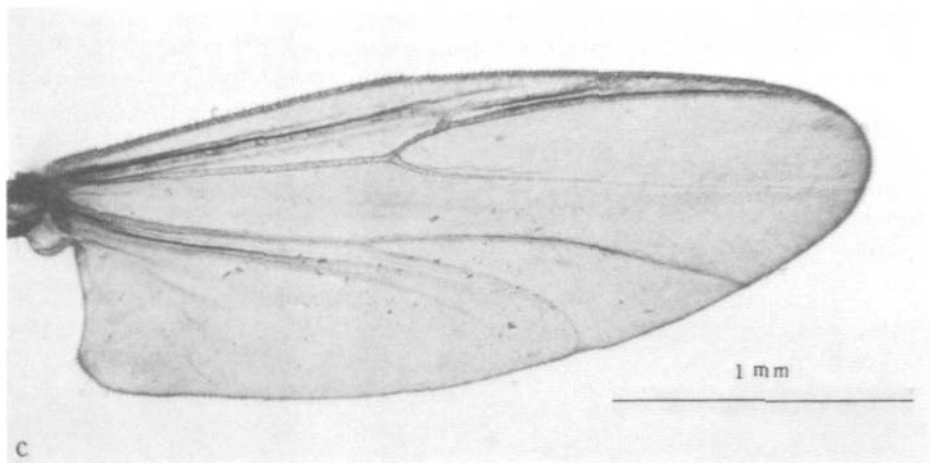
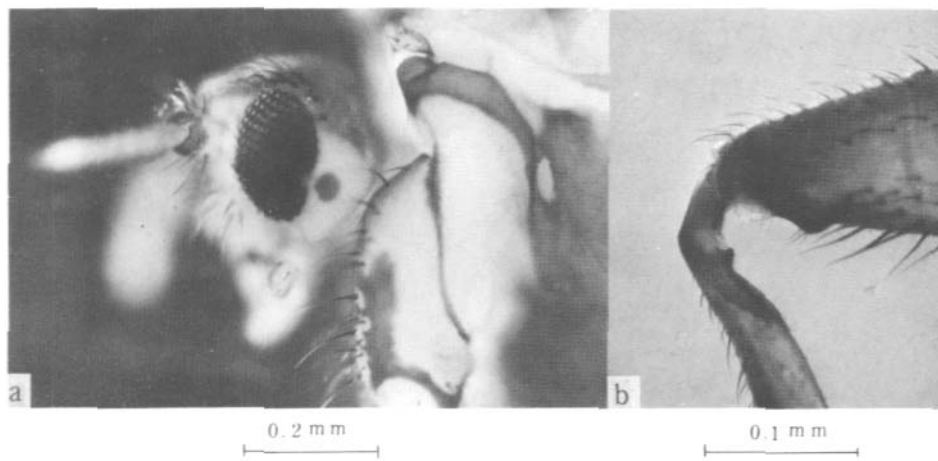

Fig. 14.8. *Telmatogeton australicus* (Womersley). Male. (a) Head; (b) hypopygium.



*Halirytus* (Eaton) (Fig. 14.10) This genus is also brachypterous. Antennae 5- or 6-segmented, palpi 1- or 2-segmented. 3 species are found in the subantarctic region. It is of interest to note that at least two of the species, *H. amphibius* and *H. macquariensis*, are considered parthenogenetic (Brundin, 1962).

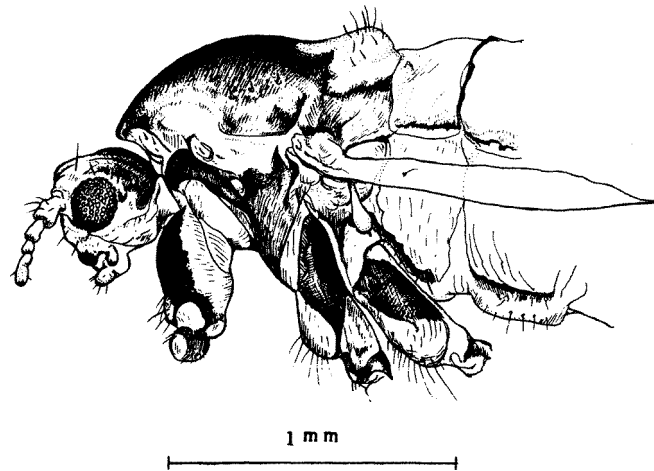

Fig. 14.10. *Halirytus macquariensis* (Brundin), female. (Brundin, 1962).

#### KEY TO GENERA OF MARINE CHIRONOMIDS

- |  |                        |
|--|------------------------|
| 1. Basitarsi on front legs subequal to or longer than tibiae, dististyles not infolded | 2                      |
| Basitarsi on front legs shorter than tibiae, dististyles infolded                      | 3                      |
| 2. Female external appendages normal   | <i>Tanytarsus</i>      |
| Female almost vermiform  | <i>Pontomyia</i>       |
| 3. Male hypopygium not inverted, basistyles with inner lobes                           | <i>Thalassosmittia</i> |
| Male hypopygium inverted, basistyles without inner lobes                               | 4                      |
| 4. Eyes pubescent, female cerci short, extended ventrad                                | 5                      |
| Eyes bare, female cerci long, tapered and extended caudad                              | 8                      |
| 5. Sexual dimorphism, segment III on hind tarsi of male longer than II                 | <i>Clunio</i>          |
| Sexual isomorphism, segment III on hind tarsi of male subequal to II                   | 6                      |
| 6. Brachypterous, halteres present   | <i>Eretmoptera</i>     |
| Wings rudimentary, halteres absent   | 7                      |
| 7. Antennae 7-segmented, palpi 1-segmented   | <i>Tethymyia</i>       |
| Antennae 4-segmented, palpi 4-segmented  | <i>Belgica</i>         |
| 8. Palpi 4-segmented, hypopygium rotated through 90–180°                               | <i>Thalassomyia</i>    |
| Palpi 1- or 2-segmented, hypopygium rotated through 30–90°                             | 9                      |
| 9. Front femora swollen with an angular projection near apex                           | <i>Paraclunio</i>      |
| Front femora normal without an angular projection                                      | 10                     |
| 10. Fully winged   | <i>Telmatogeton</i>    |
| Brachypterous  | 11                     |
| 11. Antennae 7-segmented   | <i>Psammathiomyia</i>  |
| Antennae 5- or 6-segmented   | <i>Halirytus</i>       |

### 14.3 GENERAL MORPHOLOGY

There is some variability in the morphology of adults within the family, especially in those genera with sexual dimorphism. The general morphology of a representative genus, *Clunio*, is briefly described here.

Male imago. Head (Fig. 14.11a): with large, regularly pubescent eyes; antennae as a rule 11-segmented (8-segmented only in *C. takahashii*) without plumose hairs; size and shape of each segment not uniform (Fig. 14.11b); the antennal ratio and the proportion of the length of the last segment to that of segments 3–10

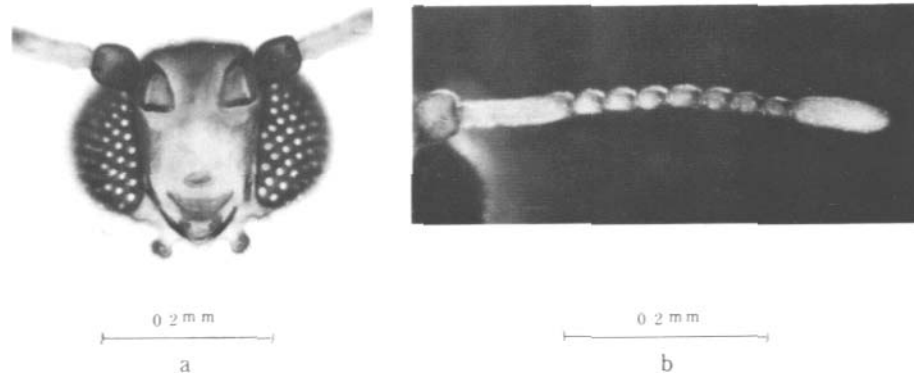

Fig. 14.11. *Clunio californiensis*. Male. (a) Head; (b) antenna.

is important for specific diagnosis; the palpi are short, unsegmented, with several minute setae; mouthparts reduced. Thorax: pronotum widely separated into two small lobes, without setae; mesonotum robust and bears only a few short setae; anepisternal suture degenerated. Wings rather broadly rounded and markedly petiolated. Venation illustrated in Fig. 14.12. Legs relatively short and stout, femora and tibia of all legs bear sparse rows of fine setae; tibial spurs (Fig. 14.13a) present on all legs, but sometimes absent on front legs in the smaller species. Third segment of hind tarsus usually deeply incised on hind edge, but *C. marinus* and *C. californiensis* lack such tarsal incision (Strenzke, 1960; Hashimoto, 1974). Tarsal claws (Fig. 14.13b) strongly curved with a tuft of hyaline setae and lamella on ventral side; pulvilli absent; empodium thickly plumose. Abdomen: tergites I to VII bear irregular rows of distinct setae; sternites VI, VII and VIII with characteristic setae-bearing chitinous plate (Fig. 14.14); shape of distal chitinous ridge of tergite VIII varies with species (Fig. 14.15). Abdominal segments VI and VII are distorted in species with rotated hypopygium (from 100 to 180°; Fig. 14.16) and sternite VIII usually becomes dorsal (Fig. 14.22a-c).

Female imago (Fig. 14.17). Head: eyes highly reduced, usually pubescent; number of the eye-facets (20–30) correlated with body size (Hashimoto, 1968);

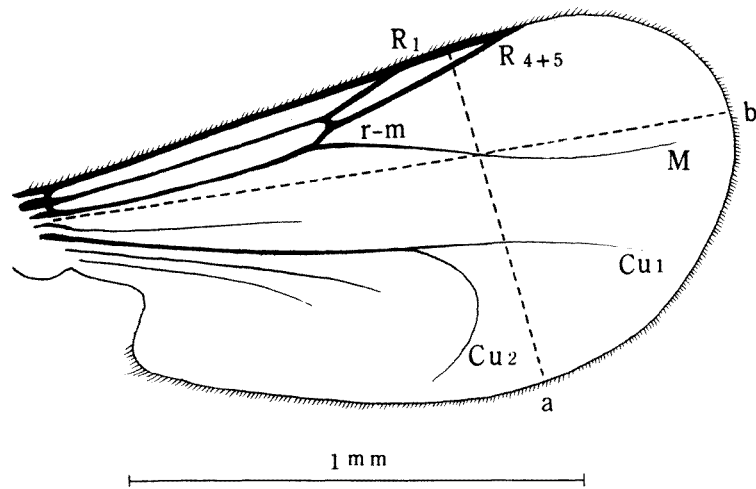

Fig. 14.12. Wing venation of *Clunio tsushimensis*. Line a, broadest cross-section; line b, length from base of M to wing tip.



Fig. 14.13. Hind tarsus (a) and last tarsal segment (b) of *Clunio tsushimensis*, male. E, empodium; L, hyaline lamella; C, claw.

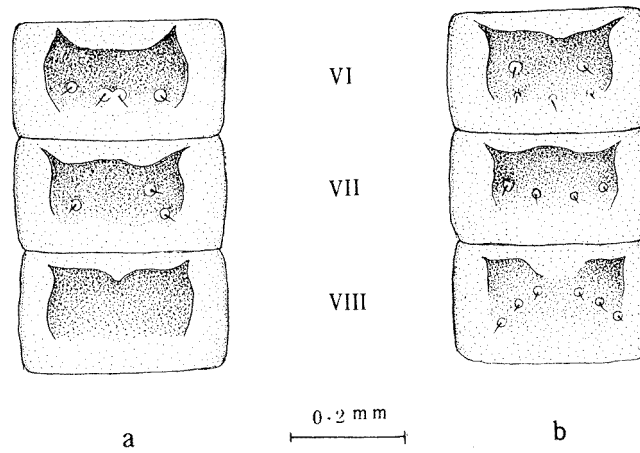

Fig. 14.14. VI to VIII posterior sternites showing chitinous patches and setal arrangement in *Clunio californiensis* (a) and *C. tsushimensis* (b).

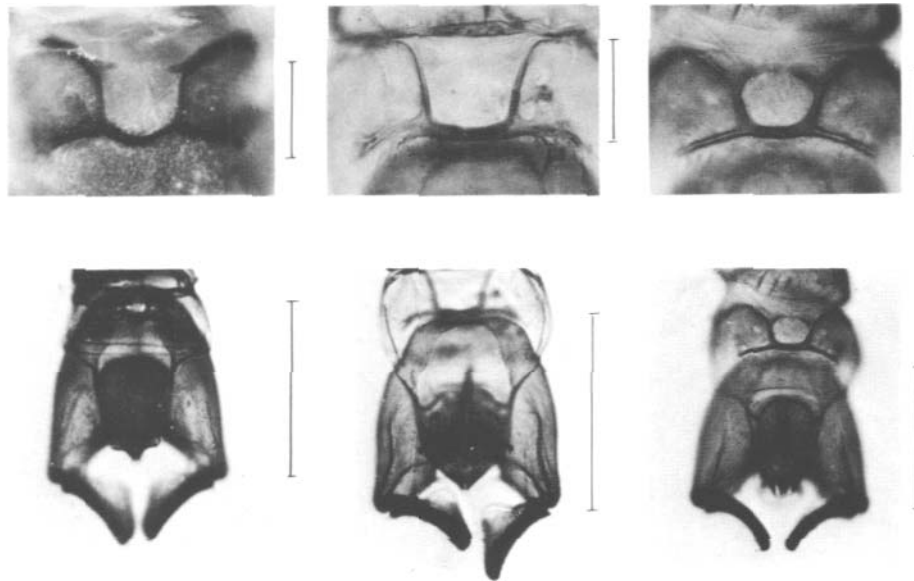

Fig. 14.15. Chitinous ridges on VIII tergite (above) and hypopygia (below) in *Clunio* spp. Left = *californiensis*, middle = *vagans*, right = *littoralis*. Scale lines: 0.1 mm (above), 0.5 mm (below).

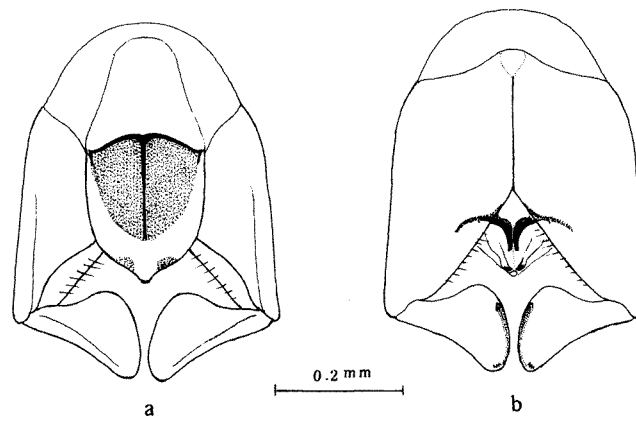

Fig. 14.16. Hypopygium of *Clunio aquilonius* (a) Dorsal aspect; (b) ventral aspect.

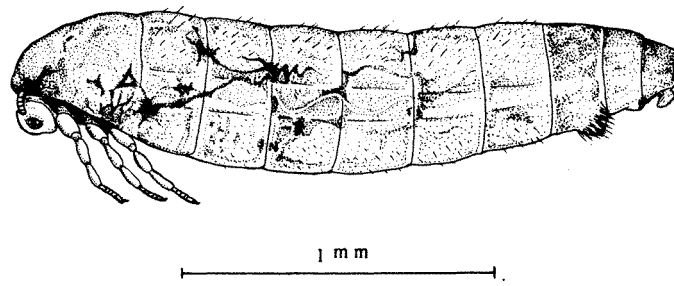

Fig. 14.17. *Clunio californiensis*, female.

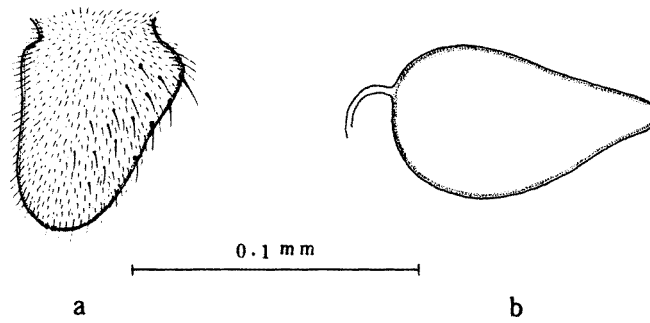

Fig. 14.18. Cercus (a) and spermatheca (b) of *Clunio californiensis*.

antennae short, normally 5 segments; palpi are vestigial. Thorax: pronotum, scutellum and postscutellum all reduced, without setae; wings and halteres absent; legs short, without tibial spurs; claws with hyaline lamellae and vestigial empodium. Abdomen: segments I to VII with 20–50 setae; VIIIth sternite bears a transverse band of dense long hairs on caudal portion; VIIIth sternite with a pair of crescent-shaped valval projections which are sclerotized along the caudal margin; cerci (Fig. 14.18a) small with numerous minute setae on both surfaces; there are always two spermathecae (Fig. 14.18b), usually oval, with partially sclerotized ducts.

Females of *Clunio* are highly variable in structure. In the most primitive species, *C. marinus*, the female has 7-segmented antennae, small vestiges of wings and a long third tarsal segment on the hind legs (Strenzke, 1960). In the specialized species, *C. purpureus*, the antennae are normally 2-segmented; in *C. takahashii* (Fig. 14.19), the antennae are only small projections, the eyes are completely absent and tarsi on all legs have only two vestigial segments (Hashimoto, 1965).

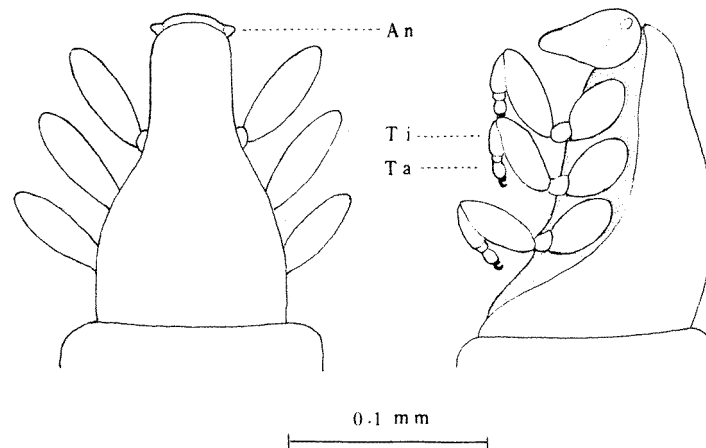

Fig. 14.19. *Clunio takahashii* Tokunaga, female. An, vestige of antenna; Ti, tibia; Ta, tarsus with only two segments. (Note: Knee joints on all legs immovable).

## 14.4 BIOLOGY

### 14.4.1 Life history

#### (a) Egg

The eggs of *Clunio* are laid in a jelly-mass. The number of eggs in an egg-mass varies from 50 to 200. In *Pontomyia*, the egg-mass is in a gelatinous cord with an average of 30 eggs (Tokunaga, 1932). On the other hand, the eggs of *Paraclunio*

and *Telmatogeton* are laid singly and not in a jelly-mass (Saunders, 1928; Tokunaga, 1934). The time required for embryonic development was estimated to take 3.5–7 days in *Clunio marinus* (Caspers, 1951; Neumann, 1966). The period is apparently dependent on temperature. In *C. tsushimensis*, the eggs hatch 80–90 hours after oviposition at 25°C (Oka and Hashimoto, 1959), but may take 10–12 days to hatch at 15°C. Embryonic development of *Clunio* is essentially the same as that of the freshwater genus *Chironomus*.

### (b) Larva

There are four larval instars and the newly hatched larvae soon begin to take food and to build the nest tubes. In *Clunio tsushimensis*, the period for each instar is 5–6, 5–6, 12–13 and 12–13 days, respectively, at 25°C (Oka and Hashimoto, 1959). The growth curve with the change of the size of the head capsule in each instar of *C. tsushimensis* is shown in Fig. 14.20. Length of larval development varies not only with temperature but also among individuals. The larvae are able to creep out from their nest with the help of their mandibles. Larvae of *Pontomyia* and *Tanytarsus* can swim and probably can be dispersed as planktonic organisms,

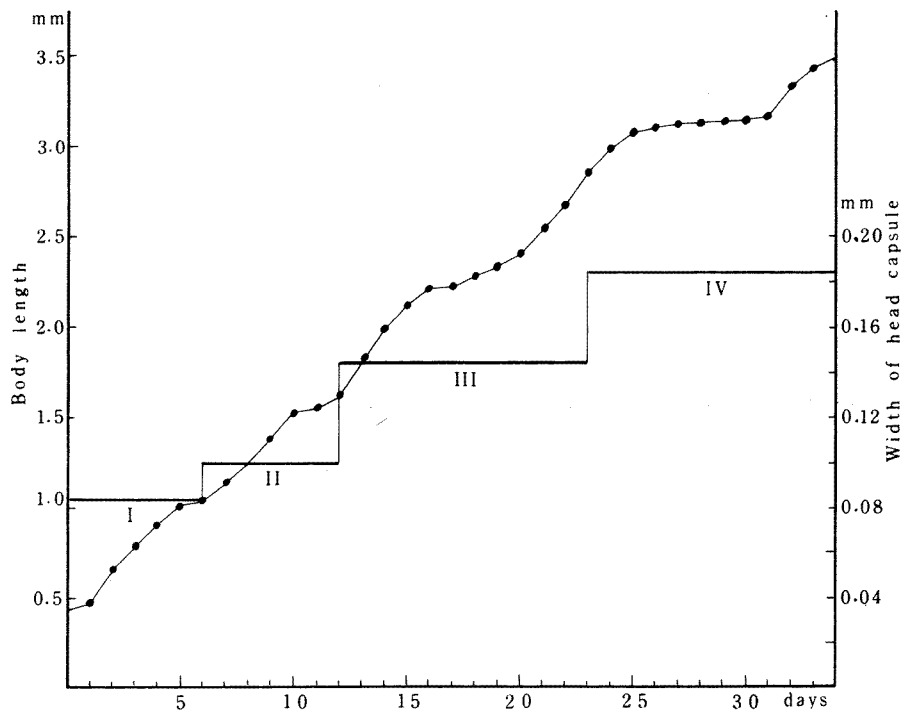

Fig. 14.20. Changes in body length (●—●) and width of head capsule (—) during larval development in *Clunio tsushimensis* Tokunaga. Roman numerals indicate larval instars.



particularly immediately after hatching; the other marine chironomid larvae do not swim at all.

The duration of the pupal stage is 7 days in *Telmatogeton sancti-pauli* (Hesse, 1934), about 2.5 days in *T. japonicus* (Tokunaga, 1933), 2–3 days in *Clunio tsushimensis* (Oka and Hashimoto, 1959) and 3.5 days in *C. marinus* (Neumann, 1971). Those data are mostly based on the observations made in summer. Neumann (1966) pointed out that the duration of the pupal stage is longer in the male than in the female at 20°C (Fig. 14.21). Before emergence, the pupa leaves the nest tubes and if the habitat is still underwater, it floats to the surface

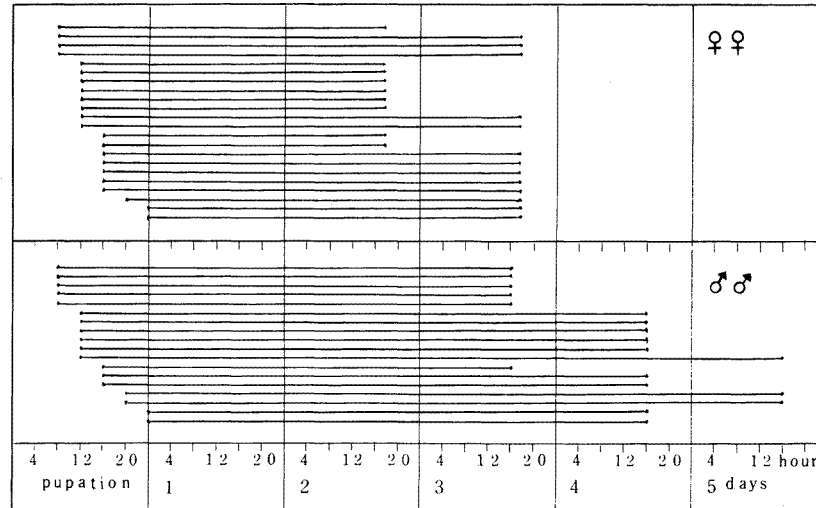

Fig. 14.21. Pupal duration in isolated females and males of *Clunio marinus* Haliday, Helgoland population, 6–18 h light, 20°C. (Modified from Neumann, Z. Vergl. Physiol. Vol. 53, 1966). (Similar data for *C. tsushimensis* described by Oka and Hashimoto, 1959).

as the pupal skin is filled with air. Pupae of *Pontomyia* and *Tanytarsus* come up to the water surface by active swimming.

The adult emerges from a dorsal split in the thorax of the pupal skin. The process of eclosion is usually completed within several seconds. It is of interest that in *Clunio*, the emergence of the female is usually completed with the assistance of the male (Hashimoto, 1957; Neumann, 1966; Olander and Palmén, 1968; Dordel, 1971). In the Tvärminne population of *C. marinus*, the emergence of an unassisted female is rare; in most cases the females are stripped by the

male (Olander and Palmen, 1968). In *C. tsushimensis* and *C. aquilonius*, the eclosion of the female without male assistance is apparently impossible. Female pupae isolated from males never emerge as adults and finally die (Hashimoto, 1957).

The male genitalia of marine Chironomidae, except *Tanytarsus* and *Thalassosmittia*, are distinctly inverted, and usually accompanied by a gradual distortion and dislocation of the more posterior abdominal segments. The morphological analysis of the segments distorted as a result of hypopygial rotation in the genus *Clunio* was first studied by Oka (1930; Fig. 14.22). In most species, the rotation of the hypopygium takes place shortly

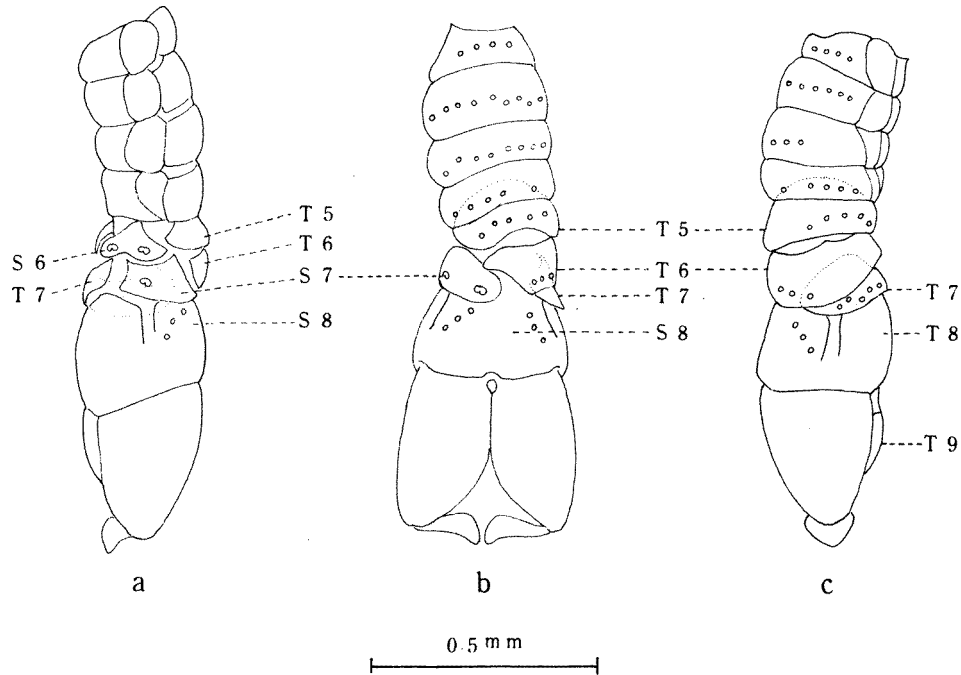

Fig. 14.22. Distortion and dislocation of posterior abdominal segments caused by hypopygial rotation in male *Clunio tsushimensis*. T = tergite, S + sternite. (a) Right side; (b) dorsal side; (c) left side. (After Oka, 1930).

after emergence. In *C. tsushimensis*, *aquilonius* and *purpureus*, the abdomen of the newly emerged male is not inverted at all, but shortly afterwards abdominal segments 6–8 gradually begin to rotate to the left or to the right. The twisted segments also become telescoped and markedly distorted until finally the 8th sternite becomes dorsal. Because of the telescoping of the segments, the abdomen of the male is distinctly shortened after completion of the rotation. During this process the male remains in a resting position, usually on the cast pupal skin. If disturbed it will move away, but must alight again to complete the process which is necessary for copulation. In *Pontomyia*,

the 8th abdominal segment and the hypopygium are turned upside down by torsion of only the middle part of the 7th segment (Hashimoto, 1959). A detailed study on the functional anatomy of torsion and its ecological implications has been studied in *Clunio marinus* by Dordel (1973).

#### 14.4.2 Reproduction

##### *Adult emergence and mating*

Adult *Clunio* reaches sexual maturity soon after emergence. In general, the peak of diurnal male emergence precedes that of the female (Neumann, 1966; Fig. 14.23) and the numerous males actively swarm to seek

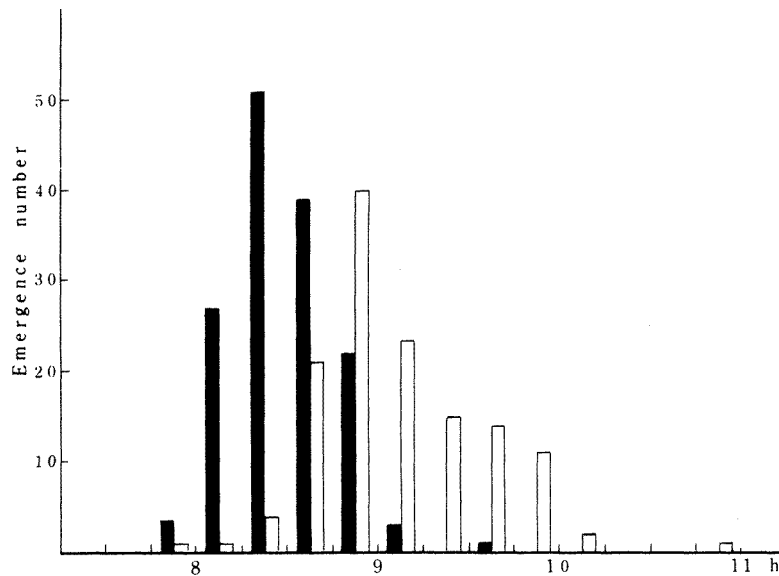

Fig. 14.23. Diurnal emergence of *Clunio tsushimensis* (July 8, 1960, Shimoda, Japan). Black co-columns = males, white columns = females. Substrate with *Clunio* larvae collected and kept in the laboratory one day before the observation, emergence number recorded every 15 min. Precedence of male emergence also found in *C. marinus* (Neumann, 1966).

female pupae. Having found a female, the male seizes it and touches the dorsal thorax with its front legs. Upon this stimulus, the female pupal skin is ripped in a moment. Then, the male skillfully pulls the edge of the ruptured skin backwards along the female body axis with his hind legs and the styles of the hypopygium (Fig. 14.24). During this process, the female remains passive and moulting is effected exclusively by the male. As soon as the female is stripped, the male grasps the ultimate segment of the female abdomen with its dististyles and the two become attached. The pair first keep a side-by-side or face-to-back position but as the male turns backwards,

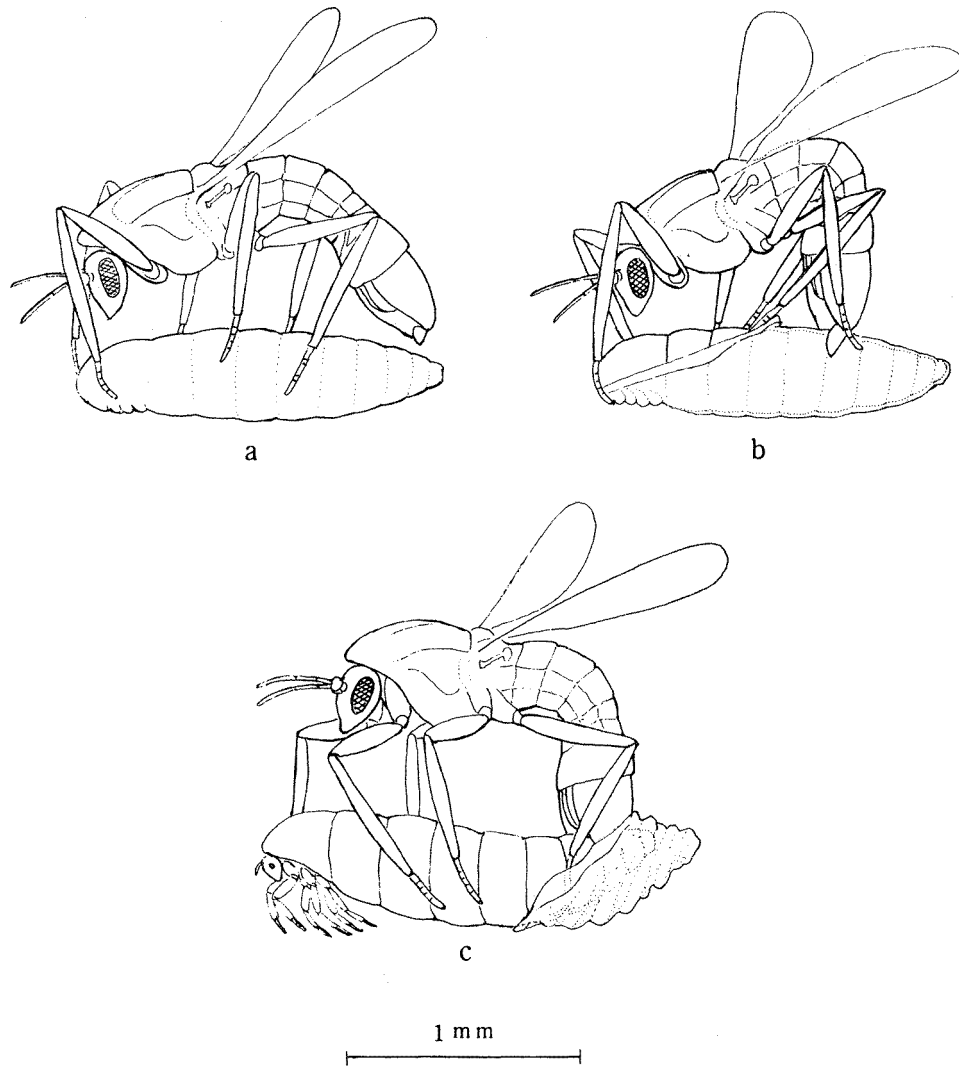

Fig. 14.24. Process of female emergence with male assistance in *Clunio tsushimensis* (a–c).

they switch to an end-to-end position (Fig. 14.25). A different copulation process in *Clunio marinus* has been illustrated by Dordel (1971). Pairing usually continues for more than 10 minutes during which the male runs about carrying the female in a mating dance (Fig. 14.25). In *C. californiensis*, however, mating is performed in the resting position (Hashimoto, 1974).

The female begins to lay eggs soon after she has been liberated from the male and dies shortly after oviposition. The male, on the other hand, will search for other virgin females and in most cases will copulate with two or three females.

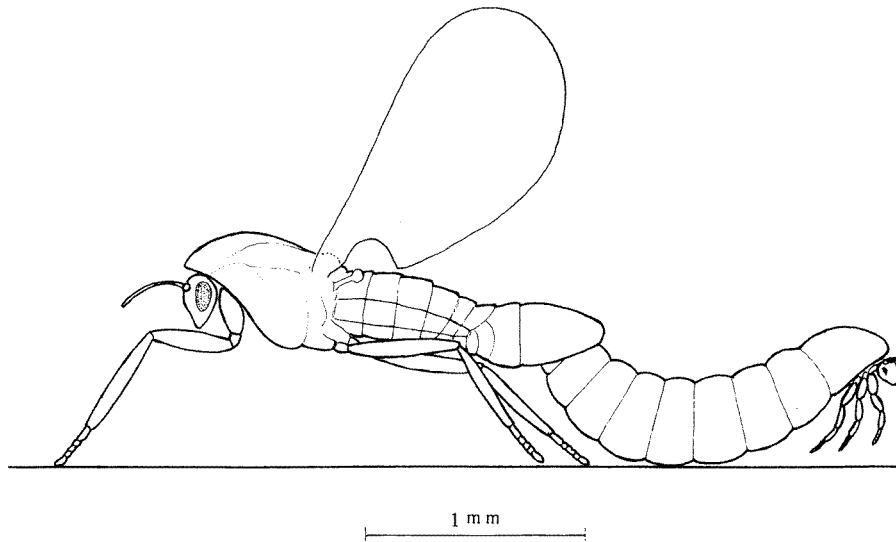

Fig. 14.25. Pairing posture in *Clunio tsushimensis*.

In a mating swarm of *Clunio*, one can often see more than one male attempting to mate with the same female, but usually only one performs the true copulation, the others merely cling to the side of the female abdomen with their dististyles (Hashimoto, 1969).

The mating behaviour of *C. takahashii* is very different from that of other *Clunio* species (Hashimoto, 1965). The highly degenerated female of this species is rarely seen, as pairing always takes place hidden among algae. In this species, the male often copulates with a female whose anterior half is still lying in the nest case with only the posterior half of the abdomen stripped off the pupal skin (Fig. 14.26). Mating lasts only one or two minutes and the female usually receives sperm and lays the egg-mass within the nest tube. Since the female cannot free herself from the nest case or float up to the water surface, the male cannot meet with the female when the habitat is not exposed. Unlike other species, *C. takahashii* is never found in tidepools or lower levels of the tidal zone.

The females of *C. purpureus* also remain in the nest throughout their lifetime. The mating behaviour and habitat of this species are similar to those of *C. takahashii*.

*Pontomyia* pairs in an end-to-end position while the male swims vigorously on the water surface. Males of *P. pacifica* often copulate with more than one female and adults of both sexes die within a few hours of emergence (Tokunaga, 1932).

Mating behaviour in the fully winged genera, *Paraclunio*, *Telmatogeton* and *Thalassomyia* is basically uniform. Pairing is performed normally in a face-to-back position on exposed rock surfaces. In *Telmatogeton japonicus*, the female

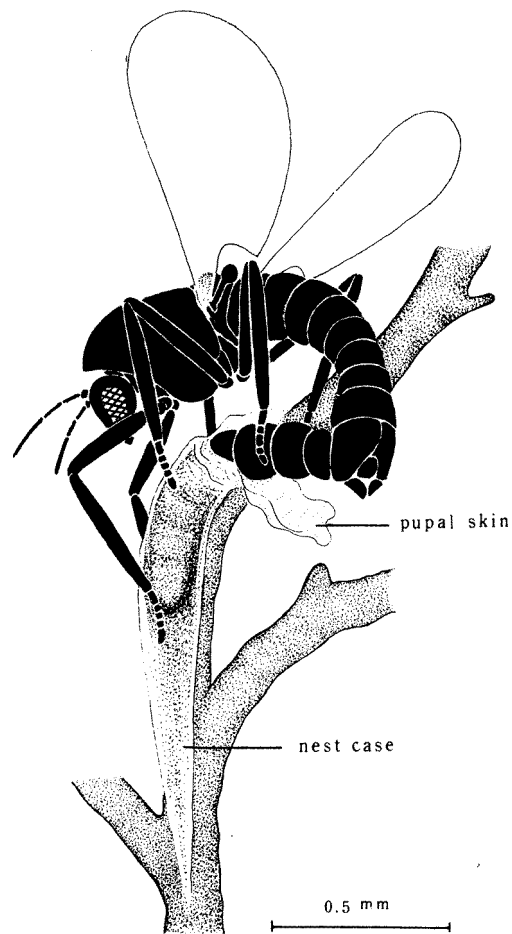

Fig. 14.26. *Clunio takahashii* in copula.

often runs carrying the male on her back, but in *Thalassomyia japonica* the paired insects usually sit still while copulating (Hashimoto, 1964).

### 14.4.3 Seasonality

#### (a) Seasonal appearance

Marine chironomids are as a rule found all the year round in areas where the annual seawater temperature is above 15°C, but there are several exceptions. *Telmatogeton sancti-pauli* appears mostly in the winter or during colder and wetter months of the year (Hesse, 1934). *Tethymia aptena* is very common during winter months in Californian coasts, but during March the number decreases rapidly and by early summer it practically disappears, and does not reappear until the

winter rain and cold weather begins in November and December (Wirth, 1949). *Clunio aquilonius* is found in the southern parts of Japan throughout the year, but is very rare during July to September (Fig. 14.27), whereas the closely related and associated *C. tsushimensis* is almost constant in number throughout the year (Hashimoto, 1975).

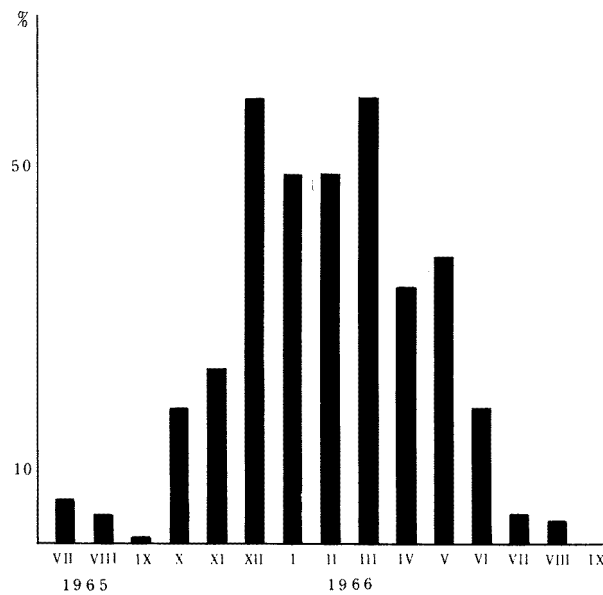

Fig. 14.27. Seasonal emergence of *Clunio aquilonius* (July 1965 to September 1966, Shimoda, Japan). Number of *C. aquilonius* emerged expressed as percentages of total number of *C. aquilonius* and *C. tsushimensis* collected per month.

In high latitudes where the temperature drops below 5°C in winter, the period of appearance of marine chironomids is restricted to the warmer seasons. For instance, *Clunio marinus* appears only from May to October in Helgoland (Caspers, 1951), from mid-July to the end of August in Northern Baltic, Finland (Palmén and Lindeberg, 1959) and from the end of April to September in Western Norway (Koskinen, 1968). It has only one generation in Northern Finland (Palmén and Lindeberg, 1959) but can have 2–3 generations a year in the Helgoland area (Neumann, 1966).

In temperate zones, seasonal variation in water temperature was found to influence the characteristics of species. Adults of *Paraclunio alaskensis* taken in late summer are less than half the size of early spring forms (Saunders, 1928). In *Telmatogeton japonicus* also, summer forms are much smaller than spring

forms from the same locality (Tokunaga, 1935). Seasonal variation of body size in *Clunio tsushimensis* is also closely correlated to the annual change of the water temperature (Fig. 14.28) (Hashimoto, 1968). The ratio of antennal segments, which is an important specific character, was also found to fluctuate with the season (Fig. 14.29) with a maximum in late summer and a minimum in early spring. The pattern is similar in *C. aquilonius* (Hashimoto, 1969). The effects of temperature on adult body length and antennal ratio in *Clunio tsushimensis* are shown in Figs 14.30 and 14.31.

#### 14.4.4 Food

Larvae of *Tanytarsus* and *Pontomyia* feed mainly on algal debris and on various diatoms (Buxton, 1926; Tokunaga, 1932). Stomach contents of larval *Telmatogeton japonicus* was found to consist of fragments of living as well as dead algae, sand particles and diatoms (Tokunaga, 1932; Wirth, 1947b). Most of the marine chironomids seem to be algal or algal detrital feeders, but larvae of *Clunio* are thought to be omnivorous. They feed not only on algal debris and diatoms (Chevrel, 1894; Caspers, 1951) but also on dead or half-dead bodies of the various animals including other chironomid larvae. True carnivores are not known in marine chironomids, nevertheless they are not uncommon in freshwater species, particularly in Tanypodiinae.

#### 14.4.5 Predators

Little is known about the predators of marine chironomids. Caspers (1951) observed the small shore crab *Carcinus maenas* taking the pupa of *Clunio*. The adult of *Clunio* is often preyed upon by the marine strider *Halovelgia maritima* (Esaki) and a marine mite *Leptotrombium* (Oka, 1930). These small predatory animals, however, feed only on the almost exhausted adults after reproduction. Tokunaga (1931) examined the gut contents of the migratory dragon fly *Pantara flavescens* which often swarm in the rocky shore at Seto, Japan and found many seashore chironomids, such as *Tanytarsus*, *Chironomus*, etc., besides the marine crane-fly *Dicranomyia*, but found no truly marine chironomids such as *Clunio* or *Telmatogeton*. Since marine chironomids swarm close to their breeding ground and are small-bodied, with a very short adult life, they are thus protected against such predators as dragonflies and birds.

The free-swimming or floating larvae and pupae of *Tanytarsus* and *Pontomyia* may be consumed by tidepool fish, but so far, no detailed dietary studies have been made. Larvae of *Paraclunio* have been found in several fish (Morley and Ring, 1972).



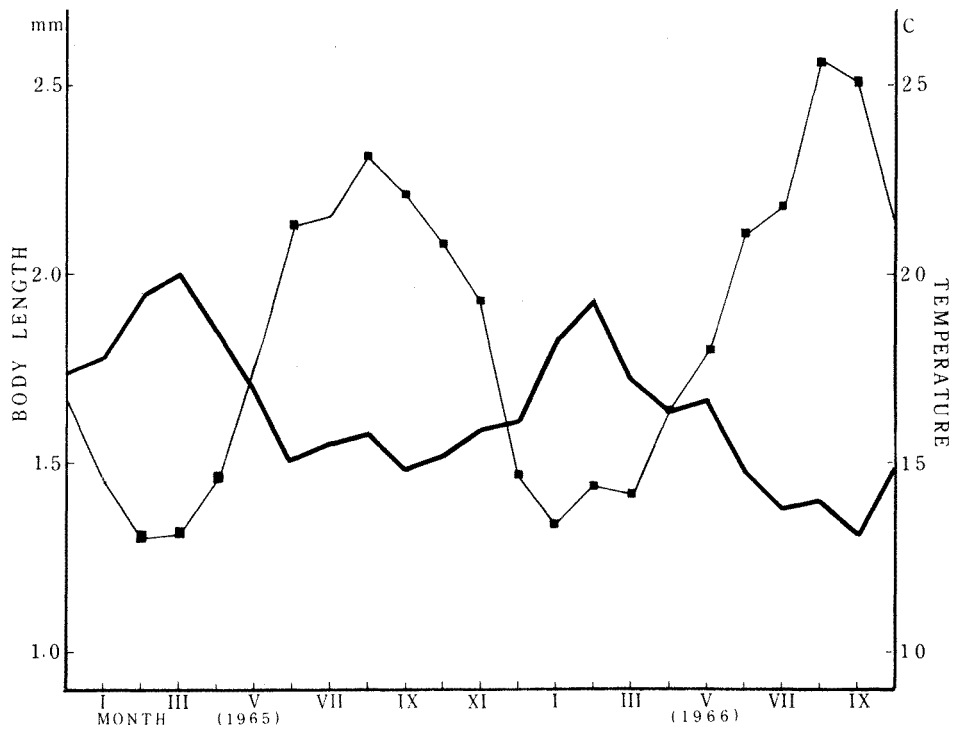

Fig. 14.28. Seasonal variations in body length of male *Clunio tsushimensis* (■—■) and sea-water temperature (—).

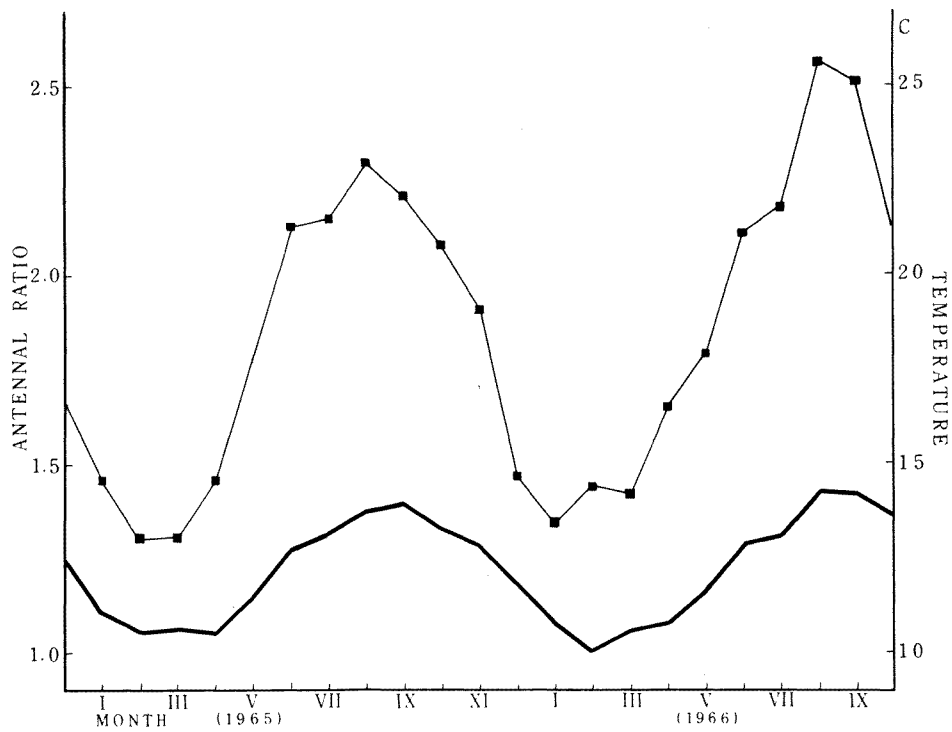

Fig. 14.29. Seasonal variations in antennal ratios of male *Clunio tsushimensis* (■—■) and sea-water temperature (—). (Antennal ratio = length of ultimate segment: combined lengths of remaining segments; see Hashimoto, 1968).

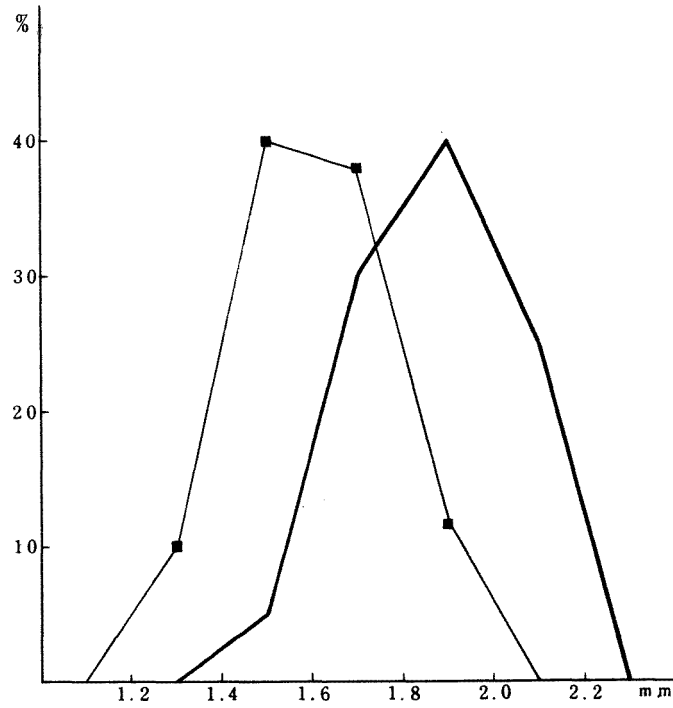

Fig. 14.30. Body length frequencies of male *Clunio tsushimensis* reared at 25°C (■—■) and 15°C (—).

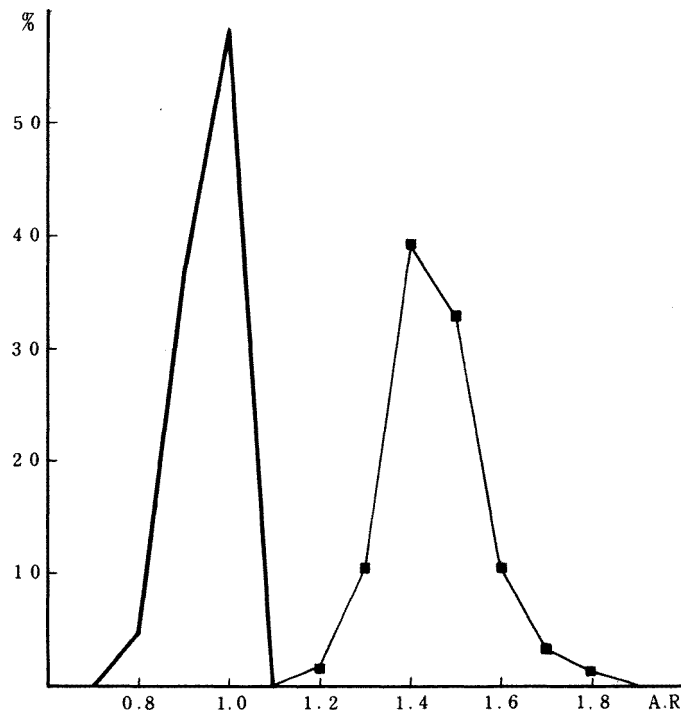

Fig. 14.31. Antennal ratio frequencies of male *Clunio tsushimensis* reared at 25°C (■—■) and

## 14.5 ECOLOGY

## 14.5.1 Special adaptations

## (a) Development of walking ability

Adults of Chironomidae are normally strong flyers which swarm in the air, but in the marine species, except for a few primitive groups of *Tanytarsus* and *Thalassosmittia*, the flying ability is degenerated and instead the walking ability is developed. This change from a flying to a walking habit may be advantageous for life on rocky shores which are apt to receive strong sea breezes.

Adults of fully winged genera, *Paraclunio*, *Telmatogeton* and *Thalassomyia* can fly skillfully, but are distinctly inclined to walking or running and mating takes place exclusively on rock surfaces or other solid substrates. While running, the body of *Telmatogeton* is always held close to the ground or substrate. Moreover, the wings do not rest upon one another but face each other with their under surfaces, thus raising the caudal margins (Fig. 14.32a). In this way, the wings never protrude beyond the lateral edges of the abdomen, allowing the legs to move freely in rapid running (Hashimoto, 1962a). The walking style of *Paraclunio* is almost the same as that of *Telmatogeton*. The locomotion of *Thalassomyia* is, however, somewhat different. When at rest or even in running, the body of

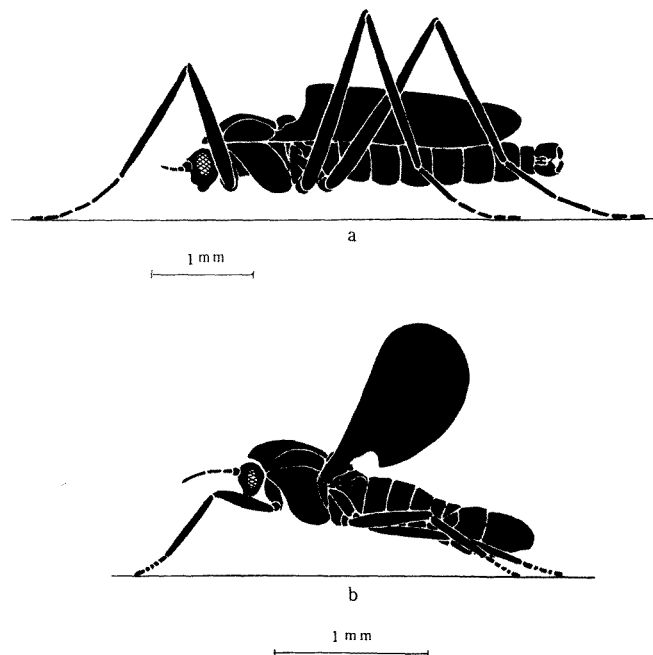

Fig. 14.32. Locomotion styles of *Telmatogeton japonicus* (a) and *Clunio tsushimensis* (b).

*Thalassomyia* is kept aloft by the legs and the wings are often stretched out horizontally at right angles to the body axis. They never flutter their wings which when out-stretched may help in balancing the body in running (Hashimoto, 1964).

The wings of *Psammathomyia*, *Halirytus* and *Eretmoptera* are short and possibly not functional. The halteres are present but also reduced. In *Belgica* the wings are reduced to short finger-like processes, while in *Tethymyia* they are vestigial. In these two genera the halteres are absent. Thus, many genera of marine chironomids are completely flightless. In these walking forms the antennae are very short, consisting of less than 7 segments, and lacking in sensory hairs even in the male, a condition probably correlated to the degeneration of flight (Tokunaga and Yoshimura, 1936). It is of interest to note that the degree of degeneration of external organs in walking midges is more or less uniform between males and females.

The mode of specialization in the sexually dimorphic *Clunio* is different from that of walking genera. The wings of the male are rather round and markedly petiolated, and are kept fluttering throughout its short adult life. This incessant vibration of the wings prevents free motion of the mid and hind legs. In forward movement on the ground, only the front legs are used and the male always drags the posterior legs behind (Fig. 14.32b). The body of the male is thus always lifted obliquely by the forelegs at an angle of  $20^\circ$  from the substratum. The main driving force of this fly is caused by the vigorous fluttering motion of the wings and not the motion of the forelegs, which only assist in its locomotion. This arrangement hinders rapid motion on solid substrate, but on a water film it becomes very efficient. The wings act like the propellers of an aeroplane, and the thoracic legs act as balancing organs. The very short tarsi, relatively enlarged empodia with dense hairs, and the retractable claws are all modifications for skating on the water surface (Oka, 1930).

In spite of its vigorous wing motion, the male of *Clunio* is incapable of normal flight. It does not fly in a straight line even for a short distance, but flies about at random from one spot to another in a series of small arcs at an altitude of not more than 30 cm. In nature such anomalous flight is frequently seen when the insects dodge from sudden impediments or dashing waves. In the highly specialized species, *Clunio takahashii* and *C. purpureus*, the males use such sporadic flight in search of the females which are often hidden in areas splashed continuously by waves (Hashimoto, 1965).

The females of *Clunio* lack wings and halteres. The antennae and palpi are also quite degenerate. The legs are reduced so as to make walking impossible. Such extreme degeneration of the female is characteristic of the genus *Clunio*, and may be correlated to the development of the gliding ability of the male (Hashimoto, 1962).

The genus *Pontomyia* was first reported as a submarine insect which lives underwater throughout its life (Buxton, 1926), but this was refuted by later investigators (Tokunaga, 1932; Womersley, 1937). The male of *Pontomyia* is highly specialized as a water-surface skater. The wings, which fan the air close to the water surface, propel the insect. The legs are quite useless for walking but are very well adapted for skating on the water film. The long forelegs are not in contact with the water surface and the body is supported by the mid and hind legs (Tokunaga, 1932). The extremely short and stout middle legs allow the wings to move continuously and freely. In addition, the fifth tarsal segments of the hind legs are boot-shaped and without distinct claws, thus providing effective support for rapid gliding on the water film.

The female of *Pontomyia* (Fig. 14.33) is almost vermiform, without any locomotory organs, and wriggles on the water surface until it is caught by a male. As in *Clunio*, it can only be transported by the male during the mating trip.

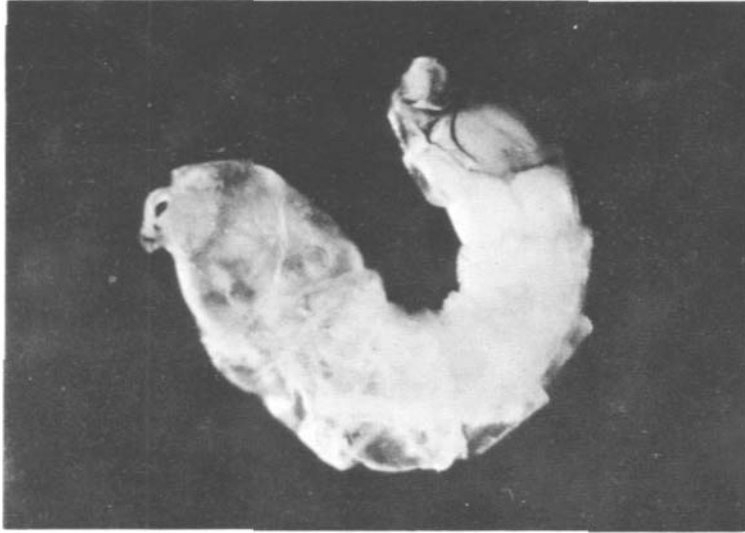

Fig. 14.33. *Pontomyia cottoni*, female.

Among the marine chironomids, only two genera, *Clunio* and *Pontomyia*, are capable of moving on the water surface; they possess remarkable sexual dimorphism in contrast to the sexually isomorphic walking genera. The development of gliding ability is thought to be a pre-adaptation for advancing to the open sea. Indeed, only *Pontomyia natans* and the Baltic Sea population of *Clunio marinus* are found in open water.

Because of their very short adult life, marine chironomids must complete their reproduction during the period of the ebb-tide. The appearance of adults is therefore affected by diurnal, fortnightly and sometimes annual changes of the tide. Particularly in lower tide-zone dwellers, e.g. *Clunio*, emergence is highly synchronized with the lowest spring tide. The emergence rhythm of *Clunio*, however, varies from place to place in relation to local variations in tides. The emergence of *C. marinus* in Helgoland has been studied in detail by Caspers (1951). During each emergence period, the adults emerge once daily, at the night ebb-tide. The emergence period of *C. tsushimensis* in Japan also corresponds to the spring tide, but the diurnal emergence time changes with the seasonal variations in the height of the tide (Fig. 14.34). The lowest tide in the Pacific coast of Japan occurs in the forenoon during the period June to September but at night during the period December to February. Thus, *C. tsushimensis* emerges only in the

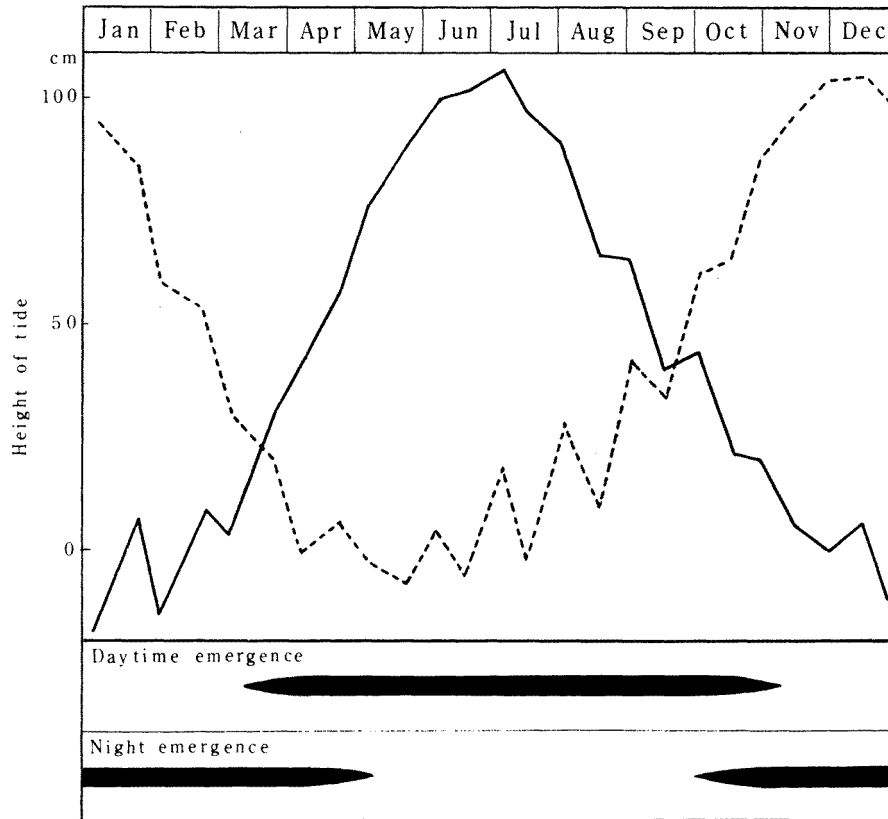

Fig. 14.34. Diurnal emergence of *Clunio tsushimensis* in relation to day (—) and night (---) ebb tides at Shimoda, Japan.

morning in summer and only at night in winter. During the transitional period from March to May and October to November, when differences between the two low tides become rather small, emergence occurs twice a day, in the morning and at night (Oka and Hashimoto, 1959).

The mechanism of periodical emergence of *C. marinus* was elucidated by a series of experimental studies carried out by Neumann (1965, 1966, 1967, 1968, 1971). According to him, *Clunio* has two physiological time clocks. The first is used for setting the time of pupation and uses moonlight for its synchronizing agent. The second determines the time of eclosion of the adult, and here the day–night cycle is the synchronizing agent. The combination of both systems permit reliable advance programming of insect development, leading to synchronization with extreme low spring tides which recur every 15 days at the same time of the day.

On the other hand, non-periodical emergence is known in *Clunio takahashii*, which is found in the southern parts of Japan. This species is strictly limited to a very narrow littoral zone, at mid-level of the tidal zone and emergence occurs whenever the habitat is exposed at ebb-tide (Hashimoto, 1965). Such conditions occur twice a day but only for a short period of about 30 minutes, just midway between the flood-tide and the ebb-tide, regardless of the tidal range. This species thus emerges twice a day, about three hours before each ebb-tide throughout the year on the island of Amami-Oshima, Japan (Fig. 14.35). A similar emergence pattern is found in the Arctic population of *Clunio marinus* in Tromsø, Norway (Neumann and Honegger, 1965). The mechanism of control of tidal rhythm of emergence has been analysed by Pflüger and Neumann (1971) and Pflüger (1973).

Several exceptional cases on the emergence pattern of *Clunio* have been reported. In Tvärminne, Finland, *C. marinus* is an open sea dweller; diurnal emergence occurs between midnight and morning (Palmén and Lindeberg, 1959). The peak of emergence of the same species at Bergen, Norway, occurs during ebb-tide of the neap tide but not the spring tide (Koskinen, 1968). Along the coast of the Black Sea, tidal influence is almost negligible but the habitat of *Clunio* is regularly exposed in the morning by the slight fall of the water surface caused by offshore winds. Diurnal emergence of *Clunio* occurs in the early morning, corresponding to this exposed condition of the habitat (Caspers, 1951).

#### 14.5.2 Habitat requirements

In general, marine chironomids are found on rocky shores, coral reefs and in a few cases in the muddy bottom. Most of them are associated with definite dominant algal species: *Telmatogeton sancti-pauli* and *T. minor* with *Porphyra* (Hesse, 1934); *T. japonicus* with *Enteromorpha*, *Ulva* and *Monostroma* (Tokunaga, 1935; Wirth, 1947b); *T. pacificus* with *Endocladia*, *Nemalion*, *Monostroma* (Tokunaga, 1933) and *Ectocarpus* (Williams, 1944); *Pontomyia natans* and certain *Tanytarsus* species in Samoa are mainly found among the leaves of *Halophila* (Buxton, 1926);

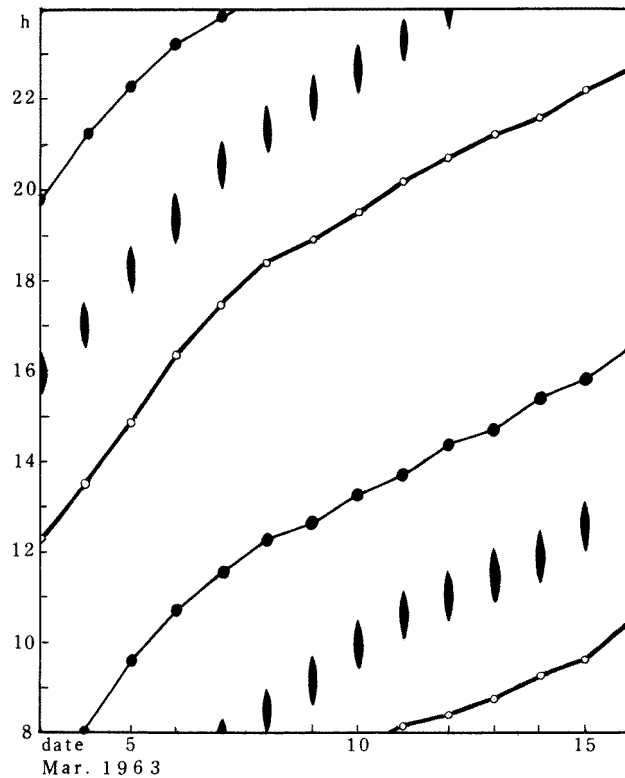

Fig. 14.35. Diurnal emergence time of *Clunio takahashii* in relation to tidal rhythm at Nase, Amami-Oshima, Japan. ●—●, low tide; ○—○, high tide.

and larvae of *Pontomyia pacifica* often occur in *Boodlea* (Tokunaga, 1932). *Clunio tsushimensis* and *C. purpureus* sometimes occur in the same area, but their host algae are quite distinct: *C. tsushimensis* prefers *Hypnea* while *C. purpureus* prefers *Gelidium divaricatum* (Hashimoto, 1962b). On the other hand, *Paraclunio alaskensis* may be found in almost any matted growth of filamentous algae (Saunders, 1928). Cheeseman and Preissler (1972) reported that *P. alaskensis* larvae are abundant in the area of sewage outfall, where food in the form of organic slime is plentiful on boulders and rocky vertical outcrops.

The distribution of marine chironomids in a given area is determined largely by topographic conditions of the tidal zone. The primitive genera, *Thalassosmittia* and *Tanytarsus*, occur almost always at the high-tide mark; *Thalassomyia*, *Telmatogeton* and *Paraclunio* are mainly distributed from the highest level to the mid-tide level; *Psammathiomyia* occurs at the low tide mark (Brown, 1947);



most members of *Clunio* live in the lower zones, at least below the mid-tide level, but *C. takahashii* and *C. purpureus* are limited to the vertical verge or the steep slant of rocky cliffs near the middle of the tidal zone (Hashimoto, 1965); the Baltic *C. marinus* is found in the open sea, the larvae living on the bottom at a depth of 4–10 m or sometimes 20 m of water (Remmert, 1955; Palmén and Lindeberg, 1959; Olander and Palmén, 1968); *Pontomyia natans* may also be found in the open sea, below the lowest level of the intertidal zone, but *P. pacifica* lives only in the tidepools near the high-water mark, often associated with *Tanytarsus* (Tokunaga, 1932).

Generally, true marine chironomids are not found in brackish water, but *C. marinus* in the Baltic Sea is normally found in water where the salinity is less than 10‰. According to Olander and Palmén (1968), the lower limit of salinity tolerated by the larvae of *C. marinus* is 4‰. A most unusual occurrence of *Clunio* was described by Stone and Wirth (1947) who found *C. vagans* males with wingless females attached in copula around the spray-drenched and ripple-washed boulders in a rapid at Wailua Falls, Kauai, Hawaii. The falls are located about 4 miles from the sea, the lower 3 miles consisting of a rather broad sluggish tidal stream, while the upper mile below the falls forms a rapid with a drop of about 50 feet. The immature stages were, however, not found.

### 14.5.3 Distribution

The marine *Tanytarsus* and its related genus *Pontomyia* are found only in the eastern hemisphere. *Pontomyia* was first believed to be tropical, but in fact extends to the temperate zone. The northernmost record of *Pontomyia* is Hokkaido, Japan (Hashimoto, 1959) and the southernmost is South Australia (Womersley, 1937). Marine members of *Tanytarsus* are so far unknown outside the Pacific tropical and temperate zones (Edwards, 1926; Tokunaga, 1934, 1936, 1964). *Telmatogeton* and *Thalassomyia* are found in both eastern and western hemispheres but the latter is more restricted to the warmer seas (Wirth, 1947a,b). Among the species, *Telmatogeton japonicus* is most widely distributed and has been recorded from Hawaii (Wirth, 1947b), Florida (Beck and Beck, 1959), South Australia (Freeman, 1961) and Japan (Tokunaga, 1933). The distribution of *Paraclunio* is of interest, as all known species are found only on the Pacific coasts of North America (Coquillett, 1900; Kieffer, 1911; Saunders, 1928; Hashimoto, 1973a).

The wingless or brachypterous genera, *Belgica*, *Tethymia*, *Eretmoptera*, *Psammathiomyia* and *Halirytus*, with very few species each, are extremely localized in distribution. The presence of *Belgica antarctica* in the Antarctic Peninsula (Wirth and Gressitt, 1967) extends the southernmost record of free-living holometabolous insects. Another Antarctic genus, *Halirytus*, includes three species: *H. magellanica* from the Straits of Magellan, Chile (Jacobs, 1900); *H. amphibius*

from Kerguelen Island (Enderlein, 1909); and *H. macquariensis* from Macquarie Island, New Zealand (Brundin, 1962).

*Clunio*, with 18 marine species, is the most widely distributed genus, all but one species are found in the Pacific. *C. marinus*, the only species found in Europe, may be composed of many races or populations. The northernmost limit recorded for this genus is Tromsø, Norway (*C. marinus*; Remmert, 1965; Neumann and Honegger, 1969) and the southernmost is Victoria, Australia (*C. martini*; Hashimoto, 1973b).

[

Since completion of this chapter three new species of marine chironomids (*Telmatogeton mortoni* (Leader), *Smittia reinga* (Leader) and *Smittia whangaroa* (Leader)) have been described from New Zealand (Leader, 1975). Also, recent evidence from banding patterns of salivary gland chromosomes of *Telmatogeton* suggests that in Hawaii some form close to *T. japonicus* ( $n = 7$ ) may have given rise not only to other marine species such as *T. pacificus* ( $n = 4$ ) but also to freshwater species such as *T. torrenticola* (Terry) ( $n = 7$ ); the chromosome patterns of *Paraclunio* species indicate that this genus was probably derived from some ancestral *Telmatogeton*-like midge. The chromosomes of *P. trilobatus* ( $n = 5$ ) are remarkably similar to the postulated 'standard' *Telmatogeton* type but those of *P. alaskensis* ( $n = 5$ ) appear to be quite different (L.J. Newman, personal communication). Ed.]

## REFERENCES

- Beck, E.C. and Beck, W.M. Jr. (1959) A checklist of the Chironomidae (Insecta) of Florida (Diptera: Chironomidae). Bull. Fla. St. Mus. 4 (30) 85–96.
- Brown, D.S. (1947) *Psammathomyia pectinata* Deby (Chironomidae) and other Nematoceros Diptera in Cornwall in 1946. Entomol. Mon. Mag. 83, 81–82.
- Brundin, L. (1962) Insects of Macquarie Island. Diptera: Chironomidae. Pac. Insects 4 (4) 945–954.
- Buxton, P.A. (1926) The colonization of the sea by insects: with an account of the habits of *Pontomyia*, the only known submarine insect. Proc. Zool. Soc. Lond. 51, 807–814.
- Caspers, H. (1951) Rhythmische Erscheinungen in der Fortpflanzung von *Clunio* (Dipt. Chironom.) und das Problem der Lunaren Periodizität bei Organismen. Arch. Hydrobiol. Suppl. 18, 415–594.
- Cheeseman, D.T., Jr. and Preissler, P. (1972) Larval distribution of *Paraclunio alaskensis* at Point Pinos sewage outfall, Monterey County, California (Diptera: Chironomidae). Pan-Pac. Entomol. 48, 204–297.
- Cheverel, R. (1894) Sur un Diptère marin du genre *Clunio* Haliday. Arch. Zool. Exp. Ser. 28, 583–598.
- Coquillett, D.W. (1900) Papers from the Alaska Expedition. Entomological results (3) Diptera. Proc. Wash. Acad. Sci. 2, 389–464.
- Dordel, H.J. (1971) The process of copulation in the marine chironomid *Clunio marinus* (Diptera). Can. Entomol. 103, 404–406.
- Dordel, H.J. (1973) Funktionsanatomische Untersuchungen über die Abdomentorsion bei der männlichen Imago Von *Clunio marinus* (Diptera, Chironomidae). Z. Morphol. Tiere 75, 165–221.
- Edwards, F.W. (1926) On marine Chironomidae (Diptera); with descriptions of a new genus and four new species from Samoa. Proc. Zool. Soc. Lond. 15, 779–806.

- Enderlein, G. (1909) Die Insekten des Antarktischen Gebiets. Deutsche Sud-Polar Expedition (1901–1903). × (Zool. II), 364–528.
- Freeman, P. (1961) The Chironomidae (Diptera) of Australia. *Aust. J. Zool.* 9, 611–737.
- Hashimoto, H. (1957) Peculiar mode of emergence in the marine chironomid *Clunio* (Diptera, Chironomidae). *Sci. Rep. Tokyo Kyoiku Daigaku, Section B*, 8, 217–226.
- Hashimoto, H. (1959) Notes on *Pontomyia natans* from Sado (Diptera, Chironomidae). *Ibid.* 9, 57–64.
- Hashimoto, H. (1962a) Ecological significance of the sexual dimorphism in marine chironomids. *Ibid.* 10, 221–252.
- Hashimoto, H. (1962b) A new species of Clunionine chironomid from Japan. *Ibid.* 9, 285–296.
- Hashimoto, H. (1964) Notes on *Thalassomyia japonica* from Ryukyu (Diptera, Chironomidae). *Kontyu* 32, 311–322.
- Hashimoto, H. (1965) Discovery of *Clunio takahashii* Tokunaga from Japan. *Jap. J. Zool.* 14 (3) 13–29.
- Hashimoto, H. (1968) Seasonal variation in the marine chironomid *Clunio tsushimensis* Tokunaga (Diptera). *Ann. Zool. Fenn.* 5, 41–48.
- Hashimoto, H. (1969) Affinity and differentiation of species in the marine chironomids, *Clunio aquilonius* and *C. tsushimensis* (Diptera). *Jap. J. Zool.* 16(1) 19–45.
- Hashimoto, H. (1973a) A new species of the marine chironomid *Paraclunio* (Diptera) from southern California. *Annot. Zool. Japon.* 46, 266–273.
- Hashimoto, H. (1973b) Marine chironomids from Australia, with description of a new species of the genus *Clunio* (Diptera: Chironomidae). *Bull. Fac. Educ. Shizuoka Univ. Nat. Sci. Ser.* 24, 1–17.
- Hashimoto, H. (1974) A new species of Clunionine chironomid from North America. *Entomol. Tidskr.* 95, suppl. 108–114.
- Hashimoto, H. (1975) Seasonal emergence of *Clunio aquilonius* Tokunaga (Diptera: Chironomidae). *Kontyu* 43(1) 52–57.
- Hesse, A.J. (1934) Contributions to a knowledge of South African marine Clunionine-chironomids. *Trans. R. Entomol. Soc. Lond.* 82, 27–40.
- Jacobs, J.C. (1900) Diptera. Diagnoses d'insectes recueillies par l'expédition Antarctique Belge. *Ann. Soc. Entomol. Belgique* 44, 106–107.
- Kieffer, J.J. (1911) Description d'un Chironomide d'Amérique formant un genre nouveau. *Bull. Soc. Hist. Nat. Metz* 27, 103–105.
- Koskinen, R. (1968) Seasonal emergence of *Clunio marinus* Haliday (Dipt., Chironomidae) in Western Norway. *Ann. Zool. Fenn.* 5, 71–75.
- Leader, J.P. (1975) Three new chironomids (Diptera: Chironomidae) from the New Zealand seashore. *N.Z. J. Zool.* 2(2) 209–214.
- Morley, R.L. and Ring, R.A. (1972) The intertidal Chironomidae (Diptera) of British Columbia. II. Life history and population dynamics. *Can. Entomol.* 104, 1099–1121.
- Neumann, D. (1965) Das Geschlechtsverhältnis bei marinen Chironomiden der Gattung *Clunio* Hal (Diptera). *Kiel. Meeresforsch.* 21, 199–202.
- Neumann, D. (1966) Die lunare und die tägliche Schlüpfperiodik der Mücke *Clunio*. Steuerung und Abstimmung auf die Gezeitenperiodik. *Z. Vergl. Physiol.* 53, 1–61.
- Neumann, D. (1967) Genetic adaptation of emergence time of *Clunio* population to different tidal condition. *Helgol. Wiss. Meeresunters.* 15, 163–171.
- Neumann, D. (1968) Die Steuerung einer semilunaren Schlüpfperiodik mit Hilfe eines künstlichen Gezeitenzyklus. *Z. Vergl. Physiol.* 60, 63–78.
- Neumann, D. (1971) The temporal programming of development in the intertidal chironomid *Clunio marinus* (Diptera: Chironomidae). *Can. Entomol.* 103, 315–318.
- Neumann, D. and Honegger, H.W. (1969) Adaptations of the intertidal midge *Clunio* to Arctic conditions. *Oecologia (Berl.)* 3, 1–13.

- Oka, H. (1930) Morphologie und Ökologie von *Clunio pacificus* Edwards. Zool. Jahrb. Abt. Syst. Ökol. Geogr. Tiere 59, 253–280.
- Oka, H. and Hashimoto, H. (1959) Lunare Periodizität in der Fortpflanzung einer pazifischen Art von *Clunio* (Diptera, Chironomidae). Biol. Zentralbl. 78, 545–559.
- Olander, R. and Palmén, E. (1968) Taxonomy and ecology of the northern Baltic *Clunio marinus* Halid. Ann. Zool. Fenn. 5, 97–110.
- Palmén, E. and Lindeberg, B. (1959) The marine midge, *Clunio marinus* Hal. (Diptera, Chironomidae), found in brackish water in the northern Baltic. Int. Rev. Hydrobiol. 44, 383–393.
- Pflüger, W. (1973) Die Sanduhrsteuerung der gezeiteinsynchronen Schlüpfrythmik der Mücke *Clunio marinus* im arktischen Mitsommer. Oecologia (Berl.) 11, 113–150.
- Pflüger, W. and Neumann, D. (1971) Die Steuerung einer gezeitenparallelen Schlüpfrythmik nach dem Sanduhrprinzip. Oecologia (Berl.) 7, 262–266.
- Remmert, H. (1955) Ökologische Untersuchungen über die Dipteren der Nord- und Ostsee. Arch. Hydrobiol. 51, 1–53.
- Saunders, C. (1928) Some marine insects of the Pacific coast of Canada. Ann. Entomol. Soc. Am. 21, 521–545.
- Stone, A. and Wirth, W.W. (1947) On the marine midges of the genus *Clunio* Haliday (Diptera, Tendipedidae). Proc. Entomol. Soc. Wash. 49, 201–224.
- Strenzke, K. (1960) Metamorphose und Verwandtschaftsbeziehung der Gattung *Clunio* Hal. (Dipt.) Ann. Zool. Soc. Zool. Bot. Fenn. 'Vanamo', 22(4) 1–30.
- Strenzke, K. and Remmert, H. (1957) Terrestrische Chironomiden XVII. *Thalassosmittia thalassophila* (Bequ. u. Goetgh.). Kiel. Meeresforsch. 13, 263–274.
- Tokunaga, M. (1931) Feeding habit of a dragon-fly *Pantala flavescens* and its ecological meaning. Trans. Kansai Entomol. Soc. 2, 56–58. (In Japanese.)
- Tokunaga, M. (1932) Morphological and biological studies on a new chironomid fly, *Pontomyia pacifica*, from Japan. Mem. Coll. Agric. Kyoto Imp. Univ. 19, 1–56.
- Tokunaga, M. (1933) Chironomidae from Japan I. Clunioninae. Philipp. J. Sci. 51(1) 87–99.
- Tokunaga, M. (1934) Chironomidae from Japan II. Marine *Tanytarsus*. Philipp. J. Sci. 51(3) 357–367.
- Tokunaga, M. (1935) Chironomidae from Japan IV. On the early stages of a marine midge *Telmatogeton japonicus* Tokunaga. Philipp. J. Sci. 57, 491–511.
- Tokunaga, M. (1936) Chironomidae from Japan VIII. Marine or seashore *Spaniotoma*, with descriptions of the immature forms of *Spaniotoma nemalione* sp. nov. and *Tanytarsus boodleeae* Tokunaga. Philipp. J. Sci. 60(3) 303–321.
- Tokunaga, M. (1964) Diptera: Chironomidae. Insects of Micronesia 12, 485–628.
- Tokunaga, M. and Yoshimura, Y. (1936) On the reduction of the antennae of a marine insect, *Telmatogeton pacificus* Tokunaga. Dobutsugaku Zasshi, 48, 222–224. (In Japanese.)
- Williams, F.X. (1944) Biological studies in Hawaiian water-loving insects, Part III. Diptera or Flies. D. Culicidae, Chironomidae, and Ceratopogonidae. Proc. Hawaii Entomol. Soc. 12, 149–180.
- Wirth, W.W. (1947a) Notes on the genus *Thalassomyia* Shiner, with descriptions of two new species (Diptera: Tendipedidae). Proc. Hawaii Entomol. Soc. 13, 117–139.
- Wirth, W.W. (1947b) A review of the genus *Telmatogeton* Shiner, with descriptions of three new Hawaiian species (Diptera: Tendipedidae). Ibid. 13, 143–191.
- Wirth, W.W. (1949) A revision of the Clunionine midges with descriptions of a new genus and four new species (Diptera: Tendipedidae). Univ. California Publ. Entomol. 8, 151–182.
- Wirth, W.W. and Gressitt, J.L. (1967) Diptera: Chironomidae (midges). Antarctic Res. Ser. 10, 187–203.
- Womersley, H. (1937) A new marine Chironomid from South Australia. Trans. R. Soc. South Aust. 61, 102–103.

## Coastal horse flies and deer flies (Diptera: Tabanidae)

Richard C. Axtell

<b>Contents</b>		
15.1	Introduction	415
15.2	Morphology and anatomy	416
	15.2.1 General diagnostic characteristics	416
15.3	Systematics	422
15.4	Biology	424
	15.4.1 General life history	424
	15.4.2 Life histories of saltmarsh species	425
	15.4.3 Seasonality	429
	15.4.4 Food	429
	15.4.5 Parasites and predators	430
15.5	Ecology and behaviour	431
	15.5.1 Sampling methods	431
	15.5.2 Larval distribution in marshes	432
	15.5.3 Adult movement and dispersal	433
	15.5.4 Role of tabanids in marsh ecosystems	434
15.6	Economic importance	434
15.7	Control	435
	15.7.1 Larval control	435
	15.7.2 Adult control	435
References		436

### 15.1 INTRODUCTION

Members of the family Tabanidae are commonly called horse flies and deer flies. In the western hemisphere, horse flies are also called greenheads (especially in coastal areas). The majority of the species of horse flies are in the genus *Tabanus*; the majority of the deer flies in *Chrysops*.

The tabanids include several more or less 'marine' insects since many species are found in coastal areas. Some species develop in the soil in saltmarshes, brackish pools and tidal overwash areas. A few species are found along beaches and seem to be associated with vegetative debris accumulating there. The majority of the tabanid species, however, develop in a variety of upland situations ranging from very wet to semi-dry (tree holes, rotting logs, margins of ponds, streams, swamps and drainage ditches).

Most tabanids are large, robust, strong fliers, vicious biters of man and animals, and, therefore, of economic importance. Their annoyance interferes with human activities and livestock culture. Disease transmission by tabanids occurs, frequently by mechanical means (with no development of the pathogen or parasite in the insect). It is likely that tabanids, along with other insects, are important in saltmarsh ecosystems but little is known on the subject. In this chapter only a brief synopsis of the family is given with further discussions confined to saltmarsh species of North America.

## 15.2 MORPHOLOGY AND ANATOMY

### *15.2.1 General diagnostic characteristics*

The adults of the family Tabanidae are characterized by their large robust body (6–25 mm long). The deer flies are relatively slender and usually have patterned wings and mixed body colours of brown, yellow, orange and black. A typical coastal deer fly (*Chrysops atlanticus* Pechuman) is shown in Fig. 15.1. Horse flies (or greenhead flies) are usually more robust with clear or slightly shaded wings and some colouration on the body. A typical horse fly (*Tabanus nigrovittatus* Macquart) of saltmarshes is shown in Fig. 15.2. All tabanids have large compound eyes (Fig. 15.3) which are widely separated in the females, close together in the males and are more prominent (and often have colour bands) in the horse flies (Tabaninae) than in the other subfamilies. Between the eyes are various shaped areas (often protruding) referred to as the frontal calluses (basal and median). The mouthparts may be reduced in some groups or modified for feeding on plant nectar. Most female tabanids, however, have the mouthparts well developed for blood feeding and have stout maxillae and blade-like mandibles (Fig. 15.4). The males feed on nectar and their mouthparts are not capable of cutting the skin of a host. The antennae are distinctly 3-segmented with annulations (false segmentation) on the terminal segment (flagellum) (Fig. 15.5). The wing venation is characteristic with branches of vein  $R_4 + 5$  diverging broadly so that they enclose the apex of the wing (2nd submarginal cell, cell  $R_4$ ) (Fig. 15.6 and 15.7).

The larvae (Fig. 15.8) and pupae (Fig. 15.9) of tabanids are usually various shades of brown and found in moist soil. For further detailed descriptions of the

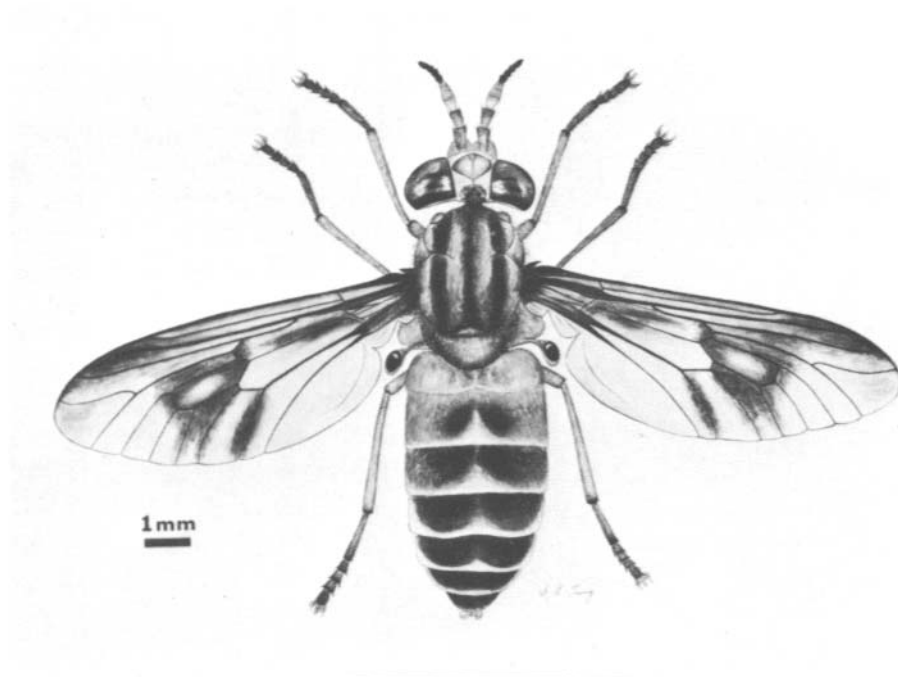

Fig. 15.1. A typical female deer fly, *Chrysops atlanticus* (Pechuman) (original drawing by S.L. Tung).

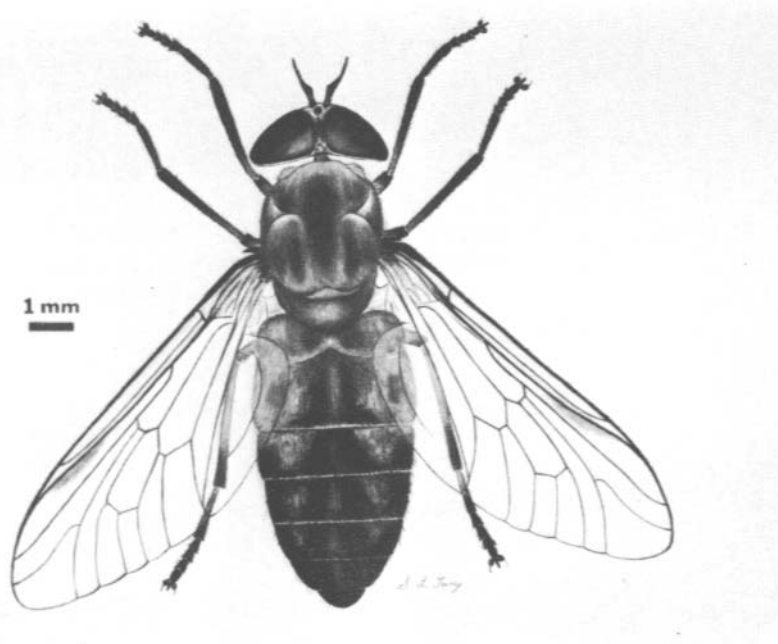
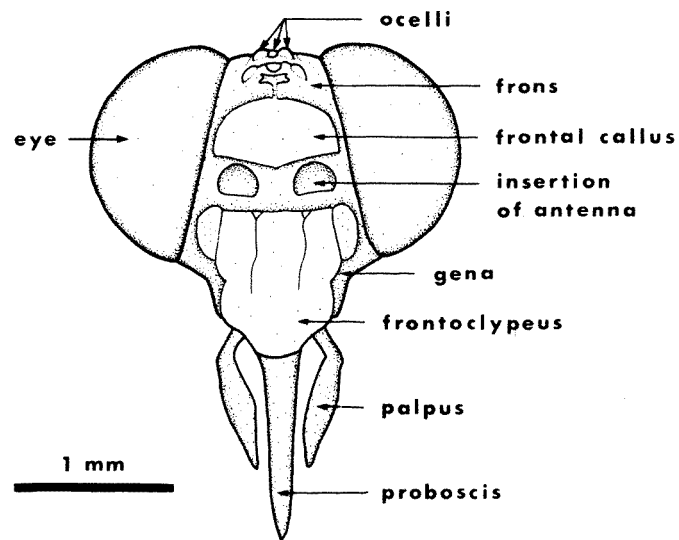
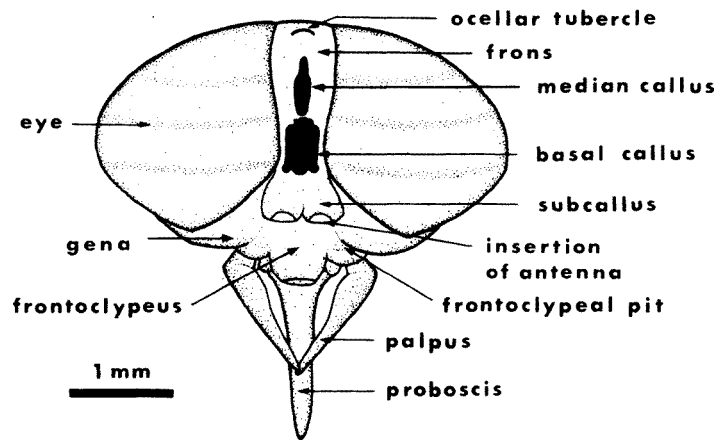

Fig. 15.2. A typical female horse fly (greenhead), *Tabanus nigrovittatus* (Macquart) (original drawing by S.L. Tung).



### CHRYSOPS



### TABANUS

Fig. 15.3. Diagram of the head of a typical female deer fly (*Chrysops*) and of a typical female horse fly (*Tabanus*) showing locations and names of structures used in descriptions.



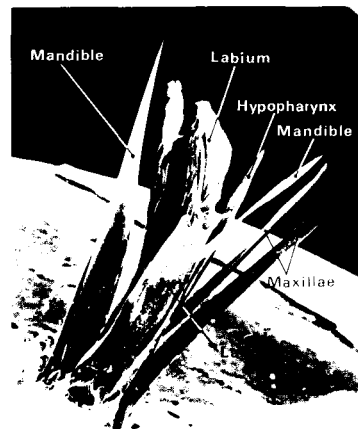
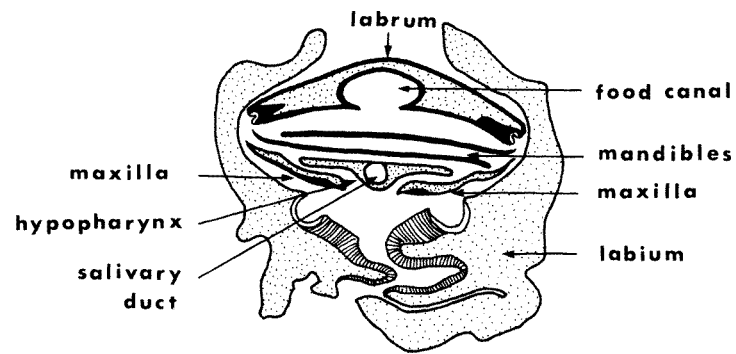

Fig. 15.4. (Above) Diagram of a cross-section of the mouthparts of a horse fly (*Tabanus*). (Below) SEM print of same.

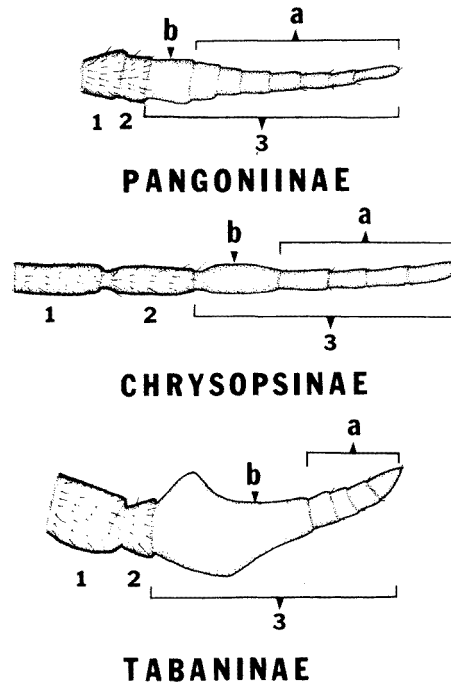

Fig. 15.5. Diagram of the shapes of the antennae in the subfamilies of Tabanidae. 1,2,3 = segments; a = annuli; b = basal portion.

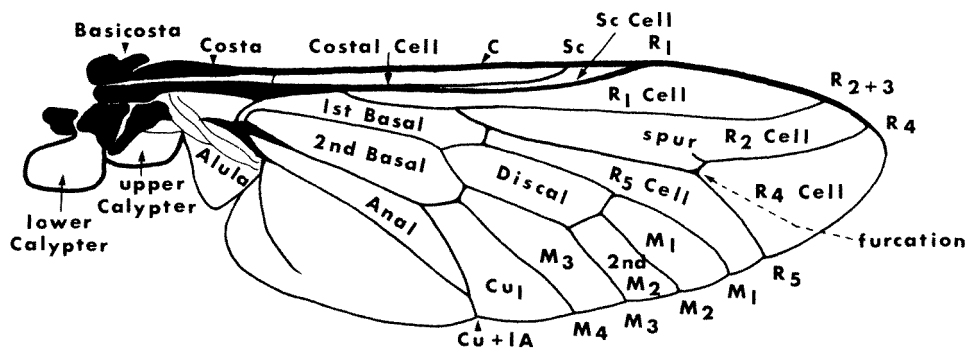

Fig. 15.6. Diagram of the wing of *Tabanus* showing names of veins, cells and basal parts. Veins are as follows: C = costa; Sc = subcosta; R = radius ( $R_1$ ,  $R_{2+3}$ ,  $R_4$ ,  $R_5$ ); M = media ( $M_1$ ,  $M_2$ ,  $M_3$ ); Cu = cubitus ( $Cu_1$ ); A = anal. Other names used by some workers for the veins are:  $R_1$  = 1st longitudinal vein;  $R_{2+3}$  = 2nd longitudinal vein;  $R_4$  = 3rd longitudinal vein (upper branch) and  $R_5$  = 3rd longitudinal vein (lower branch). The cells are named after the vein forming the anterior margin of the cell and labelled within the cells. Other names often used are  $R_1$  cell = marginal cell;  $R_2$  cell = last submarginal cell;  $R_5$  cell = 1st posterior cell;  $M_1$  cell = 2nd posterior cell; 1st  $M_2$  cell = discal cell; 2nd  $M_1$  cell = 3rd posterior cell;  $M_3$  cell = 4th posterior cell;  $Cu_1$  cell = 5th posterior cell; 1st basal cell = radial cell; 2nd basal cell = 2nd medial cell.

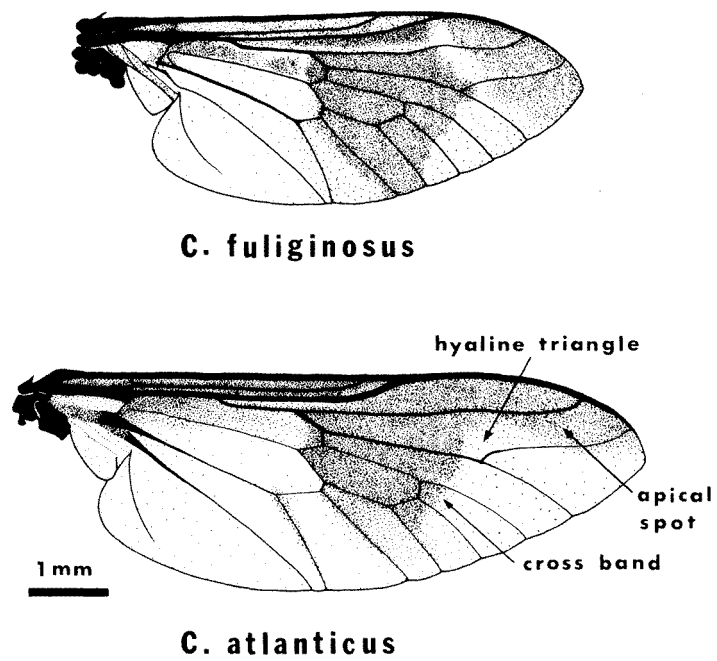

Fig. 15.7. Diagram of the wings of the saltmarsh deer flies *Chrysops fuliginosus* (Wiedemann) and *Chrysops atlanticus* (Pechuman) showing patterns of shading.

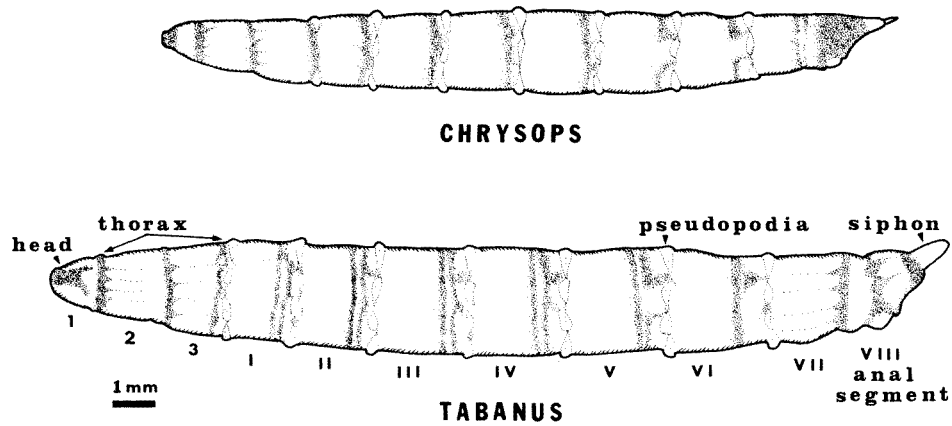

Fig. 15.8. Diagram of a typical larvae of a deer fly (*Chrysops*) and a horse fly (*Tabanus*) showing thoracic segments (1–3) and abdominal segments (I–VIII). Note the shape and characteristics of the siphon on the anal segment which aid in distinguishing between the two types of larvae.

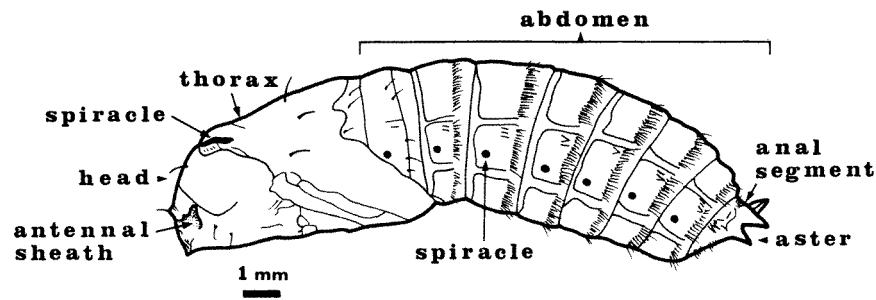

Fig. 15.9. Diagram of a pupa of Tabanidae.

internal and external morphology of the larvae and pupae refer to Teskey (1969) as well as the more specific works by Cameron (1934), El-Ziady and Hefnawy (1970) and Stammer (1924). Bonhag (1951) provides descriptions of the skeleto-muscular systems of the adult stage.

### 15.3 SYSTEMATICS

There are at least 3500 species and more than 100 subspecies of Tabanidae recognized throughout the world (Fairchild, 1969a). These are grouped in 121 genera and 77 subgenera. The center of distribution of the recent species is considered to be in the tropics where most of the species occur.

The Family Tabanidae is generally divided into 3 subfamilies, Pangoniini, Chrysopsinae and Tabaninae, based mainly on the work of Mackerras (1954, 1955a, b) and his analysis of the genitalia (Philip, 1957). Each of these is divided into tribes.

**Subfamily Pangoniinae:** This is the most primitive and the adults are characterized as follows: Antennae short, tapering to a fine point, flagellum with 6–8 subsegments (basal one is largest) (Fig. 15.5); ocelli usually well developed; hind tibia nearly always with paired apical spurs.

**Subfamily Chrysopsinae:** Adults are characterized as follows: Antennae short or long and not subulate with 2nd antennal segment (pedicel) nearly as long as the first (scape) and flagellum of 3rd segment with usually 4 or fewer subsegments marked by faint annulations (Fig. 15.5); ocelli well developed; frontal callus well developed; hind tibia with paired apical spurs.

**Subfamily Tabaninae:** Adults are characterized as follows: Antennae sometimes similar to the Chrysopsinae but usually with shorter flagellum with very faint

annulations (3 or 4) and often a dorsal lobe or projection is present on the basal part of the 3rd segment (Fig. 15.5); ocelli usually absent or very poorly developed; frontal calli well developed, hind tibia never with apical spurs.

These subfamilies and tribes are further characterized by other anatomical characters which are not practical for use in routine identifications, but they provide valuable insight into the phylogeny and evolution of the Tabanidae (Philip and Coscoran, 1971; Terteryan, 1973).

The various tribes are listed in Table 15.1. Only genera with marine species are discussed.

Table 15.1 List of coastal and saltmarsh Tabanidae.

---



---

Subfamily Pangoniinae - 4 tribes.

Tribe Pangoniini - 13 major genera. There are no Ethiopian and Oriental genera. These are primitive Tabanidae which do not suck blood. Adults of many species have been collected in coastal areas but the larval habitats are mostly unknown.

Tribe Scionini - 6 major genera, no known marine species.

Tribe Philolochini - 1 major genus, no known marine species.

Tribe Sepsidini - 3 major genera. *Sepsis* Walker, collected mostly in Brazil, usually along white sand beaches; *Adersia* Austen and *Braunsiomyia* Bequaert, collected mostly in South Africa and often from seaweed on the beach. All have reduced mouthparts and are probably non-biting.

Subfamily Chrysopsinae - 3 tribes.

Tribe Bouvieromyiini - 4 major genera, no known marine species.

Tribe Chrysopsini - 2 major genera. *Chrysops* Meigen (worldwide) and *Silvius* Meigen (Palearctic, Nearctic, Oriental). *Chrysops* is a large important genera with more than 270 species and many subspecies and forms. Fairchild (1971) lists 68 species for the Americas south of the United States and Philip (1965) lists 75 species for America north of Mexico. Although studies are limited, many species are associated with coastal habitats with some either known to be or suspected of breeding in the marshes. *C. fuliginosus* Wiedemann and *C. atlanticus* Pechuman, are major coastal species of North America. *C. italialis* Meigen is a common coastal species of southern Europe.

Tribe Rhinomyzini - 4 major genera, no known marine species.

Subfamily Tabaninae - 3 tribes.

Tribe Diachlorini - There are a very large number of genera and species with the majority found in the Neotropical region. Some species of *Diachlorus* Osten Sacken are found in coastal habitats perhaps associated with marshes. Some species of *Stenotabanus* Lutz are coastal and adapted for living in beach environments. *Chlorotabanus* Lutz includes some pale yellowgreen forms often found in coastal environments.

Tribe Haematopotini - 2 major genera, no known marine species.

Tribe Tabanini - 8 major genera. The genus *Tabanus* Linnaeus is worldwide, with 94 species in North America north of Mexico, 139 species in Americas south of the U.S. and 49 species in Europe. *Tabanus nigrovittatus* Macquart and *T. lineola* Fabricius are the common salt marsh horse flies or greenheads of North America. *Hybomitra* Enderlein includes species often found in coastal environments.

---

It is not practical to present a key to marine genera or species due to the limited information available on the habitats of the immature stages of most species. In eastern North America adults of as many as 40 or more species may be collected in a particular coastal area, but many have immature stages in upland sites (freshwater pools, stream beds, swamps, etc.) (Thompson, 1970, 1971b, 1972). Only few species are known to have larval stages in coastal marshes or brackish coastal waters.

The species which are most frequently encountered as adults and also breed in coastal saltmarshes of North America are *Tabanus nigrovittatus* (Macquart), *T. lineola* (Fabricius), *Chrysops fuliginosus* (Wiedemann) and *C. atlanticus* (Pechuman) (Bailey, 1947; Hansens, 1952; Jamnback and Wall, 1959; Rockel and Hansens, 1970a, b; Thompson, 1973; Axtell, 1974; Dukes et al., 1974a, b). *T. nigrovittatus* and *T. quinquevittatus* Wiedemann form a complex with five other closely related species whose members have often been misidentified (Thompson and Pechuman, 1970; Matthyse et al., 1974). *T. quinquevittatus* is sometimes collected in coastal areas but is not considered to be a saltmarsh breeder. Other species whose larvae have been occasionally found in saltmarshes or nearby brackish pools are listed by MacCreary (1940), Teskey (1969) and Tidwell (1973). Adults of a variety of other species are also often collected in small numbers in traps in or near saltmarshes.

For further and more detailed taxonomic information the reader should refer to recent catalogs of the Tabanidae with extensive literature references on species descriptions by Fairchild (1971) and Philip (1965, 1966). For larval and pupal stages, there exist several major publications which provide further information on morphology, keys to genera and species, and extensive literature references: (Hennig, 1952; Teskey, 1969; Goodwin, 1972, 1973a,b,c; Tidwell and Tidwell, 1973; Goodwin and Murdock, 1974; Tidwell, 1973). Regional publications which contain extensive literature references, illustrations and descriptions of adults are: (Oldroyd, 1952, 1954, 1957, 1969; Philip, 1954, 1955; Mackerras, 1956a,b, 1971, 1972; LeClercq, 1960, 1967; Takahasi, 1962; Fairchild, 1969b; Olsufjev, 1969a,b; Chvála et al., 1972; Carrasco, 1972; Pino et al., 1973; Pernot-Visentin and Beaucournu-Saguez, 1974). Other publications cover biology and adult identifications for Tabanidae of the Atlantic and Gulf coast regions of North America (MacCreary, 1940; Jamnback and Wall, 1959; Jones and Anthony, 1964; Thompson, 1967, 1971a; Pechuman, 1972, 1973; Tidwell, 1973; Ezell et al., 1974).

## 15.4 BIOLOGY

### 15.4.1 General life history

All tabanids have the same basic life history (Jones and Anthony, 1964). The adult female lays eggs on vegetation close to moist soil suitable for larval development.

They may be laid on stems or leaves of marsh grasses, emergent vegetation in and around a pond or pool, leaves of trees or shrubs overhanging water and occasionally on stones, sticks and debris (Knudsen and Rees, 1967; Tidwell and Hays, 1971; Foster et al., 1973). The eggs (1–3 mm long) are creamy white when laid but soon darken to shiny or brownish black. They are laid in masses of 100–800 and arranged in a single layer, as in most Chrysopsini, or in several layers (usually two), as in Tabanini. The eggs hatch in a few hours; the first instar larvae enter the wet soil and complete development there. The larvae of most species require high moisture level and survive long periods submerged in water. Larval development includes several molts (usually 6–10) over a long period (several months to two years). The last instar larva migrates to or near the surface of the soil to pupate. The pupal stage may last for a few days or as long as 2–3 weeks depending on the species and the temperature. The adult emerges from the pupal case through a dorsal slit and, after a few hours of drying and hardening, is capable of sustained flight. Generally the males will emerge a little before the females. Mating may take place soon after emergence or later when the opportunity arises (Bailey, 1948a; Blickle, 1959; Catts and Olkowski, 1972). The diploid chromosome number ranges from 8 to 18 (Boyes and Wilkes, 1972).

In many species a blood-meal is needed for development of each batch of eggs and a female may lay two or three batches of eggs in a lifetime. However, several species have been shown to be autogenous, capable of producing an initial batch of eggs without a blood-meal (Rockel, 1969a; Anderson, 1971; Watanabe and Kamimura, 1971a; Thomas, 1972, 1973; Boseler and Hansens, 1974). Autogenous species apparently emerge in the marsh, remain there to mate and lay a single batch of eggs. They will then seek a vertebrate host for a blood-meal and return to the marsh to lay a second batch of eggs.

Generally, different species of tabanids emerge in discrete periods of the year, often with a single peak of abundance. In temperate regions, they overwinter in the larval stage. Owing to the long larval development period, the adults are usually derived from eggs laid a year, or even two years previously.

Data on life histories of tabanids are limited due to the extreme difficulty in maintaining these flies in the laboratory. Large larvae can often be held singly for pupation and adult emergence in vials of natural media or glass beads (Roberts, 1966), but rearing from egg to adult is rare and no laboratory colony has yet been achieved for any species.

#### *15.4.2 Life histories of saltmarsh species*

The four major North American saltmarsh species have been studied extensively but significant gaps still exist in our knowledge of their life histories. This, of course, reflects the difficulties in working these flies.

- a. *Tabanus nigrovittatus* According to Jamnback and Wall (1959) this species deposits an egg mass (7.28 mm long and 3.4 mm wide) on *Spartina alterniflora* Loiseleur (smooth cordgrass) about 30 cm above the marsh sod where the plant blade is 5–6 mm wide; the mass is light brown and made up of two tiers. Individual eggs are 1.8 mm long and 0.38 mm wide at the widest point. Other researchers have had little or no success in finding *T. nigrovittatus* egg masses in the marshes even in the presence of high populations of adults. Consequently, there is considerable uncertainty about where the egg masses are laid and their appearance. Perhaps the egg masses are laid too low on the plants to be easily found, or perhaps they hatch quickly and the mass falls apart quickly. In any case, the larvae apparently hatch in a few hours and drop to the soil where development takes place. The duration of larval development and the number of moults has not been determined, but from the pattern of adult populations and from the yearly peak of large larvae and pupae recovered from soil samples, it apparently takes 9–10 months for the larvae to complete their moults. It is possible that some individuals take longer, even waiting for the second year, to pupate. Larvae are commonly collected from mud in areas of *Spartina* (Dukes et al., 1974a,b). The mature larva is about 24 mm long, pale amber colour with faint light brown rings on the abdomen and dark pattern of the anal segment. The pupa is about 13–18 mm long with head and thorax dark brown and abdomen yellowish brown. The larva and pupa are shown in Fig. 15.10 and described by Teskey (1969).
- b. *Tabanus lineola* Unlike the other three major saltmarsh species, the larval stage of this species is found in freshwater as well as in the saltmarshes. The adults of the freshwater forms tend to be darker than the yellowish saltmarsh forms (Teskey, 1969). The biology of the saltmarsh form has been described by Orminati and Hansens (1974) who found the eggs mainly on the tips of the blades of *Spartina alterniflora* and occasionally on another salt grass, *Distichlis spicata* (L.) Greene. The two-tiered egg masses (Fig. 15.11) are long and narrow (14–15 mm long and 1–2 mm wide), and contain an average of 208 eggs (27–416). Each egg is 1.5–1.7 mm long, 0.25 mm wide and dark grey when a few hours old. The eggs hatch in 4–5 days and the first-instar larvae drop, often in groups, to the soil surface. In the laboratory, larvae developed through 8–10 instars, taking about 200 days before pupating. Males on the average undergo one fewer moult than females. The pupal stage lasts 7–16 days. Development in the field may take a longer time.
- c. *Chrysops fuliginosus* The eggs of this species have not been found in the field but adult females have been induced to lay eggs in containers where they produced irregular egg masses with individual brown eggs about 1.1 mm long and 0.3 mm wide (Jamnback and Wall, 1959). Presumably the eggs are laid on saltmarsh grasses and rapidly hatch. Larvae are commonly collected in the mud



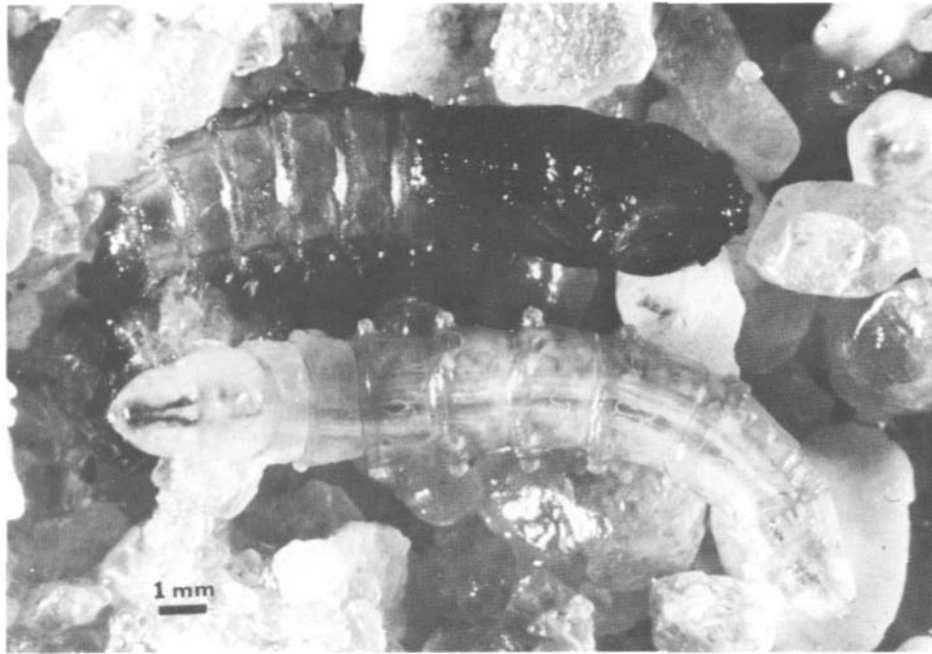

Fig. 15.10. Larva (lower) and pupa (upper) of *Tabanus nigrovittatus*. (Photo courtesy of E. Hansens, Rutgers University.)

in areas of *Spartina alterniflora* (Dukes et al., 1974a,b). The number of moults and period for larval development have not been reported. It probably takes about one year in the field since there is a single peak period of adults each year which lasts for only about a month. The mature larva (14 mm long) pupates in the upper portions of the marsh soil and adult emergence apparently occurs a few days later. The larvae and pupae have been described by Teskey (1969).

- d. *Chrysops atlanticus* Eggs of this species have not been adequately described and there are few larval collections. Jamnback and Wall (1959) found egg masses (13–32 mm long and 2.1 mm wide) on *Spartina alterniflora* about 30 cm above the sod in a single tier, with each egg measuring 1.5 mm long and 0.3 mm wide. Subsequent workers have searched for these egg masses with no success. The larva and pupa were described by Jamnback and Wall (1959) and Teskey (1969). Goodwin (1972) reared pupae from larvae collected from a shallow water area of a brackish pool '300 yards from the Atlantic Coast'. The period for larval development is not known, although it is likely to be about a year since a single peak of adult occurrence is found early each summer. With the abundance and common occurrence of this species along the Atlantic Coast of North America, it is surprising that so few larvae have been found or adults collected in emergence

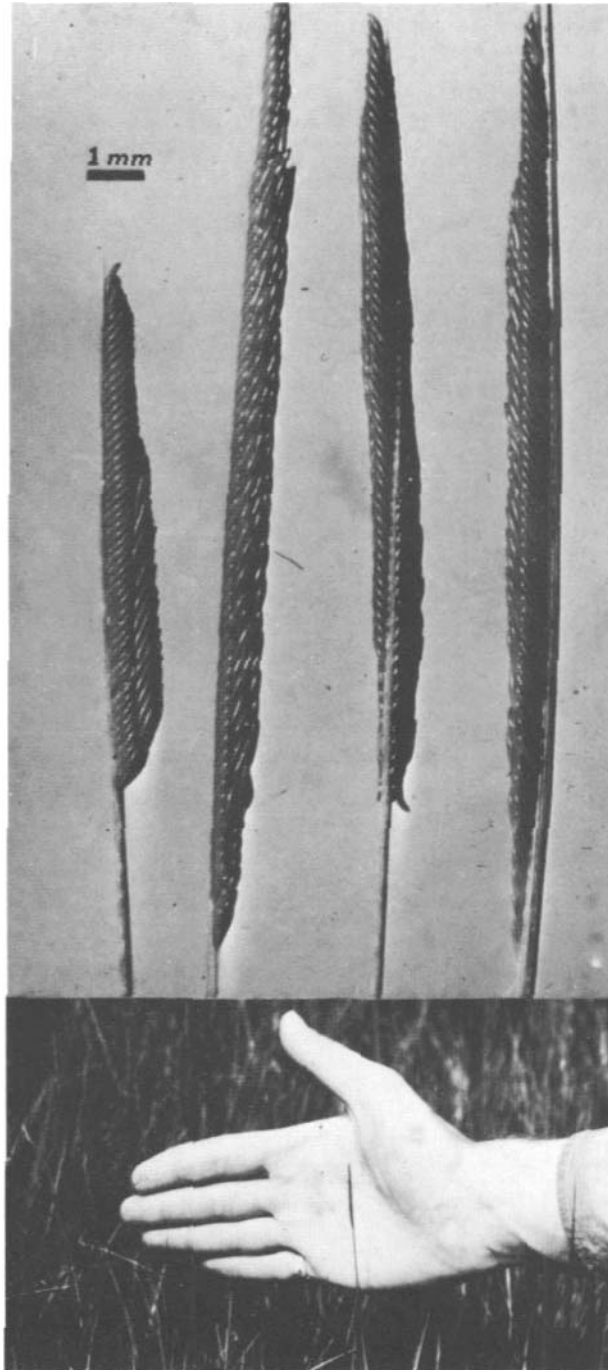

Fig. 15.11. Clusters of eggs of *Tabanus lineola* on blade of marsh grass, *Spartina patens*. (Photo courtesy of E. Hansens, Rutgers University.)

traps. The few records available were mostly from *Spartina alterniflora* marshes (Rockel and Hansens, 1970; Dukes et al., 1974b) but the possibility of more upland breeding sites cannot be ruled out.

### 15.4.3 Seasonality

The seasonal abundance of adults of the four saltmarsh species, as well as many other coastal species, has been well documented in several locations by means of systematic trapping and netting. In the mid-Atlantic coastal area of the United States, *Tabanus nigrovittatus* is present from mid-May to late September with a peak of abundance in mid-June; *T. lineola* is present in low numbers from late May to late September with a peak in August and early September; *Chrysops atlanticus* is present from late April to late September with a peak in early June (sometimes a smaller peak in late August), and *C. fuliginosus* is present from early April to early June with a peak in early May. The patterns of population levels are much the same in other locations with adjustments, of course, for later and shorter periods of activity in the more northern coastal areas and for earlier and longer periods in the more southern areas. These have been well documented. (Hansens, 1952; Jamnback and Wall, 1959; Wall and Doane, 1960; Jones and Anthony, 1964; Anderson, 1971, 1973; Hansens and Robinson, 1973; Thompson, 1973; Matthyse et al., 1974; Dale and Axtell, 1975a.)

### 15.4.4 Food

Adult female tabanids are blood feeders and occasionally nectar feeders, while the males are nectar feeders (Anthony and Jones, 1964; Roberts, 1967). Consequently, mostly females are attracted to carbon dioxide and are collected in traps which are empirically designed to simulate a host. Only a few males are caught in such traps and they are more often collected by netting from shrubs and grasses especially during the flowering period (Pratt and Pratt, 1972). Sources of pollen in the gut of several tabanids, including *T. nigrovittatus* and *T. lineola*, have been analyzed by Wilson and Lieux (1972). Although blood feeding is mostly on mammals, occasional feeding of birds also occurs (Davies, 1959; Bennett, 1960; Wilson and Richardson, 1969). The behaviour, chemical stimulants and chemoreceptors associated with feeding have been investigated in some upland species (Crewe and Gordon, 1959; Dickerson and Lavoipierre, 1959; Lall and Davies, 1967, 1971; Hafez et al., 1970; Lall, 1970a,b,c).

Little is known about the food of the larval stages. They apparently feed on small invertebrates, microorganisms and organic matter in the wet soil. *Tabanus* larvae have stout mouthparts and readily feed on small housefly larvae in the laboratory. They are cannibalistic and must be reared individually. *Chrysops* larvae are smaller and do not readily feed on insect larvae in the laboratory.

They are usually not cannibalistic. In the saltmarshes, tabanid larvae have a variety of potential food sources including often a high density of *Culicoides* larvae.

#### 15.4.5 Parasites and predators

A list of parasites and predators of tabanids in general can be found in Jenkins (1964) and a new list is in preparation by D.W. Anthony (personal communication). Egg parasites include the following Hymenoptera: Scelionidae (*Telenomus*), Mymaridae (*Patasson*) and Trichogrammatidae (*Trichogramma*). *Telenomus emersoni* (Girault) emerged from 14% of the egg masses of *Tabanus lineola* held by Orminati and Hansens (1974) and destroyed about 90% of the eggs in the parasitized masses. *Telenomus tabanivorus* (Ashmead) have been reported from other *Tabanus* egg masses and a closely related species of *Telenomus* from *Chrysops* egg masses (Jackson and Wilson, 1966; Dukes and Hays, 1971). Jones (1953) and Tashiro and Schwardt (1953) found high rates (35–45%) of parasitism on *Tabanus* by *Telenomus tabanivorus*. *Patasson* sp. was reported by Philip (1931) from *Chrysops*. *Trichogramma minutum* (Riley) and *Trichogramma semblidis* (Aurivillus) have been reported mostly from upland *Chrysops* (Cameron, 1926; Philip, 1931; Tashiro and Schwardt, 1953).

Several genera of Tachinidae (Diptera) have been reported to parasitize tabanid larvae (Jones, 1953; Tashiro and Schwardt, 1953; James, 1963; Jones and Anthony, 1964; Soratt and Wolf, 1972). Other larval parasites include a nematode *Bathymermis* (James, 1963; Shamsuddin, 1966), a microsporidian *Telohania tabani* (Gingrich, 1965) and a *Coelomomyces* fungus (Dubitskii et al., 1974).

*Trichopria tabanivora* Fouts (Diapriidae), a hymenopteran pupal parasite, has been reported from *T. nigrovittatus* (Bailey, 1947) and *T. lineola* (Jones, 1953; Jones and Anthony, 1964). Another hymenopteran pupal parasite *Diglochis occidentalis* (Ashmead) (Pteromalidae) has been found in upland *Chrysops* (Cameron, 1926; Philip, 1931). Parasites of adult tabanids include nematodes (*Gordius*) according to Philip (1931) and various mites (Jones and Anthony, 1964).

Predation on tabanid eggs probably occurs more frequently than is realized since the egg masses are exposed. Larvae and adults of the coccinelid beetle *Naemia seriata* (Melsheimer) attack egg masses of *T. lineola* in the saltmarsh (Orminati and Hansens, 1974). Johnson and Hays (1973) reported several insects preying upon *Chrysops* egg masses, but concluded that predators probably were of little significance in the natural control of Tabanidae.

Several insects preying on adult tabanids have been reported including dragon-flies (Odonata), wasps (Sphecidae) and robber flies (Asilidae), (Philip, 1931; Jones, 1953; Jones and Anthony, 1964; Roberts and Wilson, 1967).

Birds have frequently been reported as consuming tabanid larvae, pupae and

adults, although this predation is probably insignificant (Philip, 1931). Jones and Anthony (1964) were unable to find tabanid larvae in the crops of insectivorous and marsh-inhabiting birds in Florida. Cattle egrets (*Bubulcus ibis*) may occasionally consume an adult tabanid although mostly other insects are eaten (Burns and Chapin, 1969; Jenni, 1969; Snoddy, 1969; Siegfried, 1971; Dinsmore, 1973; Fogarty and Hetrick, 1973).

Predators of Tabanidae are probably incidental and exert little effect on the population. Certain parasites, occasionally reported at high incidence levels, may be important population regulators and greater research effort is warranted.

## 15.5 ECOLOGY AND BEHAVIOUR

### 15.5.1 Sampling methods

Studies on the ecology and behavior of Tabanidae are subject to bias due to different sampling methods used. Many ecological studies on saltmarsh invertebrate fauna should have yielded useful information on Tabanidae, but the researchers did not use appropriate sampling methods (Davies and Gray, 1966; Cameron, 1972).

Collection of larval tabanids is time-consuming, laborious and often unproductive. Principal methods which have been used are digging with a hand towel, treatment of the soil with chemical larvicides, drying the soil samples (on outdoor racks or Berlese funnels or in Tullgren funnels equipped with incandescent bulbs) and washing the soil through a series of sieves (Bailey, 1948b; Hansens, 1956; Anthony, 1957; Wall and Jamnback, 1957; Teskey, 1962; James, 1963; Rockel and Hansens, 1970a; Thomas, 1971; Freeman and Hansens, 1972; Edwards et al., 1974).

Adult tabanids may be collected by netting from human or other animal hosts and this also gives a direct measure of the nuisance level. The time of day, however, can drastically affect the results. Sweep netting is often used in marsh ecology studies but is quite useless in catching the fast-moving tabanids. Traps of various types have been used and these differ in their species selectivity. These trapping methods include: sticky surfaces, Malaise traps, box traps, canopy traps and some systems involving use of decoys, carbon dioxide, ultraviolet as well as visible light (Bracken and Thorsteinson, 1965; Bracken et al., 1965; Smith et al., 1965; Thorsteinson et al., 1965, 1966; Wilson et al., 1966; DeFoliart and Morris, 1967; Easton et al., 1968; Wilson, 1968; Thompson, 1969; Catts, 1970; Granger, 1970; Roberts, 1970a,b, 1971, 1974; Hansens et al., 1971; Neys et al., 1971; Adkins et al., 1972; Blume et al., 1972; Knox and Hays, 1972; Watanabe and Kamimura, 1973; Anderson et al., 1974; Thompson and Gregg, 1974; Axtell et al., 1975). Suction traps (Service, 1973) and sticky balloons (Snoddy, 1970) have been used for sampling *Chrysops*. The efficiency and composition of the samples

collected by different methods are rather variable. Ultraviolet light traps tend to collect larger numbers of males of saltmarsh *T. lineola* as well as some *T. nigrovittatus* and *C. atlanticus* (Morgan and Ubel, 1974); both *Tabanus* spp. are readily collected in box traps as well as in canopy traps. *C. fuliginosus* is poorly collected in the box traps but fairly well represented in canopy traps, while *C. atlanticus* is poorly collected by either type of trap. The sticky traps are on the whole fairly satisfactory for all four species of saltmarsh tabanids.

### 15.5.2 Larval distribution in marshes

Coastal saltmarshes vary in relative abundance and vigor of plants and tidal amplitudes. Consequently, it is not surprising that studies on Tabanidae from different marshes yield results which differ in details. However, a general pattern has emerged from studies in marshes along the Atlantic coast of the United States. Caution should be used in extrapolating these findings to other regions.

Generally these coastal saltmarshes inhabited by Tabanidae can be subdivided according to the degree and frequency of tidal flooding which is reflected in the type of vegetation (Adams, 1963; Hotchkiss, 1970; Cooper, 1974). *Spartina alterniflora* (Loiseleur) is found in areas usually flooded twice a day. At slightly higher elevations where there is less flooding and shorter durations of standing water, the marsh is usually covered by *Spartina cynosuroides* (L.) Roth (giant cordgrass), *Spartina patens* (Ait.) Muhl. (salt meadow grass), and *Distichlis spicata* (L.) Greene (salt grass). At higher elevations, flooded only during lunar tides, periods of high rainfall, etc., the dominant vegetation is *Juncus roemerianus* Scheele (black needlerush) or related species.

Larvae of the common saltmarsh tabanids, *Tabanus nigrovittatus*, *T. lineola*, *Chrysops fuliginosus* and a few *C. atlanticus* are most often recovered from soil collected in the regularly flooded areas of *Spartina alterniflora*. Progressively fewer larvae are found in areas with less flooding, and extremely few have been found in *Juncus* marshes. Such plant-tabanid associations are described and discussed by MacCreary (1940), Bailey (1947), Jamnback and Wall (1959), Freeman (1962), Rockel (1969b), Rockel and Hansens (1970a,b), Freeman and Hansens (1972), Dukes et al. (1974a,b).

*Spartina alterniflora* marshes are the major sources of tabanids. This sea grass has a tall form dominating along the sides of drainage ditches and a short form in the general expanse of coastal saltmarshes. This height difference is accentuated in the northern marshes of the Atlantic Coast where the tall ditch-bank *Spartina* is often about the same height as the so-called short *Spartina* covering wide expanses of southern marshes. In addition, the northern marshes tend to have large expanses of *S. patens* with *S. alterniflora* only in restricted areas, especially near drainage ditches. Consequently, more larvae (mostly *T. nigrovittatus*) are reported nearest drainage ditches in northern marshes (New Jersey, Long Island,

Massachusetts), while in southern marshes (North Carolina), larval distribution is fairly uniform across the *Spartina* marshes. To complicate matters, morphological variants of *T. nigrovittatus*, recognizable in the larval stage only, are found (Jamnback and Wall, 1959; Freeman, 1962; Freeman and Hansens, 1972; Dukes et al., 1974). Whether these are two separate species or two strains of *T. nigrovittatus* with different geographical distribution, and habitat requirement within the marsh is not known.

### 15.5.3 Adult movement and dispersal

Most tabanids are strong fliers and may fly up to 1 or 2 km from their breeding sites (Thornhill et al., 1971; Inoue et al., 1973; Thornhill and Hays, 1973). In mark-release-recapture studies, Sheppard et al. (1973) retrieved some *T. lineola* up to 6.4 km from the release point and Vorgetts (1973) retrieved two *T. nigrovittatus* at 8 km away.

Saltmarsh tabanids usually remain on the marsh after emergence, mating and often producing a first batch of eggs autogenously. The mating behavior of *C. fuliginosus* has been elegantly described by Catts and Olkowski (1972). The occurrence of autogeny has been shown in *T. nigrovittatus*, *C. fuliginosus* and *C. atlanticus* (Rockel, 1969a; Anderson, 1971; Bosler and Hansens, 1974). Some non-marsh *Hybomitra* display autogeny while others in the same genus do not (Thomas, 1972, 1973) and some African *Chrysops* apparently are autogenous (Duke et al., 1956), but *T. quinquevittatus* has been shown to be anautogenous in an upland area (Magnarelli and Pechuman, 1975). It is possible that the degree of autogeny in a population varies with geographical area and strains, as has been shown in mosquitoes. In any case, studies to date indicate that the saltmarsh tabanids generally do not begin their flight and host-seeking immediately after emergence. Trapping results indicate that mostly only those females which have laid eggs move.

Large numbers of *T. nigrovittatus* and *C. fuliginosus* have been found congregating in upland marsh-shrub areas. Dense shrubs and woods act as a partial barrier to further movement of these species. *C. atlanticus* moves more readily through the upland shrub-wood barrier. Open spaces (trails, roads, etc.) are the usual avenues for movement of these flies (Rockel and Hansens, 1970b; Hansens and Robinson, 1973; Dale and Axtell, 1974a; Schulze, 1974; Schulze et al., 1975).

Environmental factors including light, temperature and other climatic conditions influence light, mating and biting activities of these flies (Burnett and Hays, 1974). There are often definite peaks of activity during a 24-hour period for each species (Joyce and Hansens, 1968; Richardson and Wilson, 1969; Catts and Olkowski, 1972; Anderson, 1973; Kangwagye, 1973; Roberts, 1974; Dale and Axtell, 1975b).

#### 15.5.4 Role of tabanids in marsh ecosystems

The role of insects, including tabanids, in the marsh ecosystem is poorly understood (Teal, 1962; Davis and Gray, 1966; Marples, 1966; Cameron, 1972; Ranwell, 1972; Nixon and Oviatt, 1973; Daiber, 1974). Conclusions on the contribution of insects to the energy budget of marshes differ (Teal, 1962; McMahan et al., 1972). The few investigations carried out so far have concentrated on collections of adult insects, often with inappropriate sampling methods for insects and incomplete data collection. Examination of several ecological reports shows that usually there are few data on Tabanidae and any findings that might have been made are lumped under a larger taxonomic category - Diptera.

The role of tabanid larvae in the marsh can only be speculated upon. Their feeding habits are not known but it can be assumed that they are primary consumers and feed on detritus, algae, bacteria, etc., in the marsh soil as well as on other small invertebrates found in association with them (Gustafson and Lane, 1968; Wall, 1973; Kraeuter and Wolf, 1974; Bickley and Seek, 1975).

### 15.6 ECONOMIC IMPORTANCE

Many tabanids are aggressive biters of man, livestock and wild animals. *Chrysops* tend to circle the head and shoulders and persist in their attacks while other portions of the host are the target for many *Tabanus*. Attacks by tabanids disrupt the feeding and resting of livestock and can interfere with normal weight gains and milk production. People are annoyed and their outdoor activities are interrupted; this can be detrimental to the resort and recreation industries and property values, especially in the coastal areas (Gerhardt et al., 1973).

Tabanids are vectors of pathogens causing several diseases of man, livestock and wildlife (Zumpt, 1949; Anthony, 1962). *Chrysops* are intermediate hosts of the filarial worm, *Loa loa*, affecting man and monkeys in Africa (Gordon and Crewe, 1953; Crewe and Gordon, 1959; Duke, 1960). Development of *Loa loa* in *Chrysops atlanticus* under laboratory conditions has been demonstrated by Orihel and Lowrie (1975). Trypanosomes affecting livestock and wild animals are vectored by tabanids (Dixon et al., 1971; Davies and Clark, 1974; Krinsky and Pechuman, 1975). Mechanical transmission of the livestock diseases bovine anaplasmosis, equine infectious anemia and hog cholera by tabanids has been demonstrated (Wilson and Meyer, 1966; Hawkins et al., 1972, 1973; Tidwell et al., 1972; Wisenhutter, 1975). Tularemia ('deerfly fever') can be transmitted to humans by *Chrysops* (Klock et al., 1973; Hopla, 1974). *Chrysops discalis* is an intermediate host of a haemosporidian protozoan (DeGiusti et al., 1973; Sterling and DeGiusti, 1974). Encephalitis viruses pathogenic to humans have been isolated from tabanids (DeFoliart et al., 1969; Wright et al., 1970) resulting in recent increased interest in tabanids as disease vectors (Morris and DeFoliart, 1971; Gillies, 1974).



## 15.7 CONTROL

Control of tabanids, especially saltmarsh species, is difficult and satisfactory methods have not been developed. The sparse distribution of larvae in wet soil often in ecologically critical areas, the large number of species with differing seasonal and biological characteristics, and the lack of basic research on the flies are contributing factors to our lack of adequate control procedures. There is a demand for tabanid control to protect people and livestock from the bites and potential disease transmission. Incorporation of tabanid control in broader programs of mosquito and biting-midge control is logical and often desired, especially in coastal areas (Gerry, 1950; Gerhardt et al., 1973; Hansens, 1973; Axtell, 1974).

### *15.7.1 Larval control*

Chemical control of larval stages by treatment of the soil has been suggested and several chemicals have been tested (Hansens, 1956; Jamnback and Wall, 1959; Hoffman, 1960; Crewe and Williams, 1964; Wall and Marganian, 1973). However, it is not practical or desirable to treat a marsh with chemicals which give only partial control while having adverse effects on the non-target organisms. Larval control by water management can eliminate *Chrysops* larvae in selected marsh areas (Kneen, 1968; Anderson and Kneen, 1969), but any extensive impoundment would eliminate too much natural marsh.

### *15.7.2 Adult control*

Repellents applied to livestock or man give a short period of relief from the biting of adult tabanids (Gilbert, 1957; Gerberg, 1966; Blume et al., 1971). Repellent-impregnated mesh shirts for people have some use (Catts, 1968; Grothaus et al., 1974).

Application of chemicals in an area for adult tabanid control can give some temporary relief but proper timing is difficult and the degree of control is usually much lower than is routinely achieved for mosquitoes (Howell et al., 1949; Brown and Morrison, 1955; Wilson, 1968a; Watanabe and Kamimura, 1971b; Henry, 1973; Axtell and Dukes, 1974). Treatment of livestock with insecticides gives temporary relief (Granett and Hansens, 1957; Hoffman et al., 1965).

The use of traps for control is an attractive concept due to their lack of environmental pollution, relatively low cost and ease of use. In fact, traps have been used routinely in some coastal areas for control of *T. nigrovittatus* attacking humans (Spencer, 1971), but their effectiveness is still questionable since there are limited data on the actual degree of control achieved, although many flies have been caught in the traps. Traps around pastures have given highly variable control

of tabanids on livestock (Wilson, 1968b; Tabachi and Yahima, 1969, 1970; Bauer and Wetzel, 1974). Since vegetative barriers impede movement of tabanids from the marsh, strategic plantings and retention of natural vegetation can be used along with traps to reduce the numbers of tabanids reaching the upland.

Since saltmarsh tabanids can reproduce autogenously, selective control of the adults which move to upland areas to attack people and animals will have minor effects on the population of larvae in the marsh.

## REFERENCES

- Adams, D.A. (1963) Factors influencing vascular plant zonation in North Carolina salt marshes. *Ecology* 44, 445–456.
- Adkins, T.R., Ezell, W.B., Jr., Sheppard, D.C. and Askey, M.M., Jr. (1972) A modified canopy trap for collecting Tabanidae (Diptera). *J. Med. Entomol.* 9, 183–185.
- Anderson, J.F. (1971) Autogeny and mating and their relationship to biting in the saltmarsh deer fly, *Chrysops atlanticus* (Diptera: Tabanidae). *Ann. Entomol. Soc. Am.* 64, 1421–1424.
- Anderson, J.F. (1973) Biting behavior of salt marsh deer flies (Diptera: Tabanidae). *Ann. Entomol. Soc. Am.* 66, 21–23.
- Anderson, J.F. and Kneen, F.R. (1969) The temporary impoundment of salt marshes for the control of coastal deer flies. *Mosquito News* 29, 239–42.
- Anderson, J.R., Olkowski, W. and Hoy, J.B. (1974) The response of tabanid species to CO<sub>2</sub>-baited insect flight traps in northern California (Diptera: Tabanidae). *Pan-Pac. Entomol.* 50, 255–268.
- Anthony, D.W. (1957) Pyrethrum emulsions for the survey of tabanid larvae. *J. Econ. Entomol.* 50, 740–742.
- Anthony, D.W. (1962) Tabanidae as disease vectors. In: *Biological Transmission of Disease Agents*. (K. Maramorosch, Ed.), , pp. 93–107.
- Axtell, R.C. (Ed.) (1974) Training manual for mosquito and biting fly control in coastal areas. (UNC-SG-74-08.) 249 p.
- Axtell, R.C. and Dukes, J.C. (1974) ULV chemical control of mosquitoes, *Culicoides* and tabanids in coastal North Carolina. *Proc. Calif. Mosquito Control Assoc.* 42, 99–101.
- Axtell, R.C., Edwards, T.D. and Dukes, J.C. (1975) Rigid canopy trap for Tabanidae (Diptera). *J. Georgia Entomol. Soc.* 10, 67–73.
- Bailey, N.S. (1947) Field notes on *Tabanus nigrovittatus* Macquart. *Psyche* 54, 62–64.
- Bailey, N.S. (1948a) The hovering and mating of Tabanidae: A review of the literature with some original observations. *Ann. Entomol. Soc. Am.* 41, 403–412.
- Bailey, N.S. (1948b) A mass collection and population survey technique for larvae of Tabanidae (Diptera). *Bull. Brooklyn Entomol. Soc.* 93, 22–29.
- Bauer, B. and Wetzel, H. (1974) Versuche mit Fliegenfallen zur Tabanidenbekämpfung auf der Weide. *Tierarztl. Umsch.* 29, 206–207.
- Bennett, G.F. (1960) On some ornithophilic blood-sucking Diptera in Algonquin Park, Ontario, Canada. *Can. J. Zool.* 38, 377–389.
- Bickley, W.E. and Seek, T.R. (1975) Insects in four Maryland marshes. No. 870. 27 p.
- Blickle, R.L. (1959) Observation on the hovering and mating of *Tabanus bishoppi* Stone (Diptera; Tabanidae). *Ann. Entomol. Soc. Am.* 52, 183–190.
- Blume, R.R., Roberts, R.H., Eschle, J.F. and Matter, J. (1971) Tests of aerosols of deet for protection of livestock from biting flies. *J. Econ. Entomol.* 64, 1193–1196.

- Blume, R.R., Miller, J.A., Eschele, J.L., Matter, J.J. and Pickens, M.O. (1972) Trapping tabanids with modified Malaise traps baited with CO<sub>2</sub>. *Mosquito News* 32, 90–95.
- Bosler, E.M. and Hansens, E.J. (1974) Natural feeding behavior of adult saltmarsh greenheads, and its relation to oogenesis. *Ann. Entomol. Soc. Am.* 67, 321–324.
- Bonhag, P.F. (1951) The skeleto-muscular mechanism of the head and abdomen of the adult horsefly (Diptera: Tabanidae). *Trans. Am. Entomol. Soc.* 77, 131–202.
- Boyes, J.W. and Wilkes, A. (1972) Chromosomes of Tabanidae (Diptera). *Can. J. Genet. Cytol.* 14, 95–104.
- Bracken, G.K. and Thorsteinson, A.J. (1965) The orientation behavior of horse flies and deer flies (Tabanidae: Diptera). IV. The influence of some physical modifications of visual decoys on orientation of horse flies. *Entomol. Exp. Appl.* 8, 314–318.
- Bracken, G.K., Hanec, W. and Thorsteinson, A.J. (1965) The orientation behavior of horse flies and deer flies (Tabanidae: Diptera). II. The role of some visual factors in the attractiveness of decoy silhouettes. *Can. J. Zool.* 40, 685–695.
- Brown, A.W.A. and Morrison, P.E. (1955) Control of adult tabanids by aerial spraying. *J. Econ. Entomol.* 48, 125–9.
- Burnett, A.M. and Hays, K.L. (1974) Some influences of meteorological factors on flight activity of female horse flies (Diptera: Tabanidae). *Environ. Entomol.* 3, 515–521.
- Burns, E.C. and Chapin, J.B. (1969) Arthropods in the diet of the cattle egret (*Bubulcus ibis*) in southern Louisiana. *J. Econ. Entomol.* 62, 736–738.
- Cameron, A.E. (1926) Bionomics of the Tabanidae of the Canadian prairie. *Bull. Entomol. Res.* 17, 1–42.
- Cameron, A.E. (1934) The life-history and structure of *Haematopota pluvialis* Linne (Tabanidae). *Trans. R. Soc. Edinb.* 58, 211–250.
- Cameron, G.N. (1972) Analysis of insect trophic diversity in two salt marsh communities. *Ecology* 53, 58–73.
- Carrasco, Z.F. (1972) Tabanos del Peru. *Rev. Peruana Entomol. Agric.* 15, 317–323.
- Catts, E.P. (1968) Deet impregnated shirt repels biting flies. *J. Econ. Entomol.* 61, 1765.
- Catts, E.P. (1970) A canopy trap for collecting Tabanidae. *Mosquito News* 30, 472–474.
- Catts, E.P. and Olkowski, W. (1972) Biology of Tabanidae (Diptera): Mating and feeding behavior of *Chrysops fuliginosus*. *Environ. Entomol.* 1, 448–453.
- Chvála, M., Lyneborg, L. and Moucha, J. (1972) The Horse Flies of Europe (Diptera, Tabanidae). (, 499 p.
- Cooper, A.W. (1974) Salt marshes. In: *Coastal Ecological Systems of the United States, Vol. II.* (H.T. Odum, B.J. Copeland and E.A. McMahan, Eds.)pp. 55–98. (, )
- Crewe, W. and Gordon, R.M. (1959) The immediate reaction of the mammalian host to bite of un-infected *Chrysops* and of *Chrysops* infected with human and with monkey *Loa*. *Ann. Trop. Med. Parasitol.* 58, 343–346.
- Crewe, W. and Williams, P. (1964) Studies on the control of the vectors in Loiasis in West Africa. VII. The effects of low concentrations of dieldrin in the mud of natural tabanid breeding-sites in the rain forest of the Cameroons. *Ann. Trop. Med. Parasitol.* 58, 343–346.
- Daiber, F.C. (1974) Salt marsh plants and future coastal salt marshes in relation to animals. In: *Ecology of Halophytes.* (R.J. Reimold and W.H. Queen, Eds.) pp. 475–507. (, )
- Dale, W.E. and Axtell, R.C. (1975a) Salt marsh Tabanidae (Diptera): Comparison of abundance and distribution in *Spartina* and *Juncus* habitats. *J. Med. Entomol.* 12, (in press).
- Dale, W.E. and Axtell, R.C. (1975b) Flight of the salt marsh Tabanidae (Diptera), *Tabanus nigrovittatus*, *Chrysops atlanticus* and *C. fuliginosus*: Correlation with temperature, light, moisture and wind velocity. *J. Med. Entomol.* 12, 551–557.

- Davies, D.M. (1959) Seasonal variation of tabanids (Diptera) in Algonquin Park, Ontario. *Can. Entomol.* 91, 548–553.
- Davies, R.B. and Clark, G.G. (1974) Trypanosomes from elk and horse flies in New Mexico. *J. Wildl. Dis.* 10, 63–65.
- Davis, L.V. and Gray, I.E. (1966) Zonal and seasonal distribution of insects on North Carolina salt marshes. *Ecol. Monogr.* 36, 275–295.
- DeFoliart, G.R. and Morris, C.D. (1967) A dry ice-baited trap for the collection and field storage of hematophagous Diptera. *J. Med. Entomol.* 4, 360–362.
- DeGuisti, D.L., Sterling, C.R. and Dobrzecowski, D. (1973) Transmission of the chelonian haemoproteid *Haemoproteus metchnikovi* by a tabanid fly *Chrysops callidus*. *Nature* 242, 50–51.
- DeFoliart, G.R., Anslow, R.O., Hanson, R.P., Morris, C.D., Papadopoulos, O. and Sather, G.E. (1969) Isolation of Jamestown Canyon serotype of California encephalitis virus from naturally infected *Aedes* mosquitoes and tabanids. *Am. J. Trop. Med. Hyg.* 18, 440–447.
- Dickerson, G. and Lavoipierre, M.M.J. (1959) Studies on the methods of feeding of blood-sucking arthropods III. The method by which *Haematopota pluvialis* obtains its blood-meal from the mammalian host. *Ann. Trop. Med. Parasitol.* 53, 465–472.
- Dinsmore, J.J. (1973) Foraging success of cattle egrets, *Bubulcus ibis*. *Am. Midl. Nat.* 89, 242–246.
- Dixon, J.B., Cull, R.S., Dunbar, I.F., Greenhill, R.J., Grimshaw, C.G., Hill, M.A., Landeg, F.J. and Miller W.M. (1971) Non-cyclical transmission of trypanosomiasis in Uganda. I. Abundance and biting behavior of Tabanidae and *Stomoxys*. *Vet. Rec.* 89, 228–233.
- Dubitskii, A.M., Deshevyh, N.D. and Andreeva, R.V. (1974) Activation conditions of resting sporangia of *Coelomomyces milkoii* under laboratory conditions. *Parazitologiya* 8, 175–178. (In Russian).
- Duke, B.O.L. (1960) Studies on the biting fly habits of *Chrysops*. VIII. The biting cycle of nulliparous *C. silacea* and *C. dimidata* (Bombe form). *Ann. Trop. Med. Parasitol.* 54, 147–155.
- Dukes, J.C. and Hays, K.L. (1971) Seasonal distribution and parasitism of eggs of Tabanidae in Alabama. *J. Econ. Entomol.* 64, 886–889.
- Dukes, J.C., Edwards, T.D. and Axtell, R.C. (1974a) Distribution of larval Tabanidae (Diptera) in a *Spartina alterniflora* salt marsh. *J. Med. Entomol.* 11, 79–83.
- Dukes, J.C., Edwards, T.D. and Axtell, R.C. (1974b) Associations of Tabanidae (Diptera) larvae with plant species in salt marshes, Carteret County, North Carolina. *Environ Entomol.* 3, 280–286.
- Easton, E.R., Price, M.A. and Graham, O.H. (1968) The collection of biting flies in west Texas with Malaise and animal-baited traps. *Mosquito News* 28, 465–469.
- Edwards, T.D., Dukes, J.C. and Axtell, R.C. (1974) Soil-washing apparatus for recovery of tabanid larvae and other invertebrates. *J. Georgia Entomol. Soc.* 9, 32–35.
- El-Ziady, S. and Hefnawy, T. (1970) External and internal structure of the full-grown larva and pupa of *Tabanus taeniola* P. de B. (Diptera: Tabanidae). *Bull. Entomol. Soc. Egypt.* 54, 415–431.
- Everett, R. and Lancaster, J.L. (1968) A comparison of animal and dry-ice baited traps for the collection of tabanids. *J. Econ. Entomol.* 61, 863–864.
- Ezell, W.B., Sheppard, D.C., Adkins, T.R., Jr. and Pechuman, L.L. (1974) An annotated list of the Tabanidae (Diptera) of South Carolina. *J. Georgia Entomol. Soc.* 9, 91–99.
- Fairchild, G.B. (1969a) Climate and the phylogeny and distribution of Tabanidae. *Bull. Entomol. Soc. Am.* 15, 7–11.
- Fairchild, G.B. (1969b) Notes on Neotropical Tabanidae XII. Classification and distribution, with keys to genera and subgenera. *Arq. Zool. São Paulo* 17, 199–255.
- Fairchild, G.B. (1971) Tabanidae. In: *A Catalogue of the Diptera of the Americas South of the United States*, section 28, pp. 1–163. (, .)
- Fogarty, M.J. and Hetrick, W.M. (1973) Summer food habits of cattle egrets in north central Florida. *Auk* 90, 268–280.

- Foster, C.H., Renaud, G.D. and Hays, K.L. (1973) Some effects of the environment on oviposition by *Chrysops* (Diptera: Tabanidae). *Environ Entomol.* 2, 1048–1050.
- Freeman, J.V. (1962) *Biology, ecology and taxonomy of Tabanus nigrovittatus* Macquart (Diptera: Tabanidae) of the salt marsh at Leeds Point, New Jersey. (Ph.D. thesis, Rutgers University, New Brunswick, N.J.) 209 pp.
- Freeman, J.V. and Hansens, E.J. (1972) Collecting larvae of the salt marsh greenhead *Tabanus nigrovittatus* and related species in New Jersey: Comparison of methods. *Environ. Entomol.* 1, 653–658.
- Gerberg, E.J. (1966) Field and laboratory tests with 2,2,4-trimethyl-1,3-pentanediol (TMPD). *J. Econ. Entomol.* 59, 872–875.
- Gerhardt, R.R., Dukes, J.C., Falter, J.M. and Axtell, R.C. (1973) Public opinion on insect pest management in coastal North Carolina. No. 97. 81 p.
- Gerry, B.I. (1950) Salt marsh fly control as an adjunct to mosquito control in Massachusetts. *Proc. N. J. Mosquito Exterm. Assoc.* 37, 189–193.
- Gilbert, I.H. (1957) Evaluation of repellents against mosquitoes and deer flies in Oregon. *J. Econ. Entomol.* 50, 46–48.
- Gillies, M.T. (1974) Methods for assessing the density and survival of bloodsucking Diptera. *Annu. Rev. Entomol.* 19, 345–362.
- Goodwin, J.T. (1972) Immature stages of some eastern Nearctic Tabanidae (Diptera). I. Introduction and the genus *Chrysops* Meigen. *J. Georgia Entomol. Soc.* 7, 98–109.
- Goodwin, J.T. (1973a) Immature stages of some eastern Nearctic Tabanidae (Diptera). II. Genera of the Tribe Diachlorini. *J. Georgia Entomol. Soc.* 8, 5–11.
- Goodwin, J.T. (1973b) Immature stages of some eastern Nearctic Tabanidae (Diptera). III. The genus *Tabanus* Linnaeus. *J. Georgia Entomol. Soc.* 8, 82–99.
- Goodwin, J.T. (1973c) Immature stages of some eastern Nearctic Tabanidae (Diptera). IV. The genus *Merycomyia*. *J. Tennessee Acad. Sci.* 48, 115–118.
- Goodwin, J.T. and Murdoch, W.P. (1974) A study of some immature Neotropical Tabanidae (Diptera). *Ann. Entomol. Soc. Am.* 67, 85–133.
- Gordon, R.R. and Crewe, W. (1953) The deposition of the infective stage of *Loa loa* by *Chrysops silacea* and the early stages of its migration to the deeper tissues of the mammalian host. *Ann. Trop. Med. Parasitol.* 47, 74–85.
- Granger, C.A. (1970) Trap design and color as factors in trapping the salt marsh greenhead fly. *J. Econ. Entomol.* 63, 1670–1672.
- Granett, P. and Hansens, E.J. (1957) Further observations on the effect of biting fly control on milk production in cattle. *J. Econ. Entomol.* 50, 332–336.
- Gringrich, R.E. (1965) *Telohania tabani* sp. n. a microsporidian from larvae of the black horse fly *Tabanus atratus* Fabricius. *J. Invert. Pathol.* 7, 236–240.
- Grothaus, R.H., Gouck, H.K., Weidhaas, D.E. and Jackson, S.C. (1947) Wide-mesh netting, an improved method of protection against blood-feeding Diptera. *Am. J. Trop. Med. Hyg.* 23, 533.
- Gustafson, J.F. and Lane, R.S. (1968) An annotated bibliography of literature on salt marsh insects and related arthropods in California. *Pan-Pac. Entomol.* 44, 327–331. (Supplemented lists available from senior author.)
- Hafez, M., El-Ziady, S., Hefnawy, T. (1970) Studies on the feeding habits of female *Tabanus taeniola* P. de B. (Diptera: Tabanidae). *Bull. Entomol. Soc. Egypt.* 54, 365–376.
- Hansens, E.J. (1952) Some observations on the abundance of salt marsh greenheads. *Proc. N. J. Mosquito Exterm. Assoc.* 39, 93–98.
- Hansens, E.J. (1956) Granulated insecticides against greenhead (*Tabanus*) larvae in the salt marsh. *J. Econ. Entomol.* 49, 401–403.
- Hansens, E.J. (1973) Integrated control of blood-sucking Diptera in seashore areas. *Proc. N. J. Mosquito Exterm. Assoc.* 60, 96–102.

- Hansens, E.J. and Robinson, J.W. (1973) Emergence and movement of the saltmarsh deer flies *Chrysops fuliginosus* and *Chrysops atlanticus*. *Ann. Entomol. Soc. Am.* 66, 1215–1218.
- Hansens, E.J., Bosler, E.M. and Robinson, J.W. (1971) Use of traps for study and control of salt-marsh greenhead flies. *J. Econ. Entomol.* 64, 1481–1486.
- Howell, D.E., Eddy, G.W. and Cutt, R.L. (1949) Effect on horse fly populations of aerial spray to wooded areas. *J. Econ. Entomol.* 42, 644–646.
- Hawkins, J.A., Adams, W.V., Cook, L., Wilson, B.H. and Roth, E.E. (1972) Transmission of equine infectious anemia with the horse fly *Tabanus fuscicostatus* Hine. *Proc. 76th Annu. Meet. U. S. Anim. Health Assoc.*, pp. 227–230.
- Hawkins, J.A., Adams, W.V., Cook, L., Wilson, B.H. and Roth, E.E. (1973) Role of horse fly (*Tabanus fuscicostatus* Hine) and stable fly (*Stomoxys calcitrans* L.) in transmission of equine infectious anemia to ponies in Louisiana. *Am. J. Vet. Res.* 34, 1583–1586.
- Hennig, W. (1952) *Die Larvenformen der Dipteren*, vol. 3. ( ) 628 p.
- Henry, H.M. (1973) Control and behavior of coastal South Carolina Tabanidae (Diptera). (Ph.D. thesis, Clemson Univ., Clemson, S. C.) 84 pp.
- Hoffman, R.A. (1960) Laboratory evaluation of several insecticides against *Chrysops* larvae. *J. Econ. Entomol.* 53, 262–263.
- Hoffman, R.A., Berry, I.L. and Graham, O.H. (1965) Control of flies in cattle by frequent, low-volume mist spray applications of Ciodrin. *J. Econ. Entomol.* 58, 815–817.
- Hopla, C.E. (1974) The ecology of tularemia. *Adv. Vet. Sci. Comp. Med.* 18, 25–53.
- Hotchkiss, N. (1970) Common marsh plants of the United States and Canada. No. 93. 99 pp.
- Inoue, T., Kamimura, K. and Watanabe, M. (1973) A quantitative analysis of dispersal in a horsefly, *Tabanus iyoensis* Shiraki and its application to estimate the population size. *Res. Popul. Ecol.* 14, 209–233.
- Jackson, T.O. and Wilson, B.H. (1966) Parasitism of tabanid (Diptera: Tabanidae) eggs in four areas of Southern Louisiana. *Ann. Entomol. Soc. Am.* 59, 261–267.
- James, H.G. (1963) Larval habitats, development development, and parasites of some Tabanidae (Diptera) in southern Ontario. *Can. Entomol.* 95, 1223–1232.
- Jannback, H. and Wall, W. (1959) The common salt marsh Tabanidae of Long Island, New York. No. 375. 77 pp.
- Jenkins, D.W. (1964) Pathogens, parasites and predators of medically important arthropods. *Bull. WHO* 30, suppl. 150 pp.
- Jenni, D.A. (1969) A study of the ecology of four species of herons during the breeding season at Lake Alice, Alachua County, Florida. *Ecol. Monogr.* 39, 245–270.
- Johnson, A.W. and Hays, K.L. (1973) Some predators of immature Tabanidae (Diptera) in Alabama. *Environ. Entomol.* 2, 1116–1117.
- Jones, C.M. (1953) Biology of Tabanidae in Florida. *J. Econ. Entomol.* 46, 1108–1109.
- Jones, C.M. and Anthony, D.W. (1964) The Tabanidae (Diptera) of Florida. No. 1295. 85 pp.
- Joyce, J.M. and Hansens, E.J. (1968) The influence of weather on the activity and behavior of green-head flies, *Tabanus nigrovittatus* Macquart and *Tabanus lineola* Fabricius. *J. N. Y. Entomol. Soc.* 76, 72–80.
- Kangwagye, T.N. (1973) Diurnal and nocturnal biting activity of flies (Diptera) in western Uganda. *Bull. Entomol. Res.* 63, 17–29.
- Klock, L.E., Olsen, P.F. and Fukushima, T. (1973) Tularemia epidemic associated with the deerfly. *J. Am. Med. Assoc.* 226, 149–152.
- Kneen, F.R. (1968) Water management in the control of *Chrysops niger*. *Proc. N. J. Mosquito Exterm. Assoc.* 55, 94–98.

- Knox, P.C. and Hays, K.L. (1972) Attraction of *Tabanus* spp. (Diptera: Tabanidae) to traps baited with carbon dioxide and other chemicals. *Environ. Entomol.* 1, 323–326.
- Knudsen, A.B. and Rees, D.M. (1967) Egg laying habits of the deer fly *Chrysops discalis* Williston, in marshes bordering the Great Salt Lake, Utah. *Proc. Calif. Mosquito Control Assoc.* 35, 103–105.
- Kraeuter, J.N. and Wolf, P.L. (1974) The relationship of marine macroinvertebrates to salt marsh plants. In: *Ecology of Halophytes*. (R.J. Reimold and W.H. Queen, Eds.) pp. 449–462. (, .)
- Krinsky, W.L. and Pechuman, L.L. (1975) Trypanosomes in horse flies and deer flies in central New York State. *J. Parasitol.* 61, 12–16.
- Lall, S.B. (1970a) Nectar sugars as chemostimulants for the tarsal taste sensilla of haematophagous tabanids (Diptera). *J. Med. Entomol.* 7, 103–106.
- Lall, S.B. (1970b) Feeding behavior of haematophagous Tabanids (Diptera). *J. Med. Entomol.* 7, 115–119.
- Lall, S.B. (1970c) Loci, structure and function of contact chemical sensilla in haematophagous tabanids (Diptera). *J. Med. Entomol.* 7, 205–222.
- Lall, S.B. and Davies, D.M. (1967) Tarsal sensitivity of female tabanid flies to sucrose and sodium chloride. *Can. J. Zool.* 45, 461–464.
- Lall, S.B. and Davies, D.M. (1971) An intergeneric comparison of cephalic structure in Tabanids (Diptera) in relation to feeding habits. *J. Med. Entomol.* 8, 700–706.
- Leclercq, M. (1960) Révision systématique et biogéographique des Tabanidae paléarctique et Chrysopinae. *Mem. Inst. R. Sci. Nat. Belg.* 63, 1–77.
- Leclercq, M. (1967) Révision systématique et biogéographique des Tabanidae paléarctique, Vol. II. Tabanidae. *Mem. Inst. R. Sci. Nat. Belg.* 80, 1–237.
- MacCreary, D. (1940) Report on the Tabanidae of Delaware. No. 226. 41 p.
- Mackerras, I.M. (1954) The classification and distribution of Tabanidae (Diptera). I. General review. *Aust. J. Zool.* 2, 431–454.
- Mackerras, I.M. (1955a) The classification and distribution of Tabanidae (Diptera). II. History: morphology: classification: subfamily Pangoniinae. *Aust. J. Zool.* 3, 439–511.
- Mackerras, I.M. (1955b) The classification and distribution of Tabanidae (Diptera). III. Subfamilies Scepsidinae and Chrysopinae. *Aust. J. Zool.* 3, 583–633.
- Mackerras, I.M. (1956a) The Tabanidae (Diptera) of Australia. I. General review. *Aust. J. Zool.* 4, 376–407.
- Mackerras, I.M. (1956b) The Tabanidae (Diptera) of Australia. II. Subfamily Pangoniidae, Tribe Pangoniini. *Aust. J. Zool.* 4, 408–443.
- Mackerras, I.M. (1971) The Tabanidae (Diptera) of Australia. V. Subfamily Tabanini. *Aust. J. Zool. suppl.* 4, 54 p.
- Mackerras, I.M. (1972) Melonesian-Pacific *Tabanus* (Diptera): Tabanidae. *Pac. Insects* 14, 133–149.
- Magnarelli, L.A. and Pechuman, L.L. (1975) Ovarian studies of *Tabanus quinquevittatus* (Diptera: Tabanidae). *J. Med. Entomol.* 11, 687–690.
- Marples, T.G. (1966) A radionuclide tracer study of arthropod food chains in a *Spartina* marsh ecosystem. *Ecology* 47, 270–277.
- Matthysse, J.G., Mock, D.E. and Netherton, H.R. (1974). Seasonal flight period and relative abundance of Tabanidae (Diptera) near Ithaca, New York. *Ann. Entomol. Soc. Am.* 67, 158–166.
- McMahan, E.A., Knight, R.L. and Camp, A.R. (1972) A comparison of microarthropod populations in sewage-exposed and sewage-free *Spartina* salt marshes. *Environ. Entomol.* 1, 244–252.
- Morgan, N.O. and Uebel, E.C. (1974) Efficacy of the Assateague insect trap in collecting mosquitoes and biting flies in a Maryland salt marsh. *Mosquito News* 34, 196–199.
- Morris, C.D. and DeFoliart, G.R. (1971) Seasonal parous rates in *Hybomitra lasiophthalma* (Diptera: Tabanidae). *J. Med. Entomol.* 8, 207–208.

- Neys, W.A., Lavigne, R.S. and Roehrkas, G.P. (1971) Attraction of Wyoming Tabanidae (Diptera) to decoys suspended from modified Manitoba fly traps. No. 22. 11 p.
- Nixon, S.W. and Oviatt, C.A. (1973) Ecology of a New England salt marsh. Ecol. Monogr. 43, 463–498.
- Oldroyd, H. (1952) The Horse-Flies (Diptera: Tabanidae) of the Ethiopian Region, Vol. I: *Haematopota* and *Hippocentrum*. (Br. Mus. Nat. Hist., Lond.) 226 p.
- Oldroyd, H. (1954) The Horse-Flies (Diptera: Tabanidae) of the Ethiopian Region, Vol. V: *Tabanus* and Related Genera. (Br. Mus. Nat. Hist., Lond.) 341 p.
- Oldroyd, H. (1957) The Horse-Flies (Diptera: Tabanidae) of the Ethiopian Region, Vol. III: Sub-families Chrysopinae, Sceptidinae and Pangoniinae and a revised classification. (Br. Mus. Nat. Hist. Lond.) 489 p.
- Oldroyd, H. (1969) Diptera Brachycera. Section (a) Tabanoidea and Asiloidea. In: Handbooks for the Identification of British Insects, Vol. 9, part 4 ( ) 132 p.
- Olsufjev, N.G. (1969a) On the taxonomy and distribution of Tabanidae (Diptera) of the Palaearctic region. Acta Entomol. Bohemoslov. 66, 115–121.
- Olsufjev, N.G. (1969b) Tabanidae-Slepni. In: Opredeľitel nasekomych Evropejsko, casti SSR. 5, 481–500 (figs. 292–303). (In Russian).
- Orihel, T.C. and Lowrie, R.C., Jr. (1975) *Loa loa*: development to the infective stage in an American deerfly, *Chrysops atlanticus*. Am. J. Trop. Med. Hyg. 24, 610–615.
- Orminati, S.A. and Hansens, E.J. (1974) The biology of *Tabanus lineola lineola* F. Ann. Entomol. Soc. Am. 67, 937–939.
- Pechuman, L.L. (1972) The horse flies and deer flies of New York (Diptera: Tabanidae). Search, Agric. (N. Y. Agric. Exp. Stn.) 2(5) 72 p.
- Pechuman, L.L. (1973) The horse flies and deer flies of Virginia (Diptera: Tabanidae). , , No. 81. 92 p.
- Pernot-Visentin, O. and Beaucournu-Saguez, F. (1974) Les Tabanidae (Diptera) de France. Bull. Mens. Soc. Linn. Lyon 43, 142–155.
- Pino, G., Candia, V., Letelier, S., Ostoic, A., Sanchez, J. and Sanchez, V. (1973) Los tabanos de Chile (Diptera: Tabanidae). 4. Estudios ecologicos preliminares en Fray Jorge. Rev. Chil. Entomol. 7, 207–216.
- Philip, C.B. (1931) The Tabanidae (horseflies) of Minnesota. No. 80, 132 p.
- Philip, C.B. (1954) New North American Tabanidae. VIII. Notes on and keys to the genera and species of Pangoniinae exclusive of *Chrysops*. Rev. Brazil Entomol. 2, 13–60.
- Philip, C.B. (1955) New North American Tabanidae. IX. Notes on and keys to the genus *Chrysops* Meigen. Rev. Brazil Entomol. 3, 47–128.
- Philip, C.B. (1957) A new era in ideas of systematic relationships of world Tabanidae (Diptera) inaugurated by Mackerras and its impact on nomenclature of horseflies of the western hemisphere. Ann. Entomol. Soc. Am. 50, 550–555.
- Philip, C.B. (1965) Family Tabanidae. In: A Catalog of the Diptera of America North of Mexico. (A. Stone, C.W. Sabrosky, W.W. Wirth, R.H. Foot and J.R. Coulson, Eds.) pp. 319–342. ( No. 276, )
- Philip, C.B. (1966) New North American Tabanidae. XVIII. New species and addenda to a Nearctic catalog. Ann. Entomol. Soc. Am. 59, 519–527.
- Philip, C.B. and Coscaron, S. (1971) Comparative terminalia of certain Nearctic and Palaearctic chrysopsine flies. Tabanidae. Ann. Entomol. Soc. Am. 64, 157–162.
- Pratt, G.K. and Pratt, H.D. (1972) Records of Tabanidae (Diptera) collected on flowers. Mosquito News 32, 632–633.



- Ranwell, D.S. (1972) Ecology of Salt Marshes and Sand Dunes. (, .) 258 pp.
- Richardson, C.G. and Wilson, B.H. (1969) Daily flight activity of male *Tabanus lineola* var. *hinellus* Philip (Diptera: Tabanidae) in the estuarine area of Louisiana. J. Med. Entomol 6, 276–277.
- Roberts, L.W. and Wilson, B.H. (1967) Predation on horse flies by two bembicine wasp species in certain areas of southern Louisiana. J. Econ. Entomol. 60, 412–415.
- Roberts, R.H. (1966) A technique for rearing the immature stages of Tabanidae (Diptera). Entomol. News 77, 79–82.
- Roberts, R.H. (1967) Feeding of horseflies (Tabanidae: Diptera) on plant juices. Entomol. News 78, 250–251.
- Roberts, R.H. (1970a) Tabanidae collected in a Malaise trap baited with CO<sub>2</sub>. Mosquito News 30, 52–53.
- Roberts, R.H. (1970b) Color of Malaise trap and the collection of Tabanidae. Mosquito News 30, 567–571.
- Roberts, R.H. (1971) Effect of CO<sub>2</sub> on collection of Tabanidae in Malaise traps. Mosquito News 31, 551–558.
- Roberts, R.H. (1974) Diurnal activity of Tabanidae based on collections in Malaise traps. Mosquito News 34, 220–223.
- Rockel, E.G. (1969a) Autogeny in the deerfly, *Chrysops fuliginosus*. J. Med. Entomol. 6, 140–142.
- Rockel, E.G. (1969b) Marsh physiography: Influence on distribution of intertidal organisms. Proc. N. J. Mosquito Exterm. Assoc. 56, 102–116.
- Rockel, E.G. and Hansens, E.J. (1970a) Distribution of larval horse flies and deer flies (Diptera: Tabanidae) of a New Jersey salt marsh. Ann. Entomol. Soc. Am. 63, 681–684.
- Rockel, E.G. and Hansens, E.J. (1970b) Emergence and flight activity of salt-marsh horse flies and deer flies. Ann. Entomol. Soc. Am. 63, 27–31.
- Schulze, T.L. (1974) The effects of some environmental factors in the daily and seasonal movements of the salt marsh greenhead, *Tabanus nigrovittatus* Macquart (Diptera: Tabanidae). (Ph.D. thesis, Rutgers University, New Brunswick, N. J.) 70 p.
- Schulze, T.L., Hansens, E.J. and Trout, J.R. (1975) Some environmental factors affecting the daily and seasonal movements of the salt marsh greenhead, *Tabanus nigrovittatus*. Environ. Entomol. 4, 965–971.
- Service, M.W. (1973) Observations on the flight activities of *Chrysops caecutiens* L. Ann. Trop. Med. Parasitol. 67, 445–454.
- Shamsuddin, M. (1966) A *Bathymermis* species (Mermithidae, Nematoda) parasitic on larval Tabanidae. Quaest. Entomol. 2, 253–256.
- Sheppard, D.C., Wilson, B.H. and Hawkins, J.A. (1973) A device for self-marking of Tabanidae. Environ. Entomol. 2, 960–961.
- Siegfried, W.R. (1971) The food of the Cattle Egret. J. Appl. Ecol. 8, 447–468.
- Smith, G.E., Breeland, S.G. and Pickard, E. (1965) The Malaise trap - a survey tool in medical entomology. Mosquito News 25, 398–400.
- Snoddy, E.L. (1969) On the behavior and food habits of the cattle egret, *Bubulcus ibis* (L.). J. Georgia Entomol. Soc. 4, 156–158.
- Snoddy, E.L. (1970) Trapping deer flies with colored weather balloons (Diptera: Tabanidae). J. Georgia Entomol. Soc. 5, 207–209.
- Spencer, R.M. (1971) A mechanical approach to the abatement of the greenhead fly *Tabanus nigrovittatus*. Proc. N. J. Mosquito Exterm. Assoc. 58, 71–77.
- Spratt, D.M. and Wolf, G. (1972) A tachinid parasite of *Dasybasis oculata* (Ricardo) and *Dasybasis hebes* (Walker) (Diptera, Tabanidae). J. Aust. Entomol. Soc. 11, 260.
- Stammer, H.J. (1924) Die Larven der Tabanidae (Diptera). Ann. Entomol. Soc. Am. 23, 261–304.
- Sterling, C.R. and De Giusti, D.L. (1974) Fine structure of differentiating oocysts and mature

- sporozoites of *Haemoproteus metchnikovi* in its intermediate host *Chrysops callidus*. J. Protozool. 21, 276–283.
- Takahasi, H. (1962) Fauna Japonica: Tabanidae. (, .) 143 p.
- Tashiro, H. and Schwardt, H.H. (1953) Some natural enemies of horse flies in New York. J. Econ. Entomol. 46, 680–681.
- Teal, J.M. (1962) Energy flow in the salt marsh ecosystem of Georgia. Ecology 43, 614–624.
- Terteryan, A.Y. (1973) On the morphology of the male genitalia of horse flies (Diptera, Tabanidae) of the Armenian SSR. Entomol. Rev. 51, 345–354. (translation from Entomologicheskoe Obozrenie 51, 373–580).
- Teskey, H.J. (1962) A method and apparatus for collecting larvae of Tabanidae (Diptera) and other invertebrate inhabitants of wetlands. Proc. Entomol. Soc. Ontario 92, 204–206.
- Teskey, H.J. (1969) Larvae and pupae of some eastern North American Tabanidae (Diptera). No. 63. 147 p.
- Thomas, A.W. (1971) An apparatus and method for the field separation of tabanid larvae (Diptera: Tabanidae) from moss. Quaest. Entomol. 7, 407–408.
- Thomas, A.W. (1972) Physiological age structure of adult tabanid populations (Diptera: Tabanidae) in Alberta, Canada. J. Med. Entomol. 9, 295–300.
- Thomas, A.W. (1973) Follicle developmental stages in blood-seeking horseflies (Diptera: Tabanidae) in Alberta, Canada. J. Med. Entomol. 10, 325–328.
- Thompson, P.H. (1967) Tabanidae of Maryland. Trans. Am. Entomol. Soc. 93, 463–519.
- Thompson, P.H. (1969) Collecting methods for Tabanidae (Diptera). Ann. Entomol. Soc. Am. 62, 50–57.
- Thompson, P.H. (1970) Larvae Tabanidae (Diptera) of the Great Swamp, New Jersey. Ann. Entomol. Soc. Am. 63, 343–344.
- Thompson, P.H. (1971a) Tabanidae of Maryland, addenda (Diptera). Proc. Entomol. Soc. Wash. 73, 378–381.
- Thompson, P.H. (1971b) Larval Tabanidae (Diptera) of the Patuxent Wildlife Research Center, Laurel, Maryland. Ann. Entomol. Soc. Am. 64, 956–957.
- Thompson, P.H. (1972) Tabanidae of Patuxent Wildlife Research Center, Laurel, Maryland. The second year. (Diptera). Proc. Entomol. Soc. Wash. 74, 188–192.
- Thompson, P.H. (1973) Tabanidae (Diptera) of Texas. I. Coastal marsh species, West Galveston Bay; incidence, frequency, abundance and seasonal distribution. Proc. Entomol. Soc. Wash. 75, 359–364.
- Thompson, P.H. and Gregg, E.J. (1974) Structural modifications and performance of the modified animal trap and the modified Manitoba trap for collection of Tabanidae (Diptera). Proc. Entomol. Soc. Wash. 76, 119–122.
- Thompson, P.H. and Pechuman, L.L. (1970) Sampling populations of *Tabanus quinquevittatus* about horses in New Jersey, with notes on the identity and ecology. J. Econ. Entomol. 63, 151–155.
- Thornhill, A.R., Gilbert, J.P. and Hays, K.L. (1971) How far do horse flies and deer flies fly? Highlights Agric. Res., Auburn. Univ., Ala. 18, 5.
- Thornhill, A.R. and Hays, K.L. (1972) Dispersal and flight activities of some species of *Tabanus* (Diptera: Tabanidae). Environ. Entomol. 1, 602–606.
- Thorsteinson, A.J., Bracken, G.K. and Hanec, W. (1965) The orientation behaviour of horse flies and deer flies (Tabanidae, Diptera). III. The use of traps in the study of orientation of tabanids in the field. Entomol. Exp. Appl. 8, 189–192.
- Thorsteinson, A.J., Bracken, G.K. and Tostowaryk, W. (1966) The orientation behavior of horse flies and deer flies (Tabanidae: Diptera) V. The influence of the number and inclination of reflecting surfaces on attractiveness to tabanids of glossy black polyhedra. Can. J. Zool. 44, 275–279.
- Tidwell, M.A. (1973) The Tabanidae (Diptera) of Louisiana. Tulane Stud. Zool. Bot. 18, 1–95.

- Tidwell, M.A. and Hays, K.L. (1971) Oviposition preferences of some Tabanidae (Diptera). *Ann. Entomol. Soc. Am.* 64, 547–549.
- Tidwell, M.A. and Tidwell, M.A. (1973) Larvae and pupae of five eastern North American *Tabanus* species (Diptera: Tabanidae). *Ann. Entomol. Soc. Am.* 62, 390–398.
- Tidwell, M.A., Dean, W.D., Tidwell, M.A., Combs, G.P., Anderson, D.W., Cowart, W.O. and Axtell, R.C. (1972) Transmission of hog cholera virus by horseflies (Tabanidae: Diptera). *Am. J. Vet. Res.* 33, 615–622.
- Vorgetts, L.J., Jr. (1973) The use of box traps for studying populations of greenhead flies (*Tabanus nigrovittatus* Macq.). ( ) 97 p.
- Wall, W.J., Jr. (1973) The intertidal sand and salt marsh invertebrate fauna associated with the bloodsucking Diptera of Cape Cod, Massachusetts. *Environ. Entomol.* 2, 681–684.
- Wall, W.J., Jr. and Doane, O.W., Jr. (1960) A preliminary study of the bloodsucking Diptera on Cape Cod, Massachusetts. *Mosquito News* 20, 39–44.
- Wall, W. and Jamnback, H. (1957) Sampling methods used in estimating larval populations of salt marsh tabanids. *J. Econ. Entomol.* 50, 389–391.
- Wall, W.J., Jr. and Marganian, V.M. (1973) Control of salt marsh *Culicoides* and *Tabanus* larvae in small plots with granular organophosphorous pesticides, and the direct effect on other fauna. *Mosquito News* 33, 88–93.
- Wallace, F.G. (1966) The trypanosomatid parasites of insects and arachnids. *Exp. Parasitol.* 18, 124–193.
- Watanabe, M. and Kamimura, K. (1971a) Observations on the autogeny of horsefly, *Tabanus iyoensis* Shiraki. *Jap. J. Sanit. Zool.* 22, 170–176.
- Watanabe, M. and Kamimura, F. (1971b) Susceptibility of females of horsefly, *Tabanus iyoensis* Shiraki, to several insecticides. *Jap. J. Sanit. Zool.* 22, 69–73.
- Watanabe, M. and Kamimura, K. (1973) Attraction effect of the cylindrical sticky-dry ice trap to the horseflies (Diptera, Tabanidae). *Jap. J. Appl. Entomol. Zool.* 17, 109–111. (in Japanese)
- Wiesenhutter, E. (1975) Research into the relative importance of Tabanidae (Diptera) in mechanical disease transmission. III. The epidemiology of anaplasmosis in a Dar-es-Salaam dairy farm. *Trop. Anim. Health Prod.* 7, 15–22.
- Wilson, B.H. (1968a) Toxicity of selected insecticides against adult striped horseflies in laboratory tests. *J. Econ. Entomol.* 61, 1764–1765.
- Wilson, B.H. (1968b) Reduction of tabanid populations on cattle with sticky traps baited with dry ice. *J. Econ. Entomol.* 61, 827–829.
- Wilson, B.H. and Lieux, M. (1972) Pollen grains in the guts of field-collected tabanids in Louisiana. *Ann. Entomol. Soc. Am.* 65, 1264–1266.
- Wilson, B.H. and Meyer, R.B. (1966) Transmission studies of bovine anaplasmosis with the horseflies, *Tabanus fuscicostatus* and *Tabanus nigrovittatus*. *Am. J. Vet. Res.* 27, 367–369.
- Wilson, B.H. and Richardson, C.G. (1969) Tabanid hosts in estuarine and alluvial areas of Louisiana. *Ann. Entomol. Soc. Am.* 62, 1043–1046.
- Wilson, B.H., Tugwell, N.P. and Burns, E.C. (1966) Attraction of tabanids to traps with dry ice under field conditions in Louisiana. *J. Med. Entomol.* 3, 148–149.
- Wright, R.E., Anslow, R.O., Thompson, W.H., DeFoliart, G.R., Seawright, G. and Hanson, R.P. (1970) Isolations of LaCrosse virus of the California group from Tabanidae in Wisconsin. *Mosquito News* 30, 600–603.
- Zumt, F. (1945) Medical and veterinary importance of horse-flies. *S. Afr. Med. J.* 23, 359–362.

## Seaweed flies (Diptera: Coelopidae, etc.)

Terry Dobson

<b>Contents</b>		
16.1	Introduction	447
16.2	Systematics - Key to European Coelopidae	448
16.3	Biology	450
	16.3.1 Life histories	450
	16.3.2 Food	453
	16.3.3 Predators and parasites	454
16.4	Ecology	455
	16.4.1 Special adaptations	455
	16.4.2 Distribution	456
	16.4.3 Population dynamics	457
16.5	Special considerations	459
	16.5.1 Treatment of seaweed fly plagues	459
	16.5.2 Genetic studies in <i>Coelopa frigida</i>	460
	Acknowledgements	462
	References	462

### 16.1 INTRODUCTION

Many flies can be found on the beaches of the world — for instance, Egglshaw (1958) saw 30 species at one site in England and Backlund (1945) found 50 species in Sweden — but only a few species are specialized to live and breed exclusively on the beach and not merely to be found there as visitors.

The seaweed or kelp flies use for food and shelter the piles of seaweeds (called wrack-beds by Backlund (1945)) which are thrown up onto the beach by high tides and can lie there rotting for weeks or months. These wrack-beds can be found all

over the temperate and sub-arctic regions of the world but only the European and mainly the British situation will be described here.

The commonest seaweed flies are members of the family Coelopidae (Phycodromidae) all of which live only on the beach. They are usually inconspicuous and of little economic importance except as an occasional nuisance to human sun worshippers, so that until recently they have been the subjects only of simple descriptive work. Since Philip (1958) and Burnet (1959) pointed out the advantages of using coelopids for ecological genetics, the biology and genetics of these flies have been studied in greater detail.

In addition to the Coelopidae, a few other European flies specialize in life on seaweeds. The main species are the dryomyzid *Helcomyza ustulata* (Curt.) — a silver grey fly easily recognized by its characteristic darting flight — the muscid *Fucellia maritima* (Haliday), and the borborid *Thoracochaeta zosterae* (Haliday). Work on these species seems to be restricted to morphological and life history descriptions.

## 16.2 SYSTEMATICS

The Coelopidae is a family of acalyptrate Diptera which is in turn part of the sub-order Cyclorrhapha. The family characteristics are listed by Seguy (1934),

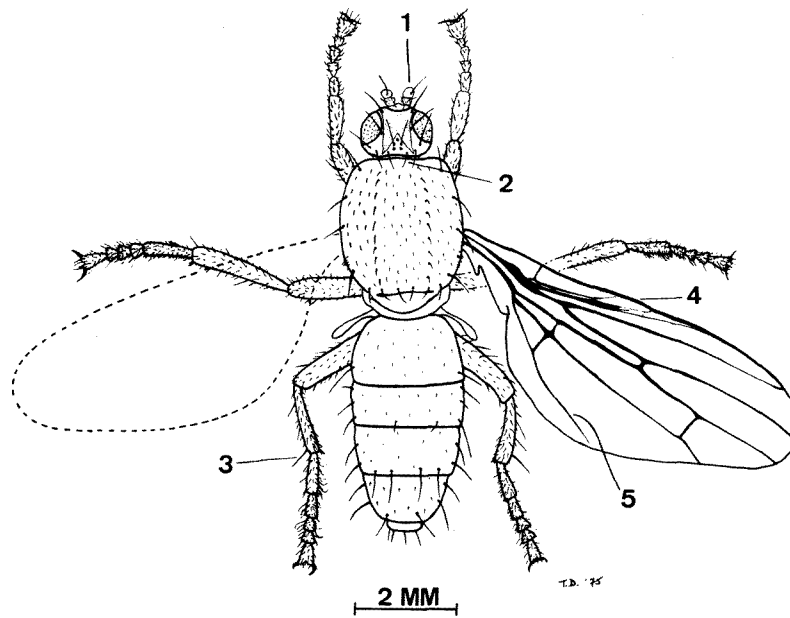

Fig. 16.1. Dorsal view of the coelopid *Coelopa frigida*. Note such features as: (1) The shortened antennae; (2) the convergent postvertical bristles; (3) the single preapical bristle on the tibia; (4) the unbroken costa; (5) the apically faint vein 6.

Hennig (1937), Hardy (1956) and by Colyer and Hammond (1968). They are small-to-medium sized, bristly and/or hairy, flattened flies with small eyes, short antennae and stout legs (Fig. 16.1).

Within the family there is still confusion over the identity and nomenclature of specimens from different parts of the world and a world-wide comparison of material is long overdue. I shall describe only the European members and refer the reader to the authors cited above and to Cole (1969) for material from other parts of the world. It remains to be seen whether the Coelopidae are a natural grouping or a heterogeneous collection characterized mainly by their specialized habitat.

European taxonomists after Seguy (1934) recognize four genera and five European species; the genera are distinguished by Seguy using the following key:

### KEY TO EUROPEAN COELOPIDAE

- |    |   |                    |
|----|---|--------------------|
| 1. | Metastigmatic bristles present near the posterior thoracic spiracles. No hairs on the hypopleural disc. Epistome not projecting (Fig. 16.3)                 | <i>Orygma</i>      |
|    | No metastigmatic bristles   | 2                  |
| 2. | Protarsus III short. Body dorso-ventrally flattened. Epistome projecting forwards making the head concave in profile. Hypopleural hairs present (Fig. 16.2) | <i>Coelopa</i>     |
|    | Protarsus III normal. Body not flattened  | 3                  |
| 3. | Tibia III with several long bristles or spines. 1st anal wing vein (no. 6) short and does not reach the edge of the wing                                    | <i>Orygma</i>      |
|    | Tibia III with only a single apical bristle. 1st anal wing vein reaches the edge of the wing  | 4                  |
| 4. | Peristomal bristles reduced. Epistome projecting as in <i>Coelopa</i> . Hypopleural hairs present   | <i>Malacomysia</i> |
|    | Peristomal hairs absent. Epistome not projecting. No hypopleural hairs  | <i>Oedoparea</i>   |

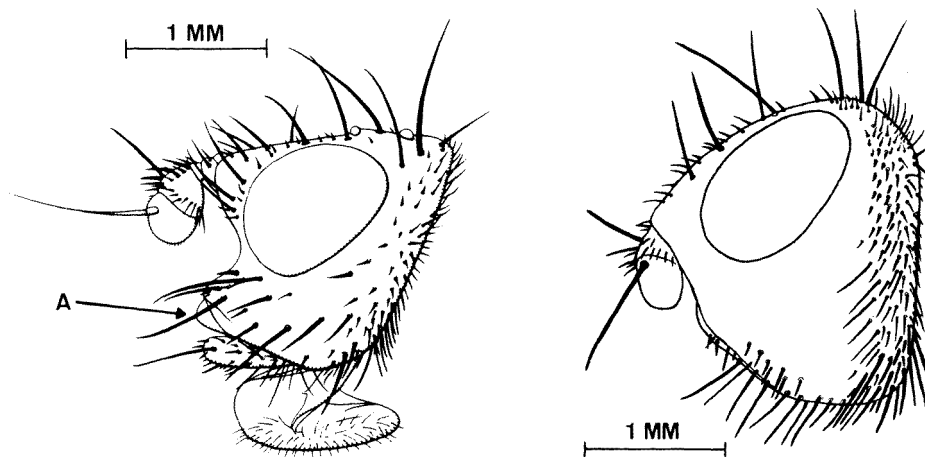

Fig. 16.2. Side view of the head of *Coelopa frigida*. Note the projecting epistome (A) (taken from Oldroyd, 1964)

Fig. 16.3. Side view of the head of *Orygma luctuosa*. (redrawn from Hennig, 1937).

Detailed descriptions of the adults of *C. frigida* and *C. pilipes* are given by Mayhew (1939) and by Burnet (1960). These publications also contain discussion of the wide range of size variation in *C. frigida* which led to the recognition of three varieties of this species by Hennig (1937) — *parvula*, *frigida* and *gravis* — which have been considered separate species by other authors. The chaetotaxy of the three forms was very different and seemed to fully warrant their separation at least into varieties, but it was shown that one form could be converted into another simply by regulating the amount of food available to the larvae. (This should provide a familiar warning to taxonomists. We must know the range of normal variation of a character before it is used to distinguish groups.)

The adults of *O. luctuosa* and *M. sciomyzina* are described by Hennig (1937) and the young stages of all the species except *M. sciomyzina* are described by Egglisshaw (1960a). There has been confusion in the past over the separation of the larvae of the *Coelopa* species but this has been resolved by Burnet (1961a).

Table 16.1 lists the common European seaweed flies.

Table 16.1 Common European seaweed flies.

---



---

Family — Coelopidae
<i>Orygma luctuosa</i> Meigen.
<i>Coelopa pilipes</i> Haliday ( <i>frigida</i> Meigen).
<i>Coelopa</i> (Fucomyia) <i>frigida</i> Fabricius ( <i>gravis</i> , <i>simplex</i> , <i>parvula</i> Haliday, <i>eximia</i> Stenhammar).
<i>Malacomyia</i> ( <i>Phycodroma</i> , <i>Malacomyza</i> ) <i>sciomyzina</i> Haliday.
<i>Oedoparea</i> ( <i>Heteromyza</i> , <i>Heterochila</i> ) <i>buccata</i> Fallen.
Family — Dryomyzidae
<i>Helcomyza ustulata</i> (Curt.).
Family — Muscidae
<i>Fucellia maritima</i> (Haliday).
Family — Borboridae
<i>Thoracochaeta zosteræ</i> (Haliday).

---

(Specific names in brackets are synonyms from Egglisshaw, 1960a).

## 16.3 BIOLOGY

### 16.3.1 Life histories

The life histories of some European seaweed flies are described by Egglisshaw (1960a,b,c) and Dobson (1974a). *Malacomyia sciomyzina* appears not to have been investigated and all that is known of *Thoracochaeta zosteræ* is that Richards (1930) found them all the year round.

All the species studied have six stages in their life cycle: egg, three larval instars, pupa and adult. Each stage is closely associated with the wrack-bed and the flies will probably not breed in any other natural substrate. Backlund (1945) divided wrack-beds into three types depending on the depth of the weed; wrack-banks, wrack-flakes and wrack-strings, in order of decreasing depth. The three types differ in the sort of decay that they undergo. In wrack-banks, the weed tends to decay rapidly and to heat up relative to outside temperatures, while in the shallower wrack-beds the weed tends to stay cool and to dry out. Different seaweed flies breed in different wrack-beds, and can be divided into those which breed more or less continually the year round, e.g. *Coelopa*, and those with longer, irregularly occurring cycles consisting of only a few generations each year.

### *Coelopidae*

*Coelopa frigida* and *C. pilipes* are found in Britain throughout the year although population sizes tend to drop in the summer. They continue to breed even in the hardest winters because they utilize the relatively constant environment deep in the rotting seaweed of wrack-banks. In places such as Britain with a wide tidal variation, wrack-beds are generally short lived and, although there is a large variation, many beds last in the region of 2–4 weeks. A typical *Coelopa* breeding cycle was described by Dobson (1974a).

Adult *Coelopa* are attracted to the wrack-bed within a few hours of deposition of the weed. The initial decay of the weed produces areas where the temperature is warmer than in the surroundings, and the eggs are laid here. (Burnet (1961b) showed that *C. frigida* chooses warm egg-laying sites in preference to cold, and that many more eggs are laid in warm than in cold conditions.) The newly hatched larvae attack the weed for food and so accelerate and spread the decay. This in turn attracts more egg-laying females, and so on. Provided that there are enough breeding adults, the whole of the inside of the wrack-bed may become a mass of developing larvae in warm decaying weed. The wrack-bank provides a warm and humid internal microclimate that is relatively independent of outside conditions because it is insulated by the drier surface layer of the weed. This has been strikingly demonstrated in winter when the beach may be covered in ice and snow, but digging 10–20 cm into the wrack-bank reveals a population of *Coelopa* enjoying temperatures up to 40°C.

All three larval instars live in the weed and pupation takes place in the drier areas of the wrack-bed. The development time varies with temperature, but Thompson (1951) gives the length of each stage in *C. frigida* under her standard culture conditions as: egg: 22.6 h; first instar: 22.3 h; second instar: 23.8 h; third instar: 96.6 h; pupa: 94.4 h; total: 11.47 days.

*C. pilipes* which is reluctant to breed in the Thompson medium, has a significantly longer development time than *C. frigida*,  $16.25 \pm 0.97$  days as against  $12.25 \pm 1.05$  days (Dobson, 1974b). The relatively short development time



required by these flies means that the breeding cycle can be completed in a short-lived wrack-bed, although the more slowly developing individuals may be washed away with the weed before they complete their development.

The life-span of a fly varies greatly in different conditions. They can easily be kept viable for 3–4 weeks in cold conditions in the laboratory, and marked individuals have been recovered three weeks after release on the beach. In a laboratory experiment at 27°C the death rate of newly hatched *C. frigida* was more or less linear with a half life of 6–10 days. A natural longevity of 2–4 weeks seems a reasonable estimate, although some flies may live considerably longer than this.

If the life of a *Coelopa* population were a simple series of non-overlapping breeding cycles it would provide a beautiful situation for ecological and genetical experiments. Unfortunately the real situation is more complex, with a great deal of variation from cycle to cycle. Some of the range of variation was described by Dobson (1974a).

In contrast to *Coelopa*, *Orygma luctuosa* and *Oedoparea buccata* have long breeding cycles. Egglisshaw (1960a) found the adults of *O. luctuosa* on the beach during April and May, and again in September, with larvae present in May, September and October. He suggested that there were only two generations a year, with the pupae overwintering. This idea was supported by the experiment in which flies were reared in the laboratory at 'room temperature'. In summer, the pupal stage lasted less than two weeks, but in winter it lasted more than four months. The *Orygma* larvae are found in the deep wrack-beds but generally only in the well-decayed and compressed weed in which *Coelopa* has already bred, and not in the warm conditions found when decay is at its height.

Egglisshaw (1960a) found *Oedoparea buccata* common only for one period in the year, from October to January, although small numbers might occur in the spring. He thought that more than one generation probably occurred during this period and that the larvae from January eventually gave rise to adults the following October. The larvae were found only in the wrack-flake and string, not in the wrack-banks, and only on *Laminaria*, not on *Fucus* which was equally common.

### *Dryomyzidae*

Egglisshaw (1960c) found the adults of *Helcomyza ustulata* only twice during the year, approximately in June and September, and the larvae only from June to October. He suggested that, like *Orygma*, there were only two generations a year. The June adults were the parents of the July and August larvae which developed into the September adults. These September adults then produced larvae in September and October, but these larvae did not emerge as adults until the following June. Larvae collected on the beach in June and reared in the laboratory at 'room temperature' produced adults in September after approximately four weeks pupation, but September larvae treated in the same way produced adults

the following April or May, after 3–4 months pupation. The animals probably overwinter as pupae although Egglisshaw could not find any pupae on the beach in winter. The larvae of this species were found only in the drier wrack-flake and string, never in the deep wrack-banks inhabited by *Coelopa*.

### *Muscidae*

*Fucellia maritima* was studied by Egglisshaw (1960b) who found that the adults only occurred during the summer. They first appeared in March, were common till September and a few remained until November. Full grown larvae were found from April to October so that there may have been several generations, but the larvae from September and October did not emerge as adults until the following year. This was shown in the laboratory by collecting September larvae which, when kept at ‘room temperature’, pupated in October and emerged as adults the following February. Like those of *H. ustula*, the larvae of *F. maritima* were found only in the shallow drier wrack-beds.

#### 16.3.2 Food

The little that is known about the food of the seaweed flies mostly concerns *C. frigida*. The larvae of this species pass large quantities of weed through their guts, but Backlund (1945) showed that the larvae died within a few hours if the eggs were allowed to hatch on sterile weed. This suggests that the larvae need microorganisms to survive, either eating them directly or feeding on some product released by their break down of the weed. Rowell (1969) showed that there was a characteristic bacterial infection that invades the gut of larval *C. frigida* within a few hours of their hatching, and it is possible that *Coelopa* itself carries this infection from wrack-bed to wrack-bed. He was also able to culture the larvae of a British *C. frigida* population on a synthetic, sterile medium developed for *Drosophila*, by adding a small amount of an aqueous extract from decaying seaweed. The important factors in this extract were not identified and may come either from the seaweed or from the microorganisms. Remmert (1957), found populations of *C. frigida* in Germany requiring different culture conditions, one type requiring animal matter mixed with seaweed while the other needed only weed.

Dobson (1974b) found that *C. pilipes* needs a mixture of *Fucus* and *Laminaria* in which to breed, while *C. frigida* needs only *Laminaria*. The difference seems to depend upon the conditions in which the adults will lay eggs, since when *C. pilipes* eggs are transferred onto *Laminaria* they develop into adults.

There is no information about the food of the larvae of other species, and while they all appear to ingest some seaweed, they may have very different food requirements.

Even less is known about the food of the adults. The two *Coelopa* species imbibe

liquids from the surface of the seaweed but nothing is known about what they actually utilize. Burnet (1961b) found that the adults survive better in the laboratory if they are provided with a 3% solution of mannitol, a sugar which is present in seaweeds. *Fucellia maritima* is the only fly which can be found congregated in large numbers on decaying animal matter on the beach, such as dead fish. This may mean that this species feeds on animal matter instead of, or in addition to, seaweed.

Several attempts have been made to breed the seaweed flies in the laboratory. *F. maritima* (Egglisshaw, 1960b), *Orygma luctuosa*, *Oedoparea buccata* and the two *Coelopa* species (Egglisshaw, 1960a), breed easily in seaweeds similar to those in which they are found on the beach. Burnet and Thompson (1960) standardized the culture medium for *C. frigida* using *Laminaria* collected on the beach, but the use of weed collected in this way introduces age and seasonal variations in the condition and chemical composition of the weed (Black, 1948). Rowell's (1969) experiments with synthetic media were an attempt to make a truly standard medium, but although eggs seeded onto his medium developed successfully, the adults would not lay eggs directly onto it. A compromise medium developed in the Genetics Department of Nottingham University, England, has been used for genetical studies of *C. frigida*. High protein baby food and a commercial dried seaweed called Marinure are added to a *Drosophila* maize/agar culture medium. Adult *C. frigida* will lay eggs onto this medium and the larvae will develop in approximately two weeks at 27°C. The medium is reasonably standard, at least within each batch of Marinure, and yields are good. The yield can be improved, with some loss in standardization, by adding one or two pieces of *Laminaria* which induces the adults to lay more eggs. Using the Nottingham medium, stocks of *C. frigida* have been kept in the laboratory for more than 30 generations, and stable population cages can be maintained.

### 16.3.3 Predators and parasites

The presence of large numbers of larvae and adult flies in the wrack must provide a useful food resource, but only a few predators and parasites are known, and nothing is known of their quantitative relationships. The larvae, and probably the adults, are eaten by shore birds, especially when there is no weed to conceal them. But, while the birds can be seen searching in the wrack-beds, they are unlikely to penetrate more than a few centimetres into the weed and so they will miss a large part of the population. Holes can sometimes be seen burrowed into the wrack-bed, presumably by small mammals which may feed on the seaweed flies, but there is no direct evidence.

Backlund (1945) found many carnivorous insects in the wrack-bed fauna and showed that some of them would eat dipteran larvae under laboratory conditions. He also found Coleoptera and Hymenoptera parasitizing the larvae and pupae,

sometimes with very high levels of infection. (For instance, in a sample of 144 *Orygma luctuosa* pupae collected on the west coast of Sweden, only 20 produced adult *Orygma*, and a total of 769 parasites emerged from the remainder.) Egglshaw (1960a) reported the presence of a phoretic mite *Thinoseius fucicola* on the two *Coelopa* species. Infestations can be so great that the whole fly seems to be encrusted in an armour of mites, but nothing is known of the effects of the infestation.

## 16.4 ECOLOGY

### 16.4.1 *Special adaptations*

The seaweed flies are probably adapted to their specialized habitat in a host of ways, but the only feature that has received much attention is their differing ability to survive wet conditions.

This ability is most pronounced in the *Coelopa* species which can be found in very wet decaying wrack-beds. Egglshaw (1960c) reports that *Helcomyza ustulata* adults will stick to any wet surface while *C. frigida* can crawl, without sticking, through tightly packed layers of mucilaginous weed. The adults of *C. frigida* are so waterproof that they can easily escape if the wrack-bed is swamped by the sea; they simply bob up to the surface and fly back to dry land. They can be shaken violently in a container of seawater and still not be wetted.

In several papers, Egglshaw suggested that the presence of hairs on the posterior spiracles, and spines on the ventral surface of the larvae of *C. frigida*, *C. pilipes*, and *O. luctuosa* are adaptations to the wet wrack-beds that they inhabit, and that the absence of these structures in *H. ustulata* and *F. maritima* restricts these species to the drier weed. There seems to have been no further investigation of this interesting possibility.

Finally, the larvae of the *C. frigida* have been shown to be resistant to immersion in seawater (Dobson, 1974a). Larvae were left in aerated seawater at 10°C for up to 144 hours and although their development was arrested while they were in the water, when they were removed and put onto *Laminaria*, they developed normally. This resistance is obviously useful to a species which is continually threatened with being washed into the sea. Many larvae have been seen to be washed away by the tides only to be returned to the beach in fresh weed and to continue developing. It may well be that this is an alternative dispersal mechanism to adult flight, since the larvae could be carried for considerable distances before they are washed back onto the beach.

The adults of *C. frigida* are strongly attracted to seaweed, presumably by the odour, and this may have a curious side effect. Oldroyd (1954) says that the organic solvents chloroform, trichloroethylene and carbon tetrachloride are 'irresistably

attractive to the flies'. This attraction could be the explanation for the occasional infestations of *Coelopa* in such places as chemist's shops, dry cleaners and jewellers which have in common the use of organic solvents. However, Burnet (personal communication) failed to demonstrate the attraction in the laboratory, and when the present author tried to use these chemicals as bait in insect traps on the beach, the flies were reluctant to leave the weed for the rival odour.

#### *16.4.2 Distribution*

Seaweed flies are naturally enough restricted to areas where seaweeds grow, particularly to where the brown kelps occur. This largely restricts them to temperate and sub-arctic regions. However, Hardy (1956) reported *Coelopa palauensis* from the equatorial Palau Islands.

The most widely distributed species is *C. frigida*, which is found throughout northern temperate and sub-arctic latitudes, from Alaska through the eastern U.S.A., Greenland and Iceland, to Europe and the far east. Whether this is truly the same species remains to be seen, especially since Remmert (1957) found sibling species of *C. frigida*, morphologically identical but unable to interbreed, only a few hundred miles apart in Germany. Remmert (1965) also showed that the distribution of wrack-bed flies depends upon the types and quality of seaweed present. For instance, he reported that 'red algae are poisonous for species such as *Coelopa* and *Fucellia*', and also that the weeds from the Gulf of Bothnia must have their salinity increased before *Orygma* and *Coelopa* will breed in them.

Coelopids are usually found only on the coast and breeding seems to be restricted to wrack-beds. Oldroyd (1954) discusses the suggestions that *C. frigida* breeds inland on compost heaps and other decaying vegetable matter, but concludes that this is unlikely. The distribution of *Coelopa* populations around Britain was given by Dobson (1974a). The flies were found to be distributed as a series of semi-isolated sub-populations (colonies) centered on beaches where wrack-beds are more or less continually cast up. This broken distribution is predictable in an animal which requires deep piles of weed to breed in. Other flies which breed in smaller piles of weed may have a more continuous distribution along the coastline.

The amount of migration between the *Coelopa* colonies is very variable. Particularly in winter, the flies are lethargic and move very little even within the colony site. Adults are generally inconspicuous, staying hidden inside the wrack-beds or under stones and vegetation on the beach, so that it is possible to walk past a large population without realizing that it is there. In warm weather the flies are more active and occasionally they perform mass flights which can be restricted to the vicinity of the wrack-bed or may develop into migrations of several kilometres. In the migrations reported by Egglisshaw (1961) and Dobson (1974a), the animals only flew along the coast and did not penetrate more than

a few metres inland. However, Oldroyd (1954) quoted Miall as saying that they occasionally fly a few miles inland and visit flowers, and Oldroyd himself found *C. frigida* on one occasion as far inland as Oxford, over 100 kilometres from the sea. The cause of the migrations is not clear. They seem to require the presence of large populations of *Coelopa* and of particularly warm calm weather. Under these conditions it is possible to generate a mass flight by disturbing the flies, but these flights are short lived and usually do not develop into migrations. Whatever the cause, the migrations have the double importance of relieving the breeding pressures on large populations and also of spreading the animals to colonize new sites.

### 16.4.3 Population dynamics

Only in the *Coelopa* species in Britain has there been any attempt to investigate the population dynamics of the seaweed flies. Two problems have been tackled, the study of population size and distribution, and the interaction of the two species of *Coelopa* in the wrack-bed habitat. In Britain, *Coelopa* colonies always contain a mixture of *C. frigida* and *C. pilipes*.

At first sight it may seem easy to measure population size of *Coelopa*, since the colonies occur in small, easily definable sites. However, the flies are often so lethargic that in a release/recapture study the marked individuals do not spread evenly through the colony (Dobson, 1974a). Resorting to estimates based on numbers of animals found in the same collecting sites on different occasions, Dobson showed that there were wide fluctuations in population size. At times, fresh wrack-beds could lie on the colony site without any flies being attracted to them, while at other times the beach seemed alive with flies. On a beach 180 metres long, Dobson estimated an adult population size of 50-100,000 with a similar number of larvae developing on the wrack-bed. This density was not unusual and apparently higher densities can be seen. In general the *Coelopa* population sizes are largest in autumn and winter when most weed is thrown up onto the beach. In summer the numbers are reduced and other seaweed flies emerge to take their place.

Perhaps more striking than absolute population size is the speed with which the size can change. The larval population can be completely destroyed by being washed out to sea. The adults, with a longevity of 2-4 weeks or more, cannot be reduced so quickly, but if a series of reproductive cycles are interrupted by the larvae being washed away, then the numbers are gradually reduced by death without replacement.

The increase in population size can be equally rapid. Thomson (1951) found that each female *C. frigida* could lay three clutches of up to 80 eggs each and that mortality is low under good breeding conditions. Thus there is a potential increase of over 100-fold in a single breeding cycle.

Not only does population size fluctuate, but the amount of weed deposited on the beach, which provides breeding space, also varies. Together these produce enormous changes in the crowding conditions experienced by the larvae. Thompson (1951) showed that there was an optimum larval density in her laboratory cultures and that over and under this density mortality increased. This is probably also true in natural wrack-beds. *C. frigida*, but possibly not *C. pilipes*, has a buffering mechanism which to some extent reduces this density-dependent mortality. This is the ability to produce a wide range of adult size (from 4–9 mm long) dependent upon the amount of food available. Thus, for instance, mildly over-crowded conditions will cause little mortality but the offspring will be smaller than average.

The interaction of *C. frigida* and *C. pilipes* is an intriguing ecological problem. All the British colonies are mixtures of the two species intermingled both as adults and as larvae. There is no fixed proportion. The mixture can vary from almost totally *C. frigida* to almost totally *C. pilipes* in neighbouring colonies only a few kilometres apart at one time, or in one colony at different times. Egglshaw (1960a) found that in the colony he investigated at Whitburn in N.E. England, there was a rapid seasonal changeover from mostly *C. frigida* in autumn and winter to mostly *C. pilipes* in spring and summer (Fig. 16.4). Dobson (1974b) found the

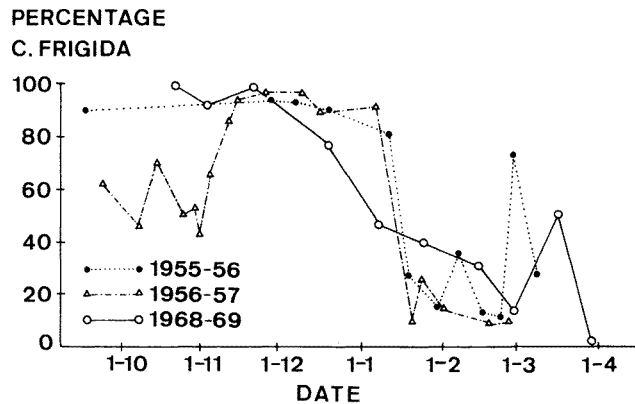

Fig. 16.4. The species composition of the *Coelopa* colony at Whitburn in N.E. England over the three winters 1955–56 and 1956–57 (from Egglshaw, 1960a) and 1968–69 (from Dobson, 1974b). Note the general similarity of the pattern on the three occasions.

situation to be more complex. He studied several colonies and found that no two of them showed exactly the same pattern (Fig. 16.5). He suggested the following mechanisms to explain the variations in the proportions of the two species:

1. *C. frigida* is the faster developer, which might give it an advantage if wrack-beds are removed before all the larvae have emerged as adults.

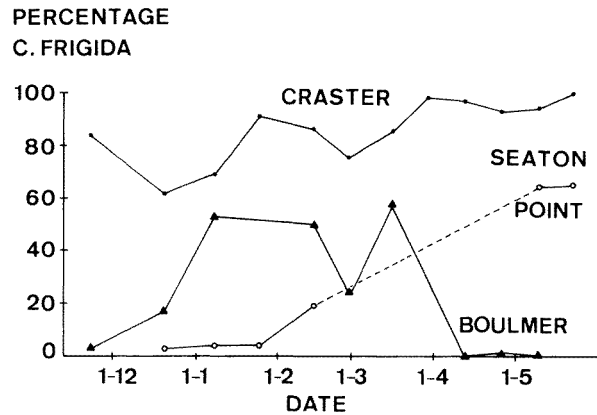

Fig. 16.5. The species composition of three *Coelopa* colonies on a 17-Km length of the N.E. coast of England during the winter 1968–69. Note the different patterns in these three neighbouring colonies.

2. The two species require different breeding conditions. *C. pilipes* needs both *Fucus* and *Laminaria* while *C. frigida* needs only *Laminaria*.
3. *C. frigida* may be the more active of the two species, which would give it an advantage in colonizing newly deposited wrack-beds.

At best these three mechanisms could only provide a partial explanation of the patterns of variation found in nature, and much more remains to be explored of the interaction between the species. Particularly interesting is the possibility that the different patterns at each colony may be stable over long periods, e.g. at Whitburn (Fig. 16.4) the seasonal alternation observed by Egglisshaw (1960a) in 1955–6 and 1956–7, and Dobson (1974b) in 1968–9, were similar.

## 16.5 SPECIAL CONSIDERATIONS

### 16.5.1 Treatment of seaweed fly plagues

The 'Great Seaweed Fly Plague' in S.E. England during 1953–4 (Oldroyd, 1954) is the most extreme example of the occasional plagues of *Coelopa*, which, to the causal observer, appear from nowhere in seaside towns, last for a few days or weeks, and just as mysteriously disappear. These plagues are simply the peaks of the natural variation in the population size of the flies, possibly coupled with mass migration. Since few people realize that the flies are always there in smaller numbers, the sudden appearance of large numbers of flies takes on a frightening aspect. Faced with a sudden plague, local medical officers, probably encouraged by their tourist office, have tended to over-react, and to order indiscriminate



spraying with insecticides and disinfectants, or as reported in 1954, to attack the flies with flame throwers! In this light it seems worth setting down a few simple guidelines for the treatment of plagues.

Firstly, the local authority should learn to identify the flies so that the plagues can be recognized and not confused, for instance, with corn flies or horse flies, both of which can be a local nuisance.

Luckily the health hazard is small, the flies are not disease vectors, and, despite the cries of tourists, they do not bite. The application of simple rules of hygiene, such as covering food, will eliminate what hazard there is.

Unfortunately there is no way to predict with certainty the occurrence of a plague. It is as well for towns that have suffered in the past to check regularly for large piles of rotting seaweed on their beaches, since these may herald the flies. Nonetheless, even if a large population breeds in the weed, it can stay quiescent and pass completely unnoticed. On the other hand, the absence of weed will not prevent the immigration of flies from the coast.

The flies' habit of migrating means that there is no economic way to prevent the plagues totally. Keeping local beaches clear of deep piles of weed will help, but it is not practical to keep the entire coast clear.

In dealing with the flies when they occur, the simplest solution is to wait the few days or weeks until they disappear naturally. If this is not possible, then any of the usual mild insecticides can be used effectively, although treatments should obviously be kept to a minimum.

The most important measure is to prevent the flies from breeding. Since all the indications are that they will not breed inland (unless farmers and gardeners are transporting seaweed as manure), attention can be concentrated on the beaches. As much weed as possible should be cleared back into the sea (not just piled onto the local refuse dump) and particularly any piles of weed over a few centimetres deep should be cleared or at least spread out so that the decay conditions in which *Coelopa* breeds will not occur. If this is done then the plagues should be at most a short-lived nuisance.

### *16.5.2 Genetic studies in Coelopa frigida*

Beach flies, like other littoral organisms, present an especially interesting case in population genetics, since they generally occupy an essentially one-dimensional habitat which may extend for thousands of kilometres in length but only a few metres in width. Gene flow is thus limited to to-and-fro movements, rather than spreading over intricately contiguous or overlapping areas; and this may modify patterns of evolution (as well as potentially simplifying mathematical models!).

*C. frigida* has many features that make it a useful organism with which to study the genetics of such natural populations. It has a restricted distribution so that its populations can be defined and their ecology easily studied. It breeds all year

round, has a short generation time, all the stages of the life history can be sampled and it can be bred rapidly in the laboratory.

The first genetical investigations were by Thompson (1951) who inbred the flies collected from natural populations to search for recessive visible mutations. She found several wing and eye mutants but suggested that the frequency of individuals carrying recessive mutations ( $6/64 = 9.4\%$ ) might be smaller than the frequency found in natural populations of other groups such as *Drosophila*. Spencer (1947) found approximately 20% of *D. subobscura* carried visible recessives but the figures vary greatly in other groups.

Following this work Burnet (1961b, 1962) looked at recessive lethals in *C. frigida*, described the effects of several lethal genes and measured their frequencies in natural populations. In interpreting his results Burnet drew attention to the problem of estimating the effective population size of *Coelopa* colonies. The effective population size is only equal to the true population size when there is random mating, constant population size, equal numbers of each sex, and a Poisson distribution of progeny number. Burnet showed that in the case of *Coelopa* none of these requirements was fulfilled and that the effective population sizes might be very different for different colonies even when the true population sizes were the same.

More recently studies on chromosomal variation and isoenzymes have been carried out on the coelopids. Philip (unpublished) found *C. frigida*, *C. pilipes* and *Orygma luctuosa* to have 6 pairs of chromosomes each, 5 pairs with median centromeres, and a single dot-shaped pair. There is no obvious sexual dimorphism and it is not known whether the sex-controlling genes are scattered or concentrated into one place. All three species have large, banded polytene chromosomes in the salivary glands and other tissues. The appearance of the polytene strands differs between the species due to the presence of varying amounts of hetero-chromatin. *C. frigida* has a compact, heavily staining heterochromatin region on one chromosome, while *C. pilipes* has relatively more heterochromatin which is scattered on different chromosomes, although it still stains heavily. In contrast, *O. luctuosa* has no evident heterochromatin. A striking difference between the species is that the structure of the chromosomes of *C. pilipes* and *O. luctuosa* is relatively uniform, while in *C. frigida* there are a number of polymorphic forms. The differing forms are due to the presence of several chromosome inversions. Inversions are found on at least three chromosomes but only the situation on Chromosome I will be described here. This chromosome has two different sequences known as  $\alpha$  and  $\beta$ , one the standard arrangement and the other the result of three overlapping inversions. None of the intermediate sequences which presumably once existed have been found, so that natural populations in Britain contain animals with three Chromosome I karyotypes -  $\alpha\alpha$ ,  $\beta\beta$  and  $\alpha\beta$ . Since a large part of the chromosome has been rearranged, crossing over between the  $\alpha$  and  $\beta$  forms must be greatly reduced.

It is well known that most organisms have polymorphic forms of an appreciable proportion of their enzymes and *C. frigida* is no exception. The enzymes that have been most intensively studied in *C. frigida* are an alcohol dehydrogenase (Adh) found both in the adult and in the larvae, and an esterase found mainly in the larvae (Nottingham group, unpublished). Each of these enzymes has been shown to be the product of a single gene locus, but there are at least four alternative alleles for each gene so that many different genotypes are found in any population. There is still discussion about the role of enzyme polymorphisms, particularly about whether they have selective effects. The properties of the different genotypes are being studied to see if they might be selective in the *Coelopa* environment. For instance, it has been shown that the different genotypes at both loci are associated with different rates of development of the animals from egg to adult. As mentioned earlier, development rate may be of importance to an animal which inhabits wrack-beds continually threatened with being washed away. However, while it is simple to show an association of genotype and development rate, it is much more difficult to show that the differing development rates are in fact the result of the enzyme genotypes.

The whole problem of variation in *C. frigida* has become even more interesting since it was shown that the enzyme genotypes studied by the Nottingham group are not randomly associated with the chromosomal forms found by Philip. For instance, the commonest alleles of the Adh locus, **B** and **D**, are almost always found together with the  $\alpha$  and  $\beta$  chromosome forms, respectively. It remains to be seen why this association exists, whether it is simply the result of an historical accident or whether it indicates the presence of different, co-adapted gene series on Chromosome I held together within the region of suppressed crossing over.

### ACKNOWLEDGEMENTS

I am grateful to Ursula Philip for permission to quote her unpublished data on chromosomal variations, and to Margaret Bathgate, Bryan Clarke, Thomas Day, Philip Hillier and David Parkin from the Genetics Department, Nottingham University, England, for permission to use unpublished information on isoenzymes.

### REFERENCES

- Backlund, H.O. (1945) The wrack fauna of Sweden and Finland. Opusc. Entomol. suppl. V.
- Black, W.A.P. (1948) The seasonal variation in chemical composition of some sub-littoral seaweeds common to Scotland. J. Soc. Chem. Ind. Lond. 69, 165–168, 172–176.
- Burnet, B. (1959) Eco-genetic studies in some littoral Diptera. Challenger Soc. Annu. Rep. 3, 11.
- Burnet, B. (1960) The European species of the genus *Coelopa*. (Dipt., Coelopidae). Entomol. Mon. Mag. 96, 8–13.

- Burnet, B. (1961a) The larvae of *Coelopa frigida* (F.) and *C. pilipes* (Dipt., Coelopidae). Entomol. Mon. Mag. 96, 178–180.
- Burnet, B. (1961b) On the distribution of recessive embryonic lethals in a natural population of *Coelopa frigida* (Fab.). Genet. Res. (Camb.) 2, 249–271.
- Burnet, B. (1962) Manifestation of eight lethals in *Coelopa frigida* (F.). Genet. Res. (Camb.) 3, 405–416.
- Burnet, B. and Thompson, U. (1960) Laboratory culture of *Coelopa frigida* (F.). Proc. R. Entomol. Soc. Lond. (A) 35, 85–89.
- Cole, F.R. (1969) *The Flies of Western North America*. (, .)
- Colyer, C.N. and Hammond, C.O. (1968) *Flies of the British Isles*. 2nd. edn (, .)
- Dobson, T. (1974a) Studies on the biology of the kelp-fly *Coelopa* in Great Britain. J. Nat. Hist. 8, 155–177.
- Dobson, T. (1974b) Mechanisms controlling species composition in natural populations of the seaweed-fly *Coelopa*. J. Nat. Hist. 8, 653–673.
- Egglislaw, H.J. (1958) The fauna of wrack-beds. (Ph.D. Thesis. University of Durham.)
- Egglislaw, H.J. (1960a) Studies on the family Coelopidae (Diptera). Trans. R. Entomol. Soc. Lond. 112(6) 109–140.
- Egglislaw, H.J. (1960b) The life-history of *Fucellia maritima* (Haliday) (Diptera, Muscidae). Entomologist Nov., 225–231.
- Egglislaw, H.J. (1960c) The life-history of *Helcomyza ustulata* (Curt.) (Diptera, Dryomyzidae). Entomol. Mon. Mag. 96, 39–42.
- Egglislaw, H.J. (1961) Mass migrational flights of *Coelopa frigida* (Fabricius) and *C. pilipes* Haliday (Diptera, Coelopidae) and *Thoracochoeta zosterae* Hal. (Diptera, Sphaeroceridae) Entomologist Jan., 11–18.
- Hardy, D.E. (1956) Coelopidae. In: *Insects of Micronesia*. 14(2) 41–46. (, .)
- Hennig, W. (1937) Coelopidae. In: *Die Fliegen der Palaearktischen Region*. (E. Lindner, Ed.) 5(52) Stuttgart, pp. 1–29.
- Mayhew, A.W. (1939) Studies on the structure and life-history of shore flies of the genus *Coelopa*. (.)
- Oldroyd, H. (1954) The seaweed fly nuisance. *Discovery* 15, 198–202.
- Oldroyd, H. (1964) *The Natural History of Flies*. (, .)
- Philip, U. (1958) Genetics and cytology of the seaweed-fly *Coelopa frigida* (Fab.). Proc. Xth. Congr. Genet. Montreal.
- Remmert, H. (1957) Ecological separation of species in *Coelopa*. *Nature* 179, 788.
- Remmert, H. (1965) Distribution and ecological factors controlling distribution of the European wrack fauna. Bot. Gothobergensia III. Proc. V Marine Biol. Symp., Gotheborg. 179–184.
- Richards, O.W. (1930) The British species of Sphaeroceridae (Borboridae, Diptera). Proc. Zool. Soc. Lond. 18, 261–345.
- Rowell, M.J. (1969) Studies on the laboratory culture, anatomy and nutritional requirements of *Coelopa frigida* (Fabricius). (Ph.D. Thesis, Univ. Durham.)
- Seguy, E. (1934) *Fauna de France*. 28, Muscidae-Acalypterae et Scatophagidae. (Paris) pp. 308–313.
- Spencer, W.P. (1947) Mutations in wild populations in *Drosophila*. Adv. Genet. I, 359–401.
- Thompson, U. (1951) Studies on the genetics and ecology of *Coelopa frigida* (Fabricius). (Ph.D. Thesis, Univ. Durham.)

## Shore flies and brine flies (Diptera: Ephydriidae)

Karl W. Simpson

<b>Contents</b>		
17.1	Introduction	465
17.2	Systematics	466
	17.2.1 General morphology	466
	17.2.2 Brief synopsis of family	466
	17.2.3 Marine representatives	472
	17.2.4 Keys to genera	472
17.3	Biology	479
	17.3.1 Brief review of literature	479
	17.3.2 Life history	481
	17.3.3 Mating	482
	17.3.4 Oviposition	483
	17.3.5 Adult feeding habits	483
	17.3.6 Larval feeding habits	484
	17.3.7 Pupation	485
17.4	Ecology	486
	17.4.1 Natural enemies	486
	17.4.2 Special adaptations	487
	17.4.3 Habitat distribution and dispersal	491
	Acknowledgements	492
	References	492

### 17.1 INTRODUCTION

The Ephydriidae is one of the most diverse and interesting families of cyclorrhaphous Diptera. Its members occur worldwide and are well represented in nearly every shallow aquatic and semi-aquatic habitat imaginable. They are commonly

found along the shorelines of most still and running waters and are often extremely abundant in saline and alkaline waters - hence the common names 'shore flies' and 'brine flies'. The majority of species occur in quiescent habitats where the adults are sheltered from the wind and the larvae are protected from turbulent water currents.

The larvae are aquatic or semi-aquatic and occur in many different microhabitats. Some thrive in such seemingly inhospitable habitats as strong mineral waters, thermal springs, and pools of crude petroleum. The most wide-spread larval feeding habit is the filtering of microorganisms from such semi-liquid media as decaying plant and/or animal material, feces, or moist shore muds. Other species feed on living plants, on other invertebrates, and on the egg masses of spiders and frogs.

The adults are small or minute in size (1–16 mm), dull in color, with prominent face and gaping mouth. They are generally semi-aquatic, living on or near the larval habitat where they walk about on the surface of the mud or water or climb on low, emergent vegetation. Most adults feed on unicellular algae and other microorganisms, although some are polyphagous and others predaceous.

## 17.2 SYSTEMATICS

### *17.2.1 General morphology*

It is beyond the scope of this work to present a detailed morphological discussion of the taxonomic terminology for the Diptera. Most of the characters used in the keys are illustrated in Figs 17.1–17.5. For additional information the reader is referred to introductory entomology texts such as Borror and DeLong (1971) and the glossary of Torre-Bueno (1937). Detailed morphological discussions of adult ephydrids have been published by Clausen and Cook (1971) for *Parydra* and Deonier (1971) for *Hydrellia*.

### *17.2.2 Brief synopsis of family*

In general, adult ephydrids can be distinguished from other acalyprate flies by the following characters: the presence of 2 distinct breaks in the costal vein, 1 at the humeral crossvein and 1 just before the end of  $R_1$  (Fig. 17.5); anal cell absent;  $R_1$  ending before middle of the wing; discal and second basal cells united. Characters other than those of wing venation include: arista bare, pubescent, or pectinate (short ventral branches are present only in *Ptilomyia* and *Asmeringa*); mesopleura hairy; preapical bristles never present on first and third tibiae; and post-vertical bristles divergent or absent (Sturtevant and Wheeler, 1954). Some typical adult ephydrids are shown in Figs 17.6–17.10.

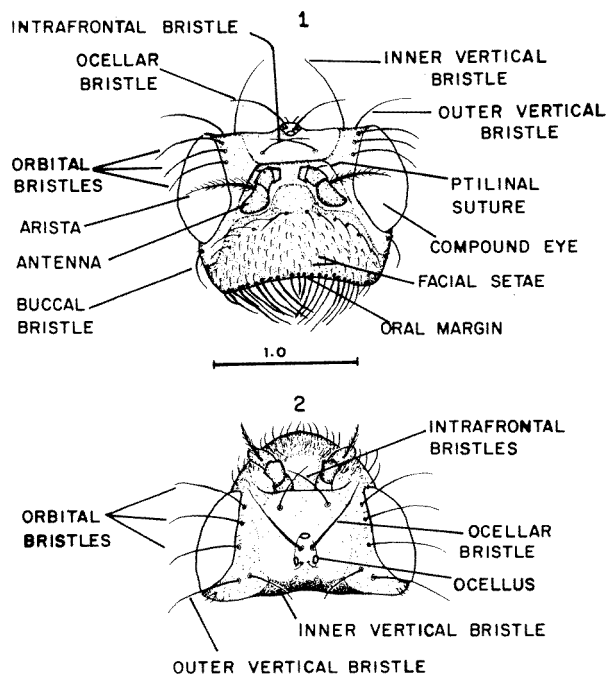

Figs. 17.1-2. Head of *Ephydra subopaca*. (1) anterior view; (2) dorsal view. Scale in mm.

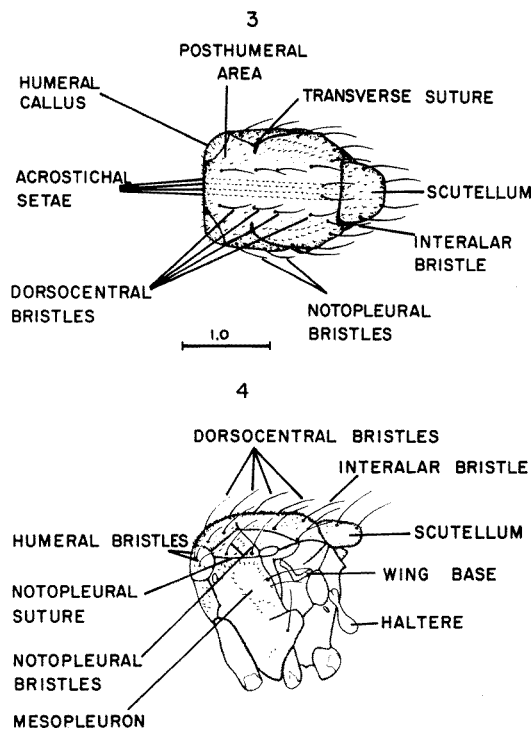

Figs. 17.3-4. Thorax of *Ephydra subopaca*. (3) dorsal view; (4) lateral view. Scale in mm.

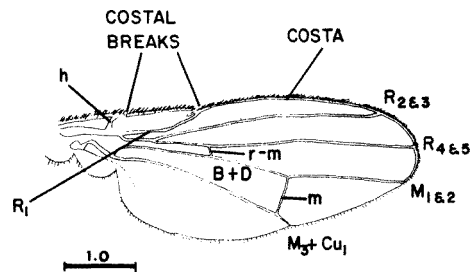
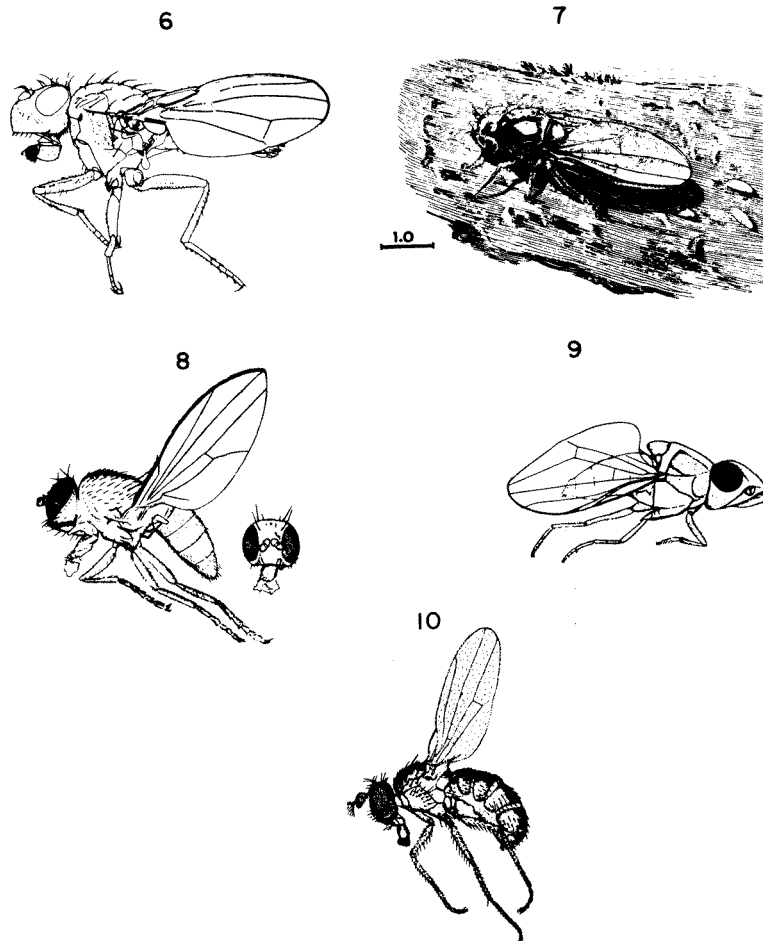

Fig. 17.5. Wing of *Ephydra subopaca*, dorsal view. Scale in mm.



Figs. 17.6–10. Adults of Ephyridae. (6) *Ephydra packardi*, reproduced with permission - Deonier (1964b); (7) *Scatella oahuense* (Williams, 1938); (8) *Atissa litoralis* (Cole, 1912); (9) *Lipochaeta slossonae* (Cole, 1912); (10) *Hydrellia philippina* (Ferino, 1958). Scale in mm.



The taxonomy of adult Ephydriidae is fairly well advanced in the Holarctic region but elsewhere many species have yet to be described. The basic classification of the family was first laid down by Loew (1860) and expanded by Becker (1926). Our present classification which differs somewhat from the earlier scheme, was established by Cresson (1942, 1944, 1946, 1949) in a series of synopses devoted to the family. His death in 1948 prevented the completion of his revisionary work, but Sturtevant and Wheeler (1954) admirably finished the chore. At present, 4 subfamilies of Ephydriidae are recognized: Ephydrinae, Notiphilinae, Parydrinae, and Psilopinae. The North American fauna consists of over 250 species in 68 genera.

Our knowledge of the immature stages is less than impressive. Of the world fauna only 62 species of 19 genera have been described in 1 or more developmental stage (B.A. Foote, personal communication). Johannsen (1935) presented descriptions, illustrations and a key for selected larvae and puparia in 10 genera. Wirth and Stone (1956) used the descriptions published by Hennig (1943) to construct one of the few existing keys for ephydrid larvae, which included just 10 of the 68 Nearctic genera. At present, larval descriptions are available for only 11 of the marine genera.

The larvae (Figs 17.11–17.19) are more or less typical cyclorrhaphous maggots being generally subcylindrical in shape with a bluntly pointed anterior end. The somewhat transparent integument is variously wrinkled, tuberculated, and covered with numerous small setae. Unlike larvae of the lower Diptera, the head is not clearly differentiated from the thorax, and there is no sclerotized head capsule. The mouthhooks are parallel, move in a vertical plane, are palmate or digitate below, and are not joined behind the mouth opening (except in some *Hydrellia*, where the mouthhooks are fused together). The anterior spiracles are usually palmate (Fig. 17.28), but are club-shaped in *Ochthera* (Fig. 17.29) and absent in *Hydrellia*. The posterior spiracles are located on well-separated, sclerotized, often cap-like discs, borne at the end of a more or less elongate, sometime branched or retractile air tube.

The most easily recognized larvae are those of the Tribe Ephydrini (*Cirrula*, *Ephydra* and *Dimecoenia*, which have abdominal prolegs, elongate air tubes, and dorsal markings (Figs 17.11 and 12).

Of all other acalyptrates, beach flies of the Family Canaceidae are most likely to be mistaken for ephydrids. The adults (Fig. 17.20) are quite ephydrid-like, especially in the structure of the head, but have important differences in wing venation. The costa is not broken at the humeral crossvein and the second basal and the anal cells are complete (Fig. 17.21). The larvae (Fig. 17.22) differ from the ephydrids primarily in having an unbranched posterior air tube and one well-developed, spinose, anal proleg (Wirth and Stone, 1956). There are only 5 North American species in 3 genera, and they are almost exclusively intertidal in habit (Wirth, 1951; Wheeler, 1952; Wirth and Stone, 1956). Williams (1938) reported

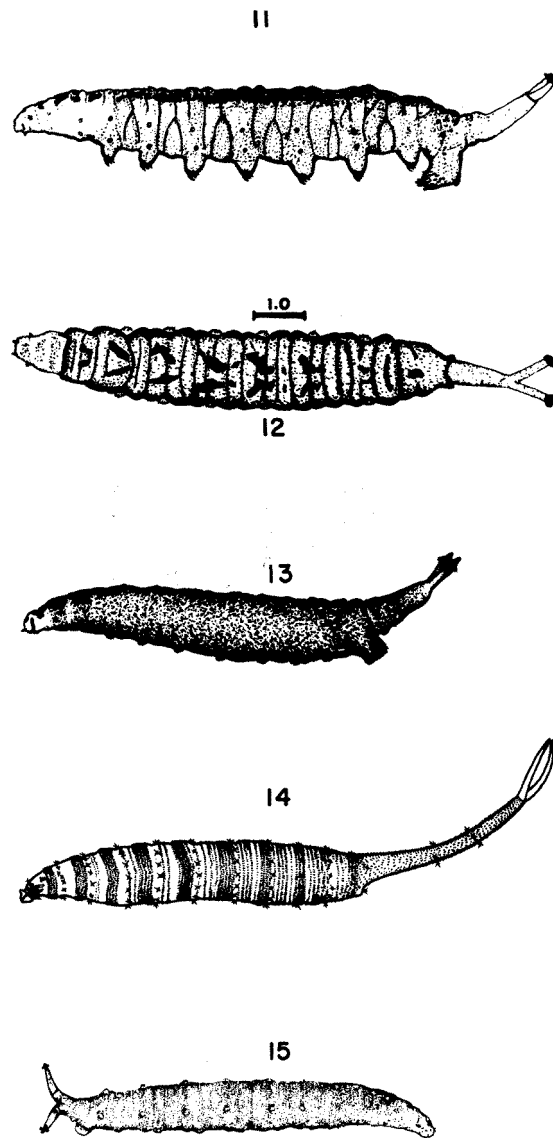

Figs. 17.11–15. Larvae of subfamily Ephydrinae. (11, 12) *Ephydra subopaca* (Simpson, 1973); (13) *Dimecoenia spinosa* (Simpson, 1973); (14) *Paracoenia fumosa* (Beyer, 1939); (15) *Scatella oahuense* (Williams, 1938). Scale in mm.

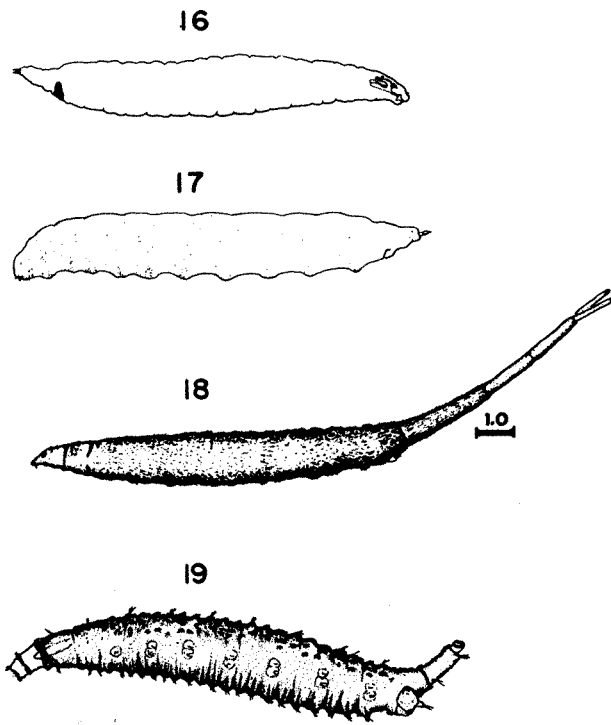

Figs. 17.16–19. Larvae of subfamilies Notiphilinae and Parydrinae. (16) *Notiphila loewi* (Berg, 1950); (17) *Hydrellia griseola* (Grigarick, 1959); (18) *Ochthera mantis* (Simpson, 1975); (19) *Brachydeutera argentata* (Johannsen, 1935). Scale in mm.

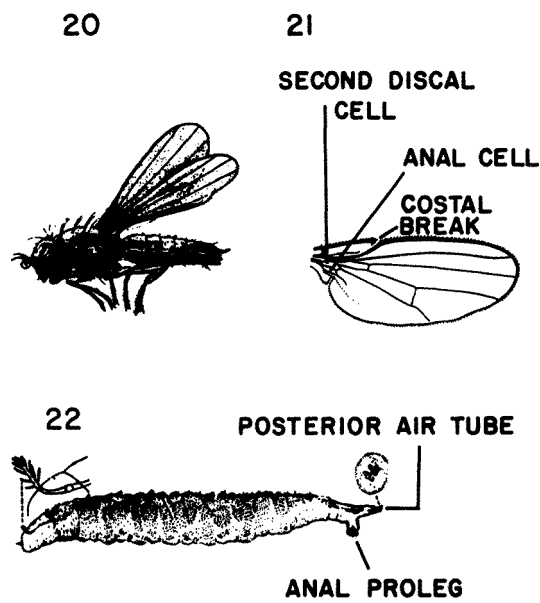

Figs. 17.20–22. Family Canaceidae. (20) adult of *Procanace nigroviridis* (Williams, 1938); (21) Wing of *Canace* sp. (Curran, 1965); (22) larva of *Canaceoides nudatus* (Williams, 1938). Same scale as above.

that, under favorable conditions, one species literally swarms on the tidal rocks of Hawaiian seacoasts.

### 17.2.3 *Marine representatives*

Records of marine distributions were obtained from articles by Williams (1938), Sturtevant and Wheeler (1954), Dahl (1959), Wirth (1965, 1971), Deonier (1971) and Clausen and Cook (1971) and supplemented with distribution records from the collection of the United States National Museum in Washington, D.C. (courtesy of Dr. W.W. Wirth). Of the 68 genera of Nearctic Ephydriidae recognized by Wirth (1965), 36 contain species found in marine habitats. The genera and marine species are listed in Table 17.1, along with notes on their ecological and geographical distribution.

The subfamily Ephydrinae with 10 marine genera includes some of the most abundant and ecologically important members of coastal saltmarshes and inland mineral waters - *Ephydra*, *Dimecoenia*, and to a lesser extent *Cirrula*. The adults of these genera are accomplished water-skaters, and may often be found on the calm water surfaces of saltmarshes and tidal pools. The larvae and puparia are easily recognized by their elongate posterior breathing tube, 8 pairs of prolegs, and dark dorsal markings.

There are 5 genera of marine Parydrinae, of which *Parydra* is the most abundant and ecologically important. The larvae inhabit littoral or supralittoral mud and probably feed on algae and bacteria. *Ochthera* is predaceous in both the larval and adult stages. *Brachydeutera* adults are water-skaters, and the larvae are scavengers in shallow stagnant water.

In the subfamily Notiphilinae there are three marine genera, two of which are strongly dependent on macrophytes in the larval stages. *Hydrellia* adults are polyphagous and the larvae mine macrophytic vegetation. Larvae of *Notiphila* live and feed in saltmarsh mud amongst the roots of aquatic macrophytes, which they tap for oxygen.

Although the subfamily Psilopinae contains 18 of the 36 genera of marine shore flies, only fragmentary biological information is available for its members, due to their smaller size and lesser abundances. Most larvae probably live in plant and animal detritus, although some may be leaf miners.

### 17.2.4 *Keys to genera*

The following key for adults has been adapted from Sturtevant and Wheeler (1954) to include only genera with marine representatives. Some terminology has been updated and a few characters have been added from Wirth and Stone (1956). Five genera (*Axysta*, *Gastrops*, *Hyadina*, *Pelina* and *Philygria*) are included that do not appear in Table 17.1. Their occurrence in marine habitats is possible, but has not been substantiated.

Marine shore flies (Diptera: Ephydriidae) of North America, excluding inland species. Compiled from Wirth (1965), supplemented where noted.

Genus	Total no. of species in North America	Generalized marine habitat	Generalized larval habits	Information supplemental to Wirth (1965)	Marine species	Nearctic distribution
<b>SUBFAMILY EPHYDRINAE (15 Nearctic genera)</b>						
<b>Tribe Ephydrini</b>						
<i>Cirrula</i>	1	Saltmarshes	Microphagous in floating algal mats	Simpson, 1973	<i>gigantea</i> Cresson	Newfoundland to New York
<i>Ephydra</i>	16	Saltmarshes & hypersaline coastal lagoons	Microphagous in floating algal mats	Wirth, 1971; Simpson, 1973	<i>cinerea</i> Jones <i>millbrae</i> Jones <i>obscuripes</i> Loew	California, Mexico, Texas British Columbia to Mexico Alaska; eastern Canada & north-eastern United States Quebec to North Carolina Virginia to Texas; Mexico & California
<i>Dimecoenia</i>	3	Saltmarshes	Microphagous, 2 spp. in mud, 1 in algal mats	Steyskal, 1970; Simpson, 1973	<i>subopaca</i> Loew <i>austrina</i> (Coquillett) <i>fuscifemur</i> Steyskal <i>spinosa</i> (Loew)	Virginia, Georgia Widespread along Atlantic, Gulf & Pacific coasts
<b>Tribe Scatellini</b>						
<i>Coenia</i>	1	Saltmarshes & wrack beds		Dahl, 1959	<i>curvicauda</i> (Meigen)	Alaska to New Hampshire, south to Massachusetts
<i>Paracoenia</i>	5	Saltmarshes	Scavengers, also feed on algae	Mathis, pers. comm.; Dahl, 1959	<i>biserota</i> (Coquillett)	British Columbia to Ontario, south to Massachusetts, Texas, Mexico, California
<i>Lamproscatella</i>	7	Seashores & saltmarshes	Scavengers(?)	Sturtevant and Wheeler, 1954; Dahl, 1959; Mathis, pers. comm.; Scheiring, pers. comm.	<i>fumosalis</i> Cresson <i>dichaeta</i> (Loew) <i>quadrisetosa</i> (Becker) <i>salinaria</i> (S & W)* <i>sibilans</i> (Haliday)	Alaska to Ontario, south to Virginia & California Washington to Nova Scotia, south to North Carolina, Mississippi, California Alaska to Greenland, south to New Brunswick & California California, Oregon Alaska to Quebec, south to California
<i>Neoscatella</i>	3	'Saline areas'		Sturtevant and Wheeler, 1954; Scheiring, pers. comm. Wirth, pers. comm.	<i>obscuriceps</i> (Cresson) <i>setosa</i> (Coquillett)	Massachusetts to Florida Alaska to Newfoundland, south to Alabama & California
<i>Parascatella</i>	3			Wirth, pers. comm.	<i>marinensis</i> Cresson <i>melanderi</i> Cresson <i>favillacea</i> Loew <i>obscura</i> Williston <i>obsoleta</i> Loew	Washington, California Quebec south to Florida & Texas Florida Alaska to Quebec, south to Florida & California
<i>Scatella</i>	12	Stagnant ponds, marshes, mud flats, wet beach sand, tidal rocks	Scavengers, also feed on algae	Williams, 1938; Sturtevant and Wheeler, 1954; Scheiring, pers. comm.		

Table 17.1 (continued)

Genus	Total no. of species in North America	Generalized marine habitat	Generalized larval habits	Information supplemental to Wirth (1965)	Marine species	Nearctic distribution
<i>Scatophila</i>	22	Sea beaches, saltmarshes	Feed on algae, esp. diatoms	Bolwig, 1940	<i>pallidum</i> (Meigen) <i>picea</i> (Walker) <i>stagnalis</i> (Fallén) <i>mesogramma</i> (Loew)	British Columbia to Ontario, south to California & Texas Northwest Territories to Labrador, south to Washington, Louisiana & Florida Entire of North America Alaska, Northwest Territories, Labrador to Maryland
SUBFAMILY NOTIPHILINAE (11 Nearctic genera)						
<i>Hydrellia</i>	57	Seashores, saltmarshes	Mine leaves and stems of aquatic macrophytes	Deonier, 1971	<i>agitator</i> Deonier <i>americana</i> Cresson <i>griseola</i> (Fallén) <i>valida</i> Loew	Florida, Georgia, Mississippi Maine to Mississippi, California Entire of United States & Canada Nova Scotia to Florida & Texas Washington
<i>Notiphila</i>	29	Saltmarshes	Microphagous in mud, tapping macrophytic roots for oxygen	Varley, 1937; Mathis, pers. comm.	<i>aenigma</i> Cresson <i>bispinosa</i> Cresson <i>erythropera</i> Loew <i>furcata</i> (Coquillett) <i>occidentalis</i> Cresson <i>nudus</i> (Coquillett)	Nova Scotia to Florida New Jersey to Florida, California Virginia to Florida & Louisiana Alaska to California California to Mississippi, Mexico
<i>Oedenops</i>	1	Seashores				
SUBFAMILY PARYDRINAE (13 Nearctic genera)						
<i>Parydra</i>	34	Saltmarshes	Inhabit mud, scavengers or algal feeders	Clausen & Cook, 1971	<i>copis</i> Clausen & Cook <i>imitans</i> Loew	Pacific northwest Eastern United States & Canada, Atlantic & Gulf coasts
<i>Lipochaeta</i>	1	Sea beaches			<i>penisica</i> Clausen & Cook <i>transversa</i> Cresson <i>slossonae</i> Coquillett	Pacific northwest Florida Massachusetts to Florida, Mexico & California
<i>Asmeringa</i>	1	Seashores			<i>lindsleyi</i> S & W*	California
<i>Ochthera</i>	8	Saltmarshes	Predaceous on chironomid larvae (Diptera)	Simpson, 1975	<i>tuberculata</i> Loew	Massachusetts to Florida & Texas
<i>Brachydeutera</i>	3	Tidal pools, saltmarshes	Scavengers in stagnant standing water	Williams, 1938; Sturtevant and Wheeler, 1954; Wirth, 1964	<i>argentata</i> (Walker)	California to Ontario & Florida

## SUBFAMILY PSILOPINAE (29 Nearctic genera)

<i>Mostillus</i>	3	Seashores	Wirth, 1969	<i>stegmaieri</i> Wirth <i>tibialis</i> Cresson	New Jersey to Florida, Mexico British Columbia to Quebec, south to California, Florida & Mexico Washington to California Alaska south to California & Florida
<i>Artisa</i>	2	Sea beaches	Sturtevant and Wheeler, 1954	<i>itorafis</i> (Cole) <i>pygmaea</i> (Haliday)	Pennsylvania to Florida & Texas Atlantic & Gulf states, California Florida Massachusetts to Maryland
<i>Ptilomyia</i>	6	Seashores	Wirth, pers. comm.	<i>mabelae</i> (Cresson)	
<i>Pseudohecamede</i>	3	Seashores	Wirth, pers. comm.	<i>abdominalis</i> (Williston) <i>facialis</i> Hendel	
<i>Hecamede</i>	1	Seashores, moist sand & low-growing vegetation	Bohart & Gressitt, 1951	<i>albicans</i> (Meigen)	
<i>Glenanthe</i>	2	Saltmarshes	Scavengers in excre- ment & on decaying animals		
<i>Diphuia</i>	1	Seashores	Sturtevant and Wheeler, 1954	<i>fascipennis</i> S & W* <i>litorea</i> Cresson	Texas Alaska to California, New Bruns- wick to Florida & Texas New York, Florida
<i>Pelignellus</i>	1	Seashores	Sturtevant and Wheeler, 1954; Wirth, pers. comm.	<i>nitida</i> S & W*	California
<i>Hydrochasma</i>	4	Seashores	Sturtevant and Wheeler, 1954	<i>subnudus</i> S & W*	
<i>Polytrichophora</i>	4	Saltmarshes	Wirth, pers. comm. Simpson, unpublished	<i>buccatum</i> (Cresson) <i>agens</i> Cresson <i>conciata</i> Cresson	New Jersey to Florida Maine to Texas Quebec south to Florida & California Florida
<i>Paratissa</i>	1	Seashores 'on seaweed'	Sturtevant and Wheeler, 1954 (as <i>pollinosa</i> )	<i>semilutea</i> (Loew)	
<i>Discomyza</i>	2		Wirth, pers. comm.	<i>maculipennis</i> (Wiedemann) <i>u-signata</i> Cresson	California Texas Western North America & Atlan- tic & Gulf states
<i>Clanoneurum</i>	1	'Saline habitats'	Scavengers on dead molluscs		
<i>Psilopa</i>	6		Scavengers(?)	<i>flavida</i> Coquillett <i>nigrimana</i> (Williston)	Maine to Texas Texas, Florida
<i>Leptopsilopa</i>	4			<i>similis</i> (Coquillett) <i>costalis</i> Wirth	Texas to Florida Virginia, Florida
<i>Ceropsilopa</i>	7		Wirth, pers. comm.	<i>staffordi</i> Cresson <i>aeneonigra</i> (Loew)	Georgia to Texas, California Massachusetts to Georgia, Louisiana, Texas New York to Texas Florida
<i>Cressonomyia</i>	4				
<i>Clasiopella</i>	1	Mangrove swamps	Wirth, pers. comm.	<i>hinei</i> (Cresson) <i>uncinata</i> Hendel	

\* = Sturtevant &amp; Wheeler, 1954.

For species identifications of the adults, the keys of Cresson (1942, 1944, 1946, 1949) and Sturtevant and Wheller (1954) should be used except for the following genera: *Athyroglossa* (Wirth, 1970), *Brachydeutera* (Wirth, 1964), *Dimecoenia* (Steyskal, 1970), *Ephydra* (Wirth, 1971, 1975), *Hydrellia* (Deonier, 1971), *Mosillus* (Wirth, 1969), *Parydra* (Clausen and Cook, 1971) and *Typopsilopa* (Wirth, 1968b). California species can be keyed in Wirth and Stone (1956).

The key for larvae has been slightly modified from Wirth and Stone (1956). The only accurate manner in which to identify the species and/or genera not included in the key is to rear the larvae and identify the emergent adults.

## KEYS TO THE GENERA OF MARINE EPHYDRIDAE IN NORTH AMERICA

### ADULTS

- |     |  |                       |
|-----|--|-----------------------|
| 1.  | Face hairy centrally and along oral margin (Fig. 17.1 + 2)   | 2                     |
|     | Face bare centrally and along oral margin  | 11                    |
| 2.  | Costa reaches only to or barely beyond end of 3rd vein ( $R_4 + 5$ ); wing and mesonotum usually with dark and light pattern                                     | <i>Scatophila</i>     |
|     | Costa reaches to 4th ( $M_1 + 2$ ) vein  | 3                     |
| 3.  | A pair of large interalars present but with no true dorsocentrals; facial bristles in dense group near center of face; large species; northeastern North America | <i>Cirrula</i>        |
|     | At least one pair of true dorsocentrals in addition to the interalars (Fig. 17.3 + 4); facial bristles not as above; size various                                | 4                     |
| 4.  | Pulvilli absent or nearly so, basal tarsal segment of third legs with dense long yellow hairs underneath; claws nearly straight                                  | 5                     |
|     | Pulvilli evident; no dense yellow hairs beneath basal tarsal segment of 3rd legs; claws curved   | 6                     |
| 5.  | No posthumeral bristles; 2 diverging orbitals; costa pectinate   | <i>Dimecoenia</i>     |
|     | Posthumeral bristles present (Fig. 17.3 + 4); 3 or more diverging orbitals   | <i>Ephydra</i>        |
| 6.  | Not more than 2 pairs of true dorsocentrals; disc of scutellum bare; arista usually bare or short plumose  | 7                     |
|     | 3 or 4 pairs of true dorsocentrals; disc of scutellum hairy; arista longer plumose   | 10                    |
| 7.  | Buccal margin with hairs but with no single markedly longer bristle; wings not spotted; arista with short branches or bare                                       | <i>Lamproscatella</i> |
|     | A strong buccal bristle near posterior end of cheek; wings usually with white or clear spots   | 8                     |
| 8.  | No presutural acrostichal bristles; postsutural acrostichal hairs strong to scutellum; presutural dorsocentrals strong   | <i>Parascatella</i>   |
|     | With a pair of strong presutural acrostichal bristles; posterior acrostichal hairs weak, irregular, often absent; presutural dorsocentrals present or absent     | 9                     |
| 9.  | Presutural dorsocentrals strong  | <i>Neoscatella</i>    |
|     | No presutural dorsocentrals  | <i>Scatella</i>       |
| 10. | Humeral bristles reduced; 3 pairs of dorsocentrals; head much longer than high in profile  | <i>Coenia</i>         |
|     | Humeral bristles well developed; 4 pairs of dorsocentrals; head about as high as long in profile   | <i>Paracoenia</i>     |
| 11. | Second tibia with 1 to 3 well-developed bristles on basal 2/3 of extensor surface  | 12                    |



	Second tibia without differentiated extensor bristles, though there may be numerous, rather long hairs	13
12.	Costa reaches to or a little beyond $R_4 + 5$ ; facials hairlike, thinner than ocellars; brown or ashy-grey species	<i>Notiphila</i>
	Costa reaches to $M_1 + 2$	<i>Oedenops</i>
13.	Antennae small, widely separated, situated in cavities; arista rudimentary; eyes hairy; face very short, bristles mostly absent (Fig. 17.9)	<i>Lipochaeta</i>
	Antennae normal in size and position, arista clearly evident; otherwise not as above	14
14.	First femora greatly enlarged, their greatest width nearly 2/3 their length; fore tibiae ending in strong apical spurs	<i>Ochthera</i>
	First legs of usual structure	15
15.	Eyes pear-shaped, strongly narrowed below	<i>Glenanthe</i>
	Eyes round or oval	16
16.	Head in profile at least 3 times as high as thick; wings short and broad, scarcely reaching tip of abdomen; scutellum broad and flat	17
	Head not remarkably high and thin; wings usually longer, scutellum not exceptionally flat	18
17.	Second vein ( $R_2 + 3$ ) bent toward margin; posterior crossvein (m) strongly bent at middle	<i>Clanoneurum</i>
	$R_2 + 3$ and m of usual type	<i>Discomyza</i>
18.	At least one well-developed pair of presutural dorsocentrals	19
	No presutural dorsocentral evident	22
19.	2nd antennal segment with a spinous bristle on upper apical corner; small dark species, wings with crossveins somewhat clouded; face with a pair of upturned bristles near base of median prominence	<i>Ptilomyia</i>
	Apical bristle of 2nd antennal segment weak or absent; otherwise not as above	20
20.	Posterior notopleural bristle at least 4 times as far from the notopleural suture as the anterior one; if the latter is absent, the former is well removed from the suture; arista bare or quite short pubescent	<i>Philygria</i>
	Posterior notopleural bristle closer to the notopleural suture	21
21.	Mouth opening small, clypeus hidden or visible at most along anterior edge; arista long pectinate to plumose above	<i>Hydrellia</i>
	Mouth opening large and cavernous; clypeus evident along sides as well as in front; arista pubescent to short pectinate	<i>Parydra</i>
22.	Arista pectinate, though sometimes small and the branches pale and difficult to see	28
	Arista bare or pubescent, rarely somewhat long haired	23
23.	Antennae depressed into deep cavities; middle of face with a prominent bare shining black tubercle; orbitals and ocellars absent or minute	<i>Mosillus</i>
	Antennae usually not depressed in cavities; middle of face without shining tubercle; orbitals and ocellars evident or not	24
24.	2nd antennal segment with 1 to several spinous bristles on inner apex; small velvety ashygrey species	<i>Pelignellus</i>
	No strong apical bristles on 2nd antennal segment	25
25.	No evident orbital bristles, no anterior notopleural	<i>Hyadina</i>
	At least one well-developed orbital bristle	26
26.	Face carinate, convex in profile, most prominent in middle; costa ends at $R_4 + 5$	<i>Axysta</i>
	Face flat or only weakly carinate in profile; in profile most prominent either at oral margin or just below antennae; costa reaches to $M_1 + 2$	27
27.	Facial bristles usually all small; face flat or carinate, not medianly prominent; mouth opening small to moderate, clypeus tongue-like; tergites usually grossly sculptured, roughened, or pitted	<i>Pelina</i>

	At least 1 facial bristle; face protuberant, the oral margin anterior to the antennal bases; mouth opening large and gaping, clypeus transversely elongate and exposed; tergites relatively smooth though somewhat pollinose	<i>Parydra</i>
28.	Costa reaching to $R_4 + 5$ or barely beyond it; mesonotum and front velvety brown	<i>Brachydeutera</i>
	Costa reaches to $M_1 + 2$	29
29.	2nd antennal segment with 1 to several spinous bristles on inner apex	31
	No strong apical bristles on second antennal segment	30
30.	At least one pair of true dorsocentrals; face densely pollinose	<i>Hydrellia</i>
	Interalar pair strong but without true dorsocentrals; face, front, and mesonotum thinly pollinose	<i>Gastrops</i>
31.	Posterior notopleural bristle at least 4 times as far from notopleural suture as is the anterior notopleural	32
	Posterior notopleural about as near the notopleural suture as is the anterior notopleural	38
32.	No distinct orbitals or ocellars evident, the front with small hairs only; tiny, whitish species	<i>Asmeringa</i>
	At least the reclinate orbital and usually the ocellars well developed	33
33.	A pair of intrafrontals well anterior to anterior ocellus; ocellars small, sometimes indistinguishable from hairs	37
	No intrafrontals; ocellars at most very slightly anterior to anterior ocellus (no further than diameter of ocellus)	34
34.	Mesonotum and face opaque, ashy-grey	35
	Mesonotum more or less shining; face at least in part shining; clypeus small, inconspicuous; face with white stripes	<i>Diphua</i>
35.	Face concave in profile, most prominent at oral margin	<i>Atissa</i>
	Face convex in profile, most prominent near its middle	36
36.	2nd costal section (between $R_1$ and $R_2 + 3$ ) less than 1.5 times as long as 3rd (between $R_2 + 3$ and $R_4 + 5$ ); a pair of upturned facial bristles near the facial hump	<i>Ptilomyia</i>
	2nd costal section more than 1.5 times as long as 3rd; no upturned facials	<i>Pseudohecamede</i>
37.	Face with a conspicuous, shining, black tubercle	<i>Hecamede</i>
	Face prominent below, without shining black area; no median tubercle	<i>Pelignellus</i>
38.	Halteres usually dark; wings yellow with base usually blackish; ocellars small, set between posterior ocelli	<i>Cressonomyia</i>
	Halteres white or pale yellow; ocellars large or small, usually anterior to posterior ocelli	39
39.	With a distinct pair of well-developed intrafrontal bristles, proclinate and parallel, anterior to the small ocellars; acrostichal hairs thick, in numerous rows	<i>Paratissa</i>
	Without conspicuous intrafrontals	40
40.	Ocellars clearly behind the anterior ocellus; face usually shining centrally, rarely somewhat carinate above	42
	Ocellars never behind anterior ocellus, usually anterior to it though rarely at about the same level; face usually pollinose to cinereous	41
41.	Face with a series of upcurved bristles in addition to the usual facials; notopleural area with hairs as well as bristles	<i>Polytrichophora</i>
	Notopleural area setulose; abdomen wholly cinereous, not at all shining	<i>Hydrochasma</i>
42.	Antennae elongate; basal segment clearly evident, nearly or quite as long as its width; 3rd antennal segment elongate, more or less cylindrical	<i>Ceropsilopa</i>
	Antennae normal, basal segment much shorter than its diameter	43
43.	Face with fine wrinkles; 1st metatarsi black and somewhat thickened	<i>Leptopsilopa</i>
	Face smooth; first metatarsi of usual structure, not thickened	<i>Psilopa</i>

## LARVAE

1.	Each posterior spiracular plate ending in a sharp, pointed spur (Fig. 17.25 + 26)	2
	Posterior spiracular plates flat or cap-shaped, not ending in a spur-shaped process (Fig. 17.23 + 24)	4
2.	Each spiracular plate with 3 slitlike openings; anterior spiracles absent	3
	Each spiracular plate with 4 openings, or 4 linear rows of openings; anterior spiracles well-developed and palmate (Fig. 17.26)	<i>Dimecoenia</i> (part)
3.	Pharyngeal skeleton with dorsal bridge and hypostomal sclerites fused in a slender, common sclerite (Fig. 17.34), the posterior cornua rodlike; mouthhooks usually fused; miners in aquatic plants	<i>Hydrellia</i>
	Pharyngeal sclerite with separate, small, hypostomal sclerites, a well-differentiated dorsal bridge and broad posterior cornua; paired mouthhooks present (Fig. 17.33); usually attached to roots of aquatic plants	<i>Notiphila</i>
4.	Posterior respiratory tube short, basal unbranched part as short as the 2 distal branched parts, which are no longer than broad	<i>Hecamede, Clanoneurum</i>
	Posterior respiratory tube and its branches much longer	5
5.	Mouthhooks with minute teeth or toothless (Fig. 17.35); posterior spiracles with 3 openings; anterior spiracles club-shaped, spiracular opening sessile (Fig. 17.29)	<i>Ochthera</i>
	Mouthhook toothed and cup-shaped (Fig. 17.31); anterior spiracles palmate (Fig. 17.28)	6
6.	8 pairs of abdominal pseudopods bearing strong claws; the pair on the 8th segment very strongly developed (Fig. 17.11)	7
	Pseudopods absent or weakly developed, without strong claws, the pair on the 8th segment not larger than the others (Fig. 17.14 + 15)	9
7.	Transverse sclerotized strap ventrally on segment 3 (Fig. 17.27); overall length may exceed 12 mm	8
	No transverse sclerotized strap ventrally on segment 3; mature larvae 12 mm or less in length	<i>Ephydra</i>
8.	Transverse strap with a lighter posterior projection; overall length to 18 mm	<i>Cirrula</i>
	Transverse strap without lighter perpendicular projection; overall length to 14 mm	<i>Dimecoenia</i> (part)
9.	Air tube and its branches more than 1/2 as long as body of larva (Fig. 17.14)	<i>Coenia, Paracoenia</i>
	Air tube and its branches shorter (Fig. 17.15)	<i>Scatella, Neoscatella, Scatophila</i>

## 17.3 BIOLOGY

*17.3.1 Brief review of literature*

The biology of ephydrids is best known for the species found in rather unusual habitats. Some of the earliest and most intensive accounts concern species living in inland saline and alkaline waters (Packard, 1869, 1871, 1873; Trägårdh, 1903; Aldrich, 1912; Ping, 1921; Zavattari, 1921; Beyer, 1939; Zahl, 1967), hot springs (Brues, 1924; Tuxen, 1944; Brock and Brock, 1968; Brock et al., 1969), and pools of crude petroleum (Crawford, 1912; Thorpe, 1930). Valuable general summaries of ephydrid biology may be found in Hennig (1943), Oldroyd (1964) and Wirth and Stone (1956).

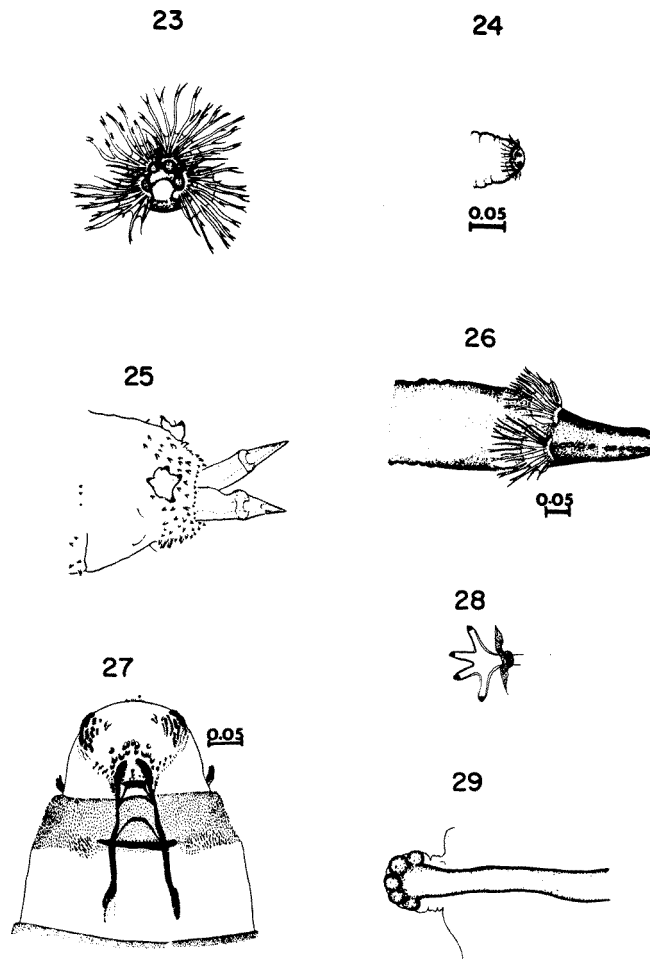

Figs. 17.23–29. Ephydrid larval structures. (23) Posterior spiracle of *Ephydra subopaca*, distal view; (24) same, lateral view (Simpson, 1973); (25) Posterior spiracles of *Hydrellia griseola* (Grigarick, 1959); (26) Posterior spiracle of *Dimecoenia spinosa* (Simpson, 1973); (27) anterior end of *Dimecoenia caesia* larva, ventral view (Hennig, 1943); (28) anterior spiracle of *Ephydra packardi* (Johannsen, 1935); (29) anterior spiracle of *Ochthera mantis* (Simpson, 1975). Scale in mm.

Eastin and Foote (1971) listed by genus many papers containing significant natural history information. Dahl's (1959) work is the most comprehensive ecological study to date, in which he discussed in detail the distribution of the Scandinavian species and presented a few behavioural observations.

In spite of the interest generated by the adaptability and abundance of selected species, relatively little is known about the natural history of the family as a whole. Foote and Eastin (1974) commented that larval feeding habits are available for only 20 of the approximately 347 Nearctic species.

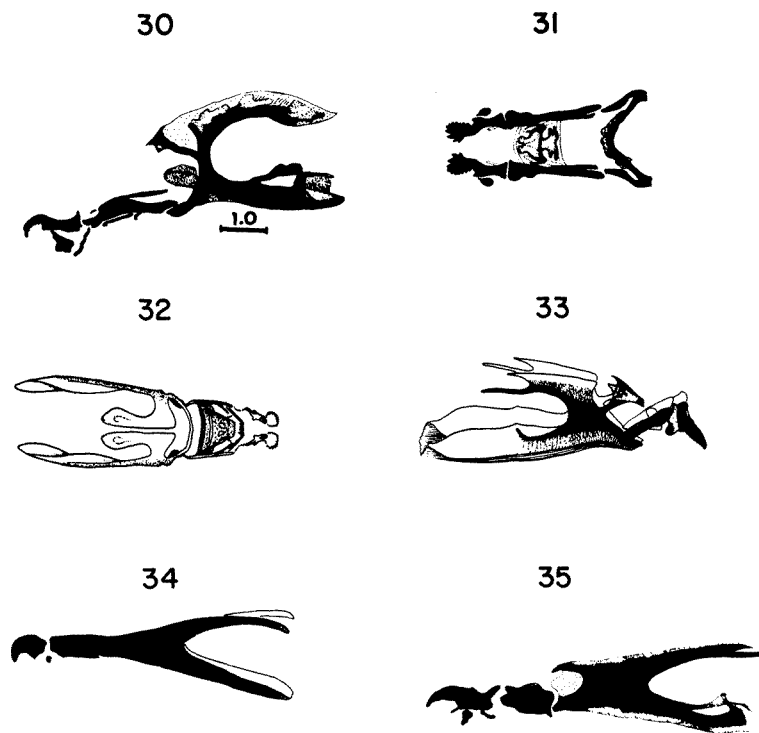

Figs. 17.30–35. Ephydrid larval mouthparts. (30) *Ephydra subopaca*, lateral view; (31) same, dorsal view (Simpson, 1973); (32) *Brachydeutera argentata*, dorsal view (Johannsen, 1935); (33) *Notiphila loewi*, lateral view (Berg, 1950); (34) *Hydrellia griseola*, lateral view (Grigarick, 1959); (35) *Ochthera mantis*, lateral view (Simpson, 1975). Scale in mm.

The truly marine, or coastal, forms have been less well investigated than their inland counterparts. Significant contributions concerning their biology and/or immature stages have been made by Jones (1906), Williams (1938), Hennig (1943), Bohart and Gressitt (1951), Oliveira (1958), Dahl (1959) and Simpson (1973).

### 17.3.2 Life history

The general life history is typical of that for most cyclorrhaphous flies. The eggs are deposited on, in, or near the larval habitat and hatch after 1–5 days. Several hours before eclosion, the young larvae begin locomotor-type movements and scrape the inside of the chorion with their mouthparts. Eventually, the chorion splits along a V- or U-shaped line of weakness and the larva crawls out and immediately begins feeding. The larva is the principal feeding and growing stage, and it is passed in three stadia. First- and second-instar larvae shed their cuticles to pass on to the succeeding stadium. The cuticle of the third-instar larva is not

shed, but hardens and darkens, forming the protective pupal covering termed the puparium. This process of puparium formation is properly called pupariation, and should not be confused with pupation, which occurs inside the puparium after its formation (Fraenkel and Bhaskaran, 1973). The adults emerge 3–10 days after pupariation by inflating a balloon-like ptilinum inside their heads, which forces off a circular ‘cap’ on the front of the puparium. Immediately after emergence, the adult exoskeleton is poorly sclerotized and somewhat transparent, the wings are coiled and limp, and the ptilinum is everted, giving the head a distorted appearance. The flies attain normal color and appearance 1/2 to 1 1/2 hours later, becoming darker and more sclerotized, and the ptilinum is permanently withdrawn behind the ptilinal suture. Total developmental time from oviposition to emergence generally ranges from 2 to 5 weeks under laboratory conditions. Many species are multivoltine, passing through several generations each year. The few observations on overwintering habits reveal that winters may be passed in the larval, pupal or adult stages.

Ephydrid adults usually live in close association with moist substrates and may often be observed directly on sand, mud, rocks and decaying organic matter or on nearby vegetation. Whereas most species spend only short periods on actual water surfaces, a few (*Ephydra*, *Dimecoenia*, *Cirrula*, and *Brachydeutera*) are accomplished water-skaters and spend much of their time there. Most adults are reluctant to fly and when they do it is only for a short distance and close to the substrate (Scheiring, 1974).

### 17.3.3 Mating

Mating behavior has been observed in *Ephydra* (Jones, 1906; Aldrich, 1912; Ping, 1921; Dahl, 1959; Simpson, 1973), *Scatella* (Williams, 1938; Dahl, 1959; Deonier, 1972), *Neoscatella* (Williams, 1938; Dahl, 1959), *Dimecoenia* (Simpson, 1973), *Hydrellia* (Hering, 1951; Grigarick, 1959; Ferino, 1968; Deonier, 1971), *Ochthera* (Deonier, 1972; Simpson, 1975) and *Parydra* (Clausen and Cook, 1971; Deonier, 1972). Dahl (1959) subdivided mating behavior into 6 phases: initiation, posturing, restimulation, mounting, insemination, and dismounting. Because of wide variations in behavior patterns from one encounter to the next, Deonier (1971) found it more convenient to classify mating behavior as either epigamic (courtship or attracting) or gamic (actual mating). In order to gain acceptance by a female, male ephydrids may (1) scissor their wings while walking to and fro in front of the female, (2) rhythmically push their bodies up and down, or (3) touch faces or antennae with the female. Once a male has mounted a female, courtship behavior may continue for several minutes. During this period, the male scissors his wings, taps the head and thorax of the female with his front and middle legs, and nearly always massages her genital region with his hind legs. Receptive females spread their wings and/or curve their abdomens dorsally to meet the

males. During copulation, the females may act quite unconcerned, often walking about feeding and grooming themselves, although the males often continue to rub their genitalia. Mating may be terminated by the male simply dismounting or by the female pushing off the male with her front legs and driving him away.

As Deonier (1971) pointed out, mechanisms for species and sex recognition in the mating process are obscure. In some cases, males have been seen attempting to mate with other males or with females of different species. In other cases, successful matings occur with no apparent premating display (Clausen and Cook, 1971). Deonier (1972) suggests that ultraviolet radiation may be reflected from the silver or gold facial pruinosity of *Hydrellia* in patterns recognized by potential mates. Wirth (1971) suggests that depressions in the fore tarsi of male *Ephydra* may be adaptations for some unknown feature of the mating process.

#### *17.3.4 Oviposition*

Females generally begin laying eggs 1–2 weeks after they emerge. The numerous bristles and hairs surrounding the ovipositors of many ephydrid females enables them to break the surface tension and place the eggs underwater. *Notiphila* females, however, possess an egg-laying sheath which permits oviposition in the wall of ‘soft-stemmed’ reeds (Dahl, 1959). *Parydra* females affix their eggs to twigs, rocks, and other objects a few centimetres above littoral mud (Clausen and Cook, 1971; Deonier, 1972). *Ochthera*, *Scatella*, and many *Ephydra* usually place their eggs directly in the larval habitat with the anterior end barely protruding above the surface. Ping (1921) observed *E. packardi* (as *subopaca*) ovipositing on the water surface, where the eggs sank quickly to the bottom of shallow brine pools. *Ephydra hians*, *E. cinerea*, and *Hydrellia* (Aldrich, 1912; Wirth, 1947; Hering, 1951; Sturtevant and Wheeler, 1954) have been seen walking down stems of aquatic vegetation to oviposit underwater. *Hydrellia* females oviposit on preferred host plants whenever available, but will oviposit on nearly any surface (Deonier, 1971).

#### *17.3.5 Adult feeding habits*

Many adult ephydrids are known to feed on such microscopic algae as diatoms, blue-greens, dinoflagellates, and other unicellular forms (Williams, 1938; Brauns, 1939; Tuxen, 1944; Deonier, 1972; Foote and Eastin, 1974). In fact, Dahl (1959) contended that the adults are basically algal feeders. Most adult mouthparts are quite broad and boot-shaped, and efficiently gather microorganisms from flat, open surfaces. The more slender feeding apparatus of *Notiphila* allows these flies to graze on the surface reed vegetation.

Adult ephydrids obtain their food in a manner quite similar to that of houseflies. The feeding behaviour of *Brachydeutera hebes* as described by Williams (1938)

is typical of many species. 'It seems almost forever to be lapping the surface of the water with rapid strokes of its large tongue-like labella, which terminates the proboscis. By moving this bilobed labella, its free (apical) surface skims the water, gathering by means of . . . pseudotracheae thereon, materials fine enough to pass through them and thence into the gullet.'

Precise food habits have been determined for only a few marine species. Ping (1921) examined the guts of 10 adults of *Ephydra packardi* (as *subopaca*) and found primarily *Chlamydomonas* (Chlorophyta) and *Navicula* diatoms (Chrysophyta). At Great Salt Lake, Utah, adults of *Ephydra cinerea* feed on masses of the blue-green algae *Aphanothece utahensis* and *Microcystis packardi* that wash up on the shore (Nemenz, 1960). Adults of *Lipochaeta slossonae* fluidize moist coastal sand by vigorously shaking their bodies, thus loosening some of the interstitial microflora on which they then feed. Gut content analysis of several flies yielded dinoflagellates (probably *Amphidinium*) and several diatoms typical of the marine interstitial community, including various species of *Navicula*, *Nitzschia*, *Pinnularia*, and *Amphora* (Cheng and Lewin, 1974).

Using the techniques of fluorescent microscopy and radioactive tracing, Brock and co-workers (Brock et al., 1969) have established that the larvae and adults of *Ephydra bruesi* and *Paracoenia turbida* ingest, digest, and assimilate blue-green algae as well as bacteria. Their work proves that microorganisms other than algae are utilized by the larvae and adults of ephydrids.

Two notable exceptions to the general microphagous habits of the adults are *Ochthera* and *Hydrellia*. *Ochthera* adults are non-specialized predators, capturing and feeding on small terrestrial and semi-aquatic insects, and occasionally midge (Chironomidae) and mosquito (Culicidae) larvae (Deonier, 1972; Simpson, 1975). The adults of *Hydrellia* are polyphagous, often feeding on dead or dying insects (including their own kind), as well as yeasts and other fungi, algae (Chlorophyta and Chrysophyta), nectars, and leaf epidermis of various plants (Deonier, 1971). In both genera, the mouthparts are more slender than in most ephydrids, and the labella are equipped with small, sclerotized teeth, which enable these adults to rasp through and feed on various plant and animal tissues.

### 17.3.6 Larval feeding habits

The most widespread larval feeding habit in ephydrids is the filtering of microorganisms (bacteria, yeasts, and unicellular algae) from a semi-liquid medium (Scheiring and Foote, 1973). Particulate matter is filtered from the surrounding fluid and concentrated by the use of longitudinal ridges in the floor of the pharynx (Dowding, 1967).

The larval mouthparts are variously modified for effectively obtaining preferred food. The mouthhooks of microbe-eating larvae (including saprophilic species)



are broadened and somewhat spoon-shaped, well adapted for directing liquid and semi-liquid materials into the mouth (Figs 17.31, 32).

Larvae of several Ephydrinae (i.e., *Ephydra*, *Paracoenia*, and *Scatella*) feed on much the same microorganisms as their adults (Ping, 1921; Brauns, 1939; Tuxen, 1944; Brock et al., 1969). The lack of divergence in food can be attributable to their occurrence in severe habitats where there is little interspecific competition for food, resulting in little evolutionary pressure to exploit new food resources. *Scatella* and its close relatives (i.e., *Neoscatella*) feed on algae to some extent but often breed in decaying organic matter (Williams, 1938).

Within the Parydrinae, *Parydra* larvae inhabit littoral or supralittoral mud, and probably feed on diatoms and other algae (Nielsen et al., 1954; Clausen and Cook, 1971). Williams reported that *Brachydeutera hebes*, a Hawaiian species, feeds on decaying vegetation and algae in stagnant brackish water. *Ochthera* larvae prey on chironomid larvae in mud banks in some coastal marshes (Simpson, 1975). The cephalopharyngeal skeleton including the pointed mouthhooks of *Ochthera* is rather robust and well suited for piercing exoskeletons of its prey (Fig. 17.35).

Of the 3 genera of marine Notiphilinae, the larvae of 2 live in close association with macrophytic vegetation. *Hydrellia* larvae mine the leaves and stems of macrophytes; the two posteriormost sclerites of their mouthparts are fused, and the entire feeding apparatus is streamlined (Fig. 17.34), allowing them to feed internally in very thin submergent leaves of the host plant (Deonier, 1971). Larvae of *Notiphila* tap the roots of aquatic macrophytes for oxygen (see section 17.4.2) and feed on bacteria and yeasts which they filter from the surrounding mud (Scheiring, 1974).

The larval feeding habits of the Psilopinae have been adeptly reviewed by Foote and Eastin (1974). Many species breed in dead and decaying animal tissues or excrement, a few are leaf miners, and one species (*Trimerina madizans*) feeds as a parasitoid within the egg cases of certain marsh-dwelling spiders. Larval feeding habits are known for only 2 of the 18 marine genera listed in Table 17.1. *Hecamede persimilis* was discovered in foul sand beneath a rotting carcass (Bohart and Gressitt, 1951) and *Discomyza* sp. scavenges on dead seashells (Wirth, personal communication). Freshwater European species of *Clanoneurum* and *Psilopa* are leaf miners (Hennig, 1943), but the habits of the marine species are not known.

### 17.3.7 Pupation

The transition from larva to adult is a crucial time in the life cycle of ephydrids. Not only is the individual completely immobile and thus unable to avoid predators and other hazards, but the adult must be able to leave the larval habitat for its own environment. Most commonly, ephydrid puparia are formed just beneath the substrate surface, a position that provides both concealment for the puparium

and easy access to the surface for the adult. Some *Ephydra* emerge from moderately deep waters of inland mineral lakes (Aldrich, 1912; Wirth, 1947). They either float to the surface or crawl up some emergent object in an air bubble which was gradually formed inside the puparium during the development of the adult. In *Hydrellia*, puparia are formed just beneath the surface of the host plant, so that emerging adults have only a thin layer of plant tissue to chew through in order to escape (Deonier, 1971). *Notiphila* larvae angle their spiracles outward in plant roots anchoring the puparia firmly to the roots. If dislodged, the puparium will float to the surface, then gradually fill with water and sink and the pupa will drown (Berg, 1950). *Ephydra*, *Cirrula*, and some *Dimecoenia* often use their last 2 or 3 prolegs for grasping some object in order to stabilize themselves during pupariation (Fig. 17.41). They may be found attached to twigs, algae, or even each other (Ping, 1921; Keilin, 1944; Oliveira, 1958; Simpson, 1973).

## 17.4 ECOLOGY

### 17.4.1 Natural enemies

While few ephydriids have been studied in sufficient detail to integrate them completely into a food web, the available observations show that they are exploited by a wide variety of organisms. In saline and alkaline habitats, they are an integral link in the simplified food webs. For example, larvae of *Ephydra cinerea* have been reported to be important or essential dietary items of waterfowl in American coastal marshes (Martin and Uhler, 1939), gulls at Great Salt Lake, Utah (Zahl, 1967), and flamingos in the West Indies (Rooth, 1965). Ping (1921) considered domestic fowl to be the most important natural enemy of *Ephydra packardii* (as *subopaca*), but the adults were also preyed upon by water-striders (Hemiptera: Gerridae), and parasitized by aquatic mites (*Limnochares* sp.). In eastern North American saltmarshes, larvae of *Ephydra*, *Dimecoenia* and *Cirrula* are fed upon by beetle larvae (*Enochrus* sp., Hydrophilidae) and fly larvae (*Tabanus lineola*, Tabanidae, and Dolichopodidae). These species are also attacked by hymenopterous parasitoids (*Belonura singularis* and *Uroleptis rufipes*, Pteromalidae; *Hexacola* sp., Cynipidae) and the adults are parasitized by aquatic mites (Simpson, 1973).

Even man at one time used to feed on *Ephydra*. Wirth (1971) reported: 'In the western United States and in Mexico, *E. hians* Say becomes so abundant in salt lakes that the puparia are washed ashore in great windrows on the beaches, where in earlier years they were gathered and prepared for use as food by the Indians.'

Natural enemies of ephydriids in non-marine habitats can provide some insight into those to be expected for the marine species. *Dimecoenia lenti* larvae are the

sole food source for small toads (*Telmatobia peruvianus*) living around geyser hot springs in Peru (Oliveira, 1954); eggs and larvae of *Paracoenia turbida* are consumed by dolichopodid (Diptera) adults in the hot springs of Yellowstone National Park, USA (Brock and Brock, 1968; Brock et al., 1969). Other egg predators include aquatic mites (probably *Partuniella* sp.), whose larvae parasitize the adult ephydrids. Adult flies in hot springs are also preyed upon by spiders, dragonflies and birds (Killdeer).

*Hydrellia* adults are preyed upon by lycosid and ctenid spiders, other ephydrids (*Ochthera* sp.), and muscid flies (*Lipse* sp. and *Hydromyza* sp.), and parasitized by various Hymenoptera (Deonier, 1971) and at least 2 genera of fungi, *Stigmatomyces* (Deonier, 1971) and *Entomophthora* (Ferino, 1968).

### 17.4.2 Special adaptations

#### (a) Respiration

The various patterns and markings on the egg surfaces of ephydrids often have a respiratory significance. The interconnected hexagonal markings on the egg surfaces of many Ephydrinae (Figs 17.36 and 37) are related to the distribution of aeropyles (small openings through which the eggs respire) over the egg surface. Each egg of *Paracoenia* (Fig. 17.38) has an elongate anterior stalk which projects above the substrate, enabling the egg to respire directly in the atmosphere (Dahl, 1959; Brock and Brock, 1968). Other ephydrid eggs, such as *Ochthera* (Fig. 17.39) are equipped with plastron-trapping devices in the form of numerous interconnected craters. A thin layer of air is held by these areas when the eggs are

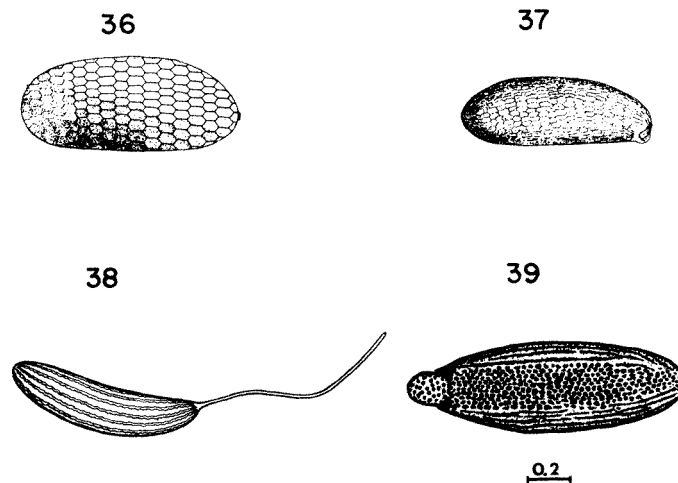

Figs. 17.36–39. Ephydrid eggs. (36) *Ephydra packardi* (Johannsen, 1935); (37) *Scatelli bryani* (Williams, 1938); (38); (38) *Paracoenia fumosa* (Beyer, 1939); (39) *Ochthera tuberculata* (Simpson, 1975). Scale in mm.

submerged, which increases the rate of gaseous exchange between the egg and the water. A complete discussion of these respiratory mechanisms has been given by Hinton (1969; also see Ch. 3).

Larval respiration occurs mainly through the posterior, or post-abdominal, spiracles (Keilin, 1944) (Figs 17.23–26). Typically, the larvae hang down from the surface with these spiracles remaining in contact with the atmosphere. The spiracles are kept afloat by four non-wettable float hairs, which also prevent water from entering the tracheal system when the spiracles are submerged. The elongate and retractable breathing tube of many species allows them to penetrate below the surface of oxygen-poor habitats in the pursuit of food and perhaps also protection without losing direct contact with the atmosphere.

Some inland marine species need only intermittent atmospheric contact. Submerged larvae of *Ephydra packardii* produce bubbles on the tips of their spiracles, which increase in size until large enough to carry the larvae to the surface. After remaining at the surface for a while, the larvae wriggle to break the surface tension, then sink to the bottom to feed and eventually repeat the surfacing cycle. These larvae suffocate when prevented from surfacing by a wire screen (Ping, 1921). Larvae of *Ephydra hians* and *E. cinerea* normally never surface from the bottom of strong inland mineral lakes (Aldrich, 1912; Wirth, 1947). Much of the respiration apparently occurs through the cuticle, but some gaseous exchange also occurs through air bubbles which the larvae carry on the tips of their posterior spiracles. According to Beyer (1939), Dahl (1959), and Nemenz (1960), the need for atmospheric oxygen decreases with increasing salinity. As the larvae increase their body surfaces, they also increase the amount of oxygen obtainable through the cuticle.

Some ephydrid larvae obtain their oxygen from aquatic plants and consequently can inhabit areas well removed from the air-water interface. Leaf-mining *Hydrellia* larvae respire by inserting their needle-like posterior spiracles (Fig. 17.25) into the air spaces of their host plants (Berg, 1950; Deonier, 1971). Larvae of *Notiphila* are free-living in highly organic, oxygen-poor mud, where they tap the gas spaces of the roots of *Potamogeton* (Berg, 1950), *Glyceria* (Varley, 1937), *Typha*, *Juncus* (Houlihan, 1969), and *Scirpus* (Mathis, personal communication). *Notiphila riparia* lives among masses of primary and secondary roots in fairly solid mud, the firmness of which provides the leverage necessary for the root-insertion process (Houlihan, 1969). The ability of *Dimecoenia spinosa* to pierce roots is unique among the Ephydrinae. These larvae live and feed in saltmarsh mud, and use their pointed posterior spiracles for acquiring oxygen from both the atmosphere and the roots of aquatic plants (Simpson, 1973).

The notorious tolerance of *Ephydra* larvae to high salt concentrations has prompted several investigations into the osmoregulatory mechanisms of these

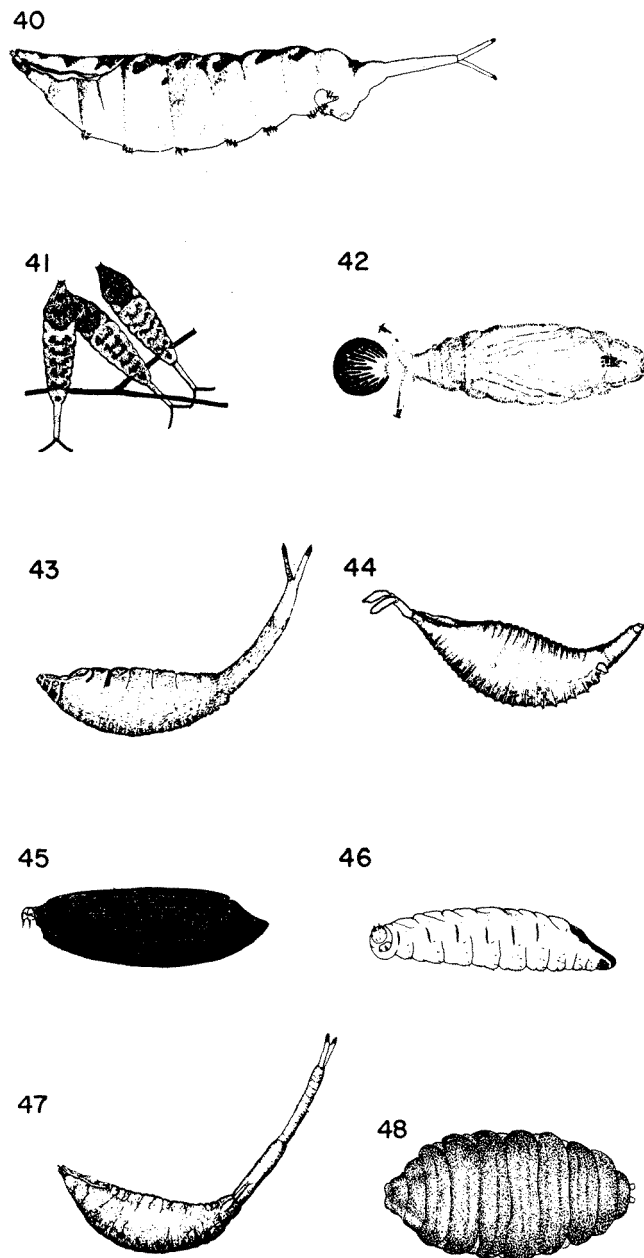

Figs. 17.40–48. Ephhydrid puparia. (40) *Ephydra packardi* (Johannsen, 1935); (41) same, attached to a twig (Johannsen, 1935); (42) *Scatella bryani* (Williams, 1938); (43) *Dimecoenia spinosa* (Simpson, 1973); (44) *Brachydeutera argentata* (Johannsen, 1935); (45) *Notiphila riparia* (Varley, 1937); (46) *Hydrellia griseola* (Grigarick, 1959); (47) *Ochthera mantis* (Simpson, 1975); (48) *Hecamede persimilis* (redrawn from Bohart and Gressitt, 1951).

creatures. Beyer (1939) noted that among conspecific larvae of *E. riparia* the breathing tube was longer on individuals inhabiting more saline waters, and suggested this had a function in osmoregulation. Sutcliffe (1960) found that the rectal fluid passed by *E. riparia* was considerably more concentrated than the medium it lived in. Nemenz (1960) obtained osmotic pressure equivalent to 20.4 atmospheres in the haemolymph of *E. cinerea* from Great Salt Lake, and claimed it was the highest value found in insects. He concluded that osmoregulation is probably accomplished partially by a very impermeable cuticle and partially by some active regulating mechanism.

Other investigations revealed that the larvae of *Ephydra* not only tolerate high salinities but require certain concentrations for survival and normal development. Ping (1921) found *E. packardi* (as *subopaca*) tolerant to salinities of from 1 to 8 %, with 4–5 % the optimum for development. When removed to freshwater, first- and second-instar larvae did not survive, but mature larvae pupated without difficulty. Packard's (1869) observations on the same species at a saltworks in Illinois revealed that the larvae occurred in great numbers in pools of intermediate salt concentrations, but did not occur at all in freshwater, weak brine, or very strong brine. Von Heyden (1844, as cited by Wirth, 1971) found *E. riparia* in concentrations of up to 6.75 % salt but not in stronger pools where the salt content was as high as 27%.

The numerous welts, spinules and spines on the larvae aid in their locomotion. The furthest extremes of those structures are the abdominal prolegs of *Cirrula*, *Ephydra* and *Dimecoenia*, which aid these larvae in moving on and through tangled masses of filamentous algae.

The structure of the adult tarsi reflects the ability of the flies to move effectively on different substrates (Dahl, 1959). The pool inhabitants (*Ephydrini* and *Brachydeutera*) are skilled surface skaters but poor climbers. Their tarsi are long and slender, with straight tarsal claws, very reduced pulvilli, and dense, water-repellent hairs. Species living in dense vegetation (e.g. *Notiphila*) are adept climbers and have curved claws and well-developed pulvilli adapted for this purpose. The majority of the remaining flies (including the Scatellini and Psilo-pinae) have moderately developed claws, pulvilli, and water-repellent hairs, enabling them to live nearly anywhere but on open water. *Ochthera* adults belong to this last category, but in addition, their forelegs are raptorial, resembling those of the predaceous praying mantids in both structure and function.

An unusual behavioural adaptation has been observed for *Ephydra cinerea* and *E. hians*. These adults enter the water by walking down sticks or other emergent objects with a bubble of air enclosed under their wings, presumably to feed and oviposit (Aldrich, 1912; Wirth, 1947; Sturtevant and Wheeler, 1954). Wirth (1971) noted: 'They walk around on the bottom clinging to algae or other

firm material, hanging on with their claws, and when ready to surface, they merely let go, and rise with the air bubble which bursts at the surface leaving them standing high and dry.' The function of a more widespread behaviour, the reluctance to fly, is not clear, but it may be to keep the adults close to the larval habitat or to make them less conspicuous to predators.

### *17.4.3 Habitat distribution and dispersal*

Although the taxonomy and morphology of adult ephydriids are fairly well known, relatively little effort has been made towards understanding their ecological requirements. Dahl (1959) discussed some of the effects of different temperatures, humidities, salinities and substrate types on the survival and distribution of certain adults. Scheiring (1974) analyzed the diversity and evenness of the ephydriid faunas in relation to habitat stability and availability of larval food, and found that larval adaptations are more important than those of the adults in determining habitat distribution. In addition to proper substrate type and adequate food supply, I have noted that ephydriids require relatively quiescent habitats where the adults are sheltered from strong winds and the larvae are protected from appreciable water movements.

Marine ephydriids can be found in a variety of habitats in the marine environments, such as rocky shores, sandy beaches, estuarine and tidal marshes, and mangrove swamps. Within each habitat, several microhabitats can be distinguished depending on types of substrate, vegetation and tidal level, e.g., moist rocks, mud flat, sand flat, algae-filled pool, floating algal mats, emergent macrophytic vegetation, decaying organic matter, etc. Although lists of ephydriid species found in various habitats have been presented by Dahl (1959), Deonier (1964a) and Scheiring and Foote (1973), it is not possible to present a detailed listing of marine shore flies for each microhabitat. However, some information on the preferred adult and larval habitats are given in Table 17.1, and a few generalizations concerning the distributions of the four subfamilies are summarized here.

The two tribes of Ephydrinae are ecologically distinct. Ephydrini contains some of the most common and abundant insects inhabiting coastal marshes. Within these habitats, the adults are found in the meadows, on mud flats, and especially on water surfaces of salt pans or pools. The larvae of *Ephydra* and *Cirrula* prefer tangled masses of floating or submerged filamentous algae; some *Dimecoenia* larvae also occur in algal mats, but those of *D. spinosa*, the most widely distributed species, live in mud. The Scatellini occur in a much wider range of marine habitats (see Table 17.1), and generally require substrates with a high organic content, supporting a rich community of microorganisms on which the larvae and adults feed.

The distribution of Notiphilinae, notably species of *Hydrellia* and *Notiphila*,

depends largely on the availability of the macrophytic plants with which their larvae are associated. The Parydrinae has affinities for muddy substrates (*Parydra* and *Ochthera*), wet intertidal sand (*Lipochaeta*), and stagnant tidal pools (*Brachydeutera*). The Psilopinae occurs in a wide array of habitats, but very little is known of their habitat preferences except for a few non-marine species (Foote and Eastin, 1974).

The dispersal of Ephydridae is accomplished almost entirely by passive transport. The combination of wind and water was considered by Dahl (1959) to be the most efficient means. Aerial plankton surveys by Hardy and Milne (1938) and Glick (1960) showed that adults of some ephydrids may be carried to considerable distances when caught in high air currents. The adherence of eggs and puparia to the legs and feathers of wading birds is of lesser importance. *Ephydra cinerea* adults have the habit of swarming into man-made vehicles. Their immigration from California to Hawaii was probably achieved by hitch-hiking on seaplanes (Wirth, 1947).

### ACKNOWLEDGEMENTS

Dr. Willis Wirth, United States National Museum, Washington, D.C., provided several unpublished marine distributions and some timely suggestions for the figures and text. Wayne Mathis of Oregon State University, Corvallis and Joseph Scheiring of the University of Kansas, Lawrence, furnished unpublished distribution records for *Notiphila* and the *Scatella* complex, respectively.

### REFERENCES

- Aldrich, J.M. (1912) The biology of some western species of the dipterous genus *Ephydra*. J. N. Y. Entomol. Soc. 20, 77–99.
- Becker, T. (1926) Ephydridae (Fam.) 56. In: Die Fliegen der Palaearktischen Region 6, pt. 1. (E. Lindner, Ed.) Stuttgart, pp. 1–115.
- Berg, C.O. (1950) *Hydrellia* (Ephydridae) and some other acalyprate Diptera reared from *Potamogeton*. Ann. Entomol. Soc. Am. 43, 374–398.
- Beyer, A. (1939) Morphologische, ökologische, und physiologische Studien an den Larven der Fliegen: *Ephydra riparia* Fallén, *E. micans* Haliday und *Cänia fumosa* Stenhammar. Kiel. Meeresforsch. 3, 265–320.
- Bohart, G.E. and Gressitt, J.L. (1951) Filth-inhabiting flies of Guam. Bull. B. P. Bishop Mus. 204, 1–152.
- Bolwig, N. (1940) The description of *Scatophila cornis* Szerny, 1900 (Ephydridae: Diptera). Proc. R. Entomol. Soc. Lond. (B) 9, 129–137.
- Borror, D.J. and DeLong, D.M. (1971) An Introduction to the Study of Insects. 3rd Edn. ( ) 812 pp.
- Brauns, A. (1939) Zur Biologie der Meerestrandfliege *Scatella subguttata* Meig. (Familie Ephydridae; Diptera). Zool. Anz. 126, 273–285.
- Brock, T.D. and Brock, M.L. (1968) Life in a hot-water basin. Nat. Hist. 77, 47–53.



- Brock, M.L., Wiegert, R.G. and Brock, T.D. (1969) Feeding by *Paracoenia* and *Ephydra* (Diptera: Ephydriidae) on the microorganisms of hot springs. *Ecology* 50, 192–200.
- Brues, C.T. (1924) Observations on animal life in thermal waters of Yellowstone Park, with a consideration of the thermal environment. *Proc. Am. Acad. Arts Sci.* 59, 369–438.
- Cheng, L. and Lewin, R.A. (1974) Fluidization as a feeding mechanism in beach flies. *Nature* 250(5462) 167–168.
- Clausen, P.J. and Cook, E.F. (1971) A revision of the Nearctic species of the Tribe Parydini. (Diptera: Ephydriidae). *Mem. Am. Entomol. Soc.* 27, 1–150.
- Cole, F.R. (1912) Some Diptera of Laguna Beach. Pomona, Col., Laguna Mar Lab., Annu. Rep. 1, 150–162, 10 Figs.
- Crawford, D.L. (1912) The petroleum fly in California *Psilopa petrolei* Coq. (Ephydriidae). *J. Entomol. Zool. (Pomona, Coll. J. Entomol.)* 4, 687–697.
- Cresson, E.T., Jr. (1942) Synopses of North American Ephydriidae (Diptera) I. The subfamily Psilopinae, with descriptions of new species. *Trans. Am. Entomol. Soc.* 68, 101–128.
- Cresson, E.T., Jr. (1944) Synopses of North American Ephydriidae (Diptera). Ia. Supplement to Part I on the Subfamily Psilopinae. II. The Tribes Hydrelliini, Hydrinini and Ilytheini of the Subfamily Notiphilinae with descriptions of new species. *Trans. Am. Entomol. Soc.* 70, 150–180.
- Cresson, E.T., Jr. (1946) Synopses of North American Ephydriidae. III. The Tribe Notiphilini of the subfamily Notiphilinae. *Trans. Am. Entomol. Soc.* 72, 227–240.
- Cresson, E.T., Jr. (1949) A systematic annotated arrangement of the genera and species of the North American Ephydriidae. IV. The subfamily Napaeninae. *Trans. Am. Entomol. Soc.* 74, 225–260.
- Curran, C.H. (1965) The Families and Genera of North American Diptera. 2nd rev. edn, (, ) 315 pp.
- Dahl, R.G. (1959) Studies on Scandinavian Ephydriidae (Diptera, Brachycera). *Opusc. Entomol. suppl.* 15, 1–224.
- Deonier, D.L. (1964a) Ecological observations on Iowa shore flies (Diptera, Ephydriidae). *Proc. Iowa Acad. Sci.* 71, 496–510.
- Deonier, D.L. (1964b) Keys to the shore flies of Iowa (Diptera, Ephydriidae). *Iowa St. J. Sci.* 39(2) 103–126.
- Deonier, D.L. (1971) A systematic and ecological study of Nearctic *Hydrellia* (Diptera: Ephydriidae). *Smithson. Contr. Zool.* 68, 1–147.
- Deonier, D.L. (1972) Observations on mating, oviposition and food habits of certain shore flies (Diptera: Ephydriidae). *Ohio J. Sci.* 72(1) 22–29.
- Dowding, V.M. (1967) The function and ecological significance of the pharyngeal ridges occurring in the larvae of some cyclorhaphous Diptera. *Parasitology* 57, 371–388.
- Eastin, W.C. and Foote, B.A. (1971) Biology and immature stages of *Dichaeta caudata* (Diptera: Ephydriidae). *Ann. Entomol. Soc. Am.* 64(1) 271–279.
- Ferino, M.P. (1968) The biology and control of the rice leaf-whorl maggot, *Hydrellia philippina* Ferino (Ephydriidae, Diptera). *Philipp. Agric. LII*(6) 332–383.
- Foote, B.A. and Eastin, W.C. (1974) Biology and immature stages of *Discocerina obscurella* (Diptera: Ephydriidae). *Proc. Entomol. Soc. Wash.* 76(4) 401–408.
- Fraenkel, G. and Bhaskaran, G. (1973) Pupariation and pupation in Cyclorhaphous flies (Diptera): terminology and interpretation. *Ann. Entomol. Soc. Am.* 66, 418–422.
- Glick, P. A. (1960) Collecting insects by airplane, with special reference to dispersal of the potato leaf-hopper. *U. S. Dep. Agric. Tech. Bull.* 1222.
- Grigarick, A. A. (1959) Bionomics of the rice leaf miner, *Hydrellia griseola* (Fallén) in California (Diptera: Ephydriidae). *Hilgardia* 29, 1–80.
- Hardy, A.C. and Milne, P.S. (1938) Studies in the distribution of insects by aerial currents. *J. Anim. Ecol.* 7, 199–229.
- Hennig, W. (1943) Übersicht über die bisher bekannten metamorphosesstadien der Ephydriden

- Neubeschreibungen nach dem Material der Deutschen Limnologischen Sunda-Expedition (Diptera: Ephydriidae). Arb. Morphol. Taxon. Entomol. 10, 105–138.
- Hering, E.M. (1951) Biology of the Leaf Miners. (, .)
- Hinton, H.E. (1969) Respiratory systems of insect egg shells. Annu. Rev. Entomol. 14, 343–368.
- Houlihan, D.F. (1969) The structure and behaviour of *Notiphila riparia* and *Erioptera squalida*, two root-piercing insects. J. Zool. Lond. 159, 249–267.
- Johannsen, O.A. (1935) Aquatic Diptera. Part II. Orthorrhapha-Brachycera and Cyclorrhapha. Mem. Cornell Univ. Agric. Exp. St. 177, 1–62.
- Jones, B.J. (1906) Catalogue of Ephydriidae, with bibliography and description of new species. Univ. Calif. Publ. Entomol. 1, 153–198.
- Keilin, D. (1944) Respiratory systems and respiratory adaptations in larvae and pupae of Diptera. Parasitology 36, 1–66.
- Loew, H. (1860) Die Europaischen Ephydrinidae und die Bisher in Schlesien Beobachteten Arten Derselben. Neue Beiträge zur Kenntnis der Dipteren. Part 7. (, .)
- Martin, A.C. and Uhler, F.M. (1939) Food of game ducks in the United States and Canada. USDA Tech. Bull. 634, 156 pp.
- Nemenz, H. (1960) On the osmotic regulation of the larvae of *Ephydra cinerea*. J. Insect Physiol. 4, 38–44.
- Nielsen, P., Ringdahl, O. and Tuxen, S.L. (1954) The Zoology of Iceland. Vol. III, pt. 48a, Diptera 1, 1–189.
- Oldroyd, H. (1964) The Natural History of Flies. ( ) 324 pp.
- Oliveira, S.J. de (1954) Contribuição para o conhecimento do gênero '*Dimecoenia*' Cresson. 1916. I. '*Dimecoenia lenti*' sp. n. Encontrada no Chile (Diptera, Ephydriidae). Rev. Bras. Biol. 14, 187–194.
- Oliveira, S.J. de (1958) Contribuição para o conhecimento do gênero '*Dimecoenia*' Cresson. 1916. IV Descrição da larva e do pupário de '*Dimecoenia grumanni*' Oliveira, 1954. (Diptera, Ephydriidae). Rev. Bras. Biol. 18, 165–169.
- Packard, A.S., Jr. (1869) On insects inhabiting salt water. Proc. Comm. Essex Inst. 6, 41–51.
- Packard, A.S., Jr. (1871) On insects inhabiting salt water. No. 2. Am. J. Sci., Ser. 3, 1, 100–110.
- Packard, A.S., Jr. (1873) Insects inhabiting Great Salt Lake and other saline or alkaline lakes in the West. Hayden's Rep. U.S. Geol. Surv. Terr. 1872, pp. 743–746.
- Ping, C. (1921) The biology of *Ephydra subopaca* Loew. Mem. Cornell Univ. Agric. Exp. Stn. 49, 557–616.
- Rooth, J. (1965) The flamingos on Bonaire (Netherlands Antilles). Habitat, diet and reproduction of *Phoenicopiterus ruber ruber*. Nat. Stud. Suriname Nederlandse Antillen no. 41. 151 pp.
- Scheiring, J.F. (1974) Diversity of shore flies (Diptera: Ephydriidae) in inland freshwater habitats. J. Kan. Entomol. Soc. 47(4) 485–491.
- Scheiring, J.F. and Foote, B.A. (1973) Habitat distribution of the shore flies of Northeastern Ohio (Diptera: Ephydriidae). Ohio J. Sci. 73(3) 152–155.
- Simpson, K.W. (1973) Biology and immature stages of certain Ephydriidae (Diptera) occurring in North America. (Ph.D. thesis, Cornell Univ., Ithaca, N.Y.) 155 pp.
- Simpson, K.W. (1975) Biology and immature stages of three species of Nearctic *Ochthera* (Diptera: Ephydriidae). Proc. Entomol. Soc. Wash. 77(1) 129–162.
- Steyskal, G.C. (1970) The species of the genus *Dimecoenia* (Diptera: Ephydriidae) in America north of Panama, with the description of a new species. Ann. Entomol. Soc. Am. 63(2) 462–465.
- Sturtevant, A.H. and Wheeler, M.R. (1954) Synopses of Nearctic Ephydriidae (Diptera). Trans. Am. Entomol. Soc. 79, 151–257.
- Sutcliffe, D.W. (1960) Osmotic regulation in the larvae of some eurhaline Diptera. Nature 187, 331–332.
- Thorpe, W.H. (1930) The biology of the petroleum fly. Trans. Entomol. Soc. Lond. 78, 331–344.

- Torre-Bueno, J.R. (1937) A glossary of entomology. Brooklyn Entomol. Soc., N. Y. 336 pp.
- Trägårdh, I. (1903) Zur Anatomie und Entwicklungsgeschichte de Larvae von *Ephydra riparia* Fall. Ark. Zool. 1, 1–42.
- Tuxen, S.L. (1944) The hot springs, their animal communities and their zoogeographical significance. The Zoology of Iceland. 1(11) 1–206.
- Varley, G.C. (1937) Aquatic insect larvae which obtain oxygen from the roots of plants. Proc. R. Entomol. Soc. Lond. (A) 12, 55–60.
- Wheeler, M.R. (1952) The dipterous family Canaceidae in the United States. Entomol. News 63, 89–94.
- Williams, F.X. (1938) Biological studies in Hawaiian water-loving insects. Part III. Diptera or flies. A; Ephydriidae and Anthomyiidae. Proc. Hawaii. Entomol. Soc. 10, 85–119.
- Wirth, W.W. (1947) *Ephydra gracilis* Packard, a recent immigrant fly in Hawaii (Diptera: Ephydriidae) Proc. Hawaii. Entomol. Soc. 13, 141–142.
- Wirth, W.W. (1951) A revision of the dipterous family Canaceidae. Occ. papers. B.P. Bishop Mus. 20, 245–275.
- Wirth, W.W. (1964) A revision of the shore flies of the genus *Brachydeutera* Loew (Diptera: Ephydriidae). Ann. Entomol. Soc. Am. 57, 3–12.
- Wirth, W.W. (1965) Family Ephydriidae. In: A Catalog of the Diptera of America north of Mexico. (Stone et al., Eds.) 276, 734–759.
- Wirth, W.W. (1968a) Family Ephydriidae. In: Catalogue of the Diptera of the Americas south of the United States. 77, 1–43.
- Wirth, W.W. (1968b) The genus *Typopsilopa* Cresson in the Western Hemisphere, Proc. Entomol. Soc. Wash. 70(3) 225–237.
- Wirth, W.W. (1969) A new Neotropical species of *Mosillus* (Diptera: Ephydriidae). Fla. Entomol. 52(3) 147–152.
- Wirth, W.W. (1970) A new *Athyroglossa*, with a key to North American species (Diptera: Ephydriidae). J. Kan. Entomol. Soc. 43(3) 315–319.
- Wirth, W.W. (1971) The brine flies of the Genus *Ephydra* in North America (Diptera: Ephydriidae). Ann. Entomol. Soc. Am. 64(2) 357–377.
- Wirth, W.W. (1975) A revision of the brine flies of the genus *Ephydra* of the Old World. Entomol. Scand. 6(1) 11–44.
- Wirth, W.W. and Stone, A. (1956) Aquatic Diptera. In: Aquatic Insects of California. (R.L. Usinger, Ed.) (, ) pp. 372–482.
- Zahl, P. (1967) Life in a 'dead' sea-Great Salt Lake. Natl. Geogr. Mag. 132, 252–263.
- Zavattari, E. (1921) Biologica Neritica Maediterranea. III. Ricerche morfologiche ed etologiche sul dittero alofilo *Ephydra bivittata* Loew. Mem. R. Comm. Talassogr. Ital. 83, 1–58.

## Marine beetles (Coleoptera excluding Staphylinidae)

John T. Doyen

<b>Contents</b>		
18.1	Introduction	497
18.2	Definition of marine Coleoptera	500
18.3	General morphology	502
	18.3.1 Adult	502
	18.3.2 Larva	504
18.4	Systematics and identification — Key to genera of marine Coleoptera	506
18.5	Biology	508
	18.5.1 Beetles of rocky shores	508
	18.5.2 Beetles of sandy beaches and mud flats	509
	18.5.3 Beetles of other habitats	510
18.6	Ecology	511
	18.6.1 Respiratory adaptations	511
	18.6.2 Wing modifications and dispersal	514
	18.6.3 Distribution	516
References		516

### 18.1 INTRODUCTION

Among holometabolous insects, which are mostly aerial as adults, Coleoptera are distinguished by a predominance of substrate-dwelling species. Consequently, aquatic forms are mostly bottom dwellers rather than swimmers, with notable exceptions among the Hydrophilidae and Dytiscidae. Saltwater Coleoptera are all benthic organisms, except for some species which inhabit saline ponds, brackish estuaries and other non-oceanic situations. Nearly all free-swimming species are more prevalent and abundant in freshwater, and probably invade

Taxon	Occurrence/remarks	Source(s)
<b>CARABIDAE</b>		
<i>Aepopsis</i> (1)	Atlantic coast of Europe, Scandinavia to Spain; crevices in rock and shingle. Known as <i>Aepus</i> in older literature.	Glynne-Williams et al, 1952; Jeannel, 1926, 1941; Alluaud, 1926; see text.
<i>Aepus</i> (3)	Atlantic, Denmark to north Africa; rock crevices.	Jeannel, 1926, 1941; Walsh, 1925; Lengerken, 1929b.
<i>Cillenius</i> (5) (= <i>Bembidion</i> )	Atlantic and Mediterranean coasts, Europe; sand beaches, Japan and neighbouring islands; coral reefs and sand beaches.	Haliday, 1837; Miall, 1895; Carpenter, 1901; Uéno, 1955–1956; Satô, 1964a; Kocher, 1966; Amanieux, 1969.
<i>Dyschirius</i> (2)	Atlantic, Mediterranean coasts of Europe; sand beaches.	Alluaud, 1926; Amanieux, 1969.
<i>Halocoryza</i> (1)	Caribbean region; local under beached algae (a second species from Pacific coast of Mexico may also be intertidal).	Vinson, 1956; Whitehead, 1966, 1968.
<i>Kenodactylus</i> (2)	Campbell Island, southern South America and Falkland Islands; rock crevices.	Jeannel, 1926; Darlington, 1964.
<i>Lymnaeum</i> (1) (= <i>Bembidion</i> )	Atlantic, Mediterranean coasts of Europe; rock crevices.	Carpenter, 1901; Walsh, 1925.
<i>Perileptus</i> (1)	Japan and neighboring islands; sandy beaches.	Satô, 1964a; Uéno, 1955.
<i>Tachys</i> (3)	Atlantic, Mediterranean coasts of Europe, Pacific coast of Mexico; rock crevices.	Lengerken, 1929b; Amanieux, 1969; Evans, 1968.
<i>Temnostega</i> (1)	Crozet Archipelago, Antarctica; rock crevices.	Jeannel, 1926.
<i>Thalasso-duvialius</i> (2)	Japan; crevices in rock, shingle.	Uéno, 1956.
<i>Thalassobius</i> (1)	Southern, central Chile; under stones in intertidal.	Jeannel, 1926.
<i>Thalassotrechus</i> (1)	Southern to central California; rock crevices, upper intertidal.	Van Dyke, 1918; Moore, 1956; Evans, 1968, 1970; Doyen, 1975.
<b>HYDROPHILIDAE</b>		
<i>Cercyon</i> (4)	Marine species recorded from Europe, North America; genus widespread, probably with other marine species.	Carpenter, 1901; Walsh, 1925; Blackwelder, 1931; Leech and Chandler, 1956; Leech and Moore, 1971; Doyen, 1975.
<b>HYDRAENIDAE</b>		
<i>Meropathus</i> (1)	Kerguelen Islands; occurs in both fresh water and intertidal.	Jeannel, 1953.
<i>Ochthebius</i> (7)	Atlantic, Mediterranean coasts of Europe; California; Japan. Rock crevices and splash pools. Many species associated with saline environments; intensive collecting	Van Dyke, 1918; Walsh, 1925; Hase, 1926; Lindberg, 1944, 1948; Machura, 1935a, b; Satô, 1963.

**HETEROCERIDAE**

*Heterocerus* (2) Atlantic, Mediterranean coasts, Europe; Cazalet, 1936; Machura, 1935a, b; sandy, silty beaches, especially in Amanieux, 1969. estuaries, salt ponds.

**LIMNICHIDAE**

*Martinius* (1) Cuba; intertidal on sand about mangrove Spilman, 1966. roots.

*Mexico* (1) Pacific coast, Mexico; shingle beaches. Spilman, 1972.

*Throscinus* (1) Pacific coast, southern California; intertidal mudflats. Leech and Chandler, 1956.

**MELYRIDAE**

*Endeodes* (9) Pacific coast, California, Mexico; rock Blackwelder, 1932; Moore, 1954, 1956, crevices, shingle beaches, sand beaches; 1957, 1964; Moore and Legner, 1975; upper intertidal/supratidal. Evans, 1968.

*Laius* (3) Madagascar, under stones; intertidal. Japan Paulian, 1959, 1961; Nakane, 1955; Sato, and neighbouring islands; upper 1964a. intertidal/supratidal. Additional investigation will probably reveal other intertidal members of this large genus of frequently maritime beetles.

**SALPINGIDAE**

*Aegialites* (4) Pacific coast, California to Alaska and Linell, 1898; Keen, 1903; Wickham, 1904a, Japanese Archipelago; rock crevices, b; Van Dyke, 1918; Saunders, 1928; lower to upper intertidal. Kono, 1936, 1938; Spilman, 1967.

*Antarcticodromus* (1) Antarctic Islands (Campbell, Auckland, Spilman, 1967. French), under stones.

**TENEBRIONIDAE**

*Epantius* (1) Pacific coast, California, northern Baja Moore, 1954; Doyen, 1975. California. Extreme upper intertidal, usually associated with *Fucus*.

*Phaleria* (-) Sea beaches worldwide, except in cold Pardi, 1955, 1958; Moore, 1954. regions; numerous species, nearly all probably marginally marine.

**RHIZOPHAGIDAE**

*Phyconomus* (1) California; under driftwood and wrack, Moore, 1954. upper intertidal.

**CHRYSOMELIDAE**

*Haemonia* (3) Brackish water, Atlantic coast of Europe, Lindberg, 1944, 1948; Carpenter, 1901. especially in tidal estuaries; associated with *Zostera*.

**CURCULIONIDAE**

*Emphyastes* (1) Pacific, California to Baja California; wrack Doyen, 1975. or rock crevices.

*Mesembriorrhinus* (1) Kerguelen Islands, Subantarctic; intertidal as Jeannel, 1940, 1953. larva.

---

saline waters opportunistically. Terrestrial and freshwater beetles often inhabit cracks and crevices, rather than frequenting exposed surfaces, and all oceanic forms apparently occupy protected nooks and crannies, either in rocks, in beached algae, or in burrows. This dependence on retreats correlates with the fact that oceanic Coleoptera are exclusively intertidal, requiring protection from wave action.

Coleoptera are practically the only holometabolous insects with submarine adults, and most strictly marine beetles spend their entire life cycle within the intertidal zone. In contrast, the Diptera, also relatively successful in marine environments, are mostly aerial and short-lived as adults. Whereas many marine insects are representatives of families which commonly inhabit freshwater (e.g., Diptera: Chironomidae, Ceratopogonidae, Culicidae, Tipulidae) most marine beetles are specialized members of typically terrestrial families. With few exceptions, families adapted to freshwater do not enter oceanic habitats. For example, among the Dytiscidae and Hydrophilidae *Bidessus megacephalus* (Gschwendtner) and *Tropisternis salsamentus* (Fall) are confined to highly saline seashore ponds, and a few species of *Cercyon* (a terrestrial genus) regularly occupy marine habitats. However, many species do occasionally invade brackish estuaries, effluences of rivers, or splash pools in rocks. More emphatically, the Elmidae, Dryopidae and Psephinidae, common and widespread in freshwater, have no marine representatives, other than a single species of dryopid which occasionally enters brackish waters. On the other hand, Carabidae and Staphylinidae, the most common marine Coleoptera, with many exclusively intertidal and littoral members, have very few truly aquatic freshwater representatives.

## 18.2 DEFINITION OF MARINE COLEOPTERA

At least 50 species of Coleoptera representing 11 families are known to be obligatorily marine (see Table 18.1). The division between marine and non-marine is admittedly arbitrary, with many species occupying intermediate zones, such as brackish estuaries, and others spending small portions of their time in marine habitats. Only taxa which regularly spend part of their life submerged by at least the higher tides are considered in any detail here. Species known to inhabit primarily freshwater, especially Hydrophilidae and Dytiscidae, are omitted unless shown to reproduce successfully in marine habitats. Genera with species characteristic of brackish water are listed in Table 18.2. Most of these species appear to be highly facultative, opportunistically invading either brackish or freshwater, and a significant portion probably represent freshwater species which occasionally enter saline habitats, but do not reproduce there. In his definitive work on Coleoptera and Hemiptera of the Baltic Sea, Lindberg (1948) lists only 7 species as 'Halobionten' (restricted to brackish water), while 54 species are recognized as

Table 18.2 Conspectus of families of brackish water Coleoptera. Figures for numbers of genera are minimal estimates, especially for the Hydrophilidae and Dytiscidae.

Family	No. of genera	Occurrence and abundance
Haliplidae	3	Occasional on vegetation, debris, many saline situations.
Dytiscidae	20	Most prevalent brackish water Coleoptera; frequently abundant. Occupy all saline habitats except open oceans.
Noteridae	1	Occasional in bottom debris.
Gyrinidae	1	Rare in saline situations.
Hydrophilidae	15	Locally abundant in various saline situations, except open seas.
Hydraenidae	3	Locally abundant in small saline pools and about margins of salt ponds, estuaries.
Dryopidae	1	Occasional, brackish estuaries, Europe.
Chrysomelidae	1	Occasional, brackish estuaries, Europe.

'Pseudohalobionten' and 'Limnobionten' (only peripherally occurring in brackish waters). Other workers have verified this pattern in other regions of the world (Keys, 1918; Benick, 1926; Lengerken, 1929a,b; Machura, 1935a,b; Lindberg, 1937, 1944, 1950; Johnsen, 1946; Caspars, 1957; Segerstrale, 1957; Linman, 1965). The reader is referred to the works of Lindberg (1948 and cited references) for more detailed information.

Finally, species which occupy wet intertidal sands but retreat before the incoming water are mentioned only in passing, and the host of species which frequent the supratidal zones of beaches, maritime strands, dunes, or bluffs are omitted. The fauna inhabiting these zones contains highly characteristic elements, but most coastal species may occur up to several miles inland where local topographic features allow a landward extension of the maritime climatic regime. Such species are properly part of the terrestrial fauna.

Under this restricted definition, the Staphylinidae is the dominant family of marine Coleoptera and is dealt with by Moore and Legner in the following chapter. The next most abundant family by number of species is the Carabidae, with about 15 strictly marine members. Nearly all of these belong to genera which are exclusively marine, and this tendency toward generic endemism in marine forms extends to the Limnichidae. In contrast, brackish water species are always members of predominantly freshwater genera, or occur facultatively in either fresh or saline situations.

Only 4 species of *Cercyon* among the Hydrophilidae can be considered marine and marginally so, since they occur under piles of wrack and are submerged only occasionally. A significant fraction of the marine species belong to the families Hydraenidae (sometimes treated as a subfamily of Hydrophilidae) and Limnichidae. Non-marine members are all amphibious or littoral inhabitants of stream



or lakeside environments. The remaining taxa largely represent families which are otherwise terrestrial. Only Chrysomelidae has close relatives in freshwater, while Tenebrionidae are normally inhabitants of arid or subarid habitats! General biological information for various species is listed in Table 18.1.

## 18.3 GENERAL MORPHOLOGY

### *19.3.1 Adult*

Adult Coleoptera are differentiated from other insects by the transformation of the mesothoracic wings into protective sheaths never used in flight (Fig. 18.1). In the great majority of beetles the elytra cover the wings and abdomen, but in the Staphylinidae the elytra are usually abbreviated. In many flightless species elytra are fused along the midline, forming a continuous protective plate over the abdomen. Relative to most insects, beetles have strongly sclerotized cuticle, with overlapping or interlocking segments. The coxae are usually sunk into sockets in the body wall, which limits mobility, but decreases vulnerability to predators (Fig. 18.2).

Most taxonomically important characters of adult beetles are on the venter. Mouthparts are of the chewing type, with unmodified mandibles, maxillae and labium in marine species (Fig. 18.3). Antennae are usually inserted between the eyes and the bases of the mandibles, and normally have 11 segments. Dorsally the oral cavity is covered by the labrum, which may be fused to the clypeus in some taxa. Postero-ventrally on the head capsule are a pair of longitudinal grooves, the gular sutures, which are indications of internal braces to which the mouthpart muscles attach. In the Curculionidae, which have highly modified mouthparts, the gular sutures are reduced to a single medial groove.

The prothorax in beetles is freely articulated with the hind body, and relatively large, forming a distinct body region, especially in strongly ambulatory forms such as Carabidae and Tenebrionidae. The dorsal portion of the pronotum is termed the pronotal disk; the ventral extensions the hypomera (Fig. 18.4). In some taxa the hypomera encroach behind the front coxae, producing a condition of closed front coxal cavities. The prosternum includes the prosternal process, separating the coxae and frequently extending posterad for some distance, where it may interlock with the mesosternum.

The mesothorax is the smallest thoracic segment in Coleoptera, but its dorsal appendages, the elytra, cover the entire dorsum in most beetles. The dorsal portion of the elytra is termed the elytral disk; the lateral margins, usually differentiated by a strong suture and ridge, the epipleura. The scutellum, usually triangular, is the only external manifestation of the mesonotum which is largely

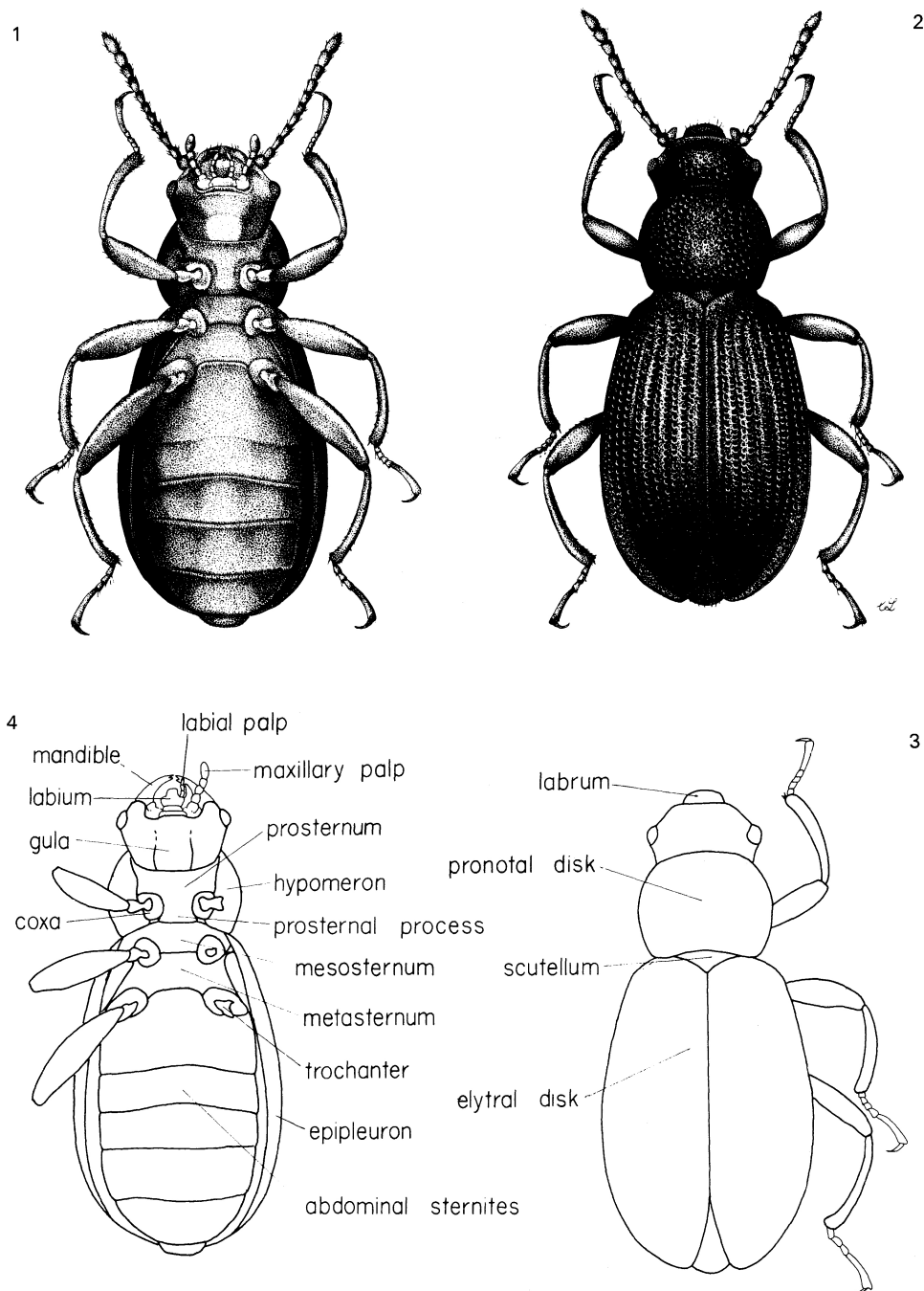

*Figs. 18.1–4. Aegialites fuchsi* Horn (Salpingidae). *Figs. 18.1 and 4. Ventral aspect. Figs. 18.2 and 3. Dorsal aspect. (Illus. by Celeste Green.)*

retracted into the prothorax. Ventrally, mesopleural sclerites and the mesosternum appear as distinct sclerites.

In most Coleoptera, the metanotum and abdominal tergites are desclerotized or sometimes completely membranous, being protected by the overlying elytra. The metathoracic wings, when present, are retracted beneath the elytra when not in use, through a complex series of apical foldings. The metapleura, metasternum and abdominal sternites are strongly sclerotized plates covering the posterior ventral half of the beetle. The metacoxae articulate posterad of the metasternum. Separating the coxae is the intercoxal process of the first abdominal sternite, and running anterad along the midline of the metasternum, the metasternal suture, which marks an internal skeletal invagination. One or more of the terminal abdominal segments are telescoped internally and not visible without dissection.

The legs in all Coleoptera consist of a proximal coxa, frequently enclosed in a socket in the body wall, and, distally, a small trochanter, a femur, tibia and tarsus. The femur and tibia are not often modified, but in Carabidae the tibial apex is frequently specialized as a complex antennal cleaning apparatus. Apical tibial spurs are almost universal among Coleoptera. The tarsus usually consists of four or five segments, the terminal segment with paired claws, with a small empodium between them. Special adhesive organs, such as pulvilli, do not commonly occur in Coleoptera.

### *18.3.2 Larva*

Coleopterous larvae are characterized by a sclerotized head capsule and mandibulate mouthparts, with maxillae, labium and labrum comparable to the homologous adult structures (Figs 18.5 and 6). Antennae usually consist of 3 or 4 segments; eyes are represented by lateral ocelli (stemmata), sometimes in characteristic numbers or patterns. Three differentiated thoracic segments with ambulatory legs are present in all but Curculionidae and a few other forms which usually feed within plant tissues. Legs are 4- or 5-segmented with one or two apical claws. Eight or 9 similar segments, never with ambulatory appendages comprise the abdomen (Fig. 18.7). Many species bear terminal appendages, either segmented or not, and of diverse configuration, on the terminal abdominal segments. These appendages, not homologous to legs, are collectively referred to by the term urogomphi, and are of great importance in species characterization and recognition.

Pupation usually occurs in a cell formed by the last instar larva (prepupa), without a cocoon, although at least one marine member, *Haemonia*, forms a cocoon. Pupae have the legs and wings free of the body (exarate), but are incapable of locomotion.

5

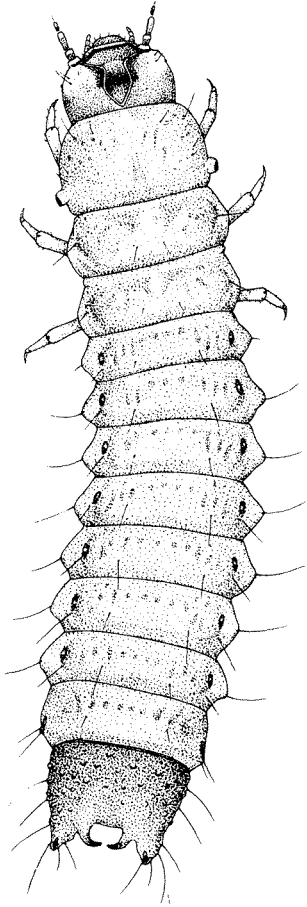

7

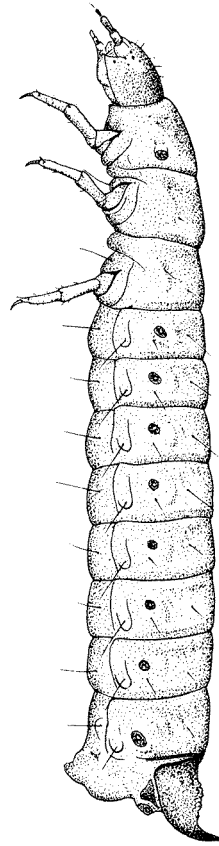

6

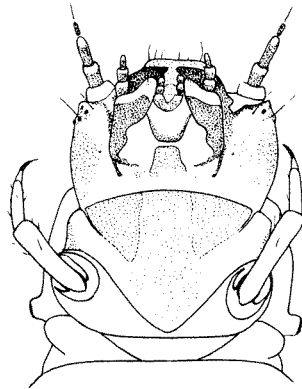

Figs. 18.5–7. *Aegialites fuchsi* larva. (Illus. by Celeste Green.)

Fig. 18.5. Dorsal (left) aspect.

Fig. 18.6. Ventral aspect of head and prothorax.

Fig. 18.7. Lateral aspect.

## 18.4 SYSTEMATICS AND IDENTIFICATION

There are ten taxonomic surveys of marine Coleoptera. Leech and Chandler (1956), though primarily concerned with the freshwater fauna of California, mentioned some marine species which are later treated in more detail by Doyen (1975). Early surveys of the British marine Coleoptera (Keys, 1918; Walsh, 1925, 1926), include nearly all the north Atlantic species, and are still valuable today. Numerous inventories of the North Sea and Baltic Sea (Lengerken, 1929a,b; Lindberg, 1937, 1944, 1948, 1950; Segerstrale, 1957; Linman, 1965) have made its fauna probably the best known of any comparable sized body of water. The salinity of the Baltic Sea varies from slightly brackish to nearly as high as sea water, but the beetles represent a brackish water fauna, with almost no species in common with the north Atlantic. No comprehensive studies of the Mediterranean exist (local species lists are given by Seurat, 1924, 1930; Peyerimhoff, 1927; Kocher, 1966), and there is only fragmentary knowledge of other regions. Sato (1963–4) lists about 15 ‘marine’ species from Japan and neighbouring islands, but many of these appear to be halophilous forms which occasionally enter the upper intertidal. Especially poorly known are tropical seas, where most undescribed species will probably be found. Worthy of mention here are a few works detailing limited taxonomic groups on a worldwide basis. Jeannel’s monograph of the Trechinae (1926–8) provides a valuable taxonomic guide to the major group of marine Carabidae. Spilman’s (1967) detailed treatment of the marine Salpingidae presents keys and detailed systematic discussions, with references to studies of biology, ecology, and distribution.

The following key includes only species regularly spending a portion of their lives below the high tide line. The myriad of species which occur on sandy beaches, coastal sand dunes, or other maritime habitats, only occasionally wandering into the intertidal, are best identified using general taxonomic works. The numerous species inhabiting saline ponds, brackish lakes, or casually entering inland seas are almost always included in treatments of freshwater faunas. Useful general works on aquatic Coleoptera include Leech and Chandler, 1956 (Pacific coast of North America); Young, 1954 (Southeastern United States); Bertrand, 1954 (Europe), 1972 (World); Balfour-Browne, 1950 (Britain).

### KEY TO GENERA OF MARINE COLEOPTERA (ADULTS ONLY)

- |   |                     |
|---|---------------------|
| 1. First visible abdominal sternite completely divided by hind coxal cavities<br>(suborder Adephaga)        | 2                   |
| First visible abdominal sternite transversely complete (suborder Polyphaga)                                 | 14                  |
| 2. Hind coxae greatly expanded, covering first 3 abdominal sternites  | <i>Haliplidae</i> * |
| Hind coxae small, not completely covering first abdominal sternite  | 3                   |
| 3. Hind legs flattened, with long hairs or spines for swimming; body and<br>appendages streamlined, rounded | <i>Dytiscidae</i> * |

Hind legs cylindrical, without swimming hairs or spines; body and appendages not streamlined (Carabidae)	4
4. Middle coxal cavities entirely closed by sterna	6
Middle coxal cavities not entirely closed by sterna (Scaritini)	5
5. Pronotum with two or three pairs of oblique, longitudinal grooves	<i>Halocoryza</i>
Pronotum convex, globular, without longitudinal grooves	<i>Dyschirius</i>
6. Maxillary palp with terminal segment subequal to preceding segment	7
Maxillary palp with terminal segment small, only about one third length of preceding segment (Bembidiini)	<i>Bembidion</i> (including <i>Cillenius</i> , <i>Lymnaeum</i> )
7. Head with frontal grooves curving postero-laterally behind eyes (Fig. 18.8) (Trechini, in part)	8
Head with frontal grooves not extending behind eyes	13
8. Elytra short, exposing 1 or 2 abdominal segments	11
Elytra completely covering abdomen	9
9. Body surface glabrous, shining	10
Body surface pubescent, dull	<i>Perileptus</i>
10. Pronotum with posterior corners rounded, obtuse	<i>Thalassobius</i>
Pronotum with posterior corners angulate, slightly acute or right angled	<i>Thalassodualius</i>
11. Labium with median tooth single	12
Labium with median tooth double or bifid	<i>Aepus</i>
12. Apical margin of elytra transverse, straight	<i>Temnostega</i>
Apical margin of elytra as 2 round lobes (Fig. 18.8)	<i>Aepopsis</i>
13. Elytra with apical margin truncate, transverse (Trechini, in part)	<i>Kenodactylus</i>
Elytra with apical margin rounded, not truncate (Pogonini)	<i>Thalassotrechus</i>
14. Antennae about twice as long as maxillary palpi; last 3 to 5 segments abruptly enlarged as a pubescent club	15
Antennae at least 4 times as long as maxillary palpi; filiform or with last 2 or 3 segments enlarged as club	17
15. Antennae with 5 pubescent segments; abdomen with 6 or 7 visible sternites (Hydraenidae)	16
Antennae with 3 pubescent segments; abdomen with 5 visible sternites (Hydrophilidae). (Fig. 18.9)	<i>Cercyon</i>
16. Epistomal region of males expanded anterodorsally as a pair of very strong tubercles (Fig. 18.10)	<i>Meropathus</i>
Epistomal region not produced as tubercles	<i>Ochthebius</i>
17. Elytra abbreviated, exposing at least 3 abdominal tergites	20
Elytra complete, exposing one tergite at most	18
18. Antennae with first segment as long as succeeding 5 segments; head prolonged anteriorly as a rostrum (Curculionidae)	19
Antennae with first segment no longer than succeeding 3 segments; head not prolonged as rostrum	21
19. Body black, dorsoventrally flattened; rostrum thick, truncate (Fig. 18.11) <i>Mesembriorrhinus</i>	
Body pale, translucent yellow, strongly convex; rostrum cylindrical, more slender	<i>Emphyastes</i>
20. Prothorax and abdomen with yellow or orange protrusible vesicles (Fig. 18.12) (Melyridae)	<i>Endeodes</i>
Prothorax and abdomen without protrusible vesicles (see Ch. 19)	<i>Staphylinidae</i>
21. Tarsi expanded ventrally as finely, densely pubescent pads	<i>Haemonia</i>
Tarsi slender; spinose or coarsely setose	22
22. Tarsal segmentation 5-5-5** or 4-4-4 or 3-3-3	27
Tarsal segmentation 5-5-4	23

23.	Anterior coxal cavities open posteriorly	24
	Anterior cavities closed posteriorly by the hypomeron (Tenebrionidae)	26
24.	Head deflexed, strongly, abruptly constricted behind eyes	<i>Anthicidae</i> *
	Head not deflexed, not abruptly constricted behind eyes (Salpingidae)	25
25.	Coxae widely separated	<i>Aegialites</i>
	Coxae nearly contiguous	<i>Antarcticodromus</i>
26.	Anterior tibiae flat, spinose, adapted for digging	<i>Phaleria</i>
	Anterior tibiae slender, not flattened, spinose	<i>Epantius</i>
27.	Antennae with prominent terminal club; body linear, elongate	<i>Phyconomus</i>
	(Rhizophagidae)	
	Antennae slender, without terminal club (intermediate segments may be enlarged); body oval or elongate oval	28
28.	Mandibles large, prognathous, extending horizontally in front of head	<i>Heteroceridae</i> *
	Mandibles small, hypognathous, directed ventrally beneath head	29
29.	Head retracted into prothorax; body compact, subglobular, strongly sclerotized	30
	(Fig.18.13) (Limnichidae)	
	Head not retracted into prothorax; body loosely articulated, with leathery, flexible cuticle (Melyridae)	<i>Laius</i>
30.	Tarsal segmentation 5-5-5; eyes separated by less than breadth of one eye	<i>Throscinus</i>
	Tarsal segmentation 4-4-4; eyes separated by more than breadth of one eye	31
31.	Antennae with 7 segments (Fig. 18.13)	<i>Martinius</i>
	Antennae with 11 segments	<i>Mexico</i>

\* Typical of brackish water or other saline situations, but without exclusively subtidal members and keyed only to family here.

\*\* No. of segments in anterior, middle and posterior tarsi, respectively.

## 18.5 BIOLOGY

Being mostly crevice dwellers, marine Coleoptera are not easily observed, and relatively little is known of their biology. Adults of many occur at all times of the year (Keen, 1903; Hase, 1926; Spilman, 1967). Larvae typically occur in the same microhabitat as adults and may frequently be identified by association with the adult beetles.

### 18.5.1 Beetles of rocky shores

A typical member of the crevice dwellers which are restricted to rocky shores is *Aepopsis robini* (Laboulbene) (Fig. 18.8), whose general biology has been studied sporadically by many workers (Audouin, 1833; Coquerel, 1850; Plateau, 1890; Miall, 1895; Alluaud, 1926). This carabid occupies fractures in rocks as well as the undersides of large stones in the intertidal from Britain and France south to Spain and Morocco. It is frequently abundant in local colonies. Larvae and adults occur throughout the year. Pupae have been taken in August and September (Masne, 1938), and pupal development in the laboratory requires 14–16 days at 18°C (comparable to temperatures in the natural environment). The entire life

cycle occurs within crevices (Audouin, 1833; Plateau, 1890; Alluaud, 1926; Masne, 1938), except for brief periods at low tides, when the beetles may forage in the open. *Aepopsis* is apparently a predator. According to Glynn-Williams and Hobart (1952) the prey is chiefly *Anurida maritima*; older accounts report that small molluscs are utilized, probably because the beetles commonly occur in association with *Rissoa* and other snails.

Although differing in details, the life histories of many crevice dwellers are broadly similar to that of *Aepopsis*. Members of the Carabidae are presumably all predators (Leech and Chandler, 1956; Darlington, 1967) although little specific information exists. *Aegialites* has been reported to feed both on oribatid mites (Spilman, 1967) and marine algae (Sugihara, 1938). Apparently there is some variation in feeding habits among different species. *Aegialites* also shows inter-specific variation in habitat preference. *A. subopacus* (Van Dyke) and *A. californicus* (Motschoulsky) apparently occur well within the intertidal (Keen, 1903; Van Dyke, 1918), while *A. stejnegeri* (Linell) ranges into the high intertidal, where the adults emerge from their retreats and crawl about on rocks surfaces at low tide (Sugihara, 1938). As in *Aepopsis*, larval development and pupation occur in the same crevices where the adults live. Adults have been collected during various seasons, but larvae and pupae are apparently restricted to the summer months (Spilman, 1967, summarizes data). In *Antarcticodromus fallai* Brooks (Fig. 18.14) a subantarctic island species, larvae are known only from February, the warm season in the southern hemisphere. Insufficient numbers of species have been studied to determine whether reproductive periods might be correlated with temperatures, or with tidal characteristics, or other factors.

Pupation occurs in rock crevices, and in some species a special pupal chamber has been observed (Moore, 1956; *Endeodes*). A protective pupal chamber is probably formed by most species, but has been recorded for only a few.

### 18.5.2 Beetles of sandy beaches and mud flats

In comparison to rocky shores, which support relatively few supratidal Coleoptera, sand beaches are inhabited by numerous species with varying degrees of dependence on and adaptation to marine environments. Adult cicindelids and some staphylinids are the most obvious beetle inhabitants of the high intertidal. These species are extremely mobile, actively avoiding submersion, and are basically terrestrial organisms living near the sea. Their larvae normally occur well above the intertidal, and are submerged only during storms, or very briefly during exceptionally high tides. Also included in this group are a variety of other beetles of diverse families such as Anthicidae, Melyridae, Lathridiidae, Oedemeridae and Ptiliidae, which frequent the drift line, feeding on decaying wrack. These beetles are characteristic of seashores, but are not aquatic and are very seldom submerged.



Other species, less mobile or occurring lower in the intertidal zone, are probably regularly submerged by high water. This group includes some Carabidae (*Cillenus*, *Dyschirius*, *Halocoryza*), the maritime hydrophilids of the genus *Cercyon*, at least one species of *Heterocerus* (Heteroceridae) a few limnichids, the tenebrionids *Phaleria* and *Epantius*, and the rhizophagid *Phyconomus*. *Cillenus* and *Dyschirius* actively move about the sand during low tides and are associated with staphylinids of the genus *Bledius*, upon which they apparently feed (Haliday, 1837; Bro Larsen, 1952; Amanieux, 1969). During high tides they seek shelter in the burrows of *Bledius* or Crustacea, or beneath stones. *Cercyon*, *Phaleria*, *Epantius* and *Phyconomus* are associated with beached algae or dead fish, and may occur on shingle beaches, but are more prevalent on sand substrates. On the California coast of North America *Cercyon* occupies nearly every sizeable heap of wrack and is restricted to its food substrate, but *Phaleria*, *Epantius* and *Phyconomus* are frequently found buried in the sand about their food, sometimes to a depth of 10 cm or more. All of these species are common in supratidal sands, where they are usually associated with Staphylinidae, Histeridae, Anthicidae and other Coleoptera, and only marginally occupy the intertidal zone. *Phaleria* and *Cercyon* are characteristic of beaches in all but the arctic and antarctic; *Epantius* and *Phyconomus* are restricted to the Pacific coast of North America. Probably many other temperate and tropical beaches support biologically comparable species. The limnichids *Martinius* (Fig. 18.13) and *Throscinus* inhabit mud or sand flats in estuaries (Leech and Chandler, 1956; Spilman, 1966), but it is uncertain whether they are ever submerged or not.

### 18.5.3 Beetles of other habitats

A few beetles apparently occur on both rocky and sandy shores. *Endeodes* (Melyridae) (Fig. 18.12) commonly occupies both situations, with differences among the various species. *Ephyastes* (Curculionidae) is prevalent beneath *Fucus* on sand beaches, but also occurs in rock crevices (Doyen, unpublished). *Laius* (Melyridae) are stated to occur beneath stones on beaches (Paulian, 1959, 1961), but probably frequent decaying seaweed as well.

An unusual habitat is that of some species of *Haemonia* (Chrysomelidae) which feed on the seagrass *Zostera*. The habits and life history are similar to those of *Donacia*, a related beetle which is restricted to freshwater. Larvae of both genera spend their entire lives submerged, feeding on their host plants, whose stems they apparently pierce with their sclerotized urogomphi (Boving, 1910; Collins, 1911). The large, posterior spiracles are situated terminally in a position to use the air contained by the plant stem. *Haemonia* displays specializations which were apparently developed in freshwater forms, and is in fact only marginally marine, being largely restricted to bays and estuaries, or brackish inland waters.

According to Jeannel (1940, 1953), the larvae of the weevil *Mesembriorrhinus*

*eatoni* (Waterhouse) are subtidal, developing in tufts of algae. Pupation occurs above the high water line in clumps of the moss *Grimmia amblyophylla* C.M. Adults inhabit rock crevices in the mid to upper intertidal. If Jeannel's account is correct, *Mesembriorrhinus eatoni* (Fig. 18.11) is unique among the Coleoptera in regularly migrating from marine to terrestrial habitats each generation. It is unknown how the legless larvae move to their supratidal pupation site, or how such specialized habits arose in this species, since other members of the genus are strictly terrestrial.

## 18.6 ECOLOGY

In adult beetles some of the most obvious adaptations to aquatic life include streamlining of the body and legs for swimming, and elongation of tarsi and enlargement of tarsal claws as holdfast organs. Some species possess special pubescence or micro-sculpturing of the ventral cuticle, so that a thin layer of air is held next to the body (see Hinton, Ch. 3). The larvae may be flattened for entering narrow spaces or burrowing, and may bear gills on various parts of the body. A few specializations of this sort are found in marine beetles.

### 18.6.1 Respiratory adaptations

*Ochthebius quadricollis*, which occupies splash pools and other protected microhabitats, respire by means of an air supply retained by the hydrofuge ventral cuticle (Fig. 18.15) (Hase, 1926). It commonly clings to the surface film, extending an antenna through the film to replenish its air supply. In general, however, marine Coleoptera possess none of the specializations of freshwater aquatic beetles, but are remarkably similar to related terrestrial species. It was demonstrated very early that marine insects, including beetles, are capable of prolonged submersion (Coquerel, 1850; Moniez, 1890; Plateau, 1890). Apparently however, most species are only occasionally in direct contact with water. Most crevice-dwelling species occupy only deep, narrow fissures, utilizing air entrapped in these refuges (Alluaud, 1926; Masne, 1938; Kensler, 1967). Similarly, beach and mud-flat inhabitants rely on air retained in burrows or beneath large stones (Baudoin, 1949). Staphylinids such as *Diglossa* and *Bledius* construct their own burrows, but most beach beetles utilize tunnels made by crustacea or other insects.

Masne (1938) subjected pupae of *Aepopsis* to different conditions, finding that submersion of only a few hours resulted in death. The pupa of *Aepopsis* is rather densely clothed with long setae, but these did not retain a significant layer of air during submersion. Probably the setae serve to prevent direct contact of the pupal cuticle with the substrate. In general, aquatic Coleoptera leave the water to pupate; only the freshwater *Psephenoides* (Psephenidae) actually has the pupal

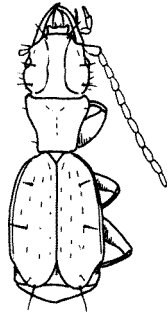

Fig. 18.8. *Aepopsis robini* Laboulbene, 2 mm (after Jeannel, 1926).

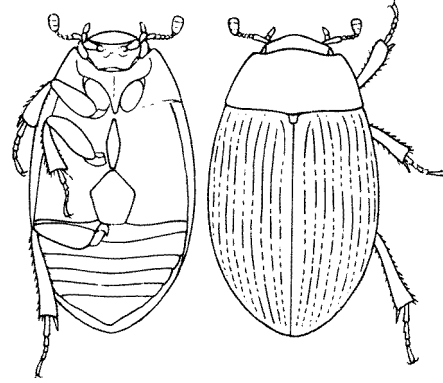

Fig. 18.9. *Cercyon fimbriatus* Mannh. 2 mm (after Jeannel, 1926).

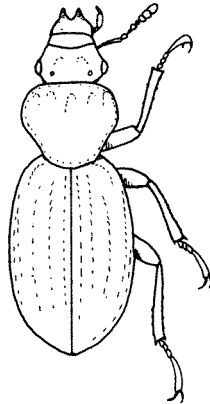
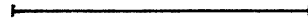

Fig. 18.10. *Meropathus chuni* Enderlein, 2 mm (after Jeannel, 1940).

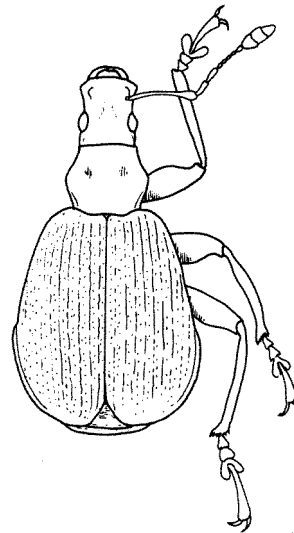

Fig. 18.11. *Mesembriorrhinus eatoni* Water-house, 3.5 mm (after Jeannel, 1940).

Figs. 18.8—15. Representative marine Coleoptera. Length of scale line follows name for each figure.

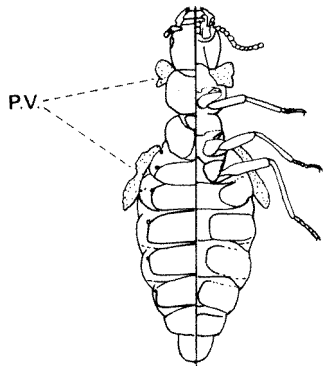

Fig. 18.12. *Endeodes collaris* LeConte, 5 mm  
p.v. = protrusible vesicles (after Blackwelder, 1932).

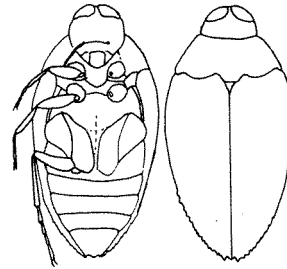

Fig. 18.13. *Martinus* sp., 1.7 mm (after Spilman, 1959).

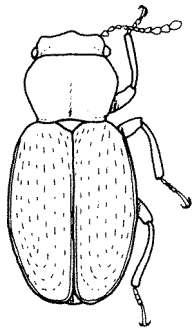

Fig. 18.14. *Antarcticodromus fallai* Brookes,  
3.4 mm (after Spilman, 1967).

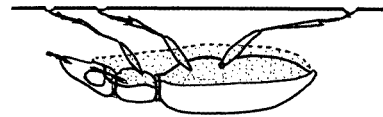

Fig. 18.15. *Ochthebius quadricollis* Mulsant, clinging to  
surface film of water (after Hase, 1926).

cuticle in contact with the water (Leech and Chandler, 1956). This is probably one factor which has limited the Coleoptera to the intertidal in marine habitats.

It seems likely that most marine Coleoptera rely exclusively on trapped air for respiration, and probably restrict their activities to air pockets during periods of submergence. The transitory contact of most marine beetles with seawater explains the general absence of morphological features specialized for aquatic existence. Miall (1895) described an enlargement of the terminal tracheae in *Aepopsis robini* (Carabidae) as internal sacs which may function as air reservoirs (Jeannel, 1926), but no detailed studies have been made. It is possible that the sacs are actually the defensive gland reservoirs. The only other forms with respiratory specializations are larvae of the chrysomelids *Haemonia*, in which the urogomphi and terminal spiracles are used for extracting air from aquatic plants, as mentioned earlier.

### 18.6.2 Wing modifications and dispersal

The most common morphological modification in marine beetles is probably the loss of wings. The entire carabid tribe Aepini, as well as *Thalassotrechus* and all marine salpingids and limnichids, and the weevil *Emphyastes* are flightless. Some of them, especially the Carabidae (Jeannel, 1953), have abbreviated elytra, but in many the elytra are immovably joined along the midline. The resulting subelytral cavity is possibly used to retain an air supply. Spilman (1972) describes the details of closure of the subelytral space in several limnichids, where the lateral elytral edges and apex interlock with the abdominal sternites to effect a tight seal.

A number of marginally marine forms such as *Phaleria*, *Heterocerus*, and many beach staphylinids are active flyers. A species of *Phaleria* (Doyen, unpublished) and one of *Cafius* (Staphylinidae) (Moore and Legner, 1973) have colonized the Salton Sea of southern California, which is more than 100 km from the nearest oceanic waters. Leech (1949) mentions other inland occurrences of normally maritime species. Many coastal forms with well developed wings, such as *Cercyon* and *Phyconomus*, apparently fly infrequently (Leech and Moore, 1971), probably during favourable weather.

Dispersal mechanisms used by the flightless species are unknown. Possibly ocean currents carry adults or larvae about, although both seem very ill-adapted for prolonged exposure to open water, and are not listed among species recovered from sea-drift (Baudrimont, 1921; Palmen, 1950). However, patches of favourable habitat, such as rocky headlands isolated on mainland coasts or even oceanic islands, have been colonized by various species, indicating effective dispersal.

Local movements, either by crawling or flying, probably maintain populations at the proper tidal levels. *Thinopinus* (Staphylinidae) was observed to shift seaward or landward in accordance with seasonal differences in tidal height (Craig, 1970). Solar orientation, apparently used in moving to and from the tide line has been



demonstrated in *Phaleria* (Pardi, 1955, 1958). The lower intertidal species, such as the trechine carabids and the salpingids probably also undergo seasonal changes in position as tidal heights fluctuate, but such movements are unrecorded.

### 18.6.3 Distribution

Our present knowledge indicates that marine Coleoptera are concentrated in temperate and cold seas. If only species definitely known to be restricted to intertidal or subtidal habitats are considered, a striking bipolar distribution is evident (Fig. 18.16). The Aepini (Carabidae) occur in the North Atlantic (Scandinavia to the Madeira Islands) and in the Antarctic and Subantarctic, including southern regions of South America. The Aegialitini (Salpingidae) and Curculionidae have representatives in the north Pacific and Subantarctica, while the Hydraenidae have one genus represented in both north temperate Atlantic and Pacific, and another in the Antarctica. Only a few taxa are recorded from tropical regions, and most of these are representatives of widespread genera, such as *Phaleria* and *Cercyon*. Moreover, the tropical fauna appears to consist of species which spend the bulk of their lives in the supratidal zone, with the possible exception of the Limnichidae.

Whether the lack of records of intertidal forms in the tropics is a sampling artifact or reflects an actual absence is uncertain. There seems to be no biological reason for the absence of a rich intertidal Coleoptera fauna in the tropics.

## REFERENCES

- Alluaud, C. (1926) Observations sur la faune entomologique intercotidale. Bull. Soc. Zool. Fr. 51, 152–154.
- Amanieux, M. (1969) Recherches écologiques sur les Faunes des plages arborées de la région d'Arcachon. Helgol. Wiss. Meeresunters 19, 455–557.
- Arnett, R. (1960) The Beetles of the United States. (, ) 1048 pp.
- Audouin, J.V. (1833) Observations sur un insect coléoptère, qui passe en grande parti sa vie sous la mer (*Blenus fulvescens* Sam. = *Aepus marinus* Strum). Nouv. Ann. Mus. Hist. Nat. (Paris) 3, 117–127.
- Balfour-Browne, F. (1940) British Water Beetles. Vol. I. (: ) 375 pp.
- Balfour-Browne, F. (1950) British Water Beetles. Vol. II. (: ) 394 pp.
- Baudoin, R. (1949) Les sables bulleux, refuge de certains insectes intercotidaux du littoral des Charentes. Bull. Soc. Zool. Fr. 74, 160–164.
- Baudrimont, A. (1921) Coléoptères et chasse à la marée. Proc. Verb. Soc. Linn. Bordeaux 73, 36–38.
- Benick, L. (1926) Die Käfer der Oldesloer Salzstellen. Mitt. Geogr. Ges. Naturh. Mus. Lubeck 31, 59–90.
- Bertrand, H. (1954) Les Insectes Aquatiques d'Europe. Encyclopédie Entomologique. 30, 1–556.
- Bertrand, H. (1972) Larves et Nymphes des Coléoptères Aquatique du Globe. (, ) 804 pp.

- Blackwelder, R.E. (1931) The Sphaeridiinae of the Pacific Coast (Coleoptera, Hydrophilidae). *Pan-Pac. Entomol.* 8, 19–32.
- Blackwelder, R.E. (1932) The genus *Endeodes* LeConte (Coleoptera, Melyridae). *Pan-Pac. Entomol.* 8, 128–136.
- Böving, A. (1910) Natural history of the larvae of Donaciinae. *Int. Rev. Hydrobiol. Hydrograph.* 3 (suppl. 1) 1–108.
- Bro Larsen, E. (1952) On subsocial beetles from the salt marsh, their care of progeny and adaptation to salt and tide. *Trans. IXth Int. Congr. Entomol.* 1, 502–506.
- Carpenter, G. (1901) The insects of the sea. *Knowledge (Lond.)* 24, 114–116, 160–163.
- Caspers, H. (1957) Black Sea and Sea of Azov. In: *Treatise on Marine Ecology*, Ch. 25 (J. Hedgepeth, Ed.) pp. 801–890.
- Cazalet, M. (1936) Recherches bionomiques sur l'estuaire du Frémur (Limité des Côtes-du-Nord et l'Ille-et-Vilaine. *Bull. Soc. Sci. Bretagne* 12, 205–237.
- Collins, J. (1911) Notes on the early stages of *Haemonia appendiculata*, Panz. *Entomol. Mon. Mag.* 47, 248–250.
- Coquerel, C. (1850) Note pour servir a l'histoire de l'*Aepus robinii* et description de sa larve. *Ann. Soc. Entomol. Fr.* 2(8) 529–532.
- Craig, P. (1970) The behavior and distribution of the intertidal sand beetle, *Thinopinus pictus* (Coleoptera: Staphylinidae). *Ecology* 51, 1012–1017.
- Darlington, P.J., Jr. (1964) Insects of Campbell Island. Coleoptera: Carabidae. *Pac. Insects Monogr.* 7, 335–339.
- Doyen, J.T. (1975) Intertidal insects: order Coleoptera. In: *Intertidal Invertebrates of the Central California Coast*. (R.I. Smith, Ed.), pp. 446–452.
- Evans, W. (1968) Some intertidal insects from western Mexico. *Pan-Pac. Entomol.* 44, 236–241.
- Evans, W. (1970) *Thalassotrechus barbarae* (Horn) and the Santa Barbara oil spill. *Pan-Pac. Entomol.* 46, 233–237.
- Glynn-Williams, J. and Hobart, J. (1952) Studies on the crevice fauna of a selected shore in Anglesey. *Proc. Zool. Soc. Lond.* 122, 797–824.
- Haliday, A.H. (1837) Notes about *Cillenum* and a submarine species of Aleocharidae. *Entomol. Mag.* 4, 251–253.
- Hase, A. (1926) Zur Kenntnis der Lebensgewohnheiten und der Umwelt des marinen Käfers *Ochthebius quadricollis* Mulsant (Hydrophilidae): *Int. Rev. Ges. Hydrobiol. Hydrogr.* 16, 141–179.
- Hedgepeth, J. (1957) *Treatise on Marine Ecology and Paleocology*. Ch. 23, Part II. Biological Aspects. *Estuaries and Lagoons. Geol. Soc. Am. Mem.* 67, (, ).
- Jeannel, R. (1926) Monographie des Trechinae. *l'Abeille* 32, 440.
- Jeannel, R. (1940) Croisière du Bougainville aux Iles Australes Françaises. III. Coléoptères. *Mem. Mus. Hist. Nat. Paris* 14, 63–201.
- Jeannel, R. (1941) Coléoptères carabiques, première partie. *Faune Fr.* 39, 1–571.
- Jeannel, R. (1953) Sur la faune entomologique de l'île Marion. *Rev. Fr. Entomol.* 20, 161–167.
- Johnsen, P. (1946) The rock-pools of Bornholm and their fauna. *Dansk Naturhist. For. Kobenhavn Vielensk. Meddel.* 109, 1–53.
- Keen, J.H. (1903) *Aegialites debilis*, Mann. *Can. Entomol.* 35, 125–126.
- Kensler, C. (1967) Desiccation resistance of intertidal crevice species as a factor in their zonation (Mollusca, Crustacea, Insecta). *J. Anim. Ecol.* 36, 391–406.
- Keys, J. (1918) A list of the maritime, sub-maritime and coast-frequenting Coleoptera of South Devon and South Cornwall. *J. Mar. Biol. Assoc.* 11, 497–513.
- Kocher, L. (1966) Les Coléoptères 'marins' du Maroc. *CR Seances Mens. Soc. Sci. Nat. Phys. Maroc* 32(2) 4–5.
- Kono, H. (1936) On a rare beetle, *Aegialites californicus* (Motschoulsky). *Kôntyu* 10, 141–145. (In Japanese).



- Kono, H. (1938) An intertidal rock-dwelling beetle, *Aegialites stejnegeri*, and its one new subspecies. Entomol. World 6, 1–5. (In Japanese).
- Leech, H.B. (1949) New species and subspecies of nearctic water beetles (Coleoptera: Dytiscidae and Hydrophilidae). Wasmann J. Biol. 7, 243–256.
- Leech, H.B. and Chandler, H.P. (1956) Aquatic Coleoptera. In: Aquatic Insects of California. (R.L. Usinger, Ed.), 508 pp.
- Leech, H. and Moore, I. (1971) Nearctic records of flights of *Cafius* and some related beetles at the seashore (Coleoptera: Staphylinidae and Hydrophilidae). Wasmann J. Biol. 29, 65–70.
- Lengerken, H. (1929a) Halophile and halobionte Coleoptera. Tierw. Nord- und Ostsee (Leipzig) 11e, 1–32.
- Lengerken, H. (1929b) Die Salzkäfer der Nord- und Ostsee Kuste. Z. Wiss. Zool. 135, 1–162.
- Lindberg, H. (1937) Okologiske Studien über die Coleopteren und Hemipterenfauna in Meere in der Poie-Wiek und im Scharenarchipel von Ekenas in Sudfinnland. Acta. Soc. Fauna Flora Fenn. 60, 516–572.
- Lindberg, H. (1944) Okologisk-geographische Untersuchungen zur Insektenfauna der Felsentempel an den Küsten Finnlands. Acta Zool. Fenn. 41, 1–178.
- Lindberg, H. (1948) Zur Kenntnis der Insekten-fauna im Brackwasser des Baltischen Meeres. Finska Vet. Soc. 10, 1–206.
- Lindberg, H. (1950) Ueber die Insekten der Küstengewässer des Baltischen Meeres. Proc. 8th Int. Congr. Entomol. (1948) 1950, 429–433.
- Linell, M. L. (1898) A new species of *Aegialites*. Can. Entomol. 30, 74–75.
- Linman, N. (1965) On the beetle fauna of the Karlso Islands. Opusc. Entomol. 30, 183–210.
- Machura, L. (1935a) Zur Biologie und geographischen Verbreitung der halophilen Coleopteren und Rhynchoten des Neusiedler Seegebietes. Zool. Anz. (Leipzig) 110, 77–90.
- Machura, L. (1935b) Oekologische Studien im Salzlackengebiet des Nausiedlersees, mit besonderer Berücksichtigung der halophilen Koleopteren und Rhynchotenarten. Z. Wiss. Zool. (Leipzig) 146, 555–590.
- Masne, G. (1938) La Nymphe d'*Aepopsis robini* Lab. Description et biologie. Bull. Soc. Zool. Fr. 63, 68–72.
- Miall, L.C. (1895) The Natural History of Aquatic Insects. (). 395 pp.
- Moniez, R. (1890) Acariens et insects marins des côtes du Boulonnais. Rev. Biol. N. Fr. 2, 403–408.
- Moore, I. (1954) Notes on *Endeodes* LeConte with a description of a new species from Baja California. Pan-Pac. Entomol. 30, 195–198.
- Moore, I. (1956) Notes on some intertidal Coleoptera with descriptions of the early stages (Carabidae, Staphylinidae, Malachiidae). Trans. San Diego Soc. Nat. Hist. 12, 207–230.
- Moore, I. (1957) A northern extension of range for *Endeodes basalis* LeConte (Coleoptera, Malachiidae). Pan-Pac. Entomol. 33, 140.
- Moore, I. (1964) A new species of *Endeodes* from Sonora, Mexico (Coleoptera: Melyridae). Pan-Pac. Entomol. 40, 57–58.
- Moore, I. and Legner, E.F. (1973) Speculation on the distribution of the southern California species of *Cafius* with a new record from the Salton Sea. Pan-Pac. Entomol. 49, 279–280.
- Moore, I. and Legner, E.F. (1975) Revision of the genus *Endeodes* LeConte with a tabular key to the species (Coleoptera: Melyridae). J.N.Y. Entomol. Soc. 83, 70–81.
- Nakane, T. (1955) Marine insects of the Tokara Islands V. Three new species of the genus *Laius* Guerin from Kyushu and the Tokara islands, with notes on a species from Marianna. Publ. Seto Mar. Biol. Lab. 4, 373–379.
- Palmen, E. (1950) Sea-drifts of insects as a factor in dispersal. Proc. 8th Int. Congr. Entomol. (1948) 1950, 450–453.
- Pardi, L. (1955) Orientamento solare in un Tenebrionide alofilo: *Phaleria provincialis* Fauv. (Coleoptera). Boll. 1st. Mus. Zool. Univ. Torino 5, 1–39.

- Pardi, L. (1958) Esperienze sull' orientamento solare di *Phaleria provincialis* Fauv. (Coleopt.): Il comportamento a luce artificiale durante l'intero ciclo di 24 Ore. Att. Ace. Sci. Torino, Cl. Sc. Fis. 92.
- Paulian, R. (1959) Observations sur la faune intercotidal de Madagascar. Nat. Malgache (Tananarive) 11, 53–61.
- Paulian, R. (1961) Faune de Madagascar. Vol. 13. La Zoogéographie de Madagascar et des Iles Voisine. (.) 484 pp.
- Peyerimhoff, P. (1927) Coléoptères halophiles ou sablicoles récoltes par M.E. — B. Seurat sur le littoral tunisien (avec la description d'une espèce nouvelle). Bull. Soc. Hist. Nat. Afr. (Algiers) 18, 17–27.
- Plateau, F. (1890) Les Myriapodes marins et la resistance des arthropodes à respiration aeriennne à la submersion. J. Anat. Physiol. Norm. Pathol. 26, 236–269.
- Satô, M. (1963) A new intertidal species of the genus *Ochthebius* Leach from Japan (Coleoptera: Hydraenidae). Trans. Shikoku Entomol. Soc. 7, 129–132.
- Satô, M. (1964a) Studies on the marine beetles in Japan, II. Study on the dytiscid-beetle dwelling in the tide-pool. J. Nagoya Jogakuin Coll. 10, 60–70.
- Satô, M. (1964b) Studies on the marine beetles in Japan, IV. Some remarks on the fauna of marine beetles in Japan. J. Nagoya Jogakuin Coll. 10, 76–81.
- Saunders, L.G. (1928) Some marine insects of the Pacific coast of Canada. Ann. Entomol. Soc. Am. 21, 521–545.
- Segerstrale, S.G. (1957) Baltic Sea. In: Treatise on Marine Ecology and Paleoecology, Vol. 1, Ecology Ch. 24 (J. Hedgpeth, Ed.) pp. 751–800.
- Seurat, L. (1924) Observations sur les limites, les facies et les associations animales de l'étage intercotidal de la petite Syrte (Golfe de Gabes). Bull. Stn. Oceanogr. Salammbo, Tunis 3, 1–72.
- Seurat, L. (1930) Observations nouvelles sur les facies et les associations animales de l'étage intercotidal de la petite Syrte (Golfe de Gabes). Bull. Stn. Oceanogr. Salammbo, Tunis 12, 25–59.
- Spilman, T.J. (1966) A new species of *Martinius* from Cuba (Coleoptera: Limnichidae). Coleopt. Bull. 20, 123–125.
- Spilman, T.J. (1967) The heteromorous intertidal beetles. Pac. Insects 9, 1–21.
- Spilman, T.J. (1972) A new genus and species of jumping shore beetle from Mexico. Pan-Pac. Entomol. 48, 108–115.
- Sugihara, Y. (1938) An observation on the intertidal rock-dwelling beetles *Aegialites stejnegeri sugiharai* Kono, in the Kuriles. Entomol. World 6, 6–12. (In Japanese).
- Uéno, S.-I. (1955) Studies on the Japanese Trechinae (III) (Coleoptera, Harpalidae). Publ. Seto Mar. Biol. Lab. 4, 337–351.
- Uéno, S.-I. (1956) New halophilous trechids of Japan (Coleoptera, Harpalidae). Mem. Coll. Sci. Kyoto Univ. (B) 23, 61–68.
- Van Dyke, E.C. (1918) New intertidal rock-dwelling Coleoptera from California. Entomol. News 24, 303–308.
- Vinson, J. (1956) A new scaritine beetle from Mauritius. Mauritius Inst. Bull. 3, 313–316.
- Walsh, G. (1925) The coast Coleoptera of the British Isles: a study in insect ecology. Entomol. Mon. Mag. 61, 137–150.
- Walsh, G. (1926) The origin and distribution of the coast Coleoptera of the British Isles. Entomol. Mon. Mag. 62, 221–262.
- Whitehead, D. (1966) A review of *Halocoryza* Alluaud, with notes on its relationship to *Schizo-genius* Putzeys (Coleoptera: Carabidae). Psyche 73, 217–228.
- Whitehead, D. (1968) Variation and distribution of the intertidal beetle *Halocoryza arenaria* (Darlington) in Mexico and the United States (Coleoptera: Carabidae). J. N.Y. Entomol. Soc. 77, 36–39.
- Wickman, H.F. (1904a) The metamorphosis of *Aegialites*. Can. Entomol. 36, 57–60.
- Wickham, H.F. (1904b) On the systematic position of the Aegialitidae. Can. Entomol. 36, 356–357.
- Young, F.N. (1954) The Water Beetles of Florida. (.) Vol. 5, 238 pp.

## Intertidal rove beetles (Coleoptera: Staphylinidae)

Ian MooreE.F. Legner

<b>Contents</b>		
19.1	Introduction — Genera with marine members	521
19.2	Systematics — Key to subfamilies	523
	19.2.1 Synopsis of subfamilies with keys to genera	528
19.3	Ecology and distribution	541
	Acknowledgements	543
	References	546

### 19.1 INTRODUCTION

Staphylinidae is a very large family of beetles, containing about 30,000 described species. Most members may be recognized by the very short elytra which leave most of the abdomen exposed. They superficially resemble earwigs but lack pinchers at the tip of the abdomen. About 1% of the species are known to be confined to seashore habitats. Since habitat records are not known for the majority of staphylinids, it is not surprising if we are unaware of the marine habitat of some species. On the Pacific seashore of North America the Staphylinidae comprise a large percentage of the insect fauna, both in number of species and in number of individuals. Most of the species of that area have been named and some of the developmental stages described, but much is still to be learned about their biology and ecology. The marine staphylinid fauna of Europe is at least as well known as that of America; but the fauna of the rest of the world is relatively unexplored.

Staphylinids are found in a variety of habitats usually in the presence of considerable moisture, such as margins of streams, ponds and lakes, damp leaf

mould, rotting fruit, animal excrement or decaying logs. Some are obligatory guests of ants or termites; others may be found in nests of small mammals or birds. A few are ectoparasites on mammals. Many are attracted to lights, particularly in the early evening, and they have been collected in considerable numbers flying at dusk. A few visit flowers apparently to feed on pollen. Although their habitats are quite varied, the large majority are predaceous both as larvae and adults on other insects, snails, etc. In the marine habitat they probably feed on crustacea and other marine organisms as well as larvae of flies found in decaying seaweed, reefs and saltmarshes.

Of the 30 or so subfamilies of the Staphylinidae, only 9 contain members which have been reported as regular inhabitants of the seashore (Moore, 1964e, 1967, 1973b). A list of the subfamilies with marine genera is given below. With 30,000 described species of Staphylinidae it has not been possible to search all of the enormous literature for possible references to marine species, so it is likely that we have not included all the species.

## LIST OF GENERA WITH MARINE MEMBERS

### Family STAPHYLINIDAE

Subfamily Aleocharinae	Subfamily Omaliinae
Tribe Myllaenini	<i>Nesomalium</i>
<i>Brachypronomaea</i>	<i>Omaliomimus</i>
<i>Myllaena</i>	<i>Micralymma</i>
<i>Actocharis</i>	<i>Arpediomimus</i>
<i>Bryothinusa</i>	<i>Omalium</i>
<i>Halorhadinus</i>	Subfamily Oxytelinae
Tribe Bolitocharini	<i>Thinobius</i>
<i>Arena</i>	<i>Bledius</i>
<i>Paractocharis</i>	<i>Psamathobledius</i>
<i>Halmaeusa</i>	<i>Microbledius</i>
<i>Corallis</i>	<i>Sartallus</i>
<i>Phytosus</i>	<i>Carpelimus</i>
<i>Thinusa</i>	<i>Oxytelus</i>
<i>Liparocephalus</i>	Subfamily Proteininae
<i>Baeostethus</i>	<i>Proteinus</i>
<i>Amblopusa</i>	Subfamily Xantholininae
<i>Bryobiota</i>	<i>Hypnogyrus tricolor</i>
<i>Heterota</i>	Subfamily Quediinae
<i>Cameronium</i>	<i>Heterothops</i>
<i>Diaulota</i>	
Tribe Oligotini	
<i>Oligota</i>	

Tribe Diglottini	Subfamily Paederinae
<i>Diglotta</i>	<i>Chetocephalus</i>
Tribe Myrmedoniini	<i>Medon</i>
<i>Falagria</i>	Subfamily Xanthopyginae
<i>Tachyusa</i>	<i>Thinopinus</i>
<i>Myrmecopora</i>	<i>Hadropinus</i>
<i>Drusilla</i>	<i>Hadrotus</i>
<i>Pontamalota</i>	Subfamily Staphylininae
<i>Acticola</i>	<i>Thinocafius</i>
<i>Atheta</i>	<i>Cafius</i>
<i>Halobrecta</i>	<i>Phucobius</i>
<i>Iotarphia</i>	<i>Orthidus</i>
<i>Tarphiota</i>	<i>Philonthus</i>
Tribe Oxypodini	
<i>Chilodera</i>	
<i>Oxypoda</i>	
Tribe Aleocharini	
<i>Aleochara</i>	

## 19.2 SYSTEMATICS

Figs. 19.1–3 illustrate the important taxonomic characters used in the following keys:

### KEY TO SUBFAMILIES OF STAPHYLINIDAE WITH MARINE MEMBERS

1.	Antennal fossae located on the surface of the head between the anterior margins of the eyes	<i>Aleocharinae</i> (Fig. 19.4)
	Antennal fossae located at the front or side margins of head	2
2.	A pair of ocelli present on the surface of head	<i>Omalinae</i> (Fig. 19.5)
	Ocelli absent	3
3.	Second sternite complete	<i>Oxytelinae</i> (Fig. 19.6)
	Second sternite absent or rudimentary	4
4.	Elytra long, covering first tergite	<i>Proteininae</i> (Fig. 19.7)
	Elytra short, first tergite exposed at least in part	5
5.	Neck plate present at anterior margin of prosternum	<i>Xantholininae</i> (Fig. 19.8)
	Neck plate absent	6
6.	Anterior angle of prothorax produced anteriorly ahead of outer anterior angle of prosternum	<i>Quediinae</i> (Fig. 19.9)
	Anterior angle of prosternum not so produced	7
7.	Last segment of maxillary palpus narrower than preceding	<i>Paederinae</i> (Fig. 19.10)
	Last segment of maxillary palpus not narrower than preceding	8
8.	Superior and inferior lateral lines or pronotum widely separated at anterior angles	<i>Xanthopyginae</i> (Fig. 19.11)
	Superior and inferior lateral lines or pronotum united at anterior angles	<i>Staphylininae</i> (Fig. 19.12)

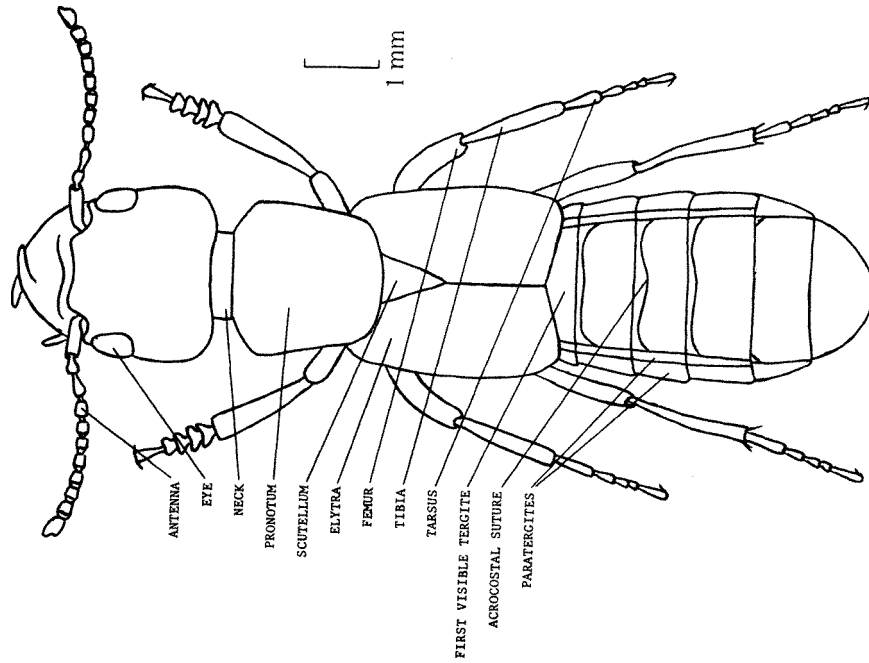
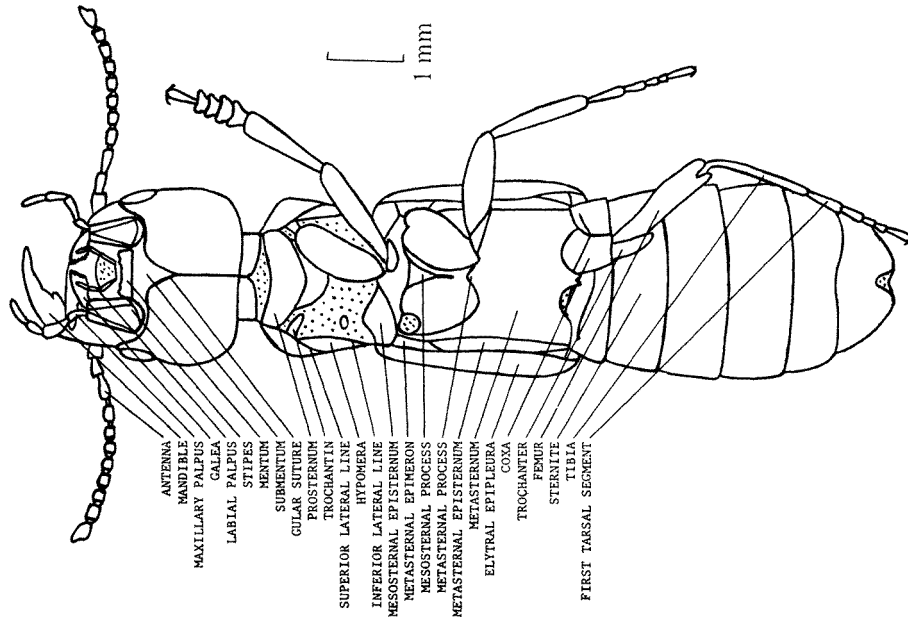

Fig. 19.1. *Caffius luteipennis* LeConte, dorsal view.

Fig. 19.2. *Caffius luteipennis* LeConte, ventral view.

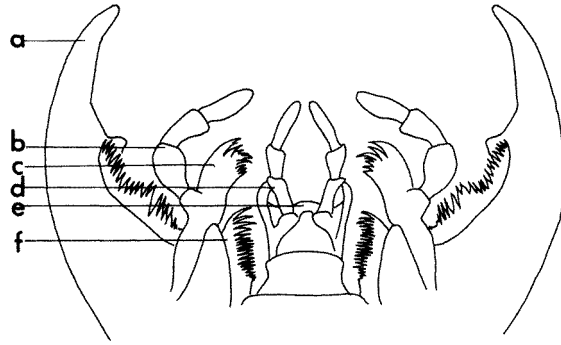

Fig. 19.3. Ventral aspect of mouth parts of *Cafius seminitens* Horn. a, mandible; b, maxillary palpus; c, galea (outer lobe of maxill); d, labial palpus; e, ligula; f, lacinia (inner lobe of maxilla).

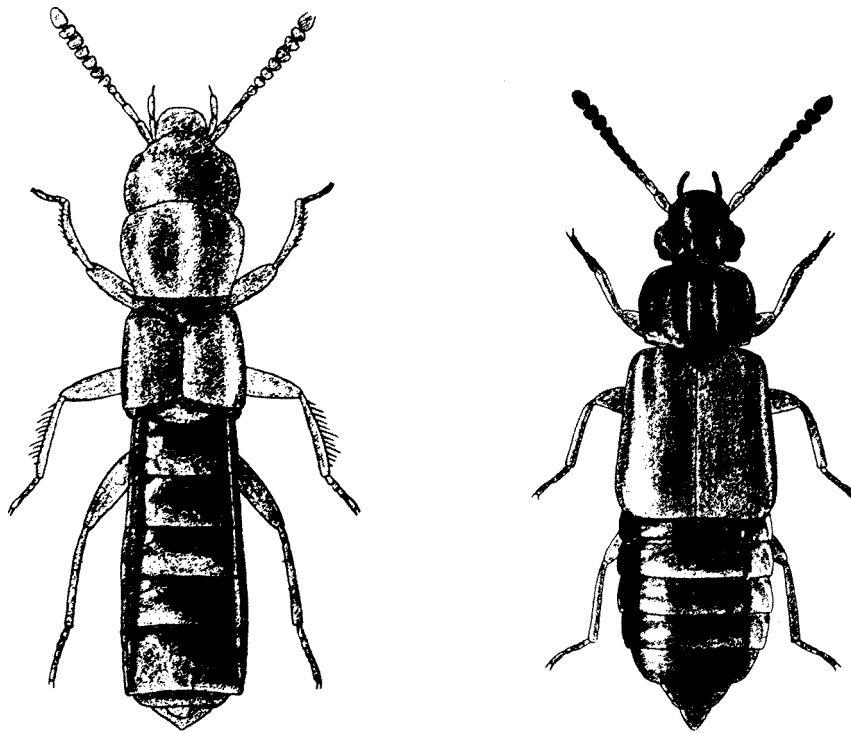

Fig. 19.4. (Left) *Phytosus balticus* Kraatz (subfamily Aleocharinae). After Victor Hansen, Danmark's fauna, rovbiller. G.E.C. Gada, Copenhagen (1951–1959).

Fig. 19.5. (Right) *Omalium rivulare* Paykull (subfamily Omaliinae). After Victor Hansen, Danmark's fauna, rovbiller. G.E.C. Gada, Copenhagen (1951–1959).

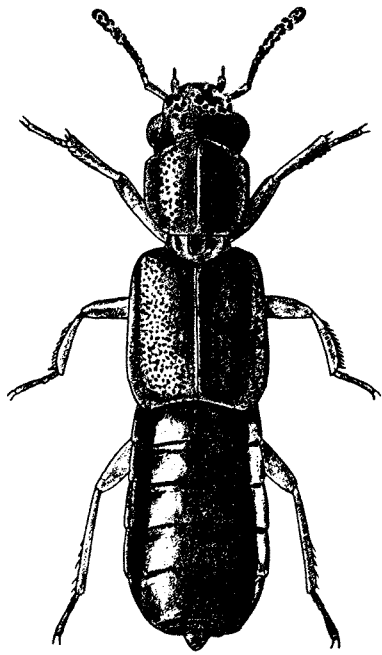

Fig. 19.6. (Left) *Bledius fracticornis* Paykull (subfamily Oxytelinae). After Victor Hansen, Danmark's fauna, rovbiller. G.E.C. Gada, Copenhagen (1951–1959).

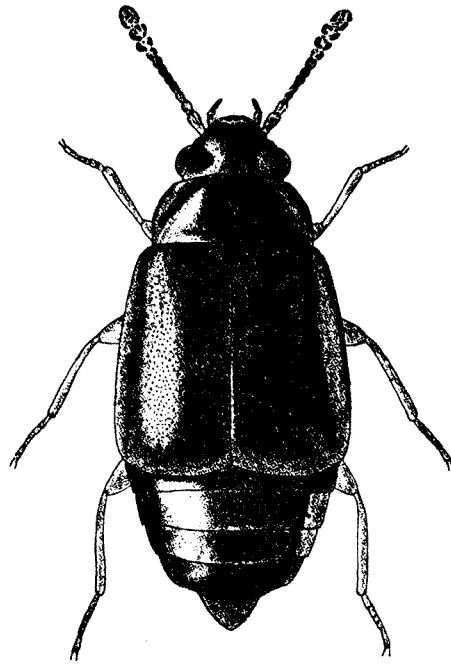

Fig. 19.7. (Right) *Proteinus brachypterus* Fabricius (subfamily Proteininae). After Victor Hansen, Danmark's fauna, rovbiller. G.E.C. Gada, Copenhagen (1951–1959).

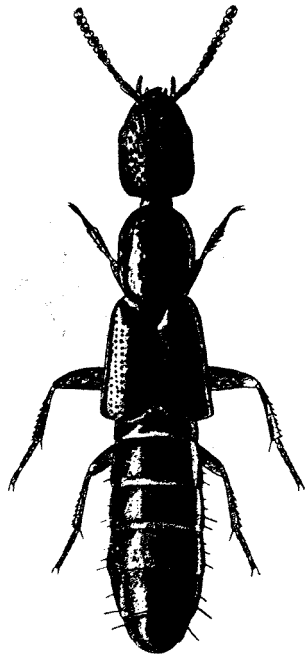

Fig. 19.8. (Left) *Hypongryus punctulatus* Paykull (subfamily Xantholininae). After Victor Hansen, Danmark's fauna, rovbiller. G.E.C. Gada, Copenhagen (1951–1959).

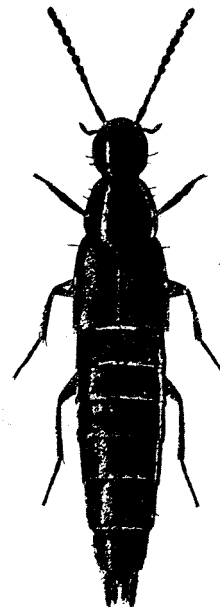

Fig. 19.9. (Right) *Heterothops binotatus* Gravenhorst (subfamily Quediinae). After Victor Hansen, Danmark's fauna, rovbiller. G.E.C. Gada, Copenhagen (1951–1959).



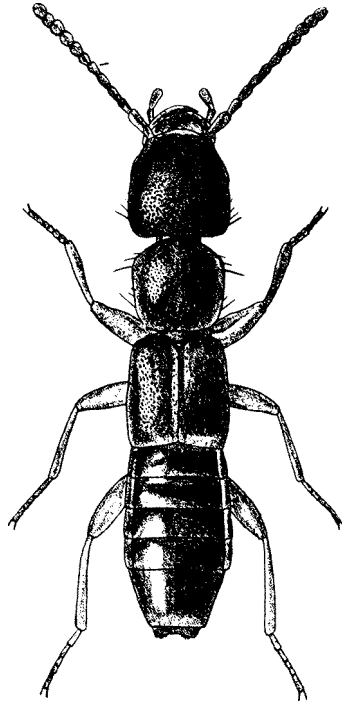

Fig. 19.10. *Medon brunneus* Erichson (subfamily Paederinae). After Victor Hansen, Danmark's fauna, rovbiller. G.E.C. Gada, Copenhagen (1951–1959).

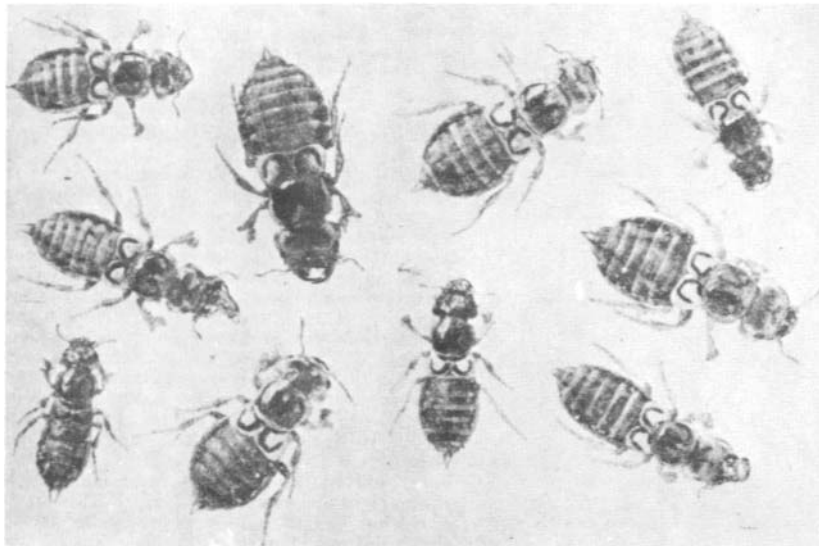

Fig. 19.11. *Thinopinus pictus* LeConte (subfamily Xanthopyginae). After E.O. Essig, Insects of Western North America. The MacMillan Co., New York (1926).

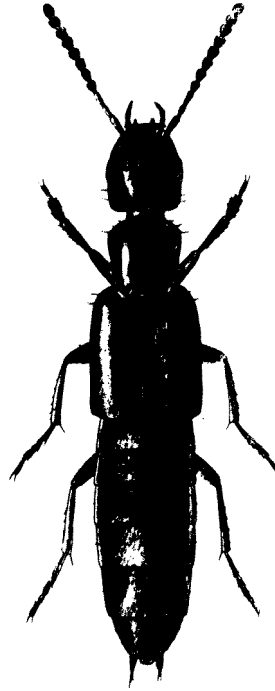

Fig. 19.12. *Cafius xantholoma* Gravenhorst (subfamily Staphylininae). After Victor Hansen, Danmark's fauna, rovbiller. G.E.C. Gada. Copenhagen (1951–1959).

### *19.2.1 Synopsis of subfamilies with keys to genera*

#### *Subfamily Aleocharinae*

Members of the Aleocharinae, the largest and most difficult subfamily, are usually quite small and often quite similar in appearance. All the species of staphylinids which can endure submergence in seawater, those of the rocky shores and coral reefs belong to this subfamily. Other species of this subfamily are found on the sandy beaches associated with wrack and a few are found on mud flats. This subfamily has been divided into tribes on the basis of mouthpart structure and tarsal segmentation. The latter is often difficult to see and not always reliable even within specific limits but no better system has been proposed.

#### KEY TO TRIBES OF ALEOCHARINAE

- |    |   |                   |
|----|---|-------------------|
| 1. | Antenna 10-segmented  | <i>Oligotini</i>  |
|    | Antenna 11-segmented  | 2                 |
| 2. | Outer lobe of maxilla entirely corneous, without pubescence on inner side   | <i>Myllaenini</i> |
|    | Outer lobe of maxilla partly membranous, with long pubescence on inner side | 3                 |

3.	Posterior tarsus 4-segmented	<i>Diglottini</i>
	Posterior tarsus 5-segmented	4
4.	Middle tarsus 4-segmented	<i>Bolitocharini</i>
	Middle tarsus 5-segmented	5
5.	Anterior tarsus 4-segmented	<i>Myrmedoniini</i>
	Anterior tarsus 5-segmented	6
6.	Maxillary palpus 4-segmented	<i>Oxypodini</i>
	Maxillary palpus 5-segmented	<i>Aleocharini</i>

One species of *Glenoplectus* Sawada and one species of *Diaulota*, both from Japan, have all the tarsi 4-segmented. They go to *Diglottini* in this key but are placed in *Bolitocharini*. They lack the basal narrowing of the pronotum which is so characteristic of *Diglottini*.

The condition of the outer lobe of the maxilla is not known in *Polypea* Fauvel, so it cannot be placed in this key. A single species has been described from a coral reef from Aru in the South Pacific.

### *Tribe Oligotini*

*Oligota* Mannerheim. This is a fairly large genus of very small insects whose members prey on mites. One species, *O. pusillima* Gravenhorst, is reported by Fowler (1888) from England as being found in 'haystack refuse, decaying seaweed, etc.'

### *Tribe Myllaenini*

The inner and outer lobes of the maxilla are entirely corneous in members of this tribe, a character not shared with any other staphylinids. The outer lobe is without spines or setae, hooked and pointed at tip. The inner lobe is also hooked and pointed but is provided with a row of various spines and teeth on the inner edge. In other staphylinids both lobes usually have dense tufts of setae on the inner edge. It is often necessary to prepare slide mounts of the mouthparts to determine their condition.

## KEY TO GENERA OF MYLLAENINI

1.	Elytron with a fin-like projection at the side	<i>Brachypronomaea</i>
	Elytron without projection at the side	2
2.	Head produced in front in the form of a beak	<i>Myllaena</i>
	Head not produced in a beak	3
3.	Ligula bifid	<i>Actocharis</i>
	Ligula simple	4
4.	Ligula very short, inconspicuous	<i>Bryothinusa</i>
	Ligula more than half as long as first segment of labial palpus	<i>Halorhadinus</i>

*Brachypronomaea* Sawada. Four species in this genus have been described, one from Japan and three from Madagascar. They are small, pale insects which can be distinguished most easily by the unusual elytra with lateral fin-like projections the outer edge of which is coarsely serrate.

*Myllaena* Erichson. This is a fairly large genus (over 50 species) of small dark insects whose abdomen is pointed and the anterior margin of the head is produced forward in the form of a beak. The senior author has collected a large number of specimens of an unidentified species from a marine mud flat at La Salina, Baja California Norte, Mexico.

*Actocharis* Fauvel. This genus is represented by a single species, *A. marina* Fauvel, from Europe. It is said to be very rare under seaweed below high water mark (Fowler, 1888). It is reddish testaceous and about 1.5 mm long. Its systematic position has been much disputed, some students placing it in the *Oxytelinae*.

*Bryothinusa* Casey. Nine species have been described in this genus. They are all small, slender, pale, parallel sided insects which live below high tide mark. One species from California moves much more rapidly when exposed to daylight than other reef dwelling staphylinids which are usually sluggish. The other eight species are known from Japan and Hong Kong. The genus was reviewed by Moore et al. (1973).

*Halorhadinus* Sawada. The two described species of this genus, from Japan, are very similar to members of *Bryothinusa* but differ mainly in the longer ligula.

### *Tribe Diglottini*

*Diglotta* Chapion. This is the only genus in the tribe. Nine species are known from Europe, California, the Red Sea, Singapore and Celebes, all confined to the seabeach. The maxillary palpi and labial palpi are exceptionally elongate. The head is large, the pronotum is rapidly narrowed to the base and the elytra are quite small, each wider than long, giving the insect its characteristic appearance.

### *Tribe Bolitocharini*

This is a large tribe characterized by the tarsal formula, 4-4-5, with some of the marine species variable in this regard. There are 13 marine genera but only 11 have been included in the following key.

## KEY TO GENERA OF MARINE BOLITOCHARINI

- |    |  |                 |
|----|--|-----------------|
| 1. | Middle coxae separate                  | 2               |
|    | Middle coxae contiguous                | 3               |
| 2. | Body sparsely pubescent                | <i>Halmaeus</i> |
|    | Body densely pubescent                 | <i>Corallis</i> |
| 3. | Anterior and middle tibiae spinose     | 4               |
|    | Anterior and middle tibiae not spinose | 5               |

4.	Fifth tergite impressed at base; ligula simple	<i>Phytosus</i>
	Fifth tergite not impressed; ligula bifid	<i>Thinusa</i>
5.	Tergites not impressed at base	6
	At least three tergites impressed at base	7
6.	Mandibles without or with one internal tooth	<i>Liparocephalus</i>
	Mandibles with numerous internal teeth	<i>Baeostethus</i>
7.	Fifth tergite impressed at base	<i>Amblopusa</i>
	Fifth tergite not impressed	8
8.	Fourth tergite impressed at base	9
	Fourth tergite not impressed at base	10
9.	Head longitudinally impressed	<i>Bryobiota</i>
	Head not longitudinally impressed	<i>Heterota</i>
10.	Metasternum long, hind and middle coxae distant; ligula bifid	<i>Cameronium</i>
	Metasternum short, hind and middle coxae approximate; ligula simple	<i>Diaulota</i>

*Arena* Fauvel is represented by a single species from Europe. We cannot place it in the key on the basis of existing descriptions.

*Paractocharis* Cameron was described on the basis of a single species from Singapore. It cannot be placed in the key from the original description.

*Halmaeus* Keissenwetter. This genus was formerly called *Antarctophytosus*. Six species have been described, all confined to the subantarctic islands. According to Steel (1964) '*Halmaeus* occurs in a variety of habitats, in litter, amongst vegetation, under stones, etc., and only occasionally on the shore'.

*Corallis* Fauvel. The single species, *C. polyporum* Fauvel, was described from Aru. It is 2 mm in length and reddish brown in colour. Fauvel stated that the woolly pubescence is remarkable in that it does not exist in this degree on other submarine insects.

*Phytosus* Curtis. Twelve species have been described from Europe, North and West Africa and New Jersey. Some of the European species are not rare but the single American species has been found only once. These are small linear black-to-orange insects which are largely submarine in habits. The anterior and middle tibiae are armed with spines.

*Thinusa* Casey. Only two species of this genus are known. Both are found on the sandy beaches of Pacific North America. In California *T. maritima* Casey can be found in numbers at night on certain beaches on the wet sand during an outgoing tide in company with *Thinopinus pictus* LeConte and *Pontamalota opaca* LeConte. It is found rarely in seaweed. It is a tiny linear insect largely black with the abdominal apex paler. Its range extends to Washington. *T. fletcheri* Casey is a little larger than *T. maritima*. It is reported from British Columbia to Alaska. The tibiae bear spines on the outer edge. The genus was revised by Moore (1956a).

*Liparocephalus* Mäklin. Members of this genus live in rock crevices on rocky headlands subjected to heavy surf. *L. cordicollis* LeConte is known from Monterey, California to Alaska where it is usually found in company with *Diaulota densissima* Casey. *L. brevipennis* Mäklin is from Alaska and *L. tokunagi* Sakaguti

is from Japan. These are dark, rather densely pubescent insects with very abbreviated elytra. They are about 4 mm in length. The genus was reviewed by Moore (1956a).

*Baeostethus* Broun. A single species, *B. chiltoni* Broun is known from Campbell Island in the subantarctic. It is yellowish brown and about 5 mm long. It resembles *Liparocephalus* from which it is distinguished by the numerous teeth on the mandibles (Steel, 1964).

*Amblopusa* Casey. The two species, *A. brevipes* Casey, found from British Columbia to Alaska, and *A. borealis* Casey, found from California to Alaska, appear to be rare. They are found in intertidal rock crevices on reefs. They somewhat resemble species of *Diaulota* but can be distinguished by their small eyes, serrate mandibles, longer elytra and impressed fourth and fifth tergites. They are ferruginous in colour, slender and about 2–3 mm in length. The genus was revised by Moore (1956a).

*Bryobiota* Casey is represented by a single species, *B. bicolor* Casey, from the Pacific coast of North America. It is not common in Southern California on the seabeaches in wrack. Southern specimens are ferruginous with darker abdomens whereas northern specimens tend to be entirely dark. The head and pronotum are impressed longitudinally. The mesosternum is carinate longitudinally, a rare character in this subfamily. It is about 2.5 mm long.

*Heterota* Mulsant and Rey. Five species have been described in this genus from Europe, the Red Sea, the Indian Ocean and Singapore. They are found under seaweed, etc., on the beach. *H. plumbea* Waterhouse, the type of the genus, is from Europe. It is dull black with the appendages paler. It is about 3 mm long.

*Cameronium* Koch. Four species are known from Zanzibar, the Red Sea, North Africa and Sonora, Mexico. They are small submarine species each from a region of hot climate. The species somewhat resemble species of *Phytosus* but lack spines on the anterior and middle tibiae. The integuments are densely reticulate and rather dull, usually dark but sometimes with pale markings. The ligula is bifid, a character shared with *Thinusa* and *Atheta*. The genus was reviewed by Moore (1964a).

*Diaulota* Casey. Six species are known in this genus, three from central California to Baja California, one from central California to Alaska and two from Japan. Individuals are found in intertidal rock crevices down to mean low water. The species restricted to near high water are dark and densely reticulate whereas those of near low water are pale and more shining. The elytra are short with the metasternum much reduced in length as is characteristic of many wingless staphylinids. The tarsal and palpal segments are sometimes reduced in number in California specimens. In the Japanese species the tarsal segmentation is apparently always reduced. The genus was revised by Moore (1956a).

*Bolitochara* Mannerheim. *B. impacta* Blackburn (1885) from Hawaii from 'marine rejectamenta on the beach' was poorly described from a single specimen.

It was later reported by Sharp (1908) on the authority of Fauvel to be the same as *Diestota testacea* Kraatz. Blackburn stated, 'The dissection . . . might possibly lead to the establishment of a new genus. . .'. It is more than likely neither a *Bolitochara* or a *Diestota*. Its true identity will have to await further study.

### *Tribe Myrmedoniini*

This tribe contains a large number of genera which are united largely on the basis of the number of tarsal segments, the anterior tarsi having 4 segments, the middle and posterior tarsi being composed of 5 segments. Numerous students have expressed the opinion that this is an artificial grouping not indicating true evolutionary relationships. However, it is the best we have at present.

### KEY TO GENERA OF MARINE MYRMEDONIINI

1.	Anterior coxae closed behind; pronotum cordate	<i>Falagria</i>
	Anterior coxae open behind	2
2.	Sternites 1 to 3 constricted or sulcate at base	<i>Tachyusa</i>
	Sternites not constricted or sulcate	3
3.	Neck narrow, two-fifths as wide as head	<i>Myrmecopora</i>
	Neck broad	4
4.	Middle coxae widely separated	<i>Drusilla</i>
	Middle coxae contiguous or narrowly separated	5
5.	Pubescence of disc of pronotum longitudinal	<i>Pontamalota</i>
	Pubescence of disc of pronotum transverse	6
6.	Ligula simple	<i>Acticola</i>
	Ligula bifid	7
7.	Middle coxal cavities margined by a carina	8
	Middle coxal cavities not margined	9
8.	Mandibles not greatly prominent	<i>Atheta</i>
	Mandibles greatly prominent	<i>Halobrecta</i>
9.	Labrum deeply emarginate	<i>Lotarphia</i>
	Labrum truncate	<i>Tarphiota</i>

*Falagria* Mannerheim. Members of this genus have a characteristic appearance known as 'falagroid' which they share with numerous unrelated genera but no marine genera except *Diglotta*: the neck is slender with the pronotum and abdomen constricted at base. The structure of the prosternum is unusual. It is produced posteriorly between the anterior coxae and then laterally to the hypomera completely closing the anterior coxal cavities. This can usually be seen only by relaxing the specimen and lifting the coxa. The genus is a rather large one with only one species, *F. obscura* Gravenhorst, reported by Fowler (1888) from 'haystack refuse, decaying seaweed, and general vegetable rubbish.'

*Tachyusa* Erichson. Like *Falagria* the species of this genus do not normally

frequent the seashore. However, a single species, *T. pumila* Sharp (1880) has been described from Hawaii from 'muddy sand about high water mark.' The constricted basal sternites readily distinguish this genus.

*Myrmecopora* Saulcy. Thirty-five species have been reported in this genus most of which are found near fresh water and a few with ants. However, the two British species and one Japanese species are found only on the beach below high water mark or in decaying seaweed. The neck is narrower than in any other marine genus in this tribe except *Falagria*.

*Drusilla* Leach. This genus contains over fifty species most of which are associated with ants. A single species, *D. canaliculata* Dillwyn, has been reported from Britain as being found under decaying seaweed. The widely separated middle coxae distinguishes it from other marine genera in this tribe.

*Pontamalota* Casey. Members of this genus are confined to the seashore of Pacific North America. Five names have been proposed, but they probably represent only two or three species. Members of this genus have a rather distinctive appearance which is due in part to the narrowing of the pronotum at the base and to the alutaceous integuments. As in some other Pacific coast seashore Coleoptera, the paler forms are at the southern extreme of the range. In southern California these insects are only occasionally found in decaying seaweed; but on certain beaches they can be found in numbers running on the wet sand at night during an outgoing tide in company with *Thinusa* and *Thinopinus*. In central California *P. californica* Casey is found commonly in seaweed but is not nocturnal. Specimens average about 3.5 to 4 mm in length.

*Acticola* Cameron. A single species, *A. faulklandica*, was described by Cameron from the Falkland Islands. Cameron said it "would appear to be near *Tarphiota* Cas. but differing in the bifid right mandible, simple tongue, short elytra, etc." It is black with the appendages paler and 2.75 mm long.

*Atheta* Thomson. An extremely large and polymorphic genus found in a great variety of habitats. A very difficult genus to study. The ligula is bifid in the shape of a letter Y and the first segment of the posterior tarsus is never longer than the next two combined and usually considerably shorter. We have found records of only twelve of the hundreds of described species as occurring on the beach, most of these recorded from decaying seaweed. All of these are from the North Temperate Zone. Many others will undoubtedly be discovered.

*Halobrecta* Thomson. Three species, one from Europe, one from Japan and one from Europe, California and Australia are reported in this genus. This was once considered a subgenus of *Atheta* but has been separated because of its 'very prominent mandibles'. The species are all reported from seaweed.

*Iotarphia* Cameron. This genus was erected in 1943 for a single species, *I. australis* Cameron, from Australia 'of maritime habitat'. It is said to differ from *Tarphiota* largely by the emarginate labrum and mentum and by the longer posterior tarsi. It is largely black with the elytra lemon yellow, the base and



sutural region triangularly infusate, antennae and legs reddish yellow. The length is 2.3 mm.

*Tarphiota* Casey. Two species are at present recognized in this genus. They are confined to the Pacific coast of North America where they are very common in decaying seaweed. *T. geniculata* Mäklin is the most abundant staphylinid in decaying seaweed. It is entirely black and about 2.5 mm long. *T. pallidipes* Casey is 3 mm long and has testaceous legs. The genus is separated from *Atheta* by the completely unmarginated middle coxal cavities which can be observed only by lifting the coxae. Although *T. geniculata* can be found in almost every clump of decaying seaweed, its developmental stages and ecology remain a complete mystery.

### *Tribe Oxypodini*

The combination of 5-segmented tarsi and 4-segmented maxillary palpi characterizes this tribe. Members of this tribe are not characteristic of the marine habitat but two species belonging to separate genera have been reported: *Chilodera* with parallel abdomen, very finely sparsely pubescent body and *Oxypoda* with abdomen tapered to apex and very densely pubescent.

*Chilodera* Cameron. This genus was described in 1944 to accommodate the single species *C. faulklandica* Cameron from the Falkland Islands found in seaweed. The head and abdomen are black with the pronotum and elytra dark reddish brown. It is narrow, parallel sided, 3 mm long.

*Oxypoda* Mannerheim. This is a large genus with several hundred described species. The species are usually teardrop shaped with the pronotum widest at base and the body very densely covered with short pubescence. The species are often closely allied and difficult to separate. One species, *O. tarda* Sharp has been recorded from a saltmarsh in England.

### *Tribe Aleocharini*

This tribe differs from Oxypodini largely in that the maxillary palpi are 5-segmented and the labial palpi 4-segmented. In each case the penultimate segment is subulate and the terminal segment is a minute appendage of it.

*Aleochara* Gravenhorst. Larvae of this large genus are ectoparasites on the pupae of flies within the fly puparium. It is a large genus of general distribution. Five species have been reported from seaweed in Great Britain by Fowler (1888), one, *A. maritima* Casey, from the east coast of North America and two from the Pacific coast of North America. *A. sulcicollis* Mannerheim is one of the most common staphylinids in seaweed in California. It is black with coarse sculpturing. *A. arenaria* Casey is less common. The elytra are pale and finely sculptured. Both species are to be found in carrion on the beach as well as seaweed. Host species of flies are not recorded for them.

### Subfamily Omaliinae

Members of this subfamily are easily known by the presence of a pair of pale mounds ('ocelli') on the surface of the head on or near a line drawn through the posterior margin of the eyes. The elytra are usually longer than those of most other staphylinids, those members covering about one-half of the abdomen. *Micralymma*, an exception, has very short elytra. Six genera are known with marine species, but only three are included in the following key:

#### KEY TO GENERA OF MARINE OMALIINAE

- |    |  |                                       |
|----|--|---------------------------------------|
| 1. | Elytra about as wide as long<br>Elytra longer than wide                                | <i>Micralymma</i><br>2                |
| 2. | Head strongly produced in front of eyes<br>Head not strongly produced in front of eyes | <i>Arpediomimus</i><br><i>Omalium</i> |

*Macralymma* Cameron. This genus is not adequately described and so cannot be included in the key. The single species *M. punctiventris* Cameron (1945) is said to be maritime from New Zealand.

*Nesomalium* Steel. Four species from the seashore of Campbell Island and Auckland Island in the subantarctic. Judging from the original description, this genus is not separable from *Omalium*.

*Omaliomimus* Jeannel. Two species from the seashore at Campbell Island. Like *Nesomalium* this genus appears to be inseparable from *Omalium*.

*Micralymma* Westwood. Members of this genus are confined to the northern part of the North Temperate Zone. They are circumpolar in distribution. Five species have been described from Siberia, Northern Europe, Greenland and Maine. They are submarine in habits. Species of this genus are readily distinguished by their very short elytra which cover no part of the abdomen. The British species *M. brevipenne* Gyllenhal is black, strongly alutaceous and about 3 mm long.

*Arpediomimus* Cameron. This genus is said to be close to *Omalium* but has the head produced forward of the eye for at least the length of the eye. Only two species are known from the subantarctic island. *A. faulklandicus* Cameron from the Falkland Islands is yellowish brown and 4.5–5 mm long. It lacks ocelli. *A. kronei* Kiesenwetter from Campbell Island is dark brown and 5–8 mm long. It has ocelli. The genus was reviewed by Steel (1964).

*Omalium* Gravenhorst. More than one hundred species have been described in this genus mostly from decaying organic matter in the Temperate Zones. Four species are known from seaweed from the British Islands and one from Pacific North America. They are reddish brown and 2–4 mm long. Members of this genus are particularly characterized by a longitudinal carina on the mesosternum.

### *Subfamily Oxytelinae*

Members of this subfamily are distinguished from all other staphylinids by the presence of a complete second sternite so that seven, rather than six, segments can be counted on the under side of the abdomen. The eyes are coarsely faceted. There are seven genera with marine members.

#### KEY TO GENERA OF MARINE OXYTELINAE

1.	Elytra with rounded inner apical angles	2
	Elytra with rectangular inner apical angles	5
2.	Tarsus 2-segmented	<i>Thinobius</i>
	Tarsus of more than 2 segments	3
3.	Tarsus 4-segmented	<i>Bledius</i>
	Tarsus 5-segmented	4
4.	Pronotal lateral bead present	<i>Psamathobledius</i>
	Pronotal lateral bead absent	<i>Microbledius</i>
5.	Tarsus 5-segmented	<i>Sartallus</i>
	Tarsus 3-segmented	6
6.	Middle coxae contiguous	<i>Carpelimus</i>
	Middle coxae separate	<i>Oxytelus</i>

*Thinobius* Kiesenwetter. More than 100 species have been described in this genus. These tiny insects are often taken near water, in decaying organic material and at light. They are dark slender insects, more or less parallel sided and from under one to about two mm long. They resemble members of the subfamily Aleocharinae but are easily distinguished by their coarsely faceted eyes and the fact that the elytra have the inner apical angles rounded. Two species are recorded from saltmarshes in North America, one from each coast, and one species from seaweed from Singapore.

*Bledius* Leach. More than 350 species are placed in *Bledius*. They are sub-cylindrical with the anterior tibiae fossorial. The inner apical angles of the elytra are rounded. Members of this genus are usually found in galleries in sand or mud often at the banks of streams or in saltmarshes, either inland or marine. Usually larvae and adults are found together. They are often attracted to lights in large numbers. At least 18 species are recorded from the marine habitat, mostly from saltmarshes. On the Pacific coast of North America, besides several saltmarsh species, one species, *B. ornatus* LeConte, is found abundantly in sand bars separating a lagoon from the ocean, and two species, *B. fenyessi* Bernhauer and Schubert and *B. monstratus* Casey are found in wrack. The ranges of the latter two species do not overlap being separated by Point Conception, California.

*Psamathobledius* Herman. This genus and *Microbledius* were recently (Herman, 1972) separated from *Bledius* for several very small species whose tarsi are 5-segmented, those of *Bledius* being 4-segmented. Herman listed 3 species. They are apparently all saltmarsh inhabitants. This genus is distinguished from *Microbledius* by the presence of a lateral carina separating the pronotal disc from the hypomera.

*Microbledius* Herman. The genus was created recently for a group of small species formerly placed in *Bledius*. Herman (1972) placed 10 new world species in the genus. At least *M. actitus* Herman is found on a marine saltmarsh.

*Sartallus* Sharp. The single species, *S. signalis* Sharp, is a pale insect about 5–6.5 mm in length. The tarsi are 5-segmented and the tibiae spinose. It is found in Australia where it is associated with sandy, coastal regions. It hides under seaweed and feeds chiefly on dead barnacles.

*Carpelimus* Leach. More than 300 species are known in this genus. They are small, somber colored insects of rather uniform appearance and consequently are difficult to study. They are found mostly at the margins of ponds and streams or associated with decaying organic materials and are often attracted to lights. The tibiae are without spines. The inner apical angles of the elytra are rectangular and the middle coxae contiguous. The eyes are coarsely faceted. Ten species have been reported from saltmarshes in various parts of the world and one species, *C. lucidus* Cameron, from seaweed at Zanzibar.

*Oxytelus* Gravenhorst. More than 100 species have been placed in this genus. The pronotum is carinate and often shining and the middle coxae are widely separated. The anterior tibiae are spinose. These insects are often found in decaying organic material so it is not surprising that four species have been reported from Great Britain from seaweed.

### *Subfamily Proteininae*

Members of this small subfamily are similar to members of the Omaliinae but lack the ocelli so characteristic of the latter.

*Proteinus* Latreille. Twenty three species, almost all from the North Temperate Zone, are included in this genus. The species are often found in decaying vegetable matter so it is not unusual that Fowler (1888) reported two species also from decaying seaweed from the British Islands. These are small oval insects with long elytra.

### *Subfamily Xantholininae*

Members of this subfamily differ from all other staphylinids in the presence of a small sclerite called the neck plate which is adjacent to the anterior margin of the prosternum. They are linear, highly flexible insects.

*Hyponygrus* Tottenham. This is a fairly large genus of worldwide distribution. A single species, *H. tricolor* Fabricius, was reported by Fowler (1888) from 'vegetable refuse, decaying seaweed, etc.' from the British Islands.

### *Subfamily Quediinae*

Among those staphylinids with a distinct neck, members of this subfamily are recognized in having the anterior angles of the prothorax produced ahead of the anterior angles of the prosternum. The hypomera is not visible from the side and is without a beaded margin internally.

*Heterothops* Mannerheim. A moderate sized genus whose members are usually found in leaf mold, etc. One species, *H. binotata* Erichson has been reported by Fowler (1888) 'in decaying seaweed on the shore' in Great Britain. Members of this genus have the last segment of the maxillary palpus much narrower than the preceding segment. The pronotum is strongly narrowed in front, highly polished and with only three punctures arranged in a triangle on the disc on each side in front.

### *Subfamily Paederinae*

Only two genera of this large subfamily are associated with the marine habitat. They are usually linear insects with a distinct neck and with the last segment of the maxillary palpus narrower than the preceding.

*Chetocephalus* Cameron. This genus, characterized by coarse umbilicate punctures on the head and pronotum, was established for a single species, *C. maritimus* Cameron, from seaweed from the island of Mauritius in the Indian Ocean.

*Medon* Stephens, with very fine umbilicate punctures on the head and pronotum, contains about 200 species, but only 3 are marine. Two are from the British Isles and one from Mauritius. These medium-sized linear insects are usually brown in colour.

### *Subfamily Xanthopyginae*

Members of this subfamily have the lateral carinae of the prothorax widely separated at the anterior angle. They are generally large linear or stout insects best developed in tropic regions.

## KEY TO GENERA OF MARINE XANTHOPYGINAE

- |    |                                |                   |
|----|--------------------------------|-------------------|
| 1. | Elytral suture overlapping     | <i>Thinopinus</i> |
|    | Elytral suture not overlapping | 2                 |
| 2. | Middle coxae separate          | <i>Hadropinus</i> |
|    | Middle coxae contiguous        | <i>Hadrotes</i>   |

*Thinopinus* LeConte. The single species, *T. pictus* LeConte, is a large stout cream-colored insect with dark markings on the upper surface. It is confined to the Pacific coast of North America. It has a pale form south of Monterey, California, and a dark form, sub-species *variegatus* Motschulsky, north of there. In southern California it is common on some beaches where it can be found at night on the wet sand during an outgoing tide. Individuals usually stay in one place waiting for the approach of a beach hopper (*Orchestoidea*). When one comes near they pounce on it and consume it. This species is rarely found in seaweed.

*Hadrotus* Máklin. Only two species are known, *H. crassus* Máklin from Alaska to Baja California and *H. wakefieldi* Cameron from New Zealand. The former is a large (up to 22 mm) linear species which is not abundant in decaying seaweed. It is sluggish in its movements.

*Hadropinus* Sharp is known by a single species, *H. fossor* Sharp, from Japan. It is described as black with the elytra solid yellow except along the suture which is darker. Length is given at 23 mm. It is said to make burrows in the sand under seaweed.

### Subfamily Staphylininae

Members of this subfamily are medium sized to large insects. They inhabit a large variety of habitats. The four marine genera can be separated by the following key.

#### KEY TO GENERA OF MARINE STAPHYLININAE

- |    |   |                   |
|----|---|-------------------|
| 1. | Superior lateral line of prothorax deflexed in front so that the large lateral setigerous puncture is removed from it by at least three times the width of the puncture   | 2                 |
|    | Superior lateral line of prothorax not deflexed in front so that the large lateral setigerous puncture is on it or separated from it at most by the width of the puncture | 3                 |
| 2. | Anterior tibiae with spines on the outer edge   | <i>Cafius</i>     |
|    | Anterior tibiae without spines on the outer edge  | <i>Phucobius</i>  |
| 3. | Pronotum with a single puncture on each side of disc  | <i>Orthidus</i>   |
|    | Pronotum with a row puncture on each side of disc   | <i>Philonthus</i> |

*Thinocafius* Steel. This genus was erected for a single species, *T. insularis* Steel, from Chatham Island. From the original description it appears not to be separable from *Cafius*.

*Cafius* Curtis. Fifty-two species have been described in *Cafius*. All members of this genus are found on the seashore or on margins of rivers near the sea. They are very active both running and flying, usually black or brown but sometimes with yellow or reddish elytra and average 10–15 mm in length. The majority of species are found in temperate regions but a few are wide spread in the tropics. Seven species, some very common, others rare, are found together in wrack on the Pacific coast of North America. They are known to lay their eggs deep in the sand

where the larvae prey on crustaceans, etc. (James et al., 1971). Twelve species are described from Australia, Tasmania and New Zealand, 4 from Europe and 4 from Japan. The genus was partially revised by Koch (1936).

*Phucobius* Sharp. The 7 species which have been described in this genus are similar to *Cafius* but lack spines on the anterior tibiae. They are confined to the Oriental Region except for one species from East Africa. They are all found on the seashore.

*Orthidus* Mulsant and Rey. Two species, *O. cribratus* Erichson from Europe and *O. curtipennis* Cameron from Singapore, both from the seashore, are the only species known in this genus. They are similar to *Philonthus* but have a single puncture on the disc of the pronotum whereas in *Philonthus* there may be either a row of punctures on each side of the disc or confused punctures throughout.

*Philonthus* Stephens contains several hundred moderate-sized-to-large (8–20 mm) insects, variously coloured, very active and found in a large variety of habitats. A single species, *P. nudus* Sharp, is known from the seashore of Japan and the Pacific Northwest of North America. Several other species are found on the sandy beaches of Australia.

### 19.3 ECOLOGY AND DISTRIBUTION

Several distinctly different ecological zones are occupied by insects on the Pacific coast of North America which can be differentiated by the type of shore and the reach of the tide. The seashore staphylinid fauna falls into three main zones or ecological habitats with almost no overlapping of species between them. The three zones are determined by the type of shore: (1) mud flats which may be associated with large open bays or lagoons at the mouths of streams and rivers that are usually closed at least part of the year by sand bars, (2) sandy beaches which support the most varied insect fauna in Southern California, and (3) rocky headlands which support a fauna of insects capable of living submerged in sea-water for long periods.

Each of the major ecological zones which supports insects can be readily divided into subzones based on the reach of the tide. The subzones fall into three categories: (1) the area which is wet by daily tides, (2) the area which is wet by only one or two high tides a month and (3) the berm of the beach which is reached by only the highest tides of the year. This subzonation is most apparent on the sandy beaches where subzone (1) contains fresh seaweed and such nocturnal staphylinids as *Thinopinus*, *Pontamalota* and *Thinusa*; subzone (2) contains decaying seaweed and species of *Cafius*, *Tarphiota* and *Aleochara* and subzone (3) has dry seaweed and no staphylinids but other Coleoptera (see Table 19.1).

Among the marine Staphylinidae it is convenient to make a distinction between submarine and littoral species. Submarine species are those which not

Table 19.1 Genera of Coleoptera which predominate in each intertidal zone in southern California.

Rocky headlands and reefs	Sandy beaches	Mud flats
(a) Area of red algae down to mean low water	Area of fresh seaweed	Area of daily tides
<i>Diaulota</i> *	<i>Cafius</i> *	<i>Berosus</i>
	<i>Cicindela</i>	<i>Enochrus</i>
	<i>Dyschirius</i>	<i>Tropisternis</i>
	<i>Thinopinus</i> *	(All in the water)
(b) Area of high tides	Area of decaying seaweed	Area of sea-lettuce
<i>Thalassotrechus</i> *	<i>Aleochara</i> *	<i>Actinidium</i>
<i>Diglossa</i> *	<i>Anthicus</i>	<i>Bembidion</i> *
<i>Bryothinus</i> *	<i>Bledius</i> *	<i>Carpelimus</i> *
<i>Diaulota</i> *	<i>Bryobiota</i> *	<i>Cicindela</i>
(also <i>Aegialites</i> , <i>Amblopusa</i> *, <i>Endeodes Liparocephalus</i> * and <i>Ochthebius</i> in central California)	<i>Cafius</i> *	<i>Myllaena</i> *
	<i>Cercyon</i>	<i>Ochthebius</i>
	<i>Diglossa</i> *	<i>Tachys</i>
	<i>Emphyastes</i>	<i>Thinobius</i> *
	<i>Hadrotus</i> *	<i>Throscinus</i>
	<i>Hypocaccus</i>	
	<i>Motschulkius</i>	
	<i>Neopachylopus</i>	
	<i>Phaleria</i>	
	<i>Phycocoetes</i>	
	<i>Pontamalota</i> *	
	<i>Tarphiota</i> *	
	<i>Thinusa</i> *	
(c) Area of spray	Area of dry seaweed	Area of <i>Salicornia</i>
<i>Bryothinus</i> *	<i>Amblyoderus</i>	<i>Bledius</i> *
<i>Diaulota</i> *	<i>Anthicus</i>	<i>Carpelimus</i> *
<i>Thalassotrechus</i>	<i>Apsena</i>	<i>Thinobius</i> *
	<i>Catorama</i>	
	<i>Endeodes</i>	
	<i>Phaleria</i>	
	<i>Phyconomus</i>	

\* Staphylinidae.

only tolerate submergence in seawater but actually continue their activities in seawater at a reduced rate of metabolism (Meyerdirk, 1969). All of the species which inhabit the reef area are submarine as they are normally submerged in seawater part of the time. One species, *Diaulota harteri* Moore, is found as deep as mean low water where it would sometimes be submerged for as long as 20 hours a day. These species spend most of their time in crevices in the rocks or in empty barnacle shells, etc. They sometimes come out and wander about at low tide.

It is questionable if any of the typical species of the sandy beach could be called



submarine. However, some species, such as *Thinopictus pictus* LeConte, which burrow in the wet sand in day time and come out to feed only at night, might be so considered. They should be investigated for tolerance to total submergence for an extended length of time. Species, such as those of *Cafius*, which are found largely in wrack and which leave the wrack immediately when it is wetted by sea water, must be called littoral. All inhabitants of saltmarshes should probably be called littoral.

Many staphylinids are temporarily attracted to decaying organic material which is not their normal habitat. However, many species are found in masses of seaweed (wrack) which are deposited on the beach with each high tide. The wrack provides food, probably first in the form of entrapped small marine organisms and later in the crustacea and the larvae of flies which soon appear. Staphylinids begin to appear in the wrack as soon as it arrives on the beach only to leave it again if it is wetted once more by salt water. The wrack which is deposited by the highest tide of any tidal period stays on the beach the longest and consequently accumulates the largest population of insects. This period can be as long as 15–20 days. Staphylinids do not breed in the wrack. Few larvae, and those of a few species of *Cafius*, are even found there. Occasional specimens of staphylinids encountered in the wrack or carrion on the beach should not be included in lists of marine insects if it is suspected that they are only accidental visitors. It is possible that a few such records are in the existing literature. Some records of Fowler (1888) are suspect in this regard, particularly where the insect is also reported from other habitats.

It is of interest that the marine insect fauna of Pacific North America, which extends for a distance north to south of over 3000 miles from the Aleutian Islands to part of the way down the coast of Baja California, shows definite correlation with the provinces outlined or described by marine biologists. Some species of staphylinids, and of other insects, have a range which encompasses the entire coast. Other species are restricted to part of the coast. There are at least two regions on the coast where a partial change in fauna takes place. These are at Point Conception and near Monterey. This is illustrated in Tables 19.2 and 19.3. Steinbeck and Ricketts (1941) considered the region between Point San Eugenio, Baja California and Point Conception, California, to be an overlap area between the Panamic Province and the North Temperate Province. Further collection of insects along the west coast of Baja California is needed to substantiate this conjecture.

#### ACKNOWLEDGEMENTS

We are pleased to extend our thanks to J.M. Campbell, Saul Frommer, Sam Harter, Melville Hatch, Lee Herman, David Kavanaugh, Horace Last, Hugh B.





Leech, Vincent Lee, Helen Moore, Dale Meyerdirk, Robert E. Orth, John Pinto, Vincent Roth, Kohei Sawada and Mary Ann Walsh, all of whom have helped in our study of the marine fauna.

## REFERENCES

- Bernhauer, M. (1915) Neue Staphyliniden des tropischen Africa (10. Beitrag). Verh. Zool.-Bot. Ges. Wien. 65, 287–321.
- Bernhauer, M. (1922) Sauters Formosa Ausbeute: Staphylinidae (I. Teil). Arch. Naturgesch. 88, 220–337.
- Bernhauer, M. (1929) Neue Kurzflügler des paläarktischen Gebietes. Koleopterol. Rundsch. 14, 179–195.
- Bernhauer, M. (1938) Voyage de M. Aubert de le Rue aux îles Kerguelen die Gattung *Antarctophytosus* Enderlein (Coleoptera Staphylinidae). Rev. Fr. Entomol. 5, 91–94.
- Bernhauer, M. and Scheerpeltz, O. (1926) Coleopterorum Catalogus, pars 82. Staphylinidae VI, () pp. 499–988.
- Bernhauer, M. and Schubert, K. (1910) Coleopterorum Catalogus, pars 19, Staphylinidae I, () pp. 1–86.
- Bernhauer, M. and Schubert, K. (1911) Coleopterorum Catalogus, pars 29, Staphylinidae II, () pp. 87–190.
- Bernhauer, M. and Schubert, K. (1912) Coleopterorum Catalogus, pars 40, Staphylinidae III, () pp. 191–288.
- Bernhauer, M. and Schubert, K. (1914) Coleopterorum Catalogus, pars 57, Staphylinidae IV, () pp. 289–408.
- Bernhauer, M. and Schubert, K. (1916) Coleopterorum Catalogus, pars 67, Staphylinidae V, (p) pp. 409–498.
- Bierig, A. (1934) Neues aus der Staphyliniden-Gattung *Cafius*, nebst Beschreibung neue Arten aus Kuba und Nordamerika. Rev. Entomol. 4, 65–70.
- Blackburn, T. and Sharp, D. (1885) Memoirs on the Coleoptera of the Hawaiian Islands. Sci. Trans. R. Dublin Soc. Ser. 2(3) 119–300.
- Blackwelder, R.E. (1936) Morphology of the coleopterous family Staphylinidae. Smith. Misc. Coll. 94, 1–102. Illus.
- Blackwelder, R.E. (1943) Monograph of the West Indian beetles of the family Staphylinidae. Bull. U.S. Nat. Mus. 182, 1–658. illus.
- Blackwelder, R.E. (1952) Generic names of the beetle family Staphylinidae with an essay on genotypy. Bull. U. S. Nat. Mus. 200, i-iv, 1–483.
- Brèthes, J. (1925) Un coléoptères et un diptère nouveaux de la Georgie du Sud. Commun. Mus. Hist. Nat. Bernardino Ridavadia. 2, 169–173.
- Broun, T. (1880) Manual of the New Zealand Coleoptera, pt. 1, 651 pp. (Wellington.)
- Broun, T. (1909) Descriptions of Coleoptera from the subantarctic islands of New Zealand; with remarks on the affinities of the genera, etc. Subantarctic Island New Zealand. 1, 78–122. (Wellington.)
- Cameron, M. (1917a) Description of a new genus of Staphylinidae. Entomol. Mon. Mag. 53, 125.
- Cameron, M. (1917b) The genus *Paraphytosus* mihi: synonymical note. Entomol. Mon. Mag. 53, 233–234.
- Cameron, M. (1919) *Paraphytosus*, a correction. Entomol. Mon. Mag. 55, 32.
- Cameron, M. (1936) Note on the genus *Arena* Fauv. Entomol. Mon. Mag. 72, 108.

- Cameron, M. (1943) New species of Staphylinidae (Col.) from Australia and New Guinea. *Ann. Mag. Nat. Hist. Ser. 11*, (X) 336–354.
- Cameron, M. (1944a) New Oriental Staphylinidae (Col.). *Ann. Mag. Nat. Hist. Ser. 11* (XI) 312–322.
- Cameron, M. (1944b) New species of Staphylinidae (Col.) from the Falkland Islands. *Ann. Mag. Nat. Hist. Ser. 11* (XI) 618–621.
- Casey, T.L. (1885) New genera and species of Californian Coleoptera. *Bull. Calif. Acad. Sci.* 1, 285–336.
- Casey, T.L. (1892) Coleopterological notices, IV. *Ann. N. Y. Acad. Sci.* 6, 359–712.
- Casey, T.L. (1893) Coleopterological notices, V. *Ann. N. Y. Acad. Sci.* 7, 281–606.
- Casey, T.L. (1904) On some new Coleoptera, including five new genera. *Can. Entomol.* 36, 312–324.
- Casey, T.L. (1906) Observations on the staphylinid groups Aleocharinae and Xantholini chiefly of America. *Trans. Acad. Sci. St. Louis* 16, 125–435.
- Casey, T.L. (1911) New American species of Aleocharinae and Myllaeninae. *Memoirs on the Coleoptera* 2, 1–245.
- Chamberlin, J.C. and Ferris, G.F. (1929) On *Liparocephalus* and allied genera (Coleoptera: Staphylinidae). *Pan-Pac. Entomol.* 5, 137–143/ 153–162, 5 figs.
- Champion, G.C. (1887) On the priority of various generic names in use in British Coleoptera. *Entomol. Mon. Mag.* 23, 227–230.
- Champion, G.C. (1889) Some remarks on the two species of *Diglossa*, occurring in Britain. *Entomol. Mon. Mag.* 35, 264–265.
- Chevrolat, L.A.A. (1843) Description d'une nouvelle espece du genre *Myrmedonia*. *Rev. Zool.* 6, 43–43.
- Curtis, J. (1838) British Entomology; being illustrations and descriptions of the genera of insects found in Great Britain and Ireland: containing coloured figures from nature of the most rare and beautiful species, and in many instances of the plants upon which they are found. V. 15 pls. 674–721. (.)
- Eichelbaum, F. (1909) Katalog der Staphyliniden-gattungen nebst Angabe ihrer Literatur, Synonyme, Artenzahl, geographischen Verbreitung und ihrer bekannten Larvenstände. *Mem. Soc. Entomol. Belg.* 17, 17–280.
- Enderlein, G. (1909) Die Insekten des Antarktischen Gebietes. *Deutsche Südpolar-Exp.* 10. Zool. II. 1908 (1909) 361–518.
- Erichson, W.F. (1839) Genera et Species Staphylinorum Insectorum Coleopterorum Familiae (pt. 1) () pp. 1–400.
- Erichson, W.F. (1840) Genera et Species Staphylinorum Insectorum Coleopterorum Familiae (pt. 2) () pp. 401–954.
- Esaki, T. (1956) Biological notes on *Brachypronomaea* Sawada. *Kontyû* 24, 199–200.
- Fall, H.C. (1916) Three new Coleoptera from Washington state. *Bull. Brooklyn Entomol. Soc.* 11, 13–14.
- Fauvel, C.A.A. (1862) Notice sur quelques aléochariens nouveaux on peu connus et description des larves de *Phytosus et Leptusa*. *Ann. Soc. Entomol. Fr. Ser. 4*, (2) 81–94.
- Fauvel, C.A.A. (1863) Notice sur quelques aléochariens nouveau ou peu connus (suite I). *Ann. Soc. Entomol. Fr. Ser. 4*, (3) 211–222.
- Fauvel, C.A.A. (1877) Les staphylinides de l'Australie et de la Polynésie. *Ann. Civ. Stor. Genova* 10, 168–298.
- Fauvel, C.A.A. (1909) Staphylinides exotique nouveaux, pt. 3. *Rev. Entomol.* 24, 113–147.
- Fenyés, A. (1912) Aleocharinae (fam. Staphylinidae, Col.) from the Aleutian Islands. *Proc. Pac. Coast Entomol. Soc.* 4 pp. (unnumbered).
- Fenyés, A. (1918) Genera Insectorum, Coleoptera, fam. Staphylinidae, subfam. Aleocharinae. fasc. 173a, 1–110.

- Fenyés, A. (1920) Genera Insectorum, Coleoptera, fam. Staphylinidae, subfam. Aleocharinae. fasc. 173b, 111–414.
- Fenyés, A. (1921) Genera Insectorum, Coleoptera, fam. Staphylinidae, subfam. Aleocharinae. fasc. 173c, 415–453, 7 pl.
- Fowler, W.W. (1888) The Coleoptera of the British Islands. A descriptive account of the families, genera and species indigenous to Great Britain and Ireland, with notes as to localities, habitats, etc. vol. 2, Staphylinidae, 444 pp. 70 pl. (.)
- Ganglbauer, L. (1895) *Die Käfer von Mitteleuropa*. Die Käfer der österreichisch-ungarischen Monarchie, Deutschlands, der Schweiz, sowie des französischen und italienischen Alpengebietes, vol. 2, Familienreihe Staphyloidea, I. Theil: Staphylinidae, Pselaphidae, () 880 pp.
- Hamilton, A. (1894) Catalogue of the Coleoptera of Alaska. Trans. Am. Entomol. Soc. 21, 1–38.
- Hatch, M. (1957) *The beetles of the Pacific Northwest. Part II: Staphyliniformia*. Univ. Wash. Publ. Biol. 16, 1–384, 37 pl.
- Hatch, M. and Kincaid, T. (1958) A list of Coleoptera from the vicinity of Willapa Bay, Washington, 19 pp. (Seattle.)
- Herman, L. (1972) Revision of *Bledius* and related genera. Part I. The *aequatorialis*, *mandibularis* and *semiferrugineous* groups and two new genera (Coleoptera, Staphylinidae, Oxytelinae). Bull. Am. Mus. Nat. Hist. 149, 111–254.
- Holdhaus, K. (1932) Über der Insektenfauna der Insel Süd-Georgien. Zool.-Jahrb. 63, 163–182.
- Horn, G.H. (1871) Descriptions of new Coleoptera from the United States with notes on known species. Trans. Am. Entomol. Soc. 3, 325–344.
- Horn, G.H. (1884) Synopsis of the *Philonthi* of boreal America. Trans. Am. Entomol. Soc. 11, 177–244.
- Jacquelin du Val, P.N.C. (1856) Genera des Coléoptères d'Europa. vol. 2, Staphylinides, p. 1–40, 16 pl.
- Jacquelin du Val, P.N.C. (1857) Genera des Coléoptères d'Europa. vol. 2, Staphylinides, p. 41–96, 12 pl.
- James, G.J., Moore, I. and Legner, E.F. (1971) The larval and pupal stages of four species of *Cafius* (Coleoptera: Staphylinidae) with notes on their biology and ecology. Trans. San Diego Soc. Nat. Hist. 16, 279–289.
- Jarridge, J. (1959) Un nouveau genre d'Aleocharide marin de la zone intertropicale. Nat. Malgache. 11, 64–66.
- Jarrige, J. (1965) Brachélytres récoltés en Nouvelle-Calédonie par M.Y. Plessis. Cah. Pac. 6, 177–180.
- Jeannel, R.G. (1940) III. Coléoptères. In: Croisière du Bougainville aux îles australes françaises. (2) 14, 64–201.
- Jones, T.W. (1968) The zonal distribution of three species of Staphylinidae in the rocky intertidal zone of California (Coleoptera: Staphylinidae). Pan-Pac. Entomol. 44, 203–210.
- Keen, J.H. (1895) List of Coleoptera collected at Massett, Queen Charlotte Islands, B.C. Can. Entomol. 27, 165–172.
- Keen, J.H. (1897) Three interesting Staphylinidae from Queen Charlotte Islands. Can. Entomol. 29, 285–287.
- Kiessenwetter, E.A.H., von (1877) In: Kiesenwetter and Kirsh, Die Käferfauna der Auckland-Inseln, nach Herm. Krone's Sammlungen beschrieben. Deutsch. Entomol. Z. 21, 160–164.
- Kincaid, T. (1961a) Ecology and morphology of *Thinobius frizzelli* Hatch, an intertidal beetle. (Seattle) 15 pp.
- Kincaid, T. (1961b) Ecology and orphology of *Thinobius frizzelli* Hatch, an intertidal beetle, (Seattle) (revised edn.) 12 pp.
- Kincaid, T. (1961c) The staphylinid genera *Pontamalota* and *Thinusa*. (Seattle) 10 pp.
- Kincaid, T. (1966) A problematic sense organ found upon the maxillae of intertidal staphylinid beetles. Trans. Am. Entomol. Soc. 85, 275–278.

- Kock, C. (1936) Wissenschaftliche Ergebnisse der entomologischen Expeditionen seiner Durchlaucht des Fürsten Assesandro C. della Torre e Tasso nach Aegypten und auf der Halbinsel Sinai. XIII. Staphylinidae. Publ. Mus. Entomol. Pietro Rossi 1, 115–232.
- Kraatz, G. (1853) Bemerkungen über Staphylini. Stett. Z. 14, 257–259.
- Kraatz, G. (1856) Naturgeschichte den Insekten Deutschlands, Abt. I, Coleoptera, vol. 2, Lief 1–2, () pp. 1–376.
- Kraatz, G. (1857) Genera Aleocharinorum illustrata. Linnaea Entomol. 11, 11–143, 1 pl.
- Kraatz, G. (1859) In: Schaum, Beitrag zur Europäischen Käferfauna. Berl. Entomol. Z. 3, 52–53.
- LeConte, J.L. (1852) Descriptions of new Coleoptera from California. Ann. Lyc. Nat. Hist. N.Y. 5, 125–216.
- LeConte, J.L. (1861) New species of Coleoptera inhabiting the Pacific District of the United States. Proc. Acad. Natl. Sci. Phil. 13, 338–359.
- LeConte, J.L. (1877) On certain genera of Staphylinidae Oxytelini, Piestidae and Micropeplidae as represented in the fauna of the United States. Trans. Am. Entomol. Soc. 6, 213–252.
- LeConte, J.L. (1880) Short studies of North American Coleoptera. Trans. Am. Entomol. Soc. 12, 1–32.
- Leech, H.B. and Moore, I. (1971) Nearctic records of flights of *Caifus* and some related beetles of the seashore (Coleoptera: Staphylinidae and Hydrophilidae). Wasman. J. Biol. 29, 65–70.
- Mäklin, F.G. (1883) In: Mannerheim, Dritter Nachtrag zu Käfer-fauna der Nord-Amerikanischen Länder des Russischen Reiches. Boll. Soc. Imp. Nat. Muscou. 26, 95–269.
- Meyerdirk, D.E. (1969) Adaptions of a rove beetle, *Diaulota fulviventris* Moore (Coleoptera: Staphylinidae) to the marine environment. (, .)
- Moore, I. (1956a) A revision of the Pacific Coast Phytosi with a review of the foreign genera (Coleoptera: Staphylinidae.) Trans. San Diego Soc. Nat. Hist. 12, 103–152.
- Moore, I. (1956b) Notes on intertidal Coleoptera with descriptions of the early stages (Carabidae, Staphylinidae, Malachidae). Trans. San Diego Soc. Nat. Hist. 12, 207–230, 4 pl.
- Moore, I. (1964a) A new marine beetle from the Gulf of California (Coleoptera: Staphylinidae). Trans. San Diego Soc. Nat. Hist. 13, 173–176.
- Moore, I. (1964b) Some potentials of seashore insects for the study of biology. Los Entomol. 6, 2–4.
- Moore, I. (1964c) The Staphylinidae of the marine mud flats of southern California and northwestern Baja California (Coleoptera: Staphylinidae). Trans. San Diego Soc. Nat. Hist. 13, 269–284.
- Moore, I. (1964d) A note on the identity of *Liparocephalus brevipennis* Mäklin (Coleoptera: Staphylinidae). Pan-Pac. Entomol. 40, 10.
- Moore, I. (1964e) A new key to the subfamilies of the Staphylinidae and notes on their classification. Coleopt. Bull. 18, 83–91.
- Moore, I. (1964f) The larva of *Hadrotus crassus* (Mannerheim) (Coleoptera: Staphylinidae). Trans. San Diego Soc. Nat. Hist. 13, 309–311.
- Moore, I. (1967) Corrections to my key to the subfamilies of the Nearctic Staphylinidae. Coleopt. Bull. 21–93.
- Moore, I. (1972) Notes on *Diaulota harteri* with new synonymy (Coleoptera: Staphylinidae). Pan-Pac. Entomol. 48, 218.
- Moore, I. (1973a) Rove beetles taking flight directly from the surface of fresh and salt water: an escape mechanism (Coleoptera: Staphylinidae). Wasman J. Biol. (1972) 30, 169–170.
- Moore, I. (1973b) A second correction to the key to the subfamilies of the Nearctic Staphylinidae. Coleopt. Bull. 27, 46.
- Moore, I. (1973c) Notes on the Coleoptera of wrack. J. Entomol. Soc. B. C. 70–40.
- Moore, I. and Legner, E.F. (1971) *Bryothinusa chani*, a new species of marine beetle from Hong Kong (Coleoptera: Staphylinidae). Coleopt. Bull. 25, 107–108.
- Moore, I. and Legner, E.F. (1972) A bit about beach beetles and habitat destruction. Environ. Southwest. 445, 7.

- Moore, I. and Legner, E.F. (1973) Speculation on the distribution of the southern California species of *Cafius* with a new record from the Salton Sea (Coleoptera: Staphylinidae). *Pan-Pac. Entomol.* 49, 279–280.
- Moore, I. and Legner, E.F. (1974a) Succession of the coleopterous fauna in wrack. *Wasmann J. Biol.* (1973) 31, 289–290.
- Moore, I. and Legner, E.F. (1974b) The larva and pupa of *Carpelimus debilis* Casey (Coleoptera: Staphylinidae). *Psyche* (1973) 80, 289–294.
- Moore, I. and Legner, E.F. (1974c) Seashore Entomology, a neglected fruitful field for the study of bio-systematics. *Insect World Digest* July–Aug., 20–24.
- Moore, I. and Legner, E.F. (1974d) Notes on *Bledius ornatus* LeConte, a seashore beetle, with description of the larvae (Coleoptera: Staphylinidae). *Wasman J. Biol.* 32, 151–154.
- Moore, Ian, Legner, E.F. and Chan, T.D. (1973) A review of the genus *Bryothinusa* with descriptions of three new species (Coleoptera: Staphylinidae). *Entomol. News* 84, 73–81.
- Morse, S. (1909) The insects of New Jersey. *Annu. Rep. N. J. St. Mus.* 888 pp.
- Motschulsky, V. von (1860) Enumeration de nouvelles especes de coléoptères rapportés de ses voyages. *Bull. Soc. Imp. Moscou* 38, 227–313.
- Mulsant, M.E. and Rey, C. (1870) Description d'un genre nouveaux de l'ordre des coléoptères tribu des brachélytres, famille des aléochariens. *Opusc. Entomol.* 14, 194–199.
- Mulsant, M.E. and Rey, C. (1872) Tribu de brévipennis: Famille des aléochariens: Huitième branche: Bolitochaires. *Ann. Soc. Linn. Lyon*, ser. 2, 19, 91–413, 426.
- Mulsant, M.E. and Rey, C. (1874) Tribu des brevipennes: Famille des aléochariens: Septième branche Myrmédonnaires. *Ann. Soc. Agric. Lyon* (4) 6, 33–738, (1873).
- Oliff, A.S. (1886a) A revision of the Staphylinidae of Australia, Part I. *Proc. Linn. Soc. NSW* (2) 1, 403–473.
- Oliff, A.S. (1886b) A revision of the Staphylinidae of Australia, Part II. *Proc. Linn. Soc. NSW* (2) 1, 887–906.
- Oliff, A.S. (1887) A revision of the Staphylinidae of Australia, Part III. *Proc. Linn. Soc. NSW* (2) 2, 471–512.
- Paulian, R. (1941) Les premier états des Staphyloinoidea. Étude de morphologie comparée. *Mem. Mus. Nat. Paris*, ser. 15, 1–361.
- Ross, E.S. (1953) *Insects close up.* (, ) 80 pp.
- Sakaguti, K. (1944) A new intertidal rove beetle from the Pacific coast of Japan. *Trans. Kansai Entomol. Soc.* 14, 20–21.
- Satô, M. (1964) Studies on the marine beetles of Japan, IV. Some remarks on the fauna of marine beetles in Japan. *J. Nagoya Jogakuin Coll.* 10, 76–81.
- Saunders, L.G. (1929) Some marine insects of the Pacific coast of Canada. *Ann. Entomol. Soc. Am.* 21, 521–545.
- Sawada, K. (1955) Marine insects of the Tokara Islands. VIII. Family Staphylinidae (Coleoptera). *Publ. Seto Mar. Biol. Lab.* 5, 81–89.
- Sawada, K. (1956) New intertidal species of Staphylinidae from Ishigakijima, Ryukyu Islands (Coleoptera). *Kontyû* 24, 197–199.
- Sawada, K. (1971) Aleocharinae (Staphylinidae, Coleoptera) from the intertidal zone of Japan. *Publ. Seto Mar. Biol. Lab.* 19, 81–110.
- Sharp, D. (1871) Description of a new genus and species of Staphylinidae (from South Australia). *Entomol. Mon. Mag.* 7, 217–218.
- Sharp, D. (1874) The Staphylinidae of Japan. *Trans. Entomol. Soc. Lond.* 1874, 1–101.
- Sharp, D. (1880) On some Coleoptera from the Hawaiian Islands. *Trans. Entomol. Soc. Lond.* 1880, 37–54.
- Sharp, D. (1889) The Staphylinidae of Japan. *Ann. Mag. Nat. Hist* (6) 3, 28–44, 108–121, 249–267, 319–334, 406–419, 463–476.



- Scheerpeltz, O. (1933) Coleopterorum Catalogus, pars 129, Staphylinidae VII, () pp. 989–1500.
- Scheerpeltz, O. (1934) Coleopterorum Catalogus, Pars 130, Staphylinidae VIII, () pp. 1501–1881.
- Schwarz, E.A. (1910) Coleoptera of the expedition. Harriman Alaska Ser., Smith. Inst. 8, 169–185.
- Steel, W.O. (1949) A new genus and species of Pacific (Chatham Is.) Staphylinidae. Entomol. Mon. Mag. 85, 309–310.
- Steel, W.O. (1964) Insects of Campbell Island. Coleoptera: Staphylinidae. Pac. Insects Monogr. 7, 340–375.
- Steinbeck, J. and Ricketts, E. (1941) Sea of Cortez, a leisurely journal of travel and research with a scientific appendix comprising materials for a source book of the marine animals of the Panamic Faunal Provenance. (, ) 598 pp.
- Thomson, C.G. (1858) Försök till uppställning af Sveriges Staphyliner. Öfv. Kön. Vet.-Akad. För. 15, 27–41.
- Tottenham, C.E. (1954) Handbook for Identification of British Insects. Coleoptera, Staphylinidae, sect. (a) Piestinae to Euaesthetinae. 4, pt. 8(a) () pp. 1–79.
- Waterhouse, C.O. (1875) On the Coleoptera of Kerguelen's Island. Entomol. Mon. Mag. 12, 54–57.
- Waterhouse, F.H. (1879) Descriptions of new Coleoptera of geographical interest, collected by Charles Darwin, Esq. J. Linn. Soc. Lond. 14, 530–534.
- Wendler, H. (1930) Neue exotische Staphyliniden (17. Beitrag zur Kenntniss der Staphylinidaen.) Neue Beit. Syst. Insekten 4, 181–192, 248–252.
- Westwood, J.O. (1838) Notes on subaquatic insects, with the description of a new genus of British Staphylinidae. Mag. Zool. Bot. 2, 124–132.
- Wollaston, T.V. (1857) Catalogue of the coleopterous insect of Madeira in the collection of the British Museum. (, ) 234 pp.
- Wollaston, T.V. (1864) Catalogue of the coleopterous insects of the Canaries in the British Museum. (, ) 648 pp.
- Wollaston, T.V. (1865) Coleoptera atlantidium, being an enumeration of the coleopterous insects of the Madeiras, Salvages and Canaries. (, ) 546 pp.

## Subject index

- acalyptrates, 466, 469  
 acarines, 80  
 actinomycetes, 352  
 adaptations,  
     breathing (*see* respiratory adaptations)  
     behavioural, 11, 16, 19, 24, 177, 226, 249, 250, 361, 490, 491  
     physiological, 16, 22  
     walking, 405, 406  
 Adriatic Sea, 127, 134  
 aerenchyma, 17  
 aeropyles, 66, 487  
 aestivation, 315  
 Africa,  
     east coast, 144, 220, 541  
     west coast, 125, 132, 319, 349, 531, 532, 538  
 aggregation, 166, 174, 313  
 air stores (*see also* plastron), 12, 17, 34, 46, 144, 145, 250, 276  
 air traps, 3, 13, 47, 94, 214, 250, 315, 490, 511, 514  
 akinesis, 50, 51  
 Alaska, 121, 132, 349, 353, 532, 540  
 alcohol dehydrogenase, 462  
 algae, 67, 121, 127, 130, 132, 410, 447–462, 501, 509–511, 528–546  
     epiphytic, 275  
     feeding on, 27, 28, 129, 173, 174, 177, 274, 296, 298, 352, 409, 453, 454, 483–485, 500, 509  
 amino acids, 27  
 anaplasmosis, 434  
 anautogeny, 317, 318, 433  
 anaemia, equine, 434  
 annelids, 141, 144, 361  
 anoxia, 15, 16, 33  
 ant associations, 522, 534  
 Antarctic, 384, 411, 516  
 anthomyids, 132  
 aphids, 11–14, 17, 24, 27, 28, 30, 31, 33, 99, 103, 113, 114  
 apodemes, 52  
 apolysis, 59, 61, 64, 65, 67  
 apterygotes, 151–180  
 Arabian Sea, 239  
 arachnids, 124  
 asparagine, 28  
 attractants, oviposition, 308  
 atrium, 64–66, 68, 71, 94  
 Australia, 122, 134, 143, 144, 232, 255, 282, 348, 411, 412, 534, 538, 541  
 autogeny, 317–318, 356, 358, 425, 433  
 bacteria, 352, 360, 453, 484, 485  
 Baja California, 122, 124, 145, 146, 348, 349, 530, 532, 540  
 Baltic Sea, 133, 171, 214, 226, 401, 407  
 beetles, 497–516, 521–546  
     Colorado, 115  
     rove, 521–546  
 benthic insects, 497  
 benzene hexachloride, 324  
 Bermuda Islands, 121  
 biomass, aerial, 98–103, 115  
 biting behaviour, 356, 357  
 blood,  
     chloride, 20  
     -feeding, 318, 319, 336, 356, 425, 429  
     -gills, 3  
     in spiracular gills, 59–62

- sucking behaviour, 86, 90
- worms, 377
- brachyptery, 29, 34, 233
- Brazil, 140, 175, 240, 349
- breeding cycle, 452, 453
- British Columbia, 274, 279, 282, 532
- British Isles, 121–124, 128, 129, 132–136, 142, 171, 173, 292, 301, 319, 386, 451, 508, 529, 534–539
- borborids, 448
- bugs,
  - dwarf, 239
  - shore, 225, 226
  - toad, 240
- buoyancy, 3
- burrowing insects, 13, 17, 355, 511, 540
- burrows, lice, 91
- butterflies, 98, 100, 101, 105, 107, 108, 110, 111
  - Monarch, 105
  - Painted Lady, 107
- caddis flies, 3, 19, 248, 291–301
- calamistrum, 140
- calcium, 1, 170, 362
- California (*see also* North America, Pacific), 122, 128, 134, 145, 147, 171, 173, 234, 282, 348, 384, 400, 510, 530, 531, 532, 534, 535, 542, 543
- canaceids, 70–73
- carabids, 508, 516
- CO<sub>2</sub>,
  - assimilation, 27, 169
  - diffusion, 47
  - fixation, 27
- carbon tetrachloride, 455
- Cenozoic, 243
- centipedes, 120–122
- Central America, 220, 232, 240, 245, 318, 319, 348, 349
- ceratopogonids, 335–365
- cestodes, 275
- chemoreception, 248, 429, 455
- Chile, 146, 235, 411
- chiloxanthine, 253
- China, 125, 206
- chironomids, 3, 208, 248, 377–412, 485
- Chlordane, 324
- chloride, 362
- chloroform, 455
- chloropids, 31, 103
- cholera, hog, 434
- chromosomes, 306, 425, 461
- coccids, 11, 17
- cocoon, 68, 70
- coelopids, 447–462
- competition, 2, 32, 35, 173, 282
- contact angle, 209
- continental drift, 256
- control, 322–327, 363, 364, 435, 436, 459, 460
- corixids, 20
- crabs, 132, 133
- crepuscular flying, 99, 100, 357
- Cretaceous, 245
- cribellum, 140
- cricket, 110
- Crustacea, 2
- cryptobiosis, 63
- cuticle,
  - development, 2, 24, 52, 59, 71, 166, 200, 244, 481
  - permeability, 18, 19, 34, 44, 52, 169, 277, 299, 490
  - surface structure, 65, 210
- cuticularization, 61
- cycle,
  - activity, 357, 433
  - diurnal, 315, 316, 350
- DDT, 323, 324, 363, 364
- density-height gradient, 103
- desiccation, 94, 311
- development, post-embryonic, 201, 202, 246, 273
- diapause, 309, 310, 350, 353, 354
- Dichlorvos, 364
- diet, 28, 35
- disease transmission, 322, 336, 362, 363, 416, 434
- dispersal, 21, 25, 29–32, 34, 97, 132, 255, 278, 279, 321, 322, 354, 355, 433, 455, 457, 492, 514
  - by wind, 105–112, 279, 355, 492
  - tidal, 29–31, 34
  - transoceanic, 105–112
- dissociation, 65, 66
- distribution,
  - bipolar, 516

- circumpolar, 536
- vertical, 354, 355
- diurnal flying, 99, 100, 113
- dolichopodids, 67–70, 140, 144, 487
- dragon-flies, 402, 430, 487
- drainage, 9, 12
- dryomyzids, 448
- dryopids, 500
- dunlins, 32
- Dyar's rule, 167
  
- ecdysis, 24, 25, 60, 61, 66, 67, 166
- echinophtherids, 84
- eclosion, 24, 25, 200, 201, 309, 310, 350, 351, 395, 396, 409, 481
- ectoparasites, 79, 80, 275, 314, 522, 535
- edge regions, 9, 10, 12, 15, 26, 30
- egg,
  - attachment, 86, 246
  - burster, 246
  - deposition (*see* oviposition) development, 86, 164–166, 200–202, 246, 273, 309, 317, 318, 350, 351, 356, 394, 425–427
  - hatching patterns, 310
  - mortality, 311
  - saldid, 74, 76, 246, 247
  - structure, 200, 202, 205, 350
- electrolyte, 20
- elytra, 250
- embryonic development, 201, 246, 309, 310, 394
- emergence,
  - diurnal, 397, 408, 409
  - factors, 7, 9
  - seasonal, 359, 360, 400, 401, 408, 452, 453
- encephalitis, 322, 363, 434
- endemism, 501
- energy,
  - flow, 28
  - metabolic, 22, 23
- entomophagy, 336
- enzymes, 462
- ephydrids, 465–492
- epidermal cells, 54, 59, 61–63, 66, 69
- epithelium, 170
- erosion, 10, 26
- esterase, 462
- estuaries, 2
  
- Europe, Atlantic, 121, 122, 124, 127, 130, 134, 142, 145, 153, 171, 173, 214, 229, 231, 235, 236, 238, 252, 253, 386, 450, 456, 508, 530–534, 536, 541
- euryhaly, 192, 226, 231, 232, 236, 237, 247, 248, 250, 253
- evolution, 2, 43, 44, 45, 52, 53, 60, 65, 199, 229, 241, 243–246
- excretory system, 169, 170
- exopterygotes, 80
  
- festucetum, 172
- filariasis, 322, 362, 363, 434
- fleas, 80
- flies,
  - brine, 465–492
  - deer, 415–436
  - harlequin, 377
  - horse, 415–436, 460
  - kelp, 141
  - seaweed, 447–462
  - shore, 465–492
- flight activity, 316, 317, 321, 406, 456
- flightless insects, 3, 31, 502, 514
- flower-feeding insects, 27, 429, 484, 522
- food chain, 28, 32
- food selection, 19, 26, 27, 356, 357
- fossil records, 2, 243, 245, 254, 280
- fungi, 33, 34, 311, 314, 315, 352, 361, 430, 484, 487
  
- Galapagos Islands, 122, 143, 220
- genes,
  - lethal, 461
  - sex, 461
- genetics, 326, 327, 460–462
- gills, 3, 17, 46–49, 62, 63, 511
  - compressible, 46–49, 280
  - incompressible, 47–49
  - lumen, 54, 59, 61, 62, 64, 65
  - permeability, 62, 63
  - physical, 3, 12, 17, 45–49, 168, 276
  - spiracular, 17, 45, 51–63, 65–69, 71–73
- glands,
  - nephridial, 170
  - scent, 208, 270, 275
- gliding, 406, 407
- glucose, 27

- glutamine, 27  
 glycogen, 319, 320  
 greenheads, 415, 416  
 Greenland, 536  
 grooming, 86, 209  
 growth-retardant, 313  
 Gulf of California, 127–131, 133–135, 140, 145, 147, 281  
 Gulf of Kiel, 132  
 Gulf of Mexico, 122, 129, 145, 281, 346, 349  
  
 habitats, 2, 9, 251, 252, 279–282, 307, 346–349, 362, 409–411, 466, 479, 491, 501, 521  
 haemocoele, 54  
 haemolymph, 66, 170, 176, 277, 278, 299–301, 490  
 haemosporidia, 434  
 hair fringe, 212  
     layers, 210  
 hairs,  
     hydrofuge, 3, 47, 209  
     spiracular, 455  
 halophily, 196, 226, 233  
 halophytes, 17, 27, 136, 137, 142  
 Hawaiian Islands, 70, 71, 411, 412, 532, 534  
 hemelytra, 247  
 heterochromatin, 461  
 heteropterans, 6  
 hibernation (*see* overwintering)  
 Holarctic Region, 171, 231, 237, 253  
 holometabolous insects, 497, 500  
 hormone, juvenile, 320  
 hybridization, 305, 306  
 hydrophilids, 510  
 hypersalinity, 18  
 hypopygial rotation, 396  
  
 iguanas, 135  
 immobilization, 11, 15, 48, 50, 51  
 immunity, 87, 93  
 India, 132  
 Indian Ocean, 348, 352, 532, 539  
 Indo-Pacific Region, 239, 253  
 insecticides, 322–327, 363, 364, 431, 435, 460  
 integument (*see* cuticle)  
 Inter-Tropical Convergence Zone (I.T.C.Z.), 110, 112  
 intertidal,  
     arthropods, 119–147  
     insects, 44, 45, 152, 171, 346–349, 510  
         zone, 2, 6  
 invaginations, abdominal, 89, 93, 94  
 ion excretion, 300  
 ion transport, 22, 23, 34, 169, 300, 301  
 ionic concentrations, 18–23, 26, 27  
     regulation, 17–23, 26, 27, 34, 152, 169, 170, 277, 278, 299–301  
 island colonization, 112, 113  
 isoenzymes, 461  
 isotonicity, 21  
  
 Japan, 128, 134, 142–144, 206, 216, 237, 240, 348, 402, 408, 411, 529, 530, 532, 534, 540, 541  
 Java, 70  
 Java Sea, 215  
 juncetum, 172  
 Jurassic, 243  
  
 larva,  
     development, 25, 29–31, 273, 294–297, 311–313, 344, 352–354, 394, 425–427, 451, 509  
     distribution, 432, 433  
     feeding, 311, 352, 402, 429, 453, 466  
     habitats, 307, 346–349, 362  
     respiration, 312, 488  
 lice, 73–75, 80–95  
     amblyceran, 80–84  
     ischnoceran, 80–84  
     mallophagan, 80–84  
 lichens, 65, 174  
 light intensity, 7  
 limnichids, 48, 510  
 lipids, 2, 166  
 locomotion, 212, 213, 313, 361, 405, 406, 490, 491  
 locust, 98, 107, 110  
 longevity, 167, 177  
 lygaeids, 110  
  
 macrophytes, 472, 485  
 Madagascar, 125, 245, 530  
 magnesium, 170, 362

- malaria, 322, 323  
 Malathion, 364  
 Malpighian tubules, 21–23, 170, 278  
 mammals, 79–95  
 manganese, 362  
 mangrove swamps, 2, 5, 29, 140, 171, 216, 226, 251–253, 323, 348, 349, 490  
 mannitol, 454  
 marsh (*see* Saltmarsh)  
 mating, 165, 166, 202, 247, 272, 296, 320, 321, 357–359, 397–400, 482, 483  
 Mediterranean Region, 121–123, 125, 127, 128, 143, 171, 253  
 medium, egg-laying, 454  
 melanin, 174  
 menisci, 72  
 Mesozoic, 243, 253  
 metamorphosis, 2  
 Mexico,  
     east coast, 132, 252  
     west coast, 128, 129, 240  
 microsporidia, 430  
 microtrichia, 48, 210  
 midges, 335–365, 435, 484  
 midgut fluid, 21  
 migration, 65, 66, 97–115, 316, 321, 456, 457, 459, 460  
 millipedes, 123, 124  
 Miocene, 243  
 mites, 80, 129–136, 180, 208, 249, 275, 361, 402, 430, 455, 486, 487, 509  
 mosquitoes, 3, 6, 17, 18, 25, 76, 104, 252, 303–327, 484  
 moths, 98, 100, 101, 105, 111  
     Diamond-Back, 105  
     Silver-striped Hawk, 107  
 moulting, 59, 60, 166, 167, 177, 201, 311, 426, 427  
 mud, anaerobic, 33  
 muscids, 448  
 mutations, 461  
  
 nectar-feeders, 429, 484  
 nematodes, 361, 430  
 neon, 47  
 neuston, 113–115  
 New Zealand, 122, 130, 136, 141, 143, 144, 146, 292, 296, 298, 412, 536  
 nitrogen, 46–48  
  
 noctuids, 105, 107  
 nocturnal flying, 99  
 North Africa, 121, 134, 143, 145, 235, 251, 253, 508, 531, 532  
 North America,  
     Atlantic coast, 127–129, 146, 240, 252, 346, 429, 456, 531, 535–537  
     Pacific, 132, 133, 229, 253, 386, 411, 456, 510, 531, 532, 534, 535, 537, 540, 541, 543 (*see also* California, Mexico, west coast, Alaska)  
 North Sea, 102, 132, 133, 172, 226, 401  
 North Temperate Province (Pacific coast), 543  
 nutrition, 26–29  
 nymphalids, 107  
  
 oceanic insects, 103–105, 187, 192, 217, 218, 220  
 ochterids, 226, 240  
 oil, diesel, 326  
 Oligocene, 243  
 organic solvents, 455, 456  
 orientation, solar, 514  
 osmoregulation, 3, 17–23, 26, 27, 34, 169, 176, 277, 299–301, 488–490  
 osmotic concentrations, 18–22, 26, 27  
 otters, 84  
 overwintering, 164, 272, 309, 315, 353, 425, 452  
 oviposition, 84, 86, 90, 92, 166, 200, 202, 203, 215, 220, 246, 247, 273, 296, 307, 308, 310, 350–352, 393, 398, 399, 424, 451, 483, 490  
 ovipositor, 193, 201, 239, 246, 483  
 oxygen,  
     conservation, 11  
     consumption (*see also* respiration), 15, 22, 23, 47, 48, 50, 67, 90, 168, 169  
     deficiency, 13, 16, 50, 51  
     diffusion, 2, 17, 46  
  
 Pacific Coast, 543  
 Palaeozoic, 2  
 Panamic Province, 543  
 papillae, 20  
 parasites, 31–35, 79–95, 132, 133, 249, 275, 311, 314, 315, 336, 360, 361, 430, 454, 485–487, 522, 535

- bird, 79–84
  - transfer of, 87, 90, 92
- Paris green, 326
- parthenogenesis, 163, 164, 357, 358, 388
- pathogens, 31–35, 314
- pauropods, 123
- pelican, 81
- penguin, 84
- peritrich ciliates, 275
- phenylthiourea, 62
- pheromones, 164, 174, 296
- phosphorus, 170
- pigmentation, 174
- plastrons, 12, 17, 45, 47–49, 51–76, 94, 211, 244, 250, 487
- plover, 31
- pollen feeders, 522
- pollinators, 336
- pollution indicators, 377
- population,
  - estimate, 102, 103
  - fluctuations, 26, 177, 179, 180, 206, 429, 451, 457
  - statistics, 1, 6, 7, 220
- poultry disease, 363
- pre-adaptations, 21, 24, 34, 63, 70, 407
- pre-copulatory barriers, 306
- predation,
  - by birds, 31, 32, 79–84, 204, 208, 209, 249, 275, 430, 454, 486, 487
  - by fish, 275, 298, 314, 402
  - by insects, 2, 206–208, 248, 249, 274, 311, 336, 352, 466, 484, 509, 522
- predation on insects, 2, 31, 32, 35, 180, 208, 249, 274, 275, 298, 313, 314, 336, 360, 430, 454
- primary production, 27, 434
- proline, 27
- pronotum, 238
- Propoxur (*see* Malathion)
- protease, 248
- protein, 356
- proto-salidid, 243
- protozoan infections, 275, 314, 361, 434
- pseudoscorpions, 126–129, 180
- ptilinum, 482
- puccinellietum, 172
- pupa,
  - case, 296, 297
  - chamber, 509
  - cuticle, 62, 64, 65, 511, 514
  - development, 315, 316, 354, 361, 395, 485, 486, 504, 508
  - respiratory devices, 52, 61, 68, 69
  - spiracular gills, 52, 54, 59, 61, 69, 72
- puparium, 482, 485, 486, 535
- pupation, effect of salinity, 23
- rectal fluid, 21, 300, 301, 490
- Red Sea, 125, 130, 239, 530, 532
- reef, intertidal, 226, 251
- rehydration, 63
- reproduction, 164, 177, 293
- respiration,
  - bubble, 46, 47, 94, 137, 209, 210, 245, 250
  - cutaneous (cuticular), 45, 49, 67, 93, 168, 250, 312, 488
  - egg, 74, 76, 487, 488
  - pharate adult stage, 52, 61, 64–67, 69, 71
  - submarine, 3
- respiratory adaptations, 2, 3, 11–17, 43–76, 168, 169, 276, 298, 299, 511, 514
  - horns, 49, 53, 64, 65, 67–71
  - siphons, 3
- respiratory system, chorionic, 74, 76
- resting behaviour, 354, 355, 359
- rhizophagid, 510
- rhythm,
  - circadian, 316
  - pupation, 315, 316
- root-living insects, 9, 12, 17
- root-tapping mechanisms, 17, 472, 485, 488
- salamanders, 275
- saldids, 12, 225, 256
- salinity, 3, 9, 10, 11, 17–23, 34, 277, 301
- salinity tolerance, 17
  - 23, 31, 33, 45, 67, 172, 173, 176, 226, 273, 277–282, 292, 299, 411, 456, 488, 490
- salpingids, 516
- salt ingestion, 19, 21, 26
- saltmarshes, 2, 5–35, 70, 143, 226, 251, 255, 432, 433, 535, 537, 538, 543
- Salton Sea, 282, 348, 514
- sampling methods, 98, 431
- sandflies, 336
- scales, 74, 75, 94
- sclerotin, 62

- sclerotization, 60, 61  
 scorpions, 124, 125  
 sea-grasses (*see also* *Zostera*), 7, 510  
 seals, 80, 84–95  
     elephant, 86–92  
 sea-skaters, 3, 187–220  
 sea-snakes, 135  
 sea-urchins, 132  
 seasonal abundance, 429, 451, 457  
 seaweeds (*see* algae)  
 setae, 48, 49  
 sex ratio, 164  
 sexual dimorphism, 380, 382, 389, 407  
 Seychelles, 352  
 shrews, 32  
 size variations, 401–404, 458  
 snakes, 135  
 sodium, 20  
 soil, 9, 10, 12, 13, 15, 26, 33  
 South Africa, 136, 143, 144, 146  
 South America (*see also* Chile, Brazil), 171, 220, 235, 255, 348  
 South Pacific Region, 135, 143, 144, 216, 220, 238, 240, 251–253, 349, 410, 456, 529, 531  
 Southeast Asia, 127, 128, 135, 140, 143, 144, 146, 199, 240, 245, 251, 318, 530–532, 537  
 speciation, 305, 306  
 species interaction, 458, 459  
 spermatophores, 163–165  
 sphingids, 107  
 spiders, 32, 35, 136–147, 180, 249, 487  
     jumping, 146  
     mygalomorph, 140  
     trap-door  
     wolf, 145  
 spinnerets, 137, 139  
 spiracles, 44, 45, 48, 51, 67, 68, 70, 94, 138, 144, 145, 169, 211, 239, 245, 250, 270, 488, 514  
 springing organ, 152  
 springtails, 152, 208  
 staphylinids, 510, 514, 521–546  
 stridulatory mechanism, 238, 247, 270, 271  
 strigil, 271  
 Subantarctic Region, 288, 509, 516, 531, 532, 534–536  
 submarine insects, 1, 407, 500, 510, 511, 528, 541–543  
 submergence, 1, 7–14, 16, 26, 33, 50, 511  
 substrate attachment, 25, 26, 86, 297  
 subterranean insects, 6, 12  
 sugar, 319, 320, 356  
 sulphate, 22, 23  
 sulphur hexafluoride, 47  
 surface-living insects, 6, 11  
 surface tension, 3, 24, 209  
 swarming, 321, 357, 399, 402  
 symphylids, 122  
  
 tabanids, 415–436  
 Tasmania, 122, 146  
 temperature, 26, 90, 299  
     tolerance, 175, 273, 279  
 tenebrionids, 510  
 terrestrial insects, 6, 21, 22, 97–115  
 Tertiary, 245  
 tethinids, 129  
 Tethys Sea, 253  
 thalassobiontics, 172, 176  
 ticks, 80, 129–136  
 tide  
     cycle, 351, 359, 408, 409, 514  
     range, 8, 9  
 tipulids, 61–67  
 tracheae, 44, 51, 52, 65, 169, 276, 514  
 transpiration, 166, 169–traps, 435, 436  
 trichloroethylene, 455  
 trichobothria, 140  
 trichopterans, 6, 20  
 triglycerides, 319, 320  
 trophic diversity, 28  
 trypanosomes, 434  
 tularaemia, 434–turgor, 60–63, 71  
  
 uric acid, 169, 170  
 urine, 277, 278, 300  
 urogomphi, 510, 514  
  
 ventilation, 15  
 ventral tube, 152, 154, 169, 170  
 vesicles, coxal, 154, 169  
 virus, 314, 315, 322, 363, 434



- water,
  - intake, 19
  - loss, 65, 169, 277
  - regulation, 152, 169, 170
- water-air interface,
  - ocean, 209
  - plastrons (*see also* plastron), 65, 67, 68, 70, 72
- water-boatmen, 263–282
- waterproofing, 13, 18, 25, 144
- water-striders, 187–220, 256, 402, 486, 472, 490
- wax layer, 168, 169, 209, 280
- waxing, 13, 17, 44
- weather, 111, 112
- West Indies, 127, 128, 132, 144, 199, 252, 255, 337, 346, 349, 352
- whipscorpions, 125
- wind, 107–109, 112
- wind-borne insects, 97–115
- wing,
  - development and adaptations, 2, 3, 405, 406, 514
  - reduction, 3, 278, 406
- wingless insects, 3, 29, 151, 193, 214, 406, 532
- wrack (*see* algae)
  
- yeasts, 484, 485
  
- zinc, 170, 362
- zonation, 28, 171, 172, 410, 411, 541

## Taxonomic index

Generic and specific names (in italics) with authors have been listed for insects and other air-breathing arthropods dealt with in chapter 6. Families and tribes (in capitals) have also been listed. Other animals and plants referred to in the text have been included and indicated here in parentheses.

- ACALYPTRATA**, 98, 102, 103  
*Acanthia*, 231, 236, 237  
**ACARIDAE**, 129  
*Actaetes*, 168, 171  
*Actaetes calcarius* Bellinger, 156  
*Actaetes neptuni* Giard, 156, 162, 171  
**ACTALETIDAE**, 153, 156, 157  
*Acticola*, 523, 533, 534  
*Acticola faulklandica* Cameron, 534  
*Actinidium*, 542  
*Actocharis*, 522, 529, 530  
*Actocharis marina* Fauvel, 530  
*Actornithophilus*, 83  
*Adalia bipunctata* (L.), 115  
 (*Adamastor-Aves*), 82  
*Adersia*, 423  
*Adonia variegata* (Goeze), 115  
*Aedeomyia* Theobald, 305  
*Aedes*, 305, 309, 313  
*Aedes australis* (Erichson), 307, 315, 317  
*Aedes caspius* Pallas, 18  
*Aedes dasyorrrhus* King and Hoogstraal, 307  
*Aedes detritus* (Haliday), 3, 18–22, 317, 319  
*Aedes mariaae* (Sergent and Sergent), 305–307  
*Aedes mitchellae* (Dyar), 306  
*Aedes nigromaculis* (Ludlow), 306, 308  
*Aedes phoeniciae* Coluzzi and Sabatini, 305  
*Aedes sollicitans* (Walker), 304, 306, 307, 309–312, 314, 317, 319, 321–324  
*Aedes taeniorhynchus* (Wiedemann), 18, 19, 22, 23, 34, 304, 307–324  
*Aedes vigilax* (Skuse), 322  
*Aedes zammitii* Theobald, 305, 306  
*Aegialites*, 498, 508, 509, 515, 542  
*Aegialites californicus* Motschoulsky, 509  
*Aegialites fuchsi* Horn, 493, 505  
*Aegialites stejnegeri* Linell, 509  
*Aegialites subopacus* (Van Dyke), 509  
*Aelia*, 114  
**AEOPHILINAE**, 228, 241  
*Aepophilus*, 48, 74, 228–231, 241–243, 246–250, 253, 511  
*Aepophilus bonnairei* Signoret, 230, 251, 253  
*Aepopsis*, 498, 507, 509, 515  
*Aepopsis robini* (Laboulbène), 25, 508, 512, 514  
*Aeopsis robinii*, 180  
*Aepus*, 498, 507, 515  
*Aepus robini*, 33  
 (*Aethia-Aves*), 83  
**AGAONTIDAE**, 101, 113  
*Agauopsis curvata* Krantz, 133  
*Agauopsis newelli* Krantz, 133  
**AGELENIDAE**, 137, 140, 143  
*Agonum*, 115  
*Agraptocorixa*, 266, 272, 273, 277  
*Agraptocorixa eurynome* (Kirkaldy), 266, 281  
*Agraptocorixa hirtifrons* (Hale), 266, 277, 281  
**AGROMYZIDAE**, 100–102  
 (*Akiba* (= *Leucocytozoon*) *caulleryi*-Protozoa), 363  
 (*Alca-Aves*), 83  
**(ALCIDAE—Aves)**, 83  
*Aleochara*, 523, 535, 536, 541, 542  
*Aleochara arenaria* Casey, 536, 545  
*Aleochara maritima* Casey, 535  
*Aleochara sulcicollis* Mannerheim, 535, 545  
**ALEOCHARINAE**, 522, 528–536  
**ALEOCHARINI**, 523, 529, 535  
**ALEYRODIDAE**, 100, 102  
 (*Alle-Aves*), 83  
*Allopauropus danicus* (Hans.), 123

- Allopauropus littoralis* Bagnall, 123  
*Allopauropus stepheni* Bagnall, 123  
*Allopauropus thalassophilus* Remy, 123  
*Amatopynia nebulosa*, 58  
*Amaurobiodes*, 136, 137, 146  
*Amaurobiodes africanus* Hewitt, 146  
*Amaurobiodes boydi* Forster, 146  
*Amaurobiodes litoralis* Hickman, 146  
*Amaurobiodes maritimus* O. Pickard-Cambridge, 146  
*Amaurobiodes major* Forster, 146  
*Amaurobiodes minor* Forster, 146  
*Amaurobiodes pallidus* Forster, 146  
*Amaurobiodes picunus* Forster, 146  
*Amaurobiodes piscator* Hogg, 146  
*Amaurobiodes pletus* Forster, 146  
*Amaurobiodes poharus* Forster, 146  
**AMAUROBIOIDAE**, 146  
 (Amaurobius—Araneida), 180  
*Amblopusa*, 522, 531, 532, 542  
*Amblopusa borealis* Casey, 532, 544  
*Amblopusa brevipes* Casey, 532, 544  
**AMBLYCERA**, 80, 81  
 (Amblychilepas—Mollusca), 144  
*Amblyoderus*, 542  
**AMERONOTHRIDAE**, 129  
*Ameronothrus bilineatus* (Mich.), 129  
*Ameronothrus marinus* (Banks), 129  
*Ameronothrus spoofi* (Oudms.), 129  
 (Amophila—Algae), 127  
 (Amphidinium—Algae), 484  
 (Amphineura—Mollusca), 132  
 (Amphora—Algae), 484  
*Anacotyle setoensis* Oi, 142  
*Ancistrona*, 81  
*Andregamasus*, 133  
**ANOBIIDAE**, 101  
**ANOETIDAE**, 129, 130  
 (Anomia—Mollusca), 144  
*Anopheles*, 76, 305, 309  
*Anopheles amictus amictus* Edwards, 317  
*Anopheles amictus hilli* Woodhill and Lee, 317  
*Anopheles atropos* Dyar and Knab, 310  
*Anopheles bradleyi* King, 306  
*Anopheles crucians* Wiedemann, 306  
*Anopheles farauti* Laveran, 305, 306, 319  
*Anopheles gambiae* Giles, 305, 310, 319, 327  
*Anopheles gambiae* var *meles* (Theobald), 25, 29  
*Anopheles melas* (Theobald), 305, 310, 319  
*Anopheles merus* Dönitz, 305, 319  
*Anopheles punctulatus* Dönitz, 305, 322  
*Anopheles sundaicus* (Rodenwaldt), 319  
**ANOPLURA**, 80, 81, 84–87  
 (Anous—Aves), 83, 204  
*Antarcticodromus*, 498, 508, 515  
*Antarcticodromus fallai* Brooks, 509, 513  
*Antarctophthirus*, 74, 85, 94  
*Antarctophthirus callorhini* (Osborn), 81, 87, 92, 93  
*Antarctophthirus lobodontis* Enderlein, 74, 81, 92, 94  
*Antarctophthirus mawsoni* Hawwison, 81  
*Antarctophthirus microchir* (Trouessart and Neumann), 81  
*Antarctophthirus ogmorhini* Enderlein, 75, 81, 85, 87, 88, 92–94  
*Antarctophthirus trichechi* (Bohemann), 74, 81, 94  
**ANTHICIDAE**, 508–510  
*Anthicus*, 542  
**ANTHOCORIDAE**, 100  
**ANTHOMYIDAE**, 102  
*Antocha*, 66  
*Antocha vitripennis* (Meigen), 59, 61–63  
*Anurida*, 156, 157, 171  
*Anurida bisetosa* Bagn., 171  
*Anurida boneti* Cassagnau, 162  
*Anurida denisi* Bagn., 171  
*Anurida granaria* (Nicolet), 162  
*Anurida maritima* (Guerin), 25, 156, 159, 164, 171, 172, 175, 177, 509  
*Anurida thalassophila* (Bagn.), 171  
*Anuridella*, 156, 157, 171  
*Anuridella calcarata* (Denis), 162, 171  
*Anuridella marina* (Will.), 171  
**ANYPHAENIDAE**, 137, 146  
*Apanteles*, 115  
 (Aphanothece *utahensis*—Algae), 484  
**APHIDIDAE**, 98, 100, 102, 113, 114  
*Aphis tripolii* Laing, 24, 25  
*Aphodius melanosticus* Schmidt, 115  
*Aphrosylus*, 17, 53, 61, 67, 68, 70  
*Aphrosylus celtiber* Haliday, 67–69  
*Aphrosylus praedator* Wheeler, 70  
*Apion*, 115  
*Aploneura lentisci* (Passerini), 13  
*Apocheiridium pelagicum* Redikorzev, 127  
*Apsena*, 542

- (*Aptenodytes*—Aves), 82  
**ARAEOPIDAE**, 100  
**ARANEAE**, 124  
*Archisotoma*, 156, 157  
*Archisotoma besselsi* (Packard), 29, 160, 171  
*Archisotoma interstitialis* Delamare Deboutteville, 171, 172  
*Archisotoma nigricans* Bagn., 171  
*Archisotoma pulchella* (Mon.), 171, 172, 176, 177  
**ARCTIIDAE**, 101  
 (*Arctocephalinae*—Mammalia), 81  
 (*Arctocephalus*—Mammalia), 85  
 (*Arctocephalus doriferus*—Mammalia), 81  
 (*Arctocephalus forsteri*—Mammalia), 81  
 (*Arctocephalus pusillus*—Mammalia), 81  
*Arctocoris*, 266, 272  
*Arctocoris carinata* (Sahlberg), 266, 279  
*Arctosa*, 145  
*Arctosa littoralis* (Hentz), 145  
*Arctosa perita* (Latreille), 145  
*Arena*, 522, 531  
 (*Armeria*—Angiospermae), 24  
 (*Armeria maritima*—Angiospermae), 27  
*Arpediomimus*, 522, 536  
*Arpediomimu faulklandicus* Cameron, 536  
*Arpediomimus kronei* Kiesenwetter, 536  
 (*Artemia salina*—Crustacea), 31  
 (*Ascophyllum*—Algae), 128  
*Asclepios*, 188, 190, 192, 199, 212, 216  
*Asclepios annandalei* Distant, 192  
**ASILIDAE**, 430  
*Askinasia aethiopicus* Yunker, 132  
*Askinasia sinusaribia* Yunker, 132  
*Asmeringa*, 446, 474, 478  
*Asmeringa linsleyi* (Sturtevant and Wheeler), 474  
*Aspidiaelaps*, 135  
 (*Aster tripolium*—Angiospermae), 31  
*Asyndetys*, 65  
**ATACARINAE**, 132  
*Atacarus giganteus* Krantz, 132  
*Atacarus pygmaeus* Schultz, 132  
*Atheta*, 523, 532–535  
*Athyroglossa*, 476  
*Atissa*, 475, 478  
*Atissa litoralis* (Cole), 468, 475  
*Atissa pygmaea* (Haliday), 475  
*Austrogoniodes*, 82  
*Austrogoniodes waterstoni* (Cummings), 84  
*Austromenopon*, 82, 83  
 (*Avicennia nitida* Jacquin—Angiospermae), 324  
*Axelsonia*, 157  
*Axelsonia littoralis* (Mon.), 156, 161, 171  
*Axelsonia tubifera* Strenzke, 171  
*Axysta*, 472, 477  
*Baeostethus*, 522, 531, 532  
*Baeostethus chiltoni* Broun, 532  
 (*Balanus balanoides*—Crustacea), 121, 132  
*Ballophilus riveroi* Chamberlin, 122  
**BARYCHELIDAE**, 137, 140  
 (*Bathymermis*—Nematoda), 430  
 (*Bdella longicornis* var. *littoralis*—Acarina), 180  
**BDELLIDAE**, 25, 130  
*Bedfordiella*, 82  
*Belgica*, 379, 384, 388, 406, 411  
*Belgica antarctica* Jacobs, 379, 384, 385, 411  
*Belonura singularis* Ashmead, 486  
**BELOSTOMATIDAE**, 275  
*Bembidion*, 50, 498, 507, 542  
*Bembidion laterale* (Samouelle) (= *Cillelus lateralis* Samouelle), 13, 32, 33  
*Berosus*, 542  
 (*Beta vulgaris* ssp. *maritima*—Angiospermae), 27  
*Bidessus megacephalus* (Gschwendtner), 500  
**BLASTOBASIDAE**, 101  
*Bledius*, 31, 33, 50, 510, 511, 522, 537, 538, 542  
*Bledius arenarius* Paykull, 33  
*Bledius diota* Schiødte, 19  
*Bledius fenysi* Bernhauer, 537, 545  
*Bledius fracticornis* Paykull, 526  
*Bledius monstratus* Casey, 538, 545  
*Bledius ornatus* LeConte, 537  
*Bledius spectabilis* Kraatz, 13–16, 19, 21, 27  
*Bledius taurus* Germ. (= *furcatus* Olivier), 19  
**BLEPHAROCERIDAE**, 61, 62  
*Bolitochara*, 532, 533  
*Bolitochara impacta* Blackburn, 532, 533  
*Bolitocharini*, 522, 529–533  
*Bombus*, 24  
 (*Boodlea*—Algae), 410  
**BORBORIDAE**, 450  
*Brachydeutera*, 472, 474, 476, 478, 482, 490, 492

- Brachydeutera argentata* (Walker), 471, 474, 481, 489  
*Brachydeutera hebes* (Cresson), 483, 485  
*Brachygeophilus admarinus* Chamberlin, 121  
*Brachypronomaea*, 522, 529, 530  
 (*Brachyramphus*—Aves), 83  
**BRACONIDAE**, 101, 104  
*Braunsiomyia*, 423  
*Briobiota bicolor* Casey, 530, 545  
*Bryobiota*, 522, 529, 530, 542  
*Bryothinusa*, 522, 529, 530, 542  
*Bryothinusa catalinae* Casey, 544  
 (*Bubulcus ibis*—Aves), 430  
 (*Bulweria*—Aves), 82  
**BUPRESTIDAE**, 101  
 (*Burnupena*—Mollusca), 144
- Caenia*, 115  
*Cafius*, 514, 523, 540–543  
*Cafius canescens* Mäklin, 545  
*Cafius decipiens* Horn, 545  
*Cafius lithocharinus* LeConte, 545  
*Cafius luteipennis* LeConte, 524, 545  
*Cafius opacus* LeConte, 545  
*Cafius seminitens* Horn, 525, 545  
*Cafius sulcicollis* Mannerheim, 545  
*Cafius xantholoma* Gravenhorst, 528  
 (*Calidris alpina*—Aves), 32  
*Callicorixa*, 266, 271, 272  
*Callicorixa audeni* Hungerford, 266, 274, 281  
*Callicorixa praeusta* (Fieber), 266, 281  
*Callicorixa producta* (Reuter), 266, 279  
 (*Callorhinus*—Mammalia), 85  
 (*Callorhinus ursinus*—Mammalia), 74, 81, 92, 93  
*Caloglyphus*, 129  
*Cambridgea*, 137  
*Cameronium*, 522, 531, 532  
*Camptocladus* (see *Thalassosmittia*)  
*Camptopus lateralis* (Germar), 114  
*Canace*, 44, 49, 53, 65, 71, 471  
*Canace nasica* Haliday, 67, 71–73  
**CANACEIDAE**, 45, 49, 53, 70–73, 469  
*Canaceoides nudatus* (Cresson), 471  
**CARABIDAE**, 48, 101, 496, 500–502, 506, 509, 510, 514–516  
 (*Carcinus maenas*—Crustacea), 402  
 (*Cardisoma crassum* Smith—Crustacea), 307  
 (*Cardisoma guanhumii* (Latreille)—Crustacea), 307
- Caritohallex minyrrhopus* Crabill, 122  
*Carpelimus*, 522, 537, 538, 542  
*Carpelimus lucidus* Cameron, 538  
 (*Catenella repens*—Algae), 65  
 (*Catharacta*—Aves), 83  
*Catorama*, 542  
**CECIDOMYIDAE**, 98, 101, 102, 114  
*Cedicus*, 137  
*Cenocorixa*, 266, 272, 274, 277–282  
*Cenocorixa bifida bifida* (Hungerford), 266, 274, 277–279, 281, 282  
*Cenocorixa bifida hungerfordi* Lansbury, 266, 281  
*Cenocorixa dakotensis* (Hungerford), 266  
*Cenocorixa expleta* (Uhler), 264, 266, 269, 274, 277, 278, 280–282  
*Cenocorixa utahensis* (Hungerford), 266  
 (*Centromerita bicolor*—Araneida), 180  
 (*Cepphus*—Aves), 83  
*Ceraleptus obtusus* (Brullé), 114  
**CERATOCOMBIDAE**, 231  
*Ceratopogon*, 336  
**CERATOPOGONIDAE**, 6, 101, 102, 114, 335–365, 500  
*Cercyon*, 498, 500, 501, 507, 510, 514, 516, 542  
*Cercyon fimbriatus* Mannerheim, 512  
*Ceropsilopa*, 475, 478  
*Ceropsilopa costalis* Wirth, 475  
*Ceropsilopa staffordi* Cresson, 475  
 (*Cerorhinca*—Aves), 83  
*Chaetopsis apicalis* Johnson, 24  
*Chaetopsis fulvifrons* (Macquart), 24  
**CHALCIDOIDEA**, 98  
**(CHARADRIIFORMES-Aves)**, 83  
 (*Charadrius hiaticula*—Aves), 32  
*Chartoscirta*, 228, 238, 239, 241, 243  
*Chartoscirta cincta* (Herrich-Schaeffer), 238  
*Chartoscirta cocksii* (Curtis), 250  
*Chartoscirta elegantula* (Fallén), 238  
**CHELIFERIDAE**, 127  
**CHERNETIDAE**, 127  
*Chetocephalus*, 523, 539  
*Chetocephalus maritimus* Cameron, 539  
**CHIERIDIIDAE**, 127  
*Chilodera*, 523, 535  
*Chilodera faulklandica* Cameron, 535  
**CHILOXANTHINAE**, 228, 231–233, 241  
*Chiloxanthus*, 228, 231, 241, 242, 245, 253  
*Chiloxanthus arcticus* (J. Sahlberg), 231

- Chiloxanthus pilosus* (Fallén), 231, 250  
**CHIRONOMIDAE**, 1, 6, 45, 49, 58, 71, 76, 98, 99, 101, 102, 114, 274, 377–412, 500  
**CHIRONOMINAE**, 378, 380  
*Chironomus*, 381, 394, 402  
*Chironomus aprilius* Meigen, 18, 20  
*Chironomus enteromorphae* Tokunaga, 381  
*Chironomus halophilus* Kieffer, 18, 20, 381  
*Chironomus salinarius* Kieffer, 18, 20, 381  
*Chironomus thummi* var. *thummi* Kieffer, 18  
(*Chlamydomonas*—Algae), 484  
(*Chlidonias*—Aves), 83  
**CHLOROPIDAE**, 100–103  
*Chlorotabanus*, 423  
*Chrysogaster hiretella* Loew  
**CHRYSOMELIDAE**, 101, 499, 501, 502, 510  
**CHRYSOPIDAE**, 98, 113  
**CHRYSOPINAE**, 420, 422, 423, 430  
*Chrysops*, 17, 415–418, 421, 423, 430, 431, 434, 435  
*Chrysops atlanticus* Pechuman, 416, 417, 421, 423, 427, 429, 432–434  
*Chrysops discalis* Williston, 434  
*Chrysops fuliginosus* Wiedemann, 421, 423, 424, 426, 429, 432, 433  
*Chrysops italiae* Meigen, 423  
**CHTHONIIDAE**, 127  
*Chthonius tetrachelatus* Preyss, 127  
*Cicadella*, 114  
**CICADELLOIDAE**, 100, 102  
*Cicindela*, 542  
*Cillenus*, 498, 507, 510  
**CIMICIDAE**, 236  
*Cinara abieticola* (Cholod.), 105, 106  
*Cirrula*, 469, 472, 473, 476, 479, 482, 486, 490, 491  
*Cirrula gigantea* Cresson, 473  
*Clanoneurum*, 475, 477, 479, 485  
*Clanoneurum americanum* Cresson, 475  
*Clasiopella uncinata* Hendel, 475  
**CLERIDAE**, 101  
*Clinopodes poseidonis* Verhoef, 121  
*Clubiona*, 146  
*Clubiona littoralis* Banks, 146  
**CLUBIONIDAE**, 137, 138, 145, 146  
*Clunio*, 208, 378, 379, 382, 388–412  
*Clunio africanus* Hesse, 378  
*Clunio aquilonius* Tokunaga, 378, 392, 396, 401, 402  
*Clunio brasiliensis* Oliveira, 379  
*Clunio brevis* Stone and Wirth, 379  
*Clunio californiensis* Hashimoto, 379, 383, 389, 391, 392, 398  
*Clunio fuscipennis* Wirth, 379  
*Clunio littoralis* Stone and Wirth, 379, 391  
*Clunio marinus* Haliday, 378, 393–395, 397, 398, 401, 407–409, 411, 412  
*Clunio marshalli* Stone and Wirth, 379  
*Clunio martini* Hashimoto, 379, 412  
*Clunio pacificus* Edwards, 379  
*Clunio purpureus* Hashimoto, 379, 393, 396, 399, 406, 410, 411  
*Clunio schmitti* Stone and Wirth, 379,  
*Clunio setoensis* Tokunaga, 378  
*Clunio takahashii* Tokunaga, 378, 389, 393, 399, 400, 406, 409–411  
*Clunio tsushimensis* Tokunaga, 378, 383, 390, 391, 394–399, 401–405, 408, 410  
*Clunio tuthilli* Tokunaga, 379  
*Clunio vagans* Stone and Wirth, 379, 391, 411  
**CLUNIONINAE**, 378, 380, 382  
*Clynotis barresi* Hogg, 146  
*Cnephelocotes curtis* Simon, 142  
*Coccinella quinquepunctata* L., 115  
*Coccinella undecimpunctata* L., 115  
**COCCINELLIDAE**, 101, 114  
**COCCOIDEA**, 100, 102  
(*Coelomomyces*—Fungi), 430  
(*Coelomomyces opifex* (Pillai and Smith)-Fungi), 315  
(*Coelomomyces psorophorae* Couch-Fungi), 315  
*Coelopa*, 449–462  
*Coelopa frigida* Fabricius, 21, 448–462  
*Coelopa frigida* Mayhew = *C. frigida* Fabricius, 21, 448–462  
*Coelopa palauensis* Hardy, 456  
*Coelopa pilipes* Haliday, 450, 451, 453, 455, 457–459, 461  
**COELOPIDAE**, 76, 447–462  
*Coenia*, 473, 476, 479  
*Coenia curvicauda* (Meigen), 473  
(*Coenobita*—Crustacea), 132  
**COLEOPHORIDAE**, 101  
*Colpocephalum*, 83  
*Copidognathus*, 132  
(*Corallina*—Algae), 143  
(*Corallina officinalis*—Algae), 296, 298  
*Corallis*, 522, 530, 531

- Corallis poryporum* Fauvel, 531  
*Corallicoris*, 228, 239, 240, 242, 246, 249, 251  
*Corallicoris marksae* (Woodward), 241, 242, 251, 254  
*Corallicoris nauruensis* (Herring and Chapman), 240, 254  
*Corallicoris satoi* (Miyamoto), 240, 254  
**CORDILURIDAE** (= **SCATOPHAGIDAE**), 415  
**COREIDAE**, 100  
*Corisella*, 266, 272, 277  
*Corisella decolor* (Uhler), 266  
*Corisella edulis* (Champion), 277, 278  
*Corisella inscripta* (Uhler), 266  
*Corisella tarsalis* (Fieber), 266, 281  
*Corixa*, 266, 267, 272  
*Corixa affinis* Leach, 266, 272, 281  
*Corixa dentipes* (Thomson), 277, 278  
*Corixa panzeri* (Fieber), 267  
*Corixa punctata* (Illiger), 267, 275, 279, 281  
**CORIXIDAE**, 263–282  
(*Cornicularia kochi*—Araneida), 180  
(*Corophium volutator*—Crustacea), 171  
**CORYNETIDAE**, 101  
*Craspedonirmus*, 83  
(*Crepidula*—Mollusca), 144  
*Cressonomyia*, 475, 478  
*Cressonomyia aeneonigra* (Loew), 475  
*Cressonomyia hinei* (Cresson), 475  
*Cricotopus*, 382  
*Cricotopus vitripennis* var. *halophilus* Kieffer, 18  
**CUCUJIDAE**, 101  
*Culex*, 76, 305, 308, 309  
*Culex annulirostris* Skuse, 322  
*Culex iolambdis* Dyar, 322  
*Culex pipiens quinquefasciatus* Say, 308  
*Culex tarsalis* Coquillett, 398  
*Culex thalassius* Theobald, 319  
**CULICIDAE**, 6, 58, 98, 101, 102, 303–327, 500  
*Culicoides*, 336–364, 430  
*Culicoides arakawae* Arakawa, 363  
*Culicoides arubae* Fox and Hoffman, 349, 363  
*Culicoides austeni* Carter, 349, 358, 359, 362  
*Culicoides barbosai* Wirth and Blanton, 349, 351, 354, 356–360  
*Culicoides belkini* Wirth and Arnaud, 349  
*Culicoides bermudensis* Williams, 348, 349, 357, 358, 362  
*Culicoides cancer* Hogue, 349  
*Culicoides circumscriptus* Kieffer, 349, 352, 357–361, 363  
*Culicoides denningi* Foote and Pratt, 351  
*Culicoides furens* (Poey), 337, 341, 342, 347–349, 351–364  
*Culicoides grisescens* Edwards, 351  
*Culicoides guyanensis* Floch and Abonnenc, 349  
*Culicoides halophilus* Kieffer, 349, 351  
*Culicoides henryi* Lee and Reye, 361  
*Culicoides hollensis* Melander and Brues, 340, 342, 348, 357, 360, 362  
*Culicoides hortensis* Khamala and Kettle, 363  
*Culicoides insignis* Lutz, 349  
*Culicoides machardy* Campbell and Pelham-Clinton, 349, 361  
*Culicoides maritimus* Kieffer, 349, 361  
*Culicoides marmoratus* Skuse, 358  
*Culicoides marium* Lutz, 349  
*Culicoides melleus* Coquillett, 346, 347, 350–356, 358, 360, 361, 363  
*Culicoides miharai* Kinoshita, 349  
*Culicoides molestus* Skuse, 348, 361  
*Culicoides nebeculosus* (Meigen), 337, 344, 345  
*Culicoides obscuripennis* Clastrier and Wirth, 349  
*Culicoides ornatus* Taylor, 351, 359  
*Culicoides peliliouensis* Tokunaga, 349, 351, 359, 360  
*Culicoides phlebotomus* (Williston), 346, 348, 353, 361  
*Culicoides picturatus* Kremer and Deduit, 349  
*Culicoides reticulatus* Lutz, 349  
*Culicoides salinarius* Kieffer, 349, 360, 361  
*Culicoides subimmaculatus* Lee and Reye, 348, 351, 359, 361  
*Culicoides tristriatulus* Hoffman, 349, 353, 360, 361  
*Culicoides vistulensis* Skierska, 349  
*Culicoides waringi* Lee and Reye, 358  
*Culiseta* Felt, 305  
*Culiseta subochrea* (Edwards), 317  
**CURCULIONIDAE**, 48, 101, 499, 502, 504, 515, 516  
**CYBOCEPHALIDAE**, 101  
(*Cyclorrhynchus*—Aves), 83  
*Cymatia*, 265, 272–274, 278  
*Cymatia americana* Hussey, 265, 278, 281  
*Cymatia bonsdorffi* (Sahlberg), 265, 281

- Cymatia coleoptrata* (Fabricius), 265, 274, 281  
*Cymatia rogenhoferi* (Fieber), 265  
**CYMATINAE**, 265, 278  
*Cymatopus*, 67  
**CYNIPIDAE**, 486  
*(Cyprinodon v. variegatus* (Lacépède)-Pisces), 314  
*Cyrthyrolaelaps hirtus* Berlese, 136  
*(Cystophora cristata*—Mammalia), 81
- Dactylochelifer laterellei* (Leach), 127  
*Danaus plexippus* L., 105  
*(Daption*—Aves), 82  
*Dasycorixa*, 266, 272  
*Dasycorixa rawsoni* Hungerford, 266, 281  
*Dasyhelea*, 336 340, 344, 346, 349, 350, 352, 356, 358, 360  
*Dasyhelea calvescens* Macfie, 349, 350  
**DASYHELEINAE**, 346  
*Deinocerites* Theobald, 305, 307, 312, 318  
*Deinocerites cancer* Theobald, 307, 309, 317–320  
*Deinocerites epitedeus* (Knab), 318  
*Deinocerites mathesoni* Belkin and Hogue, 307  
*Deinocerites pseudus* Dyar and Knab, 307, 318, 322  
**DELPHACIDAE**, 100  
*Deltocephalus*, 114  
**DERBIDAE**, 100  
**DESIDAE**, 137, 138, 143, 144  
**DESINAE**, 143, 144  
*Desis*, 136, 137, 143, 144  
*Desis crosslandi* Pocock, 143  
*Desis formidabilis* O. Pickard-Cambridge, 143  
*Desis galapagoensis* Hirst, 143  
*Desis gardineri* Pocock, 143  
*Desis hartmeyeri* Simon, 143  
*Desis inermis* Gravely, 143  
*Desis japonica* Yaginuma, 143  
*Desis kenyonae* Pocock, 144  
*Desis marinus* (Hector), 144  
*Desis martensi* L. Koch, 144  
*Desis maxillosa* (Fabr.), 144  
*Desis ribeci* Berland, 144  
*Desis tangana* Toewer, 144  
*Desis vorax* L. Koch, 144  
*Diachlorus*, 423  
*Diaulota*, 522, 529, 531, 532, 542  
*Diaulota densissima* Casey, 544  
*Diaulota fulviventris* Moore, 544  
*Diaulota harteri* Moore, 542, 544  
*Diaulota vandykei* Moore, 544  
*Dicheirotrichus gustavi* Crotch (= *pubescens* Paykull), 13, 15  
*Dicranomyia*, 53, 54, 60–62, 64, 402  
*Dicranomyia monostromia* Tokunaga, 53, 54, 56, 67  
*Dicranomyia trifilamentosa* Alexander, 53–55, 58, 66, 67  
*Dichirotrichus*, 50  
*Dictyna mineata* Banks, 131, 139–141  
**DICTYNIDAE**, 137, 140, 141  
*Diestota testacea* Krattz, 533  
*Diglochis occidentalis* (Ashmead), 430  
*Diglossa*, 511  
*Diglotta*, 523, 530, 533, 542  
*Diglotta pacifica* Fenyès, 545  
**DIGLOTTINI**, 523, 529, 530  
*Dimecoenia*, 469, 472, 473, 476, 479, 482, 486, 490, 491  
*Dimecoenia austrina* (Coquillett), 473  
*Dimecoenia caesia* (Wulp), 480  
*Dimecoenia fuscifemur* Steyskal, 473  
*Dimecoenia lenti* Oliviera, 486  
*Dimecoenia spinosa* (Loew), 470, 473, 480, 488, 489, 491  
*Dinocheirus carminis* (Chamberlin), 127  
*(Diodora*—Mollusca), 144  
*(Diomedea*—Aves), 82  
**(DIOMEDEIDAE**-Aves), 82  
*Diphuia*, 475, 478  
*Diphuia nitida* Sturtevant and Wheeler, 475  
*Diplocanthopoda marina* Abraham, 146  
*Discomyza*, 475, 477, 485  
*Discomyza maculipennis* (Wiedemann), 475  
*Discomyza u-signata* Cresson, 475  
*(Distichlis spicata*—Angiospermae), 349, 362, 426, 432  
*Docophoroides*, 82  
**DOLICHOPODIDAE**, 45, 49, 53, 54, 61, 67–71, 102, 115, 486  
*Dolichopus*, 67  
*Dolichopus nubilus* Meigen, 67  
*Dollfusella minutissima* China, 239  
*Donacia*, 510  
*Drosophila*, 207, 248, 453, 454, 461  
*Drosophila subobscura* Collin, 461  
**DROSOPHILIDAE**, 101, 102



- Drusilla*, 523, 533, 534  
*Drusilla canaliculata* Dillwyn, 534  
*Drymeia*, 115  
**DRYOMYZIDAE**, 450, 452  
**DRYOPIDAE**, 500, 501  
*Dyschirius*, 31, 498, 507, 510, 542  
**DYTISCIDAE**, 275, 497, 500, 501, 506
- ECHINOPHTHIRIIDAE**, 84, 88  
*Echinophthirius*, 84  
*Echinophthirius horridus* (von Olfers), 81, 88  
 (*Ectocarpus*—Algae), 410  
 (*Ectocarpus confervoides*—Algae), 296, 298  
*Eidmanniella*, 83  
**ELACATIDAE**, 48  
**ELASMIDAE**, 101  
**ELMIDAE**, 500  
*Elnis naugetti*, 49  
*Emphyastes*, 499, 507, 514, 542  
*Enalosalda*, 228, 231, 235, 241, 242, 245, 246, 253  
*Enalosalda mexicana* (Van Duzee), 232, 249, 253  
*Endalus disgregus*, 75  
*Endeodes*, 499, 507, 509, 510, 515, 542  
*Endeodes basalis* LeConte, 545  
*Endeodes blaisdelli* Moore  
*Endeodes collaris* LeConte, 513, 545  
*Endeodes insularis* Blackwelder, 544  
*Endeodes rugiceps* Blackwelder, 545  
 (*Endocladia*—Algae), 409  
*Enochrus*, 486, 542  
**ENTEROHALACARINAE**, 132  
*Enterohalacarus minutipalpus* Viets., 132  
 (*Enteromorpha*—Algae), 65, 71, 133, 409  
 (*Entomophthora*—Fungi), 34, 487  
*Epactiochernes tristis* (Banks), 127  
*Epactiochernes tumidus* (Banks), 127  
*Epantius*, 499, 508, 510  
**EPERMENIIDAE**, 101  
*Ephyastes*, 510  
*Ephydra*, 19, 469, 472, 473, 476, 479, 482–492  
*Ephydra bruesi* Cresson, 484  
*Ephydra cinerea* Jones, 473, 483, 484, 486, 488, 490, 492  
*Ephydra hians* Say, 483, 486, 488, 490  
*Ephydra millbrae* Jones, 473  
*Ephydra obscuripes* Loew, 473  
*Ephydra packardii* Wirth, 468, 480, 483, 484, 486–490  
*Ephydra riparia* Fallén, 18–21, 490  
*Ephydra subopaca* Loew, 467, 468, 470, 473, 480, 481, 483  
**EPHYDRIDAE**, 101, 102, 114, 465–492  
**EPHYDRINAE**, 470, 472–474, 485, 491  
**EPHYDRINI**, 469, 473, 490  
*Episbates*, 82  
*Epithalassius*, 67  
*Eretmoptera*, 379, 384, 388, 406, 411  
*Eretmoptera browni* Kellogg, 379, 385  
*Eretmoptera murphyi* Schaeffer, 379  
 (*Erignathus barbatus*—Mammalia), 81  
*Erigone*, 142  
*Erigone arctita* (White), 142, 180  
*Erigone longipalpis* (Sundevall), 142  
**ERIGONIDAE**, 141  
*Erigonopsis littoralis* Hewitt, 142  
*Erioptera*, 17, 45  
*Erioptera flavescens* (L.), 45  
*Erioptera squalida* Loew, 45  
*Erioptera stictica* (Meig.), 45  
**ERYTHRAEIDAE**, 135, 136  
 (*Eudypetes*—Aves), 82  
 (*Eudypula minor*—Aves), 82, 83  
*Eugamasus immanis* (Berl.), 133  
 (*Euglena*—Algae), 353  
*Eukoenenia*, 125  
**EULOPHIDAE**, 101  
 (*Eumetopias*—Mammalia), 84  
 (*Eumetopias jubatus*—Mammalia), 81  
*Eupodes*, 130  
*Eupodes halophilus* Halbert, 130  
**EUPOPIDAE**, 130  
*Euscelis obsoletus* Kirsch, 34  
*Euscorpius carpathicus* (L.), 125  
*Euscorpius flavicaudis* (DeGeere), 125  
*Eutanyderus*, 68  
*Eutrombicula*, 135  
*Eutrombicula poppi* Vercammen-Grandjean, 135  
**EVIPHIDIDAE**, 130–132  
*Ewingia cenobitae* Pearce, 132  
**EWINGIDAE**, 132  
*Falagria*, 523, 533, 534  
*Falagria obscura* Gravenhorst, 533  
 (*Festuca rubrum*—Angiospermae), 172  
 (*Ficus*—Angiospermae), 113

- Folsomia*, 157  
*Folsomia fimetaria* (L.), 173  
*Folsomia sexoculata* (Tullbg.), 156, 160, 172, 173, 177, 179  
*Folsomia thalassophila* Bagn., 156  
*Forcipomyia*, 336  
*Forcipomyia obesa* Costa Lima, 336  
**FORCIPOMYINAE**, 346  
**FORMICIDAE**, 101  
 (Fratercula—Aves), 83  
 (Fregata—Aves), 83  
**(FREGATIDAE—Aves)**, 83  
*Fregatiella*, 83  
 (Fregetta—Aves), 82  
*Friesea*, 157  
*Friesea acuminata* Denis, 156, 159, 171, 172  
*Friesea fagei* (Denis), 156  
*Fucellia*, 115, 456  
*Fucellia maritima* Haliday, 448, 450, 453–455  
*Fucellia tergina* Zett., 132  
 (Fucus—Algae), 128, 143, 249, 251, 452, 453, 459, 510  
 (Fucus spiralis—Algae), 132, 133  
**FULGOROIDAE**, 100, 102  
 (Fulmarus—Aves), 82,  
 (Fundulus confluentus Goode and Bean-Pisces), 314  
 (Fundulus grandis Baird and Girard-Pisces), 314  
**FUNGIVORIDAE (= MYCETOPHIIDAE)**, 98, 102, 114, 115  
  
**GAMASOLAEELAPTIDAE (= HALOAEELAP-  
 IDAE)**, 132  
 (Gambusia—Pisces), 314  
 (Gambusia affinis holbrooki Girard-Pisces), 314  
 (Garrodia—Aves), 82  
**GARYPIDAE**, 128  
*Garypus*, 128  
*Garypus beauvoisi* Savigny, 128  
*Garypus californicus* (Banks), 128  
*Garypus floridensis* (Banks), 128  
*Garypus japonicus* Beier, 128  
*Garypus litoralis* L. Koch, 128  
*Garypus pallidus* Chamberlin, 128  
*Garypus sini* Chamberlin, 126, 128  
*Gasparia*, 137  
*Gasparia delli* Forster, 144  
*Gasparia kaiangaroa* Forster, 144  
  
*Gasparia littoralis* Forster, 144  
*Gasparia nelsonensis* Forster, 144  
*Gastrops*, 472, 478  
 (Gecarcinus lateralis (Freminville)-Crustacea), 307  
**(GEKKONIDAE—Reptilia)**, 104  
**GELASTROCORIDAE**, 226–229, 240, 246  
*Gelastrocoris oculatus* (Fabricius), 247  
**GELECHIIDAE**, 101  
 (Gelidium divaricatum—Algae), 410  
 (Gelochelidon—Aves), 83  
*Geogarypus micronesiensis* Morikawa, 128  
*Geogarypus nigrimanus* (Simon), 128  
*Geolycosa pikei* Marx, 145  
*Geranomyia*, 53, 62, 64, 65  
*Geranomyia bezzi* Alexander & Leonard, 53  
*Geranomyia unicolor* Haliday, 53, 54, 57, 58, 61, 62, 64–67  
**GERRIDAE**, 45, 188–193, 199, 202, 214  
*Gerris*, 214  
*Gerris thoracicus* Schummel, 214  
**GERROMORPHA**, 243  
*Glenanthe*, 475, 477  
*Glenanthe fascipennis* Sturtevant and Wheeler, 475  
*Glenanthe litorea* Cresson, 475  
*Glenoptectus*, 529  
 (Glyceria—Angiospermae), 488  
*Gnaphosa maritima* Platnick and Shadab, 145  
*Gnaphosa synthetica* Chamberlin, 145  
**GNAPHOSIDAE**, 137, 139, 145  
*Gohia*, 137  
 (Gordius—Nematoda), 430  
*Grammonota trivittata* Banks, 143  
 (Grimmia amblyophylla C.M.-Musci), 511  
*Gryllus bimaculatus* Degeer, 110  
 (Gygis—Aves), 83  
 (Gygis alba—Aves), 209  
**GYRINIDAE**, 501  
  
*Hadropinus*, 523, 539, 540  
*Hadropinus fossor* Sharp, 540  
*Hadrotes*, 523, 539, 540, 542  
*Hadrotes crassus* Mäklin, 540, 545  
*Hadrotes wakefieldi* Cameron, 540  
*Haemonia*, 499, 504, 507, 510, 514  
*Haemonia curtisi* Lac., 17  
*Haemonia mutica* F., 17  
*Haffneria*, 83  
**HAHNIIDAE**, 137, 138, 144

- Halarachne*, 133  
**HALACARIDAE**, 132, 133  
 HALACARINAE, 132  
**HALARACHNIDAE**, 133  
*Halacarus anomalus* Trouessart, 132  
*Halacarus magniporus* Krantz, 133  
 (*Halichoerus grypus*-Mammalia), 81  
 (*Haliator*—Aves), 83  
*Halipeurus*, 82  
**HALIPLIDAE**, 501, 506  
*Halirytus*, 379, 388, 406, 411  
*Halirytus amphibius* Eaton, 379, 388, 411  
*Halirytus macquariensis* Brundin, 379, 388, 411  
*Halirytus magellanica* Jacobs, 379, 411  
*Halixodes chitonis* (Brucker), 132  
 HALIXODINAE, 132  
*Halmaeus*, 522, 529, 530  
 (*Halobaena*—Aves), 82  
*Halobates*, 1, 103, 104, 187, 188, 190–192, 199–212, 215–218, 220  
*Halobates esakii* Miyamoto, 192  
*Halobates flaviventris* Eschscholtz, 192, 212, 220  
*Halobates germanus* White, 202, 205, 206, 220  
*Halobates hawaiiensis* Usinger, 202, 206, 208  
*Halobates mangrovensis* Schmidt and Mueller, 192  
*Halobates melleus* Linnavuori, 192  
*Halobates micans* Eschscholtz, 190, 192, 199, 202, 206, 220  
*Halobates sericeus* Eschscholtz, 192, 202, 206–208, 220  
*Halobates sobrinus* White, 202, 220  
*Halobates splendens* Witlacz, 220  
*Halobates trynae* Herring, 192  
 HALOBATINAE, 188, 190  
*Halobisium occidentale* Beier, 128  
*Halobisium orientate* Redikorsev, 128  
*Halobrecta*, 523, 533, 534  
*Halocoryza*, 498, 507, 510  
 (*Halocyptena*—Aves), 82  
**HALOLAELAPIDAE**, 132  
*Halolaelaps celticus* Halbert, 132  
*Halolaelaps incisus* Hyatt, 132  
*Halolaelaps marinus* (Brady), 132  
 (*Halophila*—Angiospermae), 410  
*Halophilus dimidiatus augustus* (Latzel), 121  
*Halorates reprobus* O. Pickard-Cambridge, 143  
*Halorhadinus*, 522, 529, 530  
*Halosalda*, 228, 233, 234, 237, 241, 243  
*Halosalda concolor* (Puton), 234  
*Halosalda lateralis* (Fallén), 12, 233, 234, 250, 252, 255  
*Halovelina*, 188, 189, 193, 194, 199–202, 208, 210, 213–216, 220  
*Halovelina danae* Herring, 194  
*Halovelina marianarum* Usinger, 202, 216  
*Halovelina maritima* Esaki, 402  
*Halovelina paulian* Poisson, 194  
*Halovelina septentrionalis* Esaki, 193  
 HALOVELIINAE, 188, 189  
*Harpalus*, 115  
*Harrisoniella*, 82, 83  
**HEBRIDAE**, 189  
*Hecamede*, 475, 478, 479, 485  
*Hecamede albicians* (Meigen), 475  
*Hecamede persimilis* Hendel, 489  
*Helcomyza ustulata* Curt., 448, 450, 452, 453, 455  
*Haliotthis armigera* (Hb.), 111  
*Hermatobates*, 188, 190, 198, 208, 213, 215, 216, 218  
*Hermatobates weddi*, 198  
**HERMATOBATIDAE**, 188–190, 197–199  
**HEMEROBIIDAE**, 98, 113, 114  
**HESPERIIDAE**, 101  
*Hesperocorixa*, 267, 272, 276, 278, 282  
*Hesperocorixa laevigata* (Uhler), 267, 274, 281  
*Hesperocorixa linnei* (Fieber), 281  
*Hesperocorixa sahlbergi* (Fisher), 267, 281  
**HETEROCERIDAE**, 499, 508, 510  
*Heterocerus*, 499, 510, 514  
*Heterocerus fenestratus* Thunberg, 13, 15, 16  
*Heterota*, 522, 531, 532  
*Heterota plumbea* Waterhouse, 532  
*Heterothops*, 522, 539  
*Heterothops binotata* Erichson, 256, 539  
*Hexacola*, 486  
*Hippotion celerio* (L.), 106, 107  
**HISTERIDAE**, 510  
*Hoogstraalacarus tiwiensis* Yunker, 132  
*Huara*, 137  
*Husseyella*, 188, 189, 196, 199, 213, 216, 218  
*Husseyella diffidens* Drake and Harris, 196  
*Husseyella halophila* Drake, 196  
*Husseyella turmalis* Drake and Harris, 195, 196

**HYADESIDAE**, 133*Hyadina*, 472, 477*Hybomitra*, 423, 433*Hyadesia*, 133*Hyadesia fusca* (Lohmann), 133*Hydrachna*, 274*Hydrachna conjecta* Koenike, 274**HYDRAENIDAE**, 45, 48, 501, 515, 516*Hydraena gracilis* Germar, 48*Hydrellia*, 466, 469, 472, 474, 476–479, 482–489, 491*Hydrellia agitator* Deonier, 474*Hydrellia americana* Cresson, 474*Hydrellia griseola* (Fallén), 471, 474, 480, 481, 489*Hydrellia philippina* Ferino, 468*Hydrellia valida* Loew, 474*(Hydrobates—Aves)*, 82*(Hydrobia ulvae—Mollusca)*, 29, 171*Hydrochasma*, 475, 478*Hydrochasma buccatum* (Cresson), 475*Hydrogamasus*, 134*Hydrogamasus littoralis* (G. and R. Canestrini), 134*(Hydrogamasus salinus—Acarina)*, 180*Hydrometra*, 214**HYDROMETRIDAE**, 189, 214*Hydromyza*, 486**HYDROPHILIDAE**, 101, 486, 497, 498, 500, 501*Hydroporus*, 67*Hydroporus oceanus* (Macquart), 67*Hydroprogne*, 83*Hydroschendyla submarina* (Grube), 120, 121*(Hydrurga leptonyx—Mammalia)*, 81*Hygrocelethus*, 67*Hylotydeus hydrodromus* Berlesae and Trouessart, 130*Hyphalus insularis* Britton, 48, 49*(Hypnea—Algae)*, 410*Hypocaccus*, 542*Hypocharassus*, 67*Hypogastrura*, 157*Hypogastrura gisini* Strenzke, 155, 158, 171*Hypogastrura vernalis* (Carl), 175*Hypogastrura viatica* (Tullbg.), 155, 158, 164, 173, 175, 177, 178, 180**HYPOGASTRURIDAE**, 153, 155, 157*Hyponygrus*, 539*Hyponygrus punctulatus* Paykull, 526*Hyponygrus tricolor* Fabricius, 522, 539**ICHNEUMONIDAE**, 98, 101, 115*Idioctis littoralis* Abraham, 140*Idioglochina*, 53, 61, 62, 64*Idioglochina marmorata* (Osten-Sacken), 54, 56*Ioscytus*, 228, 234, 241, 243, 252*Ioscytus politus* (Uhler), 234, 251*Ioscytus politus flavicosta* Reuter, 234*Iotarphia*, 523, 533, 534*Iotarphia australis* Cameron, 534**ISCHNOCERA**, 80, 81*Isobactrus*, 132*Isobates littoralis* = *Thalassiobates littoralis**Isocytus politus flavicosta* Reuter*Isotoma maritima* Tullbg., 156, 161, 171–173*Isotoma maritima* ssp. *boneti* Delamare Deboutteville, 156, 171*Isotoma saltans* (Nici), 175*Isotoma viridis* Bourl., 176, 179**ISOTOMIDAE**, 153, 156, 157*Isotomiella minor* (Schäff.), 173*Isotomurus palustris* (Müller), 176**JASSIDAE**, 100, 114*(Juncus—Angiospermae)*, 488*(Juncus gerardii—Angiospermae)*, 172*(Juncus roemerianus—Angiospermae)*, 362, 432*Kenodactylus*, 498, 507, 515*(Laboulbenia pedicillata—Fungi)*, 33**LAELAPIDAE**, 133*Laius*, 499, 508, 510, 515*(Laminaria—Algae)*, 452–455, 459*Lamproscatella*, 473, 476*Lamproscatella dictaeta* (Loew), 473*Lamproscatella quadrisetosa* (Becker), 473*Lamproscatella salinaria* (Sturtevant and Wheeler), 473*Lamproscatella sibilans* (Haliday), 473**LAMPYRIDAE**, 48**(LARIDAE—Aves)**, 83*(Larosterna—Aves)*, 83*(Larus—Aves)*, 83*Lasiohelea*, 336*Latagophthirus*, 84**LATHRIDIIDAE**, 101, 509*Lepidocyrtus lanuginosus* (Gmelin), 172*Lepidophthirus*, 85

- Lepidophthirus macrorhini* Enderlein, 81, 87–94  
*Lepidophthirus piriformis* Blagoveschensky, 81  
**LEPIDOSTOMATIDAE**, 296  
**LEPISMATIDAE**, 154, 165  
*Leptinotarsa decimlineata* (Say), 115  
LEPTOCONOPINAE, 346  
*Leptoconops*, 336–340, 344–348, 350–364  
*Leptoconops (Styloconops) australiensis* Lee, 348, 351  
*Leptoconops (Holoconops) becquaerti* Kieffer, 337, 348, 351–360, 364  
*Leptoconops (Holoconops) borealis* Gutsevich, 337  
*Leptoconops (Holoconops) kerteszi* Kieffer, 337, 348, 351–353, 355, 357, 358, 360–364  
*Leptoconops (Leptoconops) bezzii* Noé, 362  
*Leptoconops (Leptoconops) irritans* Noé, 337, 348, 353, 358, 360, 362  
*Leptoconops (Holoconops) linleyi* Wirth and Atchley, 346  
*Leptoconops (Leptoconops) nipponesis* Tokunaga, 348  
*Leptoconops (Styloconops) spinosifrons* (Carter), 337, 345, 348, 352, 355, 357, 360, 361, 364  
*Leptokoenia gerlachi* Conde, 125  
(*Leptonychotes weddelli*—Mammalia), 81, 92  
*Leptopsilopa*, 475, 478  
*Leptopsilopa nigrimana* (Williston), 475  
*Leptopsilopa similis* (Coquillett), 475  
(*Leptotrombium*—Acarina), 402  
*Liancalus virens* (Scopoli), 67  
(*Ligia*—Isopoda), 146  
(*Lichina pygmaea*—Lichen), 65  
*Limnephilus affinis* Curtis, 19–21, 292, 301  
**LIMNICHIDAE**, 499, 501, 516  
(*Limnocharis*—Acarina), 486  
*Limnognonus*, 214  
(*Limulus*—Xiphosura), 16  
*Linotaenia*, 122  
**LINYPHIIDAE**, 137, 141–143  
*Lionyx hedgpethi* Chamberlin, 122  
*Liparocephalus*, 522, 531, 532, 542  
*Liparocephalus brevipennis* Mäklin, 531, 544  
*Liparocephalus cordicollis* LeConte, 531, 544  
*Liparocephalus tokunagi* Sakaguti, 531  
*Lipochaeta*, 474, 477, 484, 492  
*Lipochaeta slossonae* Coquillett, 468, 474  
*Lipse*, 487  
*Lipsothrix*, 62, 64  
*Lissorhynchus oryzophilus* Kuschel (= *L. oryzae*), 74  
*Litarachna denhami* Lohmann, 134  
(*Lithodomus*—Mollusca), 144  
(*Lithophyllum*—Algae), 143  
(*Lithothamnion*—Algae), 143  
*Litisedes*, 137  
*Litisedes shirahamaensis* Oi, 143  
(*Littorina*—Mollusca), 121, 171  
(*Loa loa*—Nematoda), 434  
(*Lobipes*—Aves), 83  
(*Lobodon carcinophagus*—Mammalia), 81, 92  
LOHMANELLINAE, 132  
*Longimenopon*, 82  
(*Loomelania*—Aves), 82  
(*Lucania parva*—Pisces), 314  
(*Lunda*—Aves), 83  
(*Lutra*—Mammalia), 84  
*Lycosa*, 145  
*Lycosa arenicola* O. Pickard-Cambridge, 145  
*Lycosa pullata* (Clerk), 145  
*Lycosa purbeckensis* F.O. Pickard-Cambridge, 145  
**LYCOSIDAE**, 137, 139, 145  
**LYGAEIDAE**, 100  
*Lymnaeum*, 498, 507  
**LYONETIIDAE**, 101  
*Machaerium*, 67  
**MACHILIDAE**, 153, 154, 165, 169  
*Macralymma*, 536  
*Macralymma punctiventris* Cameron, 536  
(*Macronectes*—Aves), 82  
*Macrosaldula*, 237  
*Macrosiphum miscanthi* (Takahashi), 105  
*Macrovelia*, 214  
**MACROVELIIDAE**, 189, 196, 214  
**MADEOVELIIDAE**, 189  
*Malacomyia*, 449, 450  
*Malacomyia sciomyzina* Haliday, 450  
**MALLOPHAGA**, 80–84  
(*Mansonella ozzardi*—Nematoda), 363  
*Mansonia perturbans* (Walker), 17  
*Marpissa marina* (Goyen), 146  
*Martinius*, 499, 508, 510, 513  
*Medon*, 523, 539  
*Medon brunneus* Erichson, 527  
(*Megadyptes*—Aves), 82

- Megamelus*, 24, 114  
*Megamelus marginatus* Van Duzee, 24  
**MELYRIDAE**, 48, 499, 509, 515  
**MENOPONIDAE**, 81  
**MENTHIDAE**, 128  
*Menthus lindahli* (Chamberlin), 128  
*Meropathus*, 498, 507, 515  
*Meropathus chuni* Enderlein, 512  
*Mesembriorrhinus*, 499, 507, 515  
*Mesembriorrhinus eatoni* Waterhouse, 510–512  
*Mesobuthus gibbosus* (Brulle), 125  
*Mesovelia*, 188–190, 196, 214  
*Mesovelia halirrhya* Polhemus, 196  
*Mesovelia mulsanti* (White), 197  
**MESOVELIIDAE**, 188–190, 196, 197, 211, 212, 214  
*Metaphidippus*, 147  
(*Metarrhizium anisopliae*—Fungi), 33  
*Methobuthus confucius* (Simon), 125  
**METROCORINI**, 199  
*Mexico*, 499, 508  
*Micracanthia*, 228, 235, 237, 241, 243, 252, 255  
*Micracanthia humilis* (Say), 235  
*Micracanthia hungerfordi* (Hogden), 235, 251, 252  
*Micracanthia husseyi* Drake and Chapman, 251  
*Micalymma*, 522, 536  
*Micalymma brevipenne* Gyllenhal, 536  
*Micalymma marina* (Stroem.), 180  
*Microbledius*, 522, 537, 538  
*Microbledius actitus* Herman, 538  
*Microbuthus fagi* Vachon, 125  
(*Microcystis packardii*—Alga), 484  
**MICROLEPIDOPTERA**, 98, 101  
*Micronecta*, 265, 272, 274, 278  
*Micronecta annae* Kirkaldy, 265, 281  
*Micronecta gracilis* Hale, 265, 281  
*Micronecta jenkiniae* Hutchinson, 265  
*Micronecta meridionalis* (Costa), 265  
*Micronecta plicata* (Costa), 266  
*Micronecta proba* Distant, 266  
*Micronecta robusta* Hale, 266, 281  
*Micronecta seutellaris* (Stal), 266  
**MICRONECTINAE**, 265, 266, 270, 271  
(*Microtrombidium*—Acarina), 361  
*Microvelia*, 214  
**MICROVELIINAE**, 188, 189  
**MICRYPHANTIDAE**, 142  
**MILICHIIDAE**, 101, 102
- MIRIDAE**, 100  
(*Mirounga*—Mammalia), 85, 87  
(*Mirounga leonina*—Mammalia), 81  
*Mizaga*, 137  
*Mizaga chevreuxi* Simon, 143  
*Mizaga racovitzai* Fage, 143  
(*Mollienesia latipinna*—Pisces), 314  
**(MONACHINAE—Mammalia)**, 81  
(*Monachus*—Mammalia), 85  
(*Monachus monachus*—Mammalia), 81  
(*Monostroma*—Alga), 409  
*Morikawia johnstoni* (Chamberlin), 127  
(*Morus*—Aves), 83  
*Motschulskium*, 542  
*Mosillus*, 475, 476, 477  
*Mosillus tibialis* Cresson, 475  
*Muizenbergia abrahami* Hewitt, 144  
*Musca domestica* L.  
**MUSCIDAE**, 76, 102, 450, 453  
**MYCETOPHILIDAE**, 98, 102, 114, 115  
*Myianoetus*, 129  
*Myllaena*, 529, 530, 542  
**MYLLAENINI**, 522, 528, 529  
**MYMARIDAE**, 101, 430  
*Mynoglenes insolens* Simon, 143  
*Mynoglenes marrineri* Hogg, 143  
*Myrmecopora*, 523, 533, 534  
**MYRMEDONINI**, 523, 529, 533–535  
*Myro marinus* (Goyen), 144  
**MYRONINAE**, 137, 143, 144  
(*Mytilus*—Mollusca), 132, 133, 144  
*Myzus persicae* (Sulz.), 27, 28
- NABIDAE**, 100  
*Nabis ferus* (L.), 114  
*Naemia seriata* Felsheimer, 430  
(*Nannopterum*—Aves), 83  
*Nanorchestes amphibius* Topsent and Trouessart, 133  
**NANORCHESTIDAE**, 133  
*Naubates*, 82  
**NAUCORIDAE**, 250, 275  
(*Navicula*—Algae), 484  
**NEANURIDAE**, 153, 155–157  
(*Nemalion*—Algae), 409  
**NEMASOMIDAE**, 124  
*Neoanagraphis*, 146  
**NEOBISIIDAE**, 128

- Neobisium maritimum* (Leach), 128, 180  
*Neodiplothele picta* Vellard, 140  
*Neomachilis halophila* Silvestri, 173  
*Neomolgus littoralis* (Linnaeus), 130  
*Neopachylopus*, 542  
 (Neophoca cinerea—Mammalia), 81  
*Neoscatella*, 473, 476, 479, 482, 485  
*Neoscatella obscuriceps* (Cresson), 473  
*Neoscatella setosa* (Coquillett), 473  
*Nerthra*, 228, 240, 242, 247, 248  
*Nerthra macrothorax* (Montrouzier), 240  
*Nerthra manni* Todd, 240  
*Nerthra rugosa* (Desjardins), 226, 240  
*Nerthra spangleri* Polhemus, 240  
*Nesiotinus*, 82  
 (Nesofregatta—Aves), 82  
*Nesomalium*, 522, 536  
*Nilaparvata lugens* (Stal.), 105  
*Nipponorgarypus enoshimaensis* Morikawa, 129  
**NITIDULIDAE**, 101  
 (Nitzschia—Algae), 484  
**NOCTUIDAE**, 98, 101  
*Nomophila noctuella* Schiff., 107  
**NOTERIDAE**, 501  
*Notiphila*, 472, 474, 477, 479, 483, 485, 486, 488–492  
*Notiphila aenigma* Cresson, 474  
*Notiphila bispinosa* Cresson, 474  
*Notiphila erythrocerata* Loew, 474  
*Notiphila furcata* (Coquillett), 474  
*Notiphila loewi* Cresson, 471, 481  
*Notiphila occidentalis* Cresson, 474  
*Notiphila riparia* Meigen, 488, 489  
**NOTIPHILINAE**, 469, 471, 472, 485, 491  
*Notonecta*, 47  
**NOTONECTIDAE**, 250, 275  
*Nyctunguis*, 122  
**NYMPHALIDAE**, 101  
  
*Obisium submersum* Bristowe, 128  
 (Oceanites—Aves), 82  
 (Oceanodroma—Aves), 82  
**OCHTERIDAE**, 227–229, 240, 242, 243, 246, 248  
*Ochterus*, 229, 242  
*Ochterus aenifrons* (Champion), 226, 242, 252  
*Ochterus americanus* (Uhler), 226, 242  
*Ochterus banski* Barber, 247  
  
*Ochterus perbosci* (Guerin), 226, 242  
*Ochthebius*, 498, 507, 515, 542  
*Ochthebius quadricollis* Mulsant, 511, 513  
*Ochthera*, 469, 472, 474, 477, 479, 482–485, 487, 490, 492  
*Ochthera mantis* (De Geer), 471, 480, 481, 489  
*Ochthera tuberculata* Loew, 474, 487  
**(ODOBENIDAE-Mammalia)**, 81  
 (Odobenus rosmarus—Mammalia), 81  
**ODONATA**, 430  
**OECOPHORIDAE**, 101  
**OEDEMERIDAE**, 509  
*Oedenops*, 474, 477  
*Oedenops nudus* (Coquillett), 474  
*Oedoparea*, 449  
*Oedoparea buccata* Fallèn, 450, 452, 454  
*Oedothorax fucus* Blackwall, 142  
 (Oedothorax retusus—Araneida), 180  
*Oligosaldina*, 228, 241, 246, 254  
*Oligota*, 522, 529  
*Oligota pusillima* Gravenhorst, 529  
**OLIGOTINI**, 522, 528, 529  
**OMALIINAE**, 522, 523, 536  
*Omaliomimus*, 522, 536  
*Omalium*, 522, 536  
*Omalium rivulare* Paykull, 525  
*Omania*, 228, 239, 241, 242  
*Omania coleoprata* Horvath, 239, 254  
**OMANIIDAE**, 45, 48, 49, 74, 227–229, 239–256  
 (Ommatophoca rossi—Mammalia), 81  
**ONYCHIURIDAE**, 153–156  
*Onchiurus*, 158  
*Onychiurus armatus* (Tullbg.), 169, 173  
*Onychiurus debilis* (Mon.), 155, 158, 171, 172  
*Opifex* Hutton, 305  
*Opifex fuscus* Hutton, 3, 18–20, 307, 317, 320  
**OPIIDAE**, 129  
**OPOMYZIDAE**, 101, 102  
**OPOSTEGIDAE**, 101  
*Oramia*, 137, 141  
*Oramia chathamensis* (Simon), 141  
*Oramia crucifera* (Hogg), 141  
*Oramia littoralis* Forster and Wilton, 141  
*Oramia marplei* Forster, 141  
*Oramia occidentalia* (Marples), 141  
*Oramia rubrioides* Hogg, 141  
*Oramia solanderensis* Forster and Wilton, 141  
*Orchelimum fidicinium* Rehn & Hebard, 28  
*Orchesella*, 164

- Orchesella cincta*, 163, 167, 168  
*Orchesella villosa* (Geoffroy), 168  
 (Orchestoidea—Crustacea), 132, 540  
*Oreokora*, 235  
*Orimagula*, 61–63  
*Orphnaeus brevilabiatus* (Newport), 122  
*Orthidus*, 523, 540, 541  
*Orthidus cribratus* Erichson, 541  
*Orthidus curtipennis* Cameron, 541  
**ORTHOCLADIINAE**, 378–382  
*Orthocladius*, 382  
*Orthohalarachne*, 133  
*Orthophrys*, 228, 235, 241, 243, 245, 246  
*Orthophrys mexicanus* Van Duzee = *Enalo-salda mexicana*  
*Orthophrys pygmaeum* (Reuter), 234, 235, 251, 253  
*Orygma*, 449, 452, 456  
*Orygma luctuosa* Meigen, 76, 449, 450, 452, 454, 455, 461  
*Oscinella frit* L., 100, 103  
*Otago chathamensis* Forster, 144  
*Otago nova* Forster, 144  
*Otago wiltoni* Forster, 144  
 (*Otaria bryonia*—Mammalia), 81  
**(OTARIIDAE-Mammalia)**, 81  
*Oudemansia*, 156, 157  
*Oxypoda*, 523, 535  
*Oxypoda tarda* Sharp, 535  
**OXYPODINI**, 523, 529, 535  
*Oxypus olens* (Mueller), 50  
 (*Oxystele*—Mollusca), 144  
*Oxytelinae*, 522, 523, 529, 537  
*Oxytelus*, 522, 537, 538  
  
*Pachybrachius dubius* Reuter, 110  
*Pachybrachius vinctus* Say, 110  
**PACHYGNATHIDAE**, 133  
 (*Pachyptila*—Aves), 82  
*Pacificana*, 137  
**PAEDERINAE**, 523, 539  
 (*Padina*—Algae), 127  
 (*Pagodroma*—Aves), 82  
 (*Pagophila*—Aves), 83  
 (*Pagophilus groenlandicus*—Mammalia), 81  
*Palpomyia*, 336  
 (*Pandanus*—Angiospermae), 240  
**PANGONINAE**, 420, 422, 423  
*Pantara flavescens*, 402  
*Parachernes litoralis* Muchmore, 127  
  
*Paraclisis*, 82  
*Paraclunio*, 379, 386, 388, 393, 399, 402, 405, 410–412  
*Paraclunio alaskensis* Coquillett, 379, 387, 401, 410, 412  
*Paraclunio spinosus* Hashimoto, 379  
*Paraclunio trilobatus* Kieffer, 379, 412  
*Paracoenia*, 473, 476, 479, 485, 487  
*Paracoenia bisetosa* (Coquillett), 473  
*Paracoenia fumosa* Stenhammar, 470, 487  
*Paracoenia fumosalis* Cresson, 473  
*Paracoenia turbida* (Curran), 484, 487  
*Paractocharis*, 522, 531  
*Paraliochthonius*, 127, 128  
*Paraliochthonius puertoricensis* Muchmore, 127  
*Paraliochthonius singularis* (Menozzi), 127  
*Paraliochthonius takashimai* (Morikawa), 128  
*Paralitarachna degiustii* Cook, 134  
*Paralosalda*, 228, 232, 241, 242, 245, 249  
*Paralosalda innova* Polhemus and Evans, 232, 233, 253  
*Parascatella*, 473, 476  
*Parascatella marinensis* Cresson, 473  
*Parascatella melanderi* Cresson, 473  
*Parasiticus kembersi* Oudms, 133  
**PARASITIDAE**, 133  
*Paratheuma*, 137, 138, 144  
*Paratheuma insulanus* Banks, 144  
*Paratheuma interaesta* (Roth and Brown), 131, 142, 144  
*Paratissa*, 475, 478  
*Paratissa pollinosa* (Coquillett), 475  
 (*Partuniella*—Acarini), 487  
*Parydra*, 466, 472, 474, 476–478, 482, 483, 485, 492  
*Parydra copis* Clausen and Cook, 474  
*Parydra imitans* Loew, 474  
*Parydra penisica* Clausen and Cook, 474  
*Parydra transversa* Cresson, 474  
**PARYDRINAE**, 469, 471, 472, 485, 492  
*Patasson*, 430  
 (*Patella*—Mollusca), 144  
*Pectiniunguis americanus* Chamberlin, 122  
*Pectiniunguis* sp., 122  
*Pectinopygus*, 83  
*Pelachoris*, 228, 232, 233, 241, 243, 246  
*Pelachoris leucographa* (Rimes), 232  
 (*Pelagodroma*—Aves), 82  
**(PELECANIDAE-Aves)**, 83



- (PELECANIFORMES-Aves)**, 82, 83  
*(Pelecanoides—Aves)*, 82  
**(PELECANOIDIDAE-Aves)**, 82  
*Pelignellus*, 475, 477, 478  
*Pelignellus subnudus* Sturtevant and Wheeler, 475  
*Pelina*, 472, 477  
*Pellenes*, 147  
*Pellenes ammophilus* Chamberlin, 147  
*Pellenes polius* Chamberlin, 147  
*Pelmatocerandra*, 82  
*(Pelvetia—Algae)*, 133  
*Pemphigus bursarius* L., 31  
*Pemphigus trehernei* Foster, 12–14, 24–26, 29–31, 33  
*Pentacora*, 228, 231–235, 241, 243, 245–247, 249, 252–255  
*Pentacora hirta* (Say), 252  
*Pentacora malayensis* Dover, 232, 252  
*Pentacora saratogae* Cobben, 249  
*Pentacora signoreti* (Guerin), 233, 242, 250, 252  
*Pentacora signoreti yucatanana* Hodgden, 247, 252  
*Pentacora sphacelata* (Uhler), 242, 252, 253  
**PENTATOMIDAE**, 100  
**PERILAMPIDAE**, 101  
*Perileptus*, 498, 507, 515  
*(Perimones britteni—Araneida)*, 180  
*Perineus*, 82  
*Periplaneta americana* L., 27  
*Petrobius*, 163, 164, 166, 167, 173, 180  
*Petrobius brevistylis* Carpenter, 155, 156, 164, 167, 173, 174  
*Petrobius lohmanderi* Agrell, 156, 173  
*Petrobius maritimus* (Leach), 156, 164, 167, 173, 176  
*(Phaeton—Aves)*, 82  
**(PHAETHONTIDAE-Aves)**, 82  
*(Phaetusa—Aves)*, 83  
**(PHALACROCORACIDAE-Aves)**, 83  
*(Phalacrocorax—Aves)*, 83  
**(PHALAROPODIDAE-Aves)**, 83  
*(Phalaropus—Aves)*, 82  
*Phaleria*, 145, 499, 508, 510, 514, 516, 542  
**PHAULODINYCHIDAE**, 133, 134  
*Phaulodinychus minor* (Halbert), 133  
*Phaulodinychus mitis* (Leonardi), 134  
*Phaulodinychus or chestiidarum* (Barrois), 133  
**PHILANISIDAE**, 291–301  
*Philanisis*, 3, 292, 295, 296, 299, 300  
*Philanisis plebeius* Walker, 292–295, 297, 298, 300, 301  
*Philoceanus*, 82  
*Philonthus*, 523, 540, 541  
*Philonthus nudus* Sharp, 541, 545  
*Philygria*, 472, 477  
*(Phoca 'itulina—Mammalia)*, 81, 94  
*(Phocarctos hookeri—Mammalia)*, 81  
**(PHOCIDAE-Mammalia)**, 81  
*(Phoebetria—Aves)*, 82  
**PHORIDAE**, 98, 101, 102  
*Phycobius*, 523, 540, 541  
*Phycocoetus*, 542  
*Phycodroma*, 450  
*Phyconomus*, 499, 508, 510, 514, 542  
*Phyllotreta*, 115  
*Phyllotreta nemorum* (L.), 115  
*(Physalia—Siphonophora)*, 208  
*Phytometra biloba* Steph., 105, 106  
*Phytonomus*, 115  
*Phytosus*, 522, 531, 532  
*Phytosus balticus* Kraatz, 525  
*Piagetiella*, 81, 83  
**(PINNIPEDIA-Mammalia)**, 81  
*(Pinnularia—Algae)*, 484  
*Pirata*, 145  
*Pirates hybridus* (Scopoli), 114  
*(Plantago maritima—Angiospermae)*, 27  
*(Platurus—Reptilia)*, 135  
*Plutella maculipennis* Curtis, 105, 106  
*Plutella xylostella* (L.), 105, 106  
*Polypea*, 529  
*Polytrichophora*, 475, 478  
*Polytrichophora agens* Cresson, 475  
*Polytrichophora conciliata* Cresson, 475  
**POLYXENIDAE**, 123, 124  
*Polyxenus* sp., 120  
*Polyxenus lapidicola* Silvestri, 124  
*Pontamalota*, 523, 533, 534, 541, 542  
*Pontamalota californica* Casey, 534, 545  
*Pontamalota luctuosa* Casey, 745  
*Pontamalota opaca* LeConte, 531, 545  
*Pontarachna halei* Womersley, 134  
**PONTARACHNIDAE**, 134  
*Pontomyia*, 1, 378, 380, 381, 388, 393–397, 399, 402, 407, 411  
*Pontomyia cottoni* Womersley, 378, 381, 407  
*Pontomyia natans* Edwards, 378, 407, 410, 411

- Pontomyia oceana* Tokunaga, 378  
*Pontomyia pacifica* Tokunaga, 378, 399, 410  
*Pontoppidania littoralis* (Halbert), 129  
*(Populus nigra—Angiospermae)*, 31  
*(Porphyra—Algae)*, 409  
*Porphyrops*, 67  
*(Porpita—Siphonophora)*, 208  
*(Potamogeton—Angiospermae)*, 488  
*Procanace*, 70, 471  
*Procanace nigroviridis* Cresson, 471  
*(Procellaria—Aves)*, 82  
**(PROCELLARIIDAE—Aves)**, 82  
**(PROCELLARIIFORMES-Aves)**, 82  
*(Procelsterna—Aves)*, 83  
*(Procelsterna cerulea—Aves)*, 209  
**PROCTOTRUPIDAE**, 101  
*Proechinophthirius*, 85  
*Proechinophthirius fluctus* (Ferris), 81, 87, 88, 92  
*Proechinophthirius zumpti* Werneck, 81  
*Proistoma*, 157  
*Proistoma crassicauda* (Tullbg.), 156, 173  
*Proistoma minuta* (Tullbg.), 173  
*Proistoma schoetti* (Dalla Torre), 156, 173  
*Prokelisia marginata* Van Duzee (= *Megmelus marginatus*), 24, 25, 28  
**PROTEININAE**, 522, 523, 538  
*Proteinus*, 522, 538  
*Proteinus brachypterus* (Fabriceus), 526  
*Psamathobledius*, 522, 537, 538  
*Psammathiomyia*, 379, 386, 388, 406, 410, 411  
*Psammathiomyia pectinata* Deby, 379, 386  
*Pselaphochernes littoralis* Beier, 127  
**PSEPHENIDAE**, 71, 500, 511  
*Psephenoides*, 511  
*Pseudanurida*, 156, 157, 162, 174  
*Pseudanurida sawayana* Schuster, 171  
*Pseudohecamede*, 475, 478  
*Pseudohecamede abdominalis* (Williston), 475  
*Pseudohecamede facialis* Handel, 475  
*Pseudonirmus*, 82  
*Pseudosaldula*, 228, 235, 236, 241, 243, 255  
*Pseudosaldula bergi* (Haglund), 236  
*Pseudosaldula cobbeni* China, 235  
*Pseudosaldula paralia* (Torres), 235, 236  
*Psilopa*, 475, 478, 485  
*Psilopa flavida* Coquillett, 475  
**PSILOPINAE**, 469, 472, 485, 492  
*Psorophora* Robineau-Desvoidy, 305  
**PSYCHODIDAE**, 52, 98, 99, 114  
**PSYLLIDAE**, 98, 100, 102  
*(Pterodroma—Aves)*, 82  
*(Pterodroma alba—Aves)*, 209  
**PTEROMALIDAE**, 25, 32, 101, 114, 486  
**PTEROPHORIDAE**, 101  
**PTILIIDAE**, 509  
*Ptilomyia*, 466, 475, 477, 478  
*Ptilomyia mabelae* (Cresson), 475  
*(Ptychoramphus—Aves)*, 83  
*(Puccinellia maritima—Angiospermae)*, 172  
*(Puffinus—Aves)*, 82  
*(Pusa hispida—Mammalia)*, 81  
*(Pusa sibirica—Mammalia)*, 81  
*(Pygoscelis—Aves)*, 82  
**PYRALIDAE**, 101  
**PYROMORPHIDAE**, 101  
*Pyrrhocoris apterus* (L.), 114  
*Quadriceps*, 83  
**QUEDIINAE**, 522, 523, 539  
**RHAPHINAE**, 67  
**RHAGADOTARSINAE**, 188, 190, 193  
**RHAGOVELIINAE**, 188, 189, 213  
*Rhagovelia*, 194, 199  
*Rheumatobates*, 188, 190, 192, 199, 208, 214, 216, 218, 219  
*Rheumatobates aestuarius* Polhemus, 192, 214, 219  
*Rheumatobates clanis* Drake and Harris, 214, 219  
*Rheumatobates mangrovensis* China, 219  
*Rheumatobates ornatus* Polhemus & Cheng, 219  
*Rheumatobates prostatus* Polhemus, 219  
*Rheumatobates trinitatus* China, 219  
*Rheumatobates vegatus* Drake and Harris, 214, 219  
*Rheumatometroides*, 190, 192, 199  
*(Rhipidura fuliginosa placabilis—Aves)*, 298  
**RHIZOPHAGIDAE**, 499  
**RHODACARIDAE**, 134  
*Rhodnius prolixus* Stål., 23  
*(Rhodostethia—Aves)*, 83  
**RHOMBOGNATHINAE**, 132  
*Rhombognathus*, 132  
*(Rissa—Aves)*, 83  
*Rissoa*, 509  
*(Ruppia—Angiospermae)*, 17  
**(RYNCHOPIDAE-Aves)**, 83  
*(Rynchops—Aves)*, 83

- Saemundssonina*, 82, 83  
*Salda*, 228, 236–238, 241, 243, 250  
*Salda buenoi* McDunnough, 236, 250  
*Salda coloradensis* Polhemus, 237  
*Salda littoralis* (Linnaeus), 236, 237, 246, 247, 250, 255  
*Salda pallipes* = *Saldula pallipes* (Fabricius)  
*Salda palustris* (Douglas) = *Saldula palustris* (Douglas)  
**SALDIDAE**, 45, 48, 49, 74, 76, 225–256  
**SALDINAE**, 236–238, 241, 245, 247, 253, 255  
*Saldoida*, 238, 239  
*Saldoida slossoni* Osborn, 239  
*Saldonia*, 228, 241, 246  
**SALDONIIDAE**, 228, 241  
*Saldula*, 228, 231, 234–237, 241, 243, 247, 251, 252  
*Saldula comatula* Parshley, 252  
*Saldula luctuosa* (Stal), 252  
*Saldula notalis* Drake, 252  
*Saldula opacula* (Zetterstedt), 255  
*Saldula pallipes* (Fabricius), 230, 250, 252, 255  
*Saldula palustris* (Douglas), 12, 248–250, 252, 255  
*Saldula pexa* Drake, 236  
*Saldula pilosella* (Thompson), 250  
*Saldula saltaoria* (Linnaeus), 25, 248–250, 255  
*Saldula setulosa* (Puton), 250  
*Saldula (Macrosaldula) variabilis* (Herrich-Schaeffer), 234, 247  
*Saldula villosa* (Hodgden), 227, 252  
*Salduncula*, 228, 237, 238, 243, 245, 251  
*Salduncula decempunctata* Miyamoto, 238, 254  
*Salduncula seycellensis* Brown, 238, 254  
*Salduncula swezeyi* (Usinger), 238, 254  
*Salduncula woodwardi* Drake, 238, 254  
(*Salicornia*—Angiospermae), 32, 251, 542  
**SALPINGIDAE**, 499, 506, 515, 516  
**SALTICIDAE**, 137, 139, 146, 147  
(*Sarothamnus scoparius*—Angiospermae), 32  
*Sartallus*, 522, 537  
*Sartallus signalis* Sharp, 538  
**SCARABAEIDAE**, 101  
*Scatella*, 473, 476, 479, 482, 483, 485, 492  
*Scatella bryani* Cresson, 487, 488  
*Scatella favillacea* Loew, 473  
*Scatella oahuense* Williams, 468, 470  
*Scatella obscura* Williston, 473  
*Scatella obsoleta* Loew, 473  
*Scatella paludum* (Meigen), 474  
*Scatella picea* (Walker), 474  
*Scatella stagnalis* (Fallén), 474  
**SCATELLINI**, 473  
**SCATOPHAGIDAE**, 115  
*Scatophila*, 474, 476, 479  
*Scatophila mesogramma* (Loew), 474  
**SCATOPSIDAE**, 101, 102  
**SCELIONIDAE**, 48, 101, 430  
*Scepsis*, 423  
*Schendylurus virgingordae* Crabill, 122  
*Schistocerca*, 110  
*Schistocerca exigua*, 107  
*Schistocerca gregaria* (Forskål), 106–109  
*Schistocerca paranensis* (Burmeister), 108, 109  
*Schizocosa avida* (Walckener), 145  
**SCIARIDAE**, 102  
(*Scirpus*—Angiospermae), 488  
*Scolioplanes*, 122  
**SCOLYTIDAE**, 101  
*Scoparia tetracycla* Meyr, 13  
**(SCORPIONIDAE—Arthropoda)**, 104, 124  
(*Sepia*—Cephalopoda), 202  
**SEPSIDAE**, 115  
*Serianus litoralis* (Chamberlin), 129  
*Serianus serianus* Chamberlin, 129  
*Serromyia*, 336  
(*Sesarma sulcatum*—Crustacea), 349  
*Sialis*, 59  
*Sialis lutaria* (L.), 78  
*Sigara*, 267, 272, 277, 278, 282  
*Sigara assimilis* (Fieber), 267  
*Sigara australis* (Fieber), 267, 277, 281  
*Sigara concinna* (Fieber), 267, 281  
*Sigara conocephala* Hungerford, 267  
*Sigara decoratella* Hungerford, 267  
*Sigara distincta* (Fieber), 279, 281  
*Sigara dorsalis* (Leach), 267, 281  
*Sigara falleni* (Fieber), 267, 275, 281  
*Sigara fossarum* (Leach), 281  
*Sigara gebleri* (Fieber), 267  
*Sigara jeistanensis* Distant, 267  
*Sigara lateralis* (Leach), 267, 274, 281  
*Sigara lateralis kilimandjaronis* (Kirkaldy), 267  
*Sigara lateralis lateralis* (Leach), 267

- Sigara lugubris* Fieber, 23  
*Sigara mayri* (Fieber), 267  
*Sigara meridionalis* (Wallengren), 267, 272  
*Sigara samani* Hoberlandt, 267  
*Sigara selecta* (Fieber), 267, 281  
*Sigara semistriata* (Fieber), 281  
*Sigara siberica* Jaczewski, 267  
*Sigara stagnalis* (Leach) (= *lugubris* (Fieber)) 22, 267, 277, 281  
*Sigara striata* (Linnaeus), 267, 274, 279, 281  
*Sigara substriata* Distant, 267  
*Sigara venusta* (Douglas and Scott), 267  
*Sigara weymarni* Hungerford, 267  
*Silvius*, 423  
**SIMOGNATHINAE**, 132  
**SIMULIIDAE**, 52, 54, 59–62  
*Sinella curviseta* Brook, 164  
*Sitona*, 115  
*Sogatella furcifera* (Horv.), 195  
*Solenopsis*, 115  
(*Sorex ornatus*—Mammalia), 32  
*Smittia reinga* (Leader), 412  
*Smittia whangaroa* (Leader), 412  
*Spaniotoma nemalione* Tokunaga, 378, 382  
(*Spartina*—Angiospermae), 9, 28, 29, 32, 34, 143, 362, 433  
(*Spartina alterniflora*—Angiospermae), 6, 28, 348, 362, 426, 427, 429, 432  
(*Spartina cynosuroides*—Angiospermae), 432  
(*Spartina patens*—Angiospermae), 428, 432  
*Speovelia*, 188, 180, 196, 211, 218  
*Speovelia maritima* Esaki, 196, 216  
*Speovelia mexicana* Polhemus, 196, 216  
**SPHAEROCERIDAE**, 76, 101, 102  
(*Sphaeroma*—Isopoda), 121  
**SPHECIDAE**, 430  
(**SPHENISCIDAE**—Aves), 82  
(**PHENISCIFORMES**—Aves), 82  
(*Spheniscus*—Aves), 82  
**SPHINGIDAE**, 101  
(*Spirula*—Cephalopoda), 202  
*Spodoptera exigua* (Hb.), 105, 106  
**STAPHILININAE**, 523, 540, 541  
**STAPHYLINIDAE**, 45, 48, 76, 101, 104,  
*Staticobium limonii* Contarini, 12, 24  
(*Steganopus*—Aves), 83  
*Stenobates*, 188, 190, 192, 199  
*Stenotabanus*, 423  
*Stenus*, 180  
**(STERCORARIIDAE—Aves)**, 83  
(*Stercorarius*—Aves), 83  
**(STERNIDAE—Aves)**, 83  
*Stictopleurus*, 114  
(*Stigmatomyces*—Fungi), 487  
*Strigamia maritima* (Leach), 120–122  
(*Sula*—Aves), 83  
**(SULIDAE—Aves)**, 83  
*Swainsia*, 139  
*Symphyella essigi* Michelbacher, 122  
(*Synthliboramphus*—Aves), 83  
*Syntormon pallipes* (F.), 67  
**SYRPHIDAE**, 98  
*Syrphus*, 115  
*Syrphus corollae* F., 115  
*Syrphus ochrostoma* (Zett.), 115  
**TABANIDAE**, 45, 415–436, 486  
**TABANINAE**, 420, 422, 423  
*Tabanus*, 415, 418–421, 423, 434  
*Tabanus lineola* Fabricius, 423, 424, 426, 428–430, 432, 433, 486  
*Tabanus nigrovittatus* Macquart, 416, 417, 423, 424, 426, 427, 429, 430, 432, 433, 435  
*Tabanus quinquevittatus* Wiedemann, 424, 433  
*Tachys*, 498, 542  
*Tachyusa*, 523, 533  
*Tachyusa pumila* Sharp, 534  
*Tanytarsus*, 378, 380, 381, 388, 394–396, 402, 405, 410, 411  
*Tanytarsus boodleae* Tokunaga, 378  
*Tanytarsus halophilae* Edwards, 378  
*Tanytarsus magnihamatus* Tokunaga, 378  
*Tanytarsus maritimus* Edwards, 378  
*Tanytarsus pelagicus* Tokunaga, 378  
*Taphoxemus*, 115  
*Tarphiota*, 523, 533–535, 541, 542  
*Tarphiota geniculata* Mäklin, 535, 545  
*Tarphoita pallidipes* Casey, 535, 545  
*Telenomus*, 430  
*Telenomus emersoni* (Girault), 430  
*Telenomus tabanivorus* (Ashmead), 430  
(*Telmatobia peruvianus*—Amphibia), 487  
*Telmatogeton*, 71, 379, 386, 388, 394, 399, 402, 405, 410, 411, 412  
*Telmatogeton atlanticum* Oliveira, 379  
*Telmatogeton australicus* Womersley, 379, 387  
*Telmatogeton japonicus* Tokunaga, 379, 383, 395, 399, 401, 402, 405, 409, 411, 412

- Telmatogeton latipennis* Wirth, 379  
*Telmatogeton macswaini* Wirth, 379  
*Telmatogeton minor* Kieffer, 379, 409  
*Telmatogeton mortoni* (Leader), 412  
*Telmatogeton nanum* Oliviera, 379  
*Telmatogeton pacificus* Tokunaga, 379, 409, 412  
*Telmatogeton pusillum* Edwards, 379  
*Telmatogeton sancti-pauli* Schiner, 379, 395, 400, 409  
*Telmatogeton simplicipes* Edwards, 379  
*Telmatogeton torrenticola* (Terry), 412  
*Telmatogeton trochanteratum* Edwards, 379  
 (Telohania tabani—Protozoa), 430  
*Temnostega*, 498, 507, 515  
*Tenebrio molitor* L., 50  
**TENEBRIONIDAE**, 101, 499, 502  
*Teneriffia marina* (Hirst), 134  
*Teneriffia quadripapillata* Thor, 135  
**TENERIFFIIDAE**, 134, 135  
**TEPHRITIDAE**, 102  
*Tethina spinulosa* Cole, 129  
*Tethymyia*, 379, 384, 388, 406, 411  
*Tethymyia aptena* Wirth, 379, 384, 400  
 (Tetraclita—Crustacea), 140  
 (Tetraclita squamosa—Crustacea), 131, 144  
*Tetramorium*, 115  
**TETTIGELLIDAE**, 100  
*Thalassarachna raphidochela* Krantz, 133  
*Thalassiobates littoralis* (Silvestri), 124  
*Thalassobius*, 498, 507, 515  
*Thalassodualius*, 498, 507, 515  
 (Thalassoica—Aves), 82  
*Thalassomyia*, 378, 379, 386, 388, 399, 405, 406, 410, 411  
*Thalassomyia africana* Edwards, 378  
*Thalassomyia bureni* Wirth, 379  
*Thalassomyia frauenfeldi* Schiner, 378  
*Thalassomyia japonica* Tokunaga, 378, 386, 400  
*Thalassomyia longipes* Johnson, 378  
*Thalassomyia maritima* Wirth, 379  
*Thalassomyia pilipes* Edwards, 378  
*Thalassomyia sabroskyi* Tokunaga, 378  
*Thalassomyia setosipennis* Wirth, 378  
*Thalassopauropus remyi* Bagnall, 123  
*Thalassosmittia*, 378, 382, 388, 396, 405, 410  
*Thalassosmittia* (*Camptocladus*) *clavicornis* Saunders, 378, 382  
*Thalassosmittia* (*Camptocladus*) *marinus* Saunders, 378, 382  
*Thalassosmittia* (*Camptocladus*) *pacifus* Saunders, 378  
*Thalassosmittia* (*Camptocladus*) *thalassophilus* Goetghebuer, 378, 382  
*Thalassotrechus*, 498, 507, 514, 515, 542  
*Thalassotrechus barbarae barbarae* Horn, 544  
*Thalassotrechus nigripennis* Van Dyke, 544  
*Thaumatomyia*, 31  
 (Thelohania—Microsporidia), 314  
*Thinobius*, 522, 537, 542  
*Thinocafius*, 523, 540  
*Thinopinus*, 514, 523, 534, 539–542  
*Thinopus pictus* Leconte, 527, 531, 540, 543, 545  
*Thinopus pictus variegatus* Motschulsky, 545  
*Thinoseius*, 130–132  
*Thinoseius brevisternalis* (Canaris), 132  
*Thinoseius fucicola* (Halbert), 130, 455  
*Thinoseius ramsayi* Evans, 130  
*Thinoseius spinosus* (Willmann), 130  
*Thinusa*, 522, 531, 532, 534, 541, 542  
*Thinusa fletcheri* Casey, 531, 545  
*Thinusa maritima* Casey, 531, 545  
*Thoracochaeta zosterae* Haliday, 448, 450  
*Throscinus*, 499, 508, 510, 542  
*Thrypticus*, 67  
**THYSANURA**, 151–180  
**TINEIDAE**, 101  
**TINGIDAE**, 100  
**TIPULIDAE**, 45, 49, 53, 54, 60, 61, 63–68, 71, 76, 102, 500  
*Tixococoba*, 146  
*Tomocerus*, 164  
**TORTRICIDAE**, 101  
*Trabeculus*, 82  
*Trepobates*, 214  
**TREPOBATINAE**, 188, 190  
*Trichocorixa*, 267, 272, 277, 278, 281, 282  
*Trichocorixa beebei* Sailer, 267, 278, 281  
*Trichocorixa borealis* Sailer, 267  
*Trichocorixa louisianae* Jaczewski, 267  
*Trichocorixa naias* Sailer, 267  
*Trichocorixa reticulata* (Guérin-Méneville), 268, 273, 278–281  
*Trichocorixa verticalis* Fieber, 264, 278, 280, 281  
*Trichocorixa verticalis californica* Sailer, 268, 279

- Trichocorixa verticalis interiores* Sailer, 268, 272–274, 277, 281, 282  
*Trichocorixa verticalis saltoni* Sailer, 268  
*Trichocorixa verticalis verticalis* (Fieber), 268  
*Trichocorixa verticalis verticalis* var. *sellaris* (Abbott), 268  
*Trichogramma*, 430  
*Trichogramma minutum* Riley, 430  
*Trichogramma semblidis* (Aurivillius), 430  
**TRICHOGRAMMATIDAE**, 430  
*Trichopria tabanivora* Fouts, 430  
*Trichocladus*, 382  
*Trimerina madizans* (Fallén), 485  
*Triplectides obsoleta* McLachlan, 299  
*Trochopus*, 188, 189, 194–196, 199, 201, 202, 213, 216, 218  
*Trochopus plumbea* (Uhler), 194, 216  
**TROMBICULIDAE**, 135  
*Tropisternis salsamentus* Fall, 500  
*Tropisternis*, 542  
(*Tubicola*—Polychaeta), 144  
*Tullbergia krausbaueri* (Börn.), 179  
*Tullbergia quadrispina* (Börn.), 173  
*Tuoba* (*Nesogeophilus*), 122  
(*Typha*—Angiospermae), 488  
*Typopsilopa*, 476  
  
(*Uca subcylindrica* (Stimpson)—Crustacea), 307  
(*Ulva*—Algae), 409  
*Uranotaenia lateralis* Ludlow, 318  
*Uranotaenia Lynch* Arribalzaga, 305  
(*Uria*—Aves), 83  
*Uroleptis rufipes* (Ashmead), 486  
**UROPODIDAE**, 133, 134  
  
*Vanessa cardui* L., 106–108, 110, 111  
*Vanessa braziliensis* (Moore), 106, 111  
*Vanessa virginiensis* Drury, 111  
*Vatacarus*, 134  
**VEIGAIIDAE**, 136  
*Veigeia* (*Veigaia*), 136  
*Vejovis*, 124, 125  
(*Verella*—Siphonophora), 208  
**VELIIDAE**, 188, 189, 193–196, 199, 202, 214  
  
**XANTHOLININAE**, 523, 539  
**XANTHOPYGINAE**, 523, 540  
(*Xema*—Aves), 83  
  
*Xenobates*, 188, 189, 194, 199, 216  
*Xenopium oceanicum palauense* (Beier), 129  
*Xenylla*, 157  
*Xenylla humicola* (Fabr.), 155, 173  
*Xenylla maritima* Tullbg., 155  
**XIPHOSURA**, 16  
  
(*Zalophus californianus*—Mammalia), 81  
*Zelotes monachus* Chamberlin, 138, 145  
**ZODARIIDAE**, 137  
(*Zostera*—Angiospermae), 7, 17, 510  
(*Zygiella*—Araneida), 180