

U. S. NAVAL OCEANOGRAPHIC OFFICE
(1963)

AD 426 972

ARCTIC ICE

By N. N. ZUBOV

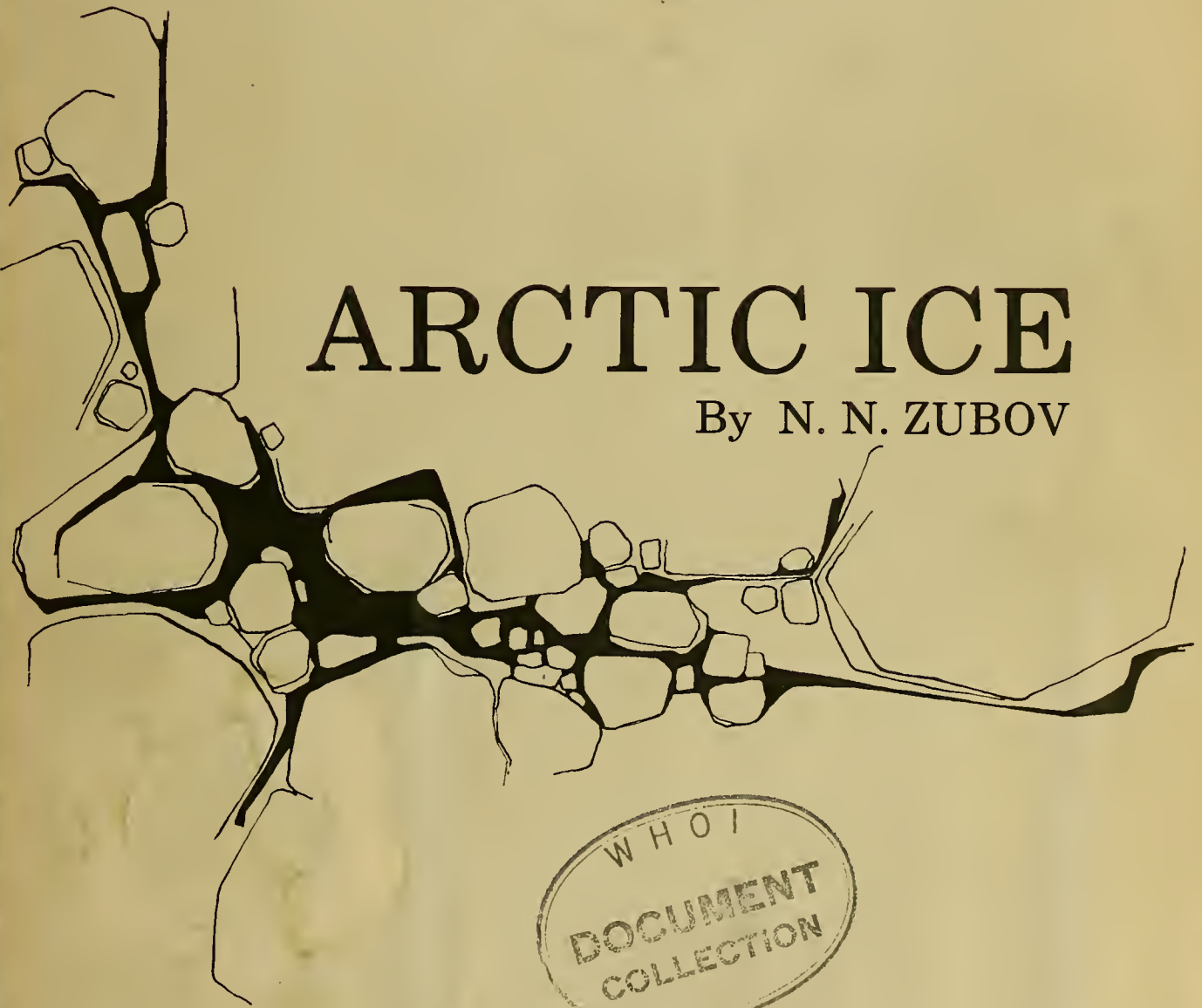

H 23.50

rskie vody i l'dy

Office

	RETURNED
✓	16. 6. 1964
	25 Mar 69
59	9/9/70
57	30 Aug 72

PUBLISHER'S STATEMENT

Reference texts devoted entirely to the concepts of arctic ice and arctic oceanography have not previously been available in English. While the bibliography of technical papers covering many specific properties of sea ice and the oceanography of the Arctic Ocean has expanded considerably in the past few years, N. N. Zubov's classical reference, "Arctic Ice," still holds much historical interest and provides general information of significant value to the beginning investigator.

During the past ten to twelve years portions of this text have been translated and abstracted at the request of various investigators reviewing the literature and the status of arctic problems. Because of the increasing interest and number of requests for translated portions of the book a cooperative project was established to provide a complete bound translation. The present translation was accomplished by the U. S. Navy Oceanographic Office and the American Meteorological Society under contract to the U. S. Air Force Cambridge Research Center. Final technical editing and publishing was by the U. S. Navy Electronics Laboratory.

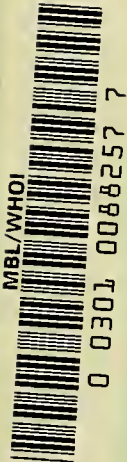

(1963)

TABLE OF CONTENTS

	Page
AUTHOR'S PREFACE	1
INTRODUCTION	3
CHAPTER I SOME PROPERTIES OF SEA WATER	7
1. The Concept of Water Structure	7
2. The Composition of Sea Water	8
3. Salinity	9
4. Specific Gravity, Density and Specific Volume	10
5. The Temperature of Maximum Density and the Freezing Point	12
6. Increase in Density During Mixing	14
7. The Properties of Sea Water of High Salinity	16
8. Thermal Capacity, Heat of Fusion and Heat of Vaporization	18
9. Vapor Pressure	18
10. Reflection and Refraction of Solar Energy	19
11. Absorption and Scattering of Solar Energy	20
CHAPTER II CHANGES IN TEMPERATURE AND SALINITY OF THE OCEAN	23
12. The Processes that Change Temperature and Salinity of the Ocean	23
13. Solar Radiation	25
14. Reradiation	31
15. Evaporation and Condensation	32
16. Evaporation of Snow	34
17. The Effect of Evaporation and Condensation on Sea Temperature	35
18. Convection	38
19. Effect of the Sea on the Air Temperature	38
20. The Effect of Atmosphere on Sea Temperature	42
21. The Effect of Ice on the Atmosphere	45
22. The Cooling of the Sea	48
23. Precipitation	51
24. Coastal Precipitation	52
25. A Concept on the Heat Balance	55
26. The Concept of the Water Balance	60
CHAPTER III THE MIXING OF OCEAN WATERS	65
27. The Concept of Mixing	65
28. Frictional Mixing	67
29. Convective Mixing	70
30. Vertical Winter Circulation	73
31. The Index of Freezing	78
32. Features of Vertical Winter Circulation in the Shallows	79
33. The Cold Intermediate Layer	80
34. The Discontinuity Layer	83
35. The Distance Transfer of Temperature Anomalies of the Ocean	84

TABLE OF CONTENTS (Continued)

	Page
CHAPTER IV ICE FORMATION AND ICE TYPES IN THE SEA	89
36. The Concept of Ice Formation	89
37. Ice Formation in Fresh Waters	90
38. Peculiarities of Ice Formation in the Sea	93
39. Ice Formation at Positive Air Temperatures	94
40. The Basic Varieties of Ice in the Sea	95
41. Initial Forms of Surface Ice	96
42. Deep Ice	100
43. Ice Under Ice	103
44. Bottom Ice	105
45. The Classification of Ice According to Origin	106
46. Classification of Ice According to Size and Form	108
47. Fast Ice	112
48. Floating Ice	115
49. Pack Ice	118
50. Glacier Ice	120
51. Icebergs	124
52. Icebergs in the Soviet Arctic Seas	131
53. Icecap Islands	133
54. Fossil Ice	136
CHAPTER V PHYSICAL AND CHEMICAL PROPERTIES OF SEA ICE	139
55. Salinity	139
56. Surface Brine and Salt Cell Brine	141
57. The Amount of Brine in Sea Ice	143
58. Brine Migration	145
59. Composition of the Salts	148
60. Specific Heat	150
61. Heat Expended in Melting	153
62. The Coexistence of Water and Ice	154
63. Thermal Expansion	158
64. Thermal Conductivity	160
65. Density as a Function of Temperature and Salinity	162
66. Density as a Function of Porosity	165
67. Buoyancy	169
68. Density of Snow	173
69. Radiation Properties	175
70. Illumination of the Sea Under the Ice	177
71. Color	180
72. Hardness	181
73. The Liquid State	182
74. Mechanical Properties	183
75. Elastic Properties	185
76. The Influence of Temperature and Continuous Pressure	186
77. The Plastic Limit	188
78. The Effect of Thickness, Temperature and Salinity on Flexural Strength	191
79. Flexure of Ice Under Load	193

TABLE OF CONTENTS (Continued)

		Page
80.	External Friction	200
81.	Fatigue	202
CHAPTER VI ICE ACCRETION		203
82.	The Centers of Freezing	203
83.	Ice Thickness as a Function of Air Temperature	204
84.	Ice Accretion as a Function of the Vertical Distribution of Temperature and Salinity Beneath the Ice	214
85.	Effect of a Snow Cover on the Rate of Ice Accretion	220
86.	Ice Accretion in the Region of Ice Removal	223
87.	Maximum Thickness of Perennial Ice	225
88.	Temperature of Sea Ice	232
89.	The Lag of the Temperature Minimum in the Lower Levels of Sea Ice	236
90.	Ice Accretion Due to Low Ice Temperatures	238
CHAPTER VII DEFORMATION OF ICE		241
91.	The Deformation of an Ice Cover	241
92.	Thermal Fissures	242
93.	Wind Pressure on Ice Fields	245
94.	Break-up of Ice Fields	247
95.	Rotation of Ice and Its Break-up	249
96.	Break-up of Fast Ice	253
97.	Theoretical Concept of Ice Heaping	254
98.	The Aspects of Ice Jamming	260
99.	Littoral Ice Hummocks	264
100.	Stamukhi.	267
101.	Hummock Structure	268
102.	Snow Cover on Ice	274
103.	Isostatic Phenomena	276
104.	Average Ice Thickness	282
105.	Decrease in the Area of Ice with Hummocking	285
106.	The Increase in the Power of the Ice Cover as a Result of Drift and Ice Hummocking	289
107.	The Influence of Hummocking of Ice	293
CHAPTER VIII MELTING OF SEA ICE		295
108.	Phases of Weakening and Destruction of Sea Ice	295
109.	Initial Phase of Weakening of Ice	298
110.	Snow Puddles and Lakes on Top of Ice	300
111.	Circulation of Water Caused by Ice	303
112.	Second Phase of Weakening of Ice	304
113.	Influence of Micro-Organisms and Inorganic Inclusions on Destruction of Sea Ice	305
114.	Breaking of Ice During Melting	308
115.	Radiation and Thermal Effect of Air on the Ice	311
116.	Melting of Ice from the Top	314
117.	Melting of Ice Due to Thermal Action of Water	316
118.	Centers of Break-up and Melting.	319

TABLE OF CONTENTS (Continued)

	Page
CHAPTER IX TIDAL PHENOMENA AND ICE	325
119. Certain Peculiarities of the Tides	325
120. Influence of Ice on Tidal Phenomena	328
121. Influence of Tides on Freezing and Break-up of Sea	330
122. Tidal Cracks (Treshchiny)	331
123. Tidal Variations in Level and Stamukhi	335
124. Tidal Movements of Sea Ice	336
125. Pressing Together and Thinning out of Ice Due to Tides	338
126. The Concept of Ice Time	340
127. Significance of Tidal Phenomena in Navigation in Ice	342
128. Tidal Ice Maps	344
CHAPTER X SEA CURRENTS AND ICE	347
129. Certain Peculiarities of Sea Currents	347
130. Movement of Ice in Sea Currents	349
131. Currents and Fast Ice	352
CHAPTER XI WIND AND THE DRIFT OF ICE	355
132. The Wind Drift of Ice	355
133. The Drift of Close Ice Fields	356
134. The Combined Influence of Winds and Currents	366
135. Drift Along the Isobars	368
136. The Rate of Drift Along the Isobars	372
137. Comparison of the Computed and Observed Drifts	373
138. The Drift of Ice During the Passage of Pressure Systems	377
139. The Drift of an Isolated Ice Floe	381
140. The Drift of Scattered Ice	386
141. Wind Strips of Ice	389
142. Compressive and Dispersive Winds	390
143. Wind Leads and Polynas	393
CHAPTER XII CIRCULATION OF WATER AND ICE OF THE ARCTIC BASIN	399
144. Certain Information Concerning the Balance of Water and Ice	399
145. Coastal Siberian Waters	403
146. Arctic Surface Water	406
147. Atlantic Water	410
148. Deep Water	416
149. Drift of Vessels and Buoys	418
150. Atmospheric Pressure Over the Arctic Basin	425
151. Atmospheric Turbulence	430
152. Variation in Ice Circulation from Year to Year	435
153. Ice Circulation in the White Sea	437
CHAPTER XIII SEASONAL AND LONG-TERM FLUCTUATIONS OF ICE	
ABUNDANCE	445
154. Ice Abundance	445
155. Seasonal Fluctuations	448
156. Long Term Fluctuations	457

TABLE OF CONTENTS (Continued)

	Page
157. Certain Factors which Determine the Ice Abundance of the Arctic Ocean	459
158. Astronomical Factors	459
159. Geological Factors	461
160. Climatic Factors	462
161. Synoptic and Oceanological Factors	464
162. Warming of the Arctic	470
CONCLUSION	477
BIBLIOGRAPHY	479

AUTHOR'S PREFACE

This book is respectfully dedicated to the men of the Russian Navy who have studied the Arctic lovingly and conscientiously, who have written of what they have observed and who have not written of what they have not observed.

Arctic Ice is written according to approximately the same plan as my book *Sea Water and Ice*,* published in 1938.

The first part of the book gives general information on the physical-chemical properties of sea water, the processes which change the temperature and the salinity of the ocean, the processes which form the water masses, and the interaction of ocean and atmosphere. The first part of *Arctic Ice* is considerably abridged as compared with the first part of *Sea Water and Ice*, but at the same time it is supplemented with new data. Almost all examples are taken in reference to the Arctic Basin.

The second part of this book, devoted to ice, has been re-edited and supplemented by recent works, my own and those of other authors, particularly observations and investigations made during the winter of 1941-1942 on the White Sea.

Thus, this book cannot be called a second edition of *Sea Water and Ice*, nor can it be called a textbook, a scientific handbook or a monograph. It presents my personal opinions, which in a number of cases still require verification and refinement. In this book I have attempted to treat a great number of the problems I have encountered, without pretending to offer a final solution. In attempting to make this book accessible to the greatest possible number of people assigned to the Arctic, to aviators, sailors and researchers, I have presented all problems as simply and comprehensively as possible.

I realize that in writing a book on arctic ice, I have undertaken a difficult and responsible task. I have not succeeded in this task as I would have liked, but I hope that even in its imperfect state, this book will prove of some value in the further assimilation of the Arctic.

I have tried to make the most possible use of existing literature and fear that I might have ascribed to myself work done by others or have belittled the importance of their work. If I have made involuntary errors in this respect, I sincerely beg forgiveness.

I wish to express my indebtedness to A. D. Dobrovolskii, L. A. Zenkevich, S. Ia. Mittel'man and M. M. Somov for reviewing this book and for their valuable suggestions.

*Morskoe vody i l'dy - Translator.

I also wish to express my indebtedness to Rear Admiral I. D. Papanin and to V. D. Novikov, who by their care and attention have aided in the completion and publication of this book.

Moscow. May, 1943.

N. N. Zubov, Naval Captain,
Professor, Doctor of
Geographical Sciences

INTRODUCTION

"World Ocean" is the name given the sea waters that cover the earth's surface in a continuous sheet. The World Ocean is divided into four parts: the Pacific, Indian, Atlantic and Arctic Oceans. Everling and I drew the boundaries between these oceans on the basis of least depths. Of course, such a delineation is more or less arbitrary, but we consider that the depth of the divides, i. e. the depth of the submarine elevations and ranges which separate the parts of the ocean, is the best index of the independence of their hydrologic regime.

Following this concept, the sea boundaries between the Arctic and Atlantic Oceans are:

(1) the straits between North America and Greenland (between Boothia Peninsula and Greenland at 82° north);

(2) the straits between Greenland, Iceland and Scandinavia.

The sea boundary between the Arctic and Pacific Oceans is the submarine ridge lying somewhat to the north of Bering Strait.

At present, because of insufficient information, it is impossible to calculate the area cross sections of the straits joining the Arctic and Atlantic Oceans through Baffin Bay. The total area cross section of all the straits between Greenland and the Scandinavian peninsula is about 370 square km. The area cross section of Bering Strait is only about 2.5 square km. Thus, the Arctic Ocean communicates much more freely with the Atlantic Ocean than with the Pacific. It is also very significant that the maximum water depth above the sill at Bering Strait is no more than 40 m, while it is about 440 m above the sill between Greenland and Scandinavia.

On examining the bathymetric charts of the World Ocean, it is easy to see that the submarine ranges and elevations divide the individual oceans into a number of ocean basins. Each of these basins includes the seas and gulfs adjacent to it. Accordingly, we have divided the Arctic Ocean into two ocean basins, the North European and the Arctic.

(1) The North European Basin is situated between Greenland, Spitsbergen, Franz Joseph Land, Novaya Zemlya, the north and northwest coasts of Europe from Yugorskii Shar to Utsire Island (Norway) off the southern coast of Scandinavia, the Shetland and Faroe Islands and Iceland and includes the Greenland and Norwegian Seas (separated by a submarine fold stretching from Spitsbergen through Björnöya and Jan Mayen to Iceland), the Scandinavian Fjord Sea (separated from the Norwegian Sea by a multitude of islands, reefs and banks along the edge of the Norwegian fjords), the Barents and White Seas.

It is difficult to draw a physical-geographical boundary between the North European Basin and the Barents Sea, since the depths of the Norwegian Sea between Spitsbergen and Scandinavia

become the shallow depths of the Barents Sea gradually, without a sill. The same may be said of the strait between Franz Josef Land and Novaya Zemlya, which connects the Barents and Kara Seas.

(2) The Arctic Basin lies between the northern coast of Asia, the eastern shores of Novaya Zemlya, the northern shores of Franz Joseph Land, Spitsbergen and Greenland, the western shores of Ellesmere, Devon, Bathurst and Prince of Wales Islands and the northern coast of North America from Boothia Peninsula to Bering Strait.

The sea boundaries of this basin are:

(a) the sea boundary between the Arctic and Pacific Oceans (Bering Strait);

(b) the sea boundary between the Arctic Ocean and Baffin Bay;

(c) the sea boundary between the Arctic and North European Basins, passing along the submarine Nansen Sill between Northeast Cape (Greenland) and Amsterdam Island (Spitsbergen), further along the northern edges of Spitsbergen from Cape Leigh-Smith (Spitsbergen) across Kvitøya and Victoria Island to Cape Mary Harmsworth (Franz Joseph Land), then from Cape Kol'zat* to Mys Zhelaniya and further along the eastern edge of Novaya Zemlya Straits.

The Arctic Basin includes the Kara, Laptev, East Siberian, Chuckchee, Beaufort, North American Channel** and Lincoln Seas.

The total area of the Arctic Ocean (13,100,000 square km) is considerably less than that of the Indian (74,917,000 square km), Atlantic (93,363,000 square km) and Pacific (179,679,000 square km) Oceans.

The Arctic Ocean has certain singular features; one of the most remarkable of these is the unusual development of the continental shoal, especially off its Eurasian shore.

While the continental shoal (depths 0-200 m) comprises only 8 per cent of the area of the World Ocean, it comprises more than 37 per cent of the area of the Arctic Ocean. At the meridian of the White Sea Neck it embraces 15° of latitude; at the meridian of Bering Strait, if we count the continental shoal of the Chuckchee and Bering Seas, it extends for 18° of latitude, and is exceptionally shallow.

The Arctic Ocean also differs from other oceans with respect to its maximum depth. While the greatest depth of the Atlantic Ocean is 8,525 m, the Indian 7,450 m and the Pacific 10,830 m, the greatest depth of the Arctic Ocean probably does not exceed 5,180 m.***

*Probably the southwest cape of Zemlya Georga, Franz Joseph Land - Translator.

**Evidently the area between the Beaufort and Lincoln Seas, in Russian "Severo-Amerikanskoye Prolivnoye More," i. e. North American Channel (strait) Sea - Translator.

***The Wilkins Expedition found a depth of 5,440 m north of Wrangel Island, using an echo sounder. After the measurements made by Libin and Cherevichnyi in 1941, this depth seems doubtful. It is more accurate to consider 5,180 m, a depth measured by the *Sedov* during its drift in 1937 to 40, to be the greatest Arctic Ocean depth.

The entire area of the Arctic Basin together with its seas is about 8,800,000 square km, and the White Sea, with an area of ~95,000 square km can be counted as ice covered in winter. The ice area of the Barents Sea toward the end of winter is, on an average, ~1,000,000 square km. The ice area of the Greenland Sea in April-May reaches 900,000 square km. The total ice area for the whole Arctic Ocean in winter reaches 10,800,000 square km.

By the end of summer, an average of 1,500,000 square km of ice melts in the Arctic Basin, about 95,000 square km in the White Sea, and around 250,000 square km in the Barents. Further, over 1,250,000 square km of ice is carried off annually from the Arctic Basin into the Greenland Sea, where, fundamentally, it melts. Thus, by the end of the polar summer, the ice area of the Arctic Ocean decreases to 8,000,000 square km, due to melting.

About 150,000 cubic km of warm and saline Atlantic waters flow into the Norwegian Sea annually. According to Helland-Hansen's calculation, if these waters were cooled only 1°, the heat released would be sufficient to raise the temperature of a 4 km layer of air over all Europe by 10°. It is not hard to see that the heat released by a 1° cooling of these 150,000 cubic km of water would be almost enough to melt all the ice transported annually from the Arctic Basin into the Greenland Sea.

The Atlantic waters are carried to the northern shores of Spitsbergen and the eastern shores of Novaya Zemlya by the surface current. Somewhat to the north of Spitsbergen these waters sink and continue as a deep-water current.

According to available observations, Atlantic waters are found at intermediate depths everywhere in the deep parts of the Arctic Basin, while in some regions they are found on the continental shoal.

Atlantic waters are characterized not only by high temperature but by high salinity. Therefore, when their temperature is high they remain at the surface of the ocean. When the temperature drops, they become heavier than the lower-lying waters and mix with them. Consequently, with any drop in temperature, enormous masses of water are drawn into a heat exchange with the atmosphere.

The co-existence of such different streams as the warm Atlantic Current (which passes along the western shores of Norway and Spitsbergen) and the cold Greenland Current (which passes along the eastern coast of Greenland and carries with it the ice of the Arctic Basin) in relatively close proximity in the North European Basin creates unusually great surface-temperature differences and the world's most remarkable thermal anomalies.

One need only point out that the air temperature in January in the eastern part of the North European Basin is 20° higher than is to be expected at that geographic latitude.

The sea off the western shores of Spitsbergen remains unfrozen right up to 80° north. Ice can always be encountered at the southern edge of the Greenland Sea and along the east coast of Greenland. The influence of this ice and the ice carried out from Baffin Bay is felt much further south, as far as 40-50° north. Nowhere else on earth does one find the simultaneous existence of such conditions. This causes strong atmospheric perturbations over the North European Basin and somewhat farther south. The Icelandic minimum with its branches is located here; it forms a special center of atmospheric activity. The basic water masses of the Arctic Ocean also form here, as we will see below; hence, this is also a special center of oceanic activity.

The Atlantic waters that enter the Arctic Ocean are important in that they bring a tremendous amount of heat, thanks to which vast areas of the Norwegian, Greenland and Barents Seas are ice-free by the beginning of summer. During the summer, these waters absorb the heat of solar radiation in amounts that considerably exceed the heat brought by these waters from the Atlantic. All these tremendous amounts of heat are subsequently released into the atmosphere, which, in turn, transports them basically northward and northeastward, to the mainland and to the arctic ice. Thus, in the Arctic Ocean the three media--air, water and ice--interact on a grandiose scale.

The water-vapor content of the atmosphere determines its basic properties. Consequently, one might say that in the Arctic Ocean the three phases of water--the gaseous, liquid and solid--interact on a grandiose scale which cannot be repeated anywhere else on the earth.

The water here constantly converts from one phase into another, during which enormous amounts of heat are released or absorbed. Therefore, one cannot approach the study of such an important feature of the arctic as its ice, without considering the interaction of the atmosphere and the ocean.

LITERATURE: 71, 77, 143, 153.

CHAPTER I

SOME PROPERTIES OF SEA WATER

Section 1. The Concept of Water Structure

Water has certain special features which distinguish it from other liquids.

First, water is distinguished by its exceptional mobility: mechanical mobility, i. e., movement and oscillation, and thermal, i. e., conversion from one phase to another, in which case the transition vapor-water-ice (or, even bypassing the intermediate phase, vapor-ice) and the reverse are realized at ordinary earth temperatures and are accompanied by the generation or absorption of an enormous quantity of heat.

According to the kinetic theory of thermal motion, molecules move from place to place constantly and chaotically (gas molecules), or they are in constant vibrational motion (the molecules of a solid). At low temperatures, the properties of the molecules of a liquid approach those of a solid, while at high temperatures, they approach those of gas molecules. The intensity of the molecular motion determines the thermal state of the body.

When the temperature is increased, the distance between the molecules increases, therefore, the density of the substance should decrease with a rise in temperature, while the thermal capacity should increase. Water is one of the few exceptions in this respect. Pure water is densest at a temperature of approximately 4° ; when temperature decreases, density decreases slowly and when freezing occurs, density decreases sharply. Actually the density of pure ice at 0° is approximately 9 percent less than that of pure water at the same temperature.

The thermal capacity of water is higher than that of any other substance on earth except hydrogen and liquid ammonia. The thermal capacity of water gradually decreases beginning at 0° and continues till approximately 30° and only then begins to increase.

The latent heat of fusion of pure water is greater than that of any other substance on earth except ammonia.

The heat of vaporization of water is considerably higher than that of any other substance on earth.

Several theories have been propounded to explain all these and other anomalies of water. In these theories it has been assumed that water is a mixture of vapor, water and ice molecules, which differ in structure and density. The higher the temperature of the water, the greater will be the vapor-molecule content; the lower the temperature, the greater the ice-molecule content. Ice molecules are not as dense as water molecules.

If we examine water as an aggregate of molecules that differ in structure and density, we will find that two processes operate simultaneously when water cools: the first is a normal decrease in volume, the second an increase in volume due to the formation of the large, less dense ice

molecules. When water is cooled to 4° , the first of these processes is the more intensive, with further cooling, the second. The greatest density is attained at 4° , the equilibrium point of the two processes. During ice formation the number of ice molecules increases sharply, which involves a sharp decrease in density.

With a rise in temperature, the heat acquired from without is expended 1) on increasing the kinetic energy of motion and increasing the potential energy (by separation of the molecules) and 2) on decreasing the number of ice molecules. The higher the temperature, the smaller the influence of the second process and thermal capacity will decrease. The usual increase in thermal capacity begins to appear when the temperature rises above 30° .

Thus, the transformation of molecules of one structure into molecules of another structure which takes place with every change in temperature (requiring an additional expenditure of energy) explains the high thermal capacity, heat of fusion and heat of vaporization of water.

LITERATURE: 62, 132.

Section 2. The Composition of Sea Water

One of the most remarkable properties of water is its capacity to dissolve all kinds of substances; no other liquid can compare with it in this respect. Strictly speaking, there are no substances in nature that are completely insoluble in water. Water itself, however, does not enter easily into chemical compounds, in the literal sense of the word.

Sea water is a dilute solution (not more than 4 per cent by weight of solid substances are dissolved in it). Evidently, all known elements are found in sea water; if some elements have not as yet been found in sea water, the inadequacy of measuring methods is at fault rather than the actual absence of the elements.

The main elements comprising sea water are (in order of weight): chlorine, sodium, magnesium, sulfur, calcium and potassium. Besides solid substances, water contains dissolved gases: oxygen, nitrogen, carbon dioxide (and in some stagnant zones, hydrogen sulfide as well). Furthermore, the presence of inert gases in sea water has also been established qualitatively.

Some organic matter, of oceanic origin and from shore run-off, is also dissolved in sea water. Finally, sea water contains some slime and suspended matter of organic and inorganic origin, which give sea water the properties of colloidal solutions.

There are physical-chemical, biological and geological processes going on continually in sea water, causing a change in its total salt content (concentration) and in the ratios between the dissolved substances. These processes may be divided into two groups according to their effect:

processes which change, chiefly, the total concentration of the solution: this group includes: the influx of shore waters, evaporation, precipitation, formation and melting of sea ice;

processes which change the content of the gases and individual solid matter in sea water and the ratios between them; to this group belong: the vital activities of marine organisms, the formation and disintegration of bottom deposits.

Changes in the total concentration of sea-water solution in the individual parts of the ocean may be very great and can easily be revealed by the simplest observations, e. g., by density

measurements. As regards the processes of the second group, the relative changes caused by them are also great, but they affect substances which, for the most part, are in minimum quantities in the sea water and therefore such changes have practically no perceptible effect on the physical properties of sea water.

This gave rise to the very convenient concept that the salt composition of ocean waters is constant, by which we understand the following: the total concentration of the dissolved solid substances in the ocean, depending on local conditions, varies from 0-4 per cent by weight of the dissolved matter; the amount of gases dissolved in sea water and also the content of the other elements found in insignificant amounts in sea water may also vary considerably, but the ratios between the main ions which determine the physical properties of sea water remain basically constant in both time and space.

LITERATURE: 62, 153.

Section 3. Salinity

The salinity of sea water is characteristic of the concentration of solid matter dissolved in sea water. By salinity we mean the total weight in grams of all salts per 1000 g of sea water. Thus, salinity is the concentration of the solution, expressed in tenths of a per cent (pro mille).

The study of many samples of sea water (differing considerably in salinity and collected in different parts of the World Ocean) conducted by a number of specialists under the direction of Knudsen, showed quite clearly that the salt composition of ocean waters is constant, at least with regard to the main elements. Thus, we may conclude that the ocean waters of various regions, with the same pressure and temperature, differ only in the total concentration of their dissolved salts.

After it had been established and verified that the ratios between the main elements of sea water are constant, the total salinity of a given water could be found by simple conversion, once the content of one of the main elements had been determined.

Chlorine was chosen as this determining element, due to its high percentage content in sea water and the ease with which it can be determined accurately by chemical methods. Knudsen, Forch and Sorensen derived the following empirical formula from their investigations:

$$S = 0.030 + 1.8050 Cl$$

where S is salinity in pro milles, i.e., the total weight of salts in grams per 1000 g of sea water; Cl is the chlorine content in pro milles, i.e., the weight of chlorine in grams per 1000 g of sea water. (By chlorine here, we mean the number of grams of chlorine equivalent to the total amount of halogens, i.e., of chlorine, bromine and iodine in 1000 g of sea water.)

Of course, if we consider the salt composition of sea water to be constant we get not only a constant relationship between the chlorine content and salinity, but also constant relationships between the chlorine content and the other main elements of sea water.

Examining the salinity formula, we see that under the condition that the chlorine content is zero, salinity will still be 0.03. This is to be explained by the fact that, even though the chlorine content around river mouths may be zero, the total salinity will be determined from the calcium salts contained in the river water.

Thus, the chlorine content is a directly determinable quantity, while salinity is a quantity obtained by multiplying the chlorine content by some standard coefficient.

In oceanography, we must deal not only with the chlorine content or the salinity, but also with densities, which depend on them and on temperature. The physical methods of determining density are either inaccurate or too complex, while the chemical determination of chlorine content is very simple and does not require special knowledge of chemistry. Assuming that the salt content of sea water is constant, it is not difficult to determine both density and specific volume from the chlorine content.

In oceanographic research, we study, chiefly, the differences in the salinity and density of sea waters both in time and in space, not their absolute values. Therefore, we are not so much concerned with how accurately we determine salinity and density by the chlorine content, as how accurately we determine their differences. Hence, we can assume not only that the salt composition of ocean waters is constant, but that the salt composition of the waters within each separate ocean basin is constant, although it may differ from that of the ocean waters. Consequently, Knudsen's formula and the relationships stemming from it can be used in investigating the dynamics of sea water, not only for the ocean, but also for most of the enclosed seas.

LITERATURE: 62, 73, 157.

Section 4. Specific Gravity, Density and Specific Volume

The density of sea water at constant pressure is a function of both salinity and temperature. At the same temperature, it is exclusively a function of salinity and in oceanography is called specific gravity. In practice, specific gravity is expressed in two ways:

1. the specific gravity of sea water at 0° relative to distilled water at 4° $\left(s \frac{0}{4}\right)$.
2. specific gravity of sea water at 17.5° relative to distilled water at the same temperature $\left(s \frac{17.5}{17.5}\right)$

In oceanography, density and specific gravity differ in that temperature is taken into consideration in the case of density. In other words, density is the specific gravity of sea water at a given temperature (t) relative to distilled water at 4° $\left(s \frac{t}{4}\right)$.

Since the density of sea water varies within small limits, Knudsen introduced the following notations to limit the number of signs:

$$\begin{aligned}\sigma_0 &= \left(s \frac{0}{4} - 1\right) 1,000 \text{ is the natural specific gravity at } 0^\circ, \\ \rho_{17.5} &= \left(s \frac{17.5}{17.5} - 1\right) 1,000 \text{ is the natural specific gravity at } 17.5^\circ, \\ \sigma_t &= \left(s \frac{t}{4} - 1\right) 1,000 \text{ is the natural density.}\end{aligned}$$

The magnitudes S , Cl , σ_0 and $\rho_{17.5}$ are different expressions of the same amount of chlorides or chlorine content. Therefore, having determined one of these four values, the other magnitudes are determined in the process.

The relationship between the natural density and the natural specific gravity at 0° is determined by formula

$$\sigma_t = \sigma_0 + D,$$

where D is the correction for temperature and salinity.

All these values can be found from Knudsen's Hydrographic Tables, which are fundamental for any kind of oceanographic work.

The specific volume is a value the reciprocal of density, i. e.

$$\alpha \frac{t}{4} = \frac{1}{s \frac{t}{4}},$$

while I call

$$v_t = \left(\alpha \frac{t}{4} - 0.9 \right) 1,000$$

the natural specific volume, in analogy with natural density.

Due to the anomalous properties of water, the relationships between density and specific volume and salinity and temperature are expressed by very complex formulas which make it difficult to find these values without using detailed tables. Therefore, for any kind of derivations and computations usually the TS diagrams developed by Helland-Hansen for oceanographic work are used; these diagrams can be constructed easily for both density and specific volume.

The TS diagram of specific volume for salinities of 3.0-7.5 o/oo and for temperature from -2° to $+10^\circ$ are given in the upper part of figure 1; the lower part shows the specific volume for salinities from 31-35.5 o/oo and the same temperatures.

An examination of the TS diagrams shows that the natural density increases at all temperature and salinity values, while natural specific volume decreases approximately 0.007-0.008 with a salinity increase of 0.01 o/oo.

The density change taken as a function of temperature change is considerably more complex. Thus, the heating of water only within limits higher than the temperature of maximum density for a given salinity decreases the density. At high temperatures this is more pronounced than at low. From the TS diagram it is evident that for sea water with salinity of 31 o/oo and higher within the temperature range 0° to 8° , a 0.1° increase in temperature has the same effect on density and specific volume as a salinity decrease of 0.01 o/oo.

At lower temperatures and particularly at low salinities, slight changes in the water temperature have practically no effect on its density, and, finally, with slight salinities and low temperatures we even get a decrease in density with a drop in temperature. These phenomena are explained by the complexity of water structure and the irregular change in the coefficient of thermal expansion resulting from it.

Low temperatures, of the order of 2 to 3° at salinities from 34.5 to 35 o/oo, are observed everywhere at great ocean depths. In the Greenland Sea, the bottom temperatures vary within the limits -1.0° to -1.6° , while in the Arctic Basin they vary from -0.7° to -0.9° at the same salinity. Thus, we see that in the surface layers of the World Ocean, density is determined by salinity and

temperature, while in the deep-water layers of the World Ocean, only salinity is determinant. The Central Arctic Basin is exceptional in this respect; here the maximum observed temperature is +2.68° and, consequently, even the density of the surface waters is almost exclusively a function of salinity.

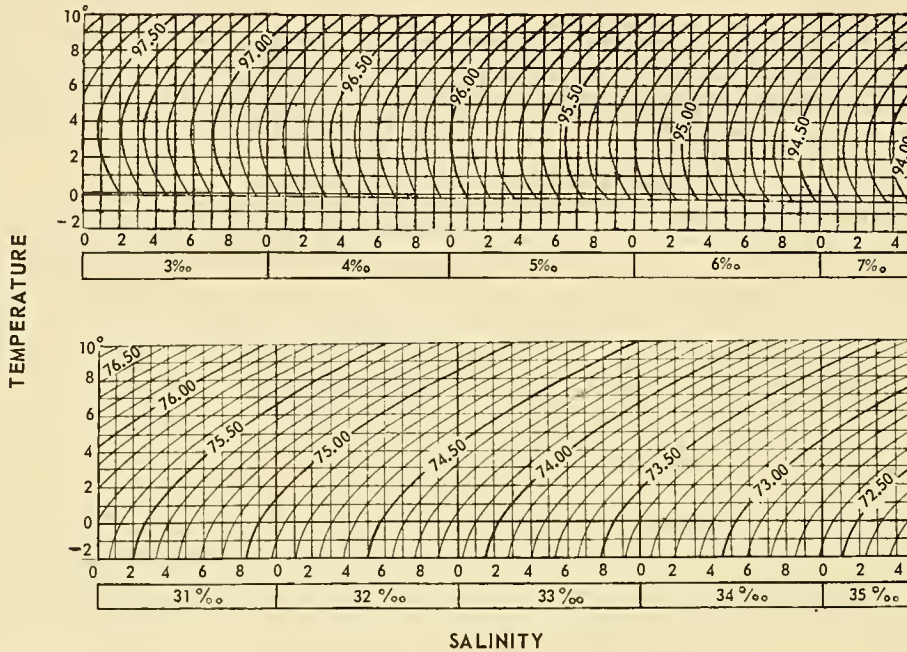

Figure 1. Graph for computing natural specific volume by temperature and salinity (TS diagram).

The density of the water increases with an increase in pressure. Thus, the density of water, whose salinity is 35 o/oo and temperature 0°, is 1.02813 at the ocean surface, while it rises to 1.07105 at a depth of 10,000 m under the pressure of the higher-lying layers. Thus, the compressibility of water is not very great. However, if water were absolutely incompressible, the ocean level would rise 30 m.

At great ocean depths an adiabatic increase in water temperatures occurs simultaneously with compression. Thus, the temperature of water sinking from the ocean surface to a depth of 10,000 m rises 1.37°.

LITERATURE: 48, 62, 73, 75, 154, 157.

Section 5. The Temperature of Maximum Density and the Freezing Point

The temperature of maximum density for distilled water is 4°. With an increase in the salinity of sea water, this temperature decreases.

Table 1 shows the temperature of maximum density, the freezing point and the natural densities of sea water at these temperatures.

TABLE 1. FREEZING POINT AND MAXIMUM DENSITY OF SEA WATER

S	θ°	σ_θ	τ°	σ_τ	S	θ°	σ_θ	τ°	σ_τ
0	3.95	0.00	-0.13	0.00	20	-0.31	16.07	-1.07	16.07
5	2.93	4.15	-0.27	3.96	25	-	-	-1.35	20.10
10	1.86	8.18	-0.53	8.00	30	-	-	-1.63	24.15
15	0.77	12.13	-0.80	12.02	35	-	-	-1.91	28.21

I believe it is possible to use the following formula for computing the freezing point of sea water according to its salinity:

$$\tau = -0.054 S$$

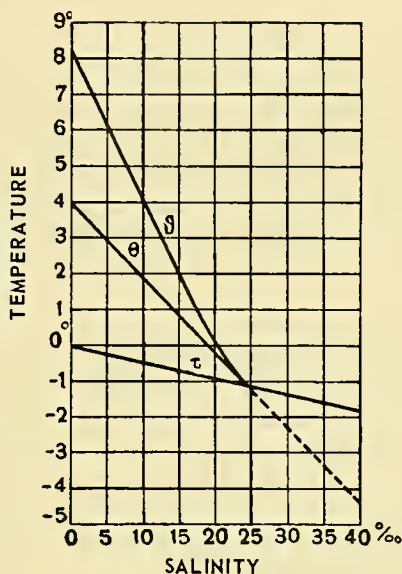

Figure 2. The freezing point of sea water, the temperature of greatest density and the temperature of density equal to the density at the freezing point.

From the graph shown in figure 2 it is evident that both temperatures decrease almost linearly with an increase in salinity, in which case the temperature of maximum density decreases more rapidly than the temperature of freezing. Consequently, the curves intersect at a certain salinity.

At the point of intersection, both temperatures are evidently equal. Determining the corresponding salinity by the last condition, we get

$$\begin{aligned} \theta &= \tau = -1^\circ.332; \\ S_\theta &= S_\tau = 24.695 \text{ o/oo}; \\ \sigma_\theta &= \sigma_\tau = 19.852 \text{ o/oo}. \end{aligned}$$

From this it follows that a salinity of 24.695 o/oo is transitional in that at lower salinities, the temperature of maximum density is higher than the freezing point, i.e., we have the same phenomena as for fresh water. Such waters are called briny. Only with salinities > 24.695 o/oo does water take on the typical character of sea water: the freezing point in the sea (if we exclude supercooling), i.e., under natural conditions, is simultaneously the temperature of maximum density.

The freezing point drops with an increase in pressure, i.e., the ice which had formed melts with increased pressure. This in particular explains the fusion of ice floes due to compression.

Theoretically, the freezing point drops 1° with a pressure increase of 134.4 bars.

The temperature of maximum water density, according to Amaga, drops 1° with a pressure increase of 40.5 bars. At a pressure of 146.6 bars, it is 0.6° .

It should be noted that any ice, and in particular sea ice, is permeated with capillaries. The freezing point decreases in the capillaries, e.g., Lange showed that a temperature of -18° is required to cause fresh water to freeze in a capillary 0.1 mm in diameter.

LITERATURE: 62, 73, 97, 154.

Section 6. Increase in Density During Mixing

Since the temperatures of freezing and of maximum density do not coincide, near the temperature of maximum density for briny waters, a region of temperatures forms in which water of the same salinity may have the same density at two different temperatures. Thus, e.g., the density of distilled water is the same at 0° and at 8.2° . Curve δ in figure 2 is a curve of temperatures lying above the temperature of maximum density, but at which the density of the water is equal to the density of water of the same salinity at the freezing point. This property of water is responsible for the "increase in density with mixing."

Let us mix two equal parts of fresh water: one with a temperature of 8.2° , the other 0° . The density is 0.99987 in each case. After mixing, the temperature of the mixture will be 4.1° , the density about 1.00000, i.e., 0.00013 greater than that of each of the mixed parts taken separately. Densification during mixing of waters of the same salinity is possible for sea water with a salinity of less than 24.695 o/oo, between the freezing temperature and the temperature which can be determined by the δ curve of figure 2. But further, as can be seen from the TS diagram, for sea waters of any salinity and temperature but of the same density, the density after mixing is always greater than the density computed from the mixing formulas, particularly at low temperatures and salinities. This phenomenon is fully explained by the convexity of the curves of equal density.

Table 2 shows the temperatures and salinities of waters of equal density and their temperatures, salinities and natural densities after equal masses of the examined waters have been mixed. As can be seen from the table, when equal masses of water are mixed, one of which has a temperature of -1.6° and a salinity of 27.38 o/oo (approximately corresponding to the waters of the Labrador Current) while the other has a temperature of 30.0° and salinity 35.36 o/oo (approximately corresponding to the waters of the Gulf Stream), and with a natural density of 22.0 for both waters before mixing, we find a common temperature of 14.2° , salinity 31.37 o/oo and natural density 23.39. Thus, in the case examined, the natural density increases 1.39 due to mixing, which is quite an appreciable amount. Actually, a similar effect is obtained for water No. 2, either by increasing the salinity 1.82 o/oo or by decreasing the temperature 4.2° .

The magnitude of density increase during mixing and the mixing proportion causing maximum density increase can be determined most simply from the TS diagram. On the TS diagram, let us join the two TS points characterizing the mixing waters by a straight line. Let us call this line the "mixing line". Actually, with any mixing proportion, the TS point of mixture lies on this line. If we compare the densities taken from the TS diagram with those computed from the mixing formulas, we will get the magnitudes of density increase. Under certain conditions the density of the mixture

proves higher than that of each of the waters prior to mixing. It is easy to see that such a highly interesting density increase is possible only if the mixing curve intersects the isostere of the denser mixing water and only if the mixing proportions lie on the "chord" of this isostere.

TABLE 2. INCREASE IN DENSITY WHEN EQUAL WATER MASSES OF UNIFORM DENSITY ARE MIXED

σ_t	Water 1		Water 2		Mixture		
	t°	S	t°	S	t°	S	σ_t
2.00	-0.1	2.58	30	8.45	15.0	5.51	3.38
4.00	-0.3	5.06	30	11.15	14.9	8.10	5.41
6.00	-0.4	7.53	30	13.84	14.8	10.68	7.40
8.00	-0.5	10.00	30	16.56	14.7	13.28	9.40
10.00	-0.6	12.48	30	19.24	14.7	15.86	11.39
12.00	-0.8	14.96	30	21.93	14.6	18.45	13.36
14.00	-0.9	17.44	30	24.62	14.5	21.03	15.38
16.00	-1.1	19.93	30	27.30	14.4	23.13	17.38
18.00	-1.2	22.42	30	29.99	14.4	26.20	19.38
20.00	-1.4	24.89	30	32.68	14.3	28.78	21.35
22.00	-1.6	27.38	30	35.36	14.2	31.37	23.39
24.00	-1.7	29.84	30	38.02	14.2	33.93	25.33

TABLE 3. TEMPERATURE, SALINITY, NATURAL DENSITY AND DENSITY INCREASE AFTER THE WATERS HAVE BEEN MIXED IN DIFFERENT PROPORTIONS

n_1	n_2	t°	S o/oo	σ_t	$\Delta\sigma_t$
0	10	10	10.0	7.56	0
1	9	9	9.8	7.56	0.07
2	8	8	9.8	7.60	0.12
3	7	7	9.7	7.61	0.16
4	6	6	9.6	7.60	0.19
5	5	5	9.5	7.57	0.20
6	4	4	9.4	7.52	0.18
7	3	3	9.3	7.46	0.15
8	2	2	9.2	7.39	0.12
9	1	1	9.1	7.31	0.07
10	0	0	9.0	7.21	0

Table 3 shows the results of mixing the two waters in different proportions: 1) $t_1 = 0^\circ$, $S_1 = 9.0$ o/oo and 2) $t_2 = 10^\circ$, $S_2 = 10.0$ o/oo. The last column of the table gives the density increase relative to the densities computed from the mixing formula. As can be seen from the table, when the masses of denser water are greater than those of less dense water, the density of the mixture is greater than that of the denser water. With other proportions, although density increase occurs, the density of the mixture is intermediate between the densities of the mixing waters.

Understandably, the capacity of water to become denser on mixing has the most essential effect on ocean dynamics and is of greatest importance in the polar regions.

LITERATURE: 77.

Section 7. The Properties of Sea Water of High Salinity

The average salinity of ocean water is 35 o/oo, but in seas where evaporation exceeds precipitation and influx of shore waters, the salinity is somewhat higher.

The increase in salinity with evaporation is to be explained by the fact that in this process only a very insignificant part of the salts dissolved in the sea water escapes into the atmosphere. A second possibility of increased salinity of sea water is ice formation, since the salinity of ice is always considerably less than that of the sea water from which it is formed.

Let us assume in first approximation that pure ice, free of all salts, is formed from sea water and let us trace the phenomena which occur during the cooling of an isolated amount of sea water.

After the water temperature, on cooling, reaches the freezing point, ice begins to separate from it, which causes increased salinity of the remaining sea water. A new decrease in temperature is required for further ice formation. Thus, the concept of a freezing point for sea water differs from that usually taken for fresh water. Actually, if we keep any amount of fresh water at a constant temperature slightly below zero for a sufficient interval of time, eventually it will freeze completely without a residue. If, however, we take sea water, we can keep it at a constant temperature below the freezing point for as long as we like. In this case only a very definite amount of pure ice will be separated from it, which will raise the salinity of the remaining volume to the extent that further ice formation at that temperature will be impossible. If the temperature is lowered, the ice production and the salinity of the remaining solution will be increased. After prolonged cooling and ice formation, the salinity of the sea water may increase to the extent that eutectic phenomena will begin in the solution.

Let us assume that we have a solution of a single salt, e. g., table salt and subject this solution to cooling. At some temperature below zero (depending on the concentration of the solution) pure ice will begin to form and subsequently the solution concentration will gradually begin to increase, each temperature will have a corresponding definite solution concentration. The formation of pure ice will continue until the temperature reaches -21.9° , until the concentration of the solution becomes 22.4 o/oo. After this, with further cooling, the entire solution as a whole will harden into a conglomerate representing a mixture of ice and salt crystals and called a cryohydrate or eutectic mixture.

If the concentration of table salt at the initial moment at a high temperature is greater than 22.4 o/oo*, on cooling the salt will begin to precipitate out from the solution again such that for each temperature there will be a corresponding definite amount of salt saturating the solution at the given temperature. This phenomenon would continue until the concentration of the solution became 22.4 o/oo and the temperature -21.9° , at which point the entire solution would harden as a cryohydrate. The solution concentration 22.4 o/oo and temperature -21.9° are the eutectics of table salt.

The difference in the eutectic temperatures of the salt solutions forming the sea water complicates the chemical processes during intense salinification caused by ice formation.

*A saturated solution of table salt at 0° is about 27 g per 100 g water.

Ringer conducted a laboratory study of these processes. For his experiments he took water with salinity 35.05 o/oo and freezing point -1.91° . Already at this temperature calcium carbonate precipitated out from the sea water.

With further cooling to a temperature of -8.2° , when glauber salt began to precipitate, only pure ice was formed. With a further drop in temperature, the precipitation of glauber salt was so rapid that at -20° , only 0.1 of the initial amount of sulfates remained in the solution. At -23° table salt began to precipitate, at -36° magnesium chloride and potassium chloride. At -55° , calcium chloride began to precipitate, while at lower temperatures the whole mass hardened.

TABLE 4. RESULTS OF THE SEA-WATER FREEZING (PRO MILLE BY WEIGHT)

τ°	Liquid Phase	Solid Phase	Sodium Sulfate In Solid Phase	Table Salt In Solid Phase	Pure Ice
-5	429.5	570.5	0	-	570.5
-8.2	281.5	718.5	0	-	718.5
-10	234.0	766.0	1.84	-	764.16
-15	186.1	813.9	3.09	-	810.81
-20	147.9	852.1	3.58	-	848.52
-23	134.6	865.4	3.68	-	861.72
-30	43.95	956.05	3.95	20.23	931.87

Table 4, according to Ringer, shows the behavior of the ice formation process and the precipitation of salts in grams per 1000 grams solution with cooling of sea water (initial salinity 35.05 o/oo) to -30° .

Thus, in sea water at low temperatures (below the temperature at which ice formation begins), the salt composition is a function of temperature; it is constant for each given temperature, but differs from that at any other temperature.

TABLE 5. FREEZING POINT OF HIGH-SALINITY SEA WATER

S o/oo	τ°	S o/oo	τ°	S o/oo	τ°
0	0.0	90	- 5.6	180	-13.6
10	-0.5	100	- 6.4	190	-14.7
20	-1.1	110	- 7.1	200	-15.8
30	-1.7	120	- 8.0	210	-16.9
40	-2.2	130	- 8.8	220	-18.0
50	-2.8	140	- 9.7	230	-19.1
60	-3.4	150	-10.5	240	-20.3
70	-4.1	160	-11.5	250	-21.6
80	-4.8	170	-12.5	260	-23.0

I computed the freezing point of high-salinity sea water after Hansen's formula (for the freezing point of sea water) and Ringer's experimental data. The results are given in table 5.*

*Computations for lower temperatures must be considered highly unreliable.

If we know the salinity of the solution, using this table we can determine the temperature at which ice formation begins. Conversely, given some temperature below 0° , we can derive the salinity to which (by production of pure ice) the salinity of any sea-water solution can be raised.

Complex phenomena analogous to ice formation also take place during evaporation of sea water. Actually, if there is only one salt in a solution, it begins to precipitate out in the form of crystals as soon as the solution becomes saturated at a given temperature due to evaporation. If there are several salts in the solution, usually the least soluble ones precipitate first. It has been found that during evaporation calcium carbonate precipitates first, then glauber salt, while potassium chloride precipitates only with great difficulty.

LITERATURE: 62, 73, 77, 168.

Section 8. Thermal Capacity, Heat of Fusion and Heat of Vaporization

The thermal capacity of sea water decreases from 1.009 to 0.925 cal/g/ $^{\circ}$ C with an increase in temperature and salinity. The thermal capacity of water is higher than that of any other substance on earth except for hydrogen (3.4 cal/g/ $^{\circ}$ C) and liquid ammonia (1.2 cal/g/ $^{\circ}$ C).

The latent heat of fusion of distilled water, according to the most reliable determinations of many researchers, is 79.67 cal/g/ $^{\circ}$ C at 0° . This heat of fusion is the highest of all substances on earth, with the exception of ammonia, for which it is 108 cal/g/ $^{\circ}$ C.

The heat of vaporization of water decreases from 596 cal/g/ $^{\circ}$ C at 0° to 540 cal/g/ $^{\circ}$ C at 100° . The heat of vaporization of water is higher than that of any other substance on earth. The heat of vaporization of ice or snow is usually considered the sum of the heat of fusion of ice and the heat of vaporization of water.

The high values of the specific heat, heat of fusion and heat of vaporization of water for the thermal regime of the earth are easily explained by the following calculation.

When one volume of water is cooled 1° an amount of heat is released sufficient to heat 3100 volumes of air by 1° ; when ice is formed an amount of heat is released from one volume of water that is sufficient to heat about 250,000 volumes of air by 1° ; when one volume of water is condensed, enough heat is generated to heat about 1,800,000 volumes of air by 1° .

LITERATURE: 62, 73.

Section 9. Vapor Pressure

If a small amount of water is placed in the Torricelli vacuum of a barometer, the water will vaporize and the vacuum will become saturated with water vapors; there will be as much water vapor as can exist in the gaseous state at the given temperature. These vapors will exert a certain pressure on the mercury, whose level will decrease correspondingly. Vapor pressure is measured by the fall of the mercury column in mm. The pressure of saturated sea-water vapor, as in the case with any solution, is somewhat less than that of pure water. Actually, in sea water the molecules which escape from the liquid during evaporation must overcome not only the attraction of the water molecules, but also the attraction of the molecules of the dissolved substances, which remain in solution during evaporation.

Of course, in general, the farther the water-adjacent atmosphere is from a state of saturation the greater will be the evaporation rate. The latter is determined either by the moisture deficit (Δ) or by the relative humidity (r) which can be determined from the formulas

$$\Delta = E - e \quad \text{and} \quad r = 100 \frac{e}{E},$$

where E is the pressure of the vapor saturating the air at the given temperature, e is the pressure of the vapor in the air at that same temperature.

The saturation vapor pressure increases very rapidly with increasing temperature and, consequently, the dryness of the air also increases. With a drop in temperature, the relative humidity of the air increases and at a temperature called the dew point, when the moisture deficit is zero and the relative humidity 100 per cent, evaporation ceases and condensation begins, i. e. the formation of fog and the precipitation of dew.

The following are given in table 6: E_w the saturation vapor pressure above water in mb, E_i the saturation vapor pressure above ice in mb, q_w the water-vapor density above water in g/m^3 , q_i the water-vapor density above ice in g/m^3 .

TABLE 6. THE PRESSURE AND DENSITY OF WATER VAPOR ABOVE WATER AND ICE

t°	E_w	E_i	q_w	q_i	$\frac{E_i}{E_w} \%$
0	6.11	6.12	4.85	4.86	103
-10	2.87	2.60	2.36	2.14	90
-20	1.25	1.03	1.07	0.88	82
-30	-	0.39	-	0.35	-

From the table it is evident that the saturation vapor pressure above ice is less than the vapor pressure above supercooled water at the same temperature. Consequently, there cannot be equilibrium above water and ice at the same temperature: water vapor in the atmosphere above ice will become ever denser until the entire liquid evaporates or until all the ice melts. Equilibrium between water and ice is even less feasible when there is a difference in temperature.

LITERATURE: 62, 73.

Section 10. Reflection and Refraction of Solar Energy

A sun's ray falling on the surface of the sea in part is reflected into the atmosphere and in part is refracted into the water.

The coefficients of refraction in water for all wavelengths of the visible spectrum are approximately 1.34. They increase slightly with decreasing temperature and increasing salinity.

Table 7 shows the angles of incidence (i) and of refraction (r) of an individual ray of light, and also the ratio between the reflected (I_i) and incident (I_o) energy (index of reflection).

TABLE 7. INDEX OF REFLECTION

i°	90	80	70	60	50	40	30	20	10	0
r°	48.3	47.3	44.5	40.3	34.9	28.7	21.9	14.8	7.4	0
I_i/I_o	100.0	35.0	13.5	6.0	3.5	2.5	2.2	2.1	2.1	0

The surface of the sea, however, is not only illuminated by direct solar rays, but also by scattered radiation, i. e., by rays falling onto it from all directions and partially reflected in all directions.

The concept of "albedo" is introduced to take account of the energy thus reflected, by albedo we understand the ratio of the reflected to the scattered energy incident on the given surface expressed in per cent or, in other words, the coefficient of reflection.

The concept of albedo should be expanded for such semi-transparent media as water and ice. Actually, as Kalitin pointed out, the albedo of the sea includes, first, solar radiation reflected and scattered by the sea surface, second, radiation sent by the sea into the atmosphere and caused by molecular scattering of the water mass itself and the particles suspended in it.

The purer and more transparent the ocean water, the lower the albedo and the closer it approaches the one derived from table 7.

Employing this table, we find that even for direct solar radiation at solar altitudes greater than 25° , the albedo of the sea is less than 9 per cent; in other words, the ocean albedo is small in comparison with that of all other forms of the earth's surface. The albedo of old, settled snow, on the other hand, varies between 30 and 50 per cent, while it reaches 70 to 90 per cent for the white smooth surface of freshly fallen snow. Thus, of all the natural surfaces of the earth, the ocean is the most absorptive of solar energy, while snow and ice are the most reflective.

Due to the high albedo of the snow cover, illumination even in the middle latitudes is maximum in spring (when the air is most transparent), in presence of a snow cover not yet affected by thawing (high albedo) and in presence of slight cloudiness and during a light snowstorm (great scattered radiation).

LITERATURE: 62, 73, 81.

Section 11. Absorption and Scattering of Solar Energy

The stream of solar energy, on passing through the layers of water and being absorbed in part, loses some energy on heating the sea.

Investigations have shown:

1. The values of the absorption coefficients, even for slightly differing wavelengths of solar energy, fluctuate within very wide limits. Thus, the absorption of solar energy by water is an extremely selective process.
2. The absorption coefficients are maximum in the infrared, absorption is considerably less in the ultraviolet and least in the visible spectrum.
3. The long waves are absorbed more intensively in the visible spectrum.

Light energy, passing through layers of air, water and ice, is not only absorbed but also scattered.

The coefficient of scattering for slightly turbid media is inversely proportional to the fourth power of the wavelength. Hence, it follows that the longer the wave, the less it will scatter, i.e., this is the opposite of what takes place for absorption in the light part of the spectrum. With an increase in the size of the particles in any medium, the exponent decreases with wavelength, and when the particles are quite large and the light ray is both reflected from the surface of the particles and is absorbed by the particles, the exponent becomes zero, i.e., scattering becomes independent of wavelength.

The heat, light and color regimes of the ocean and the atmosphere are determined by the selectivity of the absorption process and by the combined effect of absorption and scattering.

It is very important that the dark, long-wave rays in which up to 60 per cent of the thermal energy is concentrated are absorbed in the uppermost layers of the ocean. At a depth of 1 cm, the thermal effect of solar energy is approximately 94 times less than at the water surface, while at a depth of 1 m it is 8,350 times less. Light penetrates to the ocean depths, but the heat is absorbed by the surfacemost layers. This shows that the ocean would be practically unheated, if various factors did not cause mixing of its upper layers.

Since in clear or slightly turbid media, the short rays are the ones most scattered, the clearer the medium, the fewer the particles, and the fewer the particles per unit volume, the bluer the medium appears. This explains the blue color of the sky, water, ice, smoke, etc. On the other hand, scattered light does not change color with an increase in the size of foreign inclusions. This explains the white color of clouds and mists, the droplet sizes of which are considerable in comparison with the size of the light waves.

In the ocean itself, as observations have shown, the intensity of illumination decreases rapidly with depth due to selective absorption and scattering: the twilight which prevails even at moderate depths keeps deepening, the green becomes light blue, dark blue, violet, and at great depths there is complete darkness.

Neither the transparency nor the color of the sea is connected with either temperature or salinity, but is a function exclusively of the size and number of impurities of organic and inorganic origin. Therefore, the sea, as a rule, is transparent and blue far from shore, and becomes less transparent closer to shore, taking on a greenish-brown hue. The water in shallows and off shore becomes considerably less transparent after storms.

Sea ice and glacier ice always contain organic and inorganic impurities. Therefore, in regions where ice melts, transparency always decreases and the color of the sea becomes green. This is further intensified by the vigorous growth of microscopic algae, which always accompanies melting. Further, myriads of tiny air bubbles trapped in the ice enter the water when the ice melts. These bubbles, remaining in a suspended state for a long time and decreasing transparency, give the water a whitish tint, although preserving its basic color. When glacier ice melts, the so-called glacier milk affects the color of the sea, giving it a whitish-light blue tint. On the other hand, amid non-melting ices, due to the singular purification of the sea by vertical circulation, the sea is very transparent in the ice-formation period and approaches a dark blue color.

LITERATURE: 62, 73, 77.

CHAPTER II

CHANGES OF TEMPERATURE AND SALINITY OF THE OCEAN

Section 12. The Processes that Change the Temperature and Salinity of the Ocean

The measurement of temperature and the determination of salinity (or any other physical-chemical property) of sea water can be carried out in two ways:

The temperature can, for instance, be measured at certain time intervals, at the same points in the sea and at the same depths from mean sea level or, in other words, at the same geographical coordinates; such measurements will give an idea of the variations of heat regime of the sea only in the absence of vertical and horizontal movements of water masses in the given area. With the presence of currents, however, we will obtain the temperatures of various water masses each time by measuring the temperatures at geographical coordinates; the temperature variations can be traced in the moving water mass or, according to a statement by Helland-Hansen, the temperature can be measured in oceanological coordinates.

The concept of oceanological and geographical coordinates relative to temperature is determined by the following formula:

$$\frac{dt}{dT} = \frac{\partial t}{\partial T} + u \frac{\partial t}{\partial x},$$

where dt/dT = the rate of temperature variations affected by local circumstances in the same water mass, i. e., the temperature variation with time in oceanological coordinates, $\partial t/\partial T$ = the rate of temperature variations at the same geographical latitude and longitude and at the same depth below the sea surface, i. e., the temperature variation with time in geographical coordinates, u = current speed, and $\partial t/\partial x$ = the horizontal temperature gradient in the sea in the direction of the current.

It is evident that the second term of the equation characterizes the temperature variation at a given point of the sea, which is caused not only by local conditions but also by the heat influx via the current. In other words, by advected heat.

The variations of temperature and salinity of the water, in oceanological coordinates, are created almost exclusively at the sea surface. The main processes that raise the temperature of the surface water layers in oceanological coordinates are as follows:

1. absorption by the sea of incident and diffuse solar radiation (this is the most important process),
2. radiation from the warmer atmosphere to the colder ocean,
3. condensation of atmospheric moisture over the colder ocean,

4. precipitation that is warmer than the surface layers of the ocean.

The main processes that lower the temperature of surface layers of the ocean are as follows:

1. radiation from ocean to the atmosphere,
2. evaporation,
3. convection of the atmosphere,
4. precipitation that is colder than the ocean surface,
5. ice melting.

The main processes that increase the salinity of surface water layers are as follows:

1. evaporation,
2. ice formation.

The main processes that decrease the salinity of surface water layers are as follows:

1. precipitation,
2. condensation of water vapor on the ocean surface,
3. ice melting.

In addition to these main processes, there are processes that are constantly active in the sea — changing its temperature and salinity, but being of considerably smaller significance. These processes are as follows:

1. transformation of the mechanical energy of wind, currents and tidal phenomena into heat energy, which results from friction and occurs at all depths,
2. biochemical processes which change, to a degree, the temperature and salinity and occur at all depths,
3. absorption of the earth's heat by deep water layers. The earth's heat, as well as the radioactivity of the bottom, explains evidently the somewhat higher temperatures of almost immobile bottom layers of the oceans and several landlocked seas.

The main processes that affect the temperature and salinity of ocean surface layers in oceanological coordinates do not occur independently from one another. On the contrary, they usually occur simultaneously, whereby part of them act in one direction and others the reverse direction. For instance, the warming of the sea surface intensifies evaporation which, in turn, cools the surface layers. Not only does this evaporation cool the ocean surface layers, but simultaneously it also increases their salinity, etc. The intensity of each of the processes that affect the temperature and salinity of the surface layers of the ocean does not remain constant; sometimes one of the processes prevails and at other times another. In this connection, the temperature and salinity of the ocean is now increasing, now decreasing. Thus the final effect of temperature and salinity

variations is expressed as an algebraic sum of variations induced by processes that act simultaneously.

The temperatures and salinities that are created in surface layers by intermixing are transmitted downward to a certain depth, thus creating the so-called "active layer."

Depending on local circumstances, this layer can be completely uniform. At other times, the curves of vertical distribution of oceanological characteristics in the active layer are very complex. Besides, this layer can be either thick or thin.

The main distinguishing feature of the active layer is the fluctuation of oceanological characteristics (within the limits of accuracy of the observations). These fluctuations can be diurnal, seasonal, secular or of some other period. Evidently, the longer the given time period, the greater the thickness of the active layer.

The intermixing processes that create the active layer are discussed in detail in the subsequent chapter. Here it suffices to point out that if the density of surface layers increases with a change of temperature and salinity in the layer, a convective intermixing is induced as a result. Otherwise, the static equilibrium of water layers is not disturbed, and external factors need be added in order to induce intermixing, notably: the wind, tidal phenomena, currents, etc., which induce the movement of water layers relative to one another in the sea. The intermixing that is induced by external forces can be called a frictional intermixing (occurring as a result of friction relative to one another).

LITERATURE: 62, 67.

Section 13. Solar Radiation

Solar energy is a primary source of all phenomena occurring on the earth. The quantity of sunlight and heat that reaches the earth depends on the geographical latitude and varies with variations of astronomical and meteorological conditions. The quantity of heat annually transmitted by the sun to the earth could melt a layer of ice 36 in. thick covering the entire surface of the earth.

At high latitudes (beyond the Arctic Circle), the following astronomical seasons can be singled out:

1. arctic winter - the sun does not rise above the horizon,
2. arctic spring - the sun rises and sets daily, but the length of the day is increasing,
3. arctic summer - the sun does not disappear at all,
4. arctic autumn- the sun rises and sets daily, but the length of the day decreases.

The nearer to the Arctic Circle (away from the Pole), the shorter is the arctic winter and the arctic summer; the nearer to the Pole, the shorter the arctic spring and the arctic autumn.

TABLE 8. DATES OF THE BEGINNING AND DURATION (IN DAYS) OF ARCTIC SEASONS

Latitude	Spring		Summer		Autumn		Winter	
	Date	Number of Days	Date	Number of Days	Date	Number of Days	Date	Number of Days
68°	4. I	143	27. V	53	19. VII	144	10. XII	25
70°	17. I	120	17. V	72	28. VII	121	26. XI	52
72°	26. I	103	9. V	88	5. VIII	104	17. XI	70
74°	3. II	88	2. V	102	12. VIII	90	10. XI	85
76°	9. II	76	26. IV	115	19. VIII	76	3. XI	98
78°	15. II	64	20. IV	127	25. VIII	63	27. X	11
80°	22. II	51	14. IV	139	31. VIII	52	22. X	23
82°	27. II	41	9. IV	150	6. IX	41	17. X	133
84°	4. III	31	4. IV	159	10. IX	31	11. X	144
86°	9. III	21	30. III	169	15. IX	21	5. X	155
88°	14. III	11	25. III	179	20. IX	10	30. IX	165
90°	20. III	0	20. III	189	25. IX	0	25. IX	176

These simple schemes are somewhat modified by refraction, which elevates the sun above the horizon, and the twilight phenomena of either the civil or astronomical state.*

The change of astronomical conditions is determined not only by the earth's rotation around the sun (upon which the seasons of the year depend) and around its own axis (upon which the time of day depends), but also by the change of distance from the earth to the sun.

It is assumed that the solar heat reaching the upper limits of the atmosphere equals 1.94 g-cal per min. per cm³ of the surface perpendicular to the sun's rays. This magnitude is called the solar constant and it varies somewhat with time in connection with the variation of the amount of sunspots and with the variation of distance to the sun. Thus, during the years that are characterized by the maximum number of sunspots, when the sun's surface is most active, the solar constant is approximately 2 per cent greater than during the years that are characterized by the minimum number of sunspots. When the earth is nearest to the sun (about January 1, perigee) the constant is 1.07 times greater than when the earth is farthest from the sun (about July 1, apogee).

There are incident and diffuse radiations. The incident radiation is associated with direct sunbeams, the diffuse radiation with sunbeams that are reflected in the atmosphere and that strike objects from all sides.

The incident and diffuse radiations add up to the total solar radiation.

The intensity of solar radiation (as well as the solar constant) is measured in g-cal per min. per cm².

*Civil twilight lasts from the moment the upper rim of the sun disappears to the moment the sun reaches 7° below the horizon. This is a conditional concept. It is assumed that the illumination during civil twilight is sufficient for reading in the open.

Astronomical twilight lasts from the sun's disappearance to the moment the sun reaches 17° below the horizon and the stars of the 6th magnitude can be distinguished by eye.

The intensity of incident solar radiation is reduced to the horizontal plane by the formula

$$I = I_0 \sin \alpha, \quad (1)$$

where I_0 = radiation striking a plane that is perpendicular to the sun's rays, α = sun's elevation above the horizon.

Formula (1) explains the relatively intense heating of vertical walls at small elevations of the sun. This phenomenon is of special significance in arctic areas where the vertical walls of hummocks and icebergs melt intensely in summer while the horizontal surfaces of ice floes remain untouched.

The intensity of solar radiation also depends on the sun's elevation because at small elevations the sunbeams, prior to reaching a given object, must penetrate atmospheric strata having considerable thickness or, in other words, pass through considerably greater "atmospheric masses" than at greater sun's elevations. Assume that a sunbeam strikes the earth in vertical direction. When passing through the atmosphere, the energy of the sunbeam, due to absorption and scattering, will decrease, becoming equal to

$$I_1 = I_0 q, \quad (2)$$

where q = coefficient of atmospheric scattering.

If this sunbeam would penetrate one more atmosphere like this, or one more "atmospheric mass" having the same optical properties, then the preceding formula is transformed into

$$I_2 = I_1 q = I_0 q^2, \quad (3)$$

but when penetrating m atmospheric masses

$$I_m = I_0 q^m. \quad (4)$$

This is known as the Lambert-Bugge formula.

It is obvious that in order to find the intensity of the solar radiation striking the horizontal surface of the sea,

$$I = I_0 q^m \sin \alpha. \quad (5)$$

As to the coefficient of scattering, it depends on meteorological conditions, the dust content, and, mainly, on the water vapor content of the atmosphere.

The water vapor pressure in the atmosphere, as we already know, depends on temperature. At -20° , the saturated vapor pressure equals 1.25 mb, at 0° — 6 mb, at 30° — 42 mb. Hence, in arctic regions, despite small elevations of the sun, the intensity of incident solar radiation may exceed the intensity of solar radiation at noon in tropical regions, because in the arctic regions the atmosphere contains not only a small quantity of water vapor but also a small quantity of dust. Thus, the colder the air (with the absence of clouds), the greater is the scattering of the atmosphere.

TABLE 9. THE MEAN OBSERVED MAGNITUDES OF THE INTENSITY OF SOLAR RADIATION AT THE MEAN DISTANCE BETWEEN THE EARTH AND THE SUN (G-CAL/CM²/MIN)

Sun's Elevation	Bukhta Tikhaya	Barents-burg	Matochkin Shar	v. Polyapnoye	Wellen	<i>Maud</i>
3°	0.38	0.29	0.36	0.37	0.39	0.39
10°	0.80	0.78	0.81	0.78	0.83	0.82
20°	1.11	1.11	1.11	1.04	1.11	1.12
30°	1.28	1.28	1.25	1.14	1.25	1.27
35°	--	1.35	1.30	1.18	1.31	1.32
40°	--	--	1.35	1.21	1.34	--
45°	--	--	--	--	1.37	--

Table 9, based on data by Kalitin, shows the observed mean values of intensity of solar radiation for several locations in the arctic. For comparison, it needs to be pointed out that the maximum intensity of solar radiation observed on the globe (in the Sahara) equals 1.58 g-cal/cm²/min.

Table 9 demonstrates conspicuously the magnitude of the intensity of solar radiation in the arctic during summer. At the same altitude of the sun, it is, for instance, considerably higher on Franz Joseph Land (in Bukhta Tikhaya) than in Slutsk and Tashrent.

On the average, however, the radiation in the arctic is, understandably, considerably less intense than at more southern latitudes. Thus, if the yearly amount of solar radiation on Franz Joseph Land, reduced to perpendicular surface, equals about 46,000 cal/cm², on Moscow it will be about 104,000 cal/cm², on Tashrent about 177,000 cal/cm².

The solar energy, passing through the atmosphere, is partly absorbed, partly diffused. Part of the absorbed energy reaches the earth's surface in the form of long-wave radiation, without cessation during the night.

The diffused radiation is the consequence of the scattering of solar energy by air molecules and water vapor and by extraneous ingredients, such as dust particles and water droplets suspended in the air.

It is understandable that during complete cloudiness and during the twilight only the diffuse solar radiation is available. Hence, it follows that in the arctic, where the sun's elevation is limited and where clouds and fog prevail, the diffuse radiation is of especial significance.

Table 10, which is based on data by Kalitin, lists the maximum diurnal sums of intensity of diffuse solar radiation for various points in the arctic.

In arctic areas, the diffuse radiation is considerably more intense than in more southern latitudes. Thus, in Slutsk, where the diffuse radiation had been continually recorded for 9 years, the intensity of diffuse radiation did not exceed 0.59 cal/cm² min, while in the arctic, the individual measurements reached 1 cal/cm² min. Hence, the diurnal sums of diffuse radiation in the arctic exceeded by almost twice the sum for the more southern latitude.

TABLE 10. MAXIMUM DIURNAL HEAT SUMS OF DIFFUSE RADIATION OF THE ATMOSPHERE (G-CAL/CM²)

Points	Year	Month	Sum
Bukhta Tikhaya	1934	June	545
Matochkin Shar	1933	May	566
Ostrov Uyedineniya	1935	May	642
Mastyr	1933	May	583
Bukhta Tiksi	1933	May	493
Mys Shmidta	1936	May	604
Slutsk	1928	April	276
Odessa	1935	March	308

According to observations, the greatest magnitudes of intensity of the diffuse radiation in arctic regions occur with thin layer of low clouds attended by a light snowfall or mild snowstorm.* Such conditions are frequently observed in arctic regions.

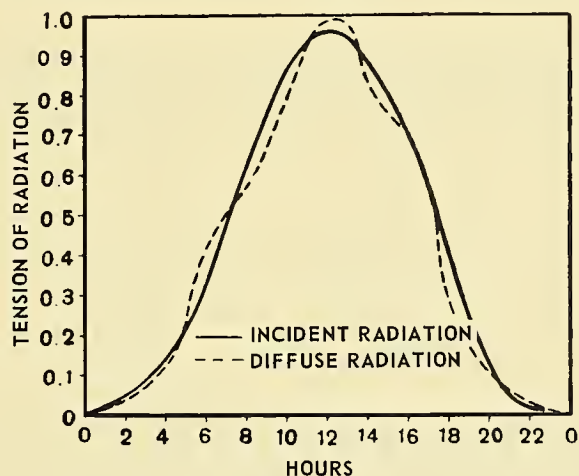

Figure 3. Intensity of incident and diffuse radiation at Mys Shmidta.

In figure 3 is presented the diurnal variation of incident (continuous line) radiation on 4 June 1936, and of diffuse (broken line) radiation on 31 May of the same year (after observations by Kuznetsov) at Mys Shmidta in the Chuckchee Sea. The sun's inclination varied from 31 May to 4 June by only half a degree, so that the sun's elevation can practically be considered as constant. It follows from examination of the figure that the magnitudes of the diffuse and incident radiations are practically equal, but that at noon the quantity of diffuse radiation was even greater than that of the incident radiation.

*These conditions are characterized by the greatest illumination.

The cumulative, or total, radiation consists of incident and diffuse radiations.

As was established, during twilight and under conditions of dense clouds only diffuse radiation is available; at other times the cumulative radiation takes place.

In certain regions and in certain seasons the diffuse radiation is considerably more intense than the incident radiation; in others the situation is reversed. Thus, at Slutsk in the "grayest" month, December, the incident radiation makes up only 22 per cent of the total radiation; in the sunniest month, July, the incident radiation makes up 68 per cent.

TABLE 11. MONTHLY SUMS OF CUMULATIVE RADIATION (G-CAL/CM²)

Points	Years	April	May	June	July
Bukhta Tikhaya . . .	1934	7,850	14,870	16,080	9,720
Slutsk	1923-1933	8,860	11,750	12,290	12,350
Feodossiya	1926-1930	10,700	15,340	15,240	16,350

In table 11, according to Kalitin, are presented the monthly sums of cumulative radiation for Bukhta Tikhaya, Slutsk and Feodossiya. It is seen from the table that in June, for instance, the cumulative solar radiation in Bukhta Tikhaya is 31 per cent greater than at Slutsk and 8 per cent greater than at Feodossiya.*

TABLE 12. HEAT SUMS OF THE CUMULATIVE RADIATION IN THE SEAS OF THE SOVIET ARCTIC (G-CAL/CM²)

Sea	In Year	In Summer	Ice in cm
Kara	60,000	37,000	830
Laptev	67,000	39,000	930
East Siberian . . .	80,000	45,000	1,110
Chuckchee	81,000	45,000	1,120

In table 12 are presented averaged data by Chernigovskiy who calculated the mean influx of the cumulative solar energy for the seas of the Soviet Arctic, per year and summer months (May, June, July). In the last column is shown the ice thickness in cm which could be melted by this amount of heat if all of it were used for the melting of ice.

This is a very representative table because it discloses the fact that in the arctic the ice regime is determined mainly by the portion of radiation which is actually absorbed by the surface of ice and water and not so much by the amount of solar radiation that reaches the surface.

LITERATURE: 62, 77, 81, 82, 138.

*This is confirmed by the fact that in 1932 the maximum (diurnal) value of the cumulative solar radiation on the South Crimean Coast was 450 g-cal/cm². During the cruise in the *Sadko* at the end of August 1935 along the north coast of Spitsbergen, the cumulative solar radiation also reached 450 g-cal/cm³ per day according to Vl. A. Verezkin.

Section 14. Reradiation

The ocean surface heated by the sun's radiant energy is, in turn, radiating the heat energy back into the atmosphere. This phenomenon is called reradiation (or back radiation).

The reradiation depends on the physical properties of the surface and its temperature. Rough surfaces reradiate most intensely, white and glossy surfaces with lowest intensity.

According to Stefan-Boltzmann, the reradiation for an absolutely black surface equals

$$E = \sigma (273 + t)^4,$$

in which E = reradiation in g-cal/cm² min,

t = surface temperature,

σ = reradiation coefficient equalling $8.35 \cdot 10^{-12}$ g-cal/cm² min.

Calculations based on this formula should be considered the extreme case because the reradiation coefficient of all surfaces of the earth is smaller than that of an absolutely black body. Thus, it is assumed that for black earth the reradiation coefficient equals 87 per cent, for yellow clay 85 per cent, for snow 75 per cent of the reradiation coefficient of a black body. The reradiation capability of water approaches that of an absolutely black body.

Because the temperature of the ocean (as well as that of any other surface of the globe) is relatively low, the ocean emits only long-wave rays, the wave-length exceeding 0.2 microns. This reradiation is most thoroughly absorbed by water vapors, and it is assumed that even on clear days the quantity of water vapor in atmosphere is sufficient for the absorption of as much as 90 per cent of the earth's reradiation.

The atmosphere, heated by the terrestrial reradiation, reradiates, in its turn, heat toward the earth's surface. The latter type of reradiation is called cross reradiation.

Here lies the "hot-bed effect" of the atmosphere; the atmosphere lets the light beams readily through, but detains the thermal reradiation, giving it off to the earth.

The difference between the terrestrial and cross reradiations is called the "effective reradiation."

More often than not, the sea temperature is higher than the air temperature, and the effective reradiation is negative, i.e., the sea loses heat. But in certain ocean areas, notably in the Arctic Basin, especially above the ice, the temperature of the air in summer at corresponding winds is considerably higher than the temperature of its underlying surface. This results in a positive, effective reradiation which warms the sea surface.

We have seen that in the arctic, the high values of the intensity of incident solar radiation is caused by the very small absolute moisture content and the small amount of dust in the atmosphere. But the same causes lead to extremely great values of terrestrial reradiation at a cloudless sky and, as a consequence, intense cooling of the sea surface.

LITERATURE: 62, 81.

Section 15. Evaporation and Condensation

At the interface between the air and water, or between air and ice, the water molecules are constantly transformed from liquid or solid phase into gaseous phase and vice versa.

If the number of molecules transmitting into the gaseous phase is greater than the number of molecules transmitting, simultaneously, into the liquid or solid phases, we have evaporation. Otherwise we have condensation.

It was stated that the further from the state of saturation the atmosphere contiguous to the water surface, the greater is the speed of evaporation. Analogously, the more saturated the atmosphere with water vapor, the greater is the speed of condensation. Both evaporation and condensation are intensified by wind, because new air masses are involved in the process.

The air over the sea is almost always in motion. The wind brings air masses of various temperatures and moisture contents over ocean areas with various surface temperatures, and the air masses are now heated, now cooled. In the first case, the moisture deficit will increase and evaporation will be intensified; in the second case, on the contrary, the deficit will decrease and the condensation and the formation of fog will be intensified. The greater the difference between the temperatures of the surface layers of the sea, the more clearly are the mentioned phenomena pronounced.

The areas where the cold and warm sea currents come into contact are characterized by intensified evaporation at winds blowing from the cold current toward the warm current, by intense condensation and fog* at winds blowing from the warm sea toward the cold current.

These phenomena become still more typical in areas covered by the arctic ice where alternate the underlying surfaces of ice and water, the temperatures of which are different. When navigating in scattered to broken ice at weak winds, now clearing, now fogging replace each other in connection with smaller or greater amounts of ice encountered.

A similar alternate clearing and fogging with weak winds is also observed in the fog of an ice-free sea, but the origin of this phenomenon is different. The point is that the sea fog, generally, does not propagate high above the sea surface. Owing to the differences of wind speeds above the fog, waves are formed on the surface of the fog that are completely identical to the Helmholtz waves observed at the lower and upper surfaces of clouds. Naturally, a rarefaction of clouds is observed at the base of these waves and a compaction of clouds at the crest. It is also natural that the crests of these fog waves are located approximately in a direction perpendicular to the wind. Intense intermixing occurring at strong winds eliminates this phenomenon.

The evaporation and condensation processes continue at very low air temperatures; however, the absolute moisture is, in this case, so small that only a slight mist, and not fog, is formed at cooling and condensation.

*The greatest producer of fog is the cold Labrador current in the area where it comes in contact with the warm waters of the gulf stream. In this respect is also known the area of Bear Island where the water of the cold Bear Island current comes in contact with the warm water of the Spitsbergen and Nordkapp currents.

The evaporation and condensation resulting from contact between very cold air and relatively warm sea surface are no less typical phenomena. In arctic conditions, the fog blanket curls over individual spaces and cracks in the ice at low temperatures, the curling being reminiscent of steam over a plate of hot soup. This is explained by the fact that water vapor rising from the sea surface becomes intermixed with the contiguous cold air and is condensed into clouds of fog which gradually dispenses.

According to Mitchell and Albers, for the formation of winter fog it is necessary that air temperature be 10.6° below the temperature of fresh water and 14.40° below the temperature of sea water. In winter, however, the temperature difference in the arctic reaches 40° .

A stable winter fog can occur only under certain conditions. It is necessary for the extremely cold air to be covered above by warmer air (temperature inversion), which limits convection. In such a case, slight evaporation causes supersaturation. But the simultaneous heating may be insufficient for the formation of convective currents. Therefore, the formation of winter fog in the sea can take place only over ice or intensely cooled land* — from which masses of very cold air may reach the sea.

Such fog formations during severe frosts are observed not only over spaces and cracks in sea ice but also over thin ice. In open portions of the sea, only summer fog is possible. This, in contrast to the winter fog, is formed only over a colder sea surface or over ice.

The unstable winter fog, as a result of strong convective currents formed over warmer surfaces, induces intense evaporation. The intense evaporation of snow and ice in arctic regions, and in winter also in temperate latitudes, is explained by the higher temperatures of the underlying surface in comparison to the air temperatures. Thus, the moisture deficit appears to be the main factor determining evaporation or condensation. The greater the moisture deficit, the more intense the evaporation. The temperature of the underlying surface and the air affect the evaporation also in indirect ways — namely, at high temperatures with the same quantity of water vapor in the air, the moisture deficit increases. Of the greatest significance in this respect is the rise of temperature of the underlying surface, which causes, in addition to an increase in the moisture deficit, the formation of convective currents which take away the particles of evaporating water from the surface. The latter aspect is of very great importance. Indeed, the evaporation is accompanied by almost momentous formation of a thin saturated air stratum at the sea surface, which is slightly cooled and therefore, despite the fact that the density of water vapor makes up only about 0.6 of the density of the air (this circumstance is not accounted for in the present theories on evaporation), it obstructs further evaporation. Convection eliminates this stratum, but because the wind is of still greater significance, the evaporation is always intensified with the intensification of wind.

Reaching a certain force, the wind gains in the sea special significance for evaporation. Indeed, as soon as the wind starts tearing off the crests of waves, minute particles of water are thrown into the air, which, by means of turbulent air movement, are raised to the layers that are less saturated with moisture and evaporate. The salt crystals are carried into the atmosphere and, owing to their hygroscopicity, become excellent condensational nuclei for the formation of clouds and fog.

*The Gulfs of Finland and Bothnia of the Baltic Sea and the White Sea, due to their small sizes in comparison to the sizes of the adjacent land masses, are typified by their winter fog. Here it sometimes happens that in winter very cold air masses reach the sea from the land and each influx of these air masses involves the formation of fog or foggy smoke.

As we shall later see, a certain amount of salt enters the atmosphere as a result of the freezing process when ice crystals are separated and blown off the surface of sea ice.

The evaporation is especially complicated by the processes that accompany the phenomenon, and therefore, not only are theoretical investigations of it extremely difficult, but also direct measurements. Indeed, it is impossible to construct instruments which would completely repeat the natural conditions. This explains, among other things, the numerous empirical formulae suggested for evaporation and the diverse calculation of results based on them.

LITERATURE: 62, 77, 108.

Section 16. Evaporation of Snow

In table 13 are presented data calculated by Schaffernak for the evaporation of snow and water; the calculation was carried out in 1914 in Munchen in similar climatic conditions. The evaporation of water and snow is expressed in millimeters of water column. It is seen from the table that the evaporation of snow is more than twice greater than that of water.

TABLE 13. EVAPORATION OF SNOW AND WATER IN IDENTICAL CLIMATIC CONDITIONS IN JANUARY 1914 (EVAPORATION IN MM OF WATER COLUMN)

Date	Thickness of Snow in mm	Density of Snow	Evaporation of Snow/of Water	
11	215	0.267	—	—
12	215	0.267	0.0	0.3
13	205	0.297	1.8	0.1
14	190	0.300	1.6	0.5
15	190	0.290	1.7	0.6
16	175	0.260	2.2	0.6
17	140	0.306	0.9	0.6
18	110	0.258	2.9	0.8
18	30	0.350	1.1	0.3
19	Traces	—	0.3	0.8
Totals			12.5	4.6

It is evident that snow evaporates in any season of the year when its temperature, for one or another reason, is higher than the temperature of the air stratum contiguous to it. A moisture deficit and convection are then created in the air that is heated by snow, which leads to evaporation. This is, as always, intensified by wind. The evaporation reaches high values when thaw or a sharp rise of snow temperature is followed by cold weather and the air is little saturated with moisture. In such cases, the radiational fog resulting from intense evaporation is frequent. It is evident that evaporation diminishes as the surface of snow is cooled by evaporation, convection and reradiation.

The evaporation of snow is of special significance in spring and summer during stabilized anticyclonic weather. Despite its high albedo, snow is continually heated by incident and diffuse solar radiation, through which the temperature difference needed for evaporation is preserved. At night, with the cessation of solar radiation, the evaporation ceases. Before the sunrise, such cases, especially in calm weather, are characterized by using radiational fog which may sometimes completely disappear during the day.

LITERATURE: 62, 77, 140.

Section 17. The Effect of Evaporation and Condensation on Sea Temperature

Evaporation is accompanied by an increase in salinity and a drop in temperature of the sea surface. Condensation is accompanied by dilution and a rise of temperature.*

It is evident that the role of evaporation and condensation in the heat balance is considerably increased if it is associated with individual areas. Especially for the arctic the processes are of paramount significance.

In this connection it is necessary to examine at the beginning the local processes of evaporation and condensation, i. e., the processes occurring without heat exchange with the adjacent areas. It was stated above that equilibrium cannot exist in areas where the water and ice come in contact. Evaporation prevails all the time above the water, and condensation above the ice. In consequence, fog is found more frequently over areas of scattered ice and here the fog is denser than over areas with open water or over concentrated ice. The local evaporation and condensation further, evidently, the cooling and heating of the sea and the destruction and melting of ice, but the amount of heat is not changed. The advective heat brought into the arctic from the adjacent land and sea areas is of great significance in this respect.

Indeed, when warm and moist air is brought into the cold arctic areas, notably in areas that are covered by ice, large quantities of heat which have been accumulated in lower latitudes at evaporation are liberated in the process of condensation.

The statement can be confirmed by the following example. In order to cool 1 m³ of air saturated with moisture, the initial temperature of which was 10° to 0°, it is necessary to obtain 5,850 g-cal from the air, which suffices to diminish the thickness of 1 m² of ice by more than 1/2 cm.

It is evident that the warmer and moister the air, and the stronger the wind, the more intense is the heating of the sea and the melting of ice.

If the qualitative aspect of the influence of evaporation and condensation on the regimen of the arctic is indubitable, then the quantitative calculations can hardly be carried out at the present time, first, due to the absence of sufficiently dependable formulae and, secondly, due to the absence of pertinent observations in open portions of the sea.

Personally, I assume that the following formula can be used for an approximate evaluation of evaporation in the sea.**

$$E = 0.1 (e_w - e_z) w,$$

where E = evaporation in 24 hours expressed in mm,

*The change of salinity caused by evaporation is considerable in certain sea areas, for instance, in the Mediterranean and Black Seas. However, the effect of these changes can in no way be compared to the heat value of evaporation and condensation for the regime of the World Ocean and for the climate of the earth.

**This formula was derived by a rough simplification of the theoretical formula by Sverdrup and by a few calculations.

e_w = pressure of saturated water vapor in mc calculated for the surface temperature and salinity of the ocean,

e_z = pressure of water vapor in mc observed at a height of 6 m above the sea surface,

w = wind speed in m/sec reduced to 6 m above the sea surface.

It is evident that this formula can be adapted for the calculation of heat loss by the sea to evaporation — namely,

$$Q = -6.1(e_w - e_z)w,$$

where Q is expressed in g-cal and calculated for 1 cm² of surface per day.

When using these formulae, the greatest difficulties are encountered in the computation of e_z value. Indeed, the wind speed can with certain approximation be determined by means of synoptic charts. The temperature of the sea surface changes so slowly that in the areas where regular oceanographic observations are conducted it can be forecast rather accurately. However, the e_z value varies all the time depending on the air masses that move above the sea at the given moment.

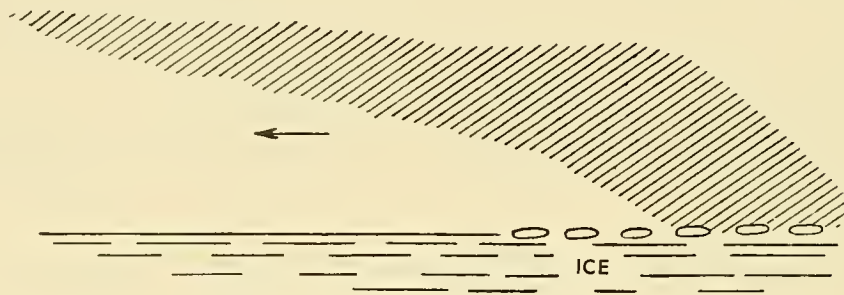

Figure 4. A scheme of fog with wind blowing from ice edge.

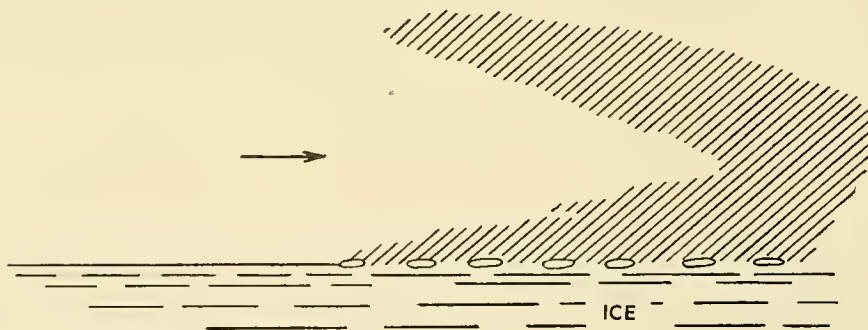

Figure 5. A scheme of fog over the Caspian Sea on 31 May 1939.

The observations by coastal hydrometeoro-logical stations pertaining to the given area can be significant only when small water basins are investigated. A few examples from any experiences can clearly illustrate the statement.

It was said that a belt of relatively scattered ice constitutes an area with frequently occurring fog. Figure 4 presents schematically the situation of fog over the Barents Sea at weak wind blowing from scattered ice edges. It is seen from the scheme that the fog, lying tight on the ice, is gradually rising as it moves away from the ice edges, and that, at a sufficient distance from the ice, the fog turns into cloudiness. Figure 5 also schematically presents a vertical cross section of atmosphere based on my observations during the flight with Vodopyanoo over the Kara Sea on 31 May 1939. During the flight it seemed that the aircraft entered the open mouth of a gigantic monster. The phenomenon was attended by a weak wind from the open sea toward the ice edge.

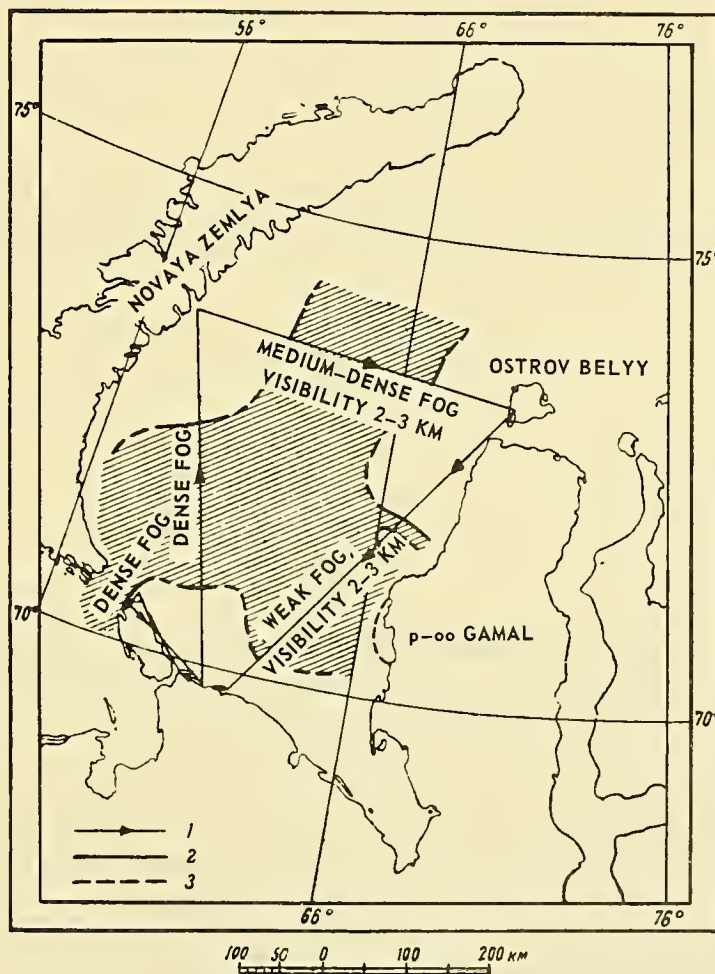

Figure 6. Distribution of fog over the southwestern part of the Kara Sea on 31 May 1939.

In figure 6 is schematically presented the distribution of fog on the same day over the southwestern part of the Kara Sea. During our flight, all the coastal stations — namely, Amderma,

Gugorskiy Shar, Matochkin Shar, Mys Zhelaniya, Ostrov Bleyy and Marresale (Mare-Sale) — recorded a complete absence of cloudiness and a good visibility, which we could confirm. However, at the same time, fog was hanging over the central portion of the Kara Sea, extending to the boundary of ice and compelling us to fly at a height of 50 to 100 m over the ice in order to be able to see it.

If the most intense condensation in the arctic seas is observed when winds are blowing from large ice-free sections of the sea, the most intense evaporation is observed when winds are coming from icy areas. The cold, and therefore almost moistless, air masses travelling over the open sea, are warmed and consequently soak up moisture.

LITERATURE: 62, 77, 176

Section 18. Convection

If the temperature of the underlying surface is higher than the temperature of the air, the air particles continually heated at this surface rise and are replaced by colder particles; thus, convection is created which causes cooling of the sea.

Kuzmin derived the theoretical formula* defining the heat loss by the sea due to convection in the air on the condition that the sea temperature is higher than the air temperature. If the air temperature and wind speed are measured at a height of 6 m above the sea level, the formula has, for average conditions, the following form:

$$W_k = \frac{5(t_w - t_a)w}{0.5 + 0.1w} \text{ g cal/cm}^2 \text{ per day}$$

In this formula

w = wind speed in m/sec,

t_w = water temperature,

t_a = air temperature.

In nature, convection in its pure form is observed only under unusual conditions. Usually the phenomenon is closely linked with evaporation, because the heating of the air always means an increase in the moisture deficit. This phenomenon is intensified by the above mentioned fact that the density of water vapor at 0° equals 0.6 of the density of the air.

LITERATURE: 92.

Section 19. Effect of the Sea on the Air Temperature

As was observed during the *Challenger* expedition, the difference between the air and water temperatures (at the height of ship's bridge) can reach a considerable magnitude only near the coast or near ice. In the open sea the difference, however, fluctuates within the limits of $\pm 2^\circ$,

*The derivation and form of the Kuzmin formula is reminiscent of the Sverdrup formula defining the speed of evaporation. It contains the difference between the air and water temperatures. This difference may reach a considerable value only near the coast or ice; in open sea it is, however, very small.

whereby, during the periods characterized by the warming of sea and over cold currents, the air temperature is somewhat higher. During periods characterized by cooling of the sea and over warm currents the air temperature is somewhat below the temperature of sea surface.

On the basis of 340 simultaneous observations of sea surface temperature and of air temperatures (12 m above the sea level), which were carried out during the *Sadko* expedition in 1935 in Greenland, Barents and Kara Seas, I plotted a graph (figure 7) on the horizontal axis of which are laid off differences between the water and air temperatures, and on the vertical axis the number of observations. In 193 cases the difference fluctuated from -2° to $+2^{\circ}$. In 104 cases, the deviation from 0° did not exceed 0.5° .

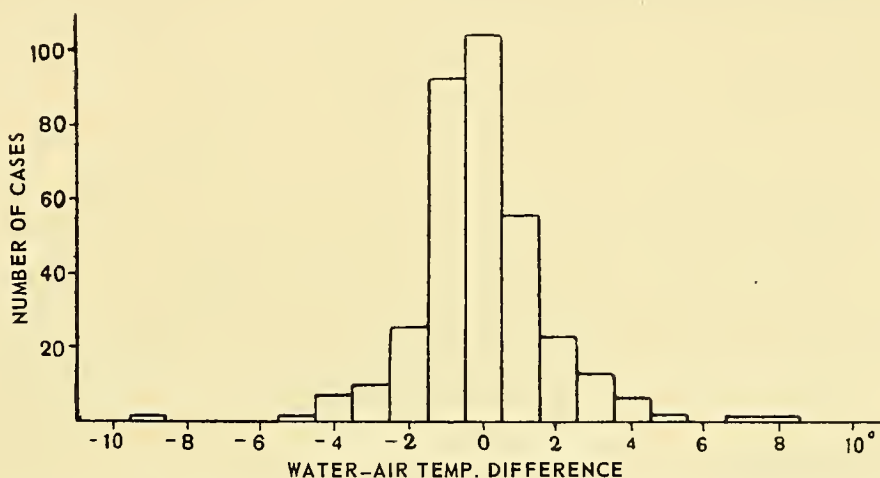

Figure 7. Differences between the water and air temperatures in August and September 1935 in the Barents, Greenland and Kara Seas.

Cases when the air was considerably warmer than the water occurred when navigating along the coast during offshore winds. Thus, the difference $t_w - t_a = -9^{\circ}$ was observed 15 miles to the north of Nordkapp. Cases when the air was considerably colder than the water occurred when navigating along the edge of concentrated ice during winds blowing from the direction of the ice.

These examples characterize with sufficient clarity the effect exercised by the temperature of sea surface on the temperature of the contiguous air strata, the effect being felt in brief intervals and at small distances from areas where the temperature difference is great. This circumstance, as well as the fact that the sea temperature remains almost unchanged during these brief time intervals (which is explained by a great difference between the heat capacity of the air and that of the water) enables us, despite all the complicity of the problem, to arrive at approximate solutions that characterize the gradual change of air temperature over the sea.

Assume that the sea is warmer than the air and that the temperature of the sea surface changes so little during a given time interval that it can, to a first approximation, be considered as constant.

The quantity of heat transferred through area F in time dT by the sea to the atmosphere equals

$$dQ = F(t_w - t_a)k dT, \quad (1)$$

where t_{w_0} = temperature of sea surface during the given time interval,

t_a = air temperature at a given moment (more precisely, the temperature of the active stratum of atmosphere),

T = time,

K = coefficient of heat transfer, i.e., the amount of heat transferred through a unit surface of sea to the atmosphere in unit time at a temperature difference equaling 1° .

On the other hand, in consequence of heat transfer by the sea, the heat content of the atmosphere will increase according to the following formula:

$$dQ = H_a F c_a \delta_a dt_a, \quad (2)$$

in which H_a = the height of the active stratum of atmosphere,

c_a = the heat capacity of the air,

δ_a = the density of the air.

Equating (1) to (2), we have

$$dT = \frac{H_a c_a \delta_a F}{k F (t_{w_0} - t_a)} dt_a. \quad (3)$$

Assuming for brevity that

$$\frac{k}{H_a c_a \delta_a} = A, \\ t_{w_0} - t_a = y, \quad dy = -dt_a,$$

we have, on the basis of formula (3)

$$-AdT = \frac{dy}{y}.$$

Integrating it, we have

$$-AT = \ln y \Big|_{t_{a_0}}^{t_a} = \ln (t_{w_0} - t_a) \Big|_{t_{a_0}}^{t_a}$$

or

$$-AT = \ln \frac{t_{w_0} - t_a}{t_{w_0} - t_{a_0}}. \quad (4)$$

From which

$$t_a = t_{w_0} - (t_{w_0} - t_{a_0}) e^{-AT}. \quad (5)$$

Figure 8 presents schematically (the lower curve) the temperature variations with time in the active layer of atmosphere which are affected by the warm sea. Temperature values are laid off on the vertical axis, time values on the horizontal axis. It is seen from the figure how, with time, the air temperature approaches the temperature of the sea surface.

Formula (5), derived by me, is an approximation. It is delimited by the time interval during which the temperature of sea surface can be considered as constant; in addition it accounts only for the convective air intermixing.

It is evident that if the heat transfer by the sea to the atmosphere occurs with wind, not only will convective but also frictional intermixing take place. This fact makes it possible to enlarge the application of formula (5) also to the case when the sea is colder than the air. Indeed, in this case the heat transfer is materialized by frictional intermixing, though convection is absent.

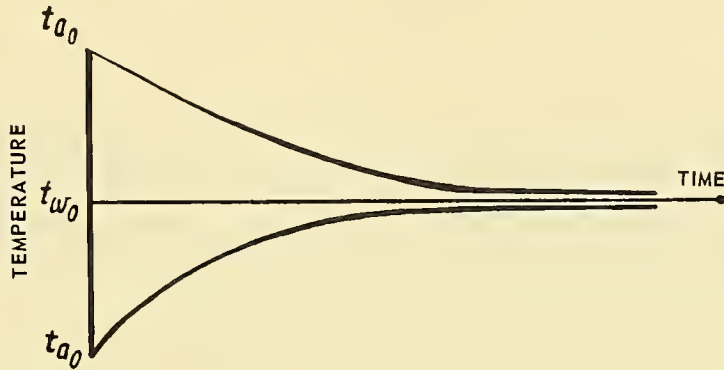

Figure 8. The change of temperature of the active layer of the atmosphere with the wind moving toward the warmer or the colder sea.

The curves in figure 8 demonstrate a gradual approach of air temperature to the temperature of the sea surface. The rate of this approach increases with a decrease in the height of the active layer of the atmosphere and with increase in the wind speed. The rate of this approach is greater for a cold wind than for a warm wind.

For utilization of formulae (4) and (5), it is necessary to know the wind speed, the temperatures of sea surface and air at the initial point, and coefficient A . In order to determine this coefficient, it is necessary to know, (in addition to the temperature of the sea surface and the air at the initial point, and wind speed and direction), the air temperature at at least one point upwind from the initial point. On the basis of formula (4) we have:

$$A = -\frac{w}{d} \ln \frac{t_{w_0} - t_a}{t_{w_0} - t_{a_0}}, \quad (6)$$

where d = the distance to the point, at which the air temperature equals t_a , from the point at which the initial temperatures of the sea surface and the air are measured,

w = wind speed.

It should be underlined that on the basis of the meaning of the derivation of formula (6) one must assume that temperatures t_{a_0} , t_a and t_w are the mean temperatures of the active layers of the sea and atmosphere. For the use of temperatures of sea surface and the air at the height of the observer, one must assume that the latter temperatures are proportional to the mean temperatures of the active layers.

In table 14 are shown, for the sake of illustration, the computed results of some of the observations carried out in the White Sea.

TABLE 14. THE MEASUREMENT OF AIR TEMPERATURE OVER THE SEA

Date	Wind Direction	Wind Speed In Knots	Distance In Miles	t_{w_0}	t_{a_0}	t_a	A
7/x 1941	*Unskiý-Mudyug	12	43	5°	1°	7°	0.27
14/x 1941	Kuzamen-Zhizhgin	17	65	4°	-9°	-2°	1.04

LITERATURE: 77.

Section 20. The Effect of Atmosphere on Sea Temperature

We saw that, due to great differences in heat capacities and densities of water and air, the air temperature very rapidly approaches the temperature of the sea surface as the air moves over the sea, whereby the water temperature remains almost unchanged.

Under certain conditions we can observe a reverse situation — namely, a relatively rapid variation with time of the sea temperature and an almost unchanged air temperature. The latter can take place only with a wind that is continually bringing to the sea new air masses of the same temperature. Here can be two cases:

1. the air is warmer than the water; only frictional intermixing is created in the atmosphere and in the sea; the intermixing being more intense as the wind is stronger and the temperature difference is smaller;

2. the air is colder than the water; the frictional intermixing is created in the atmosphere and in the sea; the intermixing being more intense as the wind is stronger, and the convective intermixing being more intense, as the temperature difference is greater.

By the same reasoning as used in the preceding paragraphs, we can assume that the amount of heat passing through an area, F , of the sea surface in time interval dT equals

$$dQ = k F (t_w - t_a) dT. \quad (1)$$

On the other hand, the amount of heat in the active layer of the sea will, during the same interval, become

$$dQ = H_w F c_w \delta_w dt_w, \quad (2)$$

where H_w = the thickness of the active layer of the sea,

c_w = heat capacity of water,

δ_w = density of water.

By equating them, we have

$$dT = \frac{H_w F c_w \delta_w}{k F (t_w - t_a)} dt_w. \quad (3)$$

*Not listed in NIS Gazatteer - Translator.

After integration and elimination of logarithms, we arrive at formula

$$t_w = t_{a_0} + (t_{w_0} - t_{a_0}) e^{-TB}, \quad (4)$$

in which

$$B = \frac{k}{H_w c_w \delta_w}.$$

If in figure 8, the air temperature (t_a) is replaced by the water temperature (t_w), and vice versa, we have a schematic presentation of a gradual approximation of the temperature of water to that of the continually arriving air. The upper curve characterizes the case when the water temperature is higher than the air temperature. The lower curve characterizes the case when the water temperature is lower than the air temperature. In summer, the offshore winds correspond to the lower curve. In winter, the offshore winds correspond to the upper curve. Winds coming from icy areas and passing across open water correspond to the upper curve in winter as well as in summer. It is evident that the upper curve characterized both convectional and frictional variations of sea temperature, while the lower curve only the frictional variations.

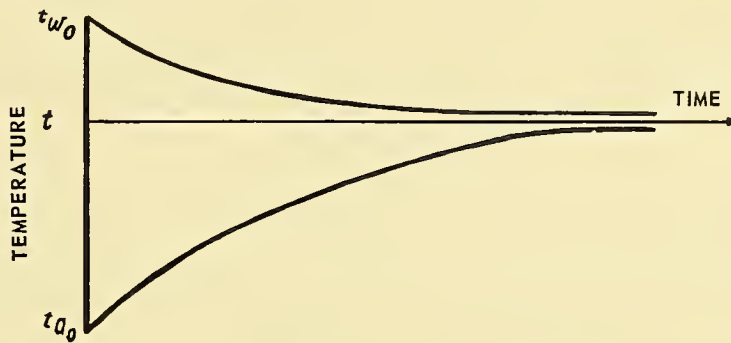

Figure 9. The variation of temperature of a warmer sea and of the air at various distances from the coast.

Figure 9 schematically presents the variation of sea temperatures at various distances from a windward coast for the case of a colder wind. Simultaneously, a gradual but a more significant variation of air temperature is shown in the figure. At a certain distance from the coast, these temperatures become almost equalized, approaching a certain temperature, t .

Because the amount of heat received by the atmosphere equals the amount of heat given off during the same time by the sea, we can write that,

$$H_w c_w \delta_w dt_w = H_a c_a \delta_a dt_a, \quad (5)$$

where the subscript a denotes atmosphere and w pertains to the sea.

On the basis of formula (5), we have

$$\frac{dt_a}{dt_w} = \frac{H_w c_w \delta_w}{H_a c_a \delta_a}. \quad (6)$$

If t is the temperature approached simultaneously by the temperature of the sea and atmosphere, it is obvious that

$$t = t_{w_0} - \Delta t_w = t_{a_0} + \Delta t_a. \quad (7)$$

On the basis of formula (6) we have

$$\Delta t_a = \Delta t_w \frac{H_w c_w \delta_w}{H_a c_a \delta_a},$$

whence, by the use of formula (7), we arrive at

$$t_{w_0} - t_{a_0} = \Delta t_w + \Delta t_w \frac{H_w c_w \delta_w}{H_a c_a \delta_a},$$

$$\Delta t_w = \frac{t_{w_0} - t_{a_0}}{1 + \frac{H_w c_w \delta_w}{H_a c_a \delta_a}}$$

and

$$t = t_{w_0} - \frac{t_{w_0} - t_{a_0}}{1 + \frac{H_w c_w \delta_w}{H_a c_a \delta_a}}. \quad (8)$$

In analogy we find that

$$t = t_{a_0} + \frac{t_{w_0} - t_{a_0}}{1 + \frac{H_a c_a \delta_a}{H_w c_w \delta_w}}. \quad (9)$$

Assuming that, approximately,

$$\delta_w = 1.0, \quad c_w = 1.0, \quad \delta_a = 0.0013 \text{ and } c_a = 0.24,$$

we have

$$t = t_{w_0} - \frac{(t_{w_0} - t_{a_0}) 0.0003 H_a}{H_w + 0.0003 H_a}, \quad (10)$$

$$t = t_{a_0} + \frac{(t_{w_0} - t_{a_0}) H_w}{H_w + 0.0003 H_a}. \quad (11)$$

Assume that the height of the active layer of the atmosphere equals approximately 3,000 m, the depth of the active layer of the sea is about 30 m, the initial air temperature is -10° and the initial water temperature is $+2^\circ$. On the basis of formulae (10) and (11) we have

$$t = +1^\circ.6.$$

If the coefficient B in formula (4) is known, it is possible to determine approximately the time interval during which the sea temperature would, under the influence of cold wind, drop to any given temperature, e. g., to the freezing temperature.

It follows from formula (4) that if at the initial time moment the temperature of the sea surface is everywhere the same, it will change with time so that the change would be greater where the differences between the water and air temperatures are greater. This difference will be the greatest at the coast, no matter whether a colder or warmer offshore wind is blowing, and therefore, it is natural that even with all the other conditions being equal (equal depths, equal vertical distributions of temperature and salinity) the coastal water will be heated more rapidly by warm winds and will cool more rapidly with cold winds.

So far we have discussed only the variation of the temperatures of sea and atmosphere. However, the temperature difference is associated with more than the process of heat exchange in the restricted sense of the word. The temperature difference also affects the effective radiation, evaporation and condensation, and therefore, the derived formulae, appropriately modified, are applicable to these processes.

Of special significance is the case of a cold offshore wind. In consequence of the low temperature, the air contains only a small amount of water vapor. As the air leaves the coastline for the sea, the moisture deficit is great and the evaporation (and, consequently, the cooling of the sea) is intense. As the distance from the coast increases, the absolute moisture of the air gradually increases but, with it, the air temperature increases rapidly. Therefore, with distance from the coast, the moisture deficit either decreases slowly or may even increase to a degree. But since the speed of evaporation is directly proportional to the moisture deficit, the evaporation rate can, at a cold offshore wind, be considerable, even for out in the open sea.

LITERATURE: 77.

Section 21. The Effect of Ice on the Atmosphere

Ice has certain distinctive qualities in comparison with the sea and the land. The ice, like the sea, appears to be an inexhaustible source of moisture for the atmosphere. In winter, with negative air temperatures, the ice behaves like the land with respect to the atmosphere. The temperature of the upper surface of the ice determines the temperature of the contiguous air stratum, if the latter is measured in oceanological coordinates, i. e., if temperatures of the same air mass are determined. The temperature of the lower air strata is very near that of the upper surface of ice. In summer, with positive air temperatures, the air masses moving over the ice may be so well heated that the temperature of the upper surface of ice remains unchanged — near the thawing temperature.

In this connection, the seasonal changes of air temperature over the ice differ from the seasonal changes of temperatures over the open (not frozen) sea and over the continent. The seasonal march of temperature is illustrated in figure 10: 1 — over open sea (southwestern part of the Barents Sea), 2 — over the ice of the Kara Sea (Ostrov Myedineniya) and 3 — over the continent (Igarka).

Insofar as the temperatures of the sea and ice are always very low in the arctic, it very frequently happens that the air temperature increases with altitude (temperature inversion).

In winter during clear weather, when the back radiation is intense, the temperature of the upper surface of the ice can be below the temperature of the adjacent air strata by a few degrees, which is the winter inversion. In summer, the warm air moving over cold ice is cooled, and thus the summer inversion is formed.

In order to illustrate the phenomenon, I shall cite a few observations conducted by Kuzmin in August-September 1934 with regard to the air temperature regime in summer over the Imat Glacier* (basin in Zeravshan River).

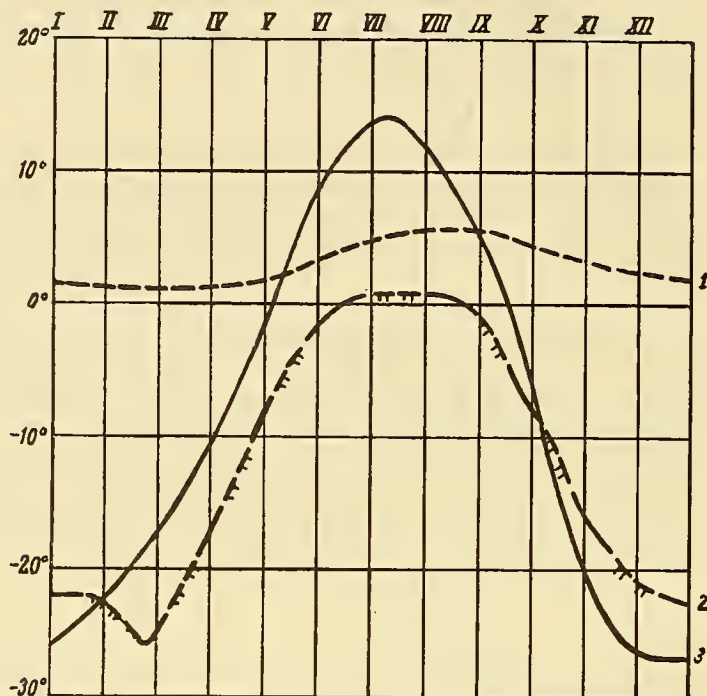

Figure 10. Graphs of the seasonal variation of air temperature: 1. over the open sea; 2. over the ice of the Kara Sea; 3. over the continent.

These observations disclosed that at the height of 200 cm above the ice level the air temperature was sometimes 4 or 5° higher than the air temperature at a height of 30 cm above the ice surface. The average temperature value for August at a height of 200 cm was 2.7° for the first ten-day period of September, 1.6° higher than the value at the height of 10 cm.

The absolute moisture at the height of 200 cm was in August 0.4 mm less than at the height of 10 cm; but in September 0.2 mm less. The relative moisture at the height of 200 cm was, for these months, 16 and 11 per cent lower than at the height of 10 cm whereas the moisture deficit at the height of 200 cm was approximately twice greater than at the height of 10 cm.

When analyzing his observations, Kuzmin remarks that over glaciers the air temperature in the day follows almost regularly the intensity of solar radiation, whereas over the sea and land, the air temperature maximum is delayed, because in these cases the air is heated from below. The temperature minimum is observed before sunrise. The maxima of absolute and relative moisture are usually observed after the sunset, and the minima before the sunrise. It is evident that the results of observations by Kuzmin cannot be completely transferred to the arctic ice fields, but they give an idea on the trends of these processes.

*Not listed in NIS Gazetteer. Possibly Lednik Zeravshanskiy. — Translator.

TABLE 15. THE DISTRIBUTION OF AIR TEMPERATURE OVER ICE
AT OSTROV CHETYRYEKLSTOLCOVOY ON JULY 1925

Height Over Ice in Meters	0.003	0.010	4.5	30
Temperature	3°.3	4°.6	5°.2	16°.8

The summer inversion was noted long ago in the arctic basins. The whalers had noticed then on the leeward side of icebergs the wind was much warmer than on the windward side. This is explained by the fact that, while passing over the icebergs, the warm air masses "curl" and descend toward the sea surface.

The most surprising example of the summer inversion is the distribution of air temperature over the ice at Ostrov Chetyreklstolcovoy, according to the *Maud* observations carried out in July 1925 during a southeasterly wind, (i. e., blowing from the heated coast) (table 15).

The conditions characterizing the possibility of formation of a strong summer inversion are well explained by the following examples.

At 0700 on 4 July 1943, the air temperature at Pevek was +22° with southwesterly winds, force 6, while at Mys Shelagskiy the temperature was +27° with southeasterly wind, force 6. At 1300 on 5 July 1943, the temperature in Bukhta Jiksi was +23° with a southwesterly wind, force 8. In these cases, the winds had been blowing from the shores to the ice-covered sea. It is natural that a clearly pronounced inversion could have been observed at some distance from the coast.

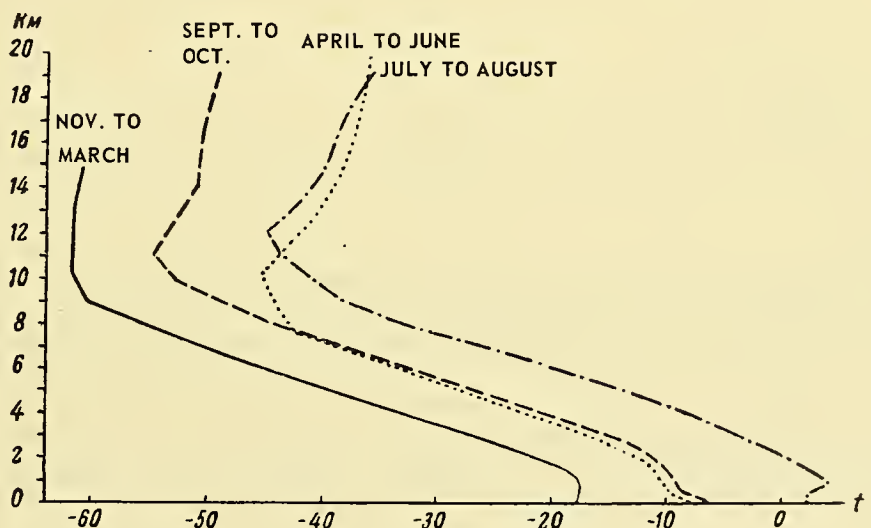

Figure 11. The vertical temperature distribution over Franz Joseph Land in various seasons.

In general, the summer inversion is usual and ubiquitous in the arctic. This is proven, for instance, by figure 11 taken from Guterman; the figure shows the vertical temperature distribution by seasons over Franz Joseph Land.

LITERATURE: 43, 77, 93, 175.

Section 22. The Cooling of the Sea

As we have seen, the cooling of the sea surface is brought about by three processes: radiation, convection and evaporation.

Other conditions being equal, the effective radiation is proportional to the difference of the fourth powers of the water and air temperatures. Convection is proportional to the water-air temperature difference and wind effect. Evaporation is proportional to the moisture deficit and wind effect. The moisture deficit is, in turn, a direct function of the water-air temperature difference. Thus, all of the three processes that cool the sea surface are directly proportional to the water-air temperature difference, but convection and evaporation are, in addition, proportional to wind speed.

On the whole it could be said that the cumulative speed of cooling of the sea and ice is directly proportional to the temperature difference and wind speed.

In order to investigate the effect of temperature difference and wind on the rate of cooling of water, Bodman carried out special observations during the Swedish Antarctic Expedition from 1901 to 1903. He measured the time needed for the cooling of water in an open container from 30° to 20° at various air temperatures and wind speeds, and presented the relationship by the following empirical formula:

$$C = (1 - 0.04 t^{\circ}) (1 + 0.27 w),$$

where t = air temperature,

w = wind celerity in m/sec,

c = coefficient of "severeness" of weather.

In table 16 are listed the values of "severeness" calculated by me for certain points of the Soviet Arctic.

In the marginal seas of the Soviet Arctic, especially in coastal areas, the air temperature is higher in summer and lower in winter than the water temperature. The time moment when the air and water temperatures become equal marks the beginning of winter cooling in the seas. However, the determination of the moment of temperature equalization—as well as the moment when the air temperature passes 0° for individual points on the earth's surface, the significance of which is not smaller for the cooling of the sea and the subsequent ice formation—is a very difficult task, which can be accomplished with an accuracy that is sufficient for practical purposes only by means of a multiannual cross section.

If, however, the conditions of individual years are examined, repeated air temperature transitions across the sea-air temperature equalization point and 0° are observed at each individual point of the sea, which is explained by continual shifts in synoptic processes.

In the latter relationship we have to take into consideration, first, the shift of natural synoptic periods, which continues in the arctic for approximately 7 days and determines the general character of the weather for this time period, and secondly, the passage of one or the other basic system across the given point.

TABLE 16. "SEVERNESS" OF WEATHER IN THE WESTERN SECTOR OF THE ARCTIC IN 1939

Points Month	Gugorskiy Shar	Mys Chelyuskin	Mys Zhelaniya	Ostrov Rudolfa	<i>Sedov</i>
January	5.58	5.71	6.28	7.15	5.48
February	5.12	4.41	5.01	5.79	4.91
March	4.40	6.88	5.83	7.04	5.44
April	5.02	4.02	7.53	6.26	5.01
May	3.87	3.17	3.52	3.33	4.19
June	2.72	2.99	3.61	2.29	3.21
July	2.26	2.26	1.96	1.65	2.21
August	1.83	2.78	2.57	2.26	2.43
September	2.22	3.18	3.80	3.74	3.78
October	3.18	4.33	3.95	4.18	4.56
November	3.45	5.92	5.01	4.67	5.04
December	3.78	5.67	5.18	4.52	5.63
For the Year	3.62	4.28	4.52	4.41	4.33

The latter is of the greatest practical interest also with respect to phenomena associated with the passage of basic systems. Therefore, it is necessary to outline the phenomenon by examining the simplest aspect of it.

Assume that a cyclone crosses the Kara Sea from west to east, following approximately the direction of the parallels (latitude). At all points located to the south of the line marked by the center of the cyclone the winds shift clockwise, approximately from southwesterly directions, over southerly and southwesterly, to westerly and northwesterly directions. The winds of the southern half of the horizon are attended by a decreased air temperature, cloudiness, fog and precipitation, which are especially typical before the warm front of a cyclone. In the rear of a cyclone, after the passage of cold front in connection with the shift of winds to northwesterly and northerly, the weather abruptly changes and the air temperature sharply drops. Thus, in July, for instance, the wind blowing from easterly to southwesterly directions, inclusive, in the Gugorskiy Shar area are attended by positive deviations of air temperature from the mean value with maximum deviation occurring during southerly winds.

The winds blowing from westerly to northeasterly directions are attended by negative deviations with the maximum negative deviation during northerly winds. It stands to reason that the directions of the winds, which create these deviations, depend on the land contours, and on the presence and form of considerable water and ice areas in the vicinity. In any case, each passage of one or the other of the basic systems across a given point creates the alternation of increased and decreased air temperatures--peculiar warm and cold waves affecting the sea regime.

In connection with a gradual decrease in daylight and solar radiation in autumn, as well as in connection with a gradual cooling of adjacent sea and land areas, the warm and the cold waves become colder. At the beginning of autumn, the air temperature in the warm sector of the cyclone still remains higher than the water temperature. At the end of autumn, the temperature drops, so that the cooling of the sea is not interrupted even with the passage of the warm sector of the cyclone, but is only somewhat retarded.

In addition to the alternation of warm and cold waves, one must remember that each subsequent cyclone in each series of cyclones passes somewhat to the south of the preceding cyclone and that after the passage of the last cyclone of a given series a cold wave penetration occurs.

During the first natural synoptic period in the Kara Sea, which lasted from 1 to 9 October 1943, several centers of cyclones moved subsequently from the Barents Sea approximately along the longitude of Gugorskiy Shar; during the second period, from 10 to 17 October, the center of cyclone intersected the Kara Sea, moving in a southeasterly direction from Franz Joseph Land. During the third period, from 18 to 24 October, the center of a cyclone intersected the southern portion of the Kara Sea, moving in a southeasterly direction. During the fourth period, from 24 to 31 October, no center of any cyclone was observed in the Kara Sea.

As a result of such development of synoptic processes, winds blowing from the southwesterly quadrant were not observed on Ostrov Uyedineniya after October, 1943. After 19 October, easterly winds became established and air temperatures began to decrease rapidly. On 24 October, the first ice appeared and as early as 27 October the air temperature dropped to -14° .

Thus, the cooling of the sea always occurs by leaps. Each of the leaps is characterized by the duration and intensity of a cold wedge of air. In consequence, at a certain time the temperature of the upper water layers drops to the freezing point. The continuation of a given cold wave or the arrival of a new one, even if insignificant, appears to be sufficient for the beginning of ice formation.

The cooling of the sea surface to the freezing point is, however, determined not only by synoptic but also by oceanological conditions. Indeed, the rate of cooling of the sea is measured by the amount of calories given off to the atmosphere by a unit surface of the sea in a unit time. But this number of calories is not at all proportional to the decrease of temperature of the sea surface. As we shall see below, the amount of heat given by the sea to the atmosphere, at the same air temperature and initial temperature of sea surface, in order to lower the temperature of the latter to the freezing point can be extremely variable, even for areas lying very near each other. As a rule, the smaller the depth, the more abrupt is the lowering of the surface temperature.

If the surface layer is very thin and its salinity so low that, even when cooled to the freezing temperature, the density of the surface layer remains lower than the density of the underlying layers, radiation alone may suffice for the cooling of the surface layer to the freezing point and for subsequent ice formation, despite the high temperature of the subsurface water layers and high temperature of the air.

Thus, if the surface layer is thin and the water is sufficiently stratified, its cooling to the freezing temperature occurs at the greatest possible speed when the frost is severe, the sky is clear (intense reradiation) and the wind is absent.

The wind brings about a rapid drop in temperature of the surface layer to the freezing point only if its force is insufficient to intermix the surface layer with the warmer, lower layers. Otherwise, not only can the temperature of surface layer rise, but the ice that has been formed can be destroyed. With wind and low air temperatures, on the other hand, the cooling involves at once a large water mass; as soon as the freezing temperature is reached, ice formation begins at once in the entire layer that has been cooled.

LITERATURE: 62, 73, 77.

Section 23. Precipitation

Precipitation always dilutes, to a degree, the surface layers of the ocean. In the arctic, the amount of precipitation is so limited that it is practically of no significance.

TABLE 17. THE AMOUNT OF PRECIPITATION (IN MM) IN THE ARCTIC IN SUMMER

Points	June	July	August	September	Total	Number of Days with Precipitation
Gugorskiy Shar	20	26	35	34	115	58
Matochkin Shar	11	35	37	37	120	47
Mys Zhelariya	13	25	32	17	87	50
Bukhta Tikyaya	7	21	29	19	76	51
Ostrov Dikson (Diksona)	16	25	37	30	108	57
Bukhta Jiksi	14	43	21	21	99	47
Ostrov B. Lyakhovskiy	11	14	18	12	55	39
Mys Shmidta	9	21	45	20	95	?
Ostrov Vrangelya	14	23	23	16	76	39
Uelen	13	41	45	53	152	40
<i>Fram</i> (1894-1895)	3	18	3	1	25	70
<i>Sedov</i> (1939)	4	22	15	5	46	39

Table 17, based on data by Vize, lists the amount of precipitation in summer at certain points in the Soviet Arctic. The quantity of precipitation in solid form in winter is impossible to determine because of problems with instruments.*

The extremely small amount of precipitation listed in table 17, especially for arctic islands, is noteworthy.

The precipitation increases somewhat in autumn (October to November) but during the winter months (December to April), with prevailing clear weather and low temperature, it drops to minimum values.**

The same table lists the mean amounts of precipitation in 1894-1895, on the basis of the *Fram* observations, and in 1939, on the basis of the *Sedov* observations. We can see the small amount of precipitation in the central arctic in comparison to the amount in its marginal seas.

Another characteristic of the arctic is the great number of days with precipitation versus the small amount of precipitation. Drizzling rains and drizzles are the prevailing forms of precipitation in summer.

*First of all, the snow falling at low temperature in the form of minute particles is easily blown out of snow gages and, secondly, in strong snowstorms and blizzards, the snow is continuously transferred from one place to another, denuding the ice in one place and forming snowdrifts elsewhere.

** It should be noted that, generally, the coastal meteorological observations do not give an idea on the regime of precipitation, even in the adjacent parts of the ocean. Indeed, rising currents are formed with sea winds on leeward slopes of mountains, which, in connection with a drop in the temperature of air masses, induce the condensation of water vapor and precipitation, while at a small distance from the coast no precipitation takes place. I repeatedly observed this phenomenon when cruising along the north coast of Norway and Murman during northwesterly winds and along the west coast of Novaya Zemlya during southwesterly winds.

An additional characteristic of the arctic is precipitation in the form of snow and hail in summer, which can be expected any month of the year in all the seas of the Soviet Arctic. On the other hand, along the ice edges of the Greenland and Barents Seas, rain is possible even in the winter time. Thus, on 8 January 1940, the *Sedov* expedition reported rain at 80°45' north latitude and at latitude 2°28' east longitude.

Icy rain is only rarely observed in the arctic. Such rain was observed during the *Sadko* expedition at the end of August 1935 along the east coast of Franz Joseph Land.

As a rule, precipitation lowers the surface temperature of the World Ocean. Indeed, the temperature of precipitation is usually somewhat lower than the temperature of the air, and the latter is usually lower than the temperature of the sea. Cold currents and coastal areas of seas in summer and at offshore winds are exceptions to this rule.

Also, in this respect, the effect of the insignificant amount of precipitation in the liquid phase is limited in the arctic. The effect is more significant in regard to the precipitation occurring in the solid phase on the ice-free sea surface, or in the liquid phase on ice.

The liquid precipitation on snow or ice in spring and summer is characterized by its warming, radiational and mechanical effect.

The thermal effect lies in a certain increase of temperature or even in the melting of a certain amount of snow. It is not difficult to show that the thermal effect of even a heavy rainfall is insignificant.

The radiational effect lies in the lowering of the albedo of snow as a result of moistening. Thus, after a rainfall, the ability of snow to absorb radiation is considerably increased.

The mechanical effect lies in the fact that the rain drops, penetrating into the snow make it porous. In the consequence, the area of the snow surface that receives radiation is increased. In addition, part of the snow is washed out to sea.

The role of solid precipitation is determined by the following facts:

1. The solid precipitation on ice-free areas of water before the winter has set in lowers the surface temperature of the ocean, but if the temperature is near the freezing point, the solid precipitation accelerates ice formation.

In the latter case, a special type of ice--snow slush--can be formed if the snowfall is heavy.

2. Solid precipitation falling on ice in summer increases the albedo of the ice, thus retarding its melting.

LITERATURE: 34, 62, 77.

Section 24. Coastal Precipitation

The coastal precipitation on the seas of the Soviet Arctic has several characteristics:

1. More than half of the entire river influx is received by the Kara Sea, and the influx decreases toward the east.

TABLE 18. THE MEAN ANNUAL DISCHARGES (IN KM³) OF THE MAIN SIBERIAN RIVERS INTO THE ARCTIC BASIN ON THE BASIS OF DATA BY THE ARCTIC INSTITUTE

River	Discharge in km ³
Genisey	663
Ob'	583
Discharge of all rivers into the Kara Sea . . .	1583
Khatanga	70
Anabara	15
Olenek	37
Lena	506
Gana	40
Discharge of all rivers into the Laptev Sea . .	731
Indigirka	54
Alazeya	10
Kolyma	112
Discharge of rivers into the East Siberian Sea .	211
Discharge into the Kara, Laptev and East Siberian Seas	2,525

Table 18 shows the annual influx in km³, from the main Siberian rivers discharging into the Arctic Basin. It is seen from the table that the discharge of four rivers--Ob', Genisey, Lena and Kolyma--makes up more than 74 per cent of the entire continental runoff.

2. The rivers that discharge their waters into the seas of the Soviet Arctic flow in a south to north direction. Therefore, their waters heat the adjacent sea areas. The mean temperature of influx into the Kara Sea equals 6.0°, into the Laptev Sea 8.8°, into the East Siberian Sea 8.3°.

3. Due also to this fact, ice in the river estuaries breaks up before the breakup occurs in the adjacent seas; this breakup occurs partly under the impact of high water progressing from south to north (dynamic action) and partly because of high temperatures of fluvial waters (thermal action). Because the melting in the arctic progresses always from fresh water areas, which are formed by different causes, the river estuaries are usually the centers of initial ice melting.

4. Diluted waters, especially in the shallows, freeze over before the more saline sea water. Therefore, river estuaries are the initial centers from which ice formation progresses into adjacent areas.

5. The sharply pronounced seasonal character of continental runoff demands our attention. This season character is explained by the fact that all of the rivers run over permanently frozen ground. As a consequence, these rivers are not fed by the ground water. In addition, small rivers that flow over the tundra freeze to the bottom over rifts. Thus, for instance, more than 90 per cent of the entire annual discharge of the Gana River enters the Arctic Ocean during the 3.5 summer months (without ice).

6. The quantity of continental runoff does not determine the amount of heat brought into the sea by rivers. The heat amount, expressed in kg-cal (multiplied by 10¹²), which is discharged by rivers annually into the Soviet Arctic seas is according to Antonov and Zotin, as follows: 9500 for the Kara Sea, 6400 for the Laptev Sea and 1750 for the East Siberian Sea.*

*These figures are rounded off.

Thus, the significance of the continental runoff into the Laptev Sea is increased on account of the heat discharged by the Lena River.

7. The quantity of heat brought by rivers into the sea is subjected to considerable seasonal fluctuations. Indeed, the entire heat discharged by rivers flows into the sea during the five summer months. During the summer season the heat discharge is also variable. This can be seen from table 19 (after Antonov).

TABLE 19. HEAT AMOUNT (BY MONTHS) BROUGHT BY RIVERS INTO THE KARA SEA

Month	June	July	August	September	October	Season
Heat amount (10^{12} kg-cal) . . .	1,530	3,410	2,120	900	180	8,140
Percentages . . .	18.8	41.8	26.1	11.0	2.3	100

Antonov directs our attention to the fact that approximately half of the whole heat of the Kara rivers is discharged during a single month, July. This heat is spent, on the one hand, on direct destruction of ice and, on the other hand, for the warming of atmosphere and the subsequent melting of ice. It is not difficult to see that the heat discharged by the Kara rivers could melt approximately $60,000 \text{ km}^2$ of ice with the average thickness of 2m.

8. The annual runoff as well as the amount of heat discharged by the rivers, does not remain constant from year to year. Table 20 presents the calculation of annual discharges of the Genisey River at the Town of Igarka, on the Ob' River at the town of Salekhard, and of the Lena River at the town Kyusyur.

TABLE 20. ANNUAL VARIATION IN THE DISCHARGE OF THE OB', GENISEY AND LENA (IN KM^3)

Rivers	Year				
	1935	1936	1937	1938	1939
Ob'	374	355	361	389	371
Genisey	636	599	615	590	564
Lena	582	470	509	587	434
Total	1,592	1,424	1,485	1,566	1,369

By comparing the value of the continental runoff with the ice conditions in the Kara Sea, Lebedev arrived at the conclusion that the intensification of river influx is associated with improvement of ice conditions.

9. The river influx dilutes the sea water to a degree. This influence progresses to a rather great distance. Thus, for instance, with a few exceptions, the salinity of surface waters in the entire southwestern part of the Kara Sea, which is bounded to the north by a meandering line from mys Zhelaniya across Ostrov Uyedineniya to Severnaya Zemlya with tongues reaching into areas influenced by the corresponding currents, is lower than 30 o/oo.

10. The river influx affects the system of sea currents in the adjacent areas and because of this, the movement and distribution of sea ice.

LITERATURE: 6, 7, 62, 77, 98.

Section 25. A Concept on the Heat Balance

For simplicity, let us dispense with the effect of continental runoff, which is felt mainly in the coastal belt, and the effect of precipitation.

In such a case, the variation of sea temperature in oceanological coordinates will be caused by the cumulative radiation by effective back radiation of the water-air system by convection, condensation and evaporation. The intention in singling out these processes for elucidation of the significance of each aspect individually is natural. But the conditions existing in nature are diverse, the observational methods are very incomplete and the observations in open sections of the ocean are altogether inadequate.

It is known that the wind is one of the main elements determining the regimen of the sea. It is, for instance, assumed that the rate of evaporation is directly proportional to the speed of wind. Besides, it is known that along the coast the direction and velocity of wind may differ greatly from the observed values in the sea.*

Thus, for instance, on the coast of the Chuckchee Sea, the wind roses have an elliptical form with the longer axis stretched along the coastline, which is explained by the coastal contours. Local breezes are constantly observed along the coast; breezes are induced by irregular heating and cooling of land and sea when nights alternate with days, whereas local monsoons are induced by irregular heating and cooling of land and sea in summer and winter.

Hence, it is natural that the most correct way of studying the problems that are associated with heat exchange between the sea and atmosphere is, in the first place, to examine the observational data, even if their scope is limited, which pertain to the open sea, and to resort to synoptic charts; whereas the observations made at coastal stations on wind, temperature, moisture, solar radiation, etc, need be considered only as supplementary data.

It seems to me that the greatest influence on the ice regime of the Soviet Arctic is exercised by the temperature and moisture of the air, on the one hand, and by the direction and velocity of wind, on the other. The temperature and moisture of the air characterizes the content of heat and cold in the air. If the air is warmer than the sea, its heating effect is determined by the heat of condensation; if the air is colder than the sea, its cooling effect is determined by the heat of evaporation. The role of wind speed is manifest in the involvement of heat exchange between large air masses. This is of special significance at relatively warm winds when the lower air strata, cooled by sea surface, protect the sea from further heating. At strong winds, this layer is eliminated, and the level of the temperature inversion rises. At colder air the importance of wind speed decreases, because convection is decisive in this case.

The wind direction is of interest because it determines the area from which the air masses are coming, and thus determines to a degree the air temperature and moisture.

**Exempli gratia*, the Novaya Zembya *boza* blowing with exceptional force along the coast of the island is well known, but it is entirely unnoticeable at a distance of a few kilometers from the coast.

TABLE 21. THERMAL WIND ROSES IN SUMMER

Points	Month	N	NO	O	SO	S	SW	W	NW	Amplitude
Gugorskiy Shar .	July	2°.3	3°.4	7°.9	13°.7	14°.7	8°.8	5°.7	3°.6	12°.4
O. Diksona . . .	July	1.8	3.8	9.5	9.5	4.6	2.5	1.8	1.4	8.1
B. Tiksi	July	6.6	6.9	7.0	7.0	19.4	16.4	14.0	8.9	12.8
Mys Shmidta . .	June	0.7	1.4	2.2	2.2	10.1	1.7	2.0	1.3	9.4
B. Tikhaya . . .	August									
	June	-0.4	0.7	1.1	1.1	0.6	0.1	-0.7	-0.7	2.0
	August									

Table 21 (by Vize) presents the typical thermal roses of winds in summer, i.e., the air temperature corresponding to winds of various directions.

In the last column of the table is shown the temperature amplitude. Vize correctly directs attention to the fact that at coastal stations (on the continent) the amplitude is considerably greater than at island stations. We already know that the water-air temperature difference far off the coast does not exceed $\pm 2^\circ$. Therefore, it is natural that a warm or cold wave, crossing the coastal line for the sea, becomes gradually extinguished with distance from the coast.

TABLE 22. THERMAL ROSES OF WINDS IN WINTER

Points	Month	N	NO	O	SO	S	SW	W	NW	Amplitude
Gugorskiy Shar .	January	-18°.8	-22°.0	-25°.0	-20°.6	-18°.4	-12°.5	-5°.4	-9°.0	19°.6
O. Diksana . . .	January	-25.8	-28.2	-31.3	-23.0	-23.0	-20.9	-13.3	-12.6	18.7
B. Tikhaya . . .	January	-23.6	-23.0	-19.1	-9.6	-5.8	-5.1	-6.7	-17.7	18.5
M. Uelen	December	-22.0	-18.3	-12.1	-4.1	-14.5	-21.8	-20.3	-23.4	19.3
	February									
Selo Kazach'ye .	December	-31.6	-32.5	-36.2	-36.6	-35.3	-36.0	-33.7	-31.9	5.0
	February									

Table 22, by Vize, shows the thermal wind roses in winter for certain points of the Soviet Arctic. The amplitudes of temperature fluctuations at various wind speeds are still more significant in winter than in summer; besides, at islands the fluctuations are greater than on the coast of the continent. The air temperature maxima and minima at various coastal points are attended by winds of various directions.

Figure 12 (by Vize) presents a chart of air temperature anomalies in January. As can be seen from the figure, the positive air temperature anomalies pertain to the Greenland, Barents and Kara Seas. The negative anomalies are found in northeastern Asia. The temperatures that are normal for the given latitudes (0 isanomal) intersect the Laptev, East Siberian and Chuckchee Seas. The relative position of heat poles (between Iceland and Norway) and cold poles (about Verkhoyansk) determines the relationship between air temperature and wind direction: with winds from areas with positive anomalies, the air temperature increases, but with winds from areas with negative anomalies, the air temperature drops.

It was already stated that the difference between the air and sea surface temperatures in offshore regions of the ocean is very small. Further it was stated that, due to its great heat capacity, the sea, not the air, governs the corresponding temperature equalization. Consequently, if

we assume that in an area where a positive air temperature anomaly is encountered, the sea is heated, the air moving over the area is also heated to the same degree. Simultaneously, the moisture of the air increases and, consequently, its heat capacity also increases considerably.

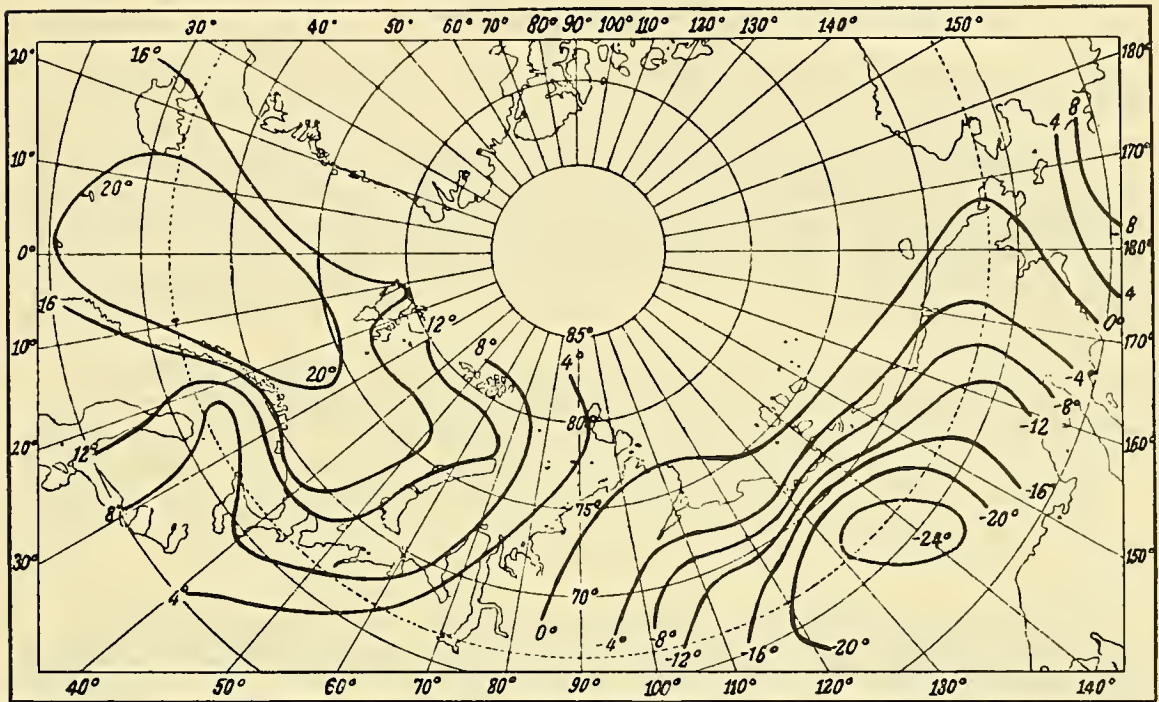

Figure 12. Isanomals of air temperature in January.

Let us now assume that the mean yearly temperature of a water basin does not change. In such a case the equation of heat balance will have the following form:

$$R(1 - A) - r - E + C + F + M - N + P - Q = 0,$$

where R = cumulative solar radiation,

A = albedo,

r = effective reradiation,

E = heat loss to evaporation and convection,

C = heat inflow at condensation,

F = heat brought by continental runoff,

M = heat brought into given basin by sea currents (+ pertains to a case when the temperature of inflowing waters is higher than the mean temperature of the basin),

N = heat carried out of a given basin by sea currents (- pertains to case when the temperature of outgoing waters is higher than the mean temperature of the basin),

R = the "cold" taken out of a given basin together with ice,

Q = the "cold" brought into a given basin together with ice.

It stands to reason that, for individual areas, not all of the terms of the equation of heat balance are of the same order.

So for instance, in basins with limited water and ice exchange with neighboring basins, the magnitudes M , N , P and Q may be of such small significance that they can be neglected in the first approximation. The White Sea, for instance, is one such basin. In the Chuckchee Sea we can dispense with the continental runoff. In the central arctic basin, where the sea is covered by continuous ice, the effect of solar radiation, owing to the great albedo of ice, becomes small in comparison with other components, etc.

The equation of heat balance is applicable not only to the year but also to individual seasons. Thus, for the arctic night the equation will assume the following form:

$$-r - E + C + M - N + P - Q = K,$$

where K = the variation of heat reserves in the basin during the given time interval.

In the latter equation the solar radiation for winter equals 0, but the heat amount brought in by the continental runoff in the winter, as we saw, is so insignificant that it can be neglected in the first approximation.

At the present time, only the first attempts at calculating the heat balance have been made, and they are restricted to individual seas. However, even after the methods of calculating the heat balance have been developed and the pertinent data obtained, the verification of the calculations will be necessary.

Assume that hydrological observations are carried out from time to time and stations occupied sufficiently often in a given area to arrive at the mean temperature of the basin.

It is obvious that on the basis of comparisons between the mean temperature values obtained in such a way one can draw conclusions about the variation in the heat content of a given water basin from one time moment to another, which result from the cumulative action of the components of the heat balance.

If the basin is large and the employment of a dense network of hydrological stations requires too much effort, observations are conducted in directions that are more typical of the basin--i.e., in the standard oceanological cross sections.

One of such standard cross sections--along the Kola longitude in the Barents Sea--intersects the Nordkapp current. By measuring the water temperature along the Kola longitude at the same geographical coordinates, we are in fact measuring the temperature of various water masses.

As we know (paragraph 12), in order to draw conclusions on the variations of temperature in the same water masses, the formula*

$$\frac{dt}{dT} = \frac{\partial t}{\partial T} + u \frac{\partial t}{\partial x}$$

is used.

In order to utilize this formula, it is necessary to employ at least two parallel oceanological cross sections (for the calculation of the temperature gradient and the current direction) across the given current and, in addition, to determine the current speed between the cross sections. The cross sections intersecting the Nordkapp current (in addition to the Kola longitude) in the Barents Sea were set up along the 38th longitude and in the direction, Nordkapp-Ostrov Medvezhiy. When comparing the cross sections along the Kola longitude and along the line Nordkapp-Ostrov Medvezhiy, it was found that, in all seasons of the year, the first cross section was approximately 1.5° colder than the second.

The data concerning the mean speed of the Nordkapp current from the line Nordkapp-Ostrov Medvezhiy to the Kola longitude are still less accurate. Judging from the existing current charts, it appears that at least three months are needed for the Atlantic water to travel from the Nordkapp-Ostrov Medvezhiy sector to the Kila longitude. In other words, the mean current speed is about 5 cm/sec. Thus, a water column 200 m thick, while on its way from the Nordkapp to the Kola longitude in winter and summer, is lowered in temperature by approximately half a degree each month.

Applying the above mentioned formulae and calculations to a concrete case, we find that, for instance, from 15 May to 15 June 1934, the temperature along the Kola longitude increased from 3.22° to 4.06°, i.e., the rate temperature variation in geographical coordinates equals 0.84° per month.

On the basis of the above formula (because the temperature gradient is negative) we find that the rate of temperature variations in oceanological coordinates equals 0.34° per month.

In other words, we find that from 15 May to 15 June, the rise of temperature in the moving Nordkapp waters to a depth of 200 m equals 0.34° or, if the heat capacity of water is assumed to equal unity, the heat content under each cm² of the Nordkapp current increases by 6.8 kg-cal.

From 15 January to 15 February 1935, the mean temperature along the Kola longitude dropped from 4.25° to 3.65°, i.e., by 0.60°. Consequently, the drop of temperature in oceanological coordinates equalled 1.10° during this time. In other words, each cm² of the surface of Nordkapp current gave off to the atmosphere 22 kg-cal.

It is not difficult to demonstrate by such reasoning that, despite the rise of temperature in the cross section along the Kola longitude in the summer--which is almost balanced with cooling in the winter-- each cm³ of the Nordkapp current (between the Nordkapp and Kola longitude) gives off to the atmosphere at least 120 kg-cal.

*It is evident that these reasonings are applicable not only to warm but also to cold currents (only the sign of temperature gradient is reversed).

The heat loss of 120 kg-cal/cm^2 in a year was found by assuming that the temperature difference at the Nordkapp and Kola cross sections equals 1.5° and that the mean speed of the Nordkapp current in the sector has also a constant value of 5 cm/sec . It is possible that the horizontal temperature gradient along the Nordkapp current is subjected to seasonal and secular variations. We cannot, for the time being, assert it, but this variation is hardly significant. As to the seasonal and secular variations in the speed of the eastward-moving Nordkapp water, they can, in any case, be considered as established from the qualitative point of view. However, if the annual heat loss to the atmosphere equals 120 kg-cal/cm^2 at the assumed speed of 5 cm/sec and the temperature gradient is 1.5° , then it is clear that, with variation in the speed of only 1 cm/sec , the heat loss varies by 24 kg-cal/cm^2 , (i.e., it exceeds considerably the result obtained by examining the temperature variations in geographical coordinates).

This reasoning gives an idea of the effect of Atlantic waters, and that of the Nordkapp current in particular, on climatic conditions in the areas penetrated by air masses moving over the Barents Sea and being heated by the water.

The southern portion of the Barents Sea is a relatively simple case for the drawing of conclusions on the influx and efflux of heat. The northern portion of the sea is, however, rather complex. Here one is faced with the formation and melting of ice and with the condensation of water vapor which is unavoidable in the summer time when the underlying surface is colder than the travelling water masses. The presence of ice in the region, which absorbs considerable amount of heat during melting and gives it off upon formation, simultaneously diluting or salinifying the water, complicates the calculation of incoming and outgoing heat. The complexity is increased by the influx and efflux of ice whose quantity varies from year to year, in each of the marginal seas of the Arctic Basin.

It is, for instance, assumed that from the central section of the arctic about $2,500 \text{ km}^3$ of sea ice is annually carried out via the Greenland-Spitsbergen Strait. Neglecting the temperature of the ice, we find that about $20 \cdot 10^{16} \text{ kg-cal}$ of heat is given off to the atmosphere by the sea during the formation of the ice. This heat has of course played its part in the raising of air temperature over the Arctic Basin.

Still more complex is the problem of the influx and efflux of heat in such seas as the Kara, Laptev and other seas where, in addition to the ice, the discharge of heat by rivers is significant.

LITERATURE: 34, 49, 62, 77, 124.

Section 26. The Concept of the Water Balance

The circulation of moisture on the earth, according to Bruckner, who assumes that the quantity of water does not change in the ocean, is expressed by the following equations:

Precipitation on the ocean = evaporation from the ocean--continental runoff.

Precipitation on land = evaporation from the land + continental runoff. It is evident that these formulae are valid only for a great number of years when the annual random deviations from mean value can be eliminated.

It is assumed that only a small part--namely, about 10 per cent of the moisture evaporating from the ocean is carried away and precipitated on land, returning later to the ocean in the form of continental runoff. The remaining portion of the water that has evaporated from the ocean is precipitated back into the same ocean. However, its distribution over the ocean areas is far from uniform. In lower latitudes, except for the pre-equatorial belt of the Northern Hemisphere, the evaporation exceeds precipitation, and here the ocean is constantly salinified. In temperate and high

latitudes, on the contrary, precipitation dominates over evaporation, and a constant dilution occurs. The general equilibrium of moisture is maintained by sea currents.

In order to judge the balance of water and salinity in individual seas of the World Ocean, let us adopt the following assumptions:

1. the volume of water in a given sea is constant; in other words, the mean water level does not change;

2. the mean salinity of the given sea does not change; with such assumptions, we have the following equation for the required balance of water masses:

precipitation + continental runoff + water influx from other basins = evaporation + water outflow to adjacent seas.

If the pure water balance in this equation is precipitation + continental runoff--evaporation, which is designated by F , we have the following formula of water balance:

$$V_1 + F = V_2, \quad (1)$$

where V_1 = the volume of water flowing from adjacent seas,

V_2 = the volume of water flowing out of the given sea.

Depending upon the relative magnitudes of the factors constituting the pure water balance, it can be either negative or positive. In the first case we may have a positive water exchange of a sea with the ocean (the influx of ocean waters exceeds the outflow of the given sea). In the second case there is a negative exchange. A typical example of the first case is the Mediterranean Sea; a typical example of the second is the Black Sea.

In order to preserve the constancy of the mean salinity of a sea (neglecting the volatilization of salts into the atmosphere and their sedimentation on the bottom of the sea), the following equation is needed:

$$V_1 S_1 = V_2 S_2, \quad (2)$$

in which S_1 = salinity of the water flowing from the ocean,

S_2 = salinity of the water flowing out of the given sea.

It follows from equation (1) that if the pure water balance of a given sea is 0, i.e., if precipitation plus continental runoff exactly equals evaporation, then

$$V_1 = V_2, \quad (3)$$

whence, on the basis of equation (2) we have

$$S_1 = S_2. \quad (4)$$

If S_1 is greater than S_2 , the water exchange with other seas is negative; if S_1 is smaller than S_2 , the water exchange is positive.

Let us assume now that a complete intermixing of incoming water with the main water mass of a given sea occurs in the entire sea immediately after the influx of the former. In such a case, the mean salinity of the outflowing water, after its intermixing with the inflowing water, will equal the mean salinity of the given sea.

The intermixing of inflowing water with the main water mass of a given sea never occurs instantly but rather over a long time interval. Because of this, the mean salinity value of a sea is usually a value between the salinity of outflowing and inflowing waters.

Simple calculations demonstrate that the greater the water volume--in comparison with the volumes of inflowing and outflowing waters--that pass (due to intermixing) through the boundary surfaces (separating individual water layers from each other) the nearer the mean salinity of the sea to the salinity of the outflowing water. Thus the mean salinity of a sea will be closer to the salinity of the outflowing waters as the pure water balance of the given sea is smaller, the water exchange with adjacent seas in comparison with the general water mass of the given sea is smaller and as the speed of intermixing is greater.

The balance of moisture and, consequently, the water exchange and salinity for each individual sea can be most readily calculated by measuring the current speeds and salinity at oceanological cross sections across the straits connecting the given sea with the adjacent parts of the ocean.

The needed formulae are readily derived from the above equations--namely:

$$D = Q_1 u_1 - Q_2 u_2, \quad (5)$$

in which Q_1 and Q_2 = areas of crosswise intersection of currents running in opposite directions in straits, u_1 and u_2 = corresponding mean speeds of the currents.

The formulae of water balance can be presented differently--namely, in lieu of (1) and (2) we write

$$V + V_1 + F - V_2 = \text{const}, \quad (6)$$

$$VS + V_1 S_1 - V_2 S_2 = \text{const}, \quad (7)$$

where V = the total volume of a basin,

S = the mean salinity of the basin.

It is evident that if one of the components of the balance changes after equilibrium is achieved, a corresponding variation of one or several components of the balance formula will be entailed. This variation will not, of course, occur immediately.

Assume that, in addition to the water exchange with the adjacent basins, an ice exchange exists. In such a case, the balance formula is as follows:

$$V_1 + F + \delta V_1' = V_2 + \delta V_2', \quad (8)$$

where

δ = density of ice,

V_1 = volume of ice brought into the basin,

V_2 = volume of ice brought out of the basin;

$$V_1 S_1 + \delta V_1' S_i = V_2 S_2 + \delta V_2' S_i, \quad (9)$$

where S_i = salinity of ice (assuming that the salinity of incoming and outgoing ice is the same).

It is evident that if we assume that the salinity of ice equals 0, the ice balance formula will not change, but in the water balance formula the ice may be included in the pure water balance.

It need be pointed out that the above formulae of water balance can be utilized for the solution of many problems of oceanology; for the heat balance, for instance. As typical examples, we can mention the following calculations (by Somov) of heat quantity brought by the Atlantic water into the heat balance of the Kara Sea.

Neglecting the amount of ice brought from the Arctic Basin into the Kara Sea, Somov derived from balance formulae the following equation.

$$V_1 = \frac{(F - \delta V_1') S_2 + \delta V_2 S_i}{S_1 - S_2}. \quad (10)$$

Assuming that the approximate values of components in the formula are as listed below:

$F = 1,300 \text{ km}^3/\text{year}$ (which corresponds, as we saw, to the annual Bering Sea influx, neglecting precipitation and evaporation in the first approximation because of their insignificant values), V_2 --the volume of ice taken out of the Kara Sea (for the sake of orientation, Somov assumes that $1/80 \text{ km}^3$ of ice is brought out of the Kara Sea annually, which is equivalent to 430 km^3 of water if the density of ice is 0.9),

$S_2 = 32 \text{ o/oo}$ --the mean salinity of the Kara Sea,

$S_i = 5 \text{ o/oo}$ --the mean salinity of ice,

$S_1 = 35 \text{ o/oo}$ --the mean salinity of Atlantic water,

and introducing these magnitudes into the main formula, Somov finds that for the preservation of the mean salinity of the Kara Sea an influx of $10,000 \text{ km}^3/\text{year}$ of Atlantic water is needed.

Assuming further that the mean temperature of the Atlantic water that is discharged into the Kara Sea across the 80th latitude equals 1.5° , and that during winter these waters are cooled to -1.5° , the annual heat influx by Atlantic waters will equal

$$Q = 3 \cdot 10\,000 \cdot 10^{12} = 3 \cdot 10^{16} \text{ kg-cal}$$

Ultimately, all of the heat brought in by Atlantic waters is given off to the atmosphere.

The area of the Kara Sea south of the 80th latitude equals $750,000 \text{ km}^2$. Hence, it follows that the sea annually gives off to the atmosphere

$$q = 4 \text{ kg-cal/cm}^2$$

of heat which is brought in by Atlantic waters.

It is evident that the thermal influence of Atlantic waters is probably not distributed over the entire Kara Sea. Delimiting the given area on the north by the 80th latitude, on the south by a straight line from Matochkin Shar to Proliv Shokalskago, and on the west by a line from Mys Zhelanizy to Franz Joseph Land, the area appears to equal 300,000 km². But the quantity of heat given off will, according to Somov, increase to 10 kg-cal/cm² per year. The amount of heat will be sufficient for the melting of ice 125 cm thick.

It is evident that such calculations are very important, and there is no doubt that, with the accumulation of the corresponding data, they will be refined and adapted to other seas.

LITERATURE: 62, 77, 108, 121, 125.

CHAPTER III

THE MIXING OF OCEAN WATERS

Section 27. The Concept of Mixing

Processes continually occur in the ocean which change the vertical and horizontal distribution of temperature and salinity (and other physical-chemical characteristics).

Some of these processes which are caused by the biological activity of organisms occur throughout the entire depth of the ocean. These processes, which change the relationships between the chemical compounds contained in sea water in small amounts, find practically no expression in the general physical-chemical state of ocean water. There are other processes which sharply change this state; i. e., the absorption and radiation of solar energy, evaporation, precipitation, etc.; these develop at the surface of the ocean. In addition, water with a specific temperature and salinity is formed on the surface in one region of the ocean, and is transported by ocean currents to different regions and depths. Here, they mix with waters created under different conditions, and in this manner vertical and horizontal hydrological gradients are continually created and maintained on the ocean's surface and in its depths.

As a result of all these processes, water masses of different composition and dimensions are created in the ocean; these differ from one another in temperature, salinity, oxygen content, etc., and are separated from each other by surfaces of separation, i. e., by frontal surfaces. In vertical cross sections, these water masses appear as superposed layers with the upper layers less dense than the lower ones, as a rule. Only very seldom is a density decreasing with depth observed.

It is evident from the TS diagram in Section 4 that identical densities can be obtained with different combinations of temperature and salinity. Normally, temperature decreases with depth, while salinity increases, but often anomalies of vertical temperature and salinity distributions can be observed. Borrowing some meteorological terms, temperature increase with depth is called a temperature inversion, and the decrease in salinity downward, a salinity inversion. We have already seen that the downward increase of temperature may be due to the pressure of the upperlying layers. Such an inversion is called an adiabatic temperature inversion. Naturally, in contrast to an ordinary temperature inversion, an adiabatic temperature inversion can be observed in the same water mass. Continuing the analogy, we call a decrease in density downward a density inversion.

Simultaneously with the creation of water masses in the ocean, processes occur which tend toward equalization of the states and which can be classified under the general heading "mixing."

Thus, the continual and chaotically uniform thermal movement of molecules comprises molecular mixing.* But the most important and decisive role in the ocean's regime is played by turbulent mixing, subdivided into frictional and convective.

*The coefficients of molecular diffusion, thermal conductivity, and friction are so small that molecular processes exert practically no influence on the ocean's regime, and they may be neglected when solving general problems.

By frictional mixing we mean that which is caused by the uneven movement of contiguous water masses; i. e., by the presence of vertical and horizontal velocity gradients. At the surfaces of separation of water masses, these gradients create eddies, penetrating from one water mass to another, and in this manner, mixing them.

By convective mixing, we mean that which arises as a result of either a decrease in the density of the deep layers, or of an increase in the density of the surface layers of the sea. In either case, there arise, in the water mass, vertical currents which cause mixing of the superposed layers.

The main difference between convective and frictional mixing is that convective mixing may occur whether or not the given layers are in motion, and that it takes place only in a vertical direction. Frictional mixing depends on the presence of vertical and horizontal velocity gradients, and in this regard, they may occur both horizontally and vertically.

If the horizontal velocity gradient is found at the surfaces of separation of water masses of different density, as happens, e. g., when sea currents flow into basins with different physical-chemical characteristics, convective and frictional mixing may occur simultaneously. Frictional mixing may also cause convective mixing when the horizontal layers differ little with respect to density and the mixing causes "a density increase" of the layers.

The rate of vertical mixing depends most strongly on the resistance which individual layers display to mixing. This resistance is determined by the stability of the layers and, according to Hesselberg and Sverdrup, this stability has the value:

$$E = \frac{\partial \alpha}{\partial t} \frac{dt}{dz} + \frac{\partial \alpha}{\partial S} \frac{dS}{dz} - \frac{\partial \alpha}{\partial t} \frac{d\xi}{dz}, \quad (1)$$

where α = the specific volume,
 t = the temperature,
 S = salinity,
 ξ = the adiabatic temperature change.

Formula 1 can be represented in another way:

$$E = \frac{d\alpha}{dz} - \frac{\partial \alpha}{\partial t} \frac{d\xi}{dz}. \quad (2)$$

The first member of the right hand side of this formula is the vertical specific volume gradient, and the second member is the specific volume corrected for adiabatic temperature change.

Since the adiabatic correction is very small, it may be disregarded when judging the stability of the upper ocean layers, (where the vertical specific volume gradients are large). At the lower depths, where the layers are extremely uniform with regard to temperature and salinity and where, accordingly, the vertical specific volume gradient is very close to 0, the adiabatic correction may play a decisive role.

Usually, in the ocean, the stability is positive, i. e., the lighter layers lie above the heavier ones. But in certain regions, negative stability, i. e., density inversion, can be observed in the intermediate layers. This is explained by the presence of sea currents, consisting of waters of different origin superimposed. Finally, in individual cases, during mixing caused, e. g., by strong cooling during the winter, stability may be negative even in the upper layers. This indicates that cooling of the ocean surface occurs more rapidly than convection.

Occasionally, formula (1) is represented as follows:

$$E = \frac{\partial \alpha}{\partial t} \left(\frac{dt}{dz} - \frac{d\xi}{dz} \right) + \frac{\partial \alpha}{\partial S} \frac{dS}{dz} = E_t + E_s, \quad (3)$$

where the first term is the stability, determined by the temperature gradient and adiabatic temperature change, and the second is the stability determined by the salinity gradient.

LITERATURE: 60, 62, 77, 155.

Section 28. Frictional Mixing

A thin stream of fuchsin introduced into a slowly moving liquid flux in a glass tube, forms a smooth straight thread. When the speed of this flux is increased the thread breaks. The broken thread travels a certain distance, after which the liquids mix and become uniformly colored. The first type of movement is called stratified or laminar, and the second, eddy or turbulent. Reynold's theoretical considerations and experiments have shown that laminar movement is evidently possible in nature only with the very slow movement of water in ground capillaries. In all other cases it is a matter of turbulent movement, characterized by the following features:

1. The speed at each point of the current fluctuates around its mean values with regard to magnitude and direction.
2. The speed of the current very close to the boundaries differs little from the overall speed of the current.
3. The motion depends only slightly on the viscosity of the liquid.

The nature of turbulent motion has not been sufficiently explained, even for uniform liquids, but its results are easily detectable from direct observations. Actually, only vertical and horizontal velocity gradients can explain the presence, e. g., in river currents, of the multitude of suspended earthen particles with specific weights of 2.0 to 2.8; these particles grow in size with an increase of the velocity gradients. This fact is supported by the almost complete homothermy of large, deep rivers and narrow straits with high current velocities, in spite of the diversity in their heating and cooling conditions.

Factors always exist in the ocean which cause velocity gradients, i. e., agitation, currents and tidal phenomena for the most part.

With regular swells or agitation, the orbits of the particles become approximately circular, and the velocity gradients are very small. But with wind agitation, particularly whitecaps, the velocity gradients may attain very high magnitudes and thus cause mixing.

The wind or wave mixing plays a role only in the surface layers of the ocean; it extends to the bottom only in shallows and assumes particular importance off-shore, where the velocity gradients increase.

The ocean currents, on the other hand, usually cause high velocity gradients only in their boundary surfaces, particularly at the bottom and off-shore.

The tidal phenomena, i. e., periodic vertical and horizontal oscillations of water masses, are most important for turbulent mixing in the ocean. The velocities of tidal currents are, as a rule, greater than those of steady or temporary ocean currents. Also, tidal phenomena extend throughout the entire depth of the ocean, while ocean currents are usually confined to the surface layers and in

only certain regions of the ocean. Finally, tidal phenomena act in both vertical and horizontal directions periodically, and at different times in adjacent regions, which aids in creating high velocity gradients.

For an elementary explanation of the occurrence of frictional mixing, let us assume that a wind of continually increasing intensity comes up over an initially calm sea. When this happens, capillary waves first appear on the surface of the sea, these gradually change into wind waves. After the wind reaches a considerable force, whitecaps form, wave destruction begins, and eddies form penetrating to ever increasing depths and mixing the surface layers. Simultaneously, thanks to the friction of the wind against the water and the pressure of the wind on the rear surface of the waves, a wind current arises. An analogous phenomena occurs on the surfaces of separation of water masses, where the role of the wind is played by the mass which moves with the greater velocity. This requires a smaller velocity gradient than between the air and water to effect a fracture of the surfaces of separation and the formation of eddies.

The lower the stability of the layers and the larger the velocity gradients the more intensely the waves and eddies develop and the stronger the mixing. From this, it follows that the magnitude of the velocity gradient determines the intensity of mixing and the possibility of overcoming a given stability.

Large velocity gradients are created at the bottom, off-shore, in narrows, and in the shallows, etc. For example, the waters contiguous with the Gorlo Belogo Morya (Neck of White Sea) both on the Barents Sea side and the White Sea side, are quite sharply stratified (inter-stratified). Despite this, the high speeds of the tidal currents and, as a result, the large velocity gradients in certain regions of the Gorlo, completely mix the water from the surface down to the very bottom, which imparts the nature of a river current to the waters of this strait. However, in this same Gorlo Belogo Morya there are regions where such velocity gradients appear to be insufficient for overcoming the sharp stratification and consequently, the high stability which exists here.

Figure 13 according to V. A. Berezkin, shows the distribution of isotherms on 13 to 17 August 1926 in Gorlo Belogo Morya through the Pulong-intsy section at high tide. It is evident from the figure that the isotherms in certain parts of the section run practically vertical, although usually during the summer, the isotherms in the surface layers of the sea are arranged practically horizontally. This is explained by strong mixing, arising here as a result of strong tidal currents.

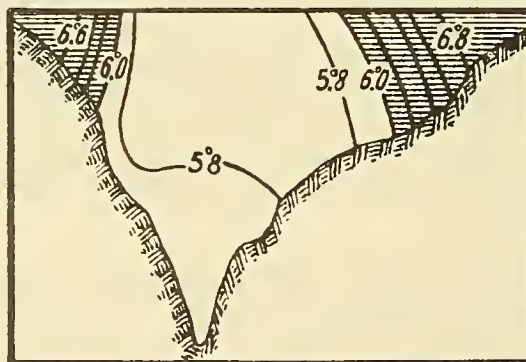

Figure 13. The arrangement of isotherms in the Gorlo Belogo Morya in August.

Wind mixing plays an important role in the regime of the open ocean. This mixing begins at the very surface of the ocean and gradually spreads to greater or lesser depths, depending on the vertical density distribution, and on the intensity and duration of the wind.

Naturally, the less the sea is stratified the less stable it is, and the less wind action that is necessary for mixing. Thus, in the southwestern part of the Barents Sea, where the stability of the surface layers is low, I often observed complete mixing of the surface layers to a depth of 30 to 40 meters after two or three days of stormy weather.

The solid lines in figure 14 show the vertical distribution of temperature, salinity and specific volume at the initial moment; the dotted lines the distribution of these same factors after wind mixing, extending from the surface of the sea to a certain depth. Curve *R* shows, on a representative scale, the wind's action expended on frictional mixing from the surface of the sea to the given depth.

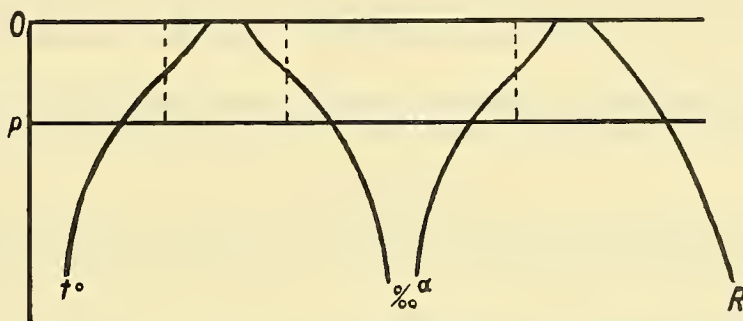

Figure 14. The vertical distribution of temperature, salinity and specific volume after wind mixing.

From the figure it is evident that the distinguishing feature of wind mixing is the destruction of the stability of the mixed layers and the creation of large gradients of all the physical-chemical properties of sea water at their lower boundary. It is also evident from the figure that with the usual distribution of temperatures, the temperature of the sea surface drops somewhat, thanks to wind mixing, and at a certain depth, it rises. In this manner, the heat absorbed by the surface layers is conveyed downward.

We should particularly stress the significance of wind mixing for the thermal regime of the ocean. It has been shown that the thermal energy of solar radiation is literally absorbed by the first few centimeters of the surface layers of the sea. Actually, (if we exclude heat transport by currents) the distribution of the heat absorbed by the surface layers is due only to frictional wind mixing.

But on the other hand, wind mixing, by creating large density gradients at the lower boundary, limits by its very nature, as it were, the depths of its distribution. This phenomenon is particularly well expressed with large salinity gradients in the surface layers.

LITERATURE: 15, 62, 77.

Section 29. Convective Mixing

As has already been pointed out, stable equilibrium of the stationary horizontal layers may exist under the condition that the lighter layers lie above the heavier ones. Being more exact, it is necessary that the stability of the layers be positive for equilibrium. As soon as this condition is disrupted, eddies occur on the surfaces of separation, mixing these layers. Thus, by its very nature, convective mixing is also a turbulent process.*

Let us assume that the specific volume of topmost layer begins to decrease for some reason. At the same time the stability between the first and second layers from the top will begin to decrease.

The stability depends on two factors -- on the vertical specific volume gradient (without correction for compressibility) and on the adiabatic correction. In our discussion we will disregard the latter, due to its small size in comparison with the specific volume gradients of the upper layers, and we will consider that for mixing to be possible it is necessary that the specific volume of the first layer becomes equal to the specific volume of the second layer from the top.

A decrease in the specific volume of sea water may be caused either by an increase in the salinity or by a change in temperature which would bring the water closer to the temperature of greatest density.

An increase in the salinity of the surface layers of the sea water, regardless of the mixing of waters of different salinity, may be caused either by ice formation, or by evaporation.

Let us assume that a layer of ice of thickness i and salinity S_i forms from a uniform layer of thickness z , whose salinity at the initial moment was S , $S_i < S$.

If we melt this layer of ice of thickness i , we will obtain a column of water of height h , whereupon

$$h = i \frac{\delta_i}{\delta_w}, \quad (1)$$

where δ_i = the density of the ice,

δ_w = the density of water.

Naturally, after the ice is formed, the salinity of the remaining water column will increase by ΔS .

From the mixing law, we get

$$Sz = hS_i + (z - h)(S + \Delta S), \quad (2)$$

from which the increase in salinity will be

$$\Delta S = \frac{(S - S_i)h}{z - h}. \quad (3)$$

*Theoretically, in the absence of turbulence, equilibrium may exist even with some negative stability.

Disregarding the thickness of the ice in the denominator of this formula in view of its smallness as compared with the thickness of the layer from which the ice was formed, and also considering the ratio of densities of ice and water as 0.9, we get

$$\Delta S = \frac{0.9 (S - S_i) i}{z} \quad (4)$$

and

$$i = \frac{1.1 z \Delta S}{S - S_i}. \quad (5)$$

If the salinity of ice is taken as 0, we get the simpler formulas

$$\Delta S = \frac{0.9 i S}{z}, \quad (6)$$

$$i = \frac{1.1 z \Delta S}{S}. \quad (7)$$

By analogous reasoning we find that increase in the salinity of the layer during evaporation will be

$$\Delta S = \frac{aS}{z}, \quad (8)$$

where z as before is the thickness of the uniform layer of salinity S and a is the height of the evaporated layer.

For water, whose salinity is greater than 24.7 o/oo, the temperature of maximum density is lower than the freezing point, and therefore for such water the specific volume will decrease, together with a temperature drop to the freezing point. In a particular case with low salinities and low temperatures, it may be shown conversely that a certain temperature rise is required to reduce the specific volume.

Thus, in the general case ($S > 24.7$ o/oo) a certain amount of heat must be removed from the examined layer in order to decrease the specific volume. Referring this quantity of heat to 1 cm^2 of the sea surface, considering the specific heat of water as unity and measuring the thickness of the layer in meters, we get

$$\Delta t = \frac{\Delta Q}{100 z}, \quad (9)$$

where Δt is the drop in temperature of a layer z meters thick and ΔQ is the amount of heat in g/cal removed from 1 cm^2 of the sea surface.

Let us assume that at the initial moment we have two layers with corresponding temperatures t_1 and t_2 , salinities S_1 and S_2 , specific volumes α_1 and α_2 , and layer heights z_1 and z_2 . Actually, from what has been said above, after complete mixing of these layers, the total thickness of the mixed layers will be $z_{1,2} = z_1 + z_2$, while the total specific volume will be equal to the specific volume of the lower layer, i. e., $\alpha_{1,2} = \alpha_2$.

Let us further assume that the decrease in specific volume of the upper layer is due solely to a change in the temperature $= \Delta t$. In such a case, the total salinity of the mixed layers can be found from the mixing formula:

$$S_{1,2} = \frac{S_1 z_1 + S_2 z_2}{z_1 + z_2}. \quad (10)$$

The overall temperature after mixing is found from

$$\frac{(t_1 + \Delta t_1) z_1 + t_2 z_2}{z_1 + z_2} = \frac{t_1 z_1 + t_2 z_2}{z_1 + z_2} + \frac{z_1}{z_1 + z_2} \Delta t_1 = t_{1,2} + \frac{z_1}{z_{1,2}} \Delta t_1, \quad (11)$$

where $S_{1,2}$ and $t_{1,2}$ indicate the mean salinity and the mean temperature, respectively, of the layers up to the start of convective mixing.

Analogously, provided that the specific volume of the first layer decreases exclusively due to an increase in its salinity by ΔS_1 , we get the total salinity and temperature, after mixing, by the formulas

$$\frac{S_1 z_1 + S_2 z_2}{z_1 + z_2} + \frac{z_1}{z_1 + z_2} \Delta S_1 = S_{1,2} + \frac{z_1}{z_{1,2}} \Delta S_1, \quad (12)$$

$$\frac{t_1 z_1 + t_2 z_2}{z_1 + z_2} = t_{1,2}. \quad (13)$$

In these formulas, Δt_1 and ΔS_2 are the changes in temperature or salinity of the first layer necessary for its specific volume to remain equal to the specific volume of the second layer.

It appears difficult, however, to compute the magnitudes Δt_1 and ΔS_1 and therefore, they are usually derived with the help of the TS diagrams. The problem reduces to the following: to find a temperature (or salinity), corresponding to the specific volume of the second layer, from the known temperature (or salinity) of the first layer. Figure 15 shows part of the TS diagram. Let point A correspond to elements of the first layer and BC be a portion of the isoline of the specific volume of the second layer. Naturally, for the specific volume of the first layer to become equal to that of the second layer, we must either change the temperature by the magnitude $AB = \Delta t$, or change the salinity by the magnitude $AC = \Delta S_1$.

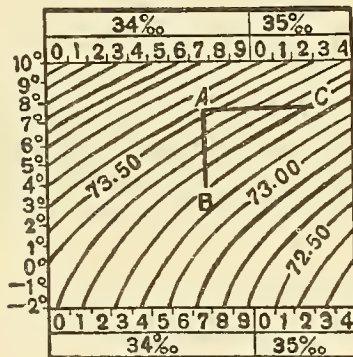

Figure 15. Determination of the TS diagram of the change in temperature or salinity necessary for a change in the specific volume to a given value.

After the value Δt_1 or ΔS_1 has been determined from the TS diagram, the total salinity and temperature of the two upper mixed layers can be easily determined from the formulas given above. We can judge the possibility of mixing with subsequent layers from the top in an analogous manner.

The solid curves in figure 16 show schematically the normal vertical distribution of temperature, salinity and specific volume at the initial moment; the dashed lines show the distribution of these same factors after convective mixing from the sea surface to a certain depth, caused solely by a drop in temperature; the crossed lines show the distribution caused exclusively by an increase in the salinity of the surface layers. As can be seen from the figure, convective mixing as opposed to frictional mixing, does not create large specific volume gradients, and accordingly, high stability at its lower distribution boundary. In addition, convective mixing due to a temperature drop usually creates a temperature inversion at its lower boundary.

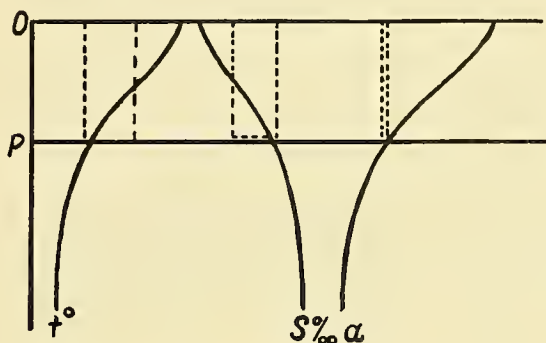

Figure 16. The vertical distribution of temperature, salinity and specific volume after convective mixing.

Mixing, convective or frictional, does not occur instantaneously, but requires definite periods of time for its completion. In general, it occurs more rapidly, the higher the negative stability which determines its appearance. Actually, we can visualize the operating process of convective mixing from the negative stabilities, sometimes observed in the surface, intermediate and deep layers of the ocean.

LITERATURE: 47, 62, 77.

Section 30. Vertical Winter Circulation

A drop in temperature of the sea surface layers (if we are examining water with a salinity greater than 24.7 ‰) causes a decrease in the specific volume, and accordingly, if this decrease is considerable, convective mixing. Therefore, in regions of the sea where the surface layers have a sufficiently expressed diurnal temperature variation, we note during the day some temperature increase (and thanks to evaporation, a certain increase in salinity as well), while at night there is a cooling and convective mixing to a certain depth. This same phenomenon occurs during any temperature drop in sea temperature. But this process reaches its highest development as a result of extended winter cooling which causes the so called vertical winter circulation. In light of the special significance of vertical winter circulation for the regime of the ocean, and in particular the Arctic Basin, we will examine in more detail this phenomena. Since it is impossible to express the relationships between temperature, salinity and specific volume by simple formulas, we will use an arbitrarily selected example in the following discussion.

Let us assume that in a certain point in the sea, a certain distribution of temperature and salinity was observed at the beginning of winter cooling, which in the future changes exclusively due to the release of heat to the atmosphere by the sea.

Let us compute the mean temperatures and salinities between the surface of the sea and the corresponding level, and note that for convective mixing to reach the given level, the specific volume of the upper layers mixed by convection must become equal to the specific volume at the given level before the start of mixing.

TABLE 23. ELEMENTS OF VERTICAL WINTER CIRCULATION.

1	2	3	4	5	6	7	8	9	10	11	12	13	14
p	t°	S	v_t	t_m	S_m	S_T	t_c	$t_m - i_c$	q_t	ΔS	i	q_i	q
0	9.10	30.62	76.84	9.1	30.62	29.46	9.1	0	0	-	0	0	0
5	8.96	30.62	76.82	9.0	30.62	29.48	9.0	0	0	-	0	0	0
10	9.00	30.62	76.82	9.0	30.62	29.48	9.0	0	0	-	0	0	0
15	8.69	31.15	76.38	8.9	30.75	30.05	6.4	2.5	3.8	-	0	0	3.8
20	6.16	31.69	75.67	8.4	30.81	30.99	-1.7	10.1	20.2	0.18	13	0.9	21.1
25	1.22	32.84	74.35	7.2	31.13	32.62	-1.8	9.0	22.5	1.49	132	9.3	31.8
30	0.07	33.04	74.15	6.2	31.51	32.96	-1.8	8.0	24.0	1.45	152	10.9	34.9
40	-0.62	33.46	73.80	4.6	31.92	33.41	-1.8	6.5	26.0	1.49	206	14.8	40.8
50	-1.56	34.16	73.23	3.7	32.29	34.15	-1.8	5.5	27.5	1.86	317	22.8	49.3
65	-1.67	34.43	73.01	3.5	32.73	34.44	-1.9	4.4	28.6	2.31	505	36.4	65.0

Table 23 gives the results of corresponding processing of the data chosen as an example. The following notations are to be used in this table:

Column 1. p is the depth in m.

Column 2. t° is the temperature at the given level before the onset of mixing.

Column 3. S is the salinity at the given level before mixing begins.

Column 4. v_t is the actual specific volume at the given level.

Column 5. t_m is the mean temperature from the surface of the sea to the given level computed by the general mixing formula:

$$t_m = \frac{\sum t \Delta p}{\sum \Delta p},$$

where t is the mean temperature between the levels before the start of mixing and Δp is the distance between the levels in meters.

Column 6. S_m is the mean salinity from the surface of the sea to the given level, computed by the same formula.

Column 7. S_T is the salinity corresponding to the specific volume of the given level, and to the freezing point.

The salinity S_T is found either from the oceanographic tables or from the TS diagram. In the latter case, we proceed along the isoline which corresponds to the given specific volume until we reach the freezing point line, and then we read the corresponding salinity from the X-axis of the TS diagram. This will be salinity S_T .

Column 8. t_c is the overall temperature of the mixed layers. It is found from the TS diagram, as the temperature corresponding to the specific volume and the mean salinity of the mixed layers at the given level.

Let us note that although salinity S_m is greater than the salinity S_T , temperature t_c may have different values. If S_T is higher than S_m , temperature t_c is always equal to the freezing point.

Column 9. The difference between columns 5 and 8, or $t_m - t_c$.

Column 10. q_t is the amount of heat in kg-cals released with convective mixing (down to the given level) by each square cm of the sea surface, provided the mean temperature of the mixed layers drops from t_m to t_c . It is computed by the formula

$$q_t = 0.1 (t_m - t_c) p.$$

In this computation the specific heat of water is taken as unity.

Column 11. ΔS is the salinity increase, of layers mixed to a given level, necessary for the general specific volume of these layers at the freezing point to equal the specific volume observed at the given level. It is computed as the difference of columns 7 and 6 by the formula

$$\Delta S = S_x - S_m$$

and is entered in the table only when this difference is positive.

Column 12. i is the thickness (in cm) of the ice formed during convective mixing to the given level. It is computed by the formula

$$i = \frac{100 p \Delta S}{S_m},$$

where ΔS is taken from column 11 and S_m from column 6. It is assumed in this formula that the density of ice is 0.9 and the salinity of the ice is 0.

Column 13. q_i is the amount of heat in kg-cal released by each square cm of the sea surface, provided that convective mixing reaches to the given level and ice of thickness i forms. It is computed by the formula

$$q_i = 0.072 i,$$

where i is the thickness of the ice in cm taken from column 12. In the formula it is assumed that the density of ice is 0.9 and that the heat of fusion is 80 gm-cal.

Column 14. $q = q_t + q_i$ is the sum of the heat released by each cm^2 when the sea cools to temperature t_c (column 8) and the heat released when ice of thickness i forms. This is computed as the sum of columns 10 and 13.

It follows from this table that in the given example, convective mixing extending to 15 m requires no ice formation whatsoever, and in this case, the temperature of these 15 m drops from $t_m = 9.1^\circ$ (column 5 of the table) to $t_c = 6.4^\circ$ (column 8). But if mixing reaches a depth of 20 m, the temperature of the entire 20 m layer not only becomes equal to the freezing point, but ice 13 cm thick (column 12) forms on the sea surface.

Further, from this table it is evident that for the vertical winter circulation to reach the bottom (65 m) the sea surface in the examined case must release to the atmosphere 65 kg-cal/cm^2 (and, during this, ice 505 cm thick must form).

Finally, from the same table we see that with convective mixing to any level, the temperature of the mixed layers (t_c) is always lower than the temperature at this same level before the start of mixing (t) which indicates the creation of a temperature inversion. The data of this table are depicted graphically in figure 17.

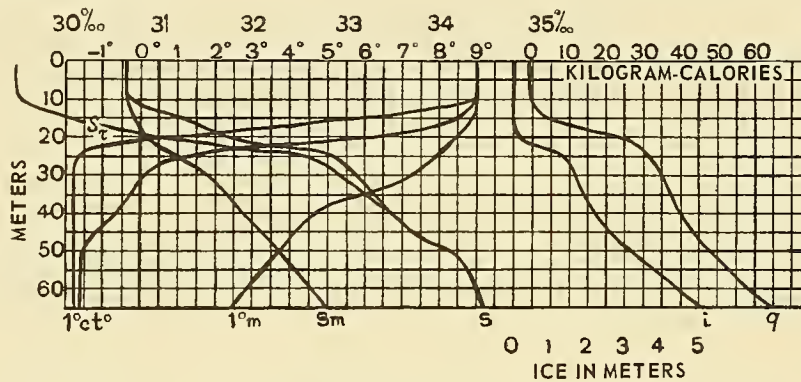

Figure 17. Vertical winter circulation elements in the Bering Sea.

In this diagram, the levels of the sea surface are plotted along the Y-axis, while the temperature t_m , salinities S_m and S_T , the ice thickness i , and the total amount of heat q , released by the sea to the atmosphere during vertical winter circulation are plotted along the X-axis; the corresponding points are then connected by smooth curves.

In the diagram we can easily determine the mean temperature from the surface to any level, from the t_m curve. We solve the same problem for salinity from the S_m curve. The curves of the amount of heat and the thickness of ice formed allows us to judge these magnitudes during vertical circulation extending to any level. The curves thus constructed allow us to answer the following questions: How much heat must be released to the atmosphere by the sea in order for the vertical circulation to reach a given level? Is this accompanied by ice formation, and if so, of what thickness? To what depth does circulation reach if ice of the given thickness forms?

Figure 18 shows the isolines of the heat emission in kg-cal/cm^2 of the sea's surface, with vertical circulation reaching the given depth which I computed for the Barents Sea by the described method. The dashed line shows the isoline of the ice thickness (in meters) which forms with mixing to the given level. The observations were conducted by the Oceanographic Institute (Okeanograficheskii Institut) along the Kola meridian ($33^\circ 30'$ east) in August 1931.

It is seen from the figure how much deeper the vertical winter circulation penetrates with the same amount of heat which is released to the atmosphere by the sea, e.g., at 74° north, compared

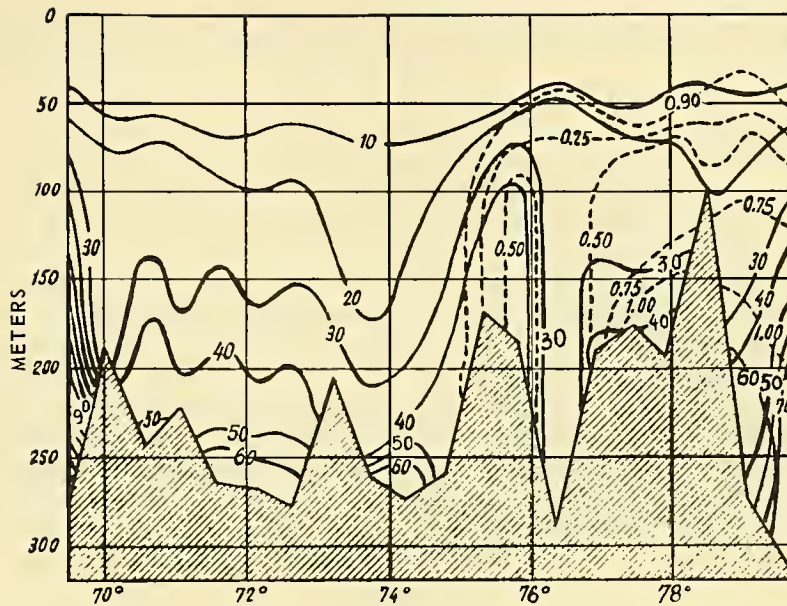

Figure 18. Isolines of the heat emission with vertical winter circulation in the Barents Sea.

with the coastal region ($69^{\circ}30'$ north). In the first case, with 20 kg-cal/cm^2 released to the atmosphere, the vertical circulation penetration drops to 175 m, in the second case it drops only to 65 m.

This phenomenon is explained by the large vertical salinity gradients at the coastal stations, where these gradients are created by shore run-off. From this, it is easy to see that the vertical circulation reaches the bottom mainly in coastal shallows and in individual banks in open sectors of the sea.

Figure 19 shows the isotherms in one of the cross sections made by the *Perseus* in the Barents Sea in March 1934. As was to be expected, particularly off shore, when convective

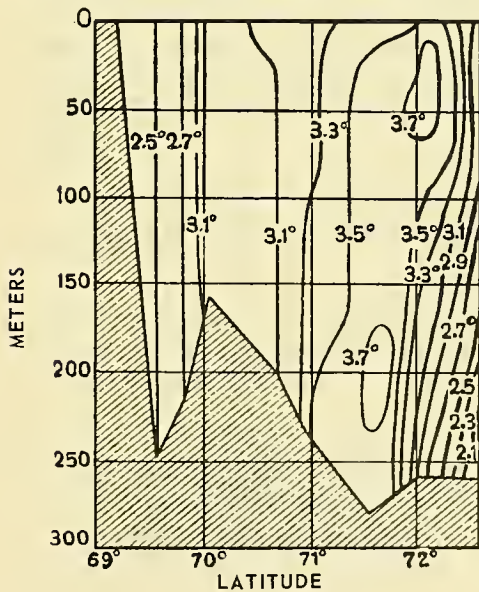

Figure 19. The influence of vertical circulation on temperature distribution.

mixing joins with frictional, and where heat, released to the atmosphere from the sea in winter is greater than in the open sea, the isotherms are completely vertical, which is always a sign of convective mixing.

LITERATURE: 47, 62, 65, 77.

Section 31. The Index of Freezing

In figure 17 the point of intersection of curves S_m and S_τ attracts our attention. This point is significant in that vertical circulation may proceed to that level where this point is located, due solely to a drop in the temperature of surface layers of the sea. For vertical circulation to penetrate deeper than this point, the surface layers must increase in salinity and accordingly, ice must form. On the diagram, curves S_m and S_τ intersect at a depth of 18 m. For this depth

$$\begin{aligned} S_m = S_\tau &= 30.70\text{‰}, \\ t_m &= 8^\circ.6, \\ \tau &= -1^\circ.7. \end{aligned}$$

From this we get

$$\begin{aligned} t_m - \tau &= 10^\circ.3, \\ q_\tau &= 0.1 (t_m - \tau) p_\tau = 18.5 \text{ кг-кал/см}^2, \end{aligned}$$

where p_τ is the depth to which vertical circulation may proceed without the formation of ice, (in the given example 18 m); I have called this depth the critical depth of vertical circulation, and q_τ is the amount of heat which must be released to the atmosphere during the process; I have called this value the index of freezing of the sea.

In the preceding paragraph we gave the complete procedure for computing vertical winter circulation. Naturally, even with such a calculation, the computations should be made only to that level at which the amount of heat released to the atmosphere during vertical circulation does not exceed the total amount of heat released by the sea to the atmosphere in a given region during the winter.

If we limit ourselves only to a determination of the indices of freezing, it would be unnecessary to compute the elements of convective mixing from the surface of the sea all the way to the bottom, but only to the level at which S_m and S_τ are equal.

We have assumed that the vertical distribution of temperature and salinity at the oceanographic station whose data has been given in table 23 changes only as a result of vertical winter circulation. But let us assume that before the very start of this circulation, the layers from the sea surface to a depth of 25 m, will be mixed by the wind.

From table 23 it is easily seen that in this case the overall temperature of the mixed layers will be 7.2° and the overall salinity 31.13 ‰, with a corresponding specific volume of 76.21. In order to cool this 25 m layer to -1.7° , i. e., to the freezing point, the sea must release to the atmosphere 22.3 кг-cal/cm^2 .

But we have seen that at the examined station during cooling under calm conditions, the critical depth of vertical circulation was only 18 m, so that the amount of heat released to the atmosphere was only 18.5 kg-cal/cm².

Thus we find that before the start of cooling, the surface layers of a given station are mixed to a depth of 25 m, before the start of the ice formation, 3.8 kg-cal/cm² more should be released to the atmosphere during calm conditions. It should be noted that such an increase in the index of freezing takes place only if wind mixing encompasses layers deeper than the critical depth of vertical circulation; in our example, below 18 m. But, if under the same conditions wind mixing proceeds to the level of temperature inversion (if in the given region such exists) there may be such an increase in the index of freezing that ice formation in a given region becomes completely impossible. This circumstance should be considered when computing the indices of freezing.

From all this, it is clear that if in the pre-winter period we set up a network of oceanographic stations in the region of interest to us, plot on a chart the indices of freezing computed for each of them separately by the method described earlier, and draw the corresponding isolines, we may in first approximation, judge at which of the stations, all other conditions being equal, the temperature of the sea surface will drop first to the freezing point, and at which it will drop last, or, in other words, where ice formation will set in earlier and later.

Naturally, in addition to the indices of freezing, we need to know the rate of cooling of the separate regions of the sea, i. e., the amount of heat released from the surface of the sea to the atmosphere during 24 hours under various conditions, taking these conditions into account we could judge approximately the time when freezing would begin.

LITERATURE: 65.

Section 32. Features of Vertical Winter Circulation in the Shallows

Let us assume that from observations, the horizontal oceanographic gradients at the initial moment in the examined sector of the sea are equal to 0, while the vertical gradients are uniform, i. e., that the sea consists of horizontal layers, which are uniform with respect to temperature and salinity. Let us further assume that at a certain moment the vertical circulation extends to the top of a submarine bank (figure 20). At this moment, "ventilation" of the top of the bank begins, as follows, the surface layers (oxygen enriched due to exchange with the atmosphere and enriched with nutritive matter as a result of the photosynthetic action of plants) will be continuously mixed with the bottom layers.

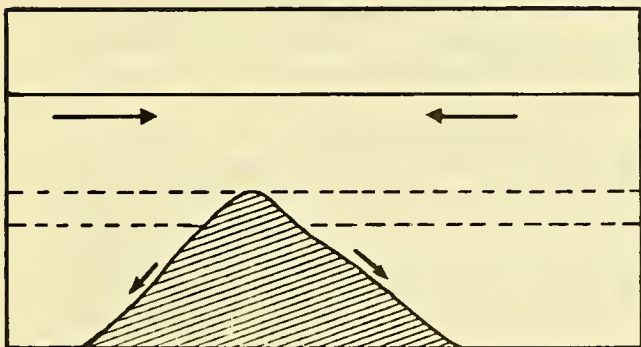

Figure 20. Diagram of the creep of cool waters along the slopes of the shore.

With further cooling of the sea surface, the lower boundary of vertical circulation, dropped even more. But here, naturally, the water above the top of the bank cooled somewhat more and correspondingly its density becomes somewhat greater than above deeper places. As a result, the colder deeper waters start to creep down the slopes of the bank until they drop to the level with equal density. In turn, the creep of the water from the slopes is compensated for by a rise in the deep waters which creates circulation, as indicated in figure 20 by the arrows.

We should note that such a phenomenon is of considerable significance only when the surface layers of the sea have comparatively high initial temperatures. Actually, we have seen that with temperatures close to the freezing point, a temperature change has practically no effect on density. It is a different story when vertical circulation is accompanied by ice formation and the salinity increase which goes along with it.

If the depth of the bank is less than the critical depth of vertical circulation, the temperature of the water above it drops to the freezing point sooner and ice formation starts earlier.

Further, we have seen that the salinity increase in the sea during ice formation, if we assume the salinity of ice to be 0, is determined by the formula

$$\Delta S = \frac{0.9i}{p} S,$$

where i = the thickness of the ice,
 S = the salinity of the water from which the ice forms,
 p = the depth of propagation of vertical winter circulation.

Assuming that the initial salinity is 15 o/oo and the thickness of the ice forming in winter is 2 m, which is common for the regions of the New Siberian Islands, for example, we find that toward the end of winter the salinity at the 10 m depth has increased to 17.6 o/oo and at the 5 m depth, to 20.4 o/oo, which gives, in the first case, a natural density of 14.12, and in the second case, 16.38. Understandably, such a large difference in densities unfaillingly involves creep of cold and more saline waters to deeper locations or, at least, to deeper levels. Naturally, such phenomena are observed off-shore, particularly in shoals and are realized to a very great extent in the frozen reaches of the ocean, particularly in the Arctic Basin.

LITERATURE: 62, 77.

Section 33. The Cold Intermediate Layer

The vertical winter circulation continues as long as cooling does, and at the moment it ceases, it is characterized by the amount of heat released by the sea, by the thickness of the mixed layers, and by their overall temperature. The latter, in the case of ice formation, naturally is equal to the freezing point, while in the absence of ice formation, depending on the vertical salinity gradient it may be either higher or lower than the temperature of the lower lying layers.

Let us assume, as in the majority of cases, that the temperature of the mixed layers is lower than the temperature of layers not affected by vertical circulation (temperature inversion) and let the lower circulation boundary at the moment it ceases, be defined by depth p' . In this case, the vertical temperature distribution is represented schematically by curve $abcd$ (figure 21). Let us further assume that at this same moment summer heating of the upper sea layers begins, gradually extending to greater and greater depths. Correspondingly, (if the heating proceeds under calm conditions) the upper layers heat through and the vertical temperature distribution is shown by curve

$a'bcd$. Thus, as a result of winter cooling and the subsequent summer heating, a cold intermediate layer is formed between levels p and p' .

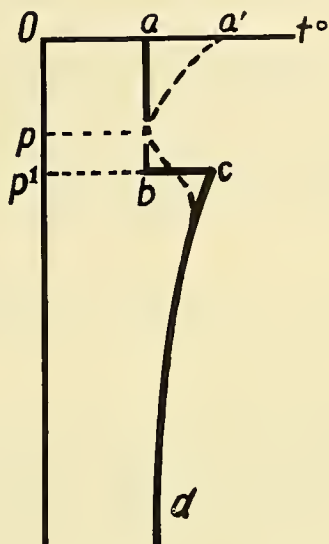

Figure 21. Formation of the cold intermediate layer.

We see that in time the cold intermediate layer, no longer maintained by cooling from above, will be gradually eliminated from below by frictional mixing with lower lying layers, and from above by continual heating and by frictional mixing with the upper, warmer layers, which is shown on the temperature curve by a gradual elimination of points on the curve, as is shown in figure 21 by the dashed lines.

If winter cooling, as compared with summer heating, were not sufficiently intense, in time all traces of a cold intermediate layer would disappear. On the other hand, if winter cooling is sufficiently intense traces of the cold intermediate layer will remain even toward the start of new cooling. The cold intermediate layers formed as a result of vertical winter circulation and summer heating are characteristic during spring and summer for all seas of the temperate and polar latitudes with noticeable vertical salinity gradients. Depending on local conditions, the cold intermediate layer may be temporary, disappearing after a year, or continual, i. e., maintained over many years. Depending also on local conditions, the temperature of the cold intermediate layer may be comparatively very high and very low--close to the freezing point.

The less the summer heating and the stronger the winter cooling, the deeper the lower boundary of the cold intermediate layer will drop, and the lower will be its temperature. When the vertical winter circulation is accompanied by ice formation, the temperature of the cold intermediate layer drops to the freezing point.

Tables 24 and 25 give examples of spring and summer distribution of temperature and salinity in regions of ice formation.

TABLE 24. BERING SEA, 14 JULY 1932. 52°42' NORTH, 150°03' EAST.

p	. . .	0	10	25	30	40	75	100	150	300	500
t°	. . .	10.80	4.22	0.86	0.70	-0.06	-0.30	-9.22	0.00	1.11	3.35
S o/oo.	. . .	28.59	32.27	32.72	32.90	33.06	33.26	33.35	33.33	33.53	34.04

TABLE 25. BARENTS SEA, 25 AUGUST 1931. 79°03' NORTH, 37°02' EAST.

p	. . .	0	10	25	50	75	100	150	200	250	270
t°	. . .	2.44	2.43	2.44	-1.71	-1.45	-1.26	-1.35	0.59	0.81	0.86
S o/oo.	. . .	33.81	33.82	33.85	34.29	34.37	34.47	37.74	34.86	34.88	34.96

In the Bering Sea the cold intermediate layer is considerably less evident towards the middle of July, thanks to summer heating and mixing. In the Barents Sea, toward the end of August at a depth of 50 m, the freezing point is still maintained, mainly because this station is located close to the retreating edge of floating ice. This ice obstructs deep penetration of solar radiation and consequently, heating.

As this example shows, the cold intermediate layer is generally most clearly expressed and is preserved longest of all at the edge of melting ice. Thus, by the way, the cold intermediate layer in ice regions is expressed in summer, we can judge when the sea will open. On the other hand, in regions where the ice is carried by the wind and currents only, no formation of the cold intermediate layer is observed.

Figure 22 shows the isotherms of the cross section which we made aboard the *Perseus* on 5 to 10 August 1928 in the Barents Sea along the edge of melting ice. From this it is clear that along the entire cross section, approximately between the 20 and 120 m levels, a strong cold intermediate layer with a temperature considerably less than -1° is observed.

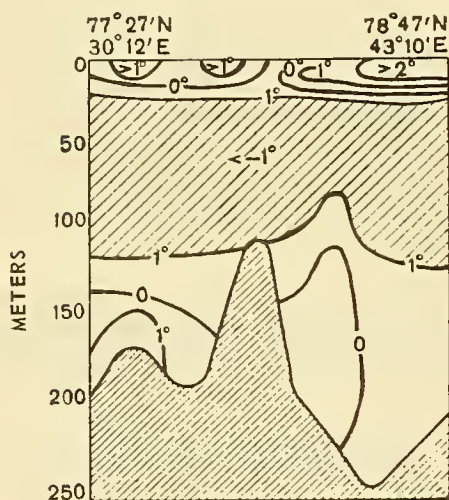

Figure 22. Cold intermediate layer in the Barents Sea in August 1928.

In regions of the sea where the vertical winter circulation encompasses the tops of submarine elevations and banks, the phenomenon of the cold intermediate layer has certain peculiarities.

Let us assume that at the time the lower boundary of the vertical winter circulation occupied a certain position below the top of a submarine elevation, winter cooling ceased, and in conjunction with the start of summer heating, formed the cold intermediate layer. Gradually, due to the absorption of solar radiation and due to frictional mixing, this layer will be eliminated from above. At deep places it will be eliminated by frictional mixing from below, as well. If the submarine elevation in question lies in the path of a warm current, as happens, e. g. , in the southern part of the Barents Sea, the effect of the washing away of the remains of the winter regime by warm waters, both from above and below, will be added to the effect of radiation and frictional mixing. Since the velocity of the current above submarine elevations is less than above deep water troughs, it is natural that this washing effect is greater in the troughs.

LITERATURE: 47, 62.

Section 34. The Discontinuity Layer

We use the term discontinuity layer to designate that layer where the corresponding vertical gradients are large--temperature, salinity, oxygen content, density, etc. , depending on which of the oceanographic characteristics actually change most rapidly in the given layer.

The discontinuity layer of density is naturally of particular significance in the ocean regime; this indicates the high stability of the surface which separates the given layers.

As we have seen in Section 27, the overall stability of layers is comprised of the stability which is determined by the vertical temperature distribution and the vertical salinity distribution. It follows from this that there is great stability when the temperature and salinity stabilities are combined e. g. , with simultaneously heating and salinity increase of the surface waters, or when fresher, warmer shore waters are superimposed on more saline and colder ocean waters.

Generally, in the surface layers of the low latitudes a temperature discontinuity layer prevails which becomes weakened, and sometimes even eliminated, by convection due to an increase in salinity during evaporation. In the temperate latitudes the temperature discontinuity layer is characteristic of summer, and is usually eliminated by winter cooling. In the high latitudes in summer, the salinity discontinuity layer is characteristic, forming as a result of a temperature increase and the melting of ice, and disappearing in winter during ice formation. Thus, depending on local conditions, the density discontinuity layer may be either temporary, seasonal, or continuous. The depths of the disposition of the discontinuity layer also vary within wide limits, depending on local conditions. We have seen that if the layer stability is high, frictional mixing is very much hindered, or almost ceases. In this case the layers slide one along the other, as it were, and the circulation in each of them has its own particular nature, reminiscent of the circulation in shallows, where the current at the upper levels may be directed in one direction, while in the lower levels, in the opposite direction, for compensation.

The density discontinuity layer which is clearly expressed in certain ocean regions creates another extremely interesting phenomenon, as for example the phenomena of "dead water," "mire," etc.

If the discontinuity layer is located not far below the surface of the sea (within the reach of a ship's draft), when a ship passes through the discontinuity layer waves are set up which increase

the drag of the water. Then the ship loses quite a bit of speed. Thus, the velocity of the *Fram*, which entered the region of dead water off the Taimyr Peninsula on 29 August 1893, dropped from 4.5 to 1 knot.

The concept of mire was established in connection with the development of submarine navigation. Submarines, in regions where a sharp density discontinuity layer is observed, on submerging, balance their buoyancy in such a manner that they sink in the upper layer and ascend in the lower layer. In such a case, the boat may lie on a discontinuity layer without moving as if on a real bottom.

LITERATURE: 62, 103.

Section 35. The Distance Transfer of Temperature Anomalies of the Ocean

As soon as the surface temperature of a certain ocean region deviates from the norm for some reason or another, this anomaly is immediately transferred to the bottom (by mixing) and horizontally (by currents).

Let us assume that a temperature anomaly is created in the center of a rectangular canal throughout whose cross section there flows a current caused by some force or another. This anomaly is immediately reflected in the slope of the longitudinal level of the canal. It can be easily seen that with a negative anomaly in the upstream part of the canal the current velocity increases, while in the downstream part of the canal, it decreases. Conversely, with a positive anomaly, the velocity of the current upstream decreases, and the downstream increases.

Thus, any temperature anomaly inevitably creates an anomaly of the velocity of the current, whereupon if the temperature at any place upstream anomalously increases, this causes an increase in the downstream velocity, and vice versa.

Let us further assume that we are dealing with a warm current, i. e. , with one for which the temperature dropped downstream, (e. g. , the Nordkapp, Spitsbergen, and deep Arctic currents) and that for some reason or another the velocity of the current increased in a certain part of it. If we assume that in the time it takes to run from this region to another, the current is cooled proportionally to the time of this run, it appears that the temperature downstream should increase even when the temperature does not change upstream. It is evident that for a cold current (the Greenland current) with an increase in the velocity upstream, the temperature of the current downstream drops correspondingly. Thus, temperature changes result in velocity changes, and vice versa. For a warm current, temperature and velocity changes are unidirectional. In first approximation, we may consider that an increase in the temperature of such currents is proportional to an increase in their velocities, and vice versa. The reverse phenomena should be observed in cold currents.

Let us now assume that in a certain time interval the temperature increases upstream. Accepting the fact that here the current velocity does not change throughout its entire length, as is the case with conditions of heat exchange with the atmosphere and the contiguous waters, we find that the temperature increase noted anywhere upstream will consequently be noted in ranges located further downstream. Thus the propagation rate of a temperature anomaly will be determined by the velocity of the current itself, and sometimes may serve as a reliable means for actually judging the mean velocity of this current.

We submit figure 23 as an example; according to Nansen and Helland-Hansen the mean May temperatures in the hydrological cross-sections of the Songe Fjord, the Lofoten Islands, and along the Kola Meridian, and the area of the open water in the Barents Sea in May are shown here. From the figure it is clearly evident that the rise and drops in temperature, noted on the Songe Fjord are noticed after a year in the Lofoten Islands, and in the following year in the Kola Meridian and in the iciness of the Barents Sea. There were not sufficient further investigations at Songe Fjord and Lofoten Islands cross-sections to be able to continue this comparison. In any event, by analyzing the available data from the Songe Fjord cross-sections in May 1925 and 1929 and in August 1928 and 1932, Helland-Hansen notes that evidently in 1928, highly saline Atlantic water entered the Norwegian Sea. In 1931 Mosby also detected water of increased salinity northeast of Spitzbergen. Accordingly, 2 to 3 years are evidently required for Atlantic waters to move from the Norwegian coast to the northeast shores of Spitzbergen.

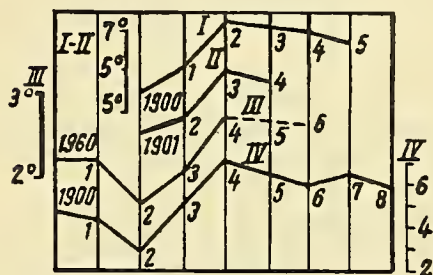

Figure 23. (1) Mean May temperature cross sections at Songe Fjord; (2) mean May temperature cross sections at the Lofoten Islands; (3) mean May temperature cross sections along the Kola Meridian; (4) area of open water in May in the Barents Sea.

Developing Nansen's and Helland-Hansen's ideas, I came to the conclusion, based on calculations of the velocities of the Nordkapp current, that the waters of this current require about 1 year to reach the northern part of the Kara Sea. On the other hand, considering that the Nordkapp current is only a branch of the main Spitsbergen currents, I assumed that at the moment the crest of the thermal wave is noted off Murman, this same crest, travelling along the main Spitsbergen current, should be located off the southern shores of Spitsbergen. The following year the crest should be located in the region to the north of Spitsbergen, and the year after, it should appear in the region between Franz Joseph Land and Severnaya Zemlya. Thus, the temperature anomalies noted along the Kola Meridian should be observed to the north of Mys Zhelaniya within a year, and in the northern part of the Kara Sea in two or three years.

Karakash and Somov further showed that the temperature anomalies observed along the Kola Meridian are reflected in the iciness of the Laptev Sea in four years.

Figures 24 and 25 according to Somov, show the distribution of temperature anomalies all along the Kola Meridian in 1935 and 1937.

But, anomalies of the temperatures of sea currents create corresponding anomalies in the heat flux from the sea into the atmosphere. In particular, for the northern part of the Kara Sea we must consider that the further north the positive temperature anomaly, the further north the paths of cyclones pass.

Figure 26 shows according to Somov, the dependence of the trajectories of cyclones on the difference of the mean annual temperatures in the cross-section along the Kola Meridian. The solid line shows the mean latitude of the cyclone trajectories in the northern part of the Kara Sea for 1930 to 1938 (according to Drogaitsev) and for 1939 to 1940 (according to Somov).

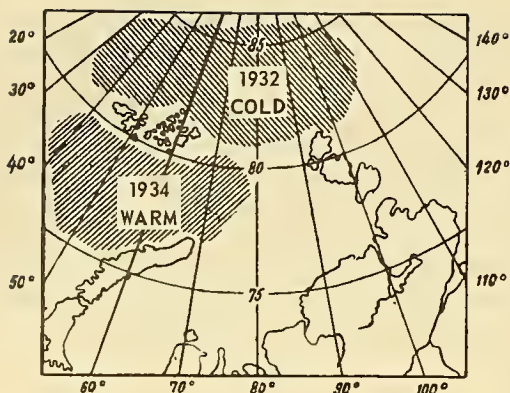

Figure 24. Distribution of temperature anomalies in 1935.

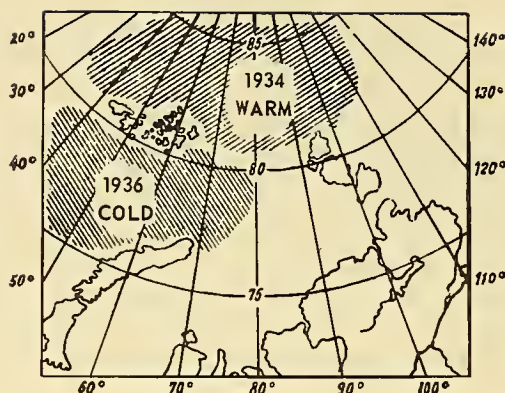

Figure 25. Distribution of temperature anomalies in 1937.

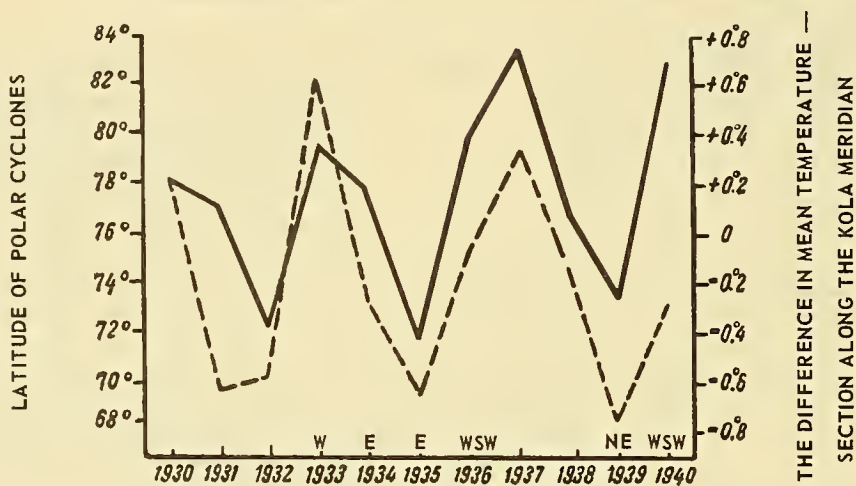

Figure 26. The trajectories of cyclones as a function of the difference in mean annual temperatures in the cross sections along the Kola Meridian.

The dashed line gives the curve of the underlying surface, and is constructed in the following manner. For example, for the 1930 curve, we take the difference in the mean annual temperature along the Kola Meridian for 1927 (northern region) and for 1929 (southern region); for the 1931 curve, we take the difference in the indicated temperatures for 1928 and 1930, etc. The positive sign of this difference shows that the positive anomaly for a given year is greater in the northern region than in the southern, and vice versa, (figures 24 and 25).

Examining figure 26, we see that the curves intersect quite well, and, although Somov considers the 11-year series of observations insufficient for a final representation of the proposed hypothesis, I have no idea about not accepting its correctness.*

*I made plans for expeditions in 1932 aboard the *Knipovich* (sailing around Franz Joseph Land at this time) and in 1935 on the icebreaker *Sadko* (setting a record, as yet unsurpassed, of open sea navigation to 82°42' north in this year) based on actual calculation of the time of the appearance of the crests of several waves noted in the cross section along the Kola Meridian.

As Drogaitsev currently points out, in the Arctic Seas where we encounter intimate expanses of open water and ice masses in close proximity, the horizontal temperature gradients of the underlying surfaces are large enough to change atmospheric pressure at sea level, i.e., that recorded on synoptic charts.

We must also add to Drogaitsev's discussion that it is not so much the actual air temperature, as the processes of evaporation and condensation which absorb and release enormous quantities of heat that play a role in the thermal interaction of the ocean and the atmosphere. These processes, as we have seen, are determined by the water vapor pressure, while the later process (condensation) is not the same over ice and water, even when their temperatures are the same. Therefore, there can never be equilibrium in the atmosphere above ice and above the sea.

Changes in atmospheric pressure cause corresponding changes in wind direction, while this latter case causes changes in air temperature, in the amount of advective heat, etc.; these in turn are all reflected in the ocean's regime.

Up to this point we have examined anomalies which are created in individual regions due to anomalies in the temperature of sea currents. We may note that the effect of even slight anomalies of this type may be increased considerably by the pressure distribution anomalies imparted by them, and even more so by the wind distribution anomalies.

Actually, the corresponding wind distribution may, for example, break up the ice and create between the pieces a considerable band of open water or, may drive the ice away from the corresponding shore. The spaces of open water formed absorb solar radiation considerably better than the ice, and therefore the horizontal air temperature gradient increases, the pressure gradient intensifies, etc. Thus, the pressure and wind distribution anomalies created by the temperature anomalies and sea currents may, under certain combinations of physical-geographic conditions, play the role of resonators, strongly increasing the magnitude of these anomalies.

Naturally, for the transfer of temperature anomalies by sea currents, the following are characteristic: 1) All other anomalies of the physical-chemical characteristics of a water mass are simultaneously transferred (e.g., salinity) and 2) This process generally requires a long period of time. For example, according to my calculations the temperature anomaly of Atlantic waters, observed off northwestern Spitsbergen, should in some way or another be reflected in Bering Strait only after 4-1/2 years. Dobrovolskii, having determined the propagation rate of Atlantic waters in the Arctic Basin for observations at the station "North Pole" and on the *Sedov* arrived at the same results.

Vize has told me that according to his 1943 calculations, the anomalies of temperature, pressure, iciness, etc., spread in the seas of the Soviet Arctic from west to east at a rate of 20° longitude per year.

We have seen that any sea temperature anomaly causes changes or shifts in one direction or another of the pressure topography. However, a change or shift of the pressure topography in one region of the sea causes definite shifts in that of the adjacent regions.

Figure 27 (according to Ovchinnikov) shows the connection between the departures in the temperatures of the January cross-section along the Kola Meridian (33°30' east), in the Barents Sea and the deviations of the winter air temperatures (December-February) from the mean multi-annual temperatures at the "Uellen" polar station and the iciness of the Chuckchee Sea in degrees of concentration.

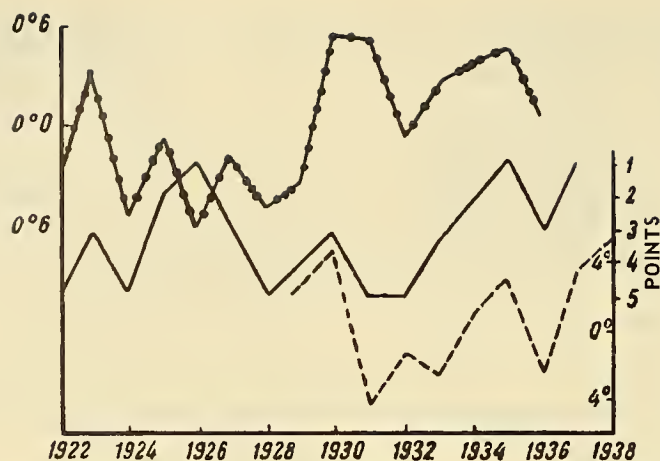

Figure 27. Departure of the temperature of the cross section along the Kola Meridian on 15 January from the mean multiannual (•—); departure of the winter air temperature (December to February) at the "Uellen" polar station from the mean multiannual (—); iciness of the Chuckchee Sea in degrees of concentration (--).

Figure 28 (also according to Ovchinnikov) shows atmospheric pressure in December for a number of years at Cape Barrow and at the center of the Iceland minimum.

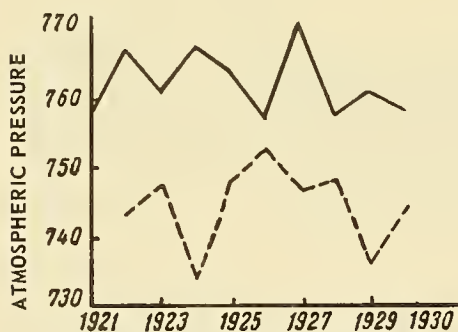

Figure 28. Mean atmospheric pressure in December at Cape Barrow (—) and mean atmospheric pressure in December at the center of the Iceland minimum (--).

Examining these figures we see a definite parallelism in the phenomena in quite widely scattered regions of the ocean, while these phenomena are somehow or other connected with the corresponding changes in the temperature of the ocean's surface layer (causing them, or vice versa, being caused by them).

Thus, a change in the temperature of the water's surface layers, causing changes in the pressure topography in one region of the ocean (in a definite period of time and in a definite direction for each region), affects the temperature of different regions of the ocean, sometimes located very far away from the given region.

LITERATURE: 46, 66, 77, 109, 125, 143.

CHAPTER IV

ICE FORMATION AND ICE TYPES IN THE SEA

Section 36. The Concept of Ice Formation

In regard to what we have learned about crystallization, ice formation does not begin immediately throughout the entire liquid after cooling to the melting point, but at individual, chaotically, but equally distributed points in it, where nuclei of crystallization are already present or are being formed. The process of generation of nuclei of crystallization is unknown. It is considered that nuclei of crystallization occur around the smallest suspended particles of organic and inorganic origin, which always exist in natural water and which are formations of the most varied size, form, and structure. In particular, Wegener points out that the dust carried by air consists primarily of quartz grains which serve as excellent nuclei of crystallization. Under natural conditions, besides this, the tiniest of ice crystal particles already existing in a given volume of water, are snow crystal particles which fall on the surface, these often serve as nuclei of crystallization. Ice and snow crystal particles, as Altberg points out, play a dual role: on one hand, they play the role of nuclei of crystallization around which further ice accretion occurs, on the other hand, they are special seeds, viz., accelerators of the growth of nuclei of crystallization and their conversion into elementary ice particles.

The effect of ice crystal particles as seed crystals is easily demonstrated by the experiment described by Shenrok.

A grain of salt with snow flakes on it was thrown into slightly supercooled water. This grain slowly sank to the bottom of the vessel and during this the effect of "a crawling meteor with a tail behind it" was created. The crystal particles moving through the water in turn continually caused the formation of other crystal particles, so that the water was gradually enriched by them. The process occurred much faster when the water was agitated.

The initial formation of nuclei of crystallization and elementary ice particles always requires a certain supercooling of the liquid. The purer the liquid and the calmer its state, the greater must the original supercooling be. It is known that under laboratory conditions, pure water can be cooled to -32°C , but it is enough even for a slightly supercooled liquid, to introduce a small piece of ice to start rapid ice formation immediately. As Altberg shows, a single grain of ice thrown into a tank of water supercooled to -0.1° creates 2 to 3 kg of ice in 30 seconds.

In natural water there are always some types of impurities on which nuclei of crystallization will form, and furthermore natural waters are always involved in some movement for some reason or another. Because of this, the supercooling necessary for the formation of nuclei of crystallization in natural water, is always extremely slight; it is less, the more intense is the movement of the water and the more particles are suspended in it.

Supercooling of water is also necessary for the further accretion of ice on nuclei of crystallization. Actually, this process requires a slight temperature difference between water and ice,

which causes a constant flow of heat across the water-ice surface of separation. In this way, ice particles whose temperature is 0° are, so to speak, surrounded by pockets of warm water during ice formation which protect them from excessive cooling. Conversely, during ice melting, when heat is introduced from without, the ice particles are surrounded by a pocket of cold water which prevents the ice temperature from rising above 0° .

Figure 29 shows the temperature variation during ice formation in agitated fresh water (according to Altberg). If water is cooled considerably and at the same time vigorously agitated, the temperature sometimes drops to -0.2° before ice formation begins. Then, as the amount of ice increases, the temperature of the water rises to 0° .

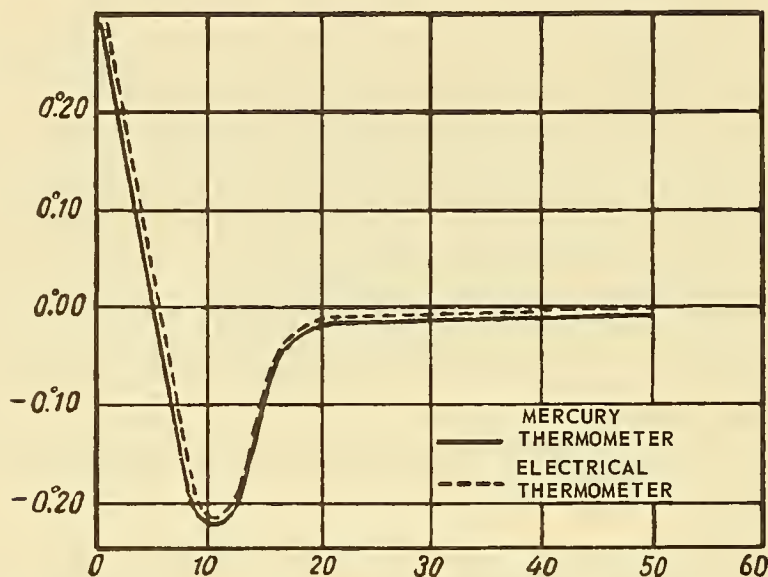

Figure 29. Changes in water temperature during ice formation.

Thus, the basic condition necessary for ice formation is a certain supercooling of water.

Furthermore, for the conversion of water from its liquid into its solid phase, it is necessary to remove a comparatively large amount of heat from it--the heat of crystallization. Consequently, the second necessary condition for ice formation is the assurance that water will, by some means or another, lose a great deal of heat.

LITERATURE: 4, 5, 40, 62, 141.

Section 37. Ice Formation in Fresh Waters

Let us assume that we have a certain volume of fresh water which is being cooled from the surface, and which is at rest. Since the freezing point of fresh water is lower than its temperature of maximum density, by the time the temperature of the surface layer reaches the freezing point, all convective currents have ceased. A certain supercooling of a very thin surface layer causes the formation of nuclei of crystallization in it. The distribution of these nuclei along the surface of the water will naturally be chaotically uniform, but further developments cannot of course be uniform in all directions.

Actually, the heat of crystallization released during ice formation must immediately be released to the atmosphere for the process to continue, since otherwise it will be used in raising the temperature of the layer. Hence, it is most natural that the growth of the nuclei develops primarily in a horizontal direction and, due to this, prismatic crystals are formed first whose optic axes are parallel to the terrain of freezing. Further, in the cells between them, according to Golovkov's microscopic experiments, plate crystals developed whose optic axes are perpendicular to the plane of freezing. From the moment the possibility of further horizontal growth of crystals is halted by contact with adjacent plates, a growth of vertically oriented crystals begins to predominate. This process is disrupted only when separate rapidly developing vertically oriented crystals turn on their sides.

As a result, we obtained ice which resembles a fusion of truncated prisms and pyramids which face upward and whose form more or less approximates a hexagon, and whose cross section slowly decreases downward.

Inasmuch as the ice crystals consist only of water molecules, all impurities gradually pass from the water into the interlayers between the crystals. The basic mass of a salt solution, due to its great density, runs downward, while air bubbles are forced out by the continuing growth of the crystals. Thus, when water is in a calm state and is gradually cooled, a pure surface ice of needle structure, free of impurities and air bubbles, is formed.

The needle structure of ice is most clearly evident, e.g., in ponds during spring, when melting begins. Solar heat is absorbed mainly by the salts and slime inclusions contained between the layers surrounding the individual crystals. As a result, the lower surface of this ice appears honeycombed, as if it had been peppered with sharp barbs, that is, crystals of pure ice separated from each other by films of melt water containing slime and salts.

Needle ice, as we have seen, is formed under the condition that the water is at rest. But if the water is sufficiently agitated, ice forms in a somewhat different manner. Actually, the supercooling of water which is necessary in this case, for the creation of nuclei of crystallization, can appear in the entire volume of the agitated liquid, and then ice formation will begin around the formed nuclei. The released heat of crystallization is carried off to the surface by the eddies which form during the agitation, and these same eddies constantly bring supercooled water particles from the top, which according to Altberg, guarantees further development of the process. Thus, if ice formation in still water always begins at the surface, with sufficient agitation of the water, ice formation can begin at a certain depth, or even near the bottom. For this, the essential factors (according to Altberg) are: water in the state of motion (the dynamic factor) and supercooling it (the thermodynamic factor).

Because of their small size, the ice particles which form within the mass of water do not float to the surface immediately, but are carried from place to place, freeze together on contact, and finally rise to the surface. During the formation of deep ice, the water ordinarily contains myriads of ice particles throughout its entire mass which are barely visible; they appear as shining dots when the observer sees them at a certain angle to the sun's rays. It is noted that when a small piece of ice is introduced into supercooled water, a certain clouding of the water occurs at first which is called ice fog. Then, tiny ice particles, which are true colloids, collect into bunches, grow, and finally turn into a spongy mass saturated with water.

According to Altberg, who formulated the above theory of deep ice formation, the elementary particles of this ice are perfectly round discs with mirror-like side surfaces and an even, as it were, polished, rim (figure 30). This form of deep ice elements is explained by the melting and

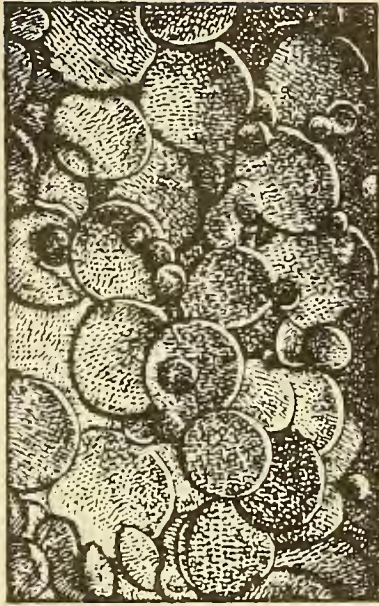

Figure 30. Disks of deep ice.

abrasion of their edge as a result of a great number of collisions with other elements during their rise to the surface of the water. A unit of such ice is completely transparent and is visible in water only in the case of complete internal reflection; ordinarily it is about 4 to 8 mm in diameter and 0.1 mm or less thick.

The nuclei of crystallization which form in the film of water enveloping bottom objects lead to the formation of a variation of deep ice, bottom ice.

It has been noted that the intensity of bottom ice formation is not the same on all objects: it forms very well on metallic objects, less well on glass, and hardly forms on wood, for example.

As they grow, pieces of bottom ice break loose from the bottom and float up to the surface, often with soiled particles, rocks, and other objects frozen to them.* After the surface is covered by the surface ice or deep ice which has floated to the surface, further formation of deep ice ceases in fresh water. Actually, we have seen that the second fundamental condition necessary for ice formation necessitates a great loss of heat by the water. This loss is hindered by the presence of surface ice, and with further supercooling of the water, it ceases in favor of crystallization.

Naturally, the most vigorous agitation is observed in the fast rapids of rivers where the amount of deep ice is often four to five times greater than the amount of surface ice which forms simultaneously. In the Angara, according to Altberg, deep ice is almost the exclusive formation.

As Velikanov points out, the formation of deep ice does not cease for very long if there are *polynyas*,** in which case ice formation always take place below these polynyas. Floating

*In river rapids, bottom ice, slowly growing, sometimes reaches the very surface of the water, creating characteristic ice formation called patrams.

***Polynya* - Any sizable sea water area, other than a lead, encompassed by ice.

upwards, deep ice sticks to the surface ice and forms ice jams, narrowing the active cross section of the river (on the Svir' River, e. g., sometimes by 80 per cent).

LITERATURE: 4, 5, 13, 26, 62, 77.

Section 38. Peculiarities of Ice Formation in the Sea

Let us assume that at the beginning of freezing, with the sea at rest, we have a series of parallel layers, uniform in temperature and salinity in which the density of the layers increases with depth.

After the surface layer cools somewhat below the freezing point, nuclei or crystallization begin to form and ice crystals begin to grow in the fallen needles. These needles, if the sea is calm, develop very rapidly at low temperatures and change to plate crystals. The ends of these crystals usually are irregular and slightly rounded. The salt dissolved in the sea simultaneously pass into the interlayers between the crystals where they form "brine." The latter, due to its relatively high salinity, in part drains down along the crystals (which causes convective currents in the entire surface layer of the water), and in part, with sufficiently intense cooling, remains frozen in between the crystals of pure ice in the form of brine-filled cells. With sufficiently rapid freezing, the gasses and air bubbles dissolved in the water are concentrated in similar cells.

During the summer in the polar basins, the interstratification of the surface layers is clearly expressed in the majority of cases, and the salinity increases sharply with depth. The surface layers are diluted by the melting of ice and by the influx of fresh waters, whereas the deep layers are either of oceanic origin (high salinity and high temperature) or they have been made saline by the winter ice formation. Because of this, the upper layer can be very thin here, and at the same time differ very much in salinity from lower-lying layers.

Thus, the most favorable conditions for the start of ice formation are in calm seas, the presence of a thin and a very fresh surface layer, and a great release of heat to the atmosphere (which is assisted by low air temperature, causing strong convection, or a very dry transparent air, causing strong evaporation and radiation). The fall of even a small amount of precipitation in solid form on the surface of the sea intensifies the process still more. As many observers have noted, the more favorable the conditions for ice formation, the finer are the developing crystals and the more uniform and stable are the forms created from them.

The indicated phenomena are also characteristic for the thicker surface layers of the sea. With the beginning of ice formation, convective currents always arise, whose intensity is determined by the intensity of cooling, and up to the time the surface of the sea is covered by a layer of ice (no matter how thin) the nuclei of crystallization can occur, and around them, and throughout the entire mass of the upper convection-mixed layers, new ice formations can develop.

But in the sea, aside from convective mixing, one observes extremely intense mixing of upper layers of the water by wave motion or currents. Under such conditions, depth ice and even bottom ice, may be formed first.

In separate areas of the arctic seas, the vertical winter circulation can be so strong, that when the layer involved in a circulation is thin, the release of heat by the water to the atmosphere may be sufficient for forming embryos of deep ice in this layer.

But nevertheless, the formation of depth and bottom ice in a sea, as in fresh water, ordinarily ceases after the formation of a surface rind of ice, since direct release of heat by the water to the air ceases after this.

Thus, there is no basic difference between the formation of deep ice in fresh water and in the seas; in both cases, a certain supercooling and mixing of water which guarantee heat release, are necessary.

LITERATURE: 62, 77.

Section 39. Ice Formation at Positive Air Temperatures

Ice formation in the sea ordinarily begins at negative air temperatures and after the temperature of the surface level has decreased to the freezing point. In individual cases, however, ice formation can begin at positive air temperatures as well.

Two conditions are necessary for this: 1) The surface layer of the water should be very thin and it should differ sharply in density from the lower layers, and 2) effective radiation should be sufficiently strong. For the latter, a very dry transparent atmosphere is necessary.

I observed a characteristic example of ice formation in a very thin, very fresh surface layer on 5 September 1934 in Traurenberg Bay (79°58' north, 16°48' east) during the voyage of the *Perseus*.

It was about noon on a calm day (the sun's elevation was approximately 17°) with a completely cloudless sky, air temperature 2.6° (at a height of about 6 m), atmospheric pressure 1,030 mb, and relative humidity 65 per cent (the minimum relative humidity, recorded by the automatic recorder, was 59 per cent for the day).

The water temperature at the very surface of the sea was 4.92°. The salinity of a water sample, taken simultaneously, was 37.73 o/oo. The water, carefully dipped from the surface of the sea by a bucket, was of lower temperature (about 3.5 per cent). Despite the high temperature of the subsurface layers (bottom temperature at a depth of 64 m was 4.18°), a very thin film, consisting of fresh (to the taste) ice appeared from time to time on the surface of a completely calm sea. But a gust of wind and the appearance of ripples were sufficient to destroy the ice which was melted by the heat of subsurface water particles which rose to the surface of the sea with a new heat supply when ripples formed.

Such formations of thin surface ice in the presence of relatively high water and air temperatures had also been observed earlier.

Scoresby often observed this phenomenon in 1882, and writes that "during cloudy weather, when the thermometer is at -1.7°, the surface of the sea does not freeze, but during clear, calm weather, when the sun drops towards the horizon, the sea begins to freeze, even though the thermometer is at +2.2° or higher."

The same phenomena was observed by Nordenskjöld on 31 August 1879 during the voyage of the *Vega*, off the New Siberian Islands.

Nordenskjöld writes "the sky was clear of clouds at the zenith and in the east. . . despite the fact that the temperature of the air and water was above the freezing point, we had the opportunity

of observing ice formation on the calm, mirrorlike surface of the sea. This ice was in part needles and in part a thin scale. Before this I had already often observed such a phenomenon on an arctic sea, i. e., I had seen ice formation with an air temperature above 0°."

On 17 May 1923 the same phenomenon was observed by Arnold-Aliabev from the icebreaker *Lenin* in the Gulf of Finland at the southern tip of Hogland Island in open water near continuous floating ice. In calm, clear weather, the ice, on being removed from the water, proved to be several tens of millimeters thick, and looked like flat cakes, i. e., plates of scaly and branched structure with irregular edges. Solid transparent ice about 2 mm thick had formed in about 15 minutes.

These examples show that the formation of surface ice during high water and air temperatures, but necessarily during the absence of wind and with a clear sky, is an ordinary phenomenon. Even Scoresby explained it by radiation. The observations on the *Perseus* are characteristic only in that the temperature of the air and water are usually high in comparison with the temperatures observed earlier.

LITERATURE: 8, 62, 77, 120.

Section 40. The Basic Varieties of Ice in the Sea

Ice structure, based on its origin, is arbitrarily divided into "needle ice" and "sponge ice." As we shall see below, sea ice, in the course of its birth, life and death, undergoes strong physical-chemical and thermodynamic changes, but its basic properties, remain the same. Needle ice forms slowly, a considerable part of the brine drains down from the interlayers between the crystals, and the air is separated out along the vertically located cells. Because of this, needle ice is freer of impurities, is more transparent and durable than sponge ice. The latter always contains more of the various types of impurities, which is particularly noticeable if such ice is formed at or near the bottom of the sea. In the latter case, particles of silt, etc., can be found in the brine cells.

The division of the sea into needle ice and sponge ice according to its structure, is more or less arbitrary, as has already been pointed out. Transitional forms are usually observed in nature. Furthermore, we can observe individual layers in the same block of ice. Thus, for example, deep ice of spongy structure, after it has floated to the surface begins to grow from below as needle ice. Needle ice which forms, when broken into separate pieces by the wind, can be overgrown with spongy ice, if the surrounding water is sufficiently cooled and agitated. Mechanical causes have a still greater effect on individual ice beams. During agitation, wind and compressions, ice floes may be pushed up on top of one another, and freeze together. As a result, ice is obtained which consists of several more or less uniform layers separated by interlayers formed, in the majority of cases, from the snow which covers the upper surfaces of the lower ice floes. Finally, when one ice flow slides over another, equilibrium can be destroyed and the ice can turn over or the surface of separation can become tilted. Thus, the stratification of the ice is a sign of the changes which it has undergone in the course of its existence.*

Ice formed from snow occupies a somewhat special place, due to its structure. Snow which has fallen on the sea surface, whose temperature is near the freezing point, does not melt, but is permeated by sea water, becomes denser, and, as we have seen, aids in the freezing of water.

*Such dynamic stratification of ice can, and must be, differentiated from its thermal stratification, which is created as a result of changes in the temperature of the air and water during ice formation. I will deal with the question of thermal stratification in Section 84.

The "granular" ice which has been obtained is almost opaque (it consists of grains) and resembles firm ice. Still more unique is the shape of the ice formed from snow, which falls on the surface of new ice, constantly damp with brine.

Thus, in first approximation, on the basis of structure, sea ice can be divided into needle, sponge and granular, while on the basis of deep formation, into surface, deep and bottom ice.

Needle ice consists of regular hexagonal pyramids with the axes perpendicular to the surface of the sea (oriented crystals). Such ice resembles glass (externally).

Sponge ice consists of needles, plates and grains (unoriented crystals) intertwined in various directions.

Granular ice consists of round grains, i. e., separate crystals round in form, with nonparallel axes. Such ice is formed from ice and snow during friction and pressure of ice floes against each other. When the grains are very close together, this ice also resembles glass.

"Surface ice" is formed at the very surface of the sea from sea water or snow. If it is formed from sea water when the sea is calm, its structure approximates the needle type, while when the sea is not calm, it resembles the sponge type.

"Deep ice" is formed at a certain depth below the surface of the sea; its structure is ordinarily spongy. Bottom ice is formed on objects lying on the bottom; it is a variation of depth ice, and also has a spongy structure.

A rougher subdivision of ice according to its external appearance (which can be determined visually) is its classification as vitreous and porous, and as stratified, which is a combination of these two types when they undergo change.

Recently some investigators approached the question of ice structure from the petrographic point of view; in other words, they examined ice as a mineral, and adapted to it the classification established for rocks. Actually, ice forms from water (which is a primary geological substance) in much the same way as, for example, crystalline silicon rocks form from melted liquid magma. Since during its existence ice undergoes many thermodynamic reactions, ice can also be a metamorphic rock. This view is shared by many. Some classify ice as neptunic (sedimentary) rock. If such analogies are drawn, surface ice should be classified as an igneous rock, while depth ice, which rises to the surface of the sea and for which the surface is the "bottom" should be classified rather as a sedimentary rock.

LITERATURE: 62, 77.

Section 41. Initial Forms of Surface Ice

Small crystals, in the form of ice needles which spread in every direction and which intermingle with each other, form on the surface of the sea when it is calm and there is no wind. These primary formations gradually grow larger, fuse together, and form spots of film on the surface of the sea, which in form resemble congealing lard and which are called "lard ice," or simply "lard." Lard ice (ordinarily a dark lead color, which differs only slightly from the color of the water during cloudy weather) externally resembles finely ground ice saturated with water.

The first result of lard ice formation is the destruction of wind ripples on the surface of a calm or agitated sea. Since ice formation does not begin evenly over the entire surface of the sea, but rather as separate more or less rare spots, the sea surface assumes the appearance of moire.

If the surface of the sea is very fresh, with further cooling and a sea completely at rest, its entire surface is covered by a thin shiny rind called "bottle ice" or "ice rind" (figure 31).



Figure 31. Bottle ice.

It should be noted that essentially, bottle ice is a typical form of fresh ice. Because of this, bottle ice at sea is observed in fresh water basins which form during the summer in the arctic on ice fields (between old ice where the surface layer can be completely fresh when there is no wind) and at the mouths of rivers.

Such bottle ice is as transparent as glass, breaks easily into pieces, and when the ship passes through it, it shatters with a characteristic crackling.

Nilas forms from lard ice on a calm sea. This is a dull opaque ice with a surface damp from brine, grey, and easily discernible from the bridge of a ship or from an airplane. As opposed to bottle ice, which is brittle, *nilas* is extremely plastic; it bends easily on a wave, and when smashed, gathers into pieces. Burke arbitrarily divides *nilas* according to colors into dark and light grey, limiting the thickness to approximately 10 cm. He further points out that the dark color of *nilas* is due not so much to water shining through it as to its high brine content. Also, due to this, the snow falling on the surface of *nilas* melts.

With slight turbulence, ice formation sometimes seems to originate from many centers (disks 30 to 50 cm in diameter). This is the "pancake ice," which is the most widespread initial form of ice in the sea (figure 32). Pancake ice is often observed on lakes and quiet rivers.

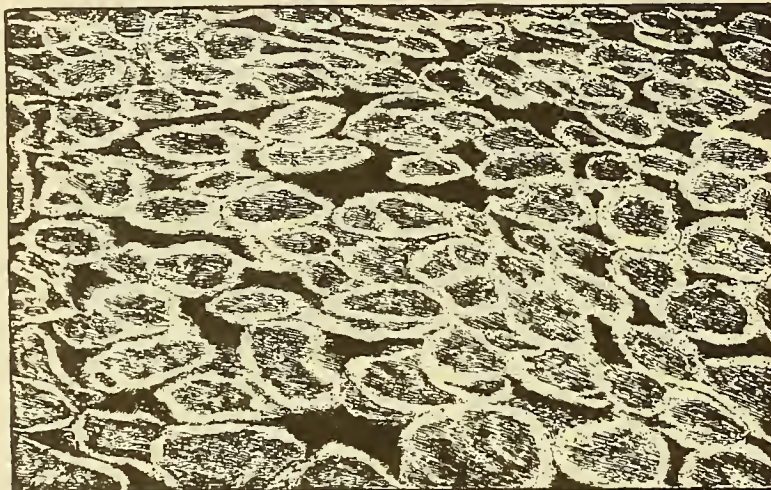

Figure 32. Pancake ice.

Round forms of pancake ice are the most frequent. Toll's expedition observed the formation of pancake ice in the form of ellipses during a 2 to 3 m/sec-wind. Such a change in form can also be caused by currents. In September 1935 during the expedition of the *Sadko* along the eastern shores of Franz Josef Land, I observed variations of pancake ice. Individual elements were angular in form, and the surface of the ice resembled crocodile skin in design. Evidently, such forms of pancake ice are created in connection with the breaking of *nilas* by interference waves, and naturally form thicker ice.

Small ridges along the edges of the pancake ice discs, which form due to the friction of one disc against the other, are characteristic. This gives it the appearance of flat frying-pans.

Pancake ice discs, gradually thickening and freezing together, finally form more or less extensive folds of continuous ice, in which the ridges along their edges, which are 1 to 2 cm higher and whiter than the discs themselves, give the surface of the freezing sea an appearance of being covered by a white net.

With wind and strong agitation, the lard ice gathers into whitish fragments called "brash." This gathering is especially characteristic along the crests of waves. During the *Sadko* expedition in 1935, with an air temperature of -6° and a strong wind, I observed the formation of brash accumulations stretched out behind the wave crests in the direction of the wind. It seemed that brash

formed, skipping the lard-ice stage. Dobrovolskii related to me in January-February, 1931, during the voyage of the *Knipovich* in the Kanin-Kolguev region, that he observed a peculiar brash consisting of regular, transparent, thin plates 1 to 2 cm long and 2 to 3 mm wide. These plates, which had not frozen together at all, formed a layer of brash more than a half-meter thick. On top, the brash was completely dry. It packed the intake ports of the cooling system so that it was necessary to stop the engine every 5 to 10 minutes.

The precipitation of snow on the surface of the sea always accelerates ice formation. Here, the surface layer always becomes fresher, cools, and moreover, introduces nuclei of crystallization into the water. When snow falls on a sea surface whose temperature is below zero, the snow does not melt but forms a soft, dough-like mass called *snezhura* ("snow slush").

Even when the air temperature is high, snow slush causes ice needles to form in the nearest cooled water layers. When there is turbulence and wind, snow slush, like the brash, gathers in bands consisting of lumps of snow saturated with sea water. With further freezing of the sea, the snow slush bands differ sharply in their appearance and white color from the surrounding ice formed from sea water.

Thus, the primary forms of ice formation in the sea are ice needles and lard ice, which give the sea a strange, greasy appearance. When the sea is calm, bottle ice and nilas are the next stage. When the sea is not calm, pancake ice is formed, and when the sea is very agitated, brash ice is found. In the majority of cases, ice formation starts from the shores, from individual ice floes, and from shore ice, and extends gradually to the sea. Because of this, all stages of ice formation can be traced simultaneously.

Thus, on 15 September 1935, along the eastern edge of Franz Joseph Land, when approaching and entering the windward edge of the ice at -10° , we observed from the *Sadko* the following forms of ice in a small area: lard ice, graying, very thin ice (nilas), pancake ice, consisting of discs with ridges along their edges, and the edge of old ice from which ice formation was proceeding. As they neared the edge of the ice, the pancake ice discs increased in size. It could be seen that the large discs represented the fusion of smaller initial discs. By means of this fusion, pancake ice discs can attain a diameter of two meters.

As has already been pointed out, initial ice formations look dark steel or lead in color, which is explained by the fact that they are almost completely saturated with water due to their thinness. As the ice thickens, it begins to ride above the water, and at first turns gray, then white. The ridges of pancake ice are the first to start turning gray. Further cooling is accompanied by thickening and fusing of individual ice floes, and thus young ice or *molidik* is created, which is light-gray and rough, and which has a surface moistened by the separated brine (figure 33).

In the majority of cases, the upper surface of young ice is smooth and slightly rippled; the lower surface, during the period of ice formation, is, on the other hand, very uneven and in some cases, where there are no currents, resembles a brush of ice crystals. According to observations made on the *Zarya*, a layer of sea water 10 cm thick or more, saturated with ice crystals which gradually freeze to the ice from below and thus thicken it, lies directly under the lower surface of young ice when it is 2 to 3 cm thick.

It has already been pointed out that even lard ice eliminates wind ripples completely on the surface of the sea. Brash, snezhura, and pancake ice completely eliminate the secondary wind waves, and very large waves gradually assume the appearance of a frozen ripple, when such ice extends downward.

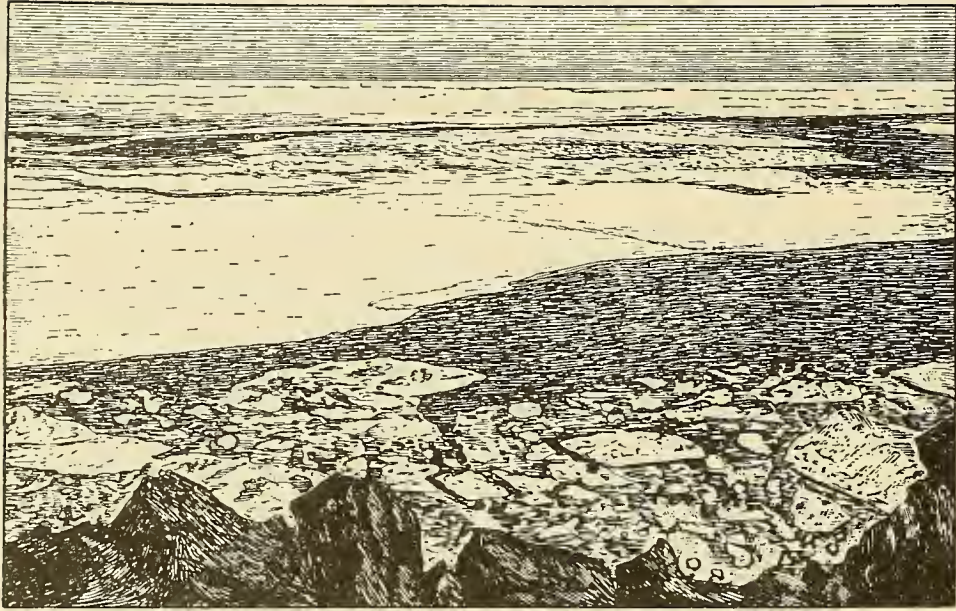

Figure 33. Young ice.

During winter, under calm conditions, young ice is gradually covered with snow and increases in thickness due to freezing from the bottom; in the arctic it reaches a thickness of 1 to 2 m in May.

An undisturbed growth of ice during the entire winter is possible mainly in sheltered bays, in fast-ice areas, and between large, thick ice formations. In the majority of cases, the ice is frequently broken, fragmented, and heaped from the very beginning of its existence.

LITERATURE: 23, 62, 77.

Section 42. Deep Ice

It has already been pointed out that with low air temperatures and strong mixing and, particularly, when there is no ice cover, ice forms, not on the surface of the water but at a certain depth.

Later, these ice formations, due to their small size and slight difference in density from water (the Archimedes forces exceed friction forces only slightly), can remain in a suspended state a long time until, increasing in size or freezing together with other particles of the same kind, they float up to the surface of the sea and fuse with surface ice.

This phenomenon is not accidental. On the contrary, many consider that during the process of ice formation, the entire layer of water included in vertical winter circulation is filled with the tiniest particles of deep ice. New particles of deep ice constantly arise replacing such particles which rise up the lower surface of the ice cover.

The sudden appearance of large masses of deep ice has often been noted in the Arctic Basin. Thus, during the expedition on the *Fram*, Nansen observed this phenomenon north of the New Siberian Islands, and Sverdrup observed it at 81°30' north, to the northwest of Spitsbergen.*

Interesting observations of deep ice formation were conducted by Wright and Priestley during the British Antarctic expedition (1910 to 1913).

These observations were corroborated by Altberg, who noted that during formation of deep ice, the water contains a multitude of ice elements throughout its entire mass, which are hardly noticeable but which, when the observer's eye is in a particular position in relation to the sun's rays, appear as shining points.

Further, Wright and Priestley also noted that in antarctic conditions, supercooling during the greater part of winter extended to a depth of 8 m. A rope lowered into the water for three days was overgrown with porous ice resembling lace or "fret-work lady's boa" up to 12 cm in diameter. This "boa" gradually narrowed with depth, and at a depth of 8 m disappeared (figure 34).

Wright and Priestley indicate that deep ice formed independently of whether or not there was any ice on the surface and also independently of the thickness of surface ice. As I was informed by Captain Melkhov during the voyage of the icebreaker *Lenin* in January, 1942, among solid nilas ice off the Dvina Gulf, he often had the opportunity of observing the following. The icebreaker navigating freely through the nilas at a speed of 5 to 7 knots, sometimes gradually lost headway

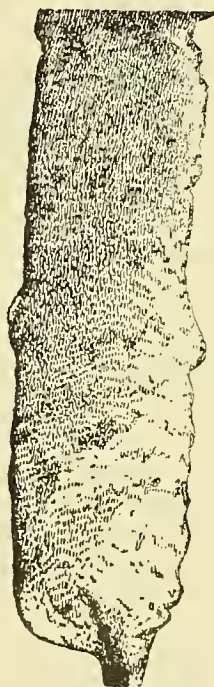

Figure 34. A rope overgrown by deep ice.

*In individual cases, deep ice floating up can have a practical effect. Thus, Tanfil'ev notes that in 1879 in the Baltic Sea, several steamers and sailing vessels were suddenly caught by rising ice which rapidly attained considerable thickness, and they had a difficult time extricating themselves.

even though there were no signs of ice thickening. After stopping the ship, he discovered that a singular pillow of deep ice in the form of needles and crystals had accumulated in front of the bow of the icebreaker. Evidently, beneath the solid nilas ice during very low air temperatures (25 - 30° below zero), the water was filled with particles of deep ice in various stages of development. It is possible that the movement of the icebreaker itself served as a peculiar catalyzer which created deep ice. Captain Shtumpf assured me that he observed the same phenomena in the Yenisei Gulf.

It follows from these observations that in the separate polar regions vertical winter circulation can be strong, that when a layer of slight depth is involved in this circulation, the heat released by the water to the atmosphere proves to be sufficient for forming deep-ice nuclei in this case.*

Unfortunately, it is not always possible to analyze the phenomena causing and accompanying the rise of large masses of deep ice. Often, only the fact itself is noted without attempts at an explanation, and meanwhile formation of deep ice can occur under different conditions.

The formation of deep ice along the interface dividing a highly cooled saline-water layer and the layer flowing over it, of cold highly freshened, water, has been most fully clarified. This phenomenon is particularly noticeable during calm weather when the upper and lower layers, which differ considerably from each other in density, hardly mix.

On 11 June, 1894, during the expedition on the *Fram*, Nansen discovered a rind of soft ice 3 cm thick at a depth of 2 to 3 m in a polynya, and came to the conclusion that formation of deep ice at the surface of separation between cool sea water of high salinity and almost fresh melt water is a common phenomenon.

In 1897, Otto Petterson brought to attention the fact that in Skagerrak the rise of ice beams is sometimes observed which are formed at the surface of separation between the surface-freshened layer (having a salinity less than 22 o/oo, a temperature of -0.8°, and a freezing point of -1.2°) and the deeper saline layer (having a salinity of more than 33 o/oo and a temperature of -1.4°).

In his notes during the drift on the *Sedov*, Buinitskii notes on 28 July 1938, that he found a thin layer of completely fresh ice on the very "bottom" of a water opening.** After a day, a new crust of ice formed in place of the one removed from the bottom of the *maina****

On 25 July 1939, in the maina across which they were making hydrographic observations on the *Sedov*, an ice rind consisting of two layers 2 and 4 cm thick, was discovered at a depth of 2.5 m. Separate pieces of ice were completely fresh.

Phenomena of the same sort were observed at the start of winter near the mouths of rivers emptying into the sea, especially near the mouths of rivers flowing south to north. Cold, fresh water flowing onto the surface of the cold sea, is cooled from below, sometimes causing formation of deep ice.

LITERATURE: 62, 77, 107, 128, 164, 179.

*On my request, Evdenov tried several times to repeat the Wright and Priestley observation during the drift of the *Sadko* in the Laptev Sea during the winter of 1937, but his results were negative.

** *Promoi* - An opening in the ice made by currents; a lead eroded by currents.

*** *Maina* - A local term for *polynya*.

Section 43. Ice Under Ice

The course of deep-ice formation underneath ice is characteristic. Large supplies of almost fresh melt water form during melting on the surface of the ice fields and fast ice. After the ice fields either melt through or are broken, this melt water goes under the ice and here, spreading along the sea water, which at this time is near freezing, creates a peculiar ice under ice. This phenomenon was first discovered by Nansen. He noted that ice which had formed in the autumn of 1893 attained a thickness of 257 cm. Six days later, Nansen discovered, completely unexpectedly, that the thickness of the ice had increased 19 cm despite the fact that the surface of the ice melted several centimeters daily.

With further measuring, Nansen obtained the data given in table 26.

TABLE 26. ICE THICKNESS ACCORDING TO NANSEN'S MEASUREMENTS

Date	Thickness of Ice in Centimeters		
	Total	Main	Sub- ice
23 July 1894	249	223	26
10 August 1894	217	194	24
22 August 1894	206	186	20
3 October 1894	198	175	23
12 October 1894	208	180	28

Nansen explained this phenomenon by the fact that the fresh water formed during melting, when draining off under ice, comes in contact with the saline sea water, whose temperature is -1.6° .

It is natural that the fresh water which freezes at 0° quickly turns into a peculiar sponge ice when coming into contact with the upper layer of the sea.

Toll's Russian polar expedition of 1900 to 1903 investigated exhaustively the process of spring ice-under-ice growth both under natural and laboratory conditions. The observations of this expedition supported Nansen's conclusions. As it developed, fresh-water ice under ice, formed as a result of the contact between the drain-off of fresh snow water with the cold sea water (whose temperature is from -1.2° to -1.5°), is an ice of coarsely crystalline form, which sometimes attains a thickness of 10 to 15 cm.

This phenomenon was checked in the laboratory. A piece of ice about 5 cm thick was placed in a solution of table salt having a temperature of about -5° . Fresh water, treated with fuchsin was added to the solution through a vertical hole in the piece of ice.

Draining under the ice and coming in contact with the cold solution, the fresh water began to freeze, and froze to the lower surface of the ice. In this manner, the phenomenon and structure of "sub-ice, fresh-water ice," which had been observed in nature, were reproduced exactly in the laboratory. Sub-ice, fresh ice has a clear crystalline structure consisting of loosely connected large crystals. Its lower surface is very irregular and coarse, and a layer of ice porridge consisting of weakly joined ice crystals is ordinarily located under it.

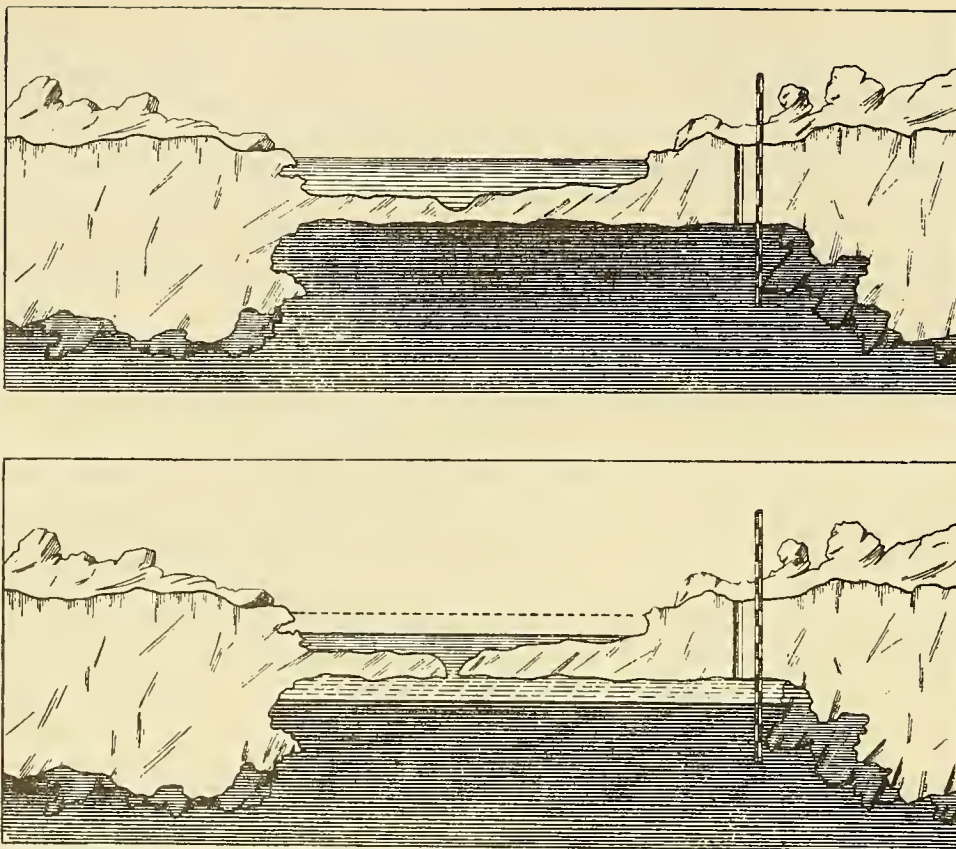

Figure 35. Formation of ice under ice in the area of the *Sedov* drift.

A reverse distribution was observed in separate instances: a thin layer of sub-ice, fresh-water ice was separated from the lower surface of the sea ice by a layer of ice porridge. Evidently, the sub-ice is not distributed over the entire ice cover but rather represents a local phenomenon and collects under the ice areas where snow water drains off under the ice, and is held for a comparatively short time—from five to ten days.

According to observations on the *Sedov*, near one of the ice-measuring rods which were set up, the ice thickness increased by 28 cm from 30 July to 10 August 1939.

It was clarified that in the given instance, a decisive role was played by an accidental condition: under the ice on which the rods stood, a singular ice shed formed consisting of hummocks reaching down deep (figure 35). These hummocks formed a locked circle which hindered the distribution of the fresh water draining down to a wide sub-ice area. A singular ice box developed in which the melt water turned to ice very rapidly.

In the summer of 1938 no formation of ice under ice occurred, according to the observations on the *Sadko* and the *Sedov*. Thus, these observations affirmed the supposition that the sub-ice under ice of noticeable thickness is a local condition.

LITERATURE: 11, 62, 77, 88, 107.

Section 44. Bottom Ice

Bottom ice is a variation of deep ice, formed in shallows, and in certain cases is more significant than deep ice.

Bottom ice in the sea is an extremely widespread phenomenon not only in northern but also in southern seas.*

Similar cases were also known in the Baltic Sea. Thus, in some years at the beginning of winter, ships found themselves surrounded by ice which had suddenly risen from the bottom of the sea, this was proved by sand and bottom objects that had floated up along with the ice.

It is known, for example, that bottom ice along the rocky shores of Greenland, Labrador, and Spitzbergen often raise chunks of rocks and bottom with themselves to the surface of the sea. Along the shores of Newfoundland, bottom ice has been encountered at depths of 20 to 30 meters.

Rodman notes a case when a box of instruments was carried to the surface of the sea by bottom ice. It happened that this box had belonged to a ship that had gone down many years ago in Hudson Strait, several hundred miles north of where it was found.

In separate regions along shallow shores, the sea freezes to the bottom and the ice fuses solidly with the bottom. When melting begins, the upper layers of this ice are covered with water, which preserves the ice from the direct action of solar radiation and heat exchange with the air. Aside from this, fragmented shore material is gradually deposited on the ice, which protects the remnants of the ice not only from the heat but also from the erosive action of water.

It is clear that under such conditions the ice frozen to the bottom is preserved for a very long time. Thus, Samoilov notes that in Khatangskii Gulf ice islets frozen to the ground were disclosed during the low tide on 27 July, 1937, 1.5 km from the shore.

In Biruli's opinion, who had observed the same phenomenon on the southern shore of the Taimyr Strait, spring bottom ice can remain for many years if the winters are especially harsh and if the sea is at a low level.

As spring bottom ice melts, parts of it break loose and float up to the surface of the sea, along with particles of the bottom and underwater stones which have frozen to it, and with products of spring-shore run-off which have been deposited on its upper surface.

During exceptionally warm years, chunks of old bottom ice, whose upper surface has not only bottom deposits but also marine organisms which have developed on it during the time it was under water, can float up to the surface in the same manner.

*Thus, according to announcement by Snezhinskii, the fishermen of the Dilzhanskii station on the Azov Sea indicate bottom ice forms annually along the western side of the Dolgaia sand spit. They assert that if a 40-centimeter rod is driven into the bottom, leaving one-tenth of the rod above the surface of the bottom, coarse bottom ice will begin to form on the rod in such dimensions that finally the rod will pull out of the bottom and along with the ice will rise to the surface of the sea. It is characteristic that on the eastern side of the sand-spit bottom ice does not form. The formation of bottom ice was also observed during certain years on the western side of the Berdianskiya sand-spit; this happened only when the sea was open.

Bottom ice often forms at the mouths of rivers emptying into seas having strong tidal phenomena. Sea water, cooled to a temperature of 1.5° to 1.8° below zero, on entering the mouth of a river when the tide comes in, cools the rocks and the other objects at the bottom of the river. When the tide goes out and fresh water flows over these objects, an ice crust forms around them which, depending on local conditions is either destroyed each time or is gradually increased. Nalivaiko discovered such river-mouth bottom ice while making winter measurements at the mouth of the Onega River. As can be seen from figure 36, which he was kind enough to give to me, the sandy bottom was covered with an ice crust and the sand had frozen through to 10 to 12 cm.

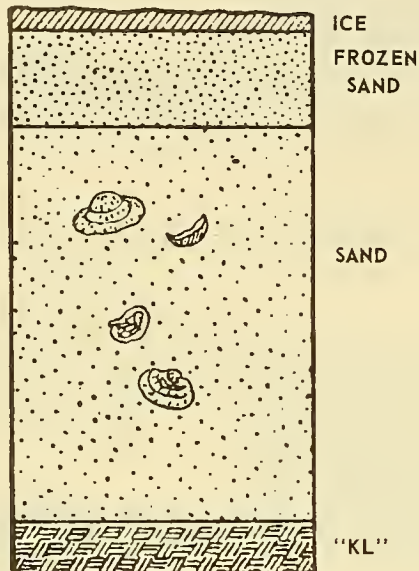

Figure 36. The vertical distribution of the elements in a column of soil taken on the Onega Bar at a depth of 3 m.

LITERATURE: 62, 77, 88.

Section 45. The Classification of Ice According to Origin

The ice found at sea is divided into three classes according to its origin, which differ sharply from each other according to their physical-chemical characteristics: "river," "glacial," and "sea."

River ice is carried out from the river to the sea during the spring ice break-up, and during the summer it either melts or, in polar regions, is integrated into the ice of marine origin. River ice is completely fresh and ordinarily it is brown in color, which is conditioned by mixtures of humus materials. Often, river ice contains shore dirt and other inclusions.

River ice is never found in the South Polar latitudes. In the Arctic Ocean, there is quite a bit of it during the beginning of summer in the areas where the large Siberian rivers drain. Inasmuch as this ice is almost completely destroyed during the course of a polar summer, its role in the ice regime of the seas is extremely insignificant.

Glacier ice gets into the sea when the ends of glaciers break off. Formed from snow which has collected in mountain valleys, glacial ice is fresh and almost completely devoid of foreign material. As a rule, it is bluish in color.

Glacier ice in the form of icebergs is found in the Arctic Ocean between 120° west and 0-100° east. The icebergs are carried out across Davis Strait into the Gulf Stream area by the Greenland and Labrador currents.

But glacier ice attains particular development and distribution in the South Polar regions. Here, icebergs are found around the entire antarctic mainland, and reach to the southeastern shores of the Americas.

Sea ice is formed in the sea itself out of sea water. Salinity is its basic characteristic. With time, sea ice becomes fresher, but even after it does become fresh (usable for the preparation of food), it preserves certain chemical properties which make it possible to distinguish it from river or glacier ice.

The main mass of sea ice has a greenish tinge; when there is a high content of snow and air bubbles, it has a whitish, glass-like appearance. Marine ice, freshened and made more dense by pressure, adopts a blue color in the course of time.

According to areas of distribution and, above all, according to mobility, sea ice is divided into two classes: "fast ice" and "pack ice."

"Fast," or "immobile ice," during the winter borders the continental shores, islands, and also ice standing in shallows, which in this relation plays the role of islands.

During the summer, fast ice usually breaks up, separates into different fields and floes, breaks loose from the shore, and changes into the pack-ice classification.

"Floating" or "drifting" ice is in constant motion both winter and summer due to the effect of constant and periodic currents and the wind.

Old drift ice of great thickness and solidarity, which is impenetrable by contemporary ice breakers, even during the summer, is called "pack ice," and fills the central part of the Arctic Basin.

Depending on the conditions under which it was formed, ice is divided into "grown ice" and "heaped ice". The thickness of the first increases exclusively due to low air temperatures. The thickness of the second, in addition, is due to the rafting of one floe on another. Any ice formation can occur at any time.

Two groups of ice are differentiated according to age:

1. Year-old ice. The following are differentiated in this group: "spring ice," i. e., the ice which is formed in the spring before navigation. This is the youngest, thinnest, and warmest ice; it hardly hinders navigation. After it follows "winter ice" and "autumn ice," both of which are older in age than the spring ice.

2. Old ice, which includes ice which had existed a winter, a summer, and the following winter.

LITERATURE: 23, 62, 77.

Section 46. Classification of Ice According to Size and Form

The ice found in the sea is differentiated, aside from its origin and age, according to its size and form.

During the winter, due to the movement of ice caused by some reason or another, and due to temperature changes, there occur: 1) an increase in the vertical size of the ice (due to growth and rafting), 2) an increase in the horizontal size (due to the fusion of separate ice formations), and 3) a decrease in the horizontal size due to fissures which arise with temperature changes (thermal fissures), with paddle phenomena (paddle fissures), and with compression (pressure fissures).

During the summer, there occur: 1) a decrease in the vertical size (as a result of melting from above and below and a deterioration of rafting formations), 2) an increase in the vertical size (due to rafting), and 3) a decrease in the horizontal size (as a result of breaking and rafting).

Ice formations in which the horizontal measurements exceed considerably the vertical ones are called "icefields" and "floes."

Pack ice, which is the most extensive in area (more than 2 km in length) is called a "large ice field." It is formed when large areas of fast ice break loose from the shore, and above all, when ice formations smaller in area are fused together (figure 37).



Figure 37. Ice fields.

Some large ice fields possess such a level upper surface and such thickness that they permit landings by heavy airplanes on them. Such fields are called "airdrome fields."

Ice fields having an extent of 200 m to 2 km are called "small ice fields." They develop either as a result of fusion of smaller formations or as a result of a break-up of large ice fields.

Ice formations of 20 to 200 m in length are called "large floes" (large or larger fragments of ice). Ice formations 20 m in extent are called "small floes" (small or small fragments of ice) (figure 38).



Figure 38. Shattered ice (blocks of ice 2 to 20 m).

At sea, ice ordinarily consists of ice accumulations of different sizes. Because of this, it is necessary to speak of large-to-small fields when large fields are predominant and of small-to-large fields when small fields are predominant; large-to-small floes (large-to-small ice) have a predominance of large floes; small-to-large floes (small-to-large ice) have a predominance of small floes.

When separate ice formations collide, their edges break and the fragments are rafted upon each other, forming simultaneously small-small floes. With further fragmentation, "crushed ice" or "ice porridge" is obtained. Ice porridge is especially characteristic of the windward edge of floes and near the shore where it forms as a result of wave and tidal action. In such cases, ice porridge often obtains a thickness of several meters, reaching the bottom near shores and shallows, and forming a drift, which is very dense when compressed and which becomes somewhat less dense during decompression.

In the White Sea, highly fragmented ice, which has been forced out upon the ice fields during hummocking, is called crushed ice. It resembles snow and differs from it by a grayish tinge. Fragmented ice, which has been forced underneath the ice fields or which fills the space between them, is called ice porridge.

Crushed ice and ice porridge, due to the smallness of their particles, melt first of all, and therefore they are mainly characteristic of winter and high altitudes.

The very size of the ice fields depends on their thickness and also on the morphological and hydrometeorological conditions of the water basin. Even if ice fields having an area of several square kilometers and more are not rare in the center of the Arctic Basin, yet in the center of the

White Sea Basin fields of such magnitude are created only for a short time and under special conditions--during heavy colds and weak winds. No ice fields are found in the Mezem Gulf due to strong tidal phenomena.

Ordinarily, the closer to shore, the smaller the sizes of the fields, and furthermore, in the summer time, especially after strong winds they decrease. Strong winds also break up large ice fields during the winter. In areas of the ocean where the edge of the ice is always sharply expressed, as, for example, in the Greenland and Barents Seas, large and small floes predominate at the very edge of the field, which should be attributed to the breaking-up action of sea waves and variations.

Ice fields and floes, depending on the conditions of their formation and structure, can be either accretional or rafted, and depending on their external appearance, level or hummocky.

Any collision of one ice formation with another, no matter what the cause, is accompanied by more or less considerable hummocking. If the ice formations advancing on one another come in contact with one or several points widely separated from each other, the ice at the points of contact breaks and turns over on its side; as a result, there remain on the comparatively level surface of the ice floes sticking up edgewise which are called "hummocks."* If the contact during compression occurs more or less uniformly, heaping occurs along the line of contact, and this is called a hummock.

In some cases, hummocks attain extremely large dimensions. During winter and the following spring, they become more dense and very durable formations. During the summer, due to their durability and size, hummocks, surrounded by areas of flat ice, melt last of all. Separate ice formations along the southern edge of the ice, in the majority of cases during summer and autumn, are remnants of hummocks. They have comparatively small horizontal surface and a comparatively large vertical size, and are called "growlers."

Large separate heapings of this type, higher than 5 m above the water level, are called "floebergs," or icebergs of marine origin.

Formations of the same sort, less than 5 m high above the surface of the water, are called "ice heaps."

Especially in the autumn, growlers, flying over the open spaces of the frontiers of the Arctic Basin seas due to the effect of the wind and the currents, often are grounded due to their deep draft, (on the shallows which are numerous here) and become *stamukhs*. Gathering in the deeper areas of the sea and freezing together during the autumn, the growlers form very powerful and highly characteristic ice formations, which in the old days were called "kettles."

Schematically, the kettles represent a series of ridges of almost conical form, having deep valleys and depressions between them.

During the winter, an extremely characteristic type consists of *smorozi*. Along the White Sea this term is understood to mean accumulations of crushed ice and ice porridge which have been brought together by the winds and currents and have frozen together. Smorozi can attain large

*In the White Sea, above-water parts of a hummock are called *ropaki* and the under-water parts--*podsovy*.

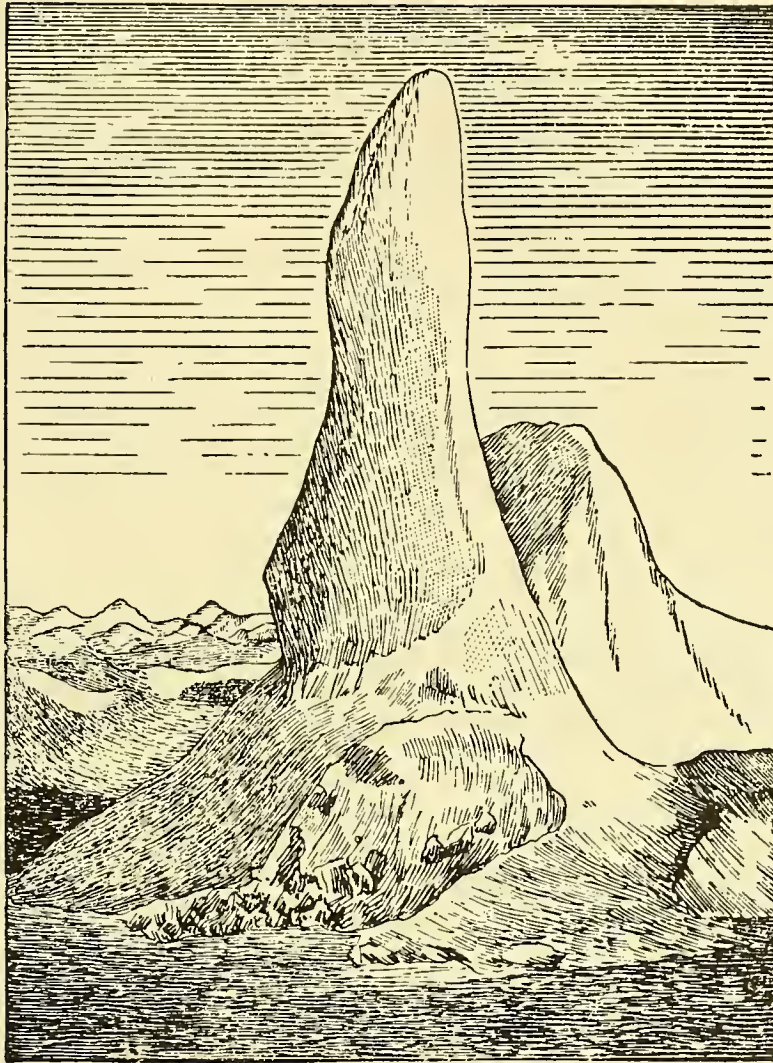

Figure 39. Hummocks.

thicknesses, and with cold air temperatures are almost impassible (or even completely impassible) to even the most powerful icebreakers. Cases are known when icebreakers breaking through smorozi, made less progress on the second blow than on the first. On the other hand, with the beginning of melting or during strong warm spells, the smorozi disintegrates easily into their component parts and are the first to disappear.

Ice frequency, computed in points on a ten-point scale, is of the highest practical importance in navigation. "Ice of five points" means that in a given area of the sea, 50 per cent of its area is covered by ice and 50 per cent is free. The following is a rougher classification of the ice according to its frequency:

"Rare ice" (1 to 3 points)--navigation in such ice is possible for all ships and almost without loss of speed.

"Scattered ice" (4 to 6 points)--in such ice, navigation is possible for all vessels, with almost no loss in speed for icebreakers and ice-breaking steamships, but with a 20 to 30 per cent loss of speed for ordinary steamers.

"Heavy" or "frequent ice" (7 to 8 points)--during navigation through such ice, icebreakers and ice-breaking steamships lose 20 to 30 per cent of their speed and ordinary steamships cannot navigate without the assistance of icebreakers.

"Compact ice" (9 to 10 points)--the possibility of navigation in such ice is determined by the thickness of the ice and the power of the icebreakers.

In the navigational characteristics of ice which have been given, it is assumed that ice fields and floes filling a given area are distributed in it equally, are sufficiently strong, and are split by a ship only with difficulty so that navigation is possible mainly along the channels. It is necessary to note, however, that the possibility of navigation is determined not only by the thickness and point-frequency of the ice, but also by the degree of their compression. Thus, for example, seven-point ice, whose ice fields and floes are wedged against each other at their corners, can prove to be impassible even for powerful vessels. Compact ice can also be compressed or weakened. The following examples affirm what has been said.

In the middle of February, 1938, the icebreaker *Erma k* traveled from Kronstadt to the Baltic Sea without any special difficulties. From the beginning of March, when returning to Kronstadt, the *Erma k* had such difficulty in forcing the ice 50 to 70 m thick that it was feared there would not be enough coal, and we were forced to return to Tallin for refueling. In March, the ice was neither more durable nor thicker than in February.

LITERATURE: 23, 62, 77.

Section 47. Fast Ice

As has already been said, fast ice, during the winter, borders shores, islands, and also ice standing in shallows.

The initial form of fast ice is "new shore ice," which forms first of all along the shores of bays, fjords, and straits well protected from winds and waves. Gradually, new shore ice, when increasing in thickness, extends further and further from the shore, (including in it the ice which had formed in the sea itself), and in narrow places, it reaches fast ice stretching from other shores.

At first, while the fast ice is thin, it is frequently broken by currents, tidal phenomena, and particularly by heaping and scattering winds. Scattering winds break considerable areas of ice from the edge of the fast ice. When the scattering winds change to heaping winds, the parts which are broken off from the fast ice and also the floating ice return. At this, the sea-side edge of the ice undergoes hummocking, and the parts broken off from the fast ice, along with the floe ice blown against the fast ice, freeze to the fast ice, thus increasing its area.

Gradually, as the thickness of the fast ice increases, the breakage phenomena occurs more rarely. Fast ice reaches its maximum development at the end of March and the beginning of April. Even though at this time its thickness continues to increase, solar radiation weakens the ice simultaneously and because of this the resistance of the fast ice to all sorts of breaking effects decreases.

Fast ice can be formed out of ice of common accretion and out of rafting ice. The first is characteristic of small bays and gulfs protected from the wind and currents, the second at open shore lines.

From the data which has been given, it is clear, as had already been established as a result of the work of the Toll expedition, that the following are the most conducive conditions for the development of fast ice;

1. An extensive shore line, especially if archipelagos of islands are located near the shores.
2. The absence of strong, constant currents and tidal phenomena which would assist in breaking up the fast ice.
3. Shallows, where the cooling of water always occurs considerably faster than above great depths and where ice formation, all other conditions being equal, begins earlier. The importance of shallows also manifested in the fact that ice heaping of various sorts, having considerable vertical measurements, ordinarily becomes grounded on shallower places like banks, rocks and shallows. Later, these heapings, under the pressure of the ice from the sea, increase in size, become more durable, and play the role of off-shore islands in the development of fast ice.

All the enumerated conditions are centered in the region of the New Siberian Islands, where, opposite the mouth of the Yana, the fast ice extends along the meridian for 270 miles, and along the 74th parallel for 350 miles (figure 40). Lappo correctly differentiates this region in relation to ice as a special fast-ice region, noting that the ice in it forms and melts under completely different conditions from neighboring regions. According to aerial reconnaissance data, the fast-ice area here is equal to approximately 380,000 cubic km in March and April of 1943. Nevertheless, shallow water is the determining condition for fast-ice distribution along the Siberian shore (with the exception of the Khatangskisaliva where the tidal phenomena are considerable and fast ice, because of this, does not extend far from the shore, and along the Chuckchee shore where the fast ice is broken by the Chuckchee current).

Separate ice heapings in the seas, washing the Siberian coastline, often have a displacement (draft) up to 25 m. Because of this, it is considered that, on an average, the 25 m isobath is a limit of fast ice distribution along the indicated shore. It is clear that at high altitudes fast ice forms even occur over greater depths in narrow straits.

Figure 104 shows the distribution of fast ice in the White Sea during 17-18 April, 1942, i. e., approximately during the height of its development. It follows from the drawing that in the White Sea, where stamukh does not play an important role, the fast ice line extends from the shore to approximately the ten-meter isobath. Fast ice attains its greater development at the summits of the Kandalakshski and Onezhskii Gulfs, in accordance with the general rule: along involuted shores, fast ice is better developed than along convoluted.

It can be approximately considered that along the White Sea, fast ice, by the time it is fully developed, occupies less than ten per cent of the sea's surface.

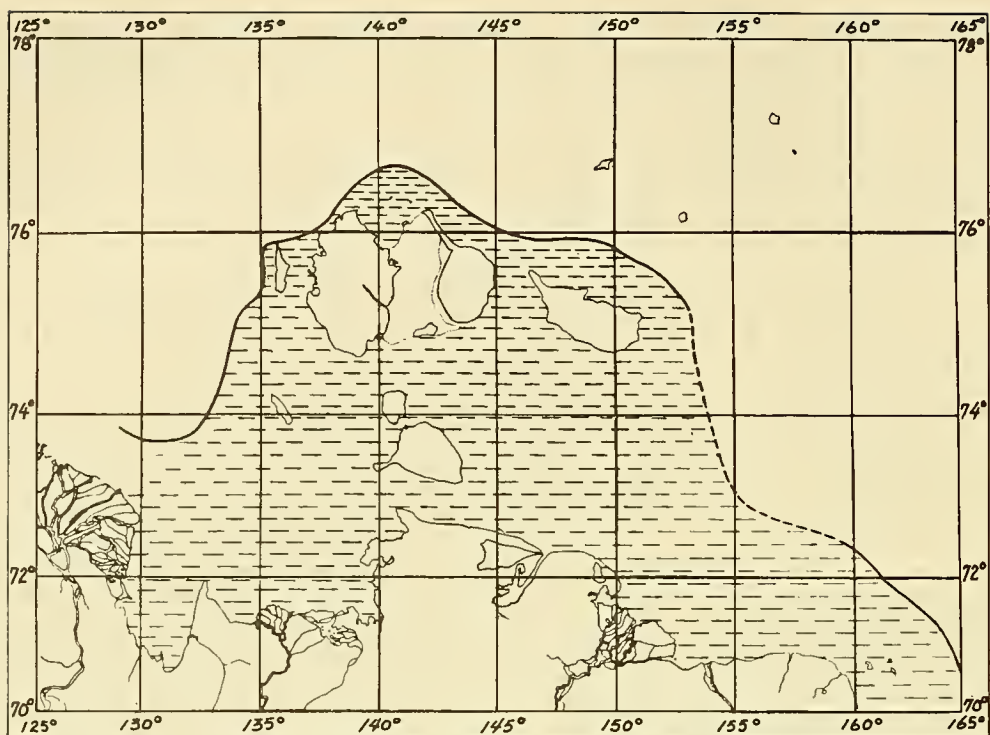

Figure 40. Fast ice region of the New Siberian Islands.

A straightening of the fast ice edge is characteristic in areas having strong tidal currents. The off-shore band of floating ice, when moving along the edge of the fast ice and when pressing against it, creates ridges above it. In the White Sea such ridges of crushed ice are especially characteristic along the Terskii shore from Ponoï to Cape Nikodinskii and at Rombakev in the Onezhskii Gulf.

Fast ice extension along the comparatively deep eastern shores of Novaya Zemlya is also characteristic. As has been established by numerous aerial reconnaissances here, the fast ice line at the moment of its greatest development, extends from cape to cape, filling in the bays and the fjords of the shoreline.

As we have seen, due to the very conditions of its formation and existence, level fast ice forms in closed bays and narrow straits and is hummocky along open shorelines.

At first, the increase in the thickness of the ice proceeds rapidly, but later, in spite of continued low air temperatures, ice accretion slows down. As a result, the ice which had formed with the beginning of frost and which had not undergone hummocking, by the beginning of January already attains a thickness greater than 100 cm in the seas of the Soviet Arctic. This thickness, in conjunction with the low temperature of the ice, is already sufficient to withstand the usual forces which break up fast ice. The formation of fast ice and the establishment of the position of its sea edge can be considered as finished by the above-indicated time. During the course of the winter, strong heaping occurs along this edge, due to the pressure of the floating ice upon the fast ice, and when the floating ice leaves the edge (caused by corresponding winds), wide fast ice polynyas are formed. The latter phenomenon is so characteristic, and has impressed all observers so

much, that it caused the concept of the so-called great Siberian polynya, which has been observed during sled trips from the region north of the New Siberian Islands to the region north of the shores of the Kolyma region. We will return to the question of this polynya in the future.

The fast ice of the arctic seas of the Soviet Union can basically be considered of year-old duration. Only in exceptional years are the separate bays and straits not open here. In some of the American regions of the Arctic Basin, old fast ice is found. Such fast ice is particularly characteristic of the northern fjords of Greenland, where it forms between glaciers falling into the fjords and the exits from the fjords, and which thus block the exit from the fjord by icebergs broken loose from the glacier. Koch called such old fast ice *sikussak*, which means old ice in Eskimo.

Old fast ice, which ordinarily contains several hundred ice-bergs, borne by this glacier, is formed opposite a small glacier in the Northern Hemisphere, called the Humboldt Glacier (on the northwestern shore of Greenland, which extends for 100 km along the shoreline.)

Every 20 to 25 years, this old fast ice breaks up, and only then are the masses of icebergs, imprisoned until then, able to move toward Davis Strait.

LITERATURE: 62, 77, 88, 133, 171.

Section 48. Floating Ice

Floating ice consists of an accumulation of separate floes and fields which had formed either in the sea itself or as a result of fast ice, old ice, or glacier ice. Therefore, ice of the most varied source and age can be found in the midst of floating ice. In the seas of the Soviet Arctic, year-old ice is predominant, but in higher latitudes, old ice is predominant.

Pack ice, due to the effect of currents, tidal phenomena, and also wind, is in a state of constant motion in both winter and summer. Due to this constant motion in different directions (mainly caused by the action of the wind), the separate floes comprising the pack constantly change their form and contours.

As we shall see further, the velocity of the movement of the separate floes is different, depending on the current or the wind. As a result, the floes which drift faster overtake the slower ones and later drift together at a certain average velocity. The belts are accumulations which form in their turn, overtake the accumulations, which drift more slowly. In this manner, ice fields are formed which are characteristic of pack ice.

When such an ice field presses against the shore or against immovable ice, hummocking occurs, both along the line of contact and within the ice field itself. First of all, the young and therefore the weakest parts of the ice field undergo destruction. Simultaneously, there is a decrease in the area of the field due to the hummocking.

When the wind changes direction, the ice field breaks loose from the shore or fast ice and begins to move in the corresponding direction until there is a new change in the wind or until it again presses against the shore fast ice.

It is clear that such phenomena assume special significance when there is comparatively little ice, which occurs at the beginning of winter. It is at this time that the greatest hummocking and the greatest breaking up of ice formations, comprising a given field, occur.

During the winter, the hummocked floes freeze together and form large fields. During the summer, the ice fields form the so-called broken ice during hummocking.

It is natural that, due to these processes, the surface of the floating ice is extremely uneven. Only in unusual circumstances does level ice form by natural means. This occurs when old, hummocky fields impinge against each other in such a way that "bays," protected on all sides, are created between them.*

The southern limit of pack-ice distribution is the shore during the summer and the sea edge of fast ice during the winter.

The position of the northern limits of pack ice in the Arctic Basin is extremely indeterminate and, in any case, extremely conditional. It can be considered as corresponding to the northern limits of free navigation by steamships during the summer. It can also be considered that the northern limit of pack ice follows approximately the 1,000 m isobath.

Plotting such a limit is possible first because it approximately corresponds to the northern limit of free navigation by vessels in the Arctic Basin, and second, because in crossing from great depths to the offshore shallows, the Atlantic waters, which fill the Arctic Basin in the form of warm, intermediate layer, rise to the surface here and have a weakening effect on the ice.

However, a comparison of the observations made of the "North Pole" stations and on the *Sedov*, and also observations from airplanes during flights made in organizing the "North Pole" station, has shown that there is no special difference between the ice which, let us say, fills in all and part of the Laptev Sea and the ice in which the ship *Sedov* drifted, but on the other hand, the ice on which the "North Pole" station was set up differed extremely from this ice.

The observations made by Alekseev are given below, and also those by Zhukov during the flight in May-June, 1937, from Rudolf Land (81° 45' north, 50° east) to the North Pole and back.

Strongly hummocked (hummocks up to 3 m) young ice, with *razvodyas* and fissures, were seen from Rudolf Land to 82° 30' north. Fragments of icebergs were found. Level areas measuring 100 or 200 square m were rarely found. From 82° 30' to 85° 30', the size of the fields increased to 20 km across. Level areas measuring 250 or 350 square m were found quite often. On 6 June 1937, when the airplane landed at 84° north, the thickness of the ice proved to be 100 to 200 cm. The ice was level with a great amount of ropaki, covered on top by a layer of snow up to 40 cm thick. The snow was slightly salty on top.

North of 85° 30', old ice began, wherein the ice fields were small, highly hummocked, the *razvodya* were jammed with small ice, brash ice, and young ice. A landing by an airplane on such airfields was impossible without crashing.

*Exceptions to this rule are the regions of strong tidal phenomena. Thus, in the White Sea estuary, even after lengthy and strong frosts, the main mass of the ice is composed of large and small, extremely hummocked floes. This is particularly noticeable in the region of Menzenskii Gulf.

The landing areas attain their greatest size between 87° and $88^{\circ} 30'$ north. Closer to the pole, they became smaller and worse. The field on which Alekseev's plane landed near the pole ($89^{\circ} 51'$ north and 47° east) was massive and old. Two long areas 500 by 300 square m were located on it, which were divided by a row of hummocks. Instead of *ropaki*, there were rounded, snow-covered hummocks here. The ice was completely fresh, and the snow cover resembled firn.

The field on which Schmidt's expedition organized the "North Pole" station on 21 May 1937, was typical pack field, having an area of 4 square km. It was about 3 m thick, and its surface was so level that four airplanes were parked on it simultaneously (figure 41).

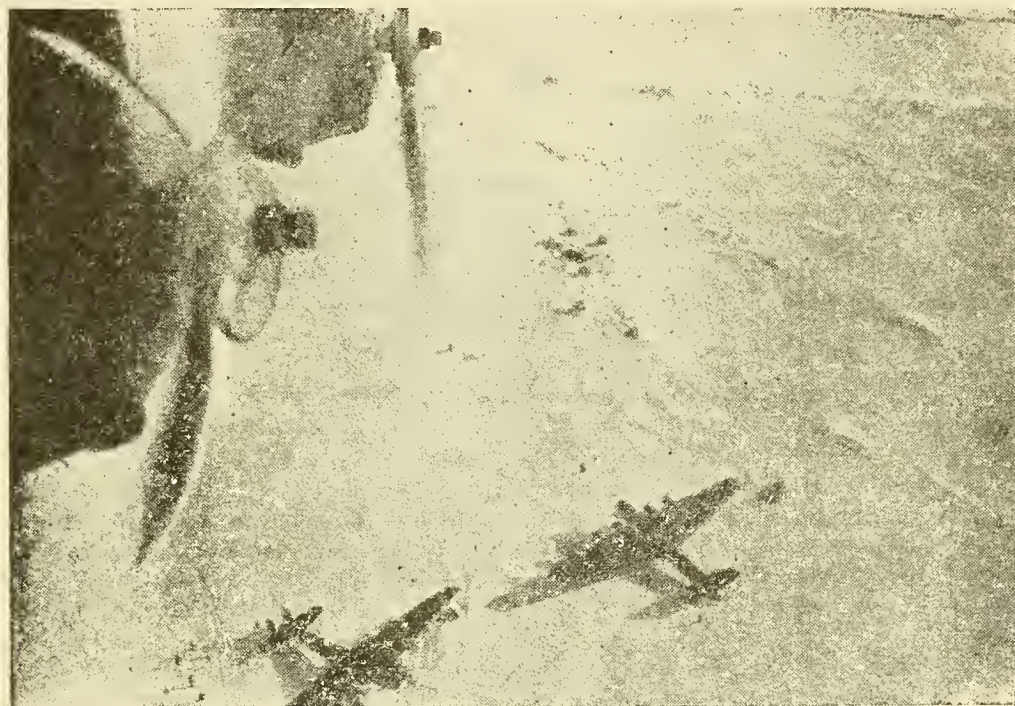

Figure 41. Ice in the region of the North Pole.

It can be seen from this description that seemingly a singular belt of hummocking divides (at least on the Rudolf Island meridian) the comparatively weak ice approximately along 86° north in which the *Sedov* drifted from the more powerful pack ice with which the "North Pole" station drifted. This belt resembles the hummocking belt observed along the sea edge of fast ice and, evidently, is caused by the same situations. *

*It should be mentioned that the Kanfi expedition (1900) on the way from Franz Joseph Land to the North Pole found highly hummocked ice at $86^{\circ} 34'$ north. In 1895, Nansen was stopped on his way to the North Pole by heavy ice at $86^{\circ} 14'$ north and 86° east. In 1939, the *Sedov* was unable to pass through the same area further north than $86^{\circ} 39.5'$ north. Thus, the belt of hummocking which borders pack ice is evidently a constant phenomenon.

During the decompressing northern winds, the more movable floating ice breaks from the pack ice and moves to the south, forming considerable channels and polynyas at the line of cleavage. During a return movement, they press against the pack ice and undergo hummocking.

LITERATURE: 62, 77, 88.

Section 49. Pack Ice

"Pack ice" is the most finished form of old ice.

They are large ice fields solidly compressed against each other so that the over-all area of water between them, even during the summer, does not exceed 2 per cent. The thickness of pack fields is not less than 3 m. Their upper surface is level and smoothed. There are no hummocks with the sharp configurations of floes. Instead of them, there are high (sometimes up to 10 m) but rounded hillocks resembling "sheep's forebrows" in form. Only along the edges of pack fields can hummocks of young ice be observed, which form in fissures between the fields during the winter as a result of the migrations of ice fields which still occur.

Several processes are necessary for the formation of pack ice:

1. An initial formation and thickening of ice by the natural method of freezing from the bottom.
2. An increase in the thickness of the ice due to rafting of separate floes and fields and their fragments upon each other.
3. The fusion of small floes and packs into large fields, which is particularly characteristic of compression during the winter.
4. Leveling of the upper and lower surfaces of the ice. This leveling occurs due to the following:
 - (a) During the same negative temperature accretion to thin ice is greater than to thick ice. Aside from this, during the period of growth, the lower part of the ice fields is brushlike, consisting of initial ice spicules which are connected very loosely to the lower surface of the ice. With the slightest movement of the ice in relation to the water, these spicules break loose from the lower surface of the deeper parts of the ice and float up under the less deep ice. Thus, other conditions being equal, the thin ice attempts to equalize its thickness to that of the thicker ice.
 - (b) Direct solar radiation, which falls at an angle in the arctic, acts most strongly on the hummocks elevated above the ice and destroys them first of all. The surface of the hummocks, which undergoes scattered solar radiation, is great by comparison with its volume. In this way, both direct and scattered radiation destroy the elevated parts of the hummocks.
 - (c) Melted ice water, which forms as a result of melting during the summer of the hummocks and the snow accumulations near the latter, drains into the depressions of the ice fields, and freezing here during the winter, increases the thickness of the thinner parts of the ice fields.

- (e) The "wind drying" of the ice, caused by evaporation and convection, which occurs both during the summer and winter, has the greatest effect on the parts of the hummocks which are elevated above the level ice.
- (f) The separate deeper parts of the ice fields, which are sufficiently durable at the beginning due to their low temperature, within time absorb the temperature of the water surrounding them, and because of this, become considerably weaker, and sometimes, if their salinity is low, they simply melt. In this way, all underwater projections of the ice fields are also gradually "wind blown." This phenomenon assumes particular importance during all the migrations of the ice fields. The protruding underwater parts of the ice fields, weakened by a rise in temperature, disintegrate during this time and their pieces float up to the thinner parts of the ice.

5. Freshening, as a result of a gradual drainage of the more dense (than sea water) brine in the saline cells, is especially intensive during the rise in the temperature of the ice, and also as a result of the expulsion of brine during compression.

6. A decrease in the porosity of the ice, as a result of the same compressions.

7. Isostatic phenomena (see Section 103), which consist of the fact that when the above water or underwater projections of the ice fields are destroyed, the corresponding parts of the fields either rise or fall. As we shall see, this phenomenon occurs most intensively during the summer.

As is known, both the *Fram* and the *Sedov* observed three-year-old ice, but just the same, that was not real pack ice, as was, for example, the field of the "North Pole" station.

Thus, pack ice in its main mass is old ice, consisting of floes which are powerful, very compact, also monolithic, almost fresh, and almost free of air bubbles, and represents in itself large fields of comparatively level ice which form areas sufficient in size for airplane landings. Along the edges, these fields are bordered by young hummocks and criss crossed sloping ice mounds (smoothed ridges of hummocking) *.

In separate areas, however, pack ice is a chaos of upraised and heaped-upon-each-other chunks of ice, in the distribution of which there is no regulation (hummocking area.)

The assumption has been made that not all of the pack ice (in the final summation) drifts to the Greenland Sea, i. e., the ice field of the "North Pole" station drifted, but a part of it drifts further to the west and enters into the region of constant pressure in the area north of the American mainland.

Actually, it is just in this region that the greater variety of pack ice is found--the "paleo-crycistic ice" (figure 42). Nares introduced this term to designate compact sea-ice formations resembling in their size and power fragments of glacier ice, but which had come about as a result of hummocking and rafting of ice of sea origin. Participants in the *Zarya* expedition evaluated

*As Libin informed me, in the area where the airplane N-169 landed (beyond the 80th parallel on the Wrangel Island meridian) pack ice occupied 80 per cent of the area visible from the airplane. The intervals between them were occupied by ice fields of one to 1.5 years of age and 150 to 200 cm thick. Airplane landings (2-28 April 1941) were made on such fields.

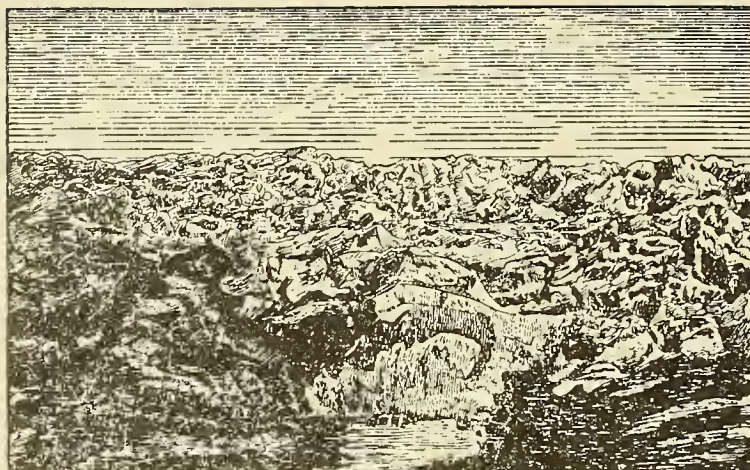

Figure 42. Paleocrystic ice.

the average power of the paleocrystic fields at 30-and-more meters, noting at this time that even in the frontier seas of the Siberian shoreline, where the ice is weaker, separate grounded hummocks attained greater dimensions.

LITERATURE: 67, 77, 88, 171.

Section 50. Glacier Ice

In the North Arctic Ocean, along the shores of Antarctica, and also in some areas of the middle latitudes of the world ocean, aside from the ice formed of sea water, glacier ice is found, which differs from sea ice both in its forms and in its properties. In high mountain passes and in the low latitudes, and especially in the polar regions, where during the course of the summer a smaller amount of snow melts than has been precipitated during the winter, a constant accumulation of snow occurs in depressions. In addition, the snow which had fallen on neighboring, more elevated points of the locale, is carried into the same depressions by the wind and by the weight of the snow itself. It is clear that an accumulation of a great amount of snow is aided by high latitudes, the great elevations above the level of the sea, and marine climate which is characterized by the frequency and intensity of winds off the sea, which carry with them moisture and abundant precipitation.

Gradually, with the increase in the amount of snow cover, the lower layers of the snow undergo important changes. First of all, due to the pressure of the upper layers, they become more solid. Secondly, due to the effect of the same pressure, which lowers the temperature of freezing, they are gradually transformed.

The first phase in the transformation of snow is "firn ice," which consists of a conglomeration of separate ice grains, white in color, and the size of peas. The next stage is a "bubble ice," which forms from the seeds of the firn frozen together and which includes within itself great amounts of air bubbles.

In time, the air bubbles are pressed out through cracks by pressure of the upper layers, and the last stage is obtained--"blue glacier ice."

Glacier ice consists of irregular, rounded grains of various sizes, each of which represents a crystal with a special optic orientation. These grains are sometimes the size of a pigeon's egg, and the deeper they lie, the larger they are. Crystals weighing up to 700 g have been found in the Alps. It is considered that the growth of these grains is due to melted water circulating in the spaces between the crystals or due to the absorption by the larger grains of the adjacent smaller grains, which had the same optic orientation. It is characteristic that every accumulation of ice in time assumes a rough, granular structure, and glacier ice, especially at the ends of the glaciers, is always very old.

Aside from its granular structure, glacier ice is also characterized by its laminar structure and streaking; along the edges of the hanging walls of the glaciers and icebergs it can be seen that the mass of the ice consists of more or less dense, alternating white and blue streaks.

This phenomenon is explained differently. Some consider that these streaks are connected to the periodic precipitation. This is proven by the fact that in southern glaciers the separate layers are divided one from the other by summer deposits of dust. Others say that the striations of glacier ice are formed as a result of slipping of the different layers of the ice over each other. Blue ice is formed along the point of contact of these layers due to melting and pressure, whereas the slipping parts, consisting of firn ice, remain white. A third group admits that both factors participate in the formation of striated glacier ice. The noted peculiarities make it possible to consider glacier ice as "pressure ice," as distinct from ice formed from sea water and being "thermic" ice.

Naturally, glacier ice differs sharply in its composition from sea ice. Experimenters have shown that water obtained through melting of glacier ice hardly differs from distilled water.

After a given depression is completely filled with ice and snow, glacier ice begins to stream out of the area of its accumulation down one or several beds, depending on the contour of the locale, analogous to the fact that one or more rivers can flow from one and the same lake.

This property of ice, to flow along valleys as a result of its plasticity, represents in itself the most noteworthy property of glaciers. The velocity of glacier motion, according to Vall's data, is 10,000 times slower than the velocity of the flow of water, having the same angle of drop. During its descent, the glacier, like a river, goes around separate elevated areas, sometimes dividing into arms and often again uniting.* With each turn and narrowing of the bed, additional compressions and tensions arise in the mass of the glacier, causing the phenomenon of "coalescence," consisting of the fact that with each compression, the ice melts somewhat and during the next decrease in pressure it again freezes together.

In the low and middle latitudes, the "basins" of snow and ice nourishing the glaciers ordinarily occupy high valleys located between mountain ridges and separate elevations. The glaciers

*As is well known, rivers flowing through soft formations lay out a bed having, in cross section, a triangular form with its peak down. The bed laid out by glaciers, for the most part, has a flat bottom and very steep side inclines. Aside from the cross section, the beds of glaciers are also characterized by their longitudinal profiles. Thus, in valleys which had been covered by glaciers, the bottom of the valley is often deep due to the eroding action of the glaciers. In the Spitsbergen, Novaya Zemlya fjords, we ordinarily find the greatest depths at the very wall of the glacier, and the fjords themselves are separated from the sea by a shelf which had formed from moraine materials.

flowing from these basins gradually flow into the lower altitudes, undergo constantly greater destruction and melting, and finally give rise to mountain rivers.

In ratio to the increase in the geographic latitude, the snow line comes down lower and lower; the extremity of the glaciers reach the level of the sea where they are of special interest to marine studies. Actually, the glaciers determine here the shoreline, change the contours of the adjacent sea bottom, and are a constant source of large masses of glacial ice in the sea.

As has already been pointed out, several conditions are favorable to the formation of glaciers, namely: high latitudes, high altitudes above sea level, and copious precipitation which is determined by the distribution of the land and the sea, marine currents and winds, and also the contours of the locale.

In some areas of the arctic and antarctic, all these factors are included. As a result, tremendous "icecaps" are created, which almost completely cover separate islands and continents. The main difference between the arctic and the antarctic is the fact that in the center of the latter, a tremendous and high continent (average height about 1,500 m) is located; in the middle of the arctic there is located the deep Basin (more than 4,000 m deep). This determines the fact that the main mass of the ice cover in the arctic is sea ice and in the antarctic is glacial ice.

The main glaciation in the arctic is in Greenland, where 90 per cent of glacier ice in the Northern Hemisphere is concentrated; it occupies an area of 1.9 million square km, with an overall area of this island equaling 2.1 million square km. At the same time, the sea ice of the Northern Hemisphere at the instant of its greatest development occupies an area of about 1200 million square km.

In the Northern Hemisphere, aside from Greenland, land ice reaching sea level is also located on the outer shores of Baffin Bay. Smaller, isolated glaciation is found in the American sector of the arctic--on Prince Patrick and Melville Islands. In the Eurasian sector of the arctic, glaciation is located on the islands of the Spitsbergen archipelago, on White and Victorian Islands (between Spitsbergen and Franz Joseph Land), on the islands of Franz Joseph Land (approximately 97 per cent of the area of the entire archipelago is covered by land ice), on Novaya Zemlya, on Ulsakov and Schmidt Islands (between Franz Joseph Land and Severnaya Zemlya), and on Severnaya Zemlya. The only known place of glaciation east of Cape Cheliuskin is on the Delong Island, and there the glacier reaches the sea only on Henrietta Island (figure 43).

An investigation of the glaciation in the Northern Hemisphere attracts attention first to the fact that the more northerly parts of the land, namely Greenland and Ellesmere Land, are free of glaciers. Labrador, having a very low summer temperature (about 7°) and also being located in the path of summer cyclones, is almost completely free of glaciers. The entire northern shore of Spitsbergen is almost completely free of glaciers. It follows from these examples that high geographic latitudes and low summer temperatures are still not enough for the formation of glaciers. Altitude above sea level is also not enough, nor are large horizontal distances. Thus, for instance, the very small Victoria Island (about 6 km long), located between Spitsbergen and Franz Joseph Land, is almost completely covered by glacier ice, whereas higher and larger islands, located further to the north along the northern shores of Spitsbergen, do not have an ice cover. Without a doubt, the most important, other factors being equal, is the amount of precipitation. Thus, for instance, it is known that in Iceland, along the dryer northern side, the snow line is located at 1,000 to 1,300 m above sea level, while on the southern, moister side, it decreases to 600 to 800 m, i. e., it is located 300 to 500 m lower.

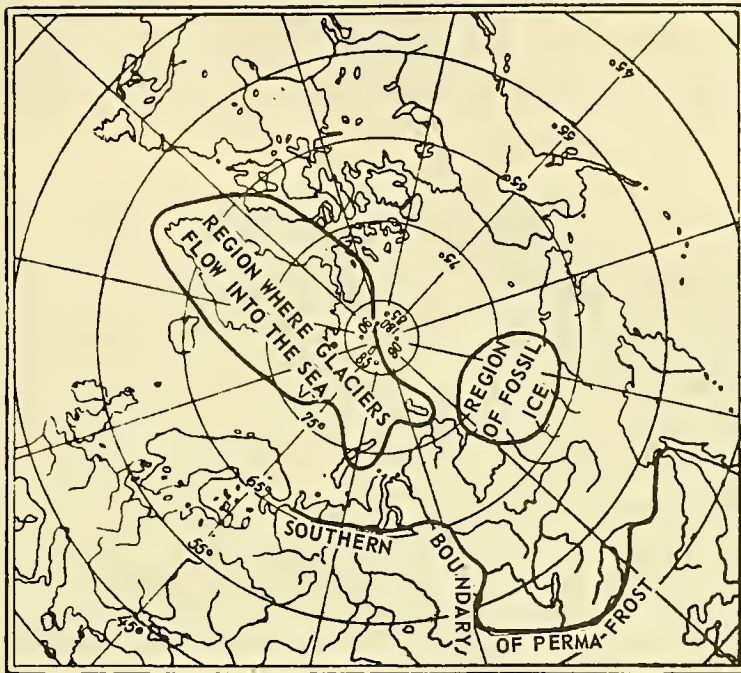

Figure 43. Boundaries of glacial regions, fossil ice and permafrost.

The question of whether present-day glaciation is, as a whole, a relic, or if at a given stage it is in a state of equilibrium, is extremely interesting but still unsolved.

Brooks, especially in Greenland, does not consider glaciation a relic. He points out that on the western side of Greenland, the snow line passes approximately 90 km from the shore and divides the ice dome into two parts, accumulating and destroying. The accumulating part annually receives 36 cm of precipitation. The thickness of the destroying part decreases from 2 m at the edge to 0 m at the snow line and averages 95 cm. Of these 95 cm, about 75 per cent is destroyed in melting and evaporation and about 25 per cent in the formation of icebergs along a 90 km belt.

The glacier color of Greenland, and also its numerous glaciers, have been comparatively well studied through observations made during crossings of the icecap and also through observations made during the numerous sledge and marine expeditions.

The icecap of Greenland consists of two domes: the northern, having its center near 75° north, and the southern, having its center near 65° north, with corresponding heights of 3,250 and 2,920 m (possibly there is a third dome in the area of Angmatssalik). According to Wegener's seismometric measurements, the thickness of the ice in the western part of the cap attains 2 to 3 km. If the entire mass of Greenland ice is melted, the level of the ocean would rise approximately 8 m.* between the northern and southern domes of the icecap, approximately along the 70th parallel (Greenland is divided by a deep valley). Into this valley the ice flows along the slopes of both domes and, further, along the valley into the sea, mainly on the side of the Baffin Gulf since the

*It has also been computed that if all the ice covering the antarctic mainland is melted, the level of the world ocean would rise 23 m.

climate is less severe here and also because the slope of the valley is steeper, and therefore the area of ice accumulation is greater. The fact that the main mass of Greenland icebergs is calved between 65° and 75° north is explained mainly by the presence of this cross valley.

LITERATURE: 62, 79, 143, 146, 171.

Section 51. Icebergs

The ends of glaciers, falling into the sea in a form of hanging walls or steep slopes in proportion to their entry into the water, undergo a constantly increasing pressure of the water from the bottom upward due to the low density of the ice. In connection with the periodic and non-periodic fluctuations of the sea, this pressure first increases then decreases, and as a result, chunks of ice of smaller or larger size break off from the end of the glacier. Icebergs, extremely different in size and form, starting with small "pups" and ranging to tremendous "ice mountains," are formed in this manner. Drigalskii considers that the end of a glacier can waste in three ways:

In the first, a complete fissure going approximately across the end of the glacier is formed. The broken-off monolith of ice, after several fluctuating movements at opposite positions of equilibrium corresponding to its form, becomes an iceberg carried from place to place by marine currents and wind. The largest icebergs are created in this way.

The second method is characteristic during the summer for the comparatively southern latitudes, particularly in Baffin Strait. If the summer wastage of the glacier end is greater on top than its wastage in the water, then the arm of the glacier finally becomes an underwater shelf, which extends for a considerable distance into the sea. In time, this underwater shelf breaks off and floats up from the depths of the sea. It is clear that such "float-up icebergs" cannot be of a large size. Aside from this, they are outstanding in the great erosion of their form.

In the third form of end-glacial waste, large and small chunks of ice gradually break off from its hanging wall and fall into the water. This method of wastage is especially characteristic of slowly moving glaciers in the high latitudes and of ice-dome islands (see Section 53).

Every glacier falling into the sea can be characterized by its productivity, i. e., by the amount of icebergs produced annually and also by the size and form of the latter.

First of all, the productivity of a glacier is determined by the velocity of its flow. As a whole, this velocity is always greater along the axis of the glacier (than along the edges) and in the upper part (than in the lower).

The flow velocity of some glaciers in Greenland is extremely great. Thus, for instance, Quarayaq Glacier, along the western shore of Greenland (70° north, 50° west), which is only 5 km wide along its front, with an altitude of 100 m above sea level at the end of the arm, flows at a velocity of 20 to 25 m per day, i. e., at a velocity almost 20 times greater than the velocity of the most rapid Alpine glaciers. Jakobshaven Glacier, located somewhat farther south, which does not halt its activity even during winter and which yields, by computation, 1,350 icebergs annually, or about 10 per cent of all the Greenland icebergs, flows with the same velocity.

In August, 1928, Smith counted 4,000 to 6,000 icebergs in the Jakobshaven fjord. It is noted that after indeterminate periods of time, approximately ten times a year, a chain of icebergs (evidently after breaking an ice dam which had formed somewhere), begins to move toward the exit from the fjord, slowly at first but later at a velocity of 10 to 15 km/hr. All this is accompanied by

a great noise, heard for several miles and continuous for several days. This glacier, occupying only 7 km along its front and having a front altitude of 88 m above sea level, evidently yields the greatest and most fantastic icebergs of the Northern Hemisphere. Its peculiarity, as is usual with rapid glaciers, is the fact that the icebergs calved by it are higher than the face of the glacier. Thus, for example, Drigalskii saw in this region an iceberg which towered 149 m above the level of the sea.

The glaciers, occupying a considerable distance along their fronts but moving slowly, can produce no icebergs at all or produce very few of them, wasting mainly by means of calving larger or smaller chunks of ice. Thus, for example, again in Greenland, in the environs of Frederikshaab the front of the glacier occupies 20 km of shoreline, but the rate of flow of the glacier is equal to the rate of melting at its end, and because of this, this glacier produces no icebergs.

In the Northern Hemisphere, one of the largest glaciers in frontal width is the glacier which falls toward Northeast Land (Spitsbergen) from Cape Leigh-Smith to Cape Mohn and which, according to Nordenskjold, presents an unbroken ice wall inaccessible from the sea about 100 km in length. But the productivity of this glacier is so small that during 1930, for instance, we on the *Knipovich* did not see a single iceberg in the nearby regions.

The Qariaq and the Jakobshaven Glaciers of Greenland fall into Disko and Nordost Bays, which are located exactly across from the Greenland cross valley, down which the main flow of mainland ice is directed. Because of this, these glaciers, along with numerous other glaciers falling into these same bays, annually yield, according to Smith, 5,400 (out of 7,500) large icebergs (i. e., such that their size would be sufficient to pass Davis Strait and then descend into the Newfoundland area without melting or disintegrating.)

The productivity of glaciers also depends on local conditions. The glaciers of Northern Greenland flowing into the North Arctic Ocean (the northernmost glacier of the Northern Hemisphere--Jungersen Glacier--is located near 80° north), have arms reaching far out to sea like the glaciers of the antarctic, due to the severe climatic conditions and the nearness of the pack and paleocrystic ice.*

The size of the icebergs, as we have seen, depends partly on the velocity of the glaciers flow, but, of course, it is also determined by its vertical and horizontal measurements. In this relation, the icebergs of the Northern Hemisphere can in no way be compared with antarctic icebergs.

The largest Greenland icebergs (of 87 icebergs measured by Drigalskii) was 149 m high. Krummel mentions an iceberg 17 to 22 m high, 13 km long, and 6 km wide, encountered near Baffin Land in 1882. The weight of such an iceberg would be about 23 million tons.

The icebergs of eastern Greenland are considerably smaller. The largest of them, not far from its place of inception, was 70 m high and about 1 km long. The size of the largest iceberg reported by the International Ice Patrol, near Newfoundland (where West Greenland icebergs are carried almost exclusively) was: height, 87 m; length, 565 m.

*It is considered that the arm of the Petterman Glacier (81° north, 62° east), which is the longest one in the Northern Hemisphere (several meters high above the surface of the water), extends the float at least 40 km out to sea. Such arms, which break themselves a path through old piled-up fast ice, break off once every 15 to 20 years.

At the same time, antarctic icebergs are often several tens of kilometers long. Thus, for instance, in 1854 in the Atlantic Ocean (44° south, 28° west), an ice mountain measuring 75 to 120 km long and 90 m high was observed. In 1894, south of New Zealand, the steamer *Antarctic* saw an ice mountain 130 km long. In November, 1904, near the Falkland Islands, the vessel *Zenita* saw a mountain whose height was determined at 450 m.

After the iceberg is separated from the end of the glacier, under the influence of the wind or currents, it begins to move or to be carried out into the open ocean or ground itself on the offshore shallows where it gradually changes its original form and is destroyed.

The icebergs in the North Arctic Ocean have little practical significance. This is explained by the fact that here icebergs are found far from the usual trade routes and also by the fact that, as a whole, there are very few of them in the European sector of the arctic. Thus, according to the computations of Smith, about 600 small icebergs were born here annually.

The glaciers of Spitsbergen and Novaya Zemlya are located in the "muff" of deep fjords, separated from the open parts of the sea by a comparatively shallow shelf. Because of this, a large, newly calved iceberg must first decrease in size in order to pass out of the fjord. And the small iceberg, when reaching the warm waters of Spitsbergen and Nordkapp currents, melts very rapidly.

The icebergs of Eastern Greenland also have little practical importance. They also are comparatively small in size, and, on the whole, there are few of them. Those which succeed in leaving the fjord travel near the shore along with the East Greenland current to the southwest around Cape Farewell, and here they join the West Greenland icebergs. Figure 44 shows, according to Smith, the usual western and southern borders of distribution of Eastern Greenland icebergs around Cape Farewell.

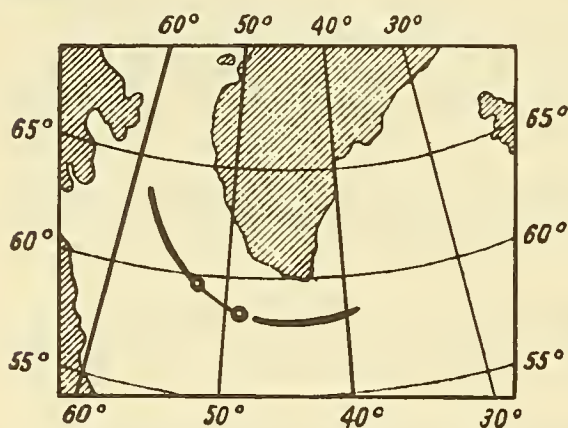

Figure 44. The extreme western and southern limits of distribution of East Greenland icebergs.

As has been pointed out, the icebergs of Baffin Strait are of the greatest practical importance. Along with pack ice, they are carried out into the open ocean by the Labrador current, and here their course crosses the most important trade routes between Europe and the ports of North America. In spite of the fact that the icebergs of Baffin Strait, in their amount, comprise, according to Smith, only 2 per cent of the amount of sea ice which had formed during the winter in the same sea, it is the icebergs, not the surviving sea ice, which comprise the main threat to marine navigation.*

*In April, 1912, the steamer *Titanic* sank as a result of a collision with an iceberg at $41^{\circ} 46'$ north, $59^{\circ} 14'$ west, at which time 1,513 persons lost their lives.

The shape of the icebergs also depends on local conditions. At the moment of calving, icebergs can be divided into two classes: table-like (figure 45) and pyramidal (figure 46).

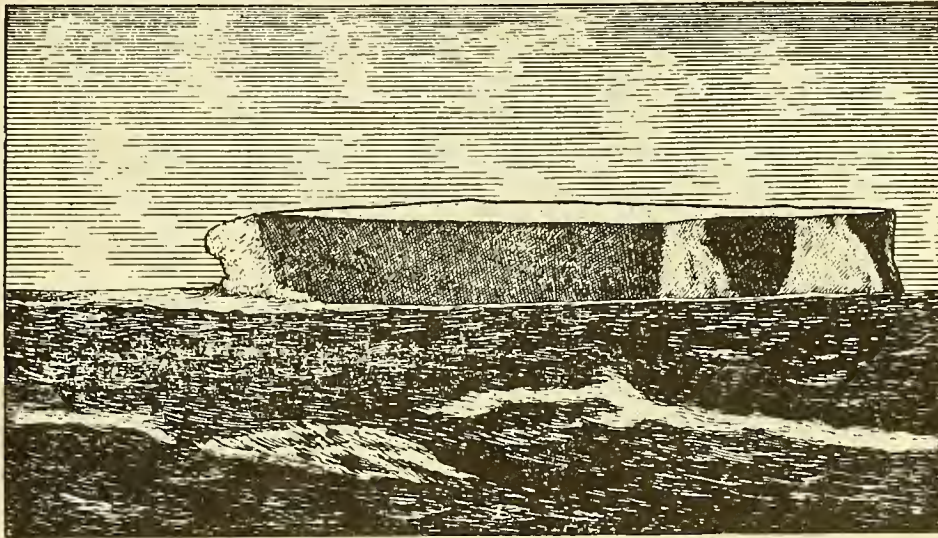

Figure 45. Table-top ice mountain 40 m above sea level.



Figure 46. Pyramid iceberg.

The first are characteristic of the antarctic, where the icebergs are formed mainly by cleavage from level ice arms or by separation from the main mass of the shelf ice. In the high latitudes of the arctic, near Franz Joseph Land, for example, where the flow of the glaciers is slow and where the glaciers are narrow and comparatively high, ordinarily icebergs of almost perfect cubic form are found.

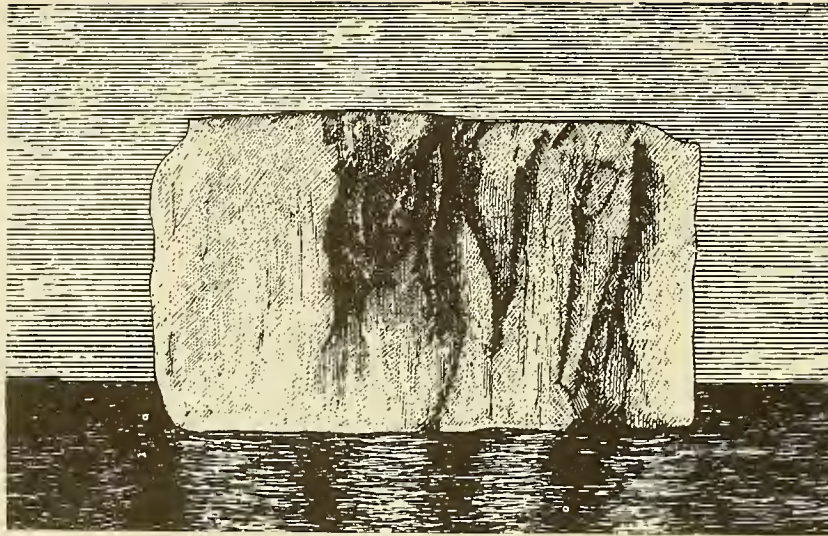

Figure 47. Icebergs cubic in form.

Pyramidal icebergs are characteristic of rapidly moving glaciers located in the more southerly latitudes, which are conditioned by high gradients of velocity and strong waste of the ends of the glaciers due to melting. The most fantastic iceberg shapes of the Northern Hemisphere are evidently yielded by the Jakobshaven Glacier, as Smith points out.

In time, the icebergs, due to unequal destruction of their under- and above-water parts, become constantly more fantastic and varied in their shape.

Iceberg classification (I have used Smith's classification as the basis of it) is as follows:

"Table-like" forms (right-angle, cubic, with more or less precipitous side walls) are characteristic of young icebergs calved under severe climatic conditions by slowly moving glaciers.

"Pyramidal" forms are characteristic of young icebergs calved by rapidly flowing glaciers.

"Rounded" forms are characteristic of old icebergs under severe climatic conditions, whose sharp outlines have been rounded by the action of the sun and the wind. The rounded forms are particularly characteristic of icebergs which have floated up and also of icebergs which have turned over or floated up after their underwater parts have been destroyed (figure 48).

"Fantastically eroded" forms are characteristic of young icebergs calved by rapidly moving glaciers.

"Columnar" and "grotto" forms are characteristic of icebergs whose underwater part is considerably destroyed by the sea and atmosphere. Such forms are ordinarily distinguished by strongly developed under-water projections.

"Winged" and "horned" forms are characteristic of icebergs in the last stages of destruction of their above-water parts (figure 49.)

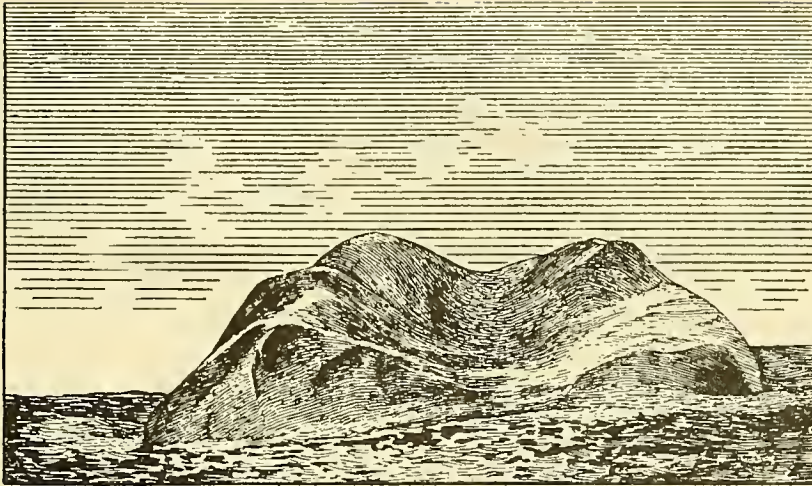

Figure 48. Rounded iceberg.

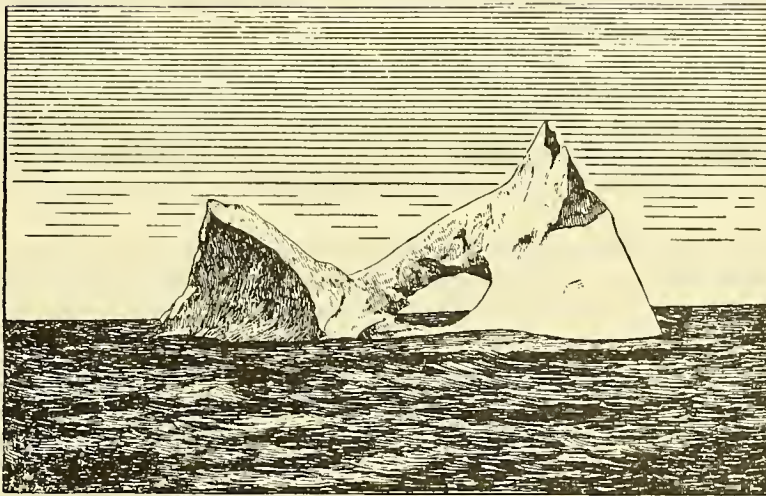

Figure 49. Iceberg with a window.

It is clear that the icebergs encountered cannot always be related to one of these listed forms.

One sign, however, remains unchanged. A recently calved or recently split iceberg has sharp outlines--like a broken lump of sugar. In time, due to melting and wind wastage, the sharp external forms of the icebergs disappear, yielding to soft, eroded forms. Thus, the degree of rounding of the iceberg's outline is a sign of its relative age.

As we shall see further, the relation of the underwater deposit to the above-water elevation of sea ice, even for floes having horizontal upper and lower surfaces and vertical side walls, fluctuates within considerable limits, depending on the density of the ice and the density of the water in which the ice is floating.

But the irregularity of their form has still greater effect on the draught of the ice. Therefore, if the floe has flat and wide underwater parts, its narrow above-water part can rise considerably above the level of the sea. This phenomenon is particularly frequent with icebergs destroyed by melting, which adopt extremely fantastic forms during this period. Thus, according to Smith, the relation of the draught of icebergs to their elevation above sea level is equal, on an average, to the amounts shown in table 27.

TABLE 27. THE RELATION OF THE DRAUGHT TO THE HEIGHT OF THE ABOVE-WATER PART OF ICEBERGS OF VARIOUS FORMS

Table top icebergs	5
Rounded icebergs	4
Pyramidal icebergs	3
Columnar icebergs	2
Winged icebergs	1

These results are based on numerous direct measurements of the heights and draught of icebergs which were carried out by the International Ice Patrol, and also according to the observational data of many expeditions.

The course of meltage and destruction of icebergs is extremely characteristic. It is, however, necessary to differentiate between the wastage or destruction of icebergs in the areas of their formation and in the areas to which they have been carried. These processes have been studied best in the areas of the Labrador Current and the Gulf Stream.

According to Smith, during the summer, water in the Labrador Current is cold and the air is warm; because of this the above-water part of the iceberg melts first of all. But in the Gulf Stream, during the spring, the water is considerably warmer than the air, as a result the underwater part melts and is destroyed faster.

Melting reaches its greatest rate during the summer in the Gulf Stream (warm air and warm water). Rivulets stream down the iceberg in a constant flow, different pieces and chunks break off from the iceberg now and then, the center of balance is destroyed, and the iceberg frequently turns over. It is natural that the smaller the iceberg, the more rapidly it melts. This is explained not only by the fact that the smaller the iceberg, the greater is the relation of its surface to its size, but also by the fact that the small iceberg floats in the surface layers more, i. e., the water layers which are more mobile and, during the summer, warmer.

According to Smith, the height of an iceberg during the summer in Baffin Gulf decreases by .7 m per day on an average; in Davis Strait, this decrease is up to 1.3 m; in Newfoundland, up to 2.0 m; and to the south of the Great Banks, up to 3.3 m per day. In the three months of its journey from Baffin Gulf to the region south of the Great Banks, the average height of an iceberg decreases from 80 to 40 m, and its mass from 1,500,000 to 150,000 tons.

According to the observations of the Ice Patrol, the height of the icebergs in the Gulf Stream decreases by 10 m per day in separate instances, and in June, 1926, a large iceberg 127 m long melted in 36 hours at the edge of the Gulf Stream.

The destruction of icebergs in warm waters is increased during stormy weather, when a mechanical erosion of the icebergs is added to the thermal effect of the air on the water. As Smith indicates, this erosion of icebergs is centered on the central part of the iceberg. Actually, one of the ends of the major axis of the iceberg becomes eroded, due to the loss in weight, this end rises and erosion begins on the other side. At the same time, erosion does not cease along the short axis (near which the fluctuation occurs). This explains the characteristic form of the icebergs and floes resembling a saddle as a result of their erosion.

LITERATURE: 62, 143, 151, 171.

Section 52. Icebergs in the Soviet Arctic Seas

In the Eurasian sector of the arctic, icebergs are found in the Berents (mainly in the north-western part), the Kara and Laptev seas.

The glaciers of Spitsbergen do not yield icebergs of any importance. In any case, in 1933, during our navigation on the vessel *Knipovich*, we did not see a single iceberg from Hope Island to White Island.

Near White Island, which consists of an icecap island, (during the journeys of 1930, 1932, and 1935) I observed many icebergs, both from its southern and its northern side. The icebergs were small with hanging walls. In the majority of the cases, they stood in shallows, evidently grouping themselves near separate banks, which were somewhat removed from the island.

Near Victoria Island, which we circumnavigated in 1932, there were few icebergs; they were also not very large, and they also stood in shallows.

There are more icebergs near Franz Joseph Land. Their height above sea level reaches 25 m, and the length up to half a kilometer. Leigh-Smith mentions an iceberg several miles long. The cubic form of icebergs is most common in this area.

It is possible that such a form of icebergs is partially connected with the slow movement of the glaciers. Thus, according to Vize, the glaciers on Guker Island flow at a rate of 12 to 17 cm diurnally, and their summer rate of flow is greater. From 24 April to 4 August 1933, the glacier on Rudolf Island flowed at a rate of 9 cm diurnally, judging by the displacement of the guide stake by 9.13 m during this time. It is curious that during the Duke of Abruzzi expedition (1899-1900), the movement of glaciers on this island was not observed.

If the straits of Franz Joseph Land, which each glacier flowing into the sea is near, are ignored, icebergs are more numerous near the southwestern and northwestern shores. Here also, they seem to border the banks a distance from the shore. In the beginning of August, 1928, the *Sedov* counted 24 icebergs south of Alexander Island.

Icebergs are seldom found between Victoria Island and Franz Joseph Land. At any rate, in 1930, we saw 2 or 3 icebergs, and in 1932, while rounding Franz Joseph Land, we did not see a single iceberg when there was complete absence of ice and visibility was good. We also saw no icebergs (with exception of icebergs in the straits) during the 1932 voyage from Rudolf Island to Belaya Zemlya, and further south around the eastern shores of Franz Joseph Land, and during the 1935 voyage near the eastern shores of Franz Joseph Land.

Along the Berents Sea shore of Novaya Zemlya, no icebergs are found as a rule in the open sea, even though in the depth of almost every fjord of the northern island of Novaya Zemlya there are glaciers falling into the sea.

Thus, Franz Joseph Land (figure 50) should be considered the greatest producer of icebergs in the Berents Sea. In certain years, these icebergs conclude surprising voyages.

Thus, in April, 1929, icebergs were seen at 71° north and 34.5° east. In the first ten days of May, these icebergs showed up near Murman. The position of some of them was as follows: 1 - $68^{\circ} 13'$ north, $39^{\circ} 24'$ east; 2 - within four miles northeast of Cape Chernyi; 3 - $69^{\circ} 22'$ north, $35^{\circ} 44'$ east; 4 - within 20 miles northwest of Cape Tsip-navolok; 5 - near Teri berki. The height of the icebergs was up to 12 m above sea level. Later, these icebergs, carried into the strait of the White Seas, stayed near the Kaninskii shore through June.

Such an extremely rare course of icebergs has to be explained by north winds which had blown the icebergs into the Nordkapp Current, which afterwards carried them to the east along the Murmansk shore. This example, at the same time, illustrates the longevity of icebergs, explained by their great mass and monolithicity.

In the Kara Sea, along the eastern shore of Novaya Zemlya, almost no icebergs can be found for the same reasons as along its western shores: the existing system of currents and winds forces them to the shore, and, furthermore, the shallow steppes do not permit them to move out of the fjords in which they have broken off from the glacier.

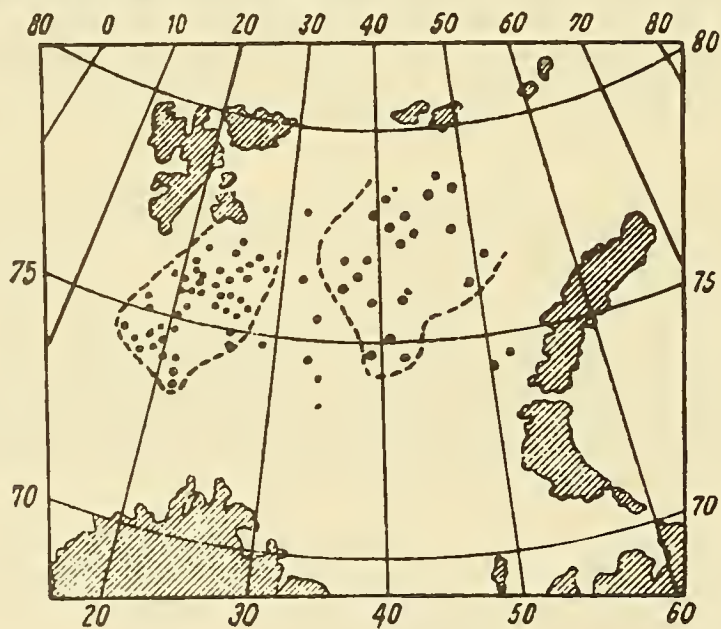

Figure 50. Locations of icebergs found in the Barents Sea from 1899 to 1928.

Many icebergs are found near Ushakov Island. Actually, this island was discovered by us (expedition on the *Sadko*) in 1935 in a fog, chiefly due to an unexpected meeting with icebergs, the sharp form of which forced us to presume that they had calved recently and that the place of their birth was located somewhere near.

According to the observations of the Ushakov Expedition (1930 to 1932), land icing reaches its greatest volume on Komsomlets Island--the northern island of Severnaya Zemlya. Here there are several icecaps, from which glaciers fall into Krasnaya Armiya Strait. The winds and currents carry the icebergs out of the strait into the Kara Sea and mainly into the Laptev Sea.

Icebergs are evidently seldom seen near the northwest shores of Severnaya Zemlya. At any rate, during the voyage on the *Sadko* in 1935, we did not see them. Along the southwest shores of Severnaya Zemlya, icebergs are found which have been carried mainly out from Shokalskii Strait.

In the Laptev Sea near the Krasnaya Armiya Strait, the *Sibiryaov* counted 129 icebergs standing here in the shallows and evidently carried from this strait. It is interesting to note that, according to the observation of 1932, icebergs were seldom found in the area south of the 80th parallel; only the *Erma*k in 1935, counted 30 to 35 icebergs in its course from Vil'kiskii Strait to Cape Lavrov.

Judging by all signs, in the areas adjacent to Severnaya Zemlya on the southwest and the southeast, the same "expulsion" of icebergs was observed, as was noted along the shores of Murman in 1929.

Laktionov assumes that the icebergs found in 1940 near the eastern shores of Bolshevik Island (in 1939 they were not there) were carried there from Krasnaya Armiya Strait, where they are particularly numerous and where, bounded by breaking fast ice, they can accumulate during the course of several years, and afterwards, during especially good conditions, are carried to the sea at once in great numbers in the same way as it occurs in certain glaciers of northwest Greenland.

Laktionov considers the positive anomalies of air temperatures observed in 1938 and 1939 at Cape Cheliuskin as one of the indicators of such good conditions.

As Padalka informed me, during the 27 March, 1943, flight to the north along the Rudolf Island meridian (Franz Joseph Land) between 84° and 84° 30' north, hundreds of icebergs were found, while to the west of the course, the number decreased. It is noteworthy that not a single iceberg was observed during the frequent flights of Soviet airplanes approximately along the same route when the "North Pole" station was being organized. Padalka supposes that these icebergs were carried toward Severnaya Zemlya (see Section 135).

The following fact is no less noteworthy. In October, 1943, within 3 km north-northwest from Cape Cheliuskin, a table-top iceberg 1,500 m long and 400 m wide and 10 m high above sea level was found. Fliers have told me that during summer aerial-reconnaissance flights, they had seen this unusual iceberg near the eastern shores of Severnaya Zemlya.

LITERATURE: 62, 77 96.

Section 53. Icecap Islands

Glaciers are a completely natural phenomena in many countries possessing high mountains. The snow required for the formation of glaciers gathers here in extensive snowfall (nutrition) areas, and then, changed by pressure into glacier ice, flows along one or several beds into the valleys or to the sea. As has already been mentioned, the lower the summer melting and the more solid precipitation, the more likely is the formation of powerful glaciers.

From this point of view, "icecap islands" are a great geographic puzzle. These islands, in spite of their low height above sea level and their small size, are almost completely buried under ice. From the sea, they seem like a precipitous ice wall of larger or smaller height above sea level. The "ice dome" (figure 51), resembling a turtle shell, rises evenly toward the center of the island.

Ice islands can be roughly divided into two types:

In the first type are Bruce and Evaliv Islands in the Franz Joseph Archipelago, and also Ushakov and Schmidt Islands, located between Franz Joseph Land and Severnaya Zemlya. These islands are completely buried under an ice cover.

White and Victoria Islands, located between Spitsbergen and Franz Joseph Land, belong to the second type. These islands have only small and low spits (with a developed shore ridge) which project from the precipitous ice wall.

The precipitous ice walls are particularly high on White and Victoria Islands, where in some places, in spite of the small size (especially of the latter island), it reaches 12 to 15 m. At a close scrutiny of the precipitous wall, we saw that, first, it is somewhat inclined toward the sea and, secondly, it is not unigenital but rather consists of wavy, horizontal layers of various thickness and structure. Each of these layers evidently characterizes definite climatic conditions. The less precipitation and the greater the summer warming, the smaller the layer is which is formed during the course of a given year.

The main difference on the ice cover of the icecap islands from the usual glaciers which are compressed in their flow to the shores, is, first, almost a complete lack of fissures and variations on their upper surface, and second, an even angle of the upper surface, equaling approximately 2 to 3°. These peculiarities of the icecap islands make them extremely usable for landing airplanes, as was reported by Soviet airplanes in 1937 on the ice cover of the islands of Franz Joseph Land.

The so-called katabatic winds on these islands are extremely unpleasant to airplanes. These winds are understood to be a sharp current of air down along the cold slopes. Such winds were observed along the edge of the antarctic mainland, for example. The British arctic aerial route expedition observed such winds at its base camp in Greenland while at that time there were only weak and temperate winds in Angmagsalik at a distance of several miles from the camp. Webb concludes from this that katabatic winds are not distributed very high and are rapidly expended due to the effect of friction and frictional mixing. In 1930, while we were anchored near one of the icecap islands (White Island), we also observed katabatic wind phenomena: a wind of storm force sped down along the slope, raising snow dust and tearing off wave caps near the shore; at the same time, the sea was completely calm at a distance of 2 to 3 miles from the shore.

Icecap islands are usually surrounded by a greater or lesser number of icebergs in various stages of destruction (in other words, various ages).

The most interesting fact is that these islands are located in the middle of, or not far from, islands of the same size and height, and even larger, which have no great accumulations of snow or ice.

Thus, for instance, in the northwest part of the Barents Sea, south of the typical icecap islands (White and Victoria), the King Karl Islands are located, which have no ice cover. To the

northwest of them lie Foyn, Brook, Karl, and Seven Islands and the northeast shore of North East Land, which are also devoid of ice cover. Alexander Land, which is also devoid of ice cover in its northwestern part, lies east of them.

Between Ushakov Island--an icecap island--and the northern island of Novaya Zemlya lies Vize Island, which has no ice cover. The nearest parts of Franz Joseph Land and Severnaya Zemlya archipelagos, which lie west and east of Ushakov Island, are comparatively lightly iced.

Thus, the question arises: are such islands relics of the last ice age, when the ice cover retreated?

It seems unlikely to me that Greenland, for example, is a single island and not an archipelago like Spitsbergen. When Greenland thaws, simultaneously with the general warming of the arctic, straits will melt and waste, first of all, and Greenland itself will thus begin to separate into different islands. It is natural that during this some islands will be cleared of ice the last. This assumption seems to be supported by the fact that all the known icecap islands are located either in archipelagos or in the center of extensive shallows.

The great number of icebergs found near such islands is also an oblique indication of the fact that the islands are in a state of destruction. The amount of precipitation (south of Franz Joseph Land about 500 mm and in the north about 300 mm annually) falling on these islands cannot compensate for the calving of icebergs.

True, it should be pointed out that the nutritional glaciers can occur not only because of the precipitation of atmospheric precipitates. Clouds consisting of extremely supercooled water droplets, when floating over cold elevations, form rime on these elevations. The importance of rime in glacial attrition is insufficiently studied, but it is known that in the Swedish Laplands, at an altitude of about 2,000 m, and in the Alps at an altitude of about 2,000 to 3,000 m, considerable accumulations of this type of precipitation form. In the polar lands, rime can play a considerable role; much more so on such isolated islands as icecap islands. However, it would still be insufficient to cover the expenditure of ice as a result of iceberg calving.

LITERATURE: 62, 77.

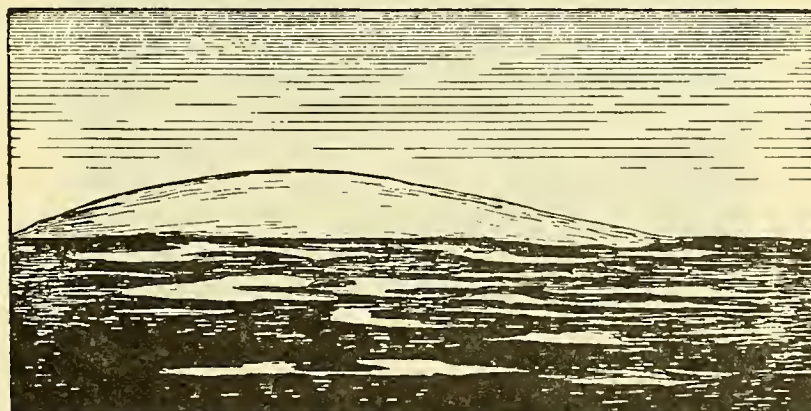

Figure 51. Ushakov Island.

Section 54. Fossil Ice

As has already been indicated, there are no glaciers of any significance to the life of the sea east of Severnaya Zemlya. This phenomenon is explained not only by the more southern location of the islands found here, but basically by the insignificant amount of precipitation. The warm and humid air masses from the Atlantic Ocean and Greenland and Barents Seas meeting the elevations of Novaya Zemlya and Severnaya Zemlya in their course are considerably dehumidified.

On the other hand, in the region east of Cape Cheliuskin, there are noteworthy deposits of "fossil ice," buried under later bottom deposits.

According to Toll, fossil ice represents remnants of the same mainland ice as the ice cover of Greenland, and consists of prismatic pieces firmly connected with each other and heaped without any order. The surface of the separate grains is covered by pits into which, like joints, fit the projections of the adjacent grains. The size of the large grains reaches 10 x 5 square mm. In this way, the structure of fossil ice bespeaks of its snow origin.

Fossil ice is found in the southern part of the northern island of Novaya Zemlya (figure 52), but it assumes a much more clear-cut form in the Laptev Sea and the Liakhovskii Islands. On B. Liakhovskii Island,* the wall of fossil ice rises 35 to 40 m above the sea. At close scrutiny, this wall consists of a sheer ice cornice, under which is located a recess braced against a terrace, formed by the soil falling from above which preserves the lower layer from melting. In the lower layer of fossil ice, the sea washes out large grottoes and caves. Shores of this type on Bolshoi Liakhovskii and Novaya Sibiryi Islands (New Siberian Islands) ends in an "ice bottom," which extends far from the shore and is covered by crushed earth material.

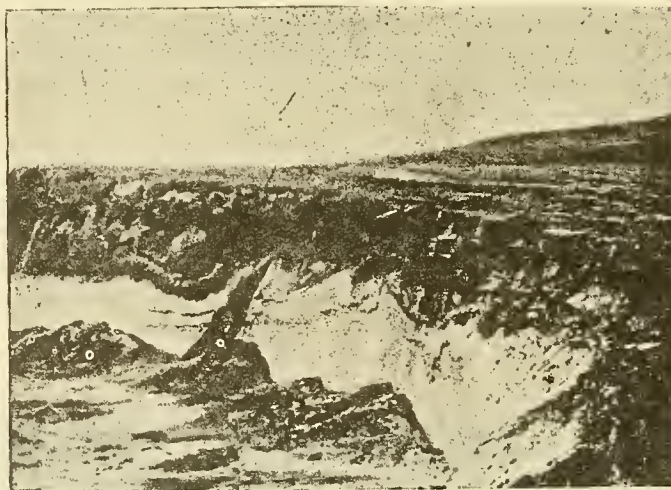

Figure 52. Fossil ice on Novaya Zemlya.

*The length of Liakhovskii Island along the parallel is about 100 km and along the meridian about 50 km. Eighty per cent of its area is occupied by fossil ice.

Fossil ice is undergoing intensive erosion at the present time, and in some places the shoreline is retreating at least half a m per year. In this relation, the Semenovskii and Vasil'evskii Islands located in the Laptev Sea north of Cape Barkhaya and west of Cape Stolbovoi, are particularly interesting.

These islands were photographed by the Anjou Expedition (1823), by the *Baigach* (1912), and *Chronometer* (1936), wherein their length (in km) has changed, as is shown in table 28.

TABLE 28. LENGTH OF SEMENOVSKII AND VASIL'EVSKII IN KW

Year of Measurement	1823	1912	1936
Semenovskii Island	15	4.6	2.0
Vasil'evskii Island	7	4.6	-

Judging by the changes in the length of Semenovskii Island and also by the fact that while its width in 1823 was .9 km, in 1936 it proved to be .6 km, it is considered that annually the length of Semenovskii Island decreases, on an average, 113 m and 4 m in width, and thus by 1954 the island should disappear, as happened in Vasil'evskii Island.*

From the examples which have been given, it can be seen that in the region of the Liakhovskii Island fossil ice determines the character of the shoreline and the offshore bottom.

LITERATURE: 62, 77, 134.

*In 1936, the *Chronometer* could not find this island. In its place, there was only a small bank. The decrease in the size and the melting of the island, consisting of fossil ice, is one of the signs of general warming in the arctic, which will be discussed in Section 160.

CHAPTER V

PHYSICAL AND CHEMICAL PROPERTIES OF SEA ICE

Section 55. Salinity

The initial forms of sea ice, as have already been mentioned, are thin needles or disks of pure ice interwoven with one another. Because of its greater density, the brine which is separate during this stage seeps through between the crystals and drops to the bottom. However, if ice formation takes place sufficiently rapidly, the spaces between the crystals are filled with new accretions of ice faster than the brine drains off, and thus a part of the brine remains disseminated in the ice in the form of more or less equally distributed salt cells. In addition, a part of the brine appears on the surface of the new ice and forms the so-called "surface brine" when ice crystals which are formed at a certain depth below the sea surface float up and fuse.

When there are temperature changes, sometimes the brine on the ice surface hardens and sometimes it again reverts to a liquid mass. In the latter case, it seeps downward slowly but steadily.

Completely analogous phenomena also occur in the salt cells which are disseminated within the ice mass. When there is a decrease in temperature, additional layers of ice also form in them, and with subsequent temperature increase, these layers again revert to the liquid stage.

It is clear that surface brine plays the main role in thin ice formation. As the ice thickness increases, the brine cells assume a greater importance the more so since (in the course of time) there is a continuous downward seepage of brine and the surface brine first enters the salt cells and then the water.

The disseminated salt solution, which is surrounded on all sides by pure ice, determines the structure of sea ice and is the primary cause for many of its physical-chemical properties.

It follows from the very processes of sea ice formation that the salinity of sea ice, by which it is understood to be the salinity of the water obtained when the ice melts, depends on the following factors:

1. The salinity of the water from which the ice was formed. Regardless of the rate of ice formation, part of the brine always manages to seep out of the ice. Therefore, the salinity of sea ice is always lower than the salinity of the water from which it was formed.

2. The rate of ice formation. The faster the ice forms, the less brine manages to seep down between the crystals. And, other conditions being equal, the rate of ice formation is greater the lower the air temperature at which the ice formation takes place.

Besides this, the ice crystals which form when it is extremely cold are very small. Because they have a large specific surface, the crystals retain a large amount of brine around themselves. Table 29 shows the corresponding observations of Malmgren.

TABLE 29. ICE SALINITY VS. AIR TEMPERATURE

Air Temperature in °C	-16	-23	-30	-40
Salinity of new ice in o/oo	5.64	8.01	8.77	10.16

The rate of ice accretion from below by means of heat conduction is generally lower than the rate of ice formation of surface ice layers which are in direct contact with the cold air. Thus, on an average, while the rate of brine seepage is not great, the ice salinity decreases from the upper surface to the lower. Malmgren's corresponding observations are given in table 30.

TABLE 30. ICE SALINITY VS. LAYER DEPTH

Depth of the layer in cm	0	13	55	95
Salinity in o/oo	6.74	5.31	4.37	3.17

3. The state of the sea during ice formation. When any of the processes that mix water are absent, ice forms in comparatively regular needle shapes; on the other hand, the ice which formed during strong mixing resembles a spongy mass saturated with sea water. This is saltier than needle ice.*

It should be kept in mind that ice formation in the open sea, even after the sea surface is covered with the solid ice cover, seldom takes place as undisturbed ice accretion from below. The initial ice structures are broken by one water movement or another, are carried from place to place, collide and leaf up on one another and fuse together. When this happens, they break up again and once more fuse. Sea water, which freezes in turn along with all the salts found in it, splashes on the ice structures which arose, thus there are precipitates, etc. All this taken together creates an extremely complex picture of salinity distribution in ice vertically and spatially and of its changes with respect to time.

4. The age of the ice. The older the ice, the lower its salinity is. This is explained by the constant seepage of the saline solution between the ice crystals.

The vertical distribution of salinity in ice, according to Weyprecht's determinations, is given below (table 31).

TABLE 31. ICE SALINITY VS. LAYER DEPTH

Depth of the layer in cm	0-5	5-14	14-19
Salinity in o/oo ,	25	13	12

*Samoilenko, in 1932, determined the salinity of ice formed from sea water with a salinity of 33.64 o/oo under conditions of rest and artificial mixing.

In spite of the small amounts of ice obtained (about 7 o/o in all, the experiments were not completed), the salinity of the ice formed under conditions of rest was 19.3 o/oo and the ice formed during mixing was about 23.8 o/oo.

The great difference in the salinities determined by Weyprecht and those determined by Malmgren is only partially explained by the fact that Weyprecht's sample was formed in more saline water and at a much lower air temperature. The main reason is that Weyprecht investigated his ice floe only 60 hours after it started to form, while Malmgren made his investigations in April on ice which had begun to form in November.

As Libin informed me, according to the investigations of the expedition, by airplane N-169, of an ice field (79°54' north, 140° east on 28 April 1941) 210 cm thick, which was one and a half years old, the layer salinity (computed with respect from the chlorine content) was as follows (table 32):

TABLE 32. THE VERTICAL DISTRIBUTION OF SALINITY IN OLD ICE

The layer from the surface of the field in cm	0	20	40	60	80	100
The salinity in o/oo	0.19	0.21	0.28	0.46	0.88	0.99

From these data, it can be seen how extensively the upper ice layers are desalted in the course of time.

5. The height of the ice above sea level. The higher the ice rises above the sea surface, the fresher it becomes, which is explained by brine seepage. Therefore, the upper part of the *ropaki* and the hummocks are almost always fresh, and, in addition, they are desalted extremely rapidly, especially during the summer.*

During recent years, many determinations of the salinity of fast ice were made at Soviet polar stations. Chernigovskii presents the following interesting data: The salinity of the upper 1.5 cm of ice which had formed on 30 December 1931, in Matochkin Shar when the temperature was 39.9° below zero, was 24.1 o/oo. The maximum salinity of young ice observed in 1934 - 35 on Franz Joseph Land was 25.02 o/oo.

The changes of salinity at all ice levels is not great during the winter at the Kara Sea stations. By the end of April, a decrease in the salinity of the upper ice layers begins. This decrease becomes especially great when there is an increase in solar radiation and when the air temperatures are positive. During this, ice desalting takes place from the ice surface down to 100 cm. However, at the 120 to 160 cm level, at the same time, the salinity also increases somewhat.

LITERATURE: 52, 62, 104, 166, 177.

Section 56. Surface Brine and Salt Cell Brine

It has already been pointed out that the salinity of sea ice is determined by surface brine and the brine in salt cells.

Surface brine is formed from frozen sea water which is left on the ice formations that have floated up to the sea surface, and from the brine which is forced out of salt cells and upward when their temperature decreases and the corresponding formation of ice layers in them.

*During the F. F. Bellingshausen Antarctic Expedition on the ships *Vostok* and *Mirnyi* (1818 to 1821), chunks of sea ice were hoisted on deck to obtain fresh water. The ice somewhat melts, sea water runs off, and the ice becomes fresh.

In turn, in the course of time, when there is a temperature decrease, surface brine partially forms crystals of pure ice (due to this, its concentration gradually increases) and it seeps downward.

The brine on the surface of the young level ice formations is one of the very characteristic phenomena. Since brine remains in a liquid state even at very low temperatures the surface of young ice is always moist. During the expedition on the *Vega*, Nordenskjöld observed surface brine containing 15.7 o/oo chlorides and which remained moist for a week when the air temperature reached -32° .

According to the observations of the expedition on the *Zarya*, the fresh ice on the polynyas which had closed in November (when the air temperature was about -30°) was covered with a moist brine during the first days of its existence, making sledging difficult. Sledging over the brine was just as difficult as over sand.

If the air temperature decreases still further, the entire surface brine freezes, turning into cryohydrates and ice--a mixture of ice crystals and salts. During this, small snow-white bushes, called "ice flowers," form on the ice surface. These flowers resemble heavy frosts on grass. According to Weyprecht, these bushes, which are sometimes 3-4 cm high, consist of thin ice needles carrying the separated salts on the ends of the crystals.

The ice flowers are very brittle formations, and are easily blown off by the wind, turning into fine salt dust. This dust is sometimes carried for great distances before it again falls on the surface of the ice along with the snow.

During each rise in temperature, the salt crystals turn into a solution and the ice surface again becomes moist.

The snow, falling on the surface of the young ice moist with brine, is saturated with brine to a slight height. During this, the upper snow layers do not undergo any changes and keep the brine from freezing during low air temperatures. Thus, surface brine is preserved for a long time, determining "ice moisture." The expedition on the *Zarya* observed that during a frost of -20° , movement over freshly fallen snow on young ice left clear, wet traces of a steel gray or gray-yellow color.

When there is a further decrease in temperature, the mixture of snow and brine solidifies and forms a thin, non-transparent, snow-white and very salty scum 2 to 3 cm thick on the ice surface, which differs sharply from the glass-like, dull and semi-transparent mass of ice.

The mass of the snow and the brine frozen together forms a rougher surface in comparison with the surface of the ice which had solidified without snow, and especially in comparison with ice formed in the fresh-water reservoirs on Arctic ice. The latter is usually as smooth as glass, and snow is not retained on it.

It has already been pointed out that the salt cells which are surrounded on all sides by pure ice (figure 53), as the ice thickness increases, assume the greatest importance for their salinity. The shape of these cells can be extremely variable.

As Bruns indicates, an understanding of sea ice structure can be given by measuring its electrical conductivity. Actually, the electrical conductivity of pure ice varies within the limits of 10^{10} to 10^{12} reciprocal ohms. But according to Bruns' calculations, the electrical conductivity

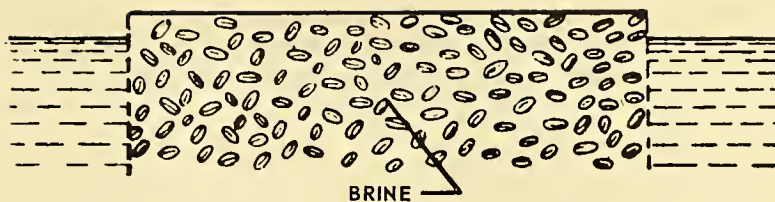

Figure 53. Scheme of brine distribution in sea ice according to Bruns.

of sea water brine at temperatures of -5° to 10° was on the order of 10^{-3} reciprocal ohms. If the brine is enclosed in isolated cells surrounded on all sides by pure ice, the electrical conductivity of sea ice should be on the same order as that of pure ice; but if the brine is found in connecting capillaries, the electrical conductivity should approach the electrical conductivity of brine. The electrical conductivity of a series of sea ice samples, measured by Bruns, proved to be on the order of 10^{-3} to 10^{-5} reciprocal ohms. Furthermore, the behavior of the temperature coefficient of electrical conductivity is satisfactorily explained by the hypothesis that the salts in sea ice participate in conductivity. According to Bruns, this shows that brine saturates like a sponge or a log.

In all probability, sea ice has both separate isolated cells containing brine and interconnected capillaries filled with brine. During the winter when the temperature of the ice falls, the first predominates, but in the summer, when the temperature of ice rises, the second predominates. Evidently, brine is distributed very unequally in ice.

During a winter spent at Cape Zhelaniia, Deriugin conducted many hundreds of salinity determinations of the ice layers which had grown under calm conditions (fast ice) and which had not undergone any movement or rafting during the course of the winter. As Deriugin and Bruns indicate, the salinity of a single level of sea ice was not constant during these tests but fluctuated within the limits of 10 o/oo (samples consisted of 300 to 500 cubic cm).

LITERATURE: 61, 62, 77, 177.

Section 57. The Amount of Brine in Sea Ice

In order to judge what amount of brine can be found in sea ice of a given salinity, let us remember that according to Ringer's and Hansen's experiments, there is a specific freezing temperature which corresponds to each salinity (7, table 5).

Table 33 which shows the salinity of sea water brine S_{τ} at temperature τ , and the change of this salinity $\frac{dS_{\tau}}{d\tau}$ during a change in temperature, was computed by me by the same method used in composing the cited table.

It follows from this table that at a temperature of -12° , for example, the salinity of the brine in the sea ice cells should be 165 o/oo. If the salinity is less, the ice will separate out of the brine, and if it is greater, the walls of the cells will melt somewhat and thus the concentration of the brine will decrease.

TABLE 33. THE SALINITY OF SEA WATER BRINE AT DIFFERENT TEMPERATURES AND THE CHANGE IN SALINITY DURING CHANGES IN TEMPERATURE

τ°	S_τ	$\frac{dS_\tau}{d\tau}$	τ°	S_τ	$\frac{dS_\tau}{d\tau}$
- 0	0	19.0	-12	165	9.5
- 1	19	18.5	-13	175	9.5
- 2	37	16.5	-14	184	9.0
- 3	54	15.0	-15	193	9.0
- 4	69	14.0	-16	202	9.0
- 5	82	13.0	-17	211	9.0
- 6	95	13.0	-18	220	8.5
- 7	108	12.5	-19	229	8.5
- 8	120	12.0	-20	237	8.0
- 9	132	11.5	-21	245	8.0
-10	144	11.0	-22	253	7.5
-11	155	10.5	-23	260	7.0

Using table 33, it is not difficult to determine what amount of brine and what amount of pure ice is contained in a given amount of sea ice. Actually, in m grams of sea ice, we have $mS_i/1000$ gm of salts, where S_i is the salinity of sea ice. If these m grams of sea ice at a certain temperature τ contain n grams of brine, and the salinity equals S_τ , we then have $nS_\tau/1000$ g of salt in n grams of brine.

Let us assume that the total amount of salts in sea ice does not change when the concentration of the brine changes in connection with a change in temperature. Obviously, then, we will always have the equation

$$\frac{mS_i}{1000} = \frac{nS_\tau}{1000}, \quad (1)$$

whence

$$n = \frac{mS_i}{S_\tau}. \quad (2)$$

It follows from this formula that 1 g of sea ice of S_i salinity at a temperature τ , contains S_i/S_τ g of brine and $(1 - S_i/S_\tau)$ g of pure ice.

The results of my computations according to table 33 and formula (2) are presented in table 34.

As can be seen from the table, when the temperatures and salinities of sea ice are high, the amount of brine is very great. It is clear that this cannot help having an effect on all the properties of sea ice.

TABLE 34. THE AMOUNT OF BRINE IN GRAMS IN 1 KG OF SEA ICE HAVING DIFFERENT SALINITIES AND TEMPERATURE

S ‰ \ -°	-2	-4	-6	-8	-10	-15	-20	-23
2	54	29	21	17	14	10	8	8
4	108	58	42	33	27	21	17	15
6	162	87	63	50	42	31	25	23
8	216	116	84	67	56	42	34	31
10	270	145	105	83	69	52	42	38
15	405	217	158	125	104	78	63	58

In using formula (2), and table 34, it should be clearly kept in mind that the salinity of the brine S_T is determined only by the temperature of the ice, and that the salinity of the ice S_i depends on the amount of brine which is determined by the number and size of its cells.

LITERATURE: 52, 62, 104.

Section 58. Brine Migration

As we have seen, sea ice consists of pure crystals, surrounding more or less equally distributed cells filled with brine. Since the ratio of the main elements in sea water of various salinities is the same, the concentration of the brine in these cells should be the same at each given temperature, depending neither on the salinity of the water from which the ice was formed nor on the general salinity of the ice.

Actually, we can consider each brine cell as being a closed vessel in which the processes follow eutectic laws during a change in temperature. Thus, with each decrease in the temperature of ice, pure ice separates from the brine in the cells and salts are precipitated in the sequence established by Ringer's experiments (Section 7). With each rise in temperature, the ice which separated out of the brine during a drop in temperatures melts, and the precipitated salts dissolve in the brine. Other conditions being equal, the salinity of the water from which the ice was formed affects only the volume of the brine included in the brine cells.

However, this scheme of phenomena is considerably complicated by the fact that separation of pure ice within the cells completely filled with brine causes a certain increase in the volume of the cell. Actually, fresh water increases its volume by 9 per cent on freezing. Thus, when the temperature drops, and additional ice is separated from the brine, pressure is created on the side walls of the cells which deforms the latter and squeezes brine out of the cells. On the other hand, with each increase in temperature, empty spaces are formed in the cells which draw brine into themselves from adjacent, mainly higher cells and also draw air from the atmosphere. Therefore, processes determining many of the properties of sea ice occur constantly in sea ice due to the effect of temperature changes.

In particular, the subsequent formation of pressures within the cells, which squeezes the brine out of them and formation of the empty spaces which draw out brine from the adjacent cells, (their temperatures are related to the changes in the temperature of the ice) assist a gradual seepage of the brine downward and a desalinification of the ice. As we have seen, this explains the decrease in the salinity of the ice as it grows older.

The seepage of brine through ice in the course of time is caused by many reasons. In this connection, the force of gravity works first of all (inasmuch as the density of brine is greater than the density of the ice and the water under the ice). The force of gravity in the narrow capillaries is somewhat balanced by the rise of the level in them due to surface tension. However, inasmuch as in the course of time the upper parts of the ice rise constantly higher above sea level as long as the ice continues to grow, and inasmuch as the size of the capillaries also increase with the course of time, finally the force of gravity, especially in the upper ice layers, begins to overcome the molecular forces.

Whitman focused attention on the displacement of the salt droplets encased in ice which causes the vertical gradient of temperature in ice by its presence.

As we have seen, salt cell brine concentration is determined by the temperature of the ice layer in which a given cell is located. In the presence of a vertical temperature gradient, the brine concentration will be higher on the warmer side of the cell and it will be lower than the concentrations necessary for conditions of equilibrium on the colder side. Hence the ice will melt on the warmer side of the cell and thus lower the brine concentration, while new ice will be formed on the colder side, and thus it will raise the brine concentration. As a result of these processes, a drop of brine will be displaced from the colder ice layers to the warmer ones during which the concentration of the brine in the drop will decrease simultaneously.

Whitman confirmed his reasoning by experiments with 3.31 o/oo concentrations of table salt solutions, artificially frozen in special cylindrical test tubes. These test tubes were maintained for some time at constant temperatures at both their upper and lower ends and then the brine concentration was determined. The results, as an average of five experiments, are given in table 35.

TABLE 35. THE CHANGE IN TABLE SALT CONTENT WITH A CHANGE IN TEMPERATURE GRADIENT

The length of the experiment in hours	5.5	6.5
The temperature in the upper part of the test tube in °C	-2	-25
The temperature in the lower part of the test tube in °C	-20	-4
Table salt content in o/oo:		
in the upper layer	3.88	1.86
in the 2nd layer	3.19	1.92
in the 3rd layer	3.19	2.69
in the 4th layer	3.08	2.77
in the bottom layer	2.92	2.51

It is seen from the table how rapidly the displacement of the brine occurs.

Very low temperatures at the upper ice surface, and close to the temperature of freezing at the lower ice surface are observed in sea ice during the winter. Therefore, the phenomenon noted by Whitman should cause energetic drainage of the brine downward during the winter. During the summer, the coldest temperatures are found in the middle parts of the ice and the salt drops should therefore move up and down (figure 54). But during the summer, the capillaries and cells containing the brine are constantly increased in size at the ice surface, the ice becomes very porous, and the force of gravity begins to play a leading role in brine seepage. Due to this, the ice becomes only slightly salty.

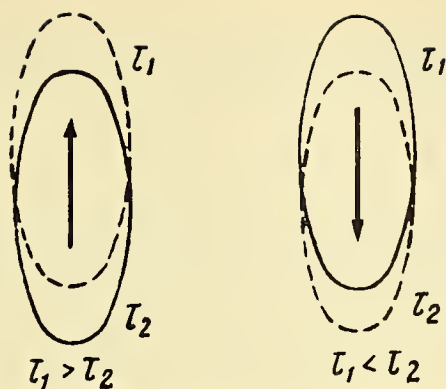

Figure 54. Scheme of brine cell migration in sea ice during the summer (left) and the winter (right).

Malmgren gives an observation made by him during the spring of 1924 to prove the ice porosity and the brine seepage through it. A hole about one meter thick was dug in an ice field on which there was no water. On the following day, the hole proved to be filled with brine of 51.0 o/oo salinity, while the salinity of the surrounding sea water was 28 o/oo and the salinity of the ice itself was 3 o/oo, which indicated that the brine had seeped from the surrounding ice. Savel'ev observed a brine salinity of 72.75 o/oo with a water salinity of 33.75 o/oo and an ice salinity of 3.75 o/oo (at the 30 to 40 cm level) on Uedineniya Island in 1939.

Captain Sverdrup's observations in the regions north of Spitsbergen are also extremely interesting. He indicates that on 18 April 1895, at an air temperature of -23° , he saw a drop in the shadow under a projecting angle of a large chunk of ice. This drop was as salty as the most concentrated brine. Obviously, this drop was the result of brine seepage through the ice capillaries.

Aside from a desalinification of the upper ice layers (of the hummocks rising above the level surface of ice) the descending movement of brine which is particularly intense during summer causes an irregular vertical distribution of salinity. During this, the salinity reaches its maximum concentrations in the middle parts of the ice.

Malmgren summarized his numerous observations of the vertical distribution of ice salinity during the course of a year in a chart (figure 55) warning, however, that this chart gives only a

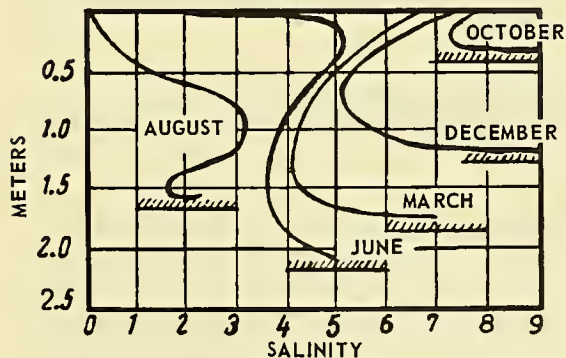

Figure 55. Chart of the changes in thickness and salinity of sea ice over a year.

qualitative picture of the changes in salinity and ice thickness and that it should not be interpreted as average amounts for different months. It is clear from figure 55 what gradual changes in thickness and salinity the ice undergoes up to the moment which characterizes these elements in August of the following year. When analyzing the curves obtained in the chart, Malmgren came to the following conclusions:

New ice has the greater salinity on its surface the more rapidly the ice formation took place; toward the bottom, the salinity decreases rapidly at first, and then more slowly; near the lower ice surface, the salinity again increases, but, in ratio to the growth of new ice layers from below, the salinity at a given point decreases to normal. During the winter, the ice salinity decreases gradually at all levels; during the summer, as a result of melting, the salinity of the surface layers begins to decrease rapidly and these layers become almost fresh. A decrease in the salinity of the lower layers occurs simultaneously.

One more conclusion should be added to these: during the seepage of cold and concentrated brine downward along the capillaries and the gradual rise of the temperature of the brine during this, there is also a simultaneous decrease in the salinity of this brine due to the melting of the capillary walls along which the brine flows. The latter condition, which increases the diameter of the capillaries, at the same time assists in the destruction of the already weak lower parts of the ice.

LITERATURE: 62, 104, 139, 178.

Section 59. Composition of the Salts

As we have seen, any change in temperature changes the amount and concentration of the brine in the salt cells of sea ice.

But these same processes also change the composition of the salts in sea ice. Actually, it is known from Ringer's experiments that only a slight decrease in the temperature of sea water below the freezing point is necessary to start precipitation of calcium carbonate from it, and when the temperature of the brine is decreased below -8.2° , sodium sulphate begins to precipitate out. It is natural that at corresponding temperatures these salts will precipitate on the walls of the cells. Inasmuch as the chlorides in sea water begin to precipitate only at temperatures lower than -23° , these salts are preserved for a very long time in the brine of the cells and gradually seep downward, decreasing the salinity of the ice in the course of time.

Thus, we should observe a deficiency of the carbonates and sulphates, which had deposited on the walls of the cells, in the melt water of sea ice, and a deficiency of the chlorides which had seeped into the water along with the brine.

Investigations of the ice in the Barents Sea, conducted by Laktionov in 1929, have led to the results (average) shown in table 36.

Table 37 shows (according to some of Laktionov's analyses) the vertical distribution of the separate components in sea ice.

TABLE 36. THE CHEMICAL CHARACTERISTICS OF SEA ICE AS A FUNCTION OF ITS AGE

The Age of the Ice	Cl o/oo	SO ₃ :Cl	A:Cl	Number of Observations
Many years old . .	0.006	0.4067	105.633	6
One year old	0.404	0.1197	1.723	19
Spring	0.731	0.1187	0.980	4

Cl o/oo is the chlorine content; SO₃:Cl is the ratio of the sulphate ion content to the chlorine content; A:Cl is the ratio of the alkaline content to the chlorine content.

TABLE 37. THE VERTICAL DISTRIBUTION OF THE SEPARATE COMPONENTS IN SEA ICE

Depth of the sample from the surface in cm	0-5	20-35	45-50	65-70	80-85
SO ₃ :Cl	0.1067	0.1134	0.1176	0.1185	0.1198
A:Cl	1.2597	1.2648	1.0370	1.0774	0.9331

From the given data, and also from other investigations we can see the following:

1. The ratio SO₃:Cl, as a rule, is considerably higher in sea ice than the same ratio in normal sea water (0.1159). In individual instances, this ratio can also be considerably higher. Thus, Hamberg notes a case when the SO₃:Cl ratio attained a value of 0.574, i. e., it was five times greater than normal.

2. The SO₃:Cl ratio increases as a rule with the age of ice. (This is explained by the fact that, as had already been pointed out, the chlorides precipitate from the solution with greater difficulty, and because of this, they seep out of the cells along with the brine more rapidly than the sulphates which are partially deposited upon the walls of the cells (in the form of solid salts).

3. The SO₃:Cl ratio is generally lower in the upper layers than in the lower (which is explained by the fact that with each rise in the temperature of the ice above -8.2°, the sulphates again dissolve in the brine and begin to seep into the lower layers of the ice, and then into the water).*

As for the ratio of alkaline to chlorine content, the first research into this question evidently belongs to Laktionov, who, aside from observations of natural ice, also conducted the same kind of investigations along with Kirilenko, under laboratory conditions.

*Sverdrup's and Malmgren's conclusions from the results of the expedition on the *Haud* are in some opposition to these conclusions. These conclusions are obtained from the comparisons of chlorine content, determined by ordinary titration of water obtained by melting sea ice, with the chlorine content computed according to specific gravity (determined by a hydrometer, fully immersed). Nansen also notes that according to his observations, the ratio of the chlorides to the sulphate in under-ice water is lower than normal. Further research is necessary to solve this contradiction.

It follows from the observations that:

4. The carbonate content in sea ice is almost constant, increasing only slightly with the depth of the ice layer which is explained by the fact that the carbonates precipitate out of sea water and settle upon the cell walls almost simultaneously with the beginning of ice formation.

5. Inasmuch as the chloride content in sea ice changes very much (decreasing along with the age and condition of the ice), the ratio A:Cl can fluctuate within considerable limits, attaining its maximum in many-year old ice.

Thus, direct measurements of the salt composition of sea ice support the selective character of the ice formation process established by Ringer, and the correctness of Petterson's and Ringer's conclusions that during ice formation, a certain excess of chlorides should be observed in the sea water from which the ice had separated, and, conversely, water in which the ice had melted should show an excess of sulphates and above all, carbonates.

Therefore, waters of arctic and antarctic origin (i. e., where intensive ice formation occurs) obviously should be outstanding due to a lower alkaline coefficient.

Determinations of the alkalinity of the surface waters in the northern part of the Kara Sea, conducted by Chigirin during the expedition on the *Sadko* in 1935 have shown that the alkaline coefficient decreases with the increase in the salinity, as can be seen from table 38.

TABLE 38. THE ALKALINE COEFFICIENT IN THE WATERS OF THE NORTHERN PART OF THE KARA SEA

S o/oo	29-30	30-31	31-32	32-33
(A:S) 10 ⁴ . . .	755	694	691	688

LITERATURE: 62, 95, 104, 166.

Section 60. Specific Heat

Otto Petterson was the first to direct attention to the fact that the heat of fusion and thermal expansion of sea ice discloses anomalies in comparison with the same properties of fresh water ice.

Thus, in studying the heat of fusion of artificially prepared sea ice within the temperature of limits of -6° to -9°, Petterson obtained the heat of fusion of 60.5 g-cal, for ice of 20 o/oo, and the heat of fusion of 49.5 g-cal for ice of 40 o/oo salinity. In Petterson's experiments, very salty ice continued to increase in volume during a decrease in temperature.

In analyzing Petterson's experiments, Krummel arrived at the conclusion that the abnormal thermal expansion of sea ice should be ascribed to the brine contained in the ice. If the temperature of sea ice is lowered, pure ice would separate from the brine contained in the cells, which is related to the great increase in volume. This increase in volume in the presence of great amounts of brine exceeds the natural increase in volume during a decrease in temperature.

Malmgren confirmed the correctness of Krummel's hypothesis by his investigations during the expedition on the *Maud* (1922 to 1924). Additionally, he was the first to point out that the high specific heat of sea ice near the freezing temperature is created by the fact that at temperatures

somewhat lower than the temperature of freezing, even a slight change in temperature causes considerable changes in the amount of pure ice per unit of volume.

In his investigations, Malmgren supposed that sea ice consists of pure ice into which are embedded more or less equally isolated cells of brine. The brine in these cells follows the eutectic law: a certain amount of ice melts from the walls of the salt cells with each rise in the brine temperature; conversely, with each decrease in temperature, a certain additional amount of ice precipitates on the walls of the cells.

Further, Malmgren indicated that with each change of ice temperature, a number of processes occur which affect the properties of sea ice in one way or another.

Thus, with a decrease in temperature:

1. Volume of ice increases and its temperature falls;
2. A certain additional amount of ice separates from the brine cell which is accompanied by a great release of heat and a great increase in the volume;
3. The temperature of the brine decreases and its volume changes;
4. All sorts of thermo-chemical processes occur in the brine itself which are related to the change in the volume and temperature.

In deriving his theoretical formulas, Malmgren assumed that the effect of the thermic and volumetric changes in the brine of sea ice (inasmuch as there is little brine in ice), is so insignificant in comparison with the effect of the same changes in pure ice, that it could be neglected.

Proceeding from the same suppositions as Malmgren, let us derive the necessary formulas by a method which in my opinion, is simpler.

Specific heat is based on 1 g of matter and 1° of temperature. Remembering that 1 g of sea ice has $(1 - \frac{S_i}{S_\tau})$ grams of pure ice and $\frac{S_i}{S_\tau}$ grams of brine and neglecting the effect of thermal chemical processes, we may write:

$$c_\tau = c_i \left(1 - \frac{S_i}{S_\tau} \right) + c_s \frac{S_i}{S_\tau} + \lambda_\tau \frac{d}{d\tau} \left(1 - \frac{S_i}{S_\tau} \right), \quad (1)$$

where c_τ is the specific heat of sea ice,

c_i is the specific heat of pure ice,

c_s is the specific heat of brine,

S_i is the salinity of sea ice,

S_τ is the salinity of brine at a temperature τ ,

λ_τ is the heat of fusion at a temperature τ (the meaning of this amount will be explained below),

$\frac{d(1 - S_i/S_\tau)}{d\tau} = S_i/S_\tau^2 \times dS_\tau/d\tau$ is the change in the amount of pure ice in 1 g of sea ice during a change of 1° in its temperature.

Inasmuch as the amount of brine in sea ice is not great, then from formula (1) we obtained approximately

$$c_{\tau} = c_i + \lambda_{\tau} \frac{S_i}{S_{\tau}^2} \frac{dS_{\tau}}{d\tau}. \quad (2)$$

It follows from formula (2) that the specific heat of sea ice consists of the specific heat of pure ice and corrections for salinity. This correction is greater the greater the salinity of sea ice and the lower the salinity of the brine. The salinity of the brine is less the higher the temperature of sea ice.

Formula (2) includes: C_i — the specific heat of pure ice and λ_{τ} — the heat of fusion of pure ice at a temperature of sea ice equal to τ .

Dickens and Osborne gave the following formula for the specific heat of pure ice at temperatures of -2° to -40° :

$$c_i = 0.5057 + 0.001863 t. \quad (3)$$

They also showed that between 0° and -2° the specific heat of pure ice increases very much and at -0.06° , it reach 1.73. This indicates that some internal molecular changes occur in pure ice near the freezing temperature. Phenomena of the same type should, of course, also occur in sea ice.

As for the melting temperature λ_{τ} included in formula (2), it is necessary to turn attention to the fact that formation and melting of additional pure ice occurs in the brine of the cells at the temperature of the sea ice itself, i. e., at very low temperatures. Because of this, we need to use Pearson's formula here which was checked by Petterson, namely:

$$\lambda_{\tau} = 80 + 0.5 \tau, \quad (4)$$

where 80 is the heat of fusion of pure ice at 0° ,

τ is the temperature of sea ice,

0.5 is the difference in the specific heat of water and ice.

This formula is based on the consideration that in order to form ice, the temperature of the brine should at first be mentally raised to the freezing temperature of pure water, then the melting point of pure ice should be subtracted from it, and then the temperature of the formed ice should be lowered to the initial temperature of the brine.

The other values entering formula (2), namely: salinity of the brine S_{τ} at a given temperature of the brine τ , and the changes in the salinity with a change in the temperature $dS_{\tau}/d\tau$ are obtained from table 33.

Table 39 gives the specific heat of sea ice at different temperatures, and salinity computed by Malmgren.

As it follows from this table, the specific heat of sea ice at high temperatures and high salinities of the ice can reach large values. Thus, for instance, when $\tau = -2^{\circ}$ and $S_{\tau} = 15$ o/oo the specific heat of sea ice equals 16.01 g-cal. Such high specific heat is explained by the fact that with a 1° change in temperature, formation or melting of considerable amounts of pure ice with the accompanying release and absorption of the heat of fusion, occurs in the salt cells.

TABLE 39. SPECIFIC HEAT OF SEA ICE IN G-CAL* AT DIFFERENT TEMPERATURES AND SALINITIES

$S_o/oo \backslash \tau^\circ$	-2	-4	-6	-8	-10	-12	-14	-16	-18	-20	-22
0 . . .	0.48	0.48	0.48	0.48	0.48	0.47	0.47	0.47	0.47	0.46	0.46
2 . . .	2.57	1.00	0.73	0.63	0.57	0.55	0.54	0.53	0.53	0.52	0.52
4 . . .	4.63	1.50	0.96	0.76	0.64	0.59	0.57	0.57	0.56	0.55	0.54
6 . . .	6.70	1.99	1.20	0.88	0.71	0.64	0.61	0.60	0.58	0.57	0.56
8 . . .	8.76	2.49	1.43	1.01	0.78	0.68	0.64	0.64	0.61	0.60	0.58
10 . . .	10.83	2.99	1.66	1.14	0.85	0.73	0.68	0.67	0.64	0.62	0.60
15 . . .	16.01	4.24	2.24	1.46	1.02	0.85	0.77	0.76	0.71	0.68	0.65

Thus, the concepts of specific heat and heat of fusion are inseparable from each other for sea ice.

LITERATURE: 13, 52, 62, 73, 104, 158, 166.

Section 61. Heat Expended in Melting

Heat of fusion is understood to mean the amount of heat which must be transferred (on the conditions of stable temperature) to a unit mass of matter in order to change it from a solid state to a liquid.

However, as Malmgren first pointed out, in dealing with the sea ice, in the cells of which there is a constant and gradual melting of pure ice during a rise of temperature, it is possible to speak not of the heat of fusion, but rather of the number of gram calories necessary to melt 1 g of sea ice having an initial temperature τ .

Let S_i be the salinity of sea ice, and τ_s be the freezing temperature of sea water of S salinity. The amount of heat $U_{\tau S}$ necessary to melt one gram of sea ice, whose initial temperature is τ , will be the sum of:

1. The heat necessary to melt the pure ice contained in one gram of sea ice, i.e.,

$$80 \left(1 - \frac{S_i}{S_\tau} \right) \text{g-cal}$$

where 80 is the heat of fusion of pure ice, $(1 - S_i/S_\tau)$ is the number of grams of pure ice contained in 1 g of sea ice of S salinity at temperature τ .

2. The heat necessary to raise the temperature of pure ice** from τ to τ_s that is approximately

$$0.5(\tau_s - \tau) \text{g-cal}$$

where 0.5 is the specific heat of pure ice.

*The heat of fusion of pure ice equals 79.67 g-cal but it is sufficient to use a round number in approximate computations.

**One may neglect the amount of heat necessary to change the temperature of the brine.

$$U_{\tau_s} = 80 \left(1 - \frac{S_i}{S_{\tau}} \right) + 0.5 (\tau_s - \tau). \quad (1)$$

By formula (1) Malgrem computed the table for the number of g-cal necessary to melt 1 g of sea ice having different salinities and having temperatures equaling -1° and -2° at the starting moment. These computations are continued for the lower temperatures (table 40).

TABLE 40. THE NUMBER OF G-CAL NECESSARY TO MELT 1 G OF SEA ICE

S o/oo	τ°						
	0	2	4	6	8	10	15
- 1	80	72	64	55	47	38	17
- 2	81	77	72	68	64	59	47
- 5	83	80	78	77	74	72	67
-10	85	84	84	81	80	79	76
-20	90	89	89	88	87	86	84

This table shows the basic difference between fresh and sea ice. Fresh ice demands a great number of calories at the exact moment of its formation or melting, and a low number of calories for changing its temperatures. Sea ice, on the contrary, demands a great number of calories for changing its temperature and a low number at the exact moment of its melting. Thus, for instance, 80 g-cal are needed to melt one g of pure ice, and 2.5 g-cal to raise its temperature from -5° to -2° . In order to melt one g of sea ice of 15 o/oo salinity, only 17 g-cal are needed, but in order to raise the temperature of this ice from -5° to -2° , it is necessary to expend 20 g-cal. This is explained by the fact that fresh ice is formed at a constant freezing temperature, and with further variations only its temperature changes. The process of forming sea ice continues steadily as long as its temperature decreases. With changes in its temperature, constant melting alternates with ice formation and vice versa.

With the start of the intensified rise in spring temperature, the internal melting of sea ice becomes constantly more intensive and at the moment of its decomposition, sea ice represents a, so to say, mass destroyed from within ("rotten ice"), still preserving at times its external form but easily destroyed by a slight warming or mechanical action. This explains the occasional extremely rapid disappearance of great masses of ice in the southern parts of the arctic basin during the course of a polar summer, which creates the impression of "melting before one's eyes."

LITERATURE: 52, 62, 73, 104.

Section 62. The Coexistence of Water and Ice

In investigating the question of equilibrium of the ice-water system, let us make the following simplifying assumptions:

1. The masses of water and ice participating in the process are limited and protected from the action of the atmosphere so that all changes that occur in the water or in the ice are conditioned exclusively by their interactions.

2. The water mass mixes constantly, so that it is always homogeneous in temperature and salinity.

With such assumptions, the following characteristic instances may occur:

1. The ice placed in water melts either partially or wholly due to the heat reserve in the water, as a result of which, the water becomes cool, and, if the salinity of the ice is lower than the salinity of the water, it becomes fresh.

2. Ice placed in water increases the freezing due to the supply of cold in the ice itself, and the salinity of sea water is somewhat raised due to the formation of an additional mass of ice (again under the usual condition that the salinity of the ice is lower than the salinity of the water).

3. Ice placed in water neither melts nor freezes.

Thus, when water and ice come in contact, thermic and saline interactions generally occur, for determining which, (assuming the existence of both water and ice), I use the following formulas:

For thermic interactions:

$$Mc_w(t_w - \tau) + (N - n)c_i(t_i - \tau) + nc_i(t_i - 0^\circ) + nc_w(0^\circ - \tau) = \lambda n, \quad (1)$$

where M is the initial mass of water,

N is the initial mass of ice,

n is the mass of ice which had melted or accreted upon contact with the water,

c_w is the specific heat of the water,

c_i is the specific heat capacity of the ice,

t_w is the initial temperature of the water,

t_i is the initial temperature of the ice,

τ is the final temperature of the water equal to its freezing point,

λ is the heat of fusion.

By means of a corresponding transpositions obtained from formula (1):

$$n = \frac{Mc_w(t_w - \tau) + Nc_i(t_i - \tau)}{\lambda + (c_w - c_i)\tau}. \quad (2)$$

It follows from formula (2) that when $n = 0$, i. e., on the condition that the ice placed in water neither melts nor freezes, the following equation should hold.

$$N_0 = -M_0 \frac{c_w}{c_i} \frac{t_w - \tau}{t_i - \tau}. \quad (3)$$

It is clear that if the mass of ice placed in a given mass of water comes out greater according to formula (3), then, as a result of interaction of water and ice, accretion occurs, but if less, melting of ice occurs.

If we examine the extreme possible case in the coexistence of water and ice, namely, that the ice placed in water melts completely, i. e., $N = n$, then we obtain from formula (2)

$$N = Mc_w \frac{t_w - \tau}{\lambda + c_w \tau - c_i t_i}. \quad (4)$$

It is natural that the limit of the mass of ice which can be melted by a given mass of water is governed by the condition that by the end of the process the temperature of the water decreases to the freezing temperature and therefore the entire reserve of heat found in the water is used up.

The following formulas serve in saline interactions:

$$MS_w + nS_i = (M + n)S, \quad (5)$$

where S_w is the initial salinity of sea water,

S_i is the salinity of the ice,

S is the final salinity of the water.

From formula (5) we obtained

$$n = M \frac{S_w - S}{S - S_i}. \quad (6)$$

It is clear that if the final salinity of the water is lower than the initial salinity (under the condition that the salinity of the ice is less than the water), then melting occurs, and if it is greater--freezing occurs.

There is some interest in treating more completely the factors which condition the coexistence of water and ice without changes in their masses. It is not difficult to see that coexistence can occur only under the following conditions:

1. The temperature of the water and ice are the same and equal to the freezing temperature of the water in which the ice floats. From this condition it follows that

$$t_w = t_i = \tau.$$

But the freezing temperature and the salinity of sea water, as we have seen in Section 5, are related by the formula

$$\tau = -0.054 S_w.$$

Inasmuch as in the investigated case there are no reasons which cause melting or freezing, there are also no reasons for changing the initial salinity of sea water, i. e., we should have the equation

$$S_w = S_\tau.$$

The investigated case is an example of thermic (due to the equality of temperature, there is no heat exchange between water and ice) and dynamic (no change in the mass of the water and ice) equilibrium.

2. The temperatures of water and ice differ from each other, but the temperature and mass of the water and ice are in such a ratio that the reserve of "heat" in the water is exactly equal to the reserve of "cold" in the ice. Such an interrelation is characterized by formula (3).

Inasmuch as in the investigated case there is no melting or freezing, then, as in the preceding case, we have

$$S_w = S_i .$$

Thus, in the second case, we have dynamic equilibrium (there is neither melting nor freezing), but there is no thermal equilibrium. Heat exchange between water and ice continues until the temperature of the water and the ice become the same and become equal to the temperature of freezing.

The discussions which have been given and the formulas, permit the solution of many questions connected with the interaction of water and ice. I shall give several examples.

Let us assume that $c_w = 1.0$, $c_i = 0.5$ and $\lambda = 80$ g-cal. With such assumptions, we find that one (metric) ton of sea water, the salinity of which equals 35.00 o/oo and the temperature 30° at the initial moment, melts 399 kilograms of fresh ice, the temperature of which equals 0° , in which case the sea water is diluted to 25.02 o/oo by mixing with the melted water and is cooled to the temperature of freezing, i. e., to -1.35° .

With the same assumptions, one ton of sea water, the salinity of which equals 35.00 o/oo at the initial moment but the temperature of which equals 0° , melts 23 kg of fresh ice, the temperature of which is also 0° , in which case the salinity of the water decreases to 34.21 o/oo by mixing with the melted water, and the temperature decreases to -1.35° .

On the same assumptions, during interaction of one ton of sea water ($S_w = 35.00$ o/oo, $t_w = 0^\circ$) and one ton of ice ($S_i = 0$ o/oo, $t_i = 0^\circ$), 35 kg of ice are melted, in which case the salinity of the water decreases to 33.81 o/oo and the temperature of the water and the remaining 965 kg of ice decreases to -1.83° .

It should be pointed that the first example characterizes the condition which occurs when an iceberg is carried into the warm and salty waters of the Gulf Stream; the second and third examples are conditions existing at high polar latitudes. The difference in the end results of the first and second examples is explained by the difference in the initial temperatures of the water. In the second and third examples, with equal initial temperatures and salinities of water and ice, the final temperatures and salinities are determined exclusively by the ratio of the masses of water and ice which come in contact. The final temperatures are extremely close to each other and actually differ within the limits of exactness of the conducted observations whereas the salinity differs very much. The fact that the surface arctic waters (see Section 146) are outstanding in their very large vertical gradients of salinity and very small vertical gradients of temperature (the temperature throughout is very close to the freezing temperature) is partially explained by this. This same fact is convincing proof that the surface arctic waters are finally formed not as a result of vertical winter circulation and not as a result of mixing with other waters, but as a result of melting. Actually, when there is vertical winter circulation, we always find complete homogeneity of the upper layers both in temperature (equal to the temperature of freezing under ice formation condition) and in salinity. When water and ice coexist, we always meet with temperatures close to the temperatures of freezing, but the salinities of the upper layers can differ sharply.

Let us imagine a cylindrical iceberg consisting of horizontal layers, and having a vertical axis; the salinity of the layers is the same and the temperature decreases with height. After the

conclusion of the water and ice interaction, the underwater part of the iceberg assumes the form of a truncated cone with its base at the bottom (this phenomenon partially explains the creation of *podsovs** and a vertical gradient of salinity is created in the water (due to the action of temperature differences). Let us now assume that the underwater part of the hummock is a cone with its point down and that the hummock is floating in water of uniform temperature and salinity. When the process is concluded, the conical form of the underwater part of the hummock will be preserved, the temperature will decrease to the temperature of freezing, and the salinity will again prove to be lower in the upper layers than in the deeper ones (due to the action of the masses).

In the examples investigated above, we have assumed that the temperature of the ice is 0°. Actually, even during the summer, it is somewhat lower than the freezing temperature of the water in which the ice is floating. As a result of this, the underwater part of the ice melts chiefly because of the heat accumulated by the water during the summer in a given region or from that accumulated in more southerly regions. Inasmuch as, according to formula (6) (other conditions being equal) the mass of the melted ice is directly proportional to the mass of the water in contact with the ice, it is natural that the melting of the part of the ice which projects beneath the level surface of the ice field occurs with particular intensity if the water and the ice are in motion. This happens, for instance, when there are sea currents under fast ice, or during wind drift of ice. Such erosion of the lower projecting parts of the ice has been noted by many observers and has a decisive importance in isostatic phenomena (see Section 103), particularly in destroying hummocks and creating level fields (Section 49). This same phenomenon explains the rapid waste of separate floating ice floes during the summer in high seas.

LITERATURE: 77.

Section 63. Thermal Expansion

For pure ice the coefficient of volumetric thermal expansion has an average value of many measurements

$$\beta = \frac{dv}{vdt} = 0.000165,$$

and therefore, the linear coefficient of expansion is

$$\alpha = \frac{dl}{ldt} = \frac{\beta}{3} = 0.000055,$$

where v is the volume, l is the length, t is the temperature.

In deriving the formula for the thermal expansion of sea ice with the same assumptions as when deriving the formula for the specific heat of sea ice, Malmgren considered that the coefficient for the expansion of sea ice is equal to the coefficient of expansion of pure ice plus the correction for change in volume depending upon the formation or melting of an additional layer of ice in connection with a change in temperature.

Thus, in accordance with Malmgren's assumptions we obtain

$$u_{\tau} = \frac{\beta}{0.92} - \gamma \frac{\partial}{\partial \tau} \left(1 - \frac{S_i}{S_{\tau}} \right), \quad (1)$$

where u_{τ} is the coefficient of thermal expansion related to one gram and one degree.

**Podsovs* - an underwater projection of ice.

0.92 is the mass in grams of 1 cubic cm of pure ice (density),

γ is the increase in volume when 1 g of pure water freezes,

$\partial (1 - S_i/S_\tau) / \partial \tau$ is the additional amount of pure ice separated from 1 g of sea ice when it is cooled by 1° .

But

$$\frac{\partial}{\partial \tau} \left(1 - \frac{S_i}{S_\tau} \right) = \frac{S_i}{S_\tau^2} \frac{\partial S_\tau}{\partial \tau}.$$

Assuming that $\beta: 0.92 = 0.000169$ and $\gamma = 0.091$, Malmgren concludes

$$u_\tau = 0.000169 - 0.091 \frac{S_i}{S_\tau^2} \frac{\partial S_\tau}{\partial \tau}, \quad (2)$$

where the coefficient of expansion is not related to the unit of volume as is ordinarily done but to the unit of mass.

The first member of the right-hand side of formula (2) is the coefficient of expansion of pure ice, the second member is the correction for salinity.

Table 41 is computed according to Malmgren's formula (2).

TABLE 41. THE COEFFICIENT OF VOLUMETRIC EXPANSION OF 1 G OF SEA ICE OF VARIOUS TEMPERATURES AND SALINITIES. THE COEFFICIENT IS MULTIPLIED BY 10^4

$\tau^\circ \backslash S \text{ o/oo}$	-2	-4	-6	-8	-10	-12	-14	-16	-18	-20	-22
2 . . .	- 22.10	- 4.12	- 1.06	+0.16	+0.83	+1.13	+1.23	+1.27	+1.33	+1.38	+1.44
4 . . .	- 45.89	- 9.92	- 3.81	-1.37	-0.02	+0.56	+0.78	+0.85	+0.96	+1.07	+1.18
6 . . .	- 69.67	-15.73	- 6.55	-2.90	-0.88	0.00	+0.33	+0.43	+0.60	+0.76	+0.93
8 . . .	- 93.46	-21.53	- 9.30	-4.43	-1.73	-0.57	-0.13	+0.02	+0.23	+0.45	+0.67
10 . . .	-117.25	-27.34	-12.05	-5.95	-2.59	-1.13	-0.59	-0.40	-0.13	+0.15	-0.42
15 . . .	-176.72	-42.85	-18.92	-9.78	-4.73	-2.54	-1.72	-1.45	-1.04	-0.63	-0.22

As yet, one more fundamental difference between sea and fresh ice is apparent from formula (2) which had been checked empirically by Malmgren: fresh ice expands with a rise in temperature; sea ice, when it has low temperatures and slight salinities and at the same time the correction of the coefficient of expansion for salinity is not great, also expands with a rise in temperature, but expansion is less than fresh ice. At high temperatures and great salinities, the amount of the correction for salinity increases so much that the coefficient of volumetric expansion becomes negative, i.e., the volume of the ice increases with a drop in temperature. Table 42 shows the change (in m) of the length of 1 km of ice of different temperatures and salinities with a 1° rise in temperature.

TABLE 42. CHANGES IN THE LENGTH OF 1 KM OF ICE IN M
WITH A 1° RISE IN TEMPERATURE

Salinity of Ice in o/oo	Temperature in Degrees C	Coefficient of Linear Expansion	Change in the Length of Ice
0	-20	+0.000055	0.055
10	-20	+0.000047	0.0047
10	- 4	-0.000911	-0.901

Malmgren conducted direct determinations of this coefficient in a specially constructed apparatus simultaneously with a computation of the coefficient of expansion. Furthermore, he compared his data with data of Petterson. Petterson had conducted his experiments very carefully with artificially prepared sea ice. It developed that all the results are in good agreement. This proves first of all the correctness of Malmgren's reasoning and secondly the fact that air bubbles within sea ice play a secondary role in the thermal expansion of ice. The latter follows from the agreement of the data obtained by Petterson when investigating artificially prepared sea ice devoid of any air bubbles with Malmgren's observations of natural ice which contained air bubbles.

LITERATURE: 52, 53, 62, 73, 104.

Section 64. Thermal Conductivity

The coefficient of thermal conductivity of pure ice, devoid of air bubbles, as an average of the data of many investigators, is given by

$$k = 0.00540 \text{ g-cal/sec} \cdot \text{deg} \times \text{cm}$$

wherein, according to Lis, it decreases somewhat (approximately 0.00001 per 1°) with a decrease in temperature.

Malmgren determined the thermal conductivity of sea ice using both direct and indirect methods for this purpose.

On the basis of his indirect computations for the coefficient of thermal conductivity, Malmgren gives a chart (figure 56) which represents the average changes of the thermal conductivity as a function of the depth of the ice level; Malmgren shows that the rapid decrease in the coefficient of thermal conductivity when approaching the upper layers of the ice is explained by the presence of a multitude of small air bubbles in these layers. At a great distance from the surface, the thermal conductivity of sea ice approaches the thermal conductivity of pure ice containing no air bubbles.

As Chernigovskii indicates, according to his computations which were conducted by the same method as Malmgren's computations, the thermal conductivity of fast ice on the Kara Sea increased from winter to summer and from the upper surface of the ice to the lower. Thus, at 0 cm level, it was about 0.001, and at the 150 cm layer it was about 0.0044.

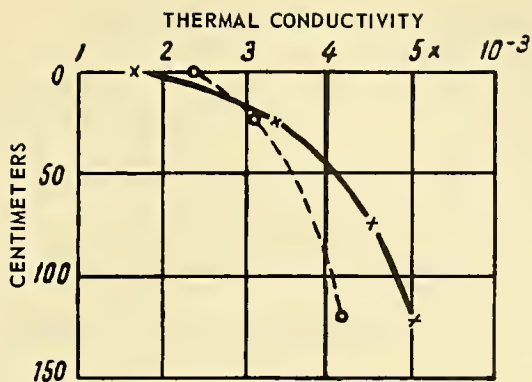

Figure 56. The thermal conductivity of sea ice according to Malmgren, as determined by observations from October 1922 to August 1923 (---), and from November 1923 to May 1924 (—).

Considering the coefficient of thermal conductivity of pure ice as being 0.0054 and neglecting the thermal conductivity of the air bubbles, I have computed the coefficients of thermal conductivity and temperature conductivity of pure ice with varying densities (table 43).

TABLE 43. THE COEFFICIENTS OF THERMAL CONDUCTIVITY AND TEMPERATURE CONDUCTIVITY OF ICE AS A FUNCTION OF ITS DENSITY (MULTIPLIED BY 10^4)

Density of Ice	0.92	0.90	0.88	0.86	0.84
Thermal Conductivity	54	53	52	50	49
Temperature Conductivity	117	118	118	117	117

The values in table 43 considerably exceed the thermal conductivity values obtained by Malmgren by the indirect method. However, it should be remembered that the thermal conductivity of sea ice is determined not only by the thermal conductivity of pure ice and the amount of air bubbles within the ice, but also by the amount of brine contained in the cells.

During this, it is necessary to take into consideration the molecular thermal conductivity of brine since the turbulence processes in the brine cells and the capillaries have no place here.

The molecular thermal conductivity of pure water at 0° is 14×10^{-4} g-cals/sec deg cm, for water with salinity of 40 o/oo at the same temperature, it is about 13×10^{-4} g-cal/sec/cm, i. e., approximately four times less than the thermal conductivity of pure ice. Therefore it is clear that the saltier and more porous the ice, the less its thermal conductivity.

As for the thermal conductivity of snow, Abel's careful investigations have shown that it depends on the density of the snow and is expressed by the formula

$$K = 0.0067\delta_s^2,$$

where δ_s is the density of snow.

The thermal conductivity coefficients of snow at different densities computed according to this formula are shown on table 44.

TABLE 44. THE THERMAL CONDUCTIVITY OF SNOW AS A FUNCTION OF ITS DENSITY (MULTIPLIED BY 10^4)

Density of snow	0.1	0.2	0.3	0.4	0.5	0.6	0.7	0.8	0.9
Thermal conductivity . .	1	3	6	11	18	24	33	43	54

As we see with high snow densities, thermal conductivity computed according to Abel's formula is very close to the thermal conductivity of ice determined by direct measurements.

The coefficients of temperature conductivity and thermal conductivity are related to each other by the formula

where a is the coefficient of temperature conductivity,

k is the coefficient of thermal conductivity,

c is the specific heat,

δ is the density.

For water, the turbulent coefficients of temperature conductivity and thermal conductivity, determined generally very approximately, can in practice be considered equal to each other numerically (not in size) since both the specific heat and the density of sea water are very near to unity.

For pure ice it can be seen from table 43 that the coefficient of temperature conductivity is numerically more than twice the coefficient of thermal conductivity. For sea ice, the coefficient of temperature conductivity depends to a great extent on an extremely changing specific heat.

LITERATURE: 1, 62, 73, 104.

Section 65. Density as a Function of Temperature and Salinity

As we have seen, natural ice is not a homogenous body, but a porous one, the cells and capillaries of which are filled with brine, silt, and air. Some of these cells are completely isolated from each other, others communicate freely both with each other and with the external water and air. This condition makes the concept of density when applied to natural ice extremely conditional. In any case when we speak of the density of ice, we must relate this concept to sufficiently large volumes of it in order to obtain an average value.

The density of pure ice which has no air bubbles at 0° equals 0.9176 g/cm^3 . Therefore, its specific volume is equal to $1.0898 \text{ cm}^3/\text{gram}$. Inasmuch as the specific volume of pure water at 0° is equal to 1.00013 , consequently, during ice formation, the specific volume increases approximately 9 per cent.

During changes in temperature, the density of pure ice changes insignificantly. Actually, the coefficient of volumetric thermo-expansion of pure ice within the temperature limits of 0° to -20° is approximately

$$\beta = 0.000165.$$

Thus the density of pure ice which has no air bubbles would be given by

$$\delta_t = \frac{\delta_0}{1 + 0.000165 t}, \quad (1)$$

where δ_t is the density of pure ice at a temperature t ,

δ_0 is the density of pure ice at a temperature of 0° .

The density of sea ice depends on its temperature, salinity, and porosity.

When computing the density of sea ice as a function of its temperature and salinity, let us remember that according to Section 57, 1 g of sea water contains $\left(\frac{S_i}{S_\tau}\right)$ g of brine and $\left(1 - \frac{S_i}{S_\tau}\right)$ g of pure ice, where S_i is the salinity of sea ice, S_τ is the salinity of the brine in the cells.

Hence, the volume of 1 g of sea ice with the salinity of S_i and temperature τ , expressed in cubic centimeters, or in other words, its specific volume, will equal

$$v_{s\tau} = \frac{S_i}{S_\tau} \frac{1}{\delta_{s\tau}} + \left(1 - \frac{S_i}{S_\tau}\right) \frac{1}{\delta_{0\tau}}, \quad (2)$$

where $\delta_{s\tau}$ is the density of the brine, the salinity of which is equal to S_τ at temperature τ .

It is clear that, knowing the specific volume of sea ice, it is not difficult to compute the density as the reciprocal of the specific volume, according to the formula

$$\delta_{s\tau} = \frac{1}{v_{s\tau}}. \quad (3)$$

Let us make the following assumption for computing this amount $\delta_{s\tau}$.

It is known that the density of sea water is related to its temperature and salinity by a very complex relationship, but for approximate computations, density vs. salinity can be expressed by the following simple formula

$$\delta_{st} = \delta_{0t} + 0.0008 S, \quad (4)$$

where $\delta_{0\tau}$ is the density of pure water at temperature τ ,

$\delta_{s\tau}$ is the density of sea water, the salinity of which is S and temperature τ .

Keeping in mind that the density of supercooled water is approximately equal to unity, and expanding formula (4), to the low temperatures and high concentrations of brine, we can compute the density of brine according to formula (5)

$$\delta_{s\tau} = 1.000 + 0.008 S_\tau. \quad (5)$$

Table 45 shows the results of my computations according to formulas (1) and (4), and table 46, the results of computations according to formula (3) and table 45.

TABLE 45. THE DENSITY OF PURE ICE $\delta_{0\tau}$ SUPERCOOLED WATER δ_w , AND SALT-CELL BRINE $\delta_{S\tau}$ AT DIFFERENT TEMPERATURES

τ°	$\delta_{0\tau}$	S_τ	δ_w	$\delta_{S\tau}$
- 2	0.918	37	0.99972	1.030
- 4	0.918	69	0.99945	1.055
- 6	0.918	95	0.99912	1.076
- 8	0.919	120	0.99869	1.096
-10	0.919	144	0.99815	1.115
-15	0.920	193	0.99815	1.154
-20	0.921	237	-	1.190
-23	0.921	260	-	1.208

When examining table 46, we see that the density of sea ice which has no air bubbles in connection with a change in its temperature and salinity changes comparatively little, but it discloses a characteristic property, namely, when the temperature of sea ice changes, its density crosses the minimum. This phenomenon is completely within the law.

TABLE 46. THE DENSITY OF SEA ICE AT DIFFERENT TEMPERATURES AND SALINITIES AND WITHOUT AIR BUBBLES

$S_i \backslash \tau^\circ$	-2	-4	-6	-8	-10	-15	-20	-23
2	0.924	0.922	0.920	0.921	0.921	0.922	0.923	0.923
4	0.927	0.925	0.924	0.923	0.923	0.923	0.925	0.925
6	0.932	0.928	0.926	0.926	0.926	0.925	0.926	0.926
8	0.936	0.932	0.929	0.928	0.928	0.928	0.929	0.929
10	0.939	0.935	0.931	0.929	0.929	0.929	0.930	0.930
15	0.953	0.944	0.939	0.937	0.935	0.934	0.935	0.935

Actually we have seen in Section 63 that the coefficient of the volumetric expansion of 1 g of sea ice, according to Malmgren, is determined by the approximate formula

$$u_\tau = 0.000169 - 0.091 \frac{S_i}{S_\tau^2} \frac{\partial S_\tau}{\partial \tau}. \quad (6)$$

The first number on the right side of this equation, according to Malmgren, is the coefficient of the thermal expansion of 1 g of pure ice. The second is the correction for salinity which characterizes the change in volume as a result of the formation or melting of a certain amount of pure ice in the brine cells during the change of temperature.

In formula (6), the fundamental difference between sea ice and fresh ice becomes apparent. The density of fresh ice increases with a decrease of temperature. The density of sea ice, when it has low salinity and a low temperature, also increases with a decrease in temperature, although to a lesser extent than the density of pure ice. But at high salinities and comparatively high temperatures, the density of sea ice decreases with the decrease in temperature. Therefore, the concept introduced by me for minimum density of sea ice as a function of temperature and salinity is based upon this. I have made use of Malmgren's formula (6) for the corresponding computations.

Actually, if the coefficient of thermal expansion changes sign, then obviously, the minimum density would occur when that coefficient would equal 0. Thus, from formula (6) we obtain

$$0.000169 = 0.091 \frac{S_i}{S_\tau^2} \frac{\partial S_\tau}{\partial \tau}, \quad (7)$$

where S_i is the salinity of sea ice,

S_τ is the salinity of the brine in the salt cell at temperature τ ,

$\frac{\delta S_\tau}{\delta \tau}$ is the change of the salinity with temperature changes.

As we have seen, the values S_τ and $\frac{\delta S_\tau}{\delta \tau}$ determine the temperature of sea ice. Therefore using formula (7) it is not difficult to compute such a temperature θ' for any salinity of sea ice at which the density of sea ice will be a minimum (table 47).

TABLE 47. THE MINIMUM DENSITY TEMPERATURE OF SEA ICE OF DIFFERENT SALINITIES

S_i	θ'	S_i	θ'
0	0.0°	9	-16.0°
1	- 5.1	10	-17.6
2	- 7.5	11	-18.5
3	- 9.3	12	-19.3
4	-10.7	13	-20.1
5	-12.0	14	-20.8
6	-13.2	15	-21.4
7	-14.4	16	-22.0
8	-15.5	17	-22.6

Nevertheless, it should be pointed out that the figures in this table are more of a theoretical interest, inasmuch as the changes in the density of sea ice in connection with the change in its temperature as we have seen are comparatively slight.

LITERATURE: 44, 62, 77.

Section 66. Density as a Function of Porosity

The ratio between the volume of air or gas bubbles found in ice to the total volume of ice is called the porosity of ice and is expressed in percentage. Arnold-Aliabev calls the following value the coefficient of porosity.

$$\varepsilon = \frac{n}{1-n} = \frac{\delta_0 - \delta}{\delta},$$

where n is the porosity of ice

δ_0 is the density of ice devoid of air bubbles.

The bubbles in sea ice can be of different origin and form. A part of the bubbles forms as a result of the separation of gases dissolved in water which had not succeeded in leaving the cells between the crystals of ice during ice formation. As has been confirmed by experiments with artificial freezing, the amount of these bubbles is proportional to the saturation of the water with gases

at the initial moment and is inversely proportional to the speed of ice formation. In fresh ice formed under calm conditions these bubbles in most cases are very elongated and thread-like, with a certain thickening in the upper part. The diameter of such thread-like bubbles equals several tenths of a mm and the length 1 to 2 cm. More rarely, such bubbles have a round or pear-like form.

Another group of bubbles forms as a result of gases that have separated from the water and bottom sedimentation and have floated up to the underside of the ice. Primarily, these are flattened convex bubbles 10 cm and more in diameter. Particularly, great accumulations of such bubbles are found in the ice that had formed over areas where an intensive decomposition of organic matter occurs on the bottom with a consequent separation of gases. In shallows, the amount of these gases is sometimes so great that they form hollows the size of a fist and make the lower surface of the ice uneven.*

Still another group of bubbles in sea ice results when algae frozen into the ice continue to produce gases in the form of tiny bubbles.

Finally, air bubbles form due to the replacement of brine with air which had seeped out of the sea ice in the course of time. These bubbles ordinarily form chains stretched out in a vertical direction. The last group of air bubbles has the greatest significance for sea ice in open seas.

Let us assume that the brine had completely seeped out of the salt cells and had been replaced with air. Such an assumption is completely possible for the above-water parts of ice, especially for the upper parts of hummocks. In Section 65 we have seen that the volume of 1 g of sea ice is

$$v_{s\tau} = \frac{S_i}{S_\tau} \frac{1}{\delta_{s\tau}} + \left(1 - \frac{S_i}{S_\tau} \right) \frac{1}{\delta_\tau}, \quad (1)$$

where the first member on the right side represents the volume occupied by the brine and the second represents the volume occupied by pure ice.

On the assumptions made, and with the porosity of ice defined as the ratio of the volume occupied by the bubbles of air to the total volume of ice, expressed in percentage, we obtain

$$n = \frac{S_i}{S_\tau} \frac{100}{\delta_{s\tau} \cdot v_{s\tau}}. \quad (2)$$

Table 48 is computed according to formula (2).

This table makes clear the importance of a rise in air temperature and the corresponding warming of the above water parts of ice. The brine cells in this case increase their volume considerably, the brine is able to drain down, and as a result, porosity increases greatly.

According to Bruns' measurements in September 1934, the sea ice of the Barents Sea sometimes contained 12 to 13 per cent gas by volume. The results of an analysis of the composition of the gases in the bubbles are shown in table 49.

*In the Laptev strait, Ermolaev has observed a vigorous separation of methane rising from the bottom of the ice and burning above the surface of the frozen sea with a bluish flame.

TABLE 48. THE POROSITY OF ICE (IN PERCENTAGE OF VOLUME) WHEN THE SALT CELLS ARE REPLACED WITH AIR

$\tau^\circ \backslash S \text{ o/oo}$	-2	-4	-6	-8	-10	-15	-20	-23
2	4.9	2.5	1.8	1.4	1.1	0.8	0.6	0.6
4	9.9	5.1	3.6	2.8	2.3	1.7	1.3	1.2
6	14.9	7.7	5.5	4.2	3.4	2.6	1.9	1.8
8	20.0	10.3	7.3	5.7	4.6	3.4	2.6	2.3
10	25.1	12.9	9.2	7.1	5.8	4.3	3.3	2.9
15	38.2	19.5	13.9	10.7	8.7	6.3	5.0	4.4

TABLE 49. GAS CONTENT OF THE SEA ICE OF THE BARENTS SEA (IN PERCENTAGE OF VOLUME)

Number of Tests	CO ₂	O ₂	N ₂ + Rare Gases	Ar + Heavy Gases	O ₂ : N ₂
1	-	18.3	81.7	0.917	0.224
2	0.6	15.9	83.5	0.905	0.190
3	0.5	16.5	83.0	0.884	0.187
4	0.6	18.0	81.4	0.944	0.223
Average	0.4	17.2	82.4	0.912	0.209

The ratio of the oxygen and nitrogen content which saturates sea water at all temperatures and salinities is approximately 0.5; the same ratio in air is approximately 0.264. The total content of oxygen and nitrogen which will saturate sea water of various salinities at freezing temperature fluctuates within the limits of 2.2 to 2.9 per cent by volume. Therefore, it should be concluded that the hollows in the sea ice are mainly filled with the air of the atmosphere, whereupon the amount of oxygen in it is lowered and the amount of carbon dioxide is raised,* in all probability by the respiration of organisms contained in sea ice and by oxidation processes.

As the investigations of Deriugin and Bruns indicated, the distribution of the gases even in ice formed under calm conditions is extremely nonuniform and the least porosity is observed in the middle part of the ice.

According to the investigations of Arnold-Aliabev, the air content within the ice of the Gulf of Finland fluctuates within the limits of 4 per cent by volume, whereas in the ice of the Barents Sea, the air contained 8 per cent and higher. The distribution of air bubbles in the separate pieces of ice is very uneven as can be seen from figure 57.

An exception to the indicated rule, is old ice which during the course of its existence had undergone strong compression which had gradually forced the brine and particularly the air bubbles out of the ice and had turned such ice into a solid monolithic mass.

*Bruns indicates that the amount of carbon dioxide is evidently still greater inasmuch as a part of the carbon dioxide dissolves in water when the air bubbles are freed from melting ice.

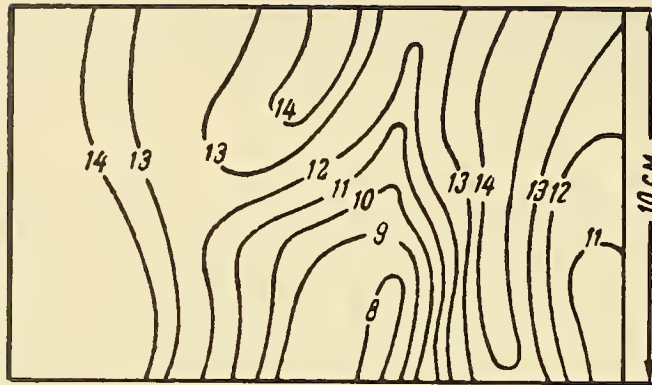

Figure 57. Isolines of air bubble content in a cm^3/kg in the upper layer of an ice floe in the Gulf of Finland.

Sometimes the amount of air in the ice is expressed in cubic cm per kg of ice. Piotrovich made interesting observations of air content in the ice of the Chuckchee Sea during the voyage of the *Krasin* in 1935.

In the very thin discs (about 2 cm) of young ice, the air content fluctuated within the limits of 3.7 to 12 cm^3/kg . In the same ice 10 cm thick, the amount of air increased to 31.0 cm^3/kg . Blue ice proved to contain considerably more air (from 55 to 130 cm^3/kg) than did the greenish (from 9 to 102 cm^3/kg), the yellowish (about 24 cm^3/kg) and snow (firn) ice (about 66 cm^3/kg). On the other hand, the air bubbles in blue ice differed by their small size (up to 1 to 2 mm) whereas the size of the rounded bubbles in greenish ice attained 2 to 3 cm, according to Piotrovich's observations.

According to Savelev's observations of fast ice near Uedineniya Island conducted February through May, 1939, the porosity of ice increases from February to May and is always greater at the upper and lower surface of the ice than in the middle parts.

Its values at the following levels in May were: 10 cm - 35.0, 80 cm - 8.0 and 170 cm - 44.0 cm^3/kg .

The data presented and discussions indicate that the hollows determining the porosity of sea ice are explained first of all by the fact that the upper layers of the ice are formed from snow, and second by the fact that the brine draining from the cells and capillaries is replaced with atmospheric air.

The origin of air bubbles in snow and glacial ice is somewhat different. In firn ice which forms from long-lying snow, air occupies 30 to 50 per cent of the volume. In the course of time with a gradual transformation of firn ice, the air bubbles are partially forced out into the atmosphere through the tiny cracks and canals and are partially compressed and preserved under pressure. This pressure has been indicated by the research of the Koch and Wegener Expedition in Greenland in 1912 - 1913, and in separate instances can reach 10 to 12 atmospheres.

Barnes expressed the thought that by investigating the air enclosed in the ice of icebergs, it is possible to judge the composition of the atmosphere at the time when the formation of a given ice glacier occurred. The conducted investigations of the air in the bubbles, however, did not disclose any differences from the contemporary composition of the atmosphere.

The air content fluctuated from 7 to 15 per cent in the icebergs investigated by Barnes near Newfoundland, and, as an average, was about 10 per cent.

The density of the icebergs fluctuates, according to Smith, from 0.6 to 0.92, in accordance with their air content.

The most porous and light glacial ice forms at very high latitudes. This ice is very lightly fused and falls apart easily. Icebergs consisting of such ice are called "sugar" by the Norwegians.

The copious release of air bubbles which is usually observed during the melting of glacial ice, and which is accompanied by characteristic hissing resembling the hissing of frying fat, should evidently be explained by the increase of pressure in the air bubbles trapped in the ice.

The density of porous ice is determined by the formula

$$\delta = \delta_0 \left(1 - \frac{n}{100} \right), \quad (3)$$

where δ_0 is the density of ice without air bubbles, and n is the porosity of ice.

The density δ_0 is a function of the temperature and salinity. As we saw in table 46, under natural conditions it fluctuates within the limits of 0.920 to 0.953.

From formula (3) we obtain

$$n = 100 \left(1 - \frac{\delta}{\delta_0} \right), \quad (4)$$

I computed the porosity of pure ice and snow as a function of its density (table 50) according to formula (4).

TABLE 50. THE POROSITY OF SNOW AND ICE AS A FUNCTION OF DENSITY

Density	. . .	0.1	0.2	0.3	0.4	0.5	0.6	0.7	0.8	0.9
Porosity	. . .	89	78	67	56	46	35	14	13	2

LITERATURE: 8, 9, 13, 44, 62, 115, 129.

Section 67. Buoyancy

Only a comparatively small part of ice rises above water (figure 58) as a result of the slight difference between the densities of ice and water.

Let the density of ice be δ_i , and density of water δ_w , the above-water volume V_h , and the underwater volume V_z , then according to Archimedes Principle, between these quantities there exists the relationship;

$$(v_h + v_z) \delta_i = v_z \delta_w. \quad (1)$$

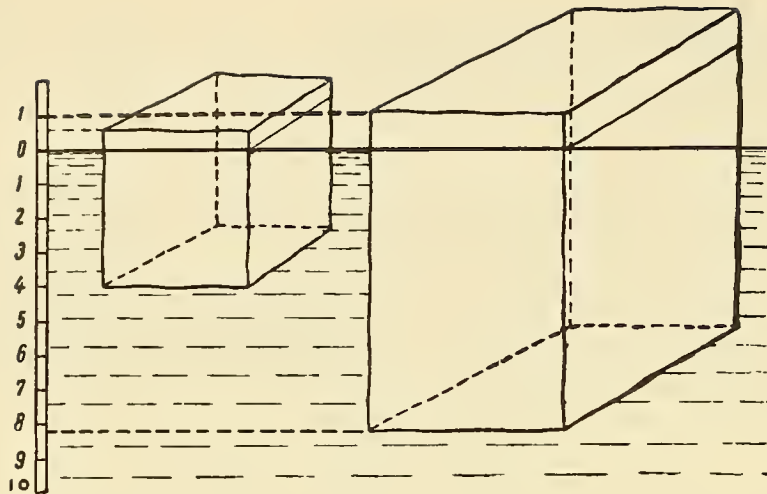

Figure 58. The draft of an ice cake (density 0.90) in water (density 1.01) according to Burke.

It is clear that if the upper and lower surfaces of the ice floe are horizontal and its side walls are vertical, formula (1) is simplified, namely:

$$(h + z) \delta_i = z \delta_w, \quad (2)$$

where h is the above water elevation, z is the underwater draft of the ice floe.

From formula (2) we obtain

$$\frac{z}{h} = \frac{\delta_i}{\delta_w - \delta_i},$$

or

$$\frac{z}{i} = \frac{\delta_i}{\delta_w}, \quad (3)$$

where i is the general thickness of the ice.

Table 51 gives the relation between the draft of the underwater part of the ice floe to the height of the above water part at different densities of water and ice for homogeneous ice floes.

When examining table 51, we see that even a slight change in the density of the ice or water causes a great change in the relation of the above water ice to the draft of the underwater part of the ice fields.

But we have seen that sea ice is a porous body in which part of the pores in the surface part of the ice communicate with the air and the underwater part communicates with the sea water. It is clear that such pores should be excluded from the volume of ice introduced into formula (1). Remembering these reservations, let us note that the porosity of sea ice increases considerably during the summer when air replaces the brine in the cells, and at this time, the density of the

above water part of ice can differ sharply from the density of its under-water part. Therefore, making formula (2) more exact, we obtain

$$h\delta_h + z\delta_z = z\delta_w, \quad (4)$$

where δ_h is the density of the above water part,

δ_z is the density of the underwater part.

From formula (4) we obtain

$$\frac{z}{h} = \frac{\delta_h}{\delta_w - \delta_z}. \quad (5)$$

Just how considerably the density can fluctuate is shown by Malmgren's measurements of the density of ice in the same ice field. During the winter, when the brine and air cells in the cold ice were isolated from each other and from the surrounding media, the density of the ice fluctuated within the limits of 0.914 to 0.924, in May within the limits of 0.885 to 0.899.

It has already been noted that according to Savelev's observations of 1939 the porosity of fast ice increased from February to May and minimum porosity was noted in the middle levels of the ice. Correspondingly, the density of the ice decreased from February to May and attained its maximum values in the middle parts of the ice. Thus in May 1939 at the 5 cm level, the density was 0.870, at 80 cm - 0.910, and at 172 cm - 0.875. The lowest density of sea ice, according to Makarov's determination (13 August 1899) was 0.846, and the greatest was 0.929 with a 2.8 o/oo salinity of ice.

Makarov calls the following ratio the buoyancy of sea ice

$$\frac{h}{h+z} = \frac{h}{i}. \quad (6)$$

TABLE 51. THE RATIO OF THE UNDERWATER TO THE ABOVE-WATER PARTS OF HOMOGENEOUS ICE FLOES HAVING HORIZONTAL UPPER AND LOWER SURFACES AND VERTICAL SIDE WALLS

$\delta_i \backslash \delta_w$	1.00	1.01	1.02	1.03
0.80	4.0	3.8	3.6	3.5
0.85	5.7	5.3	5.0	4.7
0.90	9.0	8.2	7.5	7.0
0.95	19.0	15.2	13.6	11.9

According to his measurements conducted in sea water having a temperature of -1.5° and a salinity of 32.4 o/oo (density, 1.0258), the buoyancy of 27 investigated samples fluctuated within the limits of 1:6 to 1:15.

I call the coefficient of buoyancy the entire load in tons which forces one meter cubed of ice to sink. It is not hard to see that the coefficient of buoyancy is equal to

$$p_0 = (\delta_w - \delta_i). \quad (7)$$

It is clear that the buoyancy of an ice floe will be the product of the coefficient of buoyancy and the volume of the ice flow expressed in m^3 , or

$$p = p_0 i q, \quad (8)$$

where i is the thickness of the ice,

q is the area of the ice.*

TABLE 52. THE BUOYANCY COEFFICIENT OF SEA ICE IN TONS

$\delta_i \backslash \delta_w$	1.00	1.01	1.02	1.03
0.80	0.20	0.21	0.22	0.23
0.85	0.15	0.16	0.17	0.18
0.90	0.10	0.11	0.12	0.13
0.95	0.05	0.06	0.07	0.08

It follows from formulas (6) and (7) that buoyancy is greater the greater the thickness of the ice and the density of the water and the less the density of the ice.

It can be easily seen from table 52 that with ice thickness remaining constant, the possible seasonal changes in the density of the water in which the ice is floating have little effect on the buoyancy of ice. The matter is different with the density of the ice itself, seasonal changes of which are extremely important. Because of this, if the fact that the pores of the summer ice are opened to the surrounding media while the pores of winter ice are not exposed to it is not considered, we can by formulas (6) and (7) arrive at a false conclusion that ice of the same thickness has greater buoyancy during the summer than during the winter. But we observed the reverse phenomenon in nature.

The fact that the upper surface of the ice sinks below the surface of the water under the weight of the snow precipitated upon the ice, and especially under the weight of snow drifts, is explained by the slight buoyancy of ice. Actually, from formulas (3) and (7) it follows that the upper surface of the ice field sinks below the level of the water on the condition that

$$s\delta_s = i(\delta_w - \delta_i), \quad (9)$$

where S is the height of the snow cover,

δ_s is the density of the snow.

*Formulas (6) and (7) and table 52 are derived on the proposition that the ice is homogeneous in density in its upper and lower parts.

From formula (7) it follows that an ice floe, the buoyancy coefficient of which is 0.1, the thickness 40 cm, and the area 2.4×4.37 (10.5 m^2) (the dimensions of a 12 ton tractor), will sink under a load of 0.4 tons. Therefore, if an ice floe is to support the weight of a tractor exclusively by its own buoyancy, its area should be no less than 300 square m.

It follows from this example that if we want to use the buoyancy of ice for supporting a load, we should distribute the load over large areas of ice.

LITERATURE: 62, 76, 77, 101.

Section 68. Density of Snow

The most noteworthy property of a snow cover is its significant density.

Another no less noteworthy property of snow is its ability to change its density due to the action of pressure by the above-lying layers, wind, solar radiation, temperature, and the humidity of the air and liquid precipitates, basically raising the density in the course of time, but, in separate instances, even lowering it.

Some aspects of natural snow are of practical interest.

"Wild Snow" is very fluffy, has almost no cohesion, pours like flour. Such types of freshly-fallen snow are often observed during a full calm and low air temperature. The density of such snow is about 0.01 to 0.03.

"Sandy Snow" falls at extremely low temperatures. Sleds and skis move over it with difficulty which in part confirms the observations of Koch and Wegener in Greenland.

"Frozen Windcrust and Windrind" are formed by wind pressure. This pressure is considerable. For light winds (5 m/sec) it equals about 3 kg/m^2 , for a fresh breeze (9 m/sec) it is about 6 kg/m^2 and for storm winds (30 m/sec) it is about 74 kg/m^2 . Pure snow made dense by wind has a dull crust and surface covered with ripples. Frozen wind crusts of great strength are called "snow boards."

"Spring Snow" is snow which disintegrates into individual grains. It presents an excellent surface for skiing since the grains are wetted by melt water and move with respect to each other practically without friction.

"Spring Rind" forms on spring snow when its surface temperature decreases. It usually consists of a thin layer of ice found above snow and separated from it by a thin air layer.

"Sun Rind" forms at low air temperatures as a result of the melting of upper snowflakes and their freezing together.

"Rain Rind" forms after light rain falls over very cold snow.

The density of snow fallen on the surface of land or ice increases not only due to wind pressure and other factors but also due to the weight of above-lying layers. The latter case is taken into consideration.

Abe, considering that density is proportional to pressure and to the gradient of pressure, obtained

$$d\rho = k\rho dz, \quad (1)$$

where ρ is the density, z is the depth of the layer, and k is the coefficient of proportionality.

$$\rho = \rho_0 e^{kz}. \quad (2)$$

Abe determined the constants entering into the formula (2) from his measurements at 7 levels of snow which were about 70 cm and finally obtained

$$\rho = 0.1854 e^{0.00545z}, \quad (3)$$

where z is expressed in centimeters.

According to Shepelevskii, the density of snow remains unchanged to a certain depth, inasmuch as the density of the snowflakes is sufficient here to support the light weight of the upper layers. Shepelevskii, like Abe, also considers that below this depth the density of the snow changes with depth according to logarithmic laws.

Finally after a certain additional assumptions, Shepelevskii arrives at the following formulas

$$\begin{aligned} \rho &= \rho_1 \sqrt{\frac{z-H_0}{H_1}}, \\ H_0 &= \frac{2}{3} H_1 \frac{\rho_0^2}{\rho_1^2}, \end{aligned} \quad (4)$$

where ρ_1 is the density of snow cover at a depth H_1 .

For an approximate evaluation of snow density, Kukharskii worked out the following scale which proved to be useful during sled expeditions:

<u>Point</u>	<u>Characteristics</u>
1	Loose snow not supporting one's weight at all.
2	Snow, lightly compressed by the foot.
3	Foot sinks up to the ankle and is supported before reaching the ground or the ice.
4	The foot sinks into the snow 1 to 2 cm when walking.
5	Snow supporting the weight of a man - the foot leaves a slight print.
6, 7, 8	Snow is dense and yields to a soft foot gear and to a blow by it.
9, 10	Snow yields with difficulty to a blow by a wooden stake.

LITERATURE: 25, 133, 142.

Section 69. Radiation Properties

The ice crystals are uniaxial and positive. Therefore, the speed of extraordinary rays in ice is greater than the speed of ordinary rays and hence the coefficients of refraction are greater. *

The coefficients of refraction of ice are very close to the coefficients of refraction of water. Water and ice also differ only slightly in their absorption coefficients and because of this, ice is very similar to water in its optical properties.

Other radiation properties of snow and ice are more important.

The great ability of snow to reflect radiant energy (albedo) has already been noted. This is of especially great significance to ice cover inasmuch as the latter is always covered on top by a more or less thick layer of snow. Kalitin's special investigations show that the reflecting ability of snow is greater, the more pure and fine the snow is and the lower its temperature. Thus, the albedo of newly fallen pure snow attains 90 per cent and the albedo of melted and granular snow (after a warm spell) decreases to 52 percent and lower.

Recently many observations of the albedo of sea ice, snow, and on the penetration of solar radiation have been conducted under natural conditions at different polar stations of the soviet sector of the arctic, namely at: Uedineniie Island, Cape Cheliuskin, Tiksi Bay, Tikhaia Bay, and Cape Schmidt.

As a result of a breakdown of these observations, Chernigovskii gives the following table of albedo for snow cover and ice, free of snow, by months, for the northern latitudes from 69° to 80° (table 53).

TABLE 53. THE APPARENT VALUE OF SNOW AND ICE
ALBEDO IN ARCTIC SEAS IN PER CENT

Month	Snow	Ice
March	87	--
April	87	40
May	83	45
June	80	Along an offshore strip the albedo of snow cover is about 70 per cent in June and about 50 per cent in July.
July	60	

Kalitin conducted investigations of the passage of radiant energy through snow covers of various thicknesses. Figure 59 shows the results of these investigations. The upper curve deals with snow having a temperature below 0°, i. e., with dry snow. The lower curve deals with melting snow, soaked with water. Both curves are constructed taking into consideration the reflecting ability of the snow, in other words, taking into consideration only the radiant energy which had

*In uniaxial crystals (into which category fall ice crystals), the incident ray is divided into 2 rays during refraction; the ordinary--in which the ratio of the sine of the angles of incidents and refraction is equal to the refractive index, and the extraordinary--for which this ratio has no physical significance. When the index of refraction of an extraordinary ray is mentioned, it is understood to mean the maximum deflection of an extraordinary ray.

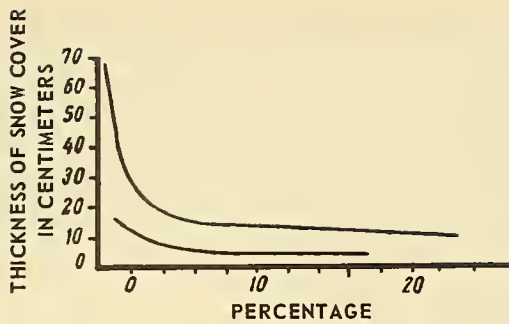

Figure 59. The passage of radiant energy through a snow cover.

actually entered into the snow cover, and not the total energy which had fallen on its surface and had been partially reflected.

In summing up the results of his investigation of the radiational properties of natural fresh ice, Kalitin arrives at the following conclusions:

1. Ice is easily penetrated by radiant energy within the limits of wave lengths of 0.35 to 3.0 microns, i. e., by the shortwave part of the spectrum.
2. As can be seen from figure 60, ice is more transparent to scattered radiation than to direct (radiation).

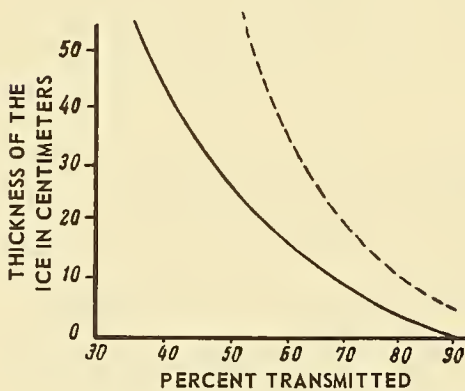

Figure 60. The change of ice transparency for direct (smooth curve) and scattered (dashed curve) solar radiation as a function of ice thickness.

3. The transparency of ice is very much affected by the air bubbles imbedded in it, whereupon porosity being equal, small bubbles, due to which there is a great deal of scattering of the incident radiant energy, makes the ice less transparent than large bubbles.

It is noteworthy that ice which to the eyes appears to be completely homogeneous, very transparent, and which contains no visible air bubbles, may prove to be more transparent to scattered radiation.

4. Ice, even in very thin discs, is completely nontransparent to long-wave rays. In this respect, ice is similar to glass, and a thin ice cover develops a "green house" effect, analagous to the same effect of glass.

This fact was noted by Melloni who as far back as 1832 showed that a plate of ice 2.6 mm thick passes 6 per cent of the energy incident on it from a source whose temperature was 1200°, and passes no radiant energy from a source fhaving a temperature of 100°.

The "green house" effect of ice is a very important factor. Due to it, ice in thin discs not only preserves the layers of water lying beneath it from cooling but with a sufficient intensification of illumination, it even assists in gradually warming them.

As for the penetrability of sea ice to the total flow of radiation, Chernigovskii presents the average results of corresponding measurements in Tiksi Bay (table 54).

TABLE 54. THE AVERAGE PENETRABILITY OF SEA ICE BY TOTAL FLOW OF RADIATION IN PER CENT FROM 19 APRIL THROUGH 4 MAY 1937 (TIKSI BAY)

Thickness of Ice in cm	0-7.3	0-11.5	0-21.0	0-42.0
The per cent of radiation in relation to the incident along the surface (without albedo) .	48	44	36	23
Albedo	40	40	40	40
Absorption	12	16	24	37

Chernigovskii also presents data on the penetrability of the snow cover for radiation from which it can be seen that not more than 10 per cent of the radiation passes through a layer of snow 5 cm thick, not more than 5 per cent through a layer of snow 10 cm thick, and not more than 1 per cent through a layer of snow 15 cm thick.

During intensive melting, however, when icing of the snow mass occurs simultaneously, the penetrability of the snow cover is considerably increased. Thus, according to the observations made at the end of June, 1935 on Uedineniie Island 23 to 30 per cent of the radiation penetrated through snow 5 cm thick, and 6 to 13 per cent was retained in the snow, 26 per cent of the radiation penetrated through a layer 10 cm thick, and 11 per cent was absorbed; through a 16 cm layer, 7 per cent of the radiation penetrated. Other polar stations also obtained amounts on the same order.

LITERATURE: 62, 73, 80, 137.

Section 70. Illumination of the Sea Under the Ice

The question of under-ice illumination has a dual significance. First, this illumination determines the biological productivity of the sea which depends on the photosynthetic activity of plants. Actually, if the sea is covered by a solid ice cover, and, therefore, is isolated from a direct exchange with the atmosphere, the only source for covering the expenditure of oxygen is

photosynthetic activity. When there is no light, the plant organisms which are the original source of food for all the rest of the organisms, cannot develop.

Secondly, under-ice illumination is connected with the practical activity of man: diving work and navigation under ice pertain to this matter.

Unfortunately, under-ice illumination has been poorly studied and the available observations are fragmentary, sometimes even inconsistent.

Trofimov, when studying the conditions of under-ice illumination in the White Sea in April 1934, computed the conditional ice transparencies as the ratio of the intensity of illumination under the ice to the intensity of the light incident from above, minus the albedo of the surface.

The results of his observations are shown in table 55.

TABLE 55. ILLUMINATION UNDER ICE AND SNOW OF DIFFERENT THICKNESSES (IN CM)

State of the Weather	Ice	Snow	Albedo in Per Cents	Illumination in Per Cents		Transparency of Ice in Per Cents
				Under Ice	At a Depth of 5 m	
Sun	10	0	30	42	5.3	0.6
Clear	70	5	90	2.5	0.17	11
Clear	70	12	91	4.5	0.18	37
Cloudy	48	1.5	63	14	3.15	13
The sun shines across a bank of clouds . . .	40	5	78	12	2.75	22
Overcast, fog . .	40	1	41	14	0.66	3
The sun behind a bank of clouds . .	35	3.5	61	22	4.5	19.5

The "Non-albedo" transparency of ice in this table was computed according to formula

$$p = \frac{Ii}{100 - A},$$

where I is the illumination under the ice,

A is the albedo,

i is the thickness of the ice in meters.

As can be seen from the table, the transparency of the ice computed for 1 m of thickness fluctuated within the limits of 0.6 to 37 per cent which is explained by the usual non-homogeneity of the ice cover under natural conditions.

Trofimov's special observations of individual plates of ice 1 to 2 square m in area which had lain for a sufficient time in the air (ropaki) and which are almost fresh (salinity less than 1 o/oo), gave the results shown in table 56.

The ice floes which were investigated were lilac blue which indicated the high purity of the ice.

TABLE 56. TRANSPARENCIES OF ICE IN PER CENTS

Thickness of Ice in cm	Snow in cm	Albedo in Per Cent	Per Cent of Light Passing Through the Snow and Ice	Transparency of Ice in Per Cent
35	5	89	11.1	100
70	5	79	12.5	48

These measurements showed an almost 100 per cent transparency of dry ropak ice which, thus both in its composition and transparency approached pure, fresh water ice. As Trofimov himself indicates, however, the results cannot be considered especially significant due to the difficulty of observation.

During the 1935 *Sadko* expedition, V. Berezkin lowered a photometer into an ice hole about 30 cm in diameter which was later filled with brash ice. On 12 August at 81° 10' north, and 26° 29' east under sunny, cloudless skies and with a snow cover of 3 to 5 cm, (the average of four observations) illumination at a depth of 5 m was about 2 per cent of the surface illumination. Ice was glass-like and transparent and with a great number of air bubbles 5 to 6 mm in diameter.

Nazarov gives the following of his observations conducted in April 1936 4 km from Uedinenie Island at a depth of 13 m, through fast ice 120 cm thick and covered by 20 to 30 cm of snow. Observations were conducted in a closed tent through a special hole. The bottom was well illuminated constantly. Under clear skies, the bottom shone, which Nazarov explains as the reflection of a large amount of light. It was easy to distinguish separate stones on the bottom, and swimming fish and sea animals in the water.

At my request, in March 1941, Bardovskii conducted observations of under-ice illumination with the aid of a secchi disc in Matochkinshar Strait. The results of these observations are presented in table 57.

TABLE 57. THE TRANSPARENCY ACCORDING TO THE SECCHI DISC, UNDER THE ICE OF MATOCHKINSHAR STRAIT

Date	Altitude of the Sun	Thickness in cm		Transparencies Accord- ing to Secchi Disc in m
		Of Ice	Of Snow	
14 March . . .	15°	114	15	36
14 March . . .	15	119	12	28
14 March . . .	14	94	34	21
27 March . . .	19	129	30	34
Average .	16	114	23	30
Average of 10 observations in June . . .	34	132	13	20

The high transparencies found by Bardovskii are extremely interesting. They indicate first, high illumination under the ice, and secondly, a high purity of water during the period of ice formation which forms as a result of a unique purification of the water during winter vertical circulation.

The observations conducted by Bardovskii in March are presented in full. The June observations made at 10 points are averaged. It is interesting that in spite of the considerable decrease in the thickness of the snow (and of the almost unchanged over-all thickness; snow plus ice), the transparency decreased sharply under the ice. This of course, should be attributed to the spring processes (development of life) both in the ice and in the water which begin in June.

It should be pointed out that instrument observations (Trofimov's and others) of ice transparency do not agree with the illumination of the sea under ice (Nazarov, Bardovskii). This question should be investigated further.

LITERATURE: 62, 77, 130.

Section 71. Color

The color of ice, like the color of water, is explained by the selective absorption and a scattering of light rays and also by the size and amount of foreign admixtures. Completely pure and fresh ice which is devoid of air bubbles appears as light azure when being observed in large pieces.

The ice found at sea can be roughly divided according to color: brown, white, green and azure, or even blue. Sailors also distinguish a black ice. This is the ice of frozen fresh water reservoirs which form on ice fields during the summer. It should be emphasized that these colors, or more correctly, hues, are noticeable only in large ice masses. Small pieces of ice almost always seem to be whitish with inner layers of a steel hue.

Brown ice (sometimes yellowish), more properly ice having a brown hue, is of river, or generally shore origin. Its color is explained by a greater or lesser amount of impurities of humic acids or clay substances.

White color is characteristic of ice formed from snow and of layers formed from snow between the layers of ice which had formed from sea water. White ice has many large bubbles of air or brine cells.

Green is characteristic of comparatively young sea ice containing a great amount of air and brine. In small chunks, green ice is usually a whitish, transparent color having interlayers of a steel hue.

Blue or azure color is characteristic of old sea ice from which almost all extraneous admixtures have been squeezed out. The blue color is frequently observed in high ropaks and hummocks which can even be of one year origin. Glacier ice from a deep deposit is also noteworthy for its blue color.

During the summer, when one is searching for fresh-water reservoirs on arctic ice to take water from them, one can be guided by the color of the ice and the color of the water in the reservoirs on the ice. Brown color indicates that there are many diatoms on the bottom of the reservoir, and that the water in it is salty. Green color indicates very salty water with a salinity close to that

of the sea surrounding it. Usually the bottom of such reservoirs proves to have melted through. Blue reservoirs (blue walls, bluish water), always prove to be completely fresh.*

Ice structure also affects the color of ice. Green ice consists of weakly expressed and irregularly arranged crystals (granular ice). In blue ice, the isoline structure is sharply expressed and the crystals are orientated alike. Such ice splits well along the axes of the crystals, it is more durable in a perpendicular direction, and when broken it yields an angular surface. Thus, basically, a plate of ice which had frozen under calm conditions, is blue.

The color of the ice at the initial moment of ice formation is also characteristic. Slush, brash and also thin, completely wet, ice is of dark-grey, steel color (dark-grey nilas). In ratio to the increase in thickness, the color of the ice changes to light grey (light-grey nilas), and then into white when a considerable part of the ice begins to rise above the water. Separate little ice chunks wet with water, which form during melting as a result of the disintegration of large ice floes, appear completely dark.

The color of ice colored by bacteria and plankton, concerning which more will be said later, should be investigated particularly.

As Burke correctly points out, in practice, there always exists the necessity to distinguish hard ice from the more friable ice. This can be done only with great experience, differentiating in the color of the ice sometimes by very slightly differing hues.

The change in the color of ice fields in connection with a change in weather is characteristic.

In clear weather with strong solar radiation and strong emission, ice fields turn white. The impression is created that they are covered with frost or freshly fallen snow. In overcast weather conditions, during high air temperatures, the ice turns grey and takes on dirty hues. An explanation of this phenomenon will be given in Section 115.

As a rule, the whiter the ice, the more frangible it is, but this rule has many exceptions. Sometimes very white ice is encountered and in spite of its considerable thickness a ship may pass through it easily. Thus for instance, in August 1935, when we were on the *Sadko* in the Barents Sea at 79°88' north, 33°27' east, we encountered very jumbled, frightening, but completely white 9 point ice, through which we sailed freely at a slow speed. On the other hand, dirty ice was found which was almost impossible to pass through with a vessel. An additional sign of the latter is a rounded, eroded form of ice.

LITERATURE: 23, 62, 77.

Section 72. Hardness

If ice is considered as a mineral, its hardness can be determined by the so called "hardness scale" of Mohs, i. e., by the resistance shown to scratching by a determined testing mineral (table 58).

*It should be added that another indirect sign of the use of water for drinking is a higher water level in the reservoir in comparison with the level of the sea. This sign, however, is not observed in all cases.

TABLE 58. SCALE OF MINERAL HARDNESS

1. Talc	6. Feldspar
2. Gypsum	7. Quartz
3. Calcite	8. Topaz
4. Fluorite	9. Corundum
5. Apatite	10. Diamond

The hardness of fresh ice at 0° is about 1.5; according to Koch and Wegner at -15° it is between 2 and 3, at -30° between 3 and 4, at -40° about 4, and finally, at -50°, fresh ice, according to Heim, cannot be cut by a saw, that is, its hardness is near 6.

The following observations by Badigin, conducted on the drift of the *Sedov* on 31 January 1938 during an air temperature near -40° is a characteristic example of the hardness of ice at low air temperatures.

"We saw a completely vertical wall of ice. We drew a circle (a 'bull's eye') and trained the sights of our carbines on this target. The lead bullets flattened out leaving hardly noticeable marks it proved that the ice was devilishly hard."

Burke considers that with the same temperature, the ice found at sea can be distributed in the following order according to its hardness: 1) Icebergs and fragments of them; 2) many year-old hummock ice; 3) "the tops" of hummocks formed by pressure; 4) one year old hummock ice; 5) thick smooth fields and fragments of them; 6) thin fields and fragments of them; 7) nilas ice; 8) brash ice and sludge.

LITERATURE: 11, 23, 62, 77.

Section 73. The Liquid State

The transfer temperature of a body from one state to another and therefore also the temperature of fusion, changes with a change of pressure according to Clayperon's following formula:

$$\frac{\Delta\tau}{\Delta p} = T \frac{\alpha_w - \alpha_i}{E\lambda},$$

where $\Delta\tau$ is the change in the fusion temperature,

Δp is the change in pressure,

E is the mechanical equivalent of heat,

T is the absolute temperature,

α_w is the specific volume of pure water,

α_i is the specific volume of pure ice,

λ is the heat of fusion.

Since the specific volume of water is less than the specific volume of ice, consequently, the freezing temperature decreases with an increase of pressure, in other words, the ice which has been formed melts with an increase in pressure.

When making the calculations, we find that with an increase 1 bar of pressure (or, in other words 1.02 kg/cm²) the freezing temperature decreases by 0.0074° or, in other words, the freezing temperature decreases by 1° with an increase in pressure of 134.6 bars.

The experimental data for distilled water are as follows:

Pressure in atmosphere	1	500	1,000
Pressure in bars	1.01	506.09	1,012.12
Freezing temperature.	0°.0	-4°.1	-8°.7

A decrease in the freezing temperature with an increase in pressure causes the regelation and fluidity of ice.

The regelation phenomenon consists of the fact that with each rise in pressure, the ice melts slightly and as soon as the pressure stops, it freezes together again. If a heavy object is placed on the ice, it melts the ice under it and squeezing out the water film which forms under it, it finally passes through the ice. Passing a wire with a weight tied to it through a beam of ice is a familiar experiment; and the beam of ice is, so to speak, cut through. The regelation phenomenon has a very characteristic effect on glacier ice. The ice flowing along the bed of the glacier undergoes either an increase or a decrease in pressure in turning, but due to its fluidity and the regelation phenomenon, the ice does not break. Thus, fluidity creates glacier movements, similar to river currents. If a row of pebbles is placed across a frozen river in the autumn, in the spring, these pebbles on the ice will be located in a curve convex down stream, which proves that the ice covers of rivers also "flow." All these phenomena are so characteristic that they permit a comparison of ice with a liquid which has a very high coefficient of viscosity.

Regelation appears in other instances also. Thus, under pressure of one piece of ice over another, they fuse with each other.

It should be emphasized that actually ice is the only body in nature whose cleavage can be eradicated by means of pressure under ordinary temperatures. If it is added to the fact that inside natural ice (especially during the winter the temperature is considerably lower than the freezing temperature) every crack in the ice is immediately reinforced by water which penetrates these cracks and freezes there.

Therefore, it follows that it is possible to apply to natural ice the formulas and theories based on studies of the mechanical properties of other materials only with the corresponding limitations.

LITERATURE: 25, 62.

Section 74. Mechanical Properties

We have seen that the physical properties of sea ice change sharply in connection with the conditions of its formation and are a function of its temperature, salinity, and porosity. It is clear that the mechanical properties of sea ice, i. e., its ability to resist the action of any external forces, depend on the same factors. Furthermore, this ability also depends on the duration of an action by a given force.

In spite of the great practical significance of the mechanical properties of ice, as far as I know, there have been no systematic investigations of these properties.

The numerous available observations are deficient due to the fact that in the majority of cases it is not known under what conditions these determinations had been made. And, furthermore, they are extremely contradictory. What I have said pertains to sea ice in particular.

The method of obtaining ice samples which are to undergo future investigation is a great source of error in determining the mechanical properties of natural ice.

Ordinarily, a chunk is broken off from a large ice floe and this chunk is raised on to the deck of the ship, or is sent to the laboratory. Sometimes the temperature is extremely different from its temperature at the moment it was taken, the chunk is broken up into smaller pieces from which blocks approximately 20 to 50 cm² are cut out. It is clear that during all these operations the physical properties of ice change considerably: the brine drains out of the cells, the temperature of the block changes (which causes changes in the structure of the ice), the faces of the block melt during the sawing, etc.

Another shortcoming in the existing determinations of the mechanical properties of ice is the fact that all of them unintentionally are made on comparatively small samples of ice, which by its very nature, is extremely nonhomogeneous.

Ice, like any hard body, in relation to the external forces acting upon it, can be elastic, plastic, and frangible. Changes in the form of a solid body caused by small external forces can disappear when these forces stop acting. Such changes are called elastic deformations; a solid body in such a case is in an elastic stage. With an increase in the external force above a certain amount (determined for each solid body) called the limit of elasticity--the changes in the body no longer disappear when the action of the force stops. An imprint is left in the body, so to speak, of the action exerted on it--a deformation remains. If the residual deformation is destroyed by an opposite action during the same time interval, the body is in a plastic state. If the applied force destroys the body, this body is in a frangible state.

Following Veinberg, the amount of force at which a body ceases to be plastic and is destroyed, i. e., changes into the frangible stage, we will call the limit of plasticity. Ordinarily, this force is called destructive force or breaking point.

Experiments have shown that separate crystals are plastic only on the plane perpendicular to the main axis. In other words, a crystal of ice behaves as if it consisted of a number of plates piled upon each other perpendicular to the axis and moving quite easily in relation to each other under the influence of an external force. At the same time, if the force is directed along the main axis, the ice crystal approaches in its properties an absolutely frangible body which breaks along with its deformation. As we shall see later, the elastic limit of ice, and particularly of sea ice, is extremely small, and because of this, we can consider natural ice as an extremely plastic body at high temperatures (near the freezing temperature), and at low temperatures as an extremely frangible body, which can be confirmed by the simplest observations. Inasmuch as the temperature of natural ice rises very sharply during the winter along a direction from its upper surface to its lower surface, the upper layers of the ice are frangible, the lower--plastic. Sea ice is considerably more plastic than river ice. Thus, sludge, brash ice, young ice, and generally nilas ice are distinguished by very high plasticity; scum* which is the characteristic initial form of fresh ice is very frangible. All these facts limit the application of the formulas and conclusions of the theory of the resistance of substances (based on the theory of elasticity) to natural ice.

LITERATURE: 25, 62, 77.

* *Sklianika* in Russian - Translator.

Section 75. Elastic Properties

Veinberg, who carefully collected and systematized the determinations of mechanical properties of ice which had been carried out by many investigators, and who himself had made quite a few such determinations, presents very little data on the elastic limit, namely: 0.5 (according to Fabian), 0.44 (according to Matsuyama), 0.57 (according to Veinberg for neve ice), and 0.9 (according to Veinberg for granular ice of the Hinterice glacier). All amounts are given in kg/cm².

As we shall see, the limit of elasticity of even fresh ice is so small that as Veinberg says, "the elastic stage in the conduct of ice under the action of forces can seem to present only a theoretical interest, even though the elastic constants of ice are used in solving such problems as construction of ice crossings, airplane landings on ice, etc. Such a conclusion, however, would be premature, inasmuch as it is extremely difficult to foresee which aspects of a study of ice would be important in the future." Now, in determining the thickness of a layer of glacier ice, echo sounding is used which requires a knowledge of the rate of propagation of elastic waves. The latter can be determined either by experimentation or by computations according to density and the elastic constants of ice.

The elastic constants of fresh ice, determined by various methods and by various investigators, differ greatly from each other. Thus, the modulus of elasticity, that is, the magnitude, which is the reverse of the coefficient of linear expansion of the rod when it is distended, according to Veinberg's resumé, fluctuates from 6,000 to 180,000 kg/cm², and the shearing modulus, i. e., the amount of force which rotates parallel surfaces of a body by an angle equal to one radian (57.3°) and fluctuates within the limits of 2,000 to 34,200 kg/cm².

Veinberg considers that determinations of elastic constants based on the frequency of the oscillations of the ice beams, or on the rate of propagation of explosive waves, are the most dependable. According to these determinations, the modulus of elasticity fluctuates within the limits of 49,000 to 96,000 kg/cm² and the shearing modulus fluctuates within the limits of 25,000 to 34,000 kg/cm². The most likely value for Poisson's modulus, i. e., the ratio of the relative lateral contraction to the relative longitudinal elongation when longitudinal expanding forces are applied, is considered by Veinberg to be 0.36.

As has been pointed out already, a knowledge of the elastic constants of ice is necessary to determine the thickness of glacier ice cover (by the propagation velocity of explosive waves). This method was first applied by Moths in the Alps and later by Wegener from 1929 to 1931 in Greenland. Thus, assuming the velocity of the fastest waves of the acoustic type to be 3,720 m/sec, the Wegener expedition in 1931 obtained for Greenland ice a thickness of 2500 to 2700 m above the level of the basic continental rocks buried under the ice.

In 1932-1933, the same method for measuring the thickness of continental ice was adopted by Ermoliaev on the northern island of Novaia Zemlya at which time the following results were obtained:

Thickness of ice cover up to 600 m,

Velocity of longitudinal waves up to 4000 m/sec,

Velocity of transverse waves up to 1,850 m/sec.

LITERATURE: 25, 62, 77, 113, 114, 152.

Section 76. The Influence of Temperature and Continuous Pressure

Temperature has a considerable effect on the ability of ice to undergo all sorts of deformations. This property is shown very clearly in relation to the hardness of ice.

Andrews computed the relative hardness of ice by comparing the depth of penetration of a polished rod into ice at different temperatures with the depth of penetration of the same rod into ice, the temperature of which equals 0°.

The same experiments were conducted by Royen with a solid, transparent sea ice in which the pressure in all the experiments was applied parallel to the plane of freezing. As a result of his experiments, Royen presented the formula

$$\epsilon_1 = \frac{k_1}{1 - t}, \quad (1)$$

where ϵ_1 is the relative compression,
 k_1 is the constant coefficient for a given sample,
 t is the temperature of the ice.

Table 59 was computed according to formula (1).

TABLE 59. THE PENETRABILITY OF ICE AT DIFFERENT TEMPERATURES EXPRESSED IN PERCENTAGES PENETRATION AT 0°

Temperature in °C . . .	0	1	2	3	4	5	6	7	8	9	10	15	20	30
Percentage	100	50	33	25	20	17	14	12	11	10	9	7	5	3

Komarovskii, who compared the results of Andrew's experiments (solid curve) figure 61 and the computations according to Royen's formula (dashed curve) notes there is almost complete agreement.

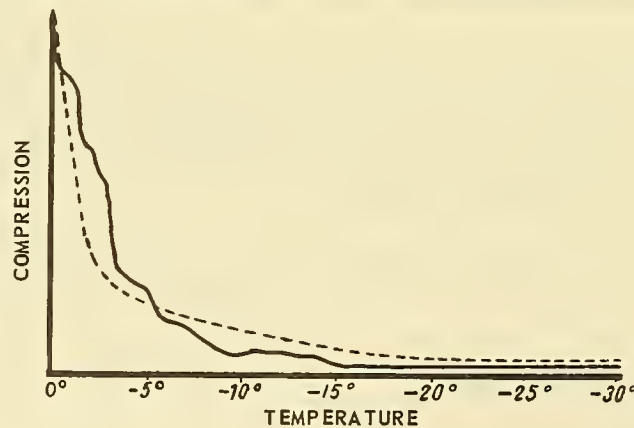

Figure 61. The compression of ice of different temperatures under the effect of constant pressure during identical periods of time according to the experiments of Andrew (—) and according to Royen's formula (---).

It becomes apparent in figure 61 that the resistance of ice to penetration increases very rapidly with a decrease in temperature to -9° C, and hardly changes with a further decrease in temperature.

As a result of investigation into the effect of continuous pressure on the deformation of ice, Royer presented the formula

$$\epsilon_2 = k_2 \sqrt[3]{T}, \quad (2)$$

where T is the duration of pressure in hours,

k_2 is the constant for a given sample of ice,

ϵ_2 is the relative deformation of the ice.

The deformation of ice also changes in connection with a change in load. In determining this dependence, Royen conducted a series of experiments with paraffin, and considering it possible to extend the obtained results to ice, offered the formula

$$\epsilon_3 = \frac{k_3 \sigma}{\sigma_b - \sigma}, \quad (3)$$

where k_3 is the constant for a given sample of ice,

σ is the compressive stress,

σ_b is the breaking compressive stress (plastic limit).

If the compressive stress is considerably less than the plastic limit, inasmuch as the limit of plasticity is constant for a given sample, this formula can be simplified and appears as

$$\begin{aligned} \epsilon_4 &= k_4 \sigma, \\ k_4 &= \frac{k_3}{\sigma_b}. \end{aligned} \quad (4)$$

Incorporating the effective temperature, duration, and the amount of load, Royen suggested the following general formula:

$$\epsilon = \frac{k \sigma \sqrt[3]{T}}{1 - t}, \quad (5)$$

where ϵ is the relative plastic deformation during compression,

k is the constant for a given sample, fluctuating during experiments within the limits of 60×10^{-5} to 90×10^{-5} ,

σ is the compressive stress in kg/cm^2 ,

T is the loading time in hours,

t is the average temperature of the ice.

LITERATURE: 25, 62, 89, 169.

Section 77. The Plastic Limit

As has already been pointed out, the plastic limit, in practice, is the most important characteristic of the mechanical properties of ice.

Actually, a knowledge of the limit of plasticity is necessary for computing the work of ice-breakers, for constructing ice-crossings and aerodromes, etc.

According to Veinberg, the average limits of plasticity of fresh ice (after they were reduced to a temperature of -3°) obtained by different investigators vary as follows:

- for compression from 12.4 to 123 kg/cm²,
- for flexure from 1.4 to 59.6 kg/cm²,
- for breaking (average of 235 tests) 11.1 kg/cm²,
- for shearing (average of 111 tests) 5.8 kg/cm²,
- for torsion (average of 9 tests) 5.1 kg/cm².

Veinberg made his reductions to a temperature of -3° according to table 60 from which it can be seen that the temperature affects the strength of ice less than as is indicated by Royen's formula.

TABLE 60. COEFFICIENTS FOR REDUCING ICE RESISTANCE TO A TEMPERATURE OF -3°

°C	0	-3	-5	-10	-15	-20	-25	-30
σ : σ^{-3} . .	0.87	1.00	1.05	1.19	1.28	1.35	1.41	1.45

As Veinberg indicates, all the values which have been presented were obtained for static loading. With dynamic loading (a blow) Nazarov obtained a limit of plasticity near 5 kg/cm² for fresh and low salinity ice.

Table 61 gives the results of certain tests of fresh ice for flexure at different temperatures; the effect of temperature can be seen very clearly from these results.

The tests of artificially prepared ice conducted by Makarov have shown that the limits of plasticity during the compression of sea ice increase with a decrease of temperature and salinity of sea ice (table 62). During the voyage on the *Sedov* in 1934, Bruns and Beriugin (the latter after his winter at Cape Zhelaniia) made large scale determinations of the limit of plasticity. For example, at this time as a result of 25 determinations of the limits of plasticity of fresh, transparent ice (composing the upper part of an ice flow) under a load directed perpendicularly to the plane of freezing proved to be, on an average, almost twice as great than under a load directed parallel to the plane. For ice, even slightly saline, the ratio of the perpendicular to parallel load decreased and approached unity for summer ice which was considerably wasted by melting. On an average, of the many hundreds of determinations of the limit of plasticity of sea ice formed during calm growth (without any sort of hummocking) this ratio proved to be 1.24 (table 63).

TABLE 61. THE LIMIT OF PLASTICITY OF ICE FOR FLEXURE IN KG/CM² AS A FUNCTION OF TEMPERATURE

Temperature in °C	Korzhavin	Whitman	Arnold- Aliabev	Veinberg
0	70	80	93	100
- 5	148	150	140	124
-10	224	190	177	140
-20	---	---	238	160

TABLE 62. THE LIMIT OF PLASTICITY FOR COMPRESSION OF VARIOUS TYPES OF ICE

Type of Ice	Temperature in °C	Limit of Plasticity in kg/cm ²
From river water	- 7.9	From 24.2 to 26.5
From river water	- 7.9	50.8
From slightly saline water	-28.75	From 17.7 to 21.6
From slightly saline water	-30	From 23.7 to 35.4
From saline water	-26.25	From 13.4 to 14.8
From saline water	-30	From 18.0 to 23.6

TABLE 63. AVERAGE LIMITS OF PLASTICITY IN KG/CM²

The Layer Depths From the Surface in cm	For Compression		For Fracture
	Perpendicular to the Surface	Parallel to the Surface	
0- 15	34.9	34.2	17.6
15- 30	41.1	35.9	19.3
30- 45	40.5	33.6	18.6
45- 60	41.9	30.4	19.6
60- 75	40.6	28.6	21.5
75- 90	43.6	32.8	23.8
90-105	48.0	38.0	22.2
105-120	46.6	34.2	--
Average	42.1	34.2	20.4

Table 63 shows the limit of plasticity for fracturing, determined for the same layers for which the limit of plasticity of compression was determined for one of the series of tests.

Each value in this table is an average of at least 100 determinations. In the majority of cases, the number of determinations was greater, and in some cases dealing with the limit of plasticity during compression, the number of determinations used in determining values in the table exceeded 300. Thus, the averages given in the lower part of the table are averages of many hundreds of determinations. The air temperature during the test was from -2° to -22°, however no obvious interrelationship between the temperature and the limit of plasticity could be established.

All of the determinations were made with samples of ice taken from shore fast ice which had not undergone any movements during the winter.

Table 64 gives the results of the limit of plasticity of sea ice in flexure, conducted by Arnold-Aliabev.

TABLE 64. LIMIT OF PLASTICITY OF SEA ICE IN FLEXURE IN KG/CM²

Temperature In °C	Minimum	Maximum	Number of Tests
- 0.3	4	8	31
- 1.0	3	6	25
- 1.7	4	8	8
- 4.4	4	14	7
- 7.0	7	10	3
- 8.0	4	16	30
- 9.0	9	13	12
-11.5	9	16	11
-18.5	10	14	3

Besides the table, Arnold-Aliabev presented the following formula

$$W_1 = 4.7 - 0.96t - 0.31t^2, \quad (1)$$

where W_1 is the limit of plasticity of ice in kg/cm².

As Arnold-Aliabev indicates, if the deviation due to ice salinity is removed, it is possible to obtain the following formula:

$$W - W_1 = 0.15 S_i - 0.34, \quad (2)$$

where W_1 is the amount computed according to formula (1), S_i is the salinity of the ice.

In the theory of resistance of materials it is considered that the effect of local faults-cracks, faults and interlayers of various sorts of sufficiently plastic substance, is reflected in a decrease of strength as well as a decrease in the cross section of the samples being tested. The same allowance can be applied to the salt cells and the air pores included in sea ice.

Arnold-Aliabev investigated 28 samples of ice from the Gulf of Finland for breakage in which the air content had been determined previously. The results of these tests are presented in figure 62 from which it can be seen that with a decrease in the air content, the limit of plasticity of ice rises considerably, varying from 10 to 25 kg/cm² at air temperatures from -5° to -7°.

According to the observations by the above author, the ice of the Barents Sea yielded a limit of plasticity during breaking of only 8 to 12 kg/cm² with a considerably greater air content (and a higher salinity) at a temperature of -5°.

Further, Tsurikov, assuming that the bubble spaces are either spherical (which, in his opinion, occurs in ice at low temperatures and porosity) or cylindrical forms (during the summer), derived a formula according to which it is possible to compute the relative decrease in the limit of plasticity of ice during breakage and compression in comparison with the same amounts for old ice. A comparison of the theoretical computations with the actual measurements yielded quite good results.



Figure 62. Limit of plasticity during breakage of ice with different air contents.

LITERATURE: 9, 25, 62, 101, 136.

Section 78. The Effect of Thickness, Temperature and Salinity on Flexural Strength

We have seen that ice has an extremely small limit of elasticity and is extremely heterogeneous along its vertical plane. Because of this, formulas based on the theory of elasticity can be applied to it only with considerable qualifications. Keeping these qualifications in mind, let us apply the formula which arises from the theory of resistance of substances to a case of flexure, namely:

$$\frac{p_1}{p_2} = \frac{h_1^2}{h_2^2}, \quad (1)$$

where p is the weight of the load placed on the ice, h is the thickness of the ice.

From formula (1) it follows that an increase in ice thickness will increase the ability of the ice to resist flexure, e. g., a 2-fold increase in thickness results in a 4-fold increase in flexural strength.

If we know from experiments the load which an ice of certain properties and thickness can support, we can, by using formula (1), compute the thickness of the ice of the same properties which would support any other load.

Thus from formula (1) Korunov arrives at the following formulas for fresh ice:

$$h = 10 \sqrt{p}, \quad (2)$$

$$p = \frac{h^2}{100}, \quad (3)$$

where h is the thickness of the fresh ice in centimeters, p is the weight of a concentrated load in tons.

It should be noted that the initial data from formulas (2) and (3) were obtained for ice whose temperature was near -10° . Tests have not yet revealed the temperature dependence of the flexural strength of ice. If one assumes that this dependence is proportional to the temperature dependence of the compressive strength, one may use Royen's formula which already has been given in Section 76:

$$\sigma = \frac{1-t}{k}, \quad (4)$$

where σ is the normal load, k is the coefficient characterizing the ice, t is the temperature.

But inasmuch as the normal loads are inversely proportional to the square of the thickness, we obtain from formula (4)

$$\frac{h_2^2}{h_1^2} = \frac{1-t_1}{1-t_2}. \quad (5)$$

It is clear that if we make use of the coefficients of formulas (2) and (3) and consider that these coefficients are obtained at an ice temperature of -9° , we obtain from formulas (2) (3) and (5):

$$h_t = h \sqrt{\frac{10}{1-t}} = 10 \sqrt{\frac{10p}{1-t}}, \quad (6)$$

$$p_t = \frac{h^2}{100} \frac{1-t}{10}, \quad (7)$$

where h_t is the thickness of the ice at temperature t , capable of supporting a load p , p_t is the weight of the load supported by the ice of thickness h and temperature t .

In actual work it is very difficult to determine the temperature of the ice, especially sea ice, since the vertical distribution of the temperature is a complex and variable curve. Because of this, it is recommended that the average air temperature for the last 10 days be used instead of ice temperature.

For sea ice of about 6 o/oo salinity and -9° temperature, I consider it possible to assume

$$h_s = 16 \sqrt{p}, \quad (8)$$

$$p = \frac{h_s^2}{250}. \quad (9)$$

It develops from the comparison of formulas (2) and (8) that winter sea ice should be 1.6 times thicker than fresh in order to support the same load.

Inasmuch as the salinity of sea ice to which I consider formulas (8) and (9) applicable, is about 6 o/oo, we can with a certain approximation write

$$h_s = h_0 (1 + 0.1 S_i), \quad (10)$$

where S_i is the salinity of sea ice.

But on an average, the salinity of sea ice is about 5 times less than the salinity of the water from which the ice had been formed. Hence it follows that the thickness of the sea ice which supports the same load as fresh ice would be equal to

$$h_s = (1 + 0.02 S) h_0, \quad (11)$$

where S is the salinity of the sea water from which the ice had formed.

In a still more rough approximation, it can be considered that for the salty ice of the white arctic and far eastern seas,

$$h_s = 1.6 h_0; \tag{12}$$

for the slightly saline ice of the Gulf of Finland, the Sea of Azov and the northern part of the Caspian Sea

$$h_s = 1.3 h_0. \tag{13}$$

Now combining the approximate formulas we obtain

$$h_{ts} = (1 + 0.1 S_i) 10 \sqrt{\frac{10 p}{1 - t}}, \tag{14}$$

$$p_{ts} = \frac{h^2}{100} \frac{1 - t}{10} \frac{1}{(1 + 0.1 S_i)^2}, \tag{15}$$

where h_{ts} is the thickness of the ice at temperature t and salinity S_i , supporting a load p . p_{ts} is the weight of the concentrated load in tons which can be supported by the ice, at temperature t and with salinity S_i , h is the thickness in cm of fresh ice, whose temperature was -9° , S_i is the salinity of the ice, and t is the temperature of the ice.

If the temperature of the ice is -15° , the salinity 5 o/oo and the thickness 50 cm, according to formula (15) we find that the load is about 21 m.

LITERATURE: 76, 91.

Section 79. Flexure of Ice Under Load

As has already been noted, ice has plasticity under comparatively small loads, bends and changes its form, but does not break.

One can walk on fresh ice 4 to 5 cm thick and sea ice 5 to 6 cm thick at which time the surface of the ice is springy underfoot. An impression is created that one is walking over tightly stretched hide. A blow on such a surface, if the ice is not broken by it, causes the formation of concentric waves on the surface of young ice.*

The flexure of ice can also be observed during tidal fluctuations of the sea level along the shores, and especially near cliffs rising out of the water. The phenomenon is expressed in the form of a concave surface during outgoing tide and a convex surface during incoming tide and the ice far from shore, bending in conformity with the incoming tidal wave, does not crack.

The flexure of ice is most clearly shown under the weight of loads placed upon it. Figure 63 shows (according to Bernstein) the sagging of ice under a railroad car on tracks laid on river ice.

*It has often been observed that when a sea wave enters a gulf or bay covered with thin, young ice, it is propagated in the form of a swell for some distance into the bay and ice 10 cm thick bends in the form of the swell.

The distance in meters from the axis of the load is plotted along the horizontal, and along the vertical, the specific "sag" is plotted which, according to Bernstein, is the ratio of the length vector of sag in mm to the weight of the load in tons.

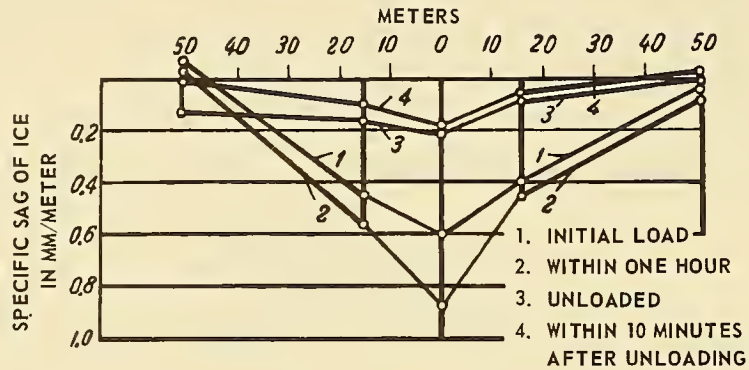

Figure 63. Ice sag under a load with time.

It can be seen from the figure that after loading, the vectors of sag increase (attaining, as Bernstein says, double and even triple amounts in the course of three hours) and then does not increase any more in the course of the following 9 to 10 hours. After unloading, the sag is very quickly almost eradicated and only a very small residual deformation remains.

Figure 64 is a graph of ice flexure on 29 January, 1942 for a 52 ton locomotive on a railroad ice crossing of the Kuznechikha River in Archangelsk.

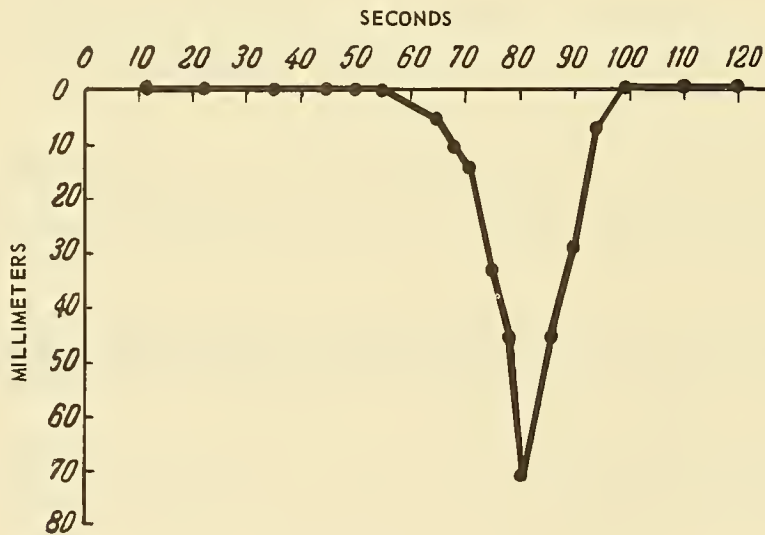

Figure 64. Ice flexure on the Kuznechikha River, 29 January 1942.

The vectors of sag in mm are plotted along the Y-axis and the time in seconds along the X-axis. The figure shows clearly the peculiarity of all flexures during motion, namely: the front incline of the curve of sag is steeper than the rear. I explain this phenomenon by the fact that during the movement of a load, inertial forces act in a direction opposite to the direction of the movement. As a result of this, ice flexure is retarded in front of the load and the straightening out of the ice is retarded behind the load.

As a result, while the load is moving, the curve of sag ceases to be symmetrical. Its front incline is steeper than the rear, and this difference is greater, the greater the velocity of the movements.

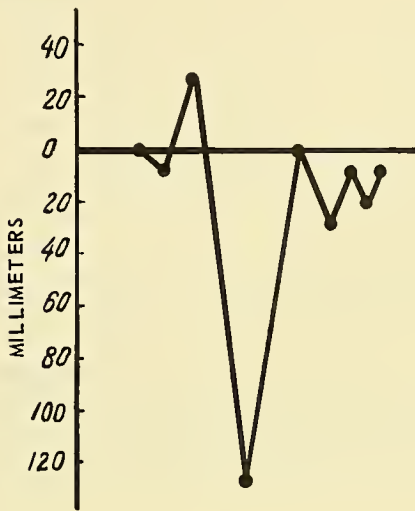

Figure 65. Oscillation of the ice on Kuznechikha River to January, 1942.

Figure 65 shows the ice sag during the 2 January, 1942 crossing of an electric train and a loaded car (total weight, 74 tons) across the same crossing. The following was recorded by a level at the time of this crossing: at first the leveling rod set up on the tracks, dropped 3 mm, then rose 28 mm, and at the instant the unit crossed it fell to 128 mm, and then after several small oscillations the rod proved to be 8 mm lower than the initial position (residual deformation). The smallest thickness of ice at the time of this crossing was 46 cm. The speed of the crossing was 15-20 km/hour.

We will notice the basic difference when we compare figures 64 and 65. The graph obtained on 29 January 1942 at a low speed of movement (about 3 km/hour) shows no oscillations in the ice; with a high speed of movement, the wave-like deflections of ice can easily be seen on the graph 2 January 1942. This phenomenon is explained by the fact that the ice deflection is transmitted by the water and the waves in the ice are a result of the waves which had formed in the water under the ice.

I consider that the wave-like deflections of the ice noted on 2 January, 1942 on the Kuznechikha River are explained, namely by this fact. The load, when moving from the shore to the ice, bends it so that a singular angled basin develops in the ice under the weight of the load. This basin, with its angular sides, is moving in space and compressing the water in its path, creates waves in the latter which in their turn, moving in space according to general laws, force the ice to bend in conformity with their shape.

It is not hard to see that with the advancing movement of the load, and consequently of the basin of deflection, ship-like waves (in eschelon, cross waves, etc.,) will be created in the water near it, which are also transmitted through the ice.

The deflection of ice under the weight of a load is ordinarily compared to the problem of the deflection of an elastic plate on an elastic foundation. But this problem presupposes uniformity of the plate and ice is extremely heterogeneous, both vertically and horizontally. The vertical distribution of temperature in natural ice is extremely peculiar and changeable, and all the mechanical properties of ice are functions of the temperature. The crux of the matter is that when solving the problem of an elastic plate on an elastic foundation it is supposed that the load does not exceed the elastic limit. But the elastic limit of ice, as we have seen, is so small that ice should be considered a plastic, frangible body. Furthermore, in practice in constructing and using ice crossings and ice airdromes, for instance, the type of ice deflection is important not near the limit of elasticity but rather near the limit of plasticity. Finally, when loads are moved on ice, the ice deflects in conformity with the "water" wave which forms under it. All these facts taken together create unusual difficulties for a mathematical analysis and make it necessary to have recourse to formulas which even though approximate, still satisfy the practical requirements.

Examining the graphs from this point of view, we see that the curves of deflection are very similar to logarithmic curves. Such a view of the curves is also supported by certain theoretical conceptions.

Actually, let us assume that the load is placed on an ice field, whose horizontal dimensions can be considered infinite (figure 66). The ice will deflect somewhat under the weight of this load whereupon the maximum deflection will be at the point of application of the load and to all sides of this point the deflection will decrease according to a certain law. In order to establish this law, I make the following recommendations:

1. After equilibrium is established the curve of deflection of the ice due to a load has no points of inflection. This assumption is completely natural, keeping in mind the properties of ice.
2. The decrease in amount of deflection from the point of application of the load in a direction toward the periphery, is proportional to the deflection at the load site and the increase in distance from the load.

The volume of the deflection, equal to the volume of the water displaced, stabilizes the weight of the load. This assumption clearly excludes certain properties of ice, but simplifies the calculations considerably.

In agreement with the second assumption we obtain

$$dz = -kzdx, \tag{1}$$

where z is the arrow vector of deflection, x is the horizontal distance, and k is the coefficient of proportionality which is called the coefficient of deflection.

After integrating, we obtained

$$z = z_0 e^{-kx}, \tag{2}$$

where z_0 is the length of the vector of displacement at the origin of the coordinate (at the point of application of the load).

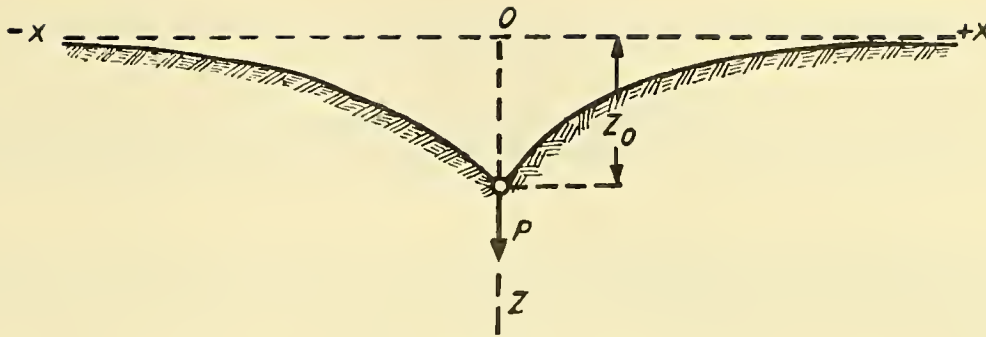

Figure 66. Ice deflection under a concentrated load.

We should remember that the curve deflection of an elastic plate on an elastic foundation is horizontal under the load, but its branches, extending into infinity are wave-like. The latter contradicts the properties of ice under a static load and the appearance of the curves obtained during observations. Actually, any displacement of ice disappears within time due to the effect of isostatic forces. On the other hand, when ice deflections are in conformity with the logarithmic curve, a sharp break of the ice under the weight itself is obtained. This fact arouses doubt as to the legality of the assumptions made. Nevertheless, I personally allow that on the lower surface of the ice, cracks might even form under the weight of the load, which is not permissible for an elastic plate, but for ice, keeping in mind its properties, is not catastrophic. Actually, the cracks which are formed are filled with water which freezes immediately on contact with the cold internal layers of the ice. But, of course, the main conclusion in favor of the suppositions made is the fact that the observed curves resemble logarithmic ones. They are all convex upwards whereas the elastic plate bends with the convex surface downward a short distance from the load.

In addition to the material which has been given, I present certain results of investigations sent to me by G. Iu. Vereshchagin which were conducted on the ice of Lake Baikal by the Baikal Station of the Academy of Sciences in 1941 and 1942. These investigations, in particular, consisted in determining the magnitudes of deflections under loads of various forms and magnitude up to loads that broke through the ice, which, understandably, is of greatest practical interest. The magnitudes of deflections were measured at 4 points on the same radius, beginning from the periphery of the load itself. The following was observed:

1. With a gradually increasing load, the magnitudes of the deflections first increase slowly and evenly, and then discontinuously with a simultaneous appearance of cracks especially near the load, and finally very rapidly just before the load breaks through the ice.
2. The magnitude of the deflections computed for a unit of distance, decreased in a direction away from the load toward the periphery.
3. When the load was first applied, a certain swelling of the ice was observed at some distance from the loads. This swelling gradually decreased with further increase in the load.
4. After the load was increased to a certain amount, the appearance of radial and concentric cracks was observed along the upper surface of the ice. The concentric cracks approximately duplicated the outlines of the load; they were circular under cylindrical loads. The cracks close to the load went all the way through before the load broke through.

5. The form and size of the breakthrough duplicated the form and size of the load almost exactly.

Vereshchagin said in his letter that the careful measurements of ice deflection under a load conducted by him on 14 January 1944 on the ice of Lake Baikal confirmed the hypothesis stated by me.

Even by the time the present book was being printed, I became acquainted with certain results of measurements of ice deflection under a load conducted by Vatalin, in February-March, 1943 in the Amurskic Liman Bay. Vatalin attempted to correlate the points of deflection he obtained, with a theoretical curve of the deflection of an elastic plate, on an elastic foundation, but this proved to be impossible. However, when Vatalin's measurements were averaged for each distance from the center of the load, surprisingly good agreement was obtained between these points and the logarithmic curve. At the same time, I was able to acquaint myself with the investigations of ice deflections along railroad and truck crossings along Severnaya Dvina conducted by Shishov at the start of 1943.

The ice deflections observed during these investigations, according to my computations, also agree well with logarithmic curves. Furthermore, it is apparent from the Vatalin and Shishov investigations that the coefficient of deflection decreases with an increase in the thickness of the ice.

Finally, it should be added that at my request, Zvolinskii rechecked the theoretic basis of ice deflection under a load and it was found that if both the elasticity and plasticity of ice are taken into consideration under known conditions of the moduli of elasticity and shear, the curve of deflection resembles a logarithm.

Thus, on the basis of available data, it is considered that the theory of deflection of an elastic plate on an elastic foundation is not applicable to the case of ice bending under a load, and that it is necessary to proceed from other premises in order to obtain a theoretical basis on this question.

In agreement with the third assumption, the maximum point of deflection is determined by the volume of the body formed by rotation around an axis OZ of a certain area: one side of the area is the axis OX , and the other is a logarithmic curve starting at the point of application of the load and leading into infinity which gradually approaches the axis OX .

The area included between the logarithmic curve and the OX and OZ axes equals

$$Q = \int_0^{\infty} z dx = \frac{z_0}{k}. \quad (3)$$

The volume of the rotating body (around the OZ axis), formed on one side by the OX axis, and on the other, by the logarithmic curves of deflection, is equal to

$$V = \pi \int_0^{z_0} x^2 dz = \frac{2\pi z_0}{k^2}. \quad (4)$$

Accepting that the density of water equals unity, and remembering that the volume of the displaced water should equalize the load, we obtain

$$P = \frac{2\pi z_0}{k^2}. \quad (5)$$

It follows from formula (5) that for the same ice (the same coefficient of deflection) the maximum point of deflection increases in proportion to the increase in weight, and that the weight of the load creating this maximum point of deflection is inversely proportional to the square of the coefficient of deflection. It is clear that the value of the coefficient of deflection is a function of the physical properties of ice and its thickness and that the smaller the coefficient the better, inasmuch as in this case, with the same maximum deflection, the ice bends more smoothly.

If we have simultaneous measurements of the deflections at 2 points located on the same line with the point of application of the load, we can easily compute the coefficient of deflection.

From 25 corresponding observations on the Volga River which I had at my disposal, I found as an average that $k = 0.1$ reciprocal meters with a maximum of 0.18 and a minimum of 0.044. A check of the obtained coefficient of deflection by means of observations conducted in the winter of 1941 and 1942 along the railroad crossing across the Kugrechikha River in Archangelsk brought about no changes.

Formula (5), however, does not take into consideration the area occupied by the load and the latter has a fundamental importance inasmuch as the greater the area over which the load is distributed, the thinner the ice may be.

Let us suppose that a rectangular load of weight p , the perimeter of which equals r and the area q , is placed on the ice. We can assume that the lines of equal deflections will pass, as shown in figure 67, namely: at the corners of the load, they will be circular arcs but along the straight lines of the contour they will be straight. The greatest deflection, understandably will travel according to the contour of the load.

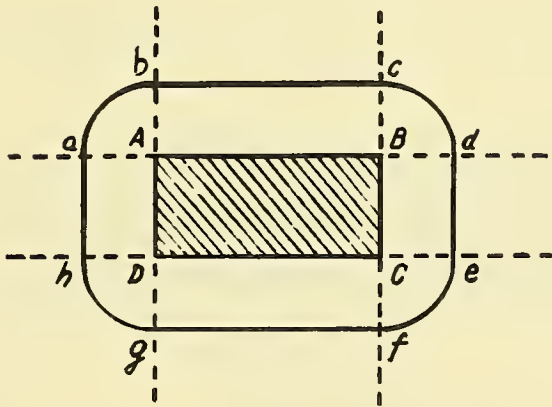

Figure 67. Isolines of ice sag around a rectangular load.

As heretofore, let us further assume that the volume of the depressed part of ice will equalize the weight. In this case the entire depressed volume will equal

$$V = \frac{2\pi z_0}{k^2} + \frac{2z_0}{k} (a+b) + z_0 ab, \quad (6)$$

$$P = \frac{2\pi z_0}{k^2} + \frac{z_0}{k} r + z_0 q,$$

where z_0 is the maximum deflection (near the contour of the load), and a and b are the sides of the rectangular load.

The first member of the right part of formula (6) represents the volume of water displaced by the load at the corner sectors and is equal to the volume displaced by a certain load P_c , concentrated at one point.

The second member is the displaced volume of water located opposite the sides of the load. It is the product of the vertical area included between the deflection curve and the starting level times the perimeter of the load.

The third member represents the displaced volume of water, located under the area of the load itself. But according to formula (5)

$$z_0 = \frac{P_c k^2}{2\pi}.$$

Substituting in formula (6) we obtain

$$P = P_c \left[1 + \frac{kr}{2\pi} + \frac{k^2 q}{2\pi} \right]. \quad (7)$$

Assuming approximately that $k = 0.1$ reciprocal meters, we obtained

$$P = P_c (1 + 0.02r + 0.002q), \quad (8)$$

where the loads are expressed in tons, and lengths in meters.

Considering the empirical relationship between the weight of the concentrated load, the thickness, the temperature, and the salinity of the ice, I obtained the following formula which had been tested in practice:

$$P = \frac{h^2}{100} \frac{1-t_i}{10} \frac{1}{(1+0.1 S_i)^2} (1+0.02r+0.002q), \quad (9)$$

where h is the thickness of the ice in cm, t_i is the temperature of the ice, and S_i is the salinity of the ice.

LITERATURE: 17, 76, 77.

Section 80. External Friction

The external friction of ice is of considerable practical interest. Arnold-Aliabev, investigating the external friction of steel against ice of various origins, sub-divided friction in the following manner:

Type of Friction	Nature of Friction
1. The friction of rest (static)	3. Dry friction
2. The friction of motion (kinetic)	4. Moist friction
	5. Self-lubricated friction

In his experiments, Arnold-Aliabev dragged chunks of ice across steel and considered that

$$f = \frac{F}{p},$$

where f is the coefficient of friction, p is the weight of the ice related to a unit of surface, and F is the weight of the load which started the given piece into motion (through a system of pulleys).

As a result of 325 tests of Neva River ice (4 samples of ice) and Baltic Sea ice (5 samples) and 375 tests of Kara Sea ice (8 samples), Arnold-Aliabev obtained the results compiled in table 65.

TABLE 65. THE COEFFICIENT OF EXTERNAL FRICTION OF WET ICE

Friction	Ice	(Neva River)		(Baltic Sea)		(Kara Sea)	
		A	B	A	B	A	B
At Rest		0.15-0.25	0.35-0.40	0.15-0.20	-	0.15-0.25	0.30-0.35
In Motion		0.10-0.15	-	0.10-0.15	-	0.10-0.20	0.20

The columns in the table deal with the following: *A* with an unpainted surface and *B* with a surface painted with red lead. The experiments were conducted under a positive air temperature and therefore the friction was moist.

The results presented in table 66 deal with experiments conducted with ice of the Baltic Sea and unpainted steel at a temperature of -5.3° ; therefore, these are the coefficients for the case of dry friction.

TABLE 66. THE COEFFICIENT OF EXTERNAL FRICTION OF DRY ICE

Friction	Coefficient
At Rest	0.30-0.50
In Motion	0.03-0.50

Arnold-Aliabev notes that in moist friction, the friction coefficient at rest is 1.5 times greater than the friction coefficient in motion, but in dry friction the ratio of these amounts reaches 10. The coefficients of moist friction for ice of various origins hardly differed from each other. Figure 68 shows the relationship of the frictional coefficient to the amount of load expressed in grams per square centimeter. Arnold-Aliabev points out that the curves of the same form are obtained for both painted and clean steel and are inherent to various ice types.

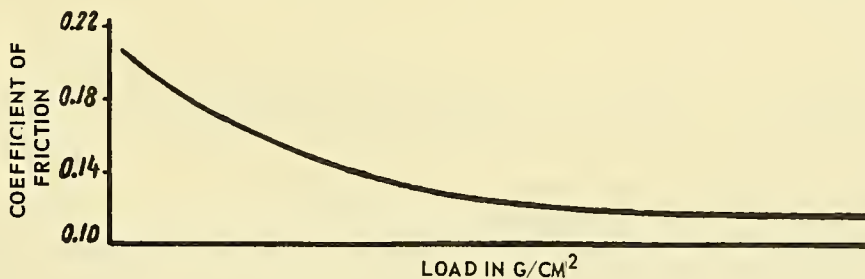

Figure 68. Curve of ice-steel friction under different loads.

When the load exceeds 120 to 130 g/cm² the friction coefficient at rest becomes almost equal to the friction coefficient in motion and with further addition of weight, hardly differs. An interesting observation was made by Alekseev in taking off an airplane weighing 5.5 tons from a snow air-drome at an air temperature of -25°. With the ski area being 3.10 x 0.70 (2.2 m²), the effort, according to the dynamometer proved to be 2.2 tons, which corresponds to a 0.40 coefficient of friction. Thus the laboratory experiments of Arnold-Aliabev are confirmed.

The fact that the external friction of moist ice is considerably less (1/2 or less) than the external friction of dry ice, explains the following phenomenon. A ship grounded on the ice and unable to get off shortly after becoming grounded, in spite of a number of adopted measures--reversed engines, rocking the ship, throwing anchors out on the ice, etc., frequently becomes free of the ice after several hours due to the action of reversed engines exclusively. The hull of the ship, especially of a metallic one, is always warmer than ice. Aside from this, the ice under the ship undergoes pressure. The combined action of temperature and pressure melts the ice at the points of contact and the dry friction becomes moist. As a result, less force is necessary to free the ship from the ice. Understandably, what has been said relates to the summer.

LITERATURE: 67, 77, 145.

Section 81. Fatigue

It is known that metallic structures loaded with fluctuating loads, under certain conditions lose their ability to withstand the deformation and are destroyed due to "fatigue." Fatigue fractures differ from the usual fractures due to deformations--breakage--and resemble the fractures of frangible substances. The deformations caused in ice by the loads transported over it also create changes in the internal structure of the ice. These deformations consist of the extrusion of brine and air bubbles from the ice which makes the ice more monolithic, and of the formation of a multitude of tiny though noticeable cracks in the ice which weaken it. As compared with metals, ice at usual temperatures possesses exceptional properties: plasticity, fluidity, and the ability to regelate. In connection with this, after the pressure ceases, the weakening of the ice is compensated for by a more rapid formation of ice near the more dangerous cracks, i. e., cracks completely through and nearly through and the ice gradually re-establishes its mechanical properties, which is impossible for metals. Thus, the term "aging" is more applicable to metals whereas the term "fatigue" is more applicable to ice.

Hence, the movement of heavy machine loads over ice should be curtailed regularly for a certain period of time when heavy use is being made of the ice crossing use.

LITERATURE: 67.

CHAPTER VI

ICE ACCRETION

Section 82. The Centers of Freezing

All observers are amazed by the speed with which the initial forms of ice appear on the surface of the sea after the water reaches the freezing point. At several degrees below freezing, only a few hours are required for the ice sludge to extend as far as the eye can see; after several more hours, the sludge turns into nilas, or pancake ice.

However, the surface layers of the sea never cool to the freezing point simultaneously over the entire sea. For one reason or another, such cooling ends in certain areas earlier than in others, and then from these areas, as from centers of freezing, it expands in all directions but not at the same rate.

When making theoretical estimates of the position of these centers of freezing, one should consider first the distribution, at the given moment, of the freezing indexes in the sector of the sea under investigation, and secondly, the rate of cooling of the sea.

As we have seen, by freezing index, we mean the amount of heat released by 1 square cm of sea surface on cooling to the freezing point. In the given instance, let us use the term "rate of cooling" to indicate the decrease of the freezing index per unit time, as a function of meteorological conditions during the pre-winter period.

It is clear that the time interval prior to the appearance of the initial forms of ice will be

$$T_{\tau} = q_{\tau} : \frac{dq_{\tau}}{dT},$$

where q_{τ} is the freezing index and dq_{τ}/dT is the rate of cooling.

If we were to compute the intervals of time prior to freezing for some moment at points equally distributed over the area of the sea, and then draw isolines of time (isochrones), the centers of freezing would be located at the points where the time interval before freezing is minimum.

From the formula, it follows that the periods of time before freezing, are the smaller, the lower the freezing index and the higher the rate of cooling, but, of course, even high freezing indexes can be quickly destroyed in the presence of a high rate of cooling.

As we have seen, other conditions being equal, the freezing index is the smaller, the shallower the location, the lower the temperature of the sea, and the greater the vertical salinity gradient which limits the distribution of vertical winter circulation. Thus, it can be considered that, generally, the freezing index is smaller in shallow water, especially offshore (slight depth), at high latitudes and near ice massifs (low water temperature), near the estuaries of rivers and near ice massifs (high vertical salinity gradients).

The rate of cooling is generally greater, the greater the temperature difference between water and air. As we have seen, this difference is very small in the open sea and reaches its greatest values near shore and ice massifs, when the winds are offshore or off the ice. Hence, the highest rate of cooling should be expected near shore during offshore winds (the land cools faster than the sea in the pre-winter period) and near the edge of the ice with a wind off the ice.

By comparison, we find that, other conditions being equal, ice formation at sea begins earliest in the high latitudes (large difference in the air and water temperatures) near the edge of the ice, especially during an off-ice wind and amidst ice which had melted during the summer (high salinity gradient and low water temperature), near shore (shallow water), and near river estuaries (shallow water, high salinity gradient and a higher freezing point as compared with sea water).

As observations have shown, the freezing dates in different regions of the Soviet Arctic vary from year to year within extremely broad limits. As a rule, freezing begins first in the region near the Lena in the New Siberian Straits (about the middle of October), in Vilkitskii Strait (in the second ten days of October), and, after this, the wave of freezing spreads from these regions in both directions to the east and west along the coasts.

This picture of freezing is particularly characteristic during years with little ice. In years with much ice, freezing which spreads from the ice aggregates that still remain at the end of summer predominates, and at first, the freezing is centered in these aggregates. The floating floes are fused very quickly by young ice, and turn into solid ice massifs which are almost impassable, even for vessels especially adapted for navigation through ice. This last factor has created a rule among arctic men; vessels which have not departed from the ice prior to the start of freezing risk remaining in the ice for the winter.

The freezing of the Soviet Arctic seas was clarified in 1943 by very late reconnaissance flights and proved to be quite unique. For example, on 26 October, the Laptev Sea was still completely free of ice between $75^{\circ} 30'$ north and 120° east, and 77° north and 110° east. It should be remembered that this same region was the first to be clear of ice in the spring of 1943. On 30 October, during reconnaissance along the 130th meridian up to $81^{\circ} 30'$ north, no old ice was observed and the entire sea was covered by solid ice without any polynyas or hummocks. In spite of quite strong winds. A strip of clear water, discovered by a reconnaissance flight on 25 October, was covered with gray nilas. According to the aerial reconnaissance of 31 October, the entire Kara Sea north of 72° north was covered by level young ice also without polynyas or hummocks.

LITERATURE: 62, 77, 73.

Section 83. Ice Thickness as a Function of Air Temperature

After the surface of the sea is covered by a continuous ice cover, further ice accretion from below, during calm conditions, takes place exclusively due to heat conductivity through the ice and the snow cover and can be computed to some extent.

Weyprecht conducted the first systematic observations of sea-ice growth due to heat conductivity during a winter in Franz Joseph Land (1873-1874). From these observations, Weyprecht gave the relationship between the number of freezing degree-days, i. e., the sum of the mean daily negative air temperatures, and the thickness in centimeters of the ice which had formed.

Weyprecht took the numbers in his table from an averaged curve obtained from observations at three points and extrapolated for higher values. Weyprecht's data, recomputed from the Reaumur to the centigrade scale, are given in table 67.

TABLE 67. ICE THICKNESS VS. THE NUMBER OF FREEZING DEGREE-DAYS
(ACCORDING TO WEYPRECHT)

Freezing degree days	500	1000	2000	3000	4000	5000	6000	7000	8000
Ice thickness in cm	51	80	115	145	170	189	208	222	237

The question of ice formation due to heat conductivity was later developed theoretically by Stefan.

The elementary amount of heat released by the water to the air per unit area of ice in time dT , will be

$$\frac{k\theta}{i} dT,$$

where i is the ice thickness, k is the heat conductivity of ice, and θ is the temperature difference between the lower and the upper surfaces of the ice.

This elementary amount of heat is expended on the formation of an additional ice layer di thick. Thus

$$\frac{k\theta}{i} dT = \lambda\delta di, \quad (1)$$

where λ is the heat of crystallization, and δ is the ice density. Integrating, we get

$$k \int_0^T \theta dT = \lambda\delta \int_0^i i di,$$

$$\int_0^T \theta dT = \frac{\lambda\delta i^2}{2k}. \quad (2)$$

If we assume that the temperature difference between the upper and the lower surfaces of the ice remains constant for the time interval T , formula (2) assumes the form

$$R = \theta T = \frac{\lambda\delta i^2}{2k}. \quad (3)$$

All the values in this formula are given in the CGS system. It is more convenient to compute the time in days, as Weyprecht did. For this, we get

$$R = \frac{\lambda\delta i^2}{2 \cdot 86,400 k}, \quad (4)$$

where 86,400 is the number of seconds in 24 hours.

If we set $k = 0.005$ in formula (4), we obtain

$$R = \frac{i^2}{12}, \quad i = 3.5\sqrt{R}.$$

Stefan also recommended that this expression be used for practical purposes.

I computed table 68, setting $\lambda = 80$ g-cal/g and $\delta = 0.9$ in formula (4).

TABLE 68. NUMBER OF FREEZING DEGREE-DAYS REQUIRED TO FORM ICE i CM THICK, WITH DIFFERENT HEAT CONDUCTIVITY VALUES

k \ i	5	10	25	50	75	100	150	200	300
0.002	5	21	129	517	1,164	2,070	4,657	8,280	18,620
0.003	4	14	87	347	781	1,389	3,125	5,555	12,492
0.004	3	10	65	260	586	1,042	2,344	4,166	9,374
0.005	2	8	57	208	468	833	1,871	3,333	7,500

As is known from observations, the temperature of the ice surface differs little from the air temperature, while the temperature of the lower ice surface is equal to the temperature of the water in which the ice forms. Thus, we can consider the value R , which enters into formula (4), as the sum of the negative air temperatures, or, actually, the number of degree-days.

As Stefan himself admitted, his formula is not entirely accurate. It presupposes that the vertical temperature gradient in the ice is constant, whereas the temperature changes considerably faster with depth in the upper layers of the ice than in the lower layers. Further, at the beginning of spring, the air temperature, remaining negative, can be higher than the temperature of the middle layers of the ice. In such a case, the heat of crystallization of the ice layers accreting from below will be expended on warming the middle layers of the ice and will not be transferred to the atmosphere. Taking this into consideration, Stefan gave a second theoretical formula, namely:

$$\int_0^T \theta dT = \frac{\lambda \delta i^2}{2k} \left(1 + \frac{c\theta'}{3\lambda} \right), \quad (5)$$

where c is the specific heat of ice and θ' is the temperature of the ice surface at the end of time T .

This formula is also approximate, inasmuch as the expression in parentheses gives only the first two terms of the series expansion. However, Stefan recommended that this formula be used for spring, although he notes that the specific heat of ice is low compared with the heat of crystallization and, consequently, the second term of the expression in parentheses is small compared with the first. Stefan's first and simpler formula can be used to draw general conclusions if we keep in mind that many of the conditions accompanying ice formation at sea cannot be calculated.

Furthermore, it should be kept in mind that the rate of ice accretion in nature is a function not only of negative air temperature, but also of other conditions, such as solar radiation, atmospheric humidity, wind, amount of snow on the ice surface, the magnitude of oceanographic gradients beneath the lower surface of the ice, the presence or absence of sea currents, etc. Consequently, many authors have followed the course indicated by Weyprecht; namely, the establishment of empirical relationships. The empirical formulas of Baker, Barnes, Bydin and others are examples of this.

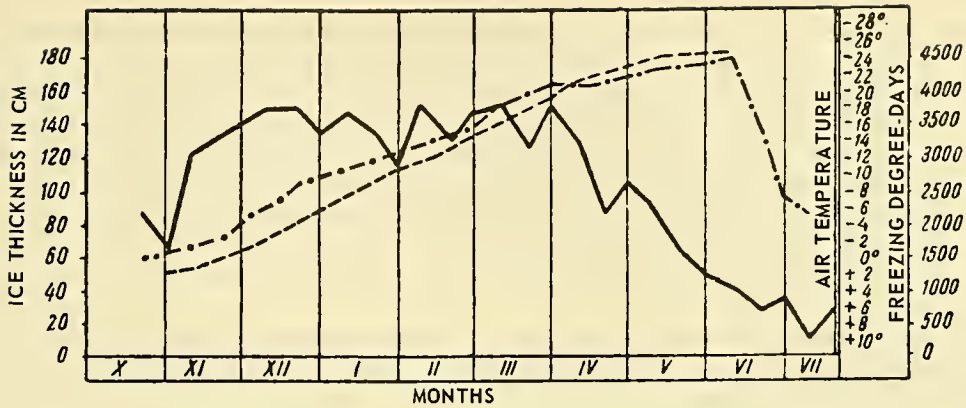

Figure 70. Air temperature (—), number of freezing degree-days (---) and ice thickness (·—) near Cape Schmidt in the Chuckchee Sea during the winter of 1936-1937.

I obtained the following formula by processing the observations of ice formation on Uyedine-niye Island (Ostrov Uyedineniye) during 1935-1936 and on Cape Schmidt (Mys Schmidt) during 1936-1937 (figure 70) and by using the available observations made by certain other polar stations as a control:

$$i^2 + 50i = 8R, \tag{6}$$

Formula (6) pertains to average conditions. As we shall see further, the thickness of ice accretion depends not only on the number of freezing degree-days, but also on the thickness and density of the snow, and also on the time when the given snow cover formed, on the distribution of temperature and salinity beneath the ice, on the presence or absence of sea currents, and on many other factors.

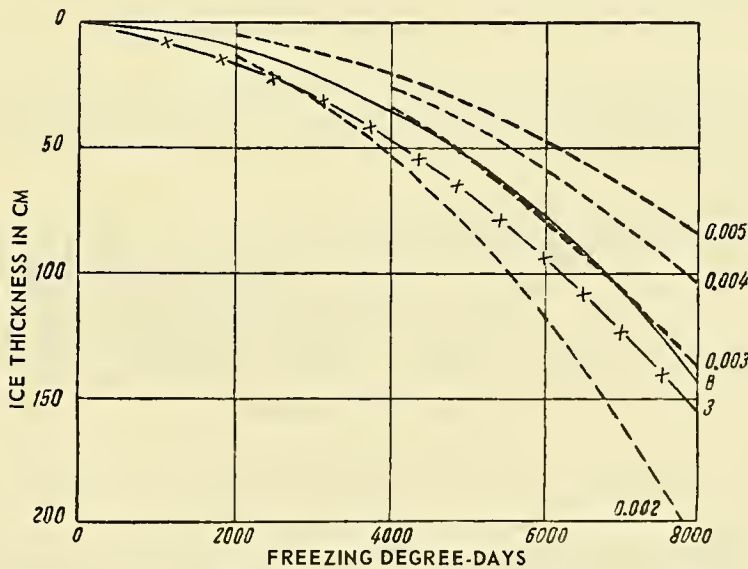

Figure 71. Ice thickness vs. number of freezing degree-days.

Figure 71 gives curves of the thickness of year-old ice as a function of the number of degree-days computed according to Stefan's formula, if we take the heat of crystallization as 80 g-cal and ice density as 0.9. The curves were constructed for heat conductivities of ice equal to 0.002, 0.003, 0.004, and 0.005 g-cal sec⁻¹ degrees⁻¹ cm⁻¹. The same diagram shows both Weyprecht's and my empirical curves. It can be seen from the figure that the empirical formulas agree surprisingly well with Stefan's theoretical curve, if we assume in the latter that the heat conductivity is 0.003, or more correctly, if we assume that Stefan's formula is of the form

$$R = 0.14 i^2. \quad (7)$$

Formula (6) was used for further deductions. When dealing with considerable ice increments, from (6) we get

$$(i_0 + \Delta i)^2 + 50(i_0 + \Delta i) = 8(R + \Delta R), \quad (8)$$

whence

$$\Delta i^2 + (50 + 2i_0) \Delta i = 8\Delta R, \quad (9)$$

$$\Delta i = -(25 + i_0) + \sqrt{(25 + i_0)^2 + 8\Delta R}, \quad (10)$$

or, since $i = i_0 + \Delta i$

$$i = -25 + \sqrt{(25 + i_0)^2 + 8\Delta R}, \quad (11)$$

where Δi is the increment of ice which was i_0 thick at the initial moment, ΔR is the number of degree-days which had accumulated from the moment the ice became i_0 thick.

TABLE 69. ICE INCREMENT IN CM PER 24 HOUR WITH A GIVEN NEGATIVE AIR TEMPERATURE (MEAN DAILY) AND A GIVEN INITIAL ICE THICKNESS IN CM

$i_0 \backslash t^\circ$	-5	-10	-15	-20	-25	-30	-35	-40
0	0.8	1.6	2.4	3.2	3.8	4.7	5.5	6.3
10	0.6	1.1	1.7	2.3	2.9	3.4	4.0	4.6
20	0.4	0.9	1.3	1.8	2.2	2.6	3.1	3.5
30	0.4	0.7	1.1	1.5	1.8	2.2	2.6	3.0
40	0.3	0.6	0.9	1.2	1.5	1.8	2.1	2.4
50	0.3	0.5	0.8	1.1	1.3	1.6	1.9	2.1
75	0.2	0.4	0.6	0.8	1.2	1.4	1.6	1.8
100	0.2	0.3	0.5	0.6	0.8	1.0	1.1	1.3
150	0.1	0.2	0.3	0.5	0.6	0.7	0.8	0.9
200	0.1	0.2	0.3	0.4	0.4	0.5	0.6	0.7

I computed table 69 on the basis of formula (10).

It can be seen from this table that daily ice accretion beneath quite thick ice is very slight even with very low air temperatures, but it is comparatively great on an ice-free sea surface. As a result, young ice forms and accretes very rapidly in polynyas and cracks when the air temperatures are very low and in individual cases, the values can be considerably higher than those in the table. Nansen noted that once he observed ice that became 8 cm thick overnight, 15 cm thick in the first three days, and 40 cm in 15 days. This should be explained by the fact that ice formation in narrow cracks is promoted not only by low air temperature, but also by the low temperature of the adjacent parts of the ice.

The fact that the accretion of thin ice occurs considerably faster than that of thick ice is exploited along the arctic coast in repairing the underwater parts of vessels by freezing the vessel out, i.e., by constructing "ice docks." To do this, the snow surrounding the vessel to be repaired is first removed, which increases ice growth considerably, as we shall see below. Then, when the ice becomes 50 to 60 cm thick, it is chopped away such that a strip of ice not more than 30 cm thick always remains around the ship. Understandably, the underwater part of the vessel becomes more and more exposed with time. This continues until repairs are possible. Wooden braces are placed around the ship to give it stability. By the end of January 1943, the ice dock in Tiksi Bay, for example, was already 3 m deep (while the thickness of the natural ice was about 180 cm).

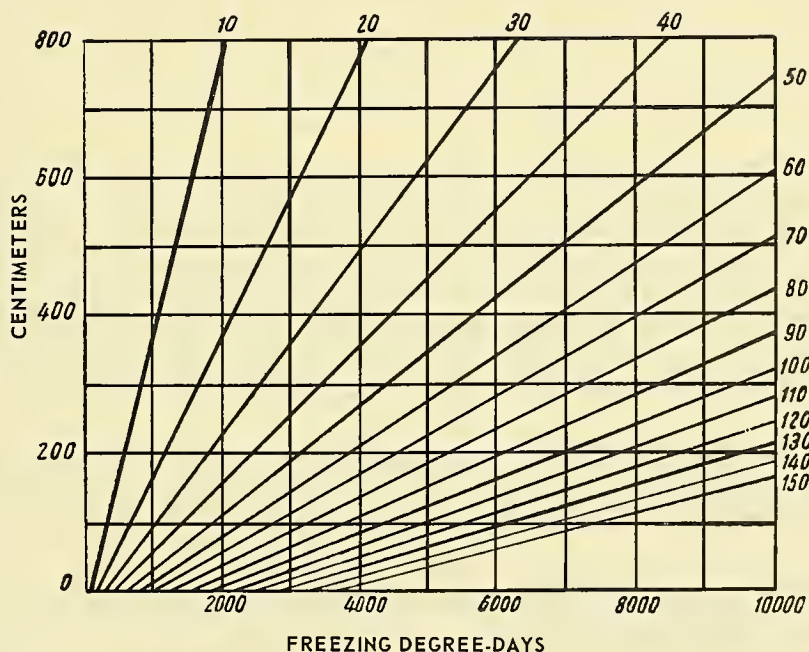

Figure 72. Graph for computing the ice increment vs. number of freezing degree-days.

I constructed the graph (figure 72) from formulas (6) and (10). The initial ice thickness in centimeters is plotted on the Y-axis and the number of freezing degree-days on the X-axis. The slanted lines represent the isolines of ice increment in centimeters. The graph is easy to use.

For example, if we wish to determine how many centimeters 100 cm-thick ice will accrete if it is subjected to 6000 freezing degree-days, we start along the graph horizontally at the number 100 and vertically at the number 6000, we find that the line of increment at the intersection will be 127 cm, which will be the answer to the question asked.

It is clear that the given formulas, table and graph cannot pretend to be highly accurate.

TABLE 70. THICKNESS OF THE ICE AND SNOW AND ELEVATION OF THE ICE SURFACE ABOVE SEA LEVEL IN CM, DICKSON BAY, END OF FEBRUARY, 1944

Ice	%	Snow	%	Elevation	%
From 81 To 90	0.5	From 0 To 10	11.5	From 11 To 15	3.7
From 91 To 100	15.0	From 11 To 20	14.9	From 6 To 10	11.5
From 101 To 110	35.0	From 21 To 30	26.4	From 1 To 5	19.8
From 111 To 120	25.2	From 31 To 40	27.6	0	9.9
From 121 To 130	15.0	From 41 To 50	14.1	From -1 To -5	34.6
From 131 To 140	5.0	From 51 To 60	4.3	From -6 To -10	17.5
From 141 To 150	2.6	From 61 To 70	1.2	From -11 To -15	2.5
From 151 To 160	0.7			From -16 To -20	0.5
From 161 To 170	0.5				
Average 112		26		-0.8	

Table 70 gives the results of an ice-measuring survey conducted in Bukhta Dikson at the end of February 1944 by Treshnikov, Subbotin and Sychev. Observations were made at 438 points, at which time the ice thickness, snow depth and the height of the ice surface above sea level were measured (the minus sign indicates that the ice surface was below the water level). In addition, the table gives the frequency percentages which I computed. Since the measurements were made at equidistant points, these same percentages characterize the areas occupied by the given values. The data in the table show how great the fluctuations of ice and snow thickness are, even at close distances, and how dangerous it is to draw conclusions from isolated measurements.

Further, it is interesting to note that the observations of the growth of ice of different ages, made during the drift of the *Sedov*, are an excellent confirmation of the applicability of formula (6). This is apparent from table 71.

It should be noted that formula (6) applies not only to the accretion of ice which is already quite thick, but also to the formation of new ice.

Thus, for example, if we consider that the ice observed by the *Sedov* (1938-1939) began to form on 1 September 1938, it should have been 110 cm thick according to formula (6) by 16 January 1939, when the number of freezing degree-days (counting from 1 September) had reached 2,190. As can be seen from table 71, the measured thickness of this ice was 107 cm.

TABLE 71. THICKNESS OF LEVEL ICE IN CM, MEASURED DURING THE DRIFT OF THE *SEDOV* IN 1939

Date of Measurement	Freezing Degree-Days	Thickness of Ice Formed in 1936-1937		Thickness of Ice Formed in 1937-1938		Thickness of Ice Formed in 1938-1939				
		Observed	Computed	Difference	Observed	Computed	Difference	Observed	Computed	Difference
1/16	-	159	159	0	130	130	0	107	107	0
1/20	114	163	162	1	137	133	4	118	110	8
2/4	686	171	173	-2	149	147	2	135	126	9
2/23	1,264	182	185	-3	162	160	2	152	141	11
3/1	1,432	183	188	-5	163	163	0	155	145	10
3/10	1,809	189	195	-6	170	171	-1	163	154	9
3/20	2,123	196	200	-4	176	177	-1	170	160	10
3/31	2,578	198	208	-10	182	186	-4	179	170	9
4/10	2,850	204	213	-9	188	190	-2	185	176	9
4/20	3,101	208	217	-9	192	195	-3	192	180	12
4/30	3,313	211	221	-10	196	200	-4	197	185	12
5/10	3,447	214	223	-9	198	202	-4	201	187	14
5/20	3,588	216	225	-9	201	205	-4	204	190	14
5/31	3,722	218	227	-9	202	207	-5	206	192	14
6/10	3,758	218	228	-10	204	208	-4	207	193	14
6/20	3,777	218	228	-10	204	208	-4	207	193	14
6/30	3,791	222	228	-6	205	208	-3	207	193	14

These examples show that formulas (6) and (10) could be extended to the entire Arctic Basin with a certain approximation. This is very important since it is a very laborious task to determine ice thickness under polar conditions and it is very easy to compute the number of freezing degree-days.*

It should merely be emphasized that formula (6) is applicable only under more or less calm hydrological conditions. For example, the ice in river rapids is always thinner than in calm stretches, and in certain rivers the rapids sometimes do not freeze at all during the entire winter. Such phenomena can also be observed in transverse ice survey profiles. The ice is always thicker at some points than at others. This is explained by the alluvial and erosional action of the current, which causes accretion and erosion of the ice along the lower surface of the ice cover in a manner quite similar to and according to the laws by which these same streams distribute suspended soil particles on the bottom of the river.

Figure 73 shows the ice survey profile through the Severnaya Dvina near Solombala, made on 9 December 1941. In the figure, attention is focused on the rafted floes near the shores and near the path made by the icebreaker and an accumulation of sludge ice 400 m from the right bank which had no apparent cause. Undoubtedly, such an accumulation was caused by a convergence of current streams at this point, and, as a result, by a certain deceleration.

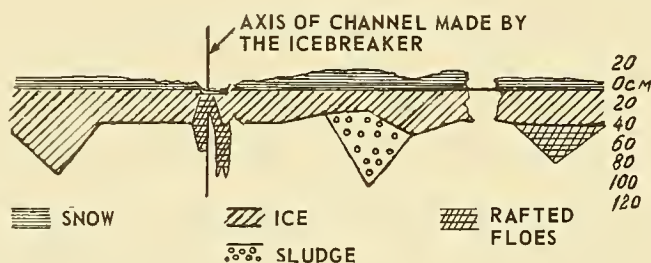

Figure 73. Ice survey profile through the Severnaya Dvina.

These same phenomena are observed at sea in areas of strong tidal currents. For example, in the narrowest part of Matochkin-Shar, near Cape Uzkii (Mys Uzkii), where the tidal currents reach a speed of five knots, the middle part of the strait freezes only during the most severe winters. It is clear that in such cases, special "local" formulas should be worked out for the relationship between ice thickness and the number of freezing degree-days. Furthermore, it is clear that, in general, in order to apply formula (6), freezing degree-days should be counted from the moment ice appears in a given region and never from the initial moment of negative air temperatures.

The number of freezing degree-days varies within wide limits from year to year at each separate point of the arctic, and of course this affects the thickness of the ice formed during a given winter in a given region. For example, during the period 1921 to 1936, the maximum number of freezing degree-days on Dickson Island (Ostrov Dikson) was 4,780 (in 1927-1928) and the minimum was 3,595 (in 1931-1932); the difference was about 25 per cent of the maximum value.

*These formulas were checked by the Hydrometeorological Institute for the White and Caspian Seas and were found to be completely satisfactory.

TABLE 72. COMPUTED ICE THICKNESSES FOR DICKSON ISLAND

Month \ Year	Year															Average	Difference
	1921-1922	1922-1923	1923-1924	1924-1925	1925-1926	1926-1927	1927-1928	1928-1929	1929-1930	1930-1931	1931-1932	1932-1933	1933-1934	1934-1935	1935-1936		
October	17	32	-	16	22	19	21	-	-	30	9	-	22	20	24	17	32
November	43	59	43	41	67	53	63	33	35	48	38	49	63	49	55	49	34
December	79	86	76	74	88	83	95	67	69	84	69	86	89	89	82	80	28
January	104	110	108	96	112	113	118	100	91	115	93	110	113	110	114	106	37
February	130	128	125	116	138	129	134	120	119	126	114	128	126	124	136	128	24
March	149	150	141	138	151	146	154	141	140	147	134	148	143	143	154	145	20
April	157	162	156	151	162	158	167	154	152	161	143	158	156	159	163	157	24
May	162	172	158	158	172	130	173	161	157	166	147	165	160	162	168	163	26
Observed	-	-	134	142	200	162	153	139	163	140	176	184	-	-	-	159	-
Difference	-	-	24	30	-40	11	8	18	3	7	-11	-24	-	-	-	-	-

Table 72 shows the thickness of ice accretion at Dickson Island, computed from formula (6), according to the number of freezing degree-days at the end of each month from 1921 to 1936. The next to the last column of the table shows the averages for the investigated period, and the last column, the difference between the maximum and minimum values. It is interesting that while the difference between the maximum and minimum numbers of freezing degree-days reaches 25 per cent, the difference between the extreme ice thicknesses is only 15 per cent. This is explained by the fact that the rate of accretion is the slower, the thicker the ice.

The next to the last line on the table shows the maximum observed ice thickness for individual years, and the last line, the difference between the observed and computed values. The sign of these differences varies, and their absolute sum is not great; this proves that the formula adopted for the computations is correct and that the reasons for these differences are not systematic. The most important of these is the fluctuation of the depth of the snow cover.

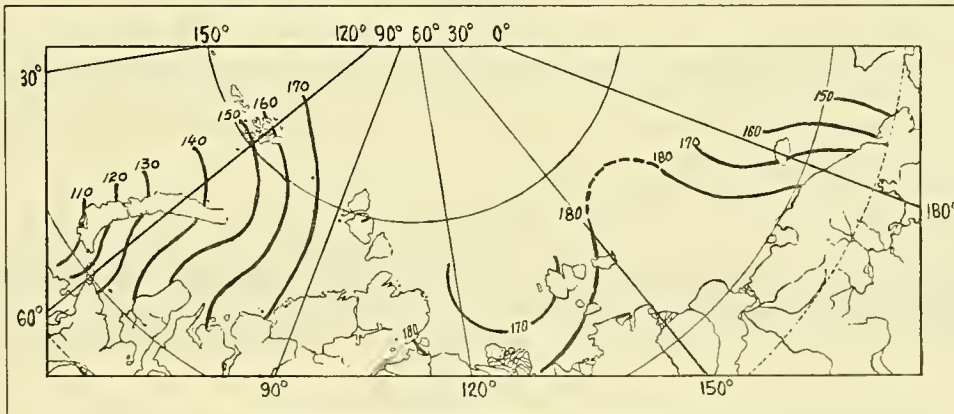

Figure 74. Isolines of the thickness of ice accretion for the winter of 1938-1939 in (cm).

Figure 74 shows the isolines of ice thickness in the seas of the Soviet Arctic, computed by formula (6) for the winter of 1938-1939. As can be seen from the figure, accretion ice reaches its maximum in the East Siberian Sea.

During the expedition on the *Fram*, Nansen found 7662 freezing degree-days for the winter of 1894-1895, which, according to formula (6), corresponds to 224 cm of ice. Evidently, these values are nearly maximum for the east longitudes of the Arctic Basin.

LITERATURE: 62, 77, 87, 88, 107, 172, 177.

Section 84. Ice Accretion as a Function of the Vertical Distribution of Temperature and Salinity Beneath the Ice

We have seen that neither Stefan's theoretical formula which reduces to

$$R = \frac{1}{2 \times 86,400} \frac{\lambda \delta_i}{k} i^2, \quad (1)$$

where R is the number of freezing degree-days, λ is the heat of crystallization, δ_i is the ice density, k is the heat conductivity of the ice and i is the ice thickness in centimeters, nor any of the empirical formulas consider the vertical distribution of temperature and salinity beneath the ice. In other words, in all the formulas it is assumed that all the heat transmitted through the ice to the atmosphere is produced solely by the heat of crystallization.

Let us assume that we have a fresh-water lake in which there is no movement of water and, consequently, no frictional mixing. In first approximation, let us ignore the molecular processes in the water. Further, let us assume that prior to the initial cooling, the temperature of the lake was somewhat higher than the temperature of the greatest density, i. e., 4° . After the temperature of the lake from the surface to the bottom drops to 4° , all convective phenomena in the lake will cease, and ice formation will start after the uppermost, thinnest layer cools to 0° . From this moment on, we can apply Stefan's reasoning to what follows, after augmenting it somewhat, namely: the elementary amount of heat released to the atmosphere in time dT through a unit area of ice of i thickness is

$$dq = \frac{k\theta}{i} dT, \quad (2)$$

where θ is the difference between the temperatures of the upper and lower surfaces of the ice.

This elementary amount of heat should be equal to the sum of the heat released during the formation of an additional layer of ice and it is

$$\lambda \delta_i di, \quad (3)$$

and of the heat released during the cooling of a column of water dh -high from 4° to 0° , from which an additional column di -high forms, and it is

$$4^\circ c_w dh = 4^\circ c_w \frac{\delta_i}{\delta_w} di, \quad (4)$$

where c_w is the specific heat of water and δ_w is the density of the water. Thus

$$\frac{k\theta}{i} dT = \left(\lambda \delta_i + 4^\circ c_w \frac{\delta_i}{\delta_w} \right) di. \quad (5)$$

Following the reasoning of the preceding section, we obtain,

$$R = \theta T = \left(\lambda \delta + 4^\circ c_w \frac{\delta_i}{\delta_w} \right) \frac{i^2}{2k}. \quad (6)$$

Substituting $\lambda = 80$ g-cal, $\delta_i = 0.9$, $\delta_w = 1.0$ and $c_w = 1.0$ in (6), we obtain

$$\theta T = (72 + 3.6) \frac{i^2}{2k}. \quad (7)$$

As can be seen from (7), under the conditions of the problem posed, the supplementary term that I introduced into Stefan's formula is comparatively small. However, if we assume that on cooling to 0° , the lake water, prior to the appearance of the first ice, will be mixed by the wind to a depth greater than the thickness of the ice, the supplementary term in formula (7) will naturally become 0.

Naturally, it can also be assumed that in the sea, the upper layer of water which exceeds (sometimes considerably) the maximum possible ice thickness will be mixed and cooled to the freezing point by the time the first ice appears. In the sea, however, ice formation involves salinification of the upper layer and subsequently, convective mixing to a depth which depends on the vertical temperature and salinity distribution. Thus, in the sea, the supplementary term in formula (7) will be zero only in shallows, where the water is cooled and mixes to the bottom and in regions where the density of the upper layer differs so much from that of the lower layers that its salinification occurring during ice formation does not cause convective mixing, which would involve new layers in the vertical circulation.

Now let us apply our discussion to a stratified sea. Let us assume that the entire upper layer is mixed to a certain depth at the moment the sea is cooled to the freezing point. In this case, ice formation will first occur according to formula (1).

If the upper layer is sufficiently thick and if its salinity is considerably less than that of the lower layers, with the given number of freezing degree-days, in the region under investigation, the entire process of ice formation could be limited to this layer, and formula (1) would be sufficient to characterize the phenomenon. However, if the first layer is thin, the vertical circulation can include the second and deeper layers. In the latter case, the phenomenon described by formula (1) will continue only until the salinification accompanying ice formation raises the density of the upper layer to the density of the layer second from the top.

The vertical distribution of oceanographic characteristics below the first layer can be quite diverse, but there can be no inversion of density and salinity; however, a temperature inversion, particularly under arctic conditions, is usual. Let us assume, for the sake of simplicity, that all the lower-lying layers are quite thick and that each of them, taken separately, is uniform. In such a case, after the density of the upper layers becomes equal to the density of the second layer, the heat released to the atmosphere by a unit of ice surface during time dT will, as before, be equal to

$$\frac{k\theta}{i} dT,$$

where i is the thickness of the ice formed before the density of the first layer became equal to the density of the second layer. However, this heat will now be released due to cooling of the second

layer (which is p_2 thick), not due to the heat of crystallization evolved during the formation of additional layers of ice. Thus we will get

$$\frac{k\theta}{i_1} dT = c_w \delta_w p_2 dt. \quad (8)$$

Integrating, we get

$$\frac{k\theta}{i_1} \int_0^T dT = c_w p_2 \delta_w \int_t^\tau dt$$

or

$$\theta T = \frac{c_w p_2 (t - \tau) i}{k 86,400}, \quad (9)$$

where τ is the freezing point.

If the thickness of the ice which has formed is known, the amount of heat released to the atmosphere by 1 square cm of ice surface due to crystallization can be computed according to

$$q_i = \lambda \delta_i i. \quad (10)$$

Since this heat is proportional to ice thickness, which increases parabolically with time, it is clear that the rate of heat release to the atmosphere will gradually decrease if the temperature difference between the air and water remains the same.

If the ice thickness remains constant, the amount of heat released to the atmosphere due to the cooling of the new layers of the sea included in the vertical circulation, will be constant and equal to

$$q_t = c_w p (t_w - \tau), \quad (11)$$

where t_w is the initial temperature of the layer and τ is the freezing point.

TABLE 73

p	t°	S o/oo	i	R_i	R_t	R	q_i	q_t	q
10	1.6	30.00	83	958	0	958	6.0	0	6.0
15	1.5	32.50	43	1,237	1,540	2,777	3.0	4.8	7.8
25	1.0	33.00	-	-	265	265	-	0.6	0.6
Σ	-	-	126	2,195	1,805	4,000	9.0	5.4	14.4

Table 73 gives some computations based on the concepts and formulas given above. In this table, p is the thickness of the water layer in meters, t° is the temperature of the layer at the initial moment, S o/oo is the salinity of the layer at the initial moment, i is the thickness of the ice (in cm) which creates the salinification required to initiate convective mixing with the lower lying layer, R_i is the number of freezing degree-days expended on crystallization, R_t is the number of freezing degree-days expended on cooling the layer to the freezing point, R is the sum of the freezing degree-days expended on crystallization and on cooling the layer, q_i is the amount of heat in kg-cal released by 1 cm² of ice surface to the atmosphere during the crystallation of the ice,

q_t is the amount of heat in kg-cal released to the atmosphere during the cooling of the layer, and q is the total amount of heat in kg-cal released to the atmosphere during crystallization and cooling.

During the computations, the salinity of the ice was assumed to be 0, the density of the ice 0.9, the density of the water 1.0, the heat of crystallization 80 g-cal and the heat conductivity of ice (which is closest to that observed in nature) was assumed to be 0.003 g-cal/sec degree cm. Finally, it was assumed that there were 4000 freezing degree-days in the investigated region during the winter, after which melting started.

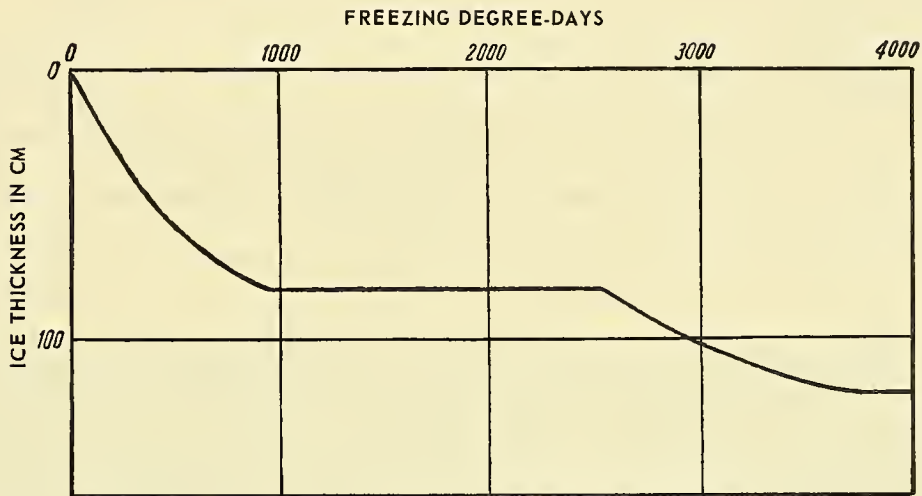

Figure 75. Ice accretion in stratified water.

The data in columns 4, 5 and 6 are depicted in figure 75, in which the freezing degree-days are plotted on the X-axis and the ice thickness in centimeters on the Y-axis.

On examining table 73 and figure 75 we see that:

1. Ice formation occurs sporadically, namely: during the first 959 freezing degree-days, there is constant ice accretion up to 83 cm, during the next 1540 freezing degree-days, the ice thickness remains the same, then, during the next 1237 freezing degree-days, ice accretion is reactivated, and the ice thickness increases to 126 cm, but then, until the end of the winter regime, i. e., until the end of the 4000 freezing degree-days, the ice again stops growing. Of course, this sporadic accretion of ice cannot help but affect the structure of the ice, and causes its stratification. Each new layer of ice results from the inclusion of a new layer of water in the vertical circulation.

Thus, ice stratification can occur not only when floes overturn or when they raft upon each other during hummocking (dynamic stratification), but also as a result of the thermal interaction of the atmosphere and sea (thermal stratification). Actually, the rate of ice accretion increases with decreasing air temperature and decreases with increasing air temperature. When ice

accretion is slow, brine drains out of the salt cells and a smaller amount of air bubbles and silt is retained in the ice. Consequently, the layers of ice which formed during higher air temperatures are fresher, less porous, and more monolithic than the layers which formed during low air temperatures. The stratification of the upper layers of the sea has a still greater effect on the stratification of ice. As has been noted, each new layer of the sea drawn into the vertical circulation creates a new ice layer; the thinner the layer of sea water, the thinner will be the layer of ice; the more sharply delineated the layer of the sea, the more sharply delineated will be the layer of ice.

2. It is easy to calculate that if the upper layers (pre-mixed and pre-cooled to the freezing point) were 20.5 m thick instead of 10 m, the ice would not grow sporadically (and consequently, the ice would not be stratified), and the ice thickness could increase to 170 m with 4000 freezing degree-days (counting from the moment of cooling to the freezing point). Thus, in this example, the ice thickness proved to be 44 cm less than it would have been under other conditions.

3. It is also easy to calculate that if, at the same temperature of 1.5° , the second layer were 30.4 m thick instead of 15 m, after 958 freezing degree-days had been expended on forming the first 83 cm of ice, the remaining 3042 freezing degree-days would be expended solely on cooling the upper layer mixed to a depth of 40.4 m to the freezing point, and there could be no additional ice formation. The same result would be obtained with the same thickness of the second layer (15 m), if its initial temperature were 3.0° instead of 1.5° .

4. It is also easy to calculate that after the ice becomes 83 cm thick, and convective mixing of the upper layer with the second layer begins, the common temperature of the two upper mixed layers, i. e., to a depth of 25 m, will increase to 0.26° , due to the temperature of the second layer, as a result of which the ice might even begin to melt somewhat from below. Of course, if we assume there is no motion other than convective motion in the water under the ice, a film of melted fresh water will immediately form near the lower surface of the ice, which will limit the heat exchange between the water and the ice. When water moves beneath fast ice, or when ice moves, frictional mixing will constantly destroy this protective crust, and thus the effect of the contact of the ice and warm water will intensify.

5. A new increase in the water temperature beneath the ice will begin after 3735 freezing degree-days, and by the end of winter the water temperature in the entire 50 m layer under the ice will be -0.19° , i. e., slightly higher than the freezing point, which will undoubtedly intensify spring thawing quite substantially.

6. The rate of heat release by the sea to the atmosphere is most intense at the initial moment of ice formation; then it decreases parabolically. After 958 freezing degree-days, the rate of heat release becomes constant, since ice accretion ceases; after 2498 freezing degree-days, it again decreases, and finally, it remains constant after 3735 freezing degree-days until the end of the season.

7. In the example studied, the freezing degree-days were computed from the moment the upper layer was cooled to the freezing point. Let us now assume that a storm mixed the two upper layers at exactly this moment. In such a case, the average temperature of these layers will be 0.26° , and consequently ice formation can begin only after the surface of the sea releases 4.8 kg-cal/cm^2 to the atmosphere.

Various assumptions can be made concerning the meteorological conditions and, correspondingly, it is possible to speak of different rates of heat release to the atmosphere by an ice-free surface. In any case, the assumed mixing will delay the appearance of the ice, and then the release of heat from the open water surface will be faster than in our example, (i.e., through ice). In this regard, the calculation of the number of freezing degree-days given in table 73 will also change. However, the total amount of heat released by the sea to the atmosphere remains unchanged; only the order of magnitude of its components changes. For example, according to the table, at first 6.0 kg-cal/cm² were expended on crystallization, then 4.8 kg-cal/cm² on cooling the second layer, after this, 3.0 kg-cal/cm² again on crystallization, etc. Under such conditions, the ice was two-layered, with the division into layers at a depth of 83 cm. During preliminary mixing down to 25 m, at first 4.8 kg-cal/cm² were expended on cooling, and then 9.0 kg-cal/cm² on crystallization. The ice formed would be single-layered.

8. In Section 7, it was assumed that the storm which mixed the first and second layers began at the exact moment that the upper layer reached the freezing point, but these layers can mix even after the sea is covered with a thin ice layer, provided the force and duration of the wind is sufficient to break it. Since the heat reserve (computing from the freezing point) in the second layer is 4.8 kg-cal/cm², this reserve is sufficient to melt up to 67 cm-thick ice.

Thus, we see that the vertical distribution of temperature and salinity in the water beneath ice has a substantial effect on the stratification and thickness of ice formed under the same meteorological conditions. Apropos, I have received information of practical interest from M. M. Somov.

During the first days of July 1943, the icebreaker *Mikoyan* discovered "spring ice" in the region of Russky Island (Ostrov Russkii) (near the Taimyr coast of the Kara Sea). For several days prior to this, unbroken shore ice still remained right up to the Kirov Islands. From this, Somov concludes that the spring ice discovered by the *Mikoyan* existed in the midst of continuous, fast ice and this ice could not have been brought in from another area; we can only assume that this ice is not of spring origin, but is thinner than the surrounding ice due to some additional amounts of heat carried into this region during the winter.

In Somov's opinion, such ice could not have been discovered earlier. Airplanes are unable to distinguish it from the air, and vessels ordinarily begin to navigate only when spring and autumn ice are so intermixed that it is difficult to resolve such a question. It seems to me that these discussions and the example taken indicate that extensive areas of thicker or thinner ice can be created by the pre-winter vertical distribution of oceanographic characteristics, which are caused basically by sea currents, and by intense wind mixing during this period.

Oceanographic profiles made in regions where climatic conditions can be considered completely identical sometimes show a great variation of the vertical temperature and salinity distribution due primarily to sea currents. This is the primary reason for the difference in the freezing indexes; another factor is the thickness of the ice which forms. As a rule, the warmer the subsurface layers, the greater are the freezing indexes and the thinner the ice.

The warm saline Atlantic waters which enter the Arctic Basin via the Greenland current, play an important role in the water balance of the Arctic Basin. The surface layers of the Arctic Basin are freshened by shore runoff and ice melt and they are salinified by ice formation and by mixing with the deep Atlantic waters. Part of the freshened water and ice is carried out of the basin by the East Greenland current. As a result, specific salinity and temperature equilibrium

conditions are created characterized by the depth of the upper surface of the Atlantic waters. During years when the influx of Atlantic waters is intensive and their temperature high, and when the winters are warm, this surface rises somewhat; during years when the influx of Atlantic waters is weak and when the winters are severe, it sinks somewhat.

The warm Atlantic waters which penetrate into the Arctic Basin as a deep current, and the changes in their regime, i. e., temperature and thickness, are extremely important, but as yet they have not been evaluated properly, mainly because these waters are, so to speak, "buried" under the cold, desalinified surface layers. Nevertheless, this effect can be detected easily by simple computations similar to the ones already given. This effect is particularly apparent where Atlantic waters, moving from west to east and forced to the right toward the continental shelf by the force of the earth's rotation, enter from the north into the Soviet Arctic Seas and here, as it were, "creep up" to shallower depths. I shall return to this interesting question later.

LITERATURE: 87.

Section 85. Effect of a Snow Cover on the Rate of Ice Accretion

As we have seen, the heat conductivity of snow is considerably less than that of ice; consequently, ice beneath a snow cover is considerably thinner than snow-free ice, and its temperature is correspondingly higher.

Figure 76 by Ponomarev shows ice accretion on the Severnaya Dvina during the winter of 1941-1942 from the moment that the ice cover was established. The middle curve shows the average thickness of the natural ice beneath the snow. The upper curve shows the snow depth. The lower curve represents the average ice thickness along a railroad ice crossing which was always kept clear of snow.

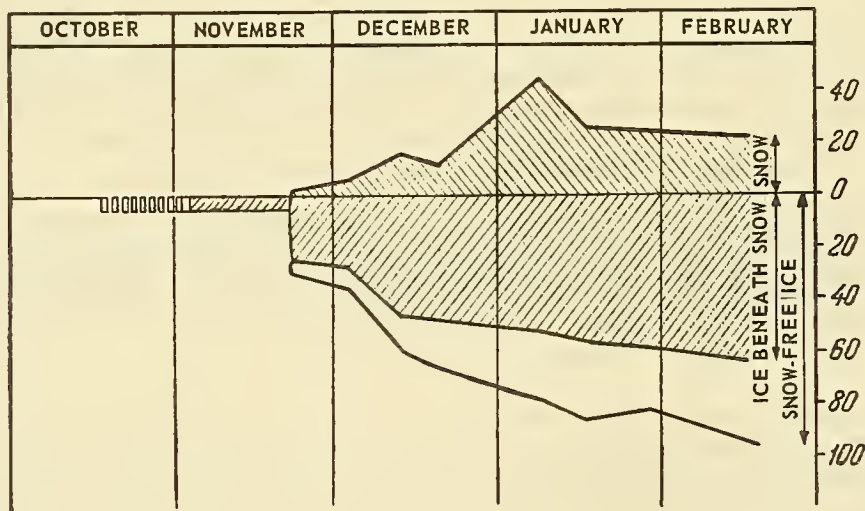

Figure 76. Ice accretion beneath snow and with no snow.

It can be seen from the figure that on 28 January 1942, for example, the average thickness of the ice beneath a snow cover 15 to 40 cm thick was 58 cm (maximum 63 cm, minimum 48 cm); but on the snow-free roadbed, the average ice thickness was 83 cm (maximum 89 cm, minimum 73 cm). Thus, snow-free ice proved to be almost 1 1/2 times thicker than ice covered with a natural snow cover. This knowledge is always used when building ice crossings and all sorts of roads on river and shore ice.

To solve the problems of the effect of a snow cover on the rate of ice growth, I have assumed that the heat flow through the snow and through the ice is in equilibrium at all times, or

$$q = \frac{k_s(t_a - t)}{S} T = \frac{k_i(t - t_w)}{i} T, \quad (1)$$

where k_s is the heat conductivity of snow, k_i is the heat conductivity of ice, S is the snow depth, i is the ice thickness, t_a is the air temperature and also the temperature of the upper surfaces of the snow, t_w is the water temperature and also the temperature of the lower surface of the ice, t is the temperature at the ice-snow interface and T is the time.

From formula (1) it follows that

$$t = \frac{k_s i t_a - k_i S t_w}{k_i S + k_s i}. \quad (2)$$

To be sure, the temperature at the interface changes constantly in connection with ice accretion which assures a flow of heat to the atmosphere, but this change can be ignored for comparatively short periods of time.

Furthermore, I have assumed that the investigated ice field is in isostatic equilibrium (see Section 103); in other words, the following equation holds at each vertical

$$s\delta_s + i\delta_i = \delta_w z, \quad (3)$$

where δ_s is the snow density, δ_i is the ice density, δ_w the water density, and z is the distance between the water-line and the lower surface of the ice.

According to Abel's, the heat conductivity of snow is determined by its density according to

$$k_s = 0.0067 \delta_s^2. \quad (4)$$

Figure 77 is constructed according to formulas (1) to (4) and the following values are assumed (for pure monolithic ice formed from fresh water): $i = 100$ cm, $t_a = -20^\circ$, $t_w = 0^\circ$, $\delta_w = 1.0$, $\delta_i = 0.9$, $\delta_s = 0.5$, $k_i = 0.0054$ and $k_s = 0.0018$.

On examining figure 77, we see the following:

1. The ice bends under the weight of the snowdrift, and under the given conditions, the upper surface of the ice sinks below the water level, even when the snow layer is 20 cm thick. It is understandable that when the snow cover is very thick and when there are through-cracks in the ice, the water will come to the surface of the ice, and, on wetting the lower layers of the snow, will freeze there (see columns 5 and 6 in table 70).

2. The isotherms bend upward beneath a snowdrift. Thus, after a snowfall, the higher the drift, the higher the ice temperature rises.

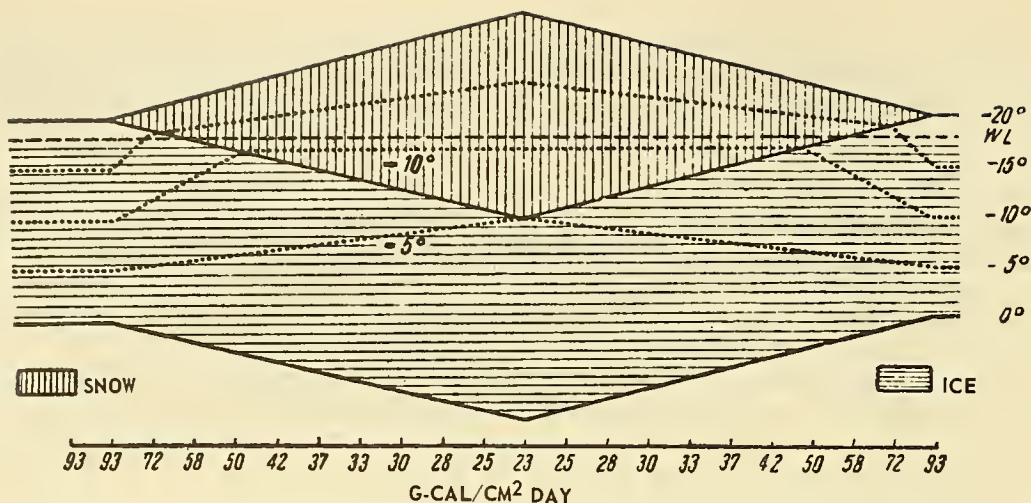

Figure 77. Ascent of isotherms beneath snow drifts.

3. The flexure of ice under a drift, with a simultaneous temperature increase in the lower layers of the ice, results in the washing away of the convexity by sea currents, especially tidal currents.

4. The amount of heat released to the atmosphere through the snow and ice can be computed easily by formulas (1) and (2). Through ice 20 cm thick with a snow-free surface, 467 g-cal/cm² day are released to the atmosphere which increases the ice thickness 16 cm, while only 233 g-cal/cm² day are released through ice 10 cm thick and covered by a layer of snow also 10 cm thick, which increases the ice thickness only 3 cm.

Figure 77 shows the amount of heat (in g-cal/cm² day) released by ice 100 cm thick with snow covers of different depths.

The decrease of heat release beneath snow, and the resulting decrease of ice accretion also gradually destroy the convexity which had formed under the weight of the drift.

Burke presents very interesting observations conducted during the winter of 1937-1938 on Franz Joseph Land, of the effect of a snow cover on the rate of ice accretion. These observations also prove the destructive action of sea currents. Burke writes: "Here, at the eastern cape of Scott-Kelty Island, extremely strong tidal phenomena are observed. In November 1937, newly-formed ice, located between hummocky fields over a quite extensive area, reached a thickness of 20 cm. Ice thickness measurements conducted every ten days showed that the ice thickness began to decrease as snow accumulated on the ice, and by 10 February, the ice had disappeared completely. It became dangerous to walk on the snow and people fell through. By this time, the snow layer had become 57 cm deep. Later, the wet snow began to freeze and new ice formed but now it was snow ice, which was gray and not the usual green color."

LITERATURE: 23, 76, 77.

Section 86. Ice Accretion in the Region of Ice Removal

As we have seen, the thickness of ice accretion as a function of freezing degree-days, can be expressed by

$$i^2 + 50i = 8R, \quad (1)$$

where i is the ice thickness in centimeters and R is the number of freezing degree-days.

This formula gives an idea of the accretion of a single floe, either stationary or drifting. Let us use this formula to solve one of the frequent questions which arise in connection with the study of the ice concentration of seas from which ice is constantly removed by winds and currents. Let us attempt to determine the ice thickness at some geographic point of the sea where the rate of ice drift is known.

Let us assume that we have a rectangular channel, open at one end, and that there is constant and uniform removal of ice through this open end. Let us also assume that the air temperature is uniform throughout the channel.

Under such assumptions, it is obvious that the ice thickness will remain near zero and that it will increase with distance. The question arises: under these conditions, what will the ice profile be like along the axis of the channel after complete removal of all the ice which had formed at the moment freezing started throughout the channel?

For the sake of simplicity, let us assume that the temperature differential between the air and water is constant, and is 25° . Let point 0 in figure 78 correspond to the origin of the coordinates. Let the X-axis represent the distance traversed by the ice in 40 days. It is clear that the ice, whose initial thickness at point 0 was 0, will be subjected to $25 \times 40 = 1000$ freezing degree-days in these 40 days. This same ice will be subjected to 2000 freezing degree-days at the end of 80 days, etc.

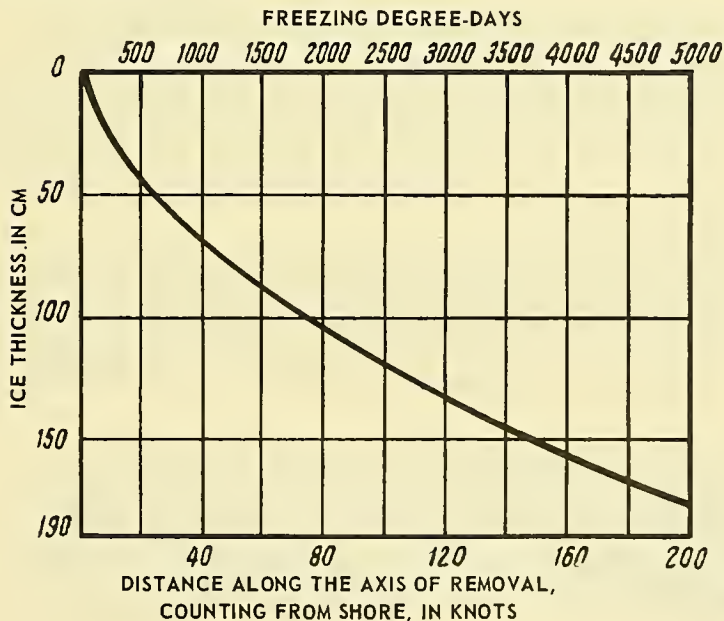

Figure 78. Ice profile along the channel axis.

In the same figure, let the Y-axis represent the ice thickness computed according to formula (1). The resulting curve will also characterize the ice thickness along the axis of the channel.

If we increase the rate of drift and retain the same scale in the figure, we should increase the distance between the points corresponding to the given number of freezing degree-days. If the rate of drift decreases, the distance between the contiguous numbers of freezing degree-days will also decrease accordingly.

The stated problem can also be solved in another manner. Actually, in formula (1) R is

$$R = \theta T,$$

where θ is the temperature difference between air and water, which we assume to be constant and T is the number of days.

However,

$$D = vT,$$

where D is the distance in knots traversed by the ice in a day, v is the rate of drift (in knots) per day and T is the drift duration.

Hence, we get

$$i^2 + 50i = \frac{8\theta}{v} D, \quad (2)$$

where D is the distance of a given point in the channel from the beginning of the channel expressed in knots.

According to this last formula, the distance along the axis of the channel, counting from the beginning of the channel, can be plotted along the X-axis, instead of the number of freezing degree-days.

With certain reservations, the problem as stated, can be adapted to the Kara Sea, e.g., where there is a constant northward removal of ice from the Yamal Peninsula at a rate of about 1.0 to 1.5 knots per day. It is clear that the problem can be complicated by making assumptions concerning the distributions of velocities and temperatures along the axis of ice removal, etc.

As an example, the lower scale in figure 78 shows the distances along the axis of removal in knots, computing from the beginning of removal, on the condition that the temperature difference air-water is 25° and the rate of removal is 1 knot/day.

Only the thickness of the accretion ice can be characterized by the given example. However, this method can be developed somewhat. Actually, if we know the drift of the ice field for a certain period of time and the number of freezing degree-days to which the ice field has been subjected during the same time interval, we can compute the thickness of this ice at any point of the drift by formula (1).

As a rule, the ice in the seas of the Soviet Arctic is in constant motion both summer and winter. Open water areas of various sizes appear from time to time due to the collisions of individual floes and fields and the subsequent hummocking, which decreases the ice area. Sometimes even thick shore ice is broken up by strong winds and is carried far from the shores. At negative air temperatures, new ice immediately begins to form in the open water thus created.

Table 74, computed as an example from formula (1), shows the thickness of ice of various ages.

TABLE 74. THEORETICAL THICKNESSES OF ACCRETION ICE IN CM ON THE FIRST DAY OF EACH MONTH COMPUTED ACCORDING TO THE AIR TEMPERATURES IN 1935 AND 1936 ON UYEDINENIYE ISLAND

Ice Thickness	By 1-11	By 1-12	By 1-1	By 1-2	By 1-3	By 1-4	By 1-5	By 1-6
October	12	51	78	107	129	150	160	166
November	-	45	73	103	126	147	157	164
December	-	-	49	86	111	135	145	150
January	-	-	-	62	92	119	131	138
February	-	-	-	-	58	93	107	116
March	-	-	-	-	-	62	81	91
April	-	-	-	-	-	-	40	56
May	-	-	-	-	-	-	-	29
Average daily air temperature for the preceding month	-3°.0	-17°.5	-19°.4	-27°.7	-27°.8	-28°.1	-15°.0	-9°.4

The freezing degree-days taken are those which were observed during the winter of 1935-1936 on Uyedineniye Island. For example, the ice which had begun to form on 1 January 1936 and which we call "January" in the table became 62 cm thick by 1 February, 119 cm by 1 April and 138 cm by 1 June.

It can be seen from the table that there is no real difference in the ice thicknesses in October, November, December and even in January. Thus, the removal or non-removal of ice in the autumn has little effect on the thickness of ice encountered during the subsequent navigation season. On the other hand, the spring removal (March through May) is of great importance. Actually, the ice carried out at this time will be replaced by ice, 1) which is not very thick, and 2) which has a relatively high temperature.

The last line of table 74 shows the average daily air temperatures for the preceeding month. The data in this line and the preceding conclusions indicate the significance of ice removal during spring and also of the early arrival of spring for summer navigation.

LITERATURE: 63, 77.

Section 87. Maximum Thickness of Perennial Ice

Weyprecht introduced the concept of the maximum thickness of "perennial ice" accretion.

On the basis of observations of the dependence of ice growth on the number of freezing degree-days, Weyprecht found that newly-formed ice would be 209 cm thick by the end of the first winter

in the Franz Joseph Land region, since the average number of freezing degree-days in that region is 5625.

Assuming that the ice thickness would decrease 100 cm during the summer, i.e., that it would become 109 cm thick, he calculated that by the end of the second winter, the ice would become 234 cm thick due to the effect of another 5625 freezing degree-days on ice 109 cm thick.

Thus, considering the further increase of ice thickness, Weyprecht found that for Franz Joseph Land where, on the average, the number of freezing degree-days was 5625 with a summer decrease of 100 cm, the maximum thickness would be 260 cm. With this ice thickness, as much ice would melt in summer as would accrete in winter.

We have seen that ice accretion, as a function of the number of freezing degree-days, can be determined with adequate approximation, by my formula

$$i^2 + 50i = 8R. \quad (1)$$

From this formula, we get

$$(\Delta i)^2 + (50 + 2i_0)\Delta i - 8\Delta R = 0. \quad (2)$$

From figure 72, we see, e.g., that if there were no ice at the initial moment, after 6000 freezing degree-days the ice would become 196 cm thick, while if the ice were 400 cm thick at the initial moment, after 6000 freezing degree-days, the ice thickness would increase only 53 cm. This, then, is Weyprecht's concept of the maximum accretion of perennial ice.

Transforming formula (2), we get

$$I_1 = \frac{4\Delta R}{\Delta I} - \frac{\Delta I}{2} - 25. \quad (3)$$

In this formula, let us assume that: ΔI is the decrease of ice thickness during summer due to melting and ΔR is the number of freezing degree-days during the winter in a given region.

In this case, I_1 will be the maximum ice thickness during the autumn, before ice formation begins.

If we assume that all the ice which has formed in the given region during the winter, melts during the summer,

$$I_1 = 0,$$

then from (3) we get

$$8\Delta R = (\Delta I)^2 + 50\Delta I. \quad (4)$$

If the number of freezing degree-days is greater in a given region than that obtained by formula (4), the ice which had formed during the winter would last through the summer and would then be classified as perennial ice. If it is less, not only the ice which had formed in a given region, but also ice of any thickness which had been carried into the given region from another region would eventually be destroyed by melting.

In order to obtain the ice thickness prior to the start of melting, i. e., the critical maximum ice thickness, we should add the amount of summer melting.

$$I_{\max} = I_1 + \Delta I, \quad (5)$$

or

$$I_{\max} = \frac{4\Delta R}{\Delta I} + \frac{\Delta I}{2} - 25. \quad (6)$$

to the value I_1 obtained from formula (3).

From formula (6), one can see that the maximum ice thickness tends toward infinity as the amount of summer melting decreases and approaches zero. I shall return to this question later.

The graph which has already been given in figure 72 can be used to compute maximum ice thickness. Actually, we have seen that when the maximum ice thickness is reached, winter ice accretion is in exact equilibrium with summer melting. Hence, if we consider the isolines of ice growth on this graph to be isolines of melting, their intersection with the vertical lines corresponding to freezing degree-days, will give us the minimum ice thickness in a given region. By adding summer melting to this value, we will find the maximum thickness.

As has already been pointed out, Nansen observed 7662 freezing degree-days during the winter of 1894-1895. Using the graph, we find that when $R = 7662$ and $i_0 = 0$ cm, year-old accretion ice will be 224 cm thick. On the other hand, Nansen noted that the ice melted 100 cm during the summer in the region of the drift of the *Fram*. Beginning on the graph at $R = 7662$ and $\Delta I = 100$ cm, we find the minimum ice thickness $I_1 = 231$ cm and the maximum ice thickness $I_{\max} = 331$ cm.

The corrections explained in figure 79 should be entered in Weyprecht's diagram. In this figure, ice thickness is plotted along the Y-axis and the freezing degree-days along the X-axis. The curve ON is plotted according to formula (1).

If a certain number of freezing degree-days R is characteristic of a given region at the end of the first year, we will find the ice thickness by the end of the first winter, i. e., i_1 at the intersection (point a) of the vertical line corresponding to the value of R and the plotted curve.

The ice thickness will change during the summer due mainly to the following processes:

1. The thickness will increase somewhat from below due to the low temperatures maintained in the ice itself at the start of melting. This increased ice thickness is expressed by segment ab in figure 79.

2. The ice thickness will decrease from above by the amount ac due to summer melting.

Thus by the end of the summer, the ice thickness will be

$$i_1 + ab - ac = i_1 + i' - i''.$$

3. The internal temperature of the ice will increase, due in part to the absorption of radiant energy and atmospheric heat by the upper ice layers, and in part due to the absorption, through

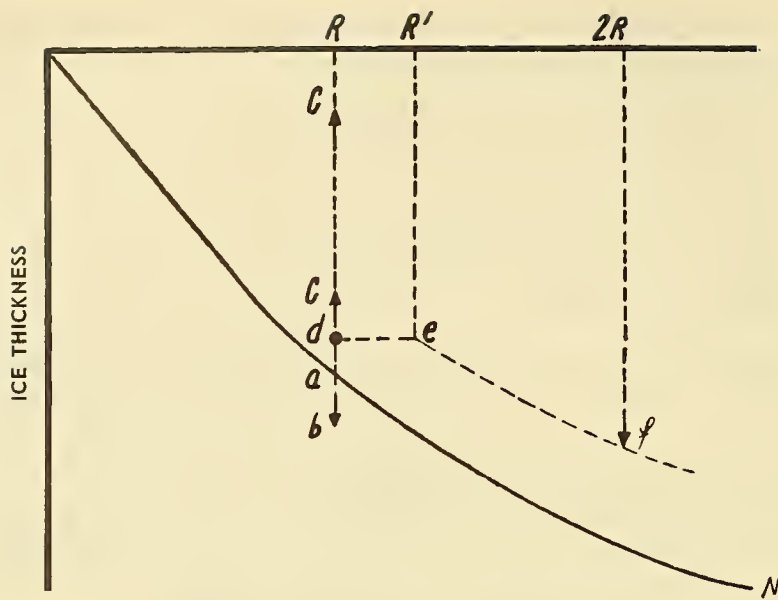

Figure 79. Accretion of perennial ice.

the lower surface of the ice, of the heat of crystallization released during the formation of an additional layer of ice of thickness ab .

The heat absorbed from the atmosphere, however, is used not only to melt a layer of ice ac thick and to raise the temperature within the ice, but also for processes within the ice (fusion) which is reflected by the fact that the upper layers of the ice become completely saturated with water by the end of summer. The importance of this process is clear from the following observations made on the *Sedov*. In 1939, the mean daily air temperatures were negative by the beginning of September, but the winter increase of ice thickness did not begin until 20 November after the ice had frozen through.

It can be seen from table 75 that 1335 freezing degree-days were required before new ice could form in the region of drift of the *Sedov*.

If we assume that the amounts of summer ice accretion and melting are constant in the given region, and that the number of freezing degree-days is also constant, from formula (6) we get

$$I_{\max} = \frac{4(R - R')}{\Delta I} + \frac{\Delta I}{2} - 25, \tag{7}$$

where $\Delta I = i' - i''$ is the total change in the thickness of the ice during the summer and R' is the number of freezing degree-days necessary for the ice to freeze through.

From formula (7), it follows that the effect of the summer saturation of ice by water is equivalent to a decrease of the average number of freezing degree-days in a given area, and if this decrease is known, it is not difficult to obtain the maximum ice thickness from both formula (6) and the graph in figure 72.

TABLE 75. CHANGES OF THICKNESS OF 1936 AND 1937 ICE (IN CM) DURING THE SUMMER OF 1939. REGION OF DRIFT OF THE *SEDOV*

Date of Measurement	Freezing Degree-Days	Stake Readings		Changes of Ice Thickness		Remarks
		Stake No. 1	Stake No. 2	Stake No. 1	Stake No. 2	
9/10	103	211	243			
9/22	193	211	236	0	-7	
10/1	315	212	233	+1	-3	
10/10	420	211	230	-1	-3	
10/22	640	211	230	0	0	Ice froze 50-60 cm
10/30	852	211	230	0	0	Ice froze 100-120 cm
11/10	1,127	211	230	0	0	Ice froze 140 cm
11/20	1,335	215	233	+4	+3	Beginning of accretion

Returning to figure 79, we see that the ice thickness will be dR by the beginning of the second winter. It will remain the same up to point e , when the ice freezes through. After this, it begins to increase along a curve parallel to the growth curve ON until it reaches point f , corresponding to $2R$, the number of freezing degree-days by the end of the second winter, etc.

Personally, I do not know of any quantitative data which would allow us to judge the effect of the saturation of ice by water, with the exception of the *Sedov* observations already mentioned. Hence, generalizations should be avoided until appropriate data have been accumulated. However, by substituting $R = 6000$ and $\Delta I = 100$ cm into formula (6), we get

$$I_{\max} = 265 \text{ cm},$$

and by substituting $R' = 1500$ into formula (7) (which is actually the case, according to the *Sedov* observations), we get

$$I'_{\max} = 205 \text{ cm}.$$

In other words, the summer warming and the saturation of the upper layers of ice by water decreases the theoretical maximum ice thickness obtained by formula (6) by 60 cm, i. e., by a rather appreciable amount. This allows us to refine Weyprecht's concept of maximum ice thickness somewhat, as follows: the maximum ice thickness is that at which the winter regime merely destroys the changes in the ice thickness and structure caused by the summer regime.

Natural phenomena are very complicated and quantitative computations can serve only to clarify the qualitative aspects of the phenomenon. We shall conduct further discussions from this point of view.

Formula (7) indicates that the maximum ice thickness depends on the number of freezing degree-days R which characterize the winter regime, and on the amount of melting ΔR and warming R' , which characterize the summer regime.

As we have seen, all these values vary within wide limits, even in the same region. This is particularly apparent in the Atlantic regions of the arctic. During some years, the number of freezing degree-days on Dickson Island (Ostrov Dikson) departs from the average by more than 15 per cent. However, the amplitude of variation of the number of freezing degree-days decreases eastward and northward. The summer regime fluctuates just as greatly in individual regions, but its amplitudes also decrease northward and eastward.

For general considerations, however, let us assume that both the summer and winter regimes remain unchanged in each individual region, and let us investigate the spatial distribution of these elements.

In the region of the Arctic Basin beyond the limits of the continental shoal, i.e., the main region of perennial ice, the number of freezing degree-days evidently fluctuates within the limits 5,000 and 8,000. The summer regime varies more intensely. Thus, while the ice melted about one meter in summer in the region of drift of the *Fram* and the *Sedov* near the Greenland Sea, the ice melt did not exceed half a meter in the region of the pole, as observations made by station "North Pole" showed. Evidently, summer melting amounts to only a few tens of centimeters in the region between the North Pole and the Arctic Archipelago, where the Atlantic influence scarcely penetrates.

Thus, over the entire Arctic Basin, the number of freezing degree-days does not vary by more than a few tens of per cents. Summer melting differs by hundreds of per cents from region to region.

However, when the ice is quite thick, even considerable changes in the number of freezing degree-days have little effect on the ice thickness. Therefore the summer regime is the main factor determining the maximum thickness of perennial ice accretion.

Let us assume the number of freezing degree-days to be constant and let us use the simpler formula (6) for further discussion. Substituting $R = 6000$ in this formula, we find that during summer melting

$$\begin{array}{ll} \Delta I = 100 \text{ cm,} & I_{\max} = 265 \text{ cm,} \\ \Delta I = 50 \text{ cm,} & I_{\max} = 480 \text{ cm,} \\ \Delta I = 20 \text{ cm,} & I_{\max} = 1185 \text{ cm.} \end{array}$$

With the same number of freezing degree-days and with 10 cm summer melting, the maximum ice thickness increases to almost 24 m. This evidently explains in part the formation of thick perennial shore ice along the northern coasts of Greenland and the shelf ice along the coasts of the antarctic.

Thus, there is no doubt that with time the ice thickness gradually approaches the average for a given region. The question arises: how many years does this take? The corresponding formulas would be too complex, but a subsequent change in the ice thickness can be obtained easily using the given formulas and the graph. As an example, let us assume that toward the beginning of winter, ice of different thicknesses is brought into a certain region, where the number of freezing degree-days is 6000, and summer melting 100 cm, and let us trace the changes of thickness from year to year. Let us consider 265 cm to be the maximum ice thickness in the given region, in other words, we shall use formulas (3) and (5) in the computations, ignoring the amount of summer warming, which as yet is little known. I computed table 76 on the basis of just such assumptions.

TABLE 76. CHANGE IN THICKNESS OF ICE OF DIFFERENT THICKNESSES BROUGHT INTO A REGION OF 6000 FREEZING DEGREE-DAYS AND 100 CM SUMMER MELTING

Ice Thickness	Initial Ice Thickness in cm				
	0	200	400	600	800
By the end of the first winter	196	289	453	636	828
By the end of the second winter	225	231	386	577	759
By the end of the third winter	241	276	355	523	693
By the end of the fourth winter	250	272	370	474	630

This table again illustrates a characteristic situation, i.e., when thinner ice arrives in a region with climatic conditions characterized by a certain maximum ice thickness, it gradually becomes thinner. I computed table 77 according to the same formulas.

TABLE 77. ICE THICKNESS IN CM WITH A CONSTANT 6000 FREEZING DEGREE-DAYS, BUT WITH VARIABLE SUMMER MELTING AND AN INITIAL ICE THICKNESS OF 0 CM

Melting in cm	10	20	30	40	50	60	70	80	90	100
After the first winter	196	196	196	196	196	196	196	196	196	196
After the second winter . .	279	272	266	259	253	247	241	236	230	225
After the third winter	342	328	316	303	291	280	269	259	249	241
After the fourth winter . . .	394	371	355	337	320	304	288	274	261	250
After the fifth winter	439	410	388	364	344	328	302	285	269	255
After the sixth winter	479	444	416	387	362	341	313	293	274	259
After the seventh winter . .	515	475	440	407	377	351	321	298	278	261
After the eighth winter . . .	548	503	462	424	390	359	327	302	281	262
After the ninth winter	579	528	481	439	401	366	332	305	283	263
After the tenth winter	607	548	499	452	411	372	336	308	284	264
Maximum Thickness	2,380	1,185	790	595	480	405	353	315	287	265

From tables 76 and 77 it can be seen that it takes a great many years for ice to reach its maximum thickness. Hence, it follows that if the climatic conditions of a given region are known, the thickness of ice accretion indicates its age. On the other hand, the maximum thickness of ice accretion, determined by some method, can serve as an excellent climatic characteristic for individual regions; actually, both the winter and summer regimes of the investigated regions enter into this value.

LITERATURE: 61, 62, 77, 177.

Section 88. Temperature of Sea Ice

Many observers have studied sea-ice temperatures and their vertical distribution, but Malmgren and Sverdrup were the first to conduct observations that encompassed all the seasons. These observations were made from October 1922 through June 1924, during the expedition on the *Maud*.*

From these and other observations, it follows that the temperature of the lower surface of ice is very close to the freezing point of sea water, i. e., it is approximately constant, while the temperature of the ice surface is close to the air temperature. Since the air temperature fluctuates during the day, the temperature of the upper layers also fluctuates during the day. Furthermore, the daily variation of ice temperature is caused by the daily variation of radiation. Thus, very often, under clear night skies, the temperature of the ice surface can be several degrees lower than the air temperature, due to the radiation which is intense at this time. During the day, when solar radiation penetrates the ice and is partially absorbed by it, the temperature of the ice rises slightly, independently of the air temperature. As a result of such a daily temperature variation, the ice strength, which also depends on temperature, has a daily variation. The ice is strongest at about sunrise and weakest at about sunset. This fact should be considered when using ice crossings.

Table 78 gives some extracts from Malmgren's observations during the winter of 1923-1924.

TABLE 78. SEA-ICE TEMPERATURE IN °C, ACCORDING TO MALMGREN'S OBSERVATIONS DURING 1923 AND 1924

Depth in cm from the Ice Surface	0	25	75	125	200
Maximum diurnal temperature increase . .	8.7	4.3	1.6	1.8	0.3
Maximum diurnal temperature decrease . .	6.8	2.4	1.4	0.7	0.4
Mean annual temperature	-15.7	-13.3	-10.2	-8.3	-4.8
Absolute annual minimum	-42.2	-30.4	-23.7	-17.3	-10.0

As was to be expected, the diurnal temperature variations, the mean annual temperature and the absolute annual minimum, which characterize the temperature amplitude in the given case, decrease with depth.

Table 79 and figure 80 show the mean monthly temperatures at different depths from the ice surface, computed by Malmgren from daily observations during the winter of 1923-1924. The average temperatures of October and November, which were obtained from the averages of the corresponding months in 1922 and 1923, are exceptions.

In figure 80, the average monthly temperatures are plotted along the Y-axis and the corresponding months along the X-axis. If we exclude the January anomaly, which was due to the air temperature anomaly, the curves of the average monthly temperatures are quite symmetrical.

*The observations were made with resistance thermometers and thermocouples frozen into the ice.

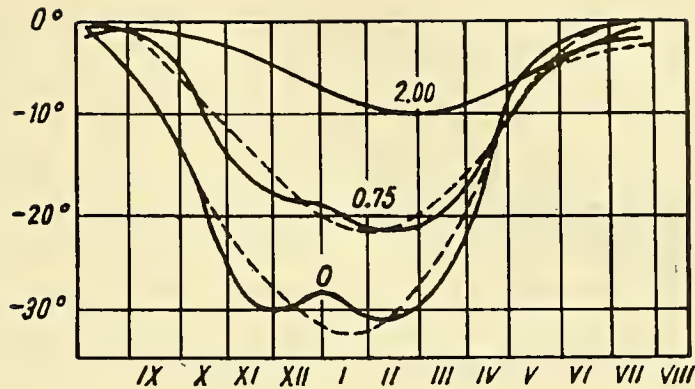

Figure 80. Annual variation of monthly ice temperatures at different depths from the ice surface, according to Malmgren. Observed temperatures (—) and temperatures computed by the harmonic formula (---).

The branches of these curves corresponding to a temperature increase are steeper than those corresponding to a temperature decrease. This phenomenon is in agreement with the following: during a temperature increase, the increase takes place from above and from below at every point in the ice, but during a temperature decrease, when there is a steady flow of heat from below (from the water), the cooling occurs only from above.

The following formula is often used to calculate the annual temperature variation on the basis of mean monthly temperatures

$$t_m = T_m + a \sin(A + m), \quad (1)$$

where t_m is the mean monthly temperature, T_m is the mean annual temperature, a is the amplitude of variation, A is the initial phase and m is an angle reckoned from the middle of January, representing the number of months.

Obviously, when this formula is used, the annual temperature variation at different levels will be represented by sinusoids that differ from each other in amplitude and phase. For ice depths of 75 cm and 200 cm, these sinusoids appear as the dashed lines in figure 80, which was constructed on the basis of Malmgren's computations.

As was to be expected, all anomalies are eliminated by the sinusoids. There is no January anomaly and there is no difference in the slope of the inclines, but the lag of the minimum average temperatures in the deeper layers of the ice, as compared with the time during which these same temperatures occurred in the layers near the surface, is shown in greater relief.

Table 80 shows the mean monthly air and ice temperatures, according to the observations made by Savel'ev on Uyedineniye Island in 1939. The table shows the characteristic decrease of the minimum temperature level and the sharp decrease of the average ice temperature by May and June, despite the steadily increasing ice thickness.

TABLE 79. THE MEAN MONTHLY TEMPERATURES OF SEA-ICE IN °C AT DIFFERENT LEVELS (NEGATIVE TEMPERATURES)

Months	Depth in cm					Average 0-200
	0	25	75	125	200	
January	28.0	24.1	18.9	14.0	6.5	15.9
February	30.9	26.9	21.3	16.3	8.5	18.3
March	29.1	26.0	21.0	16.5	9.6	18.3
April	21.6	20.1	17.3	14.4	9.4	15.2
May	7.4	8.6	9.3	9.2	7.4	8.4
June	1.5	3.0	4.1	4.5	3.8	3.6
July	0.0	0.1	1.3	1.7	1.8	1.0
August	0.0	0.0	0.8	1.1	1.2	0.8
September	4.7	1.3	0.9	1.1	1.3	1.9
October	12.3	7.6	3.3	1.6	1.4	4.2
November	23.0	17.8	11.9	7.1	2.4	10.2
December	29.9	24.4	17.7	12.2	4.6	15.1
Average	15.4	13.3	10.6	8.1	4.8	9.4

TABLE 80. MEAN MONTHLY AIR AND ICE TEMPERATURES. SAVEL'EV'S OBSERVATIONS ON UYEDINENIYE ISLAND, 1939

Months	January	February	March	April	May	June	Remarks
Air	26.60	22.75	23.69	19.38	6.85	+0.96	With the exception of the air temperature in June, the temperatures are negative throughout
Ice level in cm							
10	17.90	15.48	16.16	15.50	7.92	1.39	
20	15.86	14.21	14.91	14.58	8.00	2.20	
30	12.90	12.34	13.00	12.91	7.30	2.20	
40	10.35	11.59	12.39	12.49	7.58	2.56	
60	6.67	8.43	9.46	9.84	6.35	2.68	
80	3.99	6.49	7.76	8.42	6.10	3.18	
100		3.71	5.05	5.97	4.74	2.59	
120		2.14	3.62	4.80	4.34	2.72	
140			2.30	3.27	3.49	2.42	
160					2.22	1.49	
Average Ice Temperature	10.18	8.26	8.35	8.89	5.50	2.44	

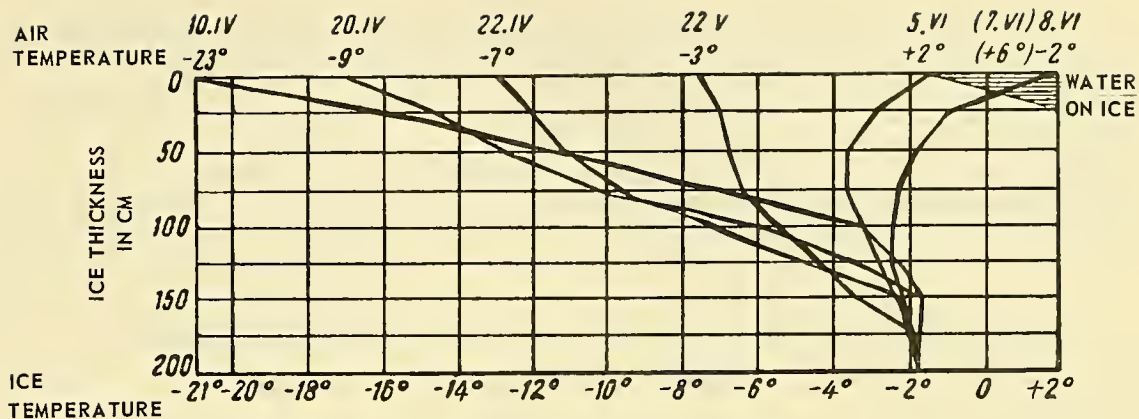

Figure 81. Ice temperatures at Cape Schmidt.

Figure 81 shows the air temperature and vertical temperature distribution in ice observed from 10 April to 8 June 1937, in the region of Cape Schmidt and the Chuckchee Sea (according to Georgievskii). Like Malmgren's observations, this figure shows how slowly the minimum temperature is established in the deep layers and it shows the characteristic summer temperature minimum in the middle of the ice. This phenomenon is well known to polar navigators, who have found through experience that the upper part of the ice is the hardest during ice formation but that the middle part is hardest during the melting period.

Interesting observations of the brief but sharp air temperature changes on the heat regime of the ice with a 30 cm snow cover were conducted in Dickson Bay (Bukhta Dikson) by Savel'ev. From 2 to 18 February 1944, the air temperature changed from -16° to -38° to -6° , the surface temperature of the snow changed from -16° to -40° to -7° , the surface temperature of the ice from -8° to -19° to -10° , and the temperature at the 80 cm level from -1.4° to -7° to -5° . Minimum temperatures lagged at the lower levels, and with the beginning of warming appeared in the middle levels of the ice.

Malmgren made another deduction from his observations of ice temperatures. Figure 82 shows the vertical distribution of the mean annual ice temperatures.

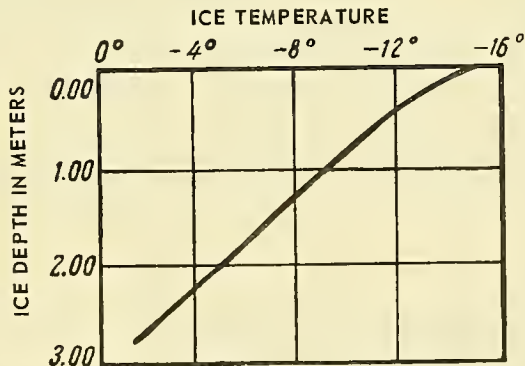

Figure 82. The mean annual temperature of sea ice in the Arctic Basin, according to Malmgren.

These temperatures decrease with increasing depth of the lower layer from the surface and, at a depth of 280 cm (if we continue the curve by geometric extrapolation) become equal to the freezing point of sea-water (in the region of Malmgren's observations, -1.5°). This is the depth which Malmgren considers the average thickness of ice formed in the East Siberian Sea due to heat conductivity.

LITERATURE: 39, 62, 104.

Section 89. The Lag of the Temperature Minimum in the Lower Levels of Sea Ice

Quite naturally, the late appearance of minimum temperatures at the lower levels of sea-ice is the result of the Fourier Laws of the distribution of periodic temperature fluctuations in a uniform solid body of infinite proportions. However, in sea-ice, this has certain specific characteristics.

At the lower surface of the ice, the temperature remains near the freezing point, but at the upper surface it is close to the air temperature. Let us assume that the temperature of the ice surface reaches its minimum at a certain moment. After this, the following factors will help increase the ice temperature: 1) solar radiation, which raises the temperature of the ice surface, penetrates deep into the ice, and converts into heat there; 2) the heat incident on the ice surface from the air, whose temperature gradually increases; 3) the continuous heat flux, both winter and summer, from the water through the lower surface of the ice, such as the heat of crystallization which is released during the formation of ever newer ice layers at the lower surface of the ice. If we ignore the action of solar radiation on the internal parts of the ice, the temperature at any point of the ice will change according to

$$\frac{dt}{dT} = \frac{k}{c_i \delta_i} \left(\frac{\partial^2 t}{\partial z^2} \right), \quad (1)$$

where t is the temperature, T the time, k is the heat conductivity, c_i is the specific heat of ice and δ_i is the ice density.

Since the ice surface is warmed through quickly during the spring, at first the vertical temperature gradients in the upper part of the ice will be considerably greater than in the lower part; consequently (see figure 83) the minimum temperature level, which decreases in size, gradually drops lower and lower until it assumes a position approximately in the middle of the ice mass.

Actually, after the temperature of the surface layer increases to the freezing point, i. e., after it becomes approximately equal to the temperature of the lower layer, and after a situation is established where

$$\left(\frac{\partial t}{\partial z} \right)_{+z} = \left(\frac{\partial t}{\partial z} \right)_{-z}, \quad (2)$$

where $(\partial t / \partial z)_{+z}$ is the temperature gradient at a distance z above a given point, $(\partial t / \partial z)_{-z}$ is the temperature gradient at a distance z below a given point, i. e., the arrival of heat from above will be equal to the arrival of heat from below; there will be no reasons for any further descent of the minimum. On examining figure 81, which represents Georgievskii's observations of ice temperatures at Cape Schmidt, and table 80 which gives the temperature observations made by Savel'ev on Uyedineniye Island, we see that these data completely confirm the above hypothesis.

The following formula is derived from the Fourier Law of the distribution with depth of periodic surface-temperature changes of a uniform infinite body,

$$z = 2t \sqrt{\frac{\pi k}{T}}, \quad (3)$$

where z is the depth of the level computed from the surface of the ice, t is the time lag of the maximum or minimum at a [given] depth, k is the thermometric conductivity, T is the period of temperature change (in our case, 10.4 months is the time it takes for the temperature of the surface layer of the ice to return to the initial temperature).

From formula (3), we obtain

$$k = \frac{T}{4\pi} \frac{z^2}{t^2} = 0.00029 \frac{z^2}{t^2}, \quad (4)$$

where t is expressed in days, z in centimeters and k in cm^2/sec .

Malmgren computed the dates of minimum temperature at different levels in the ice (table 81) from his observations of ice temperature and from his theoretical sinusoidal curves (figure 80). I obtained the values of the coefficients of thermometric conductivity of ice, given in table 82, by successive substitution of the following in formula (4); the depths 25, 75, 125 and 200 cm, and the corresponding time intervals 8, 19, 29 and 50 days, taken from the surface minimum (on 26 January).

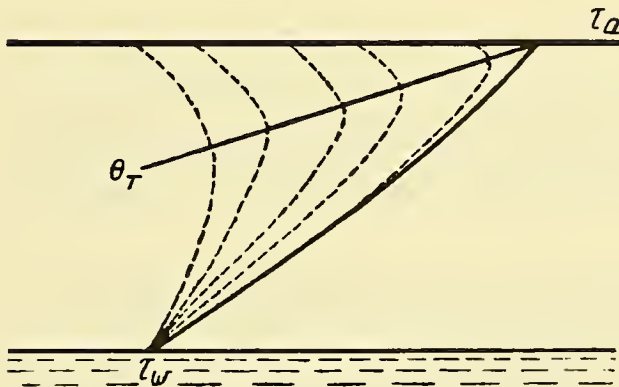

Figure 83. Diagram of the drop in the level of minimum ice temperature in the summer.

TABLE 81. THE DATES OF MINIMUM ICE TEMPERATURES AT DIFFERENT LEVELS, ACCORDING TO MALMGREN'S OBSERVATIONS

0 cm	26 January
25 cm	3 February
75 cm	14 February
125 cm	24 February
200 cm	17 February

TABLE 82. THE THERMOMETRIC CONDUCTIVITY OF SEA-ICE
 COMPUTED FROM THE LAG OF MINIMUM
 TEMPERATURES

In the layer: from 0 to 25 cm	0.0029
from 25 to 75 cm	0.0060
from 75 to 125 cm	0.0072
from 125 to 200 cm	0.0026
In the layer: from 0 to 75 cm	0.0049
from 0 to 125 cm	0.0053
from 0 to 200 cm	0.0046

Malmgren notes quite correctly that formulas for the depth distribution of periodic temperature fluctuations in a uniform medium of infinite thickness should not be applied to sea-ice, which is not uniform and is comparatively thin. Actually, one of the basic assumptions of the theory of the propagation of periodic fluctuations in a homogeneous medium consists of the fact that the average annual temperature at various levels is equal to the average annual temperature at the surface of the medium. This assumption, as well as the other assumptions in the theory, is not applicable to sea-ice. Therefore, Malmgren used other methods to determine the heat conductivity.

LITERATURE: 62, 104.

Section 90. Ice Accretion Due to Low Ice Temperatures

We have already seen that under certain conditions the ice which had formed during the winter can become thicker during the summer, because ice formed from melt water which had drained beneath the ice freezes to the lower surface of the ice when it comes into contact with the cold sea water.

However, aside from this, ice accretion can continue even after the air temperature becomes higher than the temperature of the surface layers of the ice until the temperature of the ice reaches the temperature of the water beneath it (see Section 62).

Let us try to compute approximately the maximum possible ice accretion at the lower surface of the ice, due to the cold reserves which accumulated within the ice during the winter. Let us make the following assumptions:

1. The heat reserves in the water are so slight that we can ignore them.
2. All the cold accumulated in the ice during the winter is expended on summer ice accretion.
3. The vertical temperature distribution in the ice is linear (in other words, the vertical temperature gradient is constant).

Under these assumptions, we can write the equation:

$$(t_i - \tau) \delta_i c_i i = \lambda \delta_i \Delta i, \quad (1)$$

where t_i is the average minimum temperature of the ice, τ is the freezing point, δ_i is the ice density, c_i is the specific heat of the ice, i is the ice thickness, λ is the heat of the fusion, and Δi is the increase of ice thickness due to its internal cold reserves, characterized by the left side of equation (1).

For the sake of simplicity, if we assume that $\lambda = 80$ g-cal/g and $c_i = 0.5$ g-cal/g, we will get

$$\Delta i = \frac{t_i - \tau}{160} i, \quad (2)$$

or if we consider that the temperature of the ice changes linearly from its upper to its lower surface, we get

$$\Delta i = \frac{\frac{t_0 + \tau}{2} - \tau}{160} i = \frac{t_0 - \tau}{320} i, \quad (3)$$

where t_0 is the temperature of the upper surface of the ice and τ , as before, is the temperature of the lower surface of the ice, equal to the freezing point of the sea water in which the ice is floating.

I computed table 83 according to formula (3).

TABLE 83. MAXIMUM ICE ACCRETION DUE TO THE LOW TEMPERATURES WITHIN THE ICE (IN CM)

t_0	-10	-15	-20	-25	-30
i					
50	2	2	3	4	4
100	3	4	6	7	9
150	5	6	9	11	13
200	6	8	11	15	17
250	8	11	15	18	21

Table 83 infers that the internal cold reserve cannot increase the ice thickness more than 5 to 10 per cent.

LITERATURE: 77.

CHAPTER VII

DEFORMATION OF ICE

Section 91. The Deformation of an Ice Cover

As was already shown, the formation of sea ice occurs in a calm sea only in exceptional cases and in comparatively small area; i. e., at the shore of small bays and in unfrozen patches of water (polynyas) which are situated between large ice fields. In the majority of cases, the young-ice formations are subjected to various deformation processes from the very first moment of origin.

Changes in form and size of ice caused by temperature variations are designated "thermal deformations," while those caused by vertical and horizontal movements are classed as "dynamic deformations."

We have subdivided both these deformations and others into two further classifications: relative to the structure and the properties of the sea ice (internal) and relative to the form and size (external).

The internal thermal deformations can be conditioned by the separation of fresh ice from the brine cells and capillaries with a reduction in the temperature of the sea ice.

Since the volume of ice is approximately 9 per cent more than that of water from which it was formed, it is clear that additional tensions occur which fracture the ice with every temperature reduction in every salt cell. The developed pressure in this case reaches upwards of 1,200 kg/cm².

After the beginning of a thaw, this process is even intensified. Actually, the melted water, which penetrates from the surface ice along the capillary fissures to the lower (already cold) parts of the ice, freezes, expands, and thus causes the formation of new thermal fissures. A net of very fine fissures results from these processes, and ultimately weakens the sea ice.

The external thermal deformations of ice are caused in the following manner. According to the observations of Malmgren, the temperature of the surface-layer of ice fields in the Arctic Basin, following approximately behind the air temperature, changes from -2° to -42° in the course of a winter. In connection with this, great tensions occur which cause inner structural changes in the ice, as well as jamming (and sometimes the break-up into blocks) and fissures.

Internal dynamic deformations are caused by ice jams, and are usually accompanied by external deformations. Air bubbles and the brine of the salt cells and capillaries are squeezed out by this process. The sea ice gradually becomes more monolithic and fresh. Moreover, at low temperatures, strong jamming welds the structure into one complete unit in addition to increasing the crystal size, as may be observed in the lower layers of the ice.

The much more diverse external dynamic deformations fracture ice formations, thus causing changes in either their outline and form, as well as hummocks and isostatic phenomena.

Wind, rough sea, sea currents, tidal phenomena, and the forces of gravity appear to be the chief factors determining the dynamic deformation. All these factors function differently in open sea and along the shore, on floating ice and on fast ice, on winter (cold) and summer (warm) ice, on solid and broken ice. Wind exerts the greatest influence on floating ice in an open sea; however, the rolling sea is the greatest deformative factor on the ice's edge. Along the shore, sea currents and tidal phenomena play a much greater role than the wind.

In winter, thermal, and especially dynamic, deformations occur with a distant din.

According to their statements, all polar explorers learn very quickly to distinguish by sound the changes occurring in the ice surrounding them in winter. Thus, at low temperatures, the formation of thermal crevices is accompanied by sounds which resemble harsh gunshots. The break-up of ice causes the most diverse types of sounds.

On the other hand, the quiet which accompanies the summer break-up impressed all the explorers, being sometimes far more grandiose in size than the winter break-up. Huge monoliths of ice broke off, sighed, and plunged, producing almost no noise. Furthermore, this occurred in the complete absence of wind. It is necessary to note that the dynamic deformations, which are determined by the different velocities of the various ice fields, depend on active forces and do not require high velocities for large-moving ice fields. Significant fissures and hummocks are sometimes formed, as it were, under completely calm circumstances.

According to the observations of Brusnev, hummock ridges, stretching along the New Siberian Islands, are found in quiet weather. They are the result of movement of one ice field along another which is immobile. Sometimes the ice hummocks rise to a height of 7 m, although the relative movement of the fields is imperceptible to the eye.

LITERATURE: 62, 77.

Section 92. Thermal Fissures

As we have seen, the temperature of the bottom surface of the ice fields generally remains constant. Consequently, with a temperature change in the upper layers, the bottom surface of the field will strive to preserve its dimensions, while the dimensions of the upper surface may change radically in one direction or another, depending on the salinity of the ice, its temperature, and the direction of the temperature change. Hence it follows that the ice field will sag in one direction or another under the influence of the surface-layer temperature, as long as thermal fissures do not appear on the top or the bottom of its surface (see figure 84).

If the temperature change forces the upper layers to contract, the fissures will appear on the upper surface. On the other hand, if the surface layers expand under the influence of the temperature the fissures will appear on the lower surface. Since the surface layers of ice are almost fresh, the upper surface of the ice will usually contract with a reduction in temperature and thus become covered with fissures. This phenomenon received the name of "frost cracks."*

*The frost crack is also characteristic of icebergs and glaciers. Icebergs also split into monoliths and sometimes, in the winter, disintegrate before your eyes. This is accompanied by harsh noises, which exceed in volume the noise of the break-up of ice fields. In the Alps, the noises in glaciers are always taken as one of the signs of a bad change in the weather.

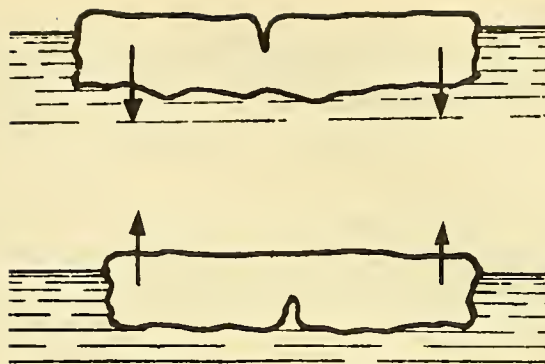

Figure 84. The formation scheme of thermal fissures. The forces causing the fissures are shown by arrows.

The fissures, once formed, are gradually filled from below by sea water, which freezes on contact with the cold ice; and from above by snow and water, which flows over them. In such a manner, owing to the temperature change of the ice, a constant ice accumulation and a cause for continuing tension occur. In the presence of a continuous ice cover, these tensions cause thermal jammings and the formation of small hummocks and ridges on the surface of the ice. These phenomena have already been pointed out by Nordenskjöld.

Thermal expansion and tension of ice is complicated by the fact that the surface of the ice, which varies according to the structure, is usually covered by snow layers of various thicknesses, which decrease the amplitude of the surface temperatures of the ice differently. Thus, toward the system of fissures, in the coldest (therefore the hardest and most brittle) surface ice layers. This system begins with very fine capillaries, proceeds in all directions, and interlaces, penetrating and separating the large areas of ice. According to Schirschov and Fedorov, after all the snow had thawed in the summer and the melted water had flowed off the ice, the ice field on which the station "North Pole" was built appeared covered with a net of more or less deep-surface fissures. When holes were dug in the ice, deep thermal fissures were repeatedly discovered.

According to the observations of the *Sedov* 25 March 1939 at 86° 26.5' north, 109° 41' east, in one 24 hour period the ice was covered by an unusual net of threadlike fissures; at the time the air temperature was about -39°.

Frost-cracking of sea ice continues all winter (especially with marked reductions in temperature) and is accompanied by a characteristic noise which reminds one of the reverberation of a gunshot. A number of the thermal fissures are filled with snow and water, which freeze on contact with cold ice and are done away with in such a manner. Others remain and prepare the ice, as it were, for a subsequent disintegration into separate parts, under the influence of suitable external forces. The presence of thermal fissures in ice should afford an explanation for the comparatively easy break-up of thin (even strong in appearance) ice fields, when sufficient areas of open water appear among these ice floes. Thus, in the middle of February, 1938, I observed how, near the shores of Greenland, the *Ermak* easily split ice blocks 3 to 5 m thick.

In some cases, thermal changes in the ice area can also have an immediate practical meaning.

As Barabanov and Richter point out, in the case of damage done to hydraulic installations from dynamic horizontal pressure of ice in the Neva Bay of the Gulf of Finland (impact of ice

blocks) it is not the periodic phenomena which are especially important. The intense, nonperiodic fluctuations of the sea level have a much greater significance, for stone piles and individual stones of earthwork embankments and pavements, which are frozen into the ice, are pulled from the ground with a quick and significant increase of sea level. Serious damage to the hydraulic installations is caused also by the expansion of the ice cover during the spring through solar radiation (thermal).

As an example of the last type of damage, the authors cite the inclination of one of the lighthouse towers in the region of the island of Kotlin. After the spring of 1926, the tower tilted $1^{\circ} 30'$ from the vertical, and toward March, 1927, the inclination of the tower reached $2^{\circ} 07'$ in the same direction.

Minute observations were carried out on the basis of these investigations to explain this phenomenon, and Barabanov and Richter arrived at the following conclusion. It appears that a continuous ice field, with one of its boundaries attached to the shore, expanded with the increase in temperature of the spring air, thus exerting strong pressure on such installations as the lighthouse tower. The extent of the stress depended on the height of the structure, within the limits of the normal thickness of the ice cover. This stress extended to significantly greater heights, with the size of the piled-up masses of ice from the previous fall and winter periods.

Fissures are extremely important in the construction of ice roads. The width of the thermal fissures on Lake Baikal sometimes reached 2 m. In the laying of a winter railroad before construction of the railroad circling the lake, the power in the formation was so great that the rails were split. The coefficient of linear expansion of the ice was almost five times more than that of iron. Bolts and fastenings were strewn in all directions, and the road was destroyed along some ten miles. During the first days of construction, doubts arose as to the possibility of an ice road across such a wide water stretch as Lake Baikal.

As Bernstein notes, fissures which stretched almost parallel to the road for 10 m characterize ice crossings. These fissures sometimes traverse the road at very small angles. They have a width of 4 to 5 cm at the top and a depth of 40 to 50 cm. With temperature increase, they are filled with melted water, which freezes with a subsequent temperature decrease.

Bernstein explains the origin of longitudinal fissures as follows: The ice under the railroad bed is always eventually cleared of the snow, thus becoming thicker than that in adjacent areas. With a temperature decrease, the ice surface not covered by snow becomes colder more rapidly. A difference in temperature, which also causes fissures, is thereby created. Bernstein notes that though snow removal from the road advantageously thickens the ice, it nevertheless causes detrimental longitudinal fissures. I do not believe that the thermal effect is the sole cause for the formation of longitudinal fissures on ice crossings. Ice is thicker on crossings where the snow has been removed; consequently, hydrodynamic forces raise the crossings. With the construction of roads on ice, the weight (cross ties, rails, etc.) exert a downward pressure on the ice. If these influences are not in equilibrium, it is understandable that the appearance of longitudinal fissures is inevitable. Bernstein recommends snow removal from the largest possible area along the tracks as one of the preventive measures against the damaging after-effects of fissures.

In 1942, I examined fissures along the tracks of the railroad across the River Kuznechikh to Archangel. The fissures were 10 m and 10 cm wide, with a funnel-shaped top. One had a measured depth of approximately 70 cm. The fissure was completely dry (the air temperature on this day was about -20°) and ran along the section cleared of snow, inside the wooden structure of the

railroad. I noted no change in the fissures as a 52 ton locomotive passed over the road. Such longitudinal thermal fissures are caused on ice roads which are constructed on fast ice.

Occasionally, "gorges" are formed at the intersection of two fissures. At first glance, these represent the greatest possible danger, but in the described case I did not notice any movement of the ice.*

When appraising the dangerousness of fissures, it is necessary to remember that in the course of time any breaks and fissures are gradually closed. As already noted, thin ice grows more quickly than thicker ice. Thus, a peculiar cushion of ice grows under each fissure, which compensates for its harmful influence.

LITERATURE: 17, 62, 76, 77.

Section 93. Wind Pressure on Ice Fields

Wind, with its pressure, exerts a double effect on ice fields: it moves ice fields (wind drift of ice, see Chapter 11), causing fluctuating movements of the ice fields, which are accompanied by wind waves behind it on the ice cover and break-up of the ice fields.

Let us assume that air molecules move in the wind with one and the same velocity and in one and the same direction (horizontal). Let us further assume that a hummock is situated on the ice field with the slope toward the wind (figure 85).

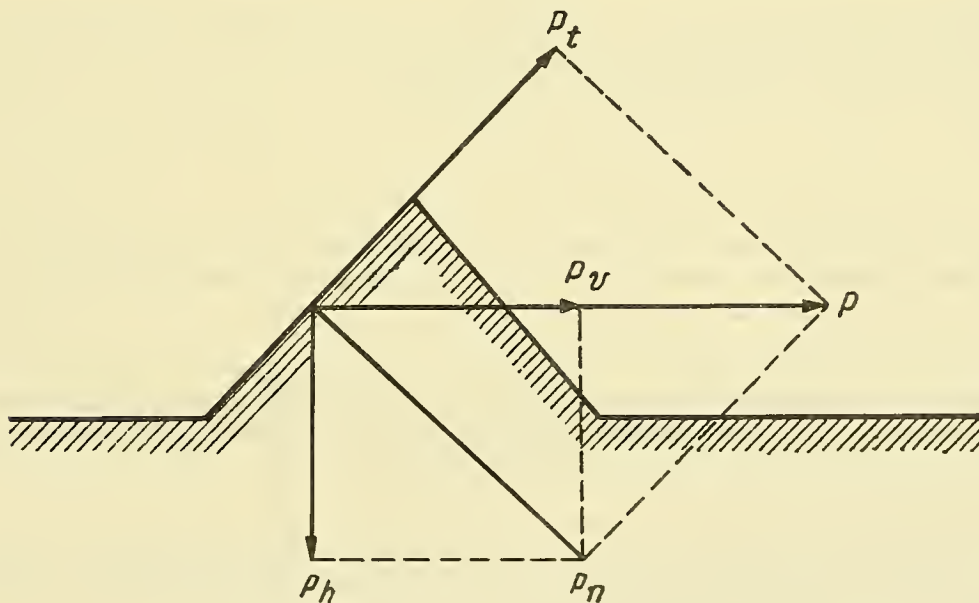

Figure 85. Pressure of the wind on ice hummocks.

*The road foreman described to me how he attempted to fill the fissures and gorges with water. He noted that the ice formed from the poured water did not hold fast to the main mass of ice.

If we resolve the pressure of the wind into its component parts, we obtain

$$p_n = p \sin \alpha, \quad (1)$$

$$p_t = p \cos \alpha, \quad (2)$$

where p_n is the wind pressure on the plane, perpendicular to the wind--the active force-power of the wind; p_t the pressure gliding along the windward surface of the hummocks (therefore, insignificant in the first approximation of the movement and heaping of ice); p the pressure in the direction of the wind; and α the slope angle of the hummocks.

Resolving further the operating power-force of the wind on the vertical and horizontal components, we obtain

$$p_h = p_n \sin \alpha = p \sin^2 \alpha, \quad (3)$$

$$p_v = p_n \cos \alpha = \frac{p}{2} \sin 2\alpha, \quad (4)$$

where p_v is the moving force of the wind, or the power-force, which causes the drift of the ice; and p_h is the drowning power of the wind, or the power which causes vertical fluctuation of the ice cover.

From formulas (4) and (3), it follows that the wind attains its maximum moving force with ice blocks having perpendicular walls. However, the maximum drowning force of the wind is attained with hummocks having slopes of 45° . In this case, we have

$$p_v = \frac{p}{2}. \quad (5)$$

Furthermore, we know that the wind pressure on a unit area, perpendicular to the wind, is approximately proportional to the square of the wind velocity,

$$p = aw^2, \quad (6)$$

where w is the wind velocity; a is the coefficient of proportionality.

From the formulas cited above, it follows that with an adequate wind velocity and with a small hummock-floating, the drowning power of the wind may be greater than the floating of the hummocking and thus cause it to sink.

Since the drowning power-pressure of the wind is determined also by the inclination and the area dimensions of the windward slope of the hummock, individual parts of the ice fields with an irregular upper surface are subjected to various stresses. This generates vertical movements of separate parts of the ice field, and thus its eventual break-up.

In the derivation of the cited formulas, I took into consideration the laminar motion of the air current, but the air is turbulent and its vertical components create disproportionate stress, even on completely level fields. As a result, vertical fluctuations are caused in the ice, similar to a wind wave on the surface of the sea.

Observers repeatedly noted the appearance of wind ripples on the thin ice. Bernstein points out that the instrument observations carried out in 1927 on the Volga established, without a doubt, the origin of the wind fluctuations of the ice level. Thus, with a wind of 13 m/sec. (which

corresponds to a pressure of 21 kg/m^2 on a surface perpendicular to the wind), a constant agitation of the ice (irregular periods of 20 to 180 sec.) was observed. The amplitude reached 3 mm (figure 86). In calm weather, fluctuations of an equal order were not observed.

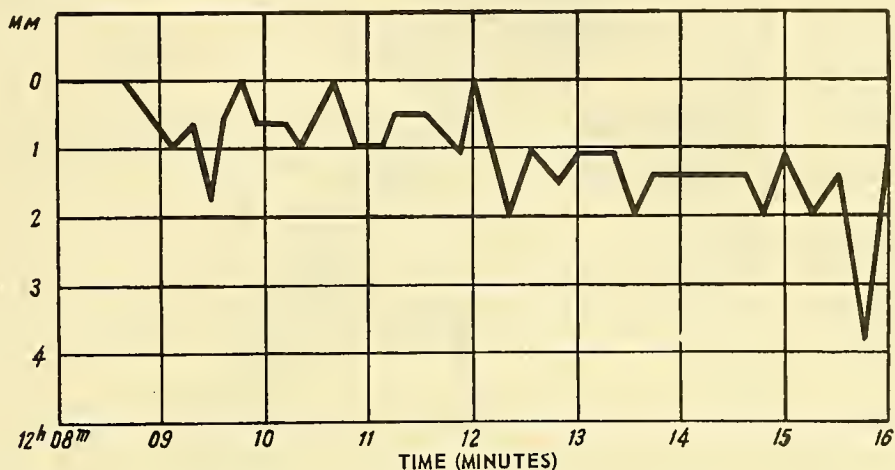

Figure 86. Wind fluctuation of ice on the Volga.

LITERATURE: 17, 77.

Section 94. Break-up of Ice Fields

Let us assume that initially we have a large ice field. With diverse conditions existing in the sea, the examined field cannot be equally durable and vigorous in its entire extent; this is not possible since it usually consists of comparatively small ice blocks which are frozen together. Even if the field is initially completely homogeneous, it will be gradually covered by a set of thermal and dynamic fissures. The external forces of a different order, which have a varying effect on individual parts of the field, cause tension of a distinct order. When these tensions exceed the limit of plasticity of the weakest parts of the examined field, it separates along the lines of least resistance.

Of the external forces which fracture ice fields, sea current and tidal phenomena are most important in the Littoral Belt, while in the open sea the wind exerts the greatest influence on floating ice.

The appearance of fissures in the ice fields naturally precedes the break-up. Sometimes ice hummocks result from the contact of large ice fields and thus border the fields. Moreover, large fissures are not observed.

During powerful jammings, large fissures are found which run across the entire field, fracturing it into large sections.

It was established from a trial durability test of materials that the length of the test model must not exceed five times the dimension of the smallest magnitude of its transverse section. Otherwise, the model is bent and cracked with jamming even with the comparatively largest ice blocks, where the horizontal dimensions often surpass the vertical. Thus it is necessary to regard the formation of fissures accompanying ice jamming as entirely natural.

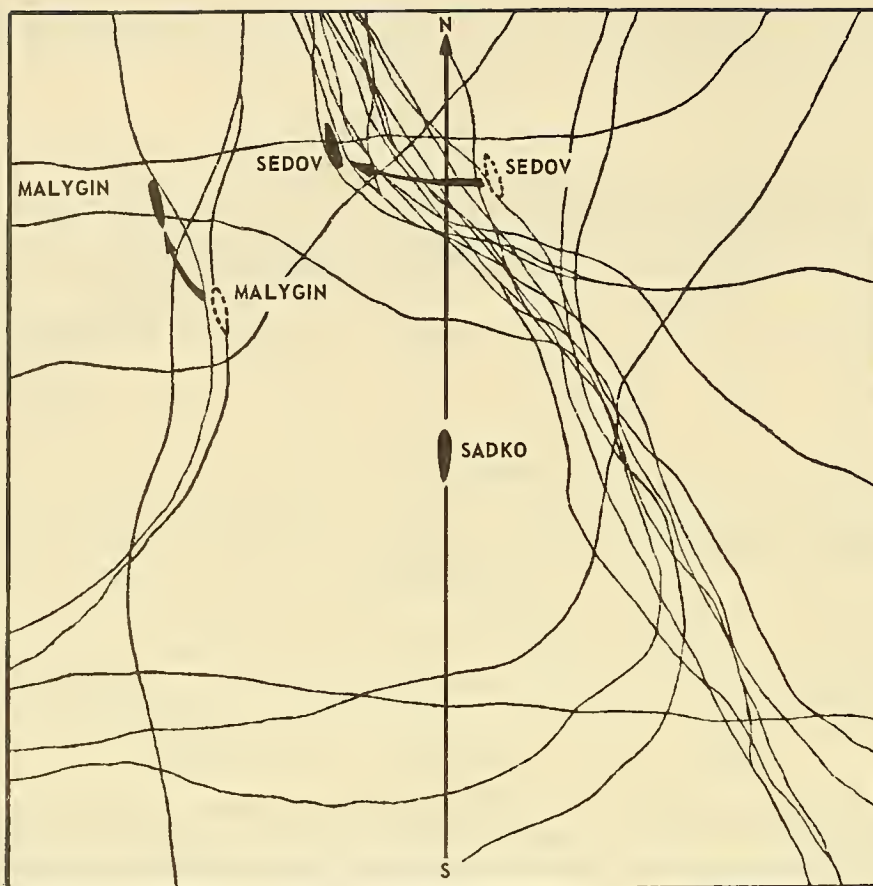

Figure 87. The location of the fissures in the region of the drift of the *Sadko* from November through December 1937.

Figure 87 corroborates that well. Figure 87 depicts Gordeev's sketching of the disposition of the icebreakers *Sadko*, *Malygin*, and *Sedov*, which drifted with the ice in the northern part of the Laptev Sea, as well as the dynamic fissures formed from November, 1937, to January, 1938, in the region of the drift. The drawing gives the relative shift of the ships for that period.

It is curious to note that in November, 1937, the fleet of ships drifted approximately in a northerly direction as a result of the southeast wind. At the end of November, the winds were from the southwest; during December, the ships drifted east-northeast. It is clearly shown in the sketch that the principal directions of the fissures were approximately perpendicular to the prevailing wind.

In 1934, during magnetic observations on the ice of the Chukchee Sea (after the destruction of the *Cheliuskin*), Fakdov set up two identical perpendicular surfaces on an artificial, leveled terrace. He observed that the ice began to fluctuate from time to time along them. After an analysis of his observations, Fakidov arrived at the following conclusions:

1. Wind appears to be the chief cause of ice fluctuation.
2. The greatest range of fluctuation is observed to be in the direction of the wind.

3. With the same wind force, the fluctuations increase with the stoppage of drift and, in particular, with the break-up.

4. Appearance of ice fluctuation anticipates the wind.

Vertical ice fluctuations, which are caused by the wind even with a smooth ice surface, involves break-up of a field into parts, superimposition of one block on another, and ice heaping.

In such seas as the Barents and Greenland Seas, where the ice edge is clearly defined, the wave is also important in the break-up of ice fields in addition to the action of the wind. This is corroborated by the observations of the station "North Pole" and the *Sedov*.

The drift of the ice fields of the station "North Pole" first occurred quietly. The winterers occasionally discovered fissures, which were formed in connection with the temperature changes. They did not observe ice hummocks and powerful shocks till the end of January, 1938. Even rotation of the ice fields around the vertical axis were comparatively small, especially at the beginning of the drift.

The first powerful shock was observed on 20 January 1938, and the first fluctuations of the theodolite level were discovered on the following day (the ice field was located in the Greenland Sea about 77° latitude). Without a doubt, this was related to the fact that the entire month of January was stormy in the Greenland Sea. The wind velocity often reached 30 m/sec. Since the eastern part of the Greenland Sea is always ice-free, the ice fields began to move somewhat as a result of this wind force.

On 26 January, a storm set in which lasted six days. The ice field began to undergo more powerful oscillations. The period of these oscillations was 10 to 12 seconds and was the sum of the waves period and the period of its own fluctuations. The inclination of the ice field reached 60 angular seconds or more. As a result of these oscillations, tensions were generated in the ice field, which finally caused it to break up on 1 February along lines approximately perpendicular to the wind direction. A large surge undoubtedly caused these fluctuations and thus the break-up of the ice field. The surge was caused by stormy winds in the neighboring ice-free areas of the Greenland Sea and spread in all directions according to a general law.

On 2 January 1940, the first oscillations of the *Sedov* were observed by fluctuations of the theodolite tube at 81° 01.9' latitude and 3° 18' longitude. The fluctuations occurred in the plane of the meridian with a periodicity characteristic for a surge. At this time, the ice edge was not located north of 80° latitude.

On 12 January 1940, it was noted in the log of the *Sedov*:

"2100, significant surge 30 m--when the ridge passed, ice was raised a little and broke open. When the base of the wave had passed, the ice rejoined with a creak, characteristic of jamming. The phenomenon occurred with a periodicity, characteristic for a heavy sea of 9-10 sec."

LITERATURE: 11, 41, 42, 62, 77, 131.

Section 95. Rotation of Ice and Its Break-up

The break-up of ice fields occurs quite often during the rotation of ice, which is caused by various factors. The first systematic research of the causes of ice rotation was carried out by Gakkel and Khmyznikov during the expedition on the *Cheliuskin* in 1933-34.

Let us assume that ice belts, consisting of several blocks, move along a rectilinear shore (figure 88). If the ice is very firm, the littoral belt remains immobile as the seaward belt glides

along it. If the ice blocks can move freely, the ice blocks at the rate relative to the ice drift will rotate clockwise in connection with the friction of ice blocks against the shore, with a smaller velocity of current at the shore, and with other conditions. In 1933-34, the drift of the *Cheliuskin* began on 21 September 1933, at Cape Vankri in the Chuckchee Sea (figure 158). At this time, the ship was surrounded by solid ice hummocks.

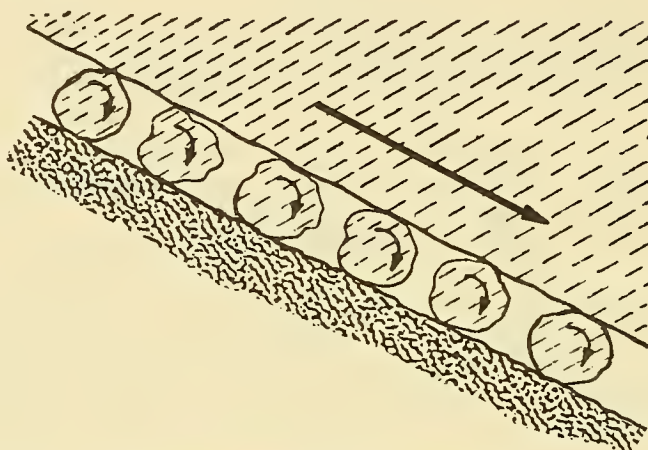

Figure 88. Rotation plan of ice with drift along a rectilinear shore.

At first, the ship drifted with the southwest wind along the shoreline to the southeast. With the same wind force, the heaping of young ice between old ice gradually increased. The drift was simultaneously slowed down. According to Gakkel and Khmyznikov, these phenomena were caused by the contact made by the ice drifting around projecting Cape Onman. At least, after passing this cape, the drift accelerated.

Gradually, the ice belt with which the *Cheliuskin* drifted was pressed toward the shore, and on 23 September, when the ship was 7.3 miles east-southeast of the island Koliuchin, the drift of the ship discontinued. One mile north of the ship, the ice continued to drift southeast. A sharp rectilinear edge was formed at the junction of the immobile and drifting ice. Between its polished vertical walls, there was a narrow (about a meter) strip of rubbed ice. After about 12 days, the ice field with the *Cheliuskin*, having been shifted by the wind, broke off from the fast ice and resumed its course to the southeast.

On 28 and 29 October 1933, when the *Cheliuskin* was at Cape Serdtse-Kameni, the course of the belt was changed 165° in a clockwise direction for two days. This was the most powerful (angular velocity reached 10° per hour) rotation of the ice for the entire drift period. Gakkel and Khmyznikov note that this rotation was not caused by the wind, since the winds were steady and from a southwest direction, but by the resistance given the ice drift by Cape Iukagir.

The rotation was caused by other factors, which were also analyzed by Gakkel and Khmyznikov. These depended on the distance of the *Cheliuskin* from shore.

From the morning of 5 November to the morning of 6 November 1933, the rotation of the ice field of the *Cheliuskin* was clockwise, with a steady six-point east wind, which could be explained by influence of the fast shore ice. The wind direction began to change in a clockwise direction. In connection with this, the ice field began to turn counterclockwise; i. e., in the converse direction.

Similar phenomena were observed in other cases, and Gakkel and Khmyznikov explain them in the following way.

It was noted that in the majority of cases, the corresponding drift of the ice outstrips the wind which caused it.

With regard to the slowness of the wind, an observer, being, for example, at one end of this immobile ice field, notes drift which begins during a calm. The wind, blowing at the opposite end of the field, caused the ice to move relative to the observer before the wind reached the observer. Some time had already elapsed before the wind reached the observer. If the wind direction changes at the opposite end of the field, in addition to the progressive movement, usual with an established or prevailing wind, the field begins to rotate since the different ends of the field will be subjected to different wind directions.

From these simple considerations, we can readily see that with constant winds ice fields move lineally, but with a change of wind they begin to rotate in a direction opposite to that of the wind.*

On 12 November 1933, owing to a suitable wind, the western part of the *Cheliuskin* ice field moved over the western boundary of the currents from the Bering Strait. As a result of the continued influence of the wind and current, the angular velocity of the ice field reached 4° per hour (counterclockwise). According to Gakkel and Khmyznikov, the increase in the ice rotation was the result of two ends of the ice field being located in regions having sea currents of different velocities.

The ice rotation with which the *Cheliuskin* drifted continued sufficiently intensive until the end of November, 1933, when the *Cheliuskin* was at least 60 miles from shore.

Gakkel and Khmyznikov explain the velocity decrease of the ice rotation, which had begun at the end of November, as follows: At this time, the winter was established in the Chuckchee Sea--it was filled with ice to such an extent that any movement of ice was difficult.

It is clear that with rotation of the ice fields, collisions, which are accompanied by heaping and breakup of ice, are inevitable. Such phenomena were observed up to the destruction of the *Cheliuskin*, which was a result of fissures and hummocks caused by a six-point wind.

At 1320, 13 February 1934, the ice drift in which the *Cheliuskin* was frozen discontinued suddenly. Following this, the fissure at the stern of the ship, which had been formed on 7 February, began to separate. That part of the ice northwest of the ship started to move, drawing the ship behind it along the edge of the immobile ice on the southeast side of the ship. The ice along the side of the *Cheliuskin* began to be heaped. On the starboard side of the ship, the blocks moved under the hull; on the port side, however, the ice was forced upwards.

At 1330, the *Cheliuskin* was hooked by its stern to an entire field which had not been touched by the preceding jamming. Since only the ship was stopped, its port side was torn by the windward ice, which continued to drift.

*See Section 138.

At 1430, greater damage had been inflicted on the ship by the strong ice pressure, and at 1600, 13 February 1934, the ship sank.

After the catastrophe of the ship, the participants of the expedition from the *Cheliuskin* crossed the ice and stayed until 13 April 1934, at the so-called "Camp Schmidt." On this day, the last participants of the expedition were taken from the ice by airplanes.

During the time of the sojourn on the ice, Gakkel and Khmyznikov continued their interesting observations, which were the first in this respect. The ice continued to drift (obeying the wind and the current) to rotate, to be heaped, and to be fractured. Figure 89 shows the plan of Camp Schmidt for 8 March 1934.

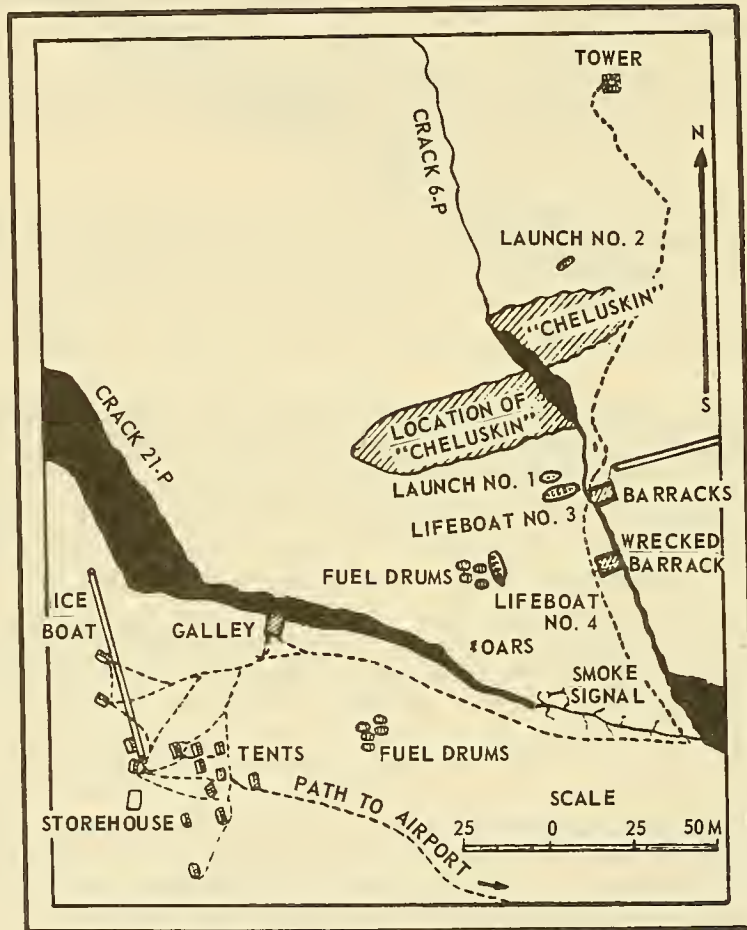

Figure 89. Plan of Camp Schmidt.

The fissures, which were formed during the existence of a camp, are shown in addition to the movements of the ice fields relative to one another.

The ice field of the station "North Pole" underwent practically no rotations, relative to the meridian, during the drift from the North Pole to the Greenland Sea. The ice with which the

Sedov drifted, generally moved quite calmly. The ship experienced sharp rotations only with sharp wind changes, which were accompanied also by sharp changes in the direction of the drift. Fissures, breaking up, and heaping of ice occurred simultaneously.

Thus, on 12 November 1938, it was observed on the *Sedov* that the ice began to move in an unusual manner after the southeast wind, with a force of 7 to 8 points (which blew for a period of 48 hours), had been replaced by a powerful southwest wind. A fissure passed at 50 to 70 m from the ship and widened up to 10 to 15 m. An open patch of water (polynya) 100 x 150 m square was formed on the starboard side of the ship.

Hummocks appeared simultaneously in all directions. The course of the ship changed quickly from 100° to 75°, and later turned to 87°.

Thus, rotation inevitably results from collision of ice fields and ice blocks which have some freedom of movement relative to one another, such as when they are situated in sea currents which differ in velocity and direction or become subject to wind which acts differently on various ice blocks with regard to their size and form. The ice fields begin to collide and to rotate; as a result, their sharp corners break off gradually and become worn. If viewed from the top, the ice blocks have a characteristic, monotonous, oval form. Only ice blocks which have not been separated from ice fields, and broken-up ice fields which cannot undergo any further break-up because of solid ice, retain their initial angular contour. This process is particularly characteristic of warm ice; i. e., for spring and summer.

LITERATURE: 38, 72, 77.

Section 96. Break-up of Fast Ice

As we have seen, the break-up of ice fields in the open sea occurs as a result of wind action, sea currents, and ice fluctuations. The break-up of fast ice occurs as a result of the same factors. Naturally, it is necessary to distinguish the break-up of fast ice at the shore, which is open to the sea, and that of fast ice in closed bays and narrow straits.

The break-up of fast ice in open shores, even with solid ice present in the sea, may occur during the entire winter. Thus, e. g., at Cape Cheliuskin, in the winter of 1942-43, fast ice broke up four times before the end of March: 5 and 24 November, 27 January, and 25 March.

On 24 November, the center of an intense cyclone was situated between Franz Joseph Land and Novaya Zemlya (pressure: in the Bay of Tikhara, 981.6 mb, on Cape Cheliuskin 1010.7 mb). Over the entire Kara Sea, a southwest storm reached a force of eight marks or points. As a result, the fast ice at Cape Cheliuskin was fractured.

On 26 January, the center of a vigorous cyclone was situated toward the north of Franz Joseph Land (pressure: in the Bay of Tikhara 980.9 mb, on Cape Cheliuskin 1010.2 mb). On 27 January, the center of the same cyclone moved to the northern part of Severnaya Zemlya (pressure: on the Island of Domasch 984.5 mb, on Cape Cheliuskin 1000.6 mb, and at Tiksi Bay 1035 mb). A stormy southwest wind reached a force of 8 to 9 points. As a result, the fast ice at Cape Cheliuskin was fractured. Furthermore, on 28 January, an unusual rise in the level to 1.25 above the normal was noted at Cape Cheliuskin. This increase was evidently connected with observed storms. Some small barges and mooring ropes were damaged at this time.

On 25 March, the center of a cyclone was situated northeast of Severnaya Zemlya (pressure: on the Island of Domasch 992.6 mb, on Cape Cheliuskin 1000.3 mb). A storm with a force up to eight points was located over the northeastern part of the Cheliuskin Sea. As a result, the fast ice (thickness 73 to 78 cm) was broken up at Cape Cheliuskin.

On the basis of the cited cases, it follows that the break-up of durable fast ice at shores, open to the sea, may occur at any time during the winter under appropriate meteorological conditions in spite of the great strength of floating and fast ice.

I consider that all these phenomena result from waves generated in the ice cover as the result of the storm. The waves are propagated in the water masses under the ice. The ice cover bends in conformity with the form and velocity of the propagation of these "water" waves. This ice cover is only a thin, partly plastic and partly brittle film, which is bent at some places, according to the form of the water wave, while at other places it is broken open.

The most interesting phenomena are, of course, those during the storm, 26 to 28 January 1943, when the fast ice at Cape Cheliuskin was gradually broken open. A huge wave rolled in Tiksi Bay, in spite of the fact that the entire sea was covered by solid 9-10 ice with a thickness of more than a meter. This wave recalls the phenomenon called "sea bar" by the fishermen of the German Baltic.

A roller, with a height of 1 to 2 m, appears on the surface of the calm sea, accompanied in various cases by smaller waves. This roller approaches and breaks on the shore with foam and spray. A special investigation affirmed that the sea bar was caused by a sharp change in the atmospheric pressure, sometimes in distant regions of the Baltic Sea. It is also known that the sea surge formed as a result of storms can cover large distances. Thus, e.g., on 1 March 1886, an unusual surge with a length of 400 m and a velocity of propagation of 25 m/sec, was noted at the Island of Voznesenie. This surge occurred on 25 February in the region (40° north, 55° east) and covered 3,640 miles in 100 hours.

It is clear that the ice cover softens these phenomena and that a combination of various circumstances is necessary for their distinct development. With the exception of the enumerated cases, observations of this type are unknown to me. Thus conclusions are not possible.

LITERATURE: 62, 77.

Section 97. Theoretical Concept of Ice Heaping

The dynamic deformation of ice cover appeared most intense in ice heaping ("hummocking").

Hummocking is a complex process. It may be caused by various factors and occurs differently in ices of different thickness and durability. Thus, it is difficult to sum up the theoretical basis of the process of hummocking. Moreover, it is necessary to examine only the first step in this respect.

In order to simplify the considerations, I assume that at the time of hummocking, neither thawing nor accretion by freezing occurs, and that the ice appears absolutely as an inelastic body; in other words, only residual deformations are created within it.

The following chief processes may be distinguished in hummocking:

1. The firmness of ice, which results in the destruction of the spaces between the ice blocks ("beams").
2. Ice packing, which results from squeezing air and brine bubbles from the ice.
3. Fracture and break-up of ice into the largest or the smallest fragments.
4. Formation of hummocks, which consists of the moving of ice fragments to the upper surface of the ice and the packing of fragments under the ice.

Let us assume that we have two ice fields, moving in one direction with different velocities. After collision, the united field will move with a common velocity where m is the mass of the ice field.

$$v = \frac{m_1 v_1 + m_2 v_2}{m_1 + m_2}, \quad (1)$$

The kinetic energy, according to formula (1), of the united ice fields after the collision will be

$$E = \frac{mv^2}{2} = \frac{m_1 + m_2}{2} \left(\frac{m_1 v_1 + m_2 v_2}{m_1 + m_2} \right)^2. \quad (2)$$

Before the collision, the energy of the first field was $E_1 = \frac{m_1 v_1^2}{2}$

while that of the second was $E_2 = \frac{m_2 v_2^2}{2}$.

Consequently, the energy of the two fields was

$$E_1 + E_2 = \frac{m_1 v_1^2 + m_2 v_2^2}{2}. \quad (3)$$

Subtracting (2) from (3), we obtain the kinetic energy lost in the deformation of the collided ice fields; namely

$$\Delta E = \frac{m_1 m_2}{m_1 + m_2} \frac{(v_1 - v_2)^2}{2}. \quad (4)$$

It is evident that if the second field is not mobile, then

$$\Delta E = \frac{m_1 m_2}{m_1 + m_2} \frac{v_1^2}{2} = \frac{E_1}{1 + \frac{m_1}{m_2}}, \quad (5)$$

where E_1 is the energy of the first field.

If the mass of the second field is immeasurably great, compared to that of the first field, then from formula (5), we see that the total energy of the first field is expended in the deformation.

Let us now assume that a rectangular ice field was pushed up on a straight vertical shore (figure 90) with one of its sides perpendicular to the shoreline.

Its energy, before coming to rest at the shore, was equal to

$$E = \frac{mv^2}{2} = hlb\delta_i \frac{v^2}{2}, \quad (6)$$

where h is the thickness of the ice field, l is the length of the ice field, b is the width of the ice field, δ_i is the ice solidity.

As we have seen, the loss of kinetic energy is expressed in the packing, smashing, and hummocking formation. In the last process, part of the ice fragments move on to the ice, while a part is crammed under the ice. In such a way, kinetic energy is transformed into potential energy. It is necessary to note that kinetic energy, causing deformations of ice fields, is not the same at all points of the ice field. At an external edge (figure 90) of the ice field, it is equal to 0; at point a , at the same distance from the shore, it is equal to

$$E_x = h(l - x) b \delta_i \frac{v^2}{2}. \quad (7)$$

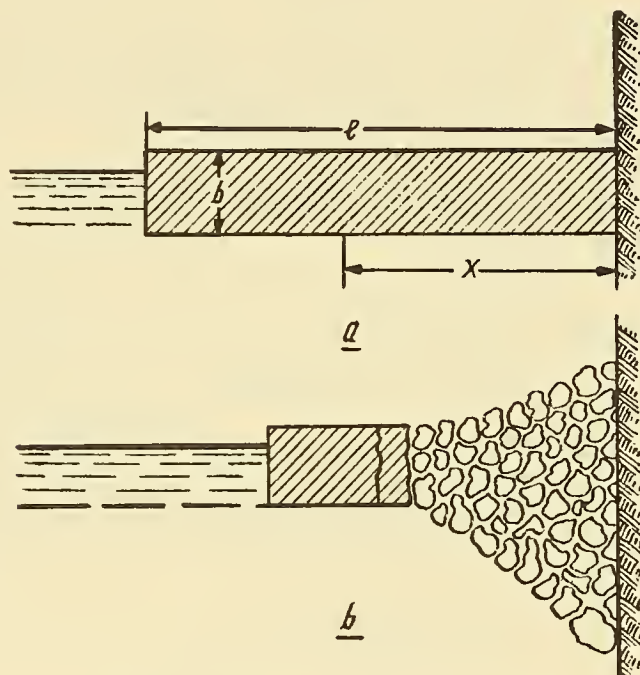

Figure 90. Heaping on a vertical shore.

Finally, at the shore, the kinetic energy is defined by formula (6). In such a way, the kinetic energy causing the deformations increases along the direction from the sea edge of the ice field toward the shore. It is clear that the work which can be produced due to the loss of energy by the parts of the ice field which are more distant than the distance x from the shore can be shown adequate only for a certain packing of the ice but not for its break-up.

At a point situated at some distance from the shore, with a smaller x , the kinetic energy of the left part of the field appears satisfactory, both for packing and for smashing of ice, but inadequate for formation of hummocks, and only beginning with a distance of significantly smaller x from the shore can the kinetic energy appear adequate for all three processes: packing, break-up and hummock formation.

In figure 90, the above- and below-water parts of hummocks, the belt of completely broken-up ice, the belt of jammed ice, and also the motion for the time of the hummocking of the border of ice field in the direction toward the shore are shown.

From the assumption, the volume of the ice is not changed with hummocking; it clearly follows that the volume of the over-ice (V_h) and under-ice (V_z) parts of the ice hummock are exactly equal to the volume, to which the ice field was reduced during hummocking; that is

$$V_h + V_z = ha\Delta l. \quad (8)$$

It is natural that in the examined case the hummock reaches the greatest height and depth at shore. The seaward height of the ice hummock decreases in such a way that natural slopes are formed over and under water, which are characteristic for fragments of ice of a given size.

If the ice field pushes up on a shallow shore rather than a vertical shore, depending on local conditions of ice hummocking in the full sense of the work, that also cannot occur. All kinetic energy in such a case can be expended in jamming, break-up, friction of the lower surface of the ice field against the shore, and in movement of the edge of the ice field on to the shore.

If the ice field is pushed up onto fast ice, the process proceeds in accordance with the same principle, in the case of movement of ice on to shore, with the difference that jamming, break-up, and ice-hummock formation extend also to the seaward ledge of the grounded ice. It follows from that, that with other similar conditions (other conditions being equal) the directions of the ice heap, which is formed with a collision of the ice field and fast ice, are greater in area and less in height than with the movement of the ice field on to a steep shore.

With flat ice fields, thin and yet plastic enough, ice hummocking can be discharged in some packing of them, and movement of the edges of the ice fields on to one another without preliminary break-up.

Returning to the case of an ice field which is pushed up on a steep shore, we see that the loss of energy is equal to all the kinetic energy of the ice field, or

$$\Delta E = \frac{mv^2}{2}.$$

From the formula, it follows that with one and the same durability, one and the same effect can be attained either by an increase of velocity or an increase of mass of the ice field. The greatest velocity of drift is observed at that time when the ice fields, twisted and strained from shore by suitable winds, are driven along clear water to the shore with an inverse change of the wind direction. But the masses of ice fields are of such size that even with the very smallest velocities of the ice fields huge hummock formation takes place.

As we have seen, the dimensions of ice hummocking are determined by the loss of kinetic energy.

Having distinguished three basic processes of ice hummocking, we get

$$\Delta E = \Delta E_1 + \Delta E_2 + \Delta E_3, \quad (9)$$

where ΔE_1 is the loss of energy in jamming, ΔE_2 is the loss of energy in break-up, ΔE_3 is the loss of energy in formation of ice hummocks.

It is possible to assume that the loss of energy in jamming of ice is insignificant, as compared with other losses. The energy expended in the complete break-up of ice hummocks is greater the thicker and firmer the ice. The energy expended in ice-hummock formation is more according to the size of the ice hummock; in other words, the greater the decrease of the length and the greater the thickness of the ice field, the more energy is expended.

The durability of the ice depends to the greatest degree on its temperature. From that, it follows that significantly less energy is expended in the break-up of warm ice than in the break-up of cold ice of the same volume.

As regards to the dimensions of the formation of ice hummocks, we have seen that

$$bh\Delta l = V_h + V_z = \frac{b}{2}(H_h a_1 + H_z a_2), \quad (10)$$

where V_h is the volume of the part of the ice hummock over the ice, V_z is the volume of part of the ice heap under the ice, Δl is the decrease in length of the ice field, H_h is the height of the above-water part of the ice hummock over the top surface of the ice field, a_1 is the range of the above-water part of the ice hummock from the shore, H_z is the depth of the underwater part of the ice hummock under the lower surface of the ice field, a_2 is the extent of the underwater part of the ice hummock from the shore.

But if the ice hummock is isostatically counterbalanced, (see Section 103), then

$$a_1 = a_2 = a, \\ H_z = H_h \frac{\delta_i}{\delta_w - \delta_i},$$

where δ_i is the ice density, δ_w is the water density.

From formula (10), we derive

$$h\Delta l = \frac{a}{2} H_h \frac{\delta_w}{\delta_w - \delta_i}. \quad (11)$$

According to the observations, the angle of the slope of above-ice part of hummocks is about 30° ; in such a case, it is approximately

$$a = 2H_h, \\ h\Delta l = H_h^2 \frac{\delta_w}{\delta_w - \delta_i}. \quad (12)$$

Let us assume that a rectangular ice field, with width b and length ℓ , was hooked by its side to the shore. It is clear that if the winds blow perpendicular to the shore, the force of the pressure of the ice field on the shore will be equal to

$$F = kblw^2, \quad (13)$$

where w is the wind velocity, k is the coefficient of proportionality, depending on the unevenness of the upper and lower surfaces of the ice, and also on other circumstances. It is natural that at a distance x from the outer border of the field, the forces being caused by the movement of the left side of the field compress the given field and will be equal to

$$F_x = kbxw^2,$$

and the average normal tension

$$\sigma_x = \frac{F_x}{bh} = k \frac{x}{h} w^2. \quad (14)$$

It is clear that the average tension will increase along the direction from the windward salvage of the field toward the shore, and at a certain distance may appear equal or even greater than the boundary of plasticity of the jammed ice field of the given thickness. In the last case, at such a distance, breaking open the ice field, its fracturing and subsequent hummocking are inevitable.

As direct observations show, ice hummocking, which is caused among the spacious ice fields by wind, is distinguished according to its character from ice hummocking which is caused by pushing up of ice fields on the shore or on fast ice. In the latter case, ice hummocking is concentrated at the shore and at the salvages; in the first case, ice hummocking is distributed more or less proportionally on the whole area of the region covered by ice hummocking. It follows from that that the thickness of the ice which is hummocked by the wind is approximately equal in the entire region of the ice hummocking.

Let us note further that the capability to cause ice hummocking with every wind is limited entirely by the specified thickness of the ice. After the attainment by the ice of this limited thickness, a wind with the same force blowing even during the course of lengthy periods of time cannot cause any new ice hummocking.

Taking into consideration the circumstances of ice hummocking, I consider we accept that

$$\Delta l = a \frac{l}{h^2} (w - w_h)^2 T, \quad (15)$$

where Δl is the decrease in length of the ice field in the direction of the wind,

l is the length of the ice field in the direction of the wind,

h is the ice thickness,

w is the wind velocity at a given moment,

w_h is the wind velocity at which the ice of a given thickness is hummocked, or the velocity of the ice hummocking wind,

T is the time,

a is the coefficient of proportionality.

It is natural that formula (15) is applicable only in that case when the velocity of the affecting wind is more than the wind velocity which hummocks ice of a given thickness (with the same durability).

In formula (15) variables appear: the length of the ice field (gradually decreasing), the average thickness of the ice (correspondently increasing), the velocity of the ice-hummocking wind (proportional to the ice thickness, also gradually increasing), and finally the gradually increasing time.

From formula (15), it is easy to see that the decrease in the length of the ice field in the direction of the wind, and consequently also the dimensions of the ice hummocking with the elapse of time, approach 0.

LITERATURE: 77.

Section 98. The Aspects of Ice Jamming

It is possible to divide ice jamming into three aspects, according to origin:

1. Thermal - the weakest, which takes place under exceptional conditions.
2. Tidal - which is caused by the non-simultaneous change of the velocity and direction of the tidal currents at a close interval.
3. Wind - the most powerful ice jamming, which exerts the greatest forces during pressure winds on the shore or on fast ice.*

According to external form, three aspects of ice jamming are distinguished:

1. Marginal, which consists of formation of an inclination of comparatively large broken, open fields into a vertical state, with relatively small piling up of fragments on one another.
2. The complete breakup of the collided edges of ice beams with a subsequent piling up of ridges and rollers which consist of fine fragments.
3. The pushing up of flat ice beams on one another, which is observed often, particularly with pancake or young ice.

Usually, all these aspects accompany one another, but with the predominance of the first aspect a hummock ice jam of marginal crushing type is obtained (figure 91); with the predominance of the second, the hummock from complete breakup (figure 92) and with the predominance of the third, packed ice (rafting). It is clear, that the dimensions in both these and other ice jams depend also on the relative speed of movement of the mass of the collided ice beams.

According to the observations of *Zarya*, the ice hummock forms from the complete breakup of the ice as characterized more by the limited area than by the great height with an angle of 20 to 30°. Among floating ice, the ice hummock formed from marginal crushing seldom reaches a height more than 5 to 6 m, while the ice hummock from a complete breakup is 6 to 8 m high. The height of a packed ice hummock is usually less.

As Nansen indicates, at the time of his journey along the ice of the central part of the Arctic Basin, he had a chance to see an ice hummock 7 m high. "The highest hummocks, which were measured by me, and there was enough of that type," adds Nansen "were from 5.5 to 7 m high, and I can positively affirm that the piling up of sea ice to heights greater than 8 m is a rare exception."

*Ice jamming sometimes results with flowing of the current under fast ice, but these cases are rare.

The height of the largest ice hummocks, which were measured by Gakkel and Khmyznikov in the Chuckchee Sea (in the region of the catastrophe to the ship *Cheliuskin*) ($68^{\circ}18'$ north, $170^{\circ}50'$ west) was equal to 7.2 m, measured from the level of the water.

The dimensions of the largest ice hummock which was measured by Badigin on 24 March 1939 at the time of the drift of the *Sedov* at $86^{\circ}27.6'$ north, and 109° west were in meters: height 6.1, width 32, length 60. The remaining measured hummocks were significantly lower; their average height was about .5 m.

In the boundary parts of the Central Arctic Basin, the height of the hummocks may be more. Thus, Markham encountered ice columns up to 13 m high at the north end of Grinnelevaya Vemlya.

The chief formation of ice hummocks from marginal crushing or from complete breakup depend on the physical and especially on the mechanical properties of ice.

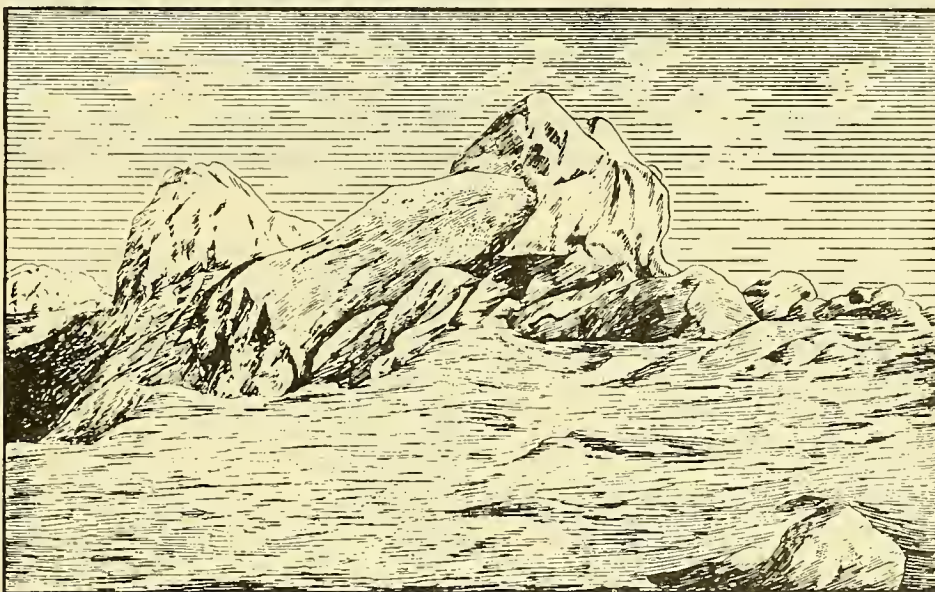

Figure 91. An ice hummock from marginal crushing.

In ice heaps on jams from marginal crushing, separate pieces of ice represent sometimes surprisingly accurate forms of cubes or parallelepipetes. I saw such ice hummocks, for example, in the northwest part of the Barents Sea. Usually, separate pieces of ice in ice hummocks formed from the complete breakup are not so accurate and regular in form. Ice heaps resulting from marginal crushing are, in general, characteristic for less durable annual ice, while ice heaps resulting from the complete breakup are characteristic for standing and powerful ice fields, whose edges usually they border. Since the durability of ice increases generally with lowering temperatures, the ice hummocks from marginal crushing are formed more often in summer and fall, whereas the ice hummocks from complete breakup are formed in winter.

As we have seen, the greatest ice jamming is caused by the wind.

Let us assume that in a certain region of the Arctic Basin, calm weather continued during the course of several days. For this time, the wind drift of the ice field which is caused by the preceding wind, discontinues; separate leads and separations are prolonged by the young ice.

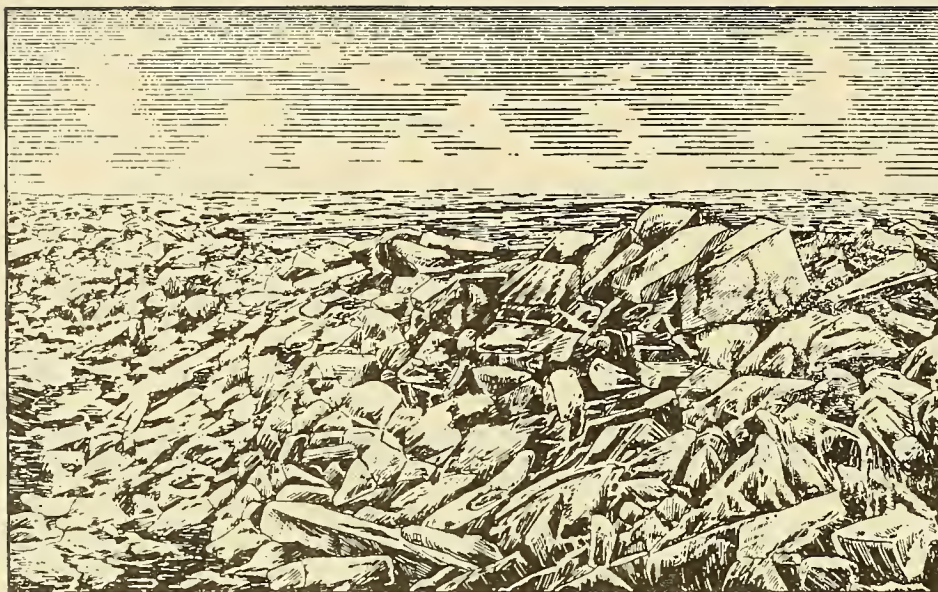

Figure 92. An ice hummock from complete breakup.

Let us further assume that the wind begins with a sufficient force. Gradually the ice fields, beginning with the windward side, will begin to move. Large ice fields, pressing on fields which are leeward before starting into motion, crumple and heap the young ice, which had been formed between them during the time of the calm. In such a way, the movement is gradually transferred to new powerful ice hills which in turn will crumple the young ice which is located between them and the succeeding powerful ice fields. It is clear that with the collisions of large powerful ice fields not only young ice between them is crumpled but also their own borders of contact.

If viewed from above, it would be possible to see how an interrupted strip of ice heaping runs leeward zigzag from one field to another.

With a very sharp increase of the wind force not only the young ice but also weak ice fields are heaped. In such a case, it was as if an ice surge had passed along the ice fields which was reminiscent of a breaker rolling into the shallows and breaking with spray and foam. After the ice surge, the ice field which was level until then represents a chaos of raised heaps of diverse forms and sizes. It seems that the vigorous ice fields of the Central Arctic Basin are created chiefly after such ice heapings and after various processes level out their upper and lower surfaces.

The top ice hummocks, although their height over the level ice is less, also represents quite vigorous ones. With their formation, the ice fields very often, even without any fracture, as it were, push one under the other. The observations of the *Sedov* at the time of its drift, give the idea of the process of rafting ice fields.

On 2 and 3 January 1938 in the drift region of the *Sedov*, the ice fields were rafted over one another in widths of 30 to 40 meters. The *Sedov* was at the same time exactly on the lines of movement. At 1600 3 January, impacts of ice were heard against the bottom of the ship; selvage of the neighboring field reached the ship and crossed under it. For 2 to 3 minutes, the impacts in the ice began to rebound even on the other side of the ship. The ice cover at this place was

somewhat opened from the pushing under of ice blocks. The hummocks from small ice blocks with a height more than 2 m crossed some meters in all from the left side of the ship and approached close to the stern.

As a result of the pushing up under the ship, an ice cushion was formed not less than 2 m thick. At the time of the ice heaping, the ship listed 5 to 7° to the left.

Gordeev illustrates the occurrences (figure 93) from which it is seen that the ice fields retire under neighboring fields at the port side of the ship from left to right and along the stern from right to left.

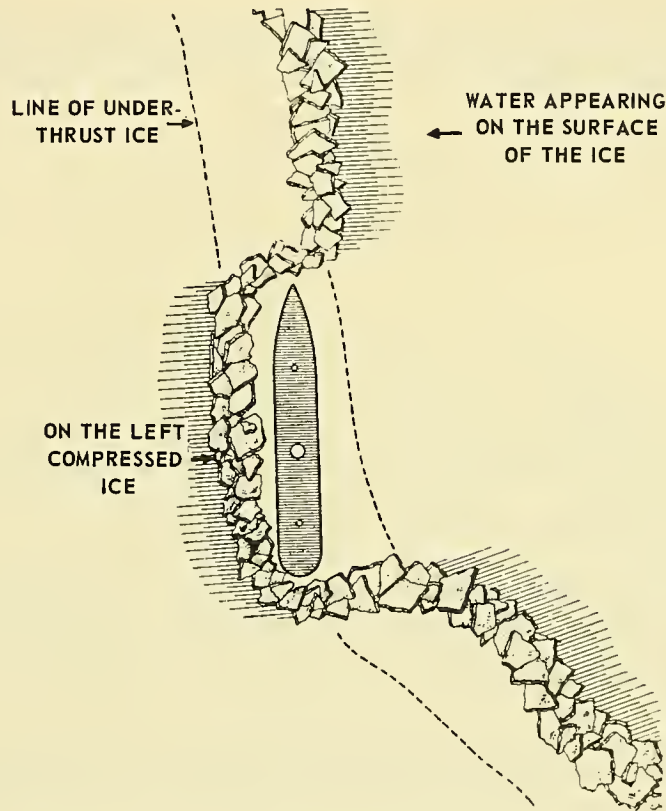

Figure 93. Diagram of ice ridging around the *Sedov* on 2 and 3 January 1938.

The ice thickness pushed under the *Sedov*, gradually increased in the course of the winter and on 24 June 1938, divers were let down under the stern to examine the damage done to the *Sedov*'s rudder by the jamming in January; it was noted that the thickness of the ice it had pushed under the ship exceeded 10 m.

Beside the ice jamming, the formation of ice steps appeared as a consequence of the movement, the breakup, and the subsequent collision of the ice beams during the winter time.

We already know that in the open sea, old ice beams appear at the centers of new ice formations. It is natural that after some time, with nice weather, flat young ice girdled by a strip of

pancake ice will be located along every old ice block, which is in turn girdled by a strip of the first slush. When new ice formations spreading from two neighboring ice blocks join, both ice blocks appear united by a solid ice covering whose thickness will be maximum in the immediate neighborhood of the old ice and minimum approximately in the middle of them.

In the course of the winter, these or some breaking intensifications appear sufficient to fracture the solid ice cover; it is natural that this breakup will go along the lines of the least resistance, which appear as stated, equidistant from the old ice beams frozen in the young ice. With subsequent collisions of broken up ice fields, ice jams are created along the line of the rupture, but if the broken-away parts, on breakup, remain at rest for some time, ice formation will begin again between them as described above.

In the end along the lines of breakup, a characteristic step is formed. According to the observations of the *Zarya*, steps are very often encountered among old ice, steps which comprise two or even three systems of fissures.

LITERATURE: 11, 38, 41, 42, 62, 77, 88, 107, 133, 134, 164, 171.

Section 99. Littoral Ice Hummocks

Ice heaping reaches its greatest dimensions on immobile ice, especially if there is sufficient clear water between the attaching ice and the shore, so that the ice gains a suitable start.

Morozov cites the following case characteristic of the White Sea.

In December 1915, somewhat north of the Ponoï River, two ships were pushed against 8 m of fast ice in a storm. With further pressure, the ice was piled up 2 to 4 m higher than the windward side of the ship and was packed under the ships to the bottom (of the sea bottom) having formed after freezing a floating ice-heaped mass with a thickness of 14 m. The ships were raised 1 m during this pressure.

Thereupon, all this ice-heaped field was broken from the shore and was carried along the sea together with the ships which were not able to be freed; finally, the ships' company had to be transferred to a third ship.

In this same year, on 30 November, a steamship of the icebreaker type *Iceland* on the way to Sorokab, 24 miles west from the Soroka settlement, was held by the ice during a south-southeast wind with a force of 6. Ice hummocks were formed on the port side up to the deck and the ice packed under the ship which was completely in ice. To let the ship down on the water a canal had to be dynamited in the ice along which the ship sneaked, and sideways at that.

Ostrovskii cites the following case in the White Sea.

It was early in the morning of 5 January 1888, when ice was pushed up on the village Kaschkaranets which was located on the Kola Peninsula. The low shore did not present an obstacle until at eight in the morning when the pressure ended. The whole village was cut exactly as if by a

razor. On the shore a belt of ice remained with a length of about 1 km and a width of 60 m. Separate ice hummocks reached 16 m high.

Littoral ice heap which borders the sea with ice selvage is formed during the pressure of the ice on fast ice. After formation of littoral ice hummocks, floating ice can be driven into the sea by the wind and the fast ice begins to spread out in winter from the littoral ice hummocks, so long as the floating ice which is driven out does not cause formation of new ice heaps by its pressure. In such a way, some rolls of littoral ice heaps are created which are almost parallel with one another. On 10 April 1944 with fast ice about 9 km wide at Cape Schmidt, ridges of littoral ice heaps were counted up to 7 m high. Simultaneously at the Koluchin Island, the height of the ice heaps reached 15 m.

The littoral ice hummock can be one formed from a complete breakup, from marginal crushing or from packing. Some observers note that the littoral or packed ice heap usually is observed in a concave shore and is formed by the frequent marginal crushing in autumn with a tight moving over of blocks onto one another. Its height reaches 1.5 to 2 m. As a consequence of the pushed up ice, it is difficult to pass. Besides that, sometimes they even distinguish littoral surf ice hummocks which consist of fine smashed ice beams about .5 m in diameter which will wash rolled around by the water and which are formed during the period of powerful fall storms on the borders of the shore of fast ice or in the neighborhood of the shallows. Relative to form, it is relatively short and not wide; the piled up ridge usually is 4 to 10 m high.*

As we have seen, the powerful polar ice which was bordered from the south by a belt of ice heaps, plays the role of the grounded ice in the Central Arctic Basin.

Especially powerful ice heap formations of several years' standing are encountered in the region off the northern coasts of Greenland and Elzmir Island. In contrast to the remaining region of pack which consists of comparatively flat ice fields, here, ridges of ice heaps will stretch out obstructing the so-called "American" road to the North Pole by a wide littoral strip. This ice, as was already shown, had received from Ners the rather incorrect name "paleocrystic." Separate floe bergs which spotted this ice, reached 10 m high and in my opinion are so similar to icebergs that even an experienced polar researcher as Peary was mistaken in defining them.**

Ice heaping in the region of developed fast ice takes on large dimensions after the dissection or breakup of the sea, where comparatively weak ice fields predominate. Soon after the breakup of the sea, such fields begin to move and are driven from place to place by the wind and the currents, pushing one another and forming characteristic ice heaps of eruption. In the course of time, larger and larger areas of clear water are opened and the amplitudes of the movement of these fields increases still more. Simultaneously, the velocity of these movements increases and consequently, the living force of the moving ice formations. With the collisions, large slabs and monoliths are broken off and raised along the edges of such fields.

*A characteristic ice hummock is formed on the windward selvage. A heavy sea moving blocks of ice packed them solidly one against the other, such ice as Makarov had noted, but very heavy for the ice breaker to cross.

**As Liben informed me, some ice pilings were seen which resembled icebergs in form and size at the time of the flight of the airplane H-169 in March 1941 along 75° north and 160° and 165° east.

The summer ice hummocking takes on especially significant dimensions with the pressure of ice under the influence of the wind and of the currents on the shores. If the shore is deep, the pressure manifests itself in the formation of the littoral hummocks; if the shore is shallow, summer stamukhi are formed with the pressure of the ice on the littoral shallows and banks, stamukhi which are grandiose in dimensions and consist of monoliths of ice 1 m or more thick, but less solid or durable than autumn formations.

At the very shore, the pressure of large masses of ice causes the advance of huge monoliths further beyond the shore line, where they remain a long time until the surf and the sun finally destroy them.

Simultaneously, the pressure on the shallow shores with the movement of ice along the bottom and the shore follows them as it would seem, and causes formation of a dam, which reminds one of a moraine and which consists of unsorted littoral and shore material in contrast to the sorted shore bank formed by the breakers.*

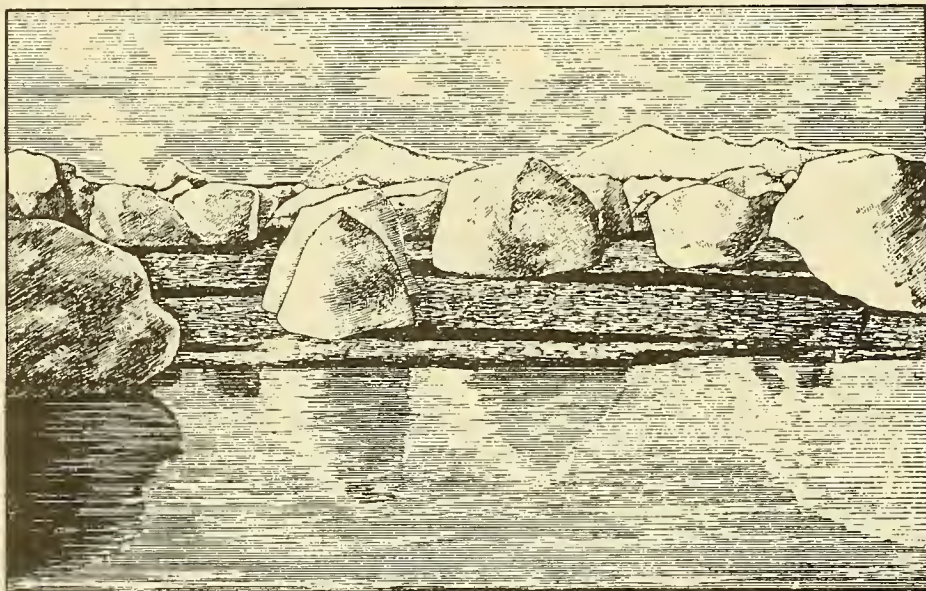

Figure 94. Ice boulders on the shore.

The blocks of floating ice at the shore often fall into the belt of the surf and here some are rolled and rounded and thrown on the shore, and some, striking the bottom disintegrate into large numbers of fine fragments. These fragments being rolled around quickly, take on the appearance of boulders with dimensions of from a few centimeters to a meter or more (figure 94). Actual

*Besides the blocks of ice tossed onto the shore during ice hummocking, these blocks at the very shore block up or fill up the sea to fill up its very bottom, forming the so-called "stone." On the White Sea, stones reach a thickness of 10 m.

wash banks are formed on the shore which are made up of ice pebbles and are completely similar to the surf banks on the shore of the sea of a reduced volcanic type. These ice pebbles are sometimes discarded by the surf some meters from the shore. In such a way, the ice boulders and the pebbles are evidently produced in a period of hours by the sea rolling the angular blocks; with another material, this requires great periods of time.*

LITERATURE: 62, 77, 101, 105, 110, 133, 134, 171.

Section 100. Stamukhi

Every ice formation which has stuck to the shoals or in the shallows is called a stamukh. This is not entirely correct. A stamukh consists of ice of sea origin and its external forms distinguish it sharply from the iceberg which is located in the shallows (figure 95). Stamukhi in the shallow regions of the Arctic Seas play the role of littoral islands as we have seen.

Having been formed as the result of ice heaping, stamukhi are stationed along the isobaths appropriate to their draught and border, on all sides of the island, under water shoals and the shore.**

With pressure of ice, stamukhi stopping the movement of the ice caused awful ice hummocking formation around itself, greatly increasing its initial dimensions and at the same time protecting the shore from the pressure of the ice. Thus, the ice between the shore and the row of stamukhi which border the shore is not heaped but flat and even.

The 20 m isobath which stretched from the Chaumskaya lip approximately in the direction of the New Siberian Island, appears as the limit of the spreading of stamukhi, and the ridge of ice heaps, according to the observations from an airplane by Gorienko, were stretched as a strip approximately along the isobath.

Stamukhi generally appear firm in shape and in the Arctic Seas they last usually a few years. They extend perpendicularly to the pressure and more steeply toward the shore. Like every ice heap, stamukhi are made up of a pile of blocks of various dimensions and forms. In the course of the summer, when less powerful surrounding ice breaks up and is transferred into the class of floating ice, stamukhi usually remain fixed. Melted water flows beneath and freezes on contact with the internal cold parts of the stamukhi and thus welds them into a whole mass. The masses of water which are thrown onto the stamukhi by rough sea, play the same role or have the same effect. The sun and the waves can destroy the stamukhi, but chiefly they influence its forms. The internal structure actually gets stronger. Stamukhi, which consisted at the beginning of blocks,

*During the earthquake of 1923 at Kamchatka the sea ice was cast by the waves 5 km from the shore line and had plowed up the swamp.

**Thus, for example, the airmen Kotov and Marozof observed Stamukhi on 29 March 1942 in the funnel of the White Sea, which borders the island of Marzhovets. The height of the stamukhi reached 7 to 8 m located toward the north from the Bay of Meverk, southeast from the island of Marzhovets many stamukhi even accumulate toward the end of winter; some of them get afloat in the deep water but are again deposited in the shallow water on the bottom. Stamukhi located in the funnel of the White Sea hamper the currents of the channels and cause a powerful current in the passages between them, hollowing out the shallows and changing their contour and position.

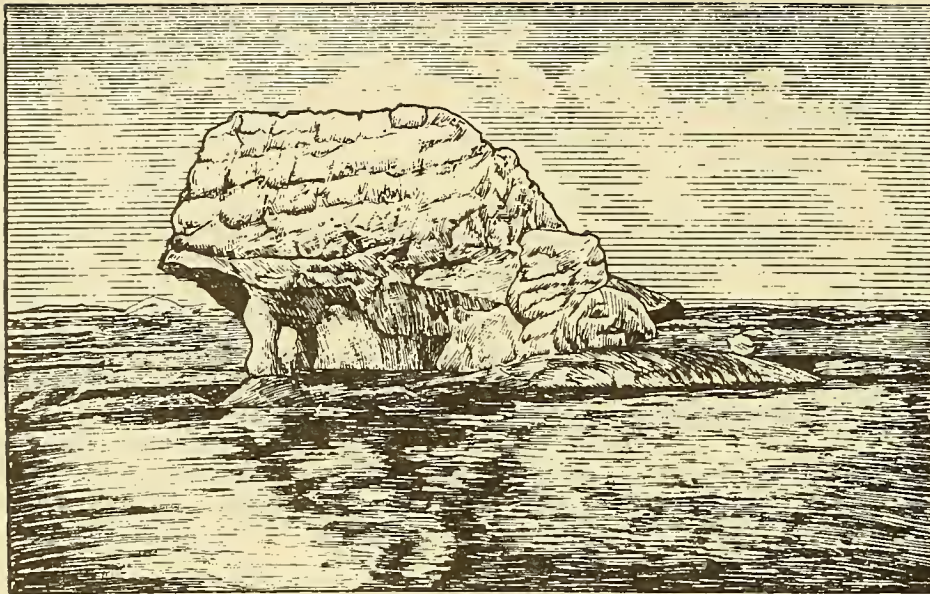

Figure 95. Stamukhi.

acquires a monolithic unity toward the end of summer; at the same time, its external form acquires a rounded contour and the stamukhi reminds one of an actual summer island.

In autumn, from the beginning of ice formations and of ice movements, the stamukhi becomes a center of ice heaping and piles of block are heaped on it, which gives it its initial appearance. According to Wrangel, the height of the perennial stamukhi at the shore of the Kolyma border reached 23 m above an even sea. According to the observations of the *Zarya*, the stamukhi at the Siberian border reached a height of 15 m, which is a usual phenomenon, and in some individual areas even reach 20 m. Peary observed stamukhi 40 m high at the Washington cape, north of Greenland. Simpson observed at Bering Strait how a perennial ice hill having been raised some tens of centimeters above water, formed under pressure, in the shore water, a pile-up with a height of 13 to 15 m over the level sea.

In such a way, due to the protruding in the shallow water and the subsequent ice heaping, the height of the stamukhi increased in the course of time. If the ratio of the heights of the below and above water parts is above 5 for flat ice fields, as in the case of floe bergs, and ice heaps and *nesiak* due to the usually greater destroyed overwater part is about 4, then the ratio for the stamukhi is usually about 2 and often reaches 1 or less.

LITERATURE: 62, 77, 88, 171.

Section 101. Hummock Structure

Hummocks which have just been formed represent rather uniform amalgamations which easily disintegrate into ponds, for example, if the jamming or compression which causes the ice hummocking is changed by clearing. This refers especially to the summer ice hummocking. In winter the ice rallies slightly with jamming and at the points of contact, for the melted water freezes and welds the pressure of contact as soon as the pressure weakens.

But in the course of the winter the ice heaps will grow firmer and firmer. The falling snow fills the fissures and passages of the ice hummock; blocks of ice which form the ice hummock settle and pass under their own weight. Together with the changes in temperature, the internal deformations of the various pieces of the ice begin, increasing their durability. In such a way, the winter ice hummocks are stronger than the summer ones and the older ones stronger than the younger ones.

Usually, toward the end of the polar summer, the flat yearly or annual ice is destroyed in the regions of the fast ice and of the floating ice. Floating ice at this time is made up either of various floebergs and hummocks or ice hummock fields and blocks.

If toward the beginning of the new ice formation these high sections appear beaten down together they are folded and form "cauldrons"; if also toward the beginning of the ice formation they appear scattered, a comparatively large distance from one another, they form more or less ice-heaped fields.

Cauldrons represent a very durable ice formation. In the course of the following winter, they thicken and settle. Only in a few cases are they smashed into separate parts, for in the majority of cases they represent the beginning of perennial pack fields. Being carried out by the currents from the bordering seas into the Central Arctic Basin, they enter for the future into the packed ice as composite parts. In the bordering seas of the Arctic Basin, cauldrons are destroyed in some only in exceptional years. In the north part of the Barents and Kara Seas, it is not a rarity to meet cauldrons of 2 or 3 years growth. In the Chuckchee Sea it is almost possible to meet yearly blocks of perennial ice with a height of 4 to 5 m, the draught of which is 10 to 12 m. The ice fields which consist of young ice with spots in them of nesiak are much less durable: in the course of winter they are repeatedly broken up along the lines of the least resistance, which are, in the majority of cases, thermal fissures and lines of solder.

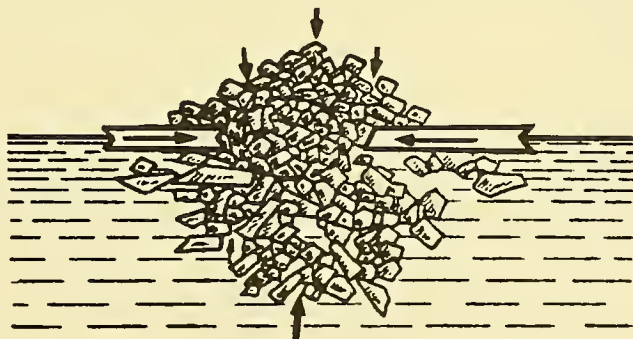

Figure 96. A scheme of the structure of a hummock according to Burke.

As we have seen, the forms of the hummocks as a result of complete breakup, marginal crushing and pushing of one ice field on another are quite different. The hummocks of the pushing type are made up of the largest ice slabs and it is natural that the angle of slope and the height are the smallest. The hummocks from marginal crushing are made up of large blocks sometimes of very irregular forms. The hummock of complete breakup consists of fine blocks. Its height and angle of slope appear the greatest. These hummocks are the most regular in form.

The scheme of the structure and texture of a hummock is shown in figure 96, according to Burke. In every hummock, he distinguishes a core, ropak, and podsovy.

In the very formation, the ice in the middle part of the hummock is subjected, according to Burke, to the greatest jamming from the sides, and also from the top (the weight of the blocks) and from below (Archimedes' forces). As a result, the middle part, after freezing under pressure, is transformed into an ice block with a relatively rounded form which sometimes reaches large dimensions. Such rounded ice blocks were noted among other types in the period of thawing, when the weaker parts of the ice hummock had already disintegrated. According to the White Sea terminology, the over water parts of the hummocks are called ropaki but the underwater parts of the hummock are called podsovy.

According to the observations of the *Zarya*, which were already mentioned, the angle flow for the hummocks from a complete break-up is about 20° to 30°. The average angle of slope of the hummock measured on 24 March 1939 at the time of the drift of the *Sedov*, was about 20°.

We may assume how Makarov did this; at the beginning, the over- and under-water ice parts of the hummock represent isosceles prisms with a characteristic angle of flow for a given hummock which is equal both for the under-water and above-water parts of the hummock. The weight of the prism of the over-ice part of such a hummock is equal to

$$P = \frac{1}{2} khab\delta_i = kh^2b\delta_i \text{ctg } \alpha, \quad (1)$$

where P = the weight of the prism,

h = the height of the hummock,

a = the width of the hummock,

b = the length of the prism,

k = the volume of the prism, filled with ice, or the coefficient of filling of the hummock,

α = the angle of slope,

δ_i = the ice density.

This weight for the balance must be equal to the floatage of the corresponding prism of the under-ice part of the ice hummock, with the same angle of slope; in other words, the identity must exist

$$P = kb\delta_i h^2 \text{ctg } \alpha = kb (\delta_w - \delta_i) z^2 \text{ctg } \alpha.$$

This identity was obtained on the assumption that in the under-ice part of the hummock, the same part of its volume was filled by the ice as the over-ice part. Reducing the equation we derive

$$h^2 \delta_i = z^2 (\delta_w - \delta_i)$$

or

$$z = h \sqrt{\frac{\delta_i}{\delta_w - \delta_i}}. \quad (2)$$

From formula (2) it follows that the correlation between the above-ice and the under-ice parts of the hummocks with one and the same angle of flow does not depend on the angle of slope. Putting the proper meanings in formula (2) and namely, $\delta_w = 1.02$ and $\delta_i = 0.90$, we get

$$z = 2.75 h.$$

In figure 97 the scheme of the hummock was shown according to Makarov (reckoned for an angle of slope of 45° , which it is necessary to regard as exaggerated). From the figure, as well as from the form of formula (2), it is clear that in the case of an equal angle of slope, the basis of the over-ice part and the under-ice part of the hummock are not equal. Consequently, the ice field, especially the above-ice part of the ice hummock, will undergo a stress downward in the center of the pileup and upward along the sides.

"Therefore," states Makarov, "the surface of the ice assumes a convex form, which Nansen also observed.

"When the thaw begins, water collects in the cavities of the hummock. The ice hummock reaches, at the moment of its formation, its greatest depth, but then the ice begins to be leveled. Weyprecht attests that sometimes shift at the bottom is audible, with the complete repose of the ice at the top. This occurs probably as a result of the movement of water under the ice field. The difference of the movements of the ice fields and of the water on which it lies, that is, the current of the water, is that power which levels the lower depth of the ice."

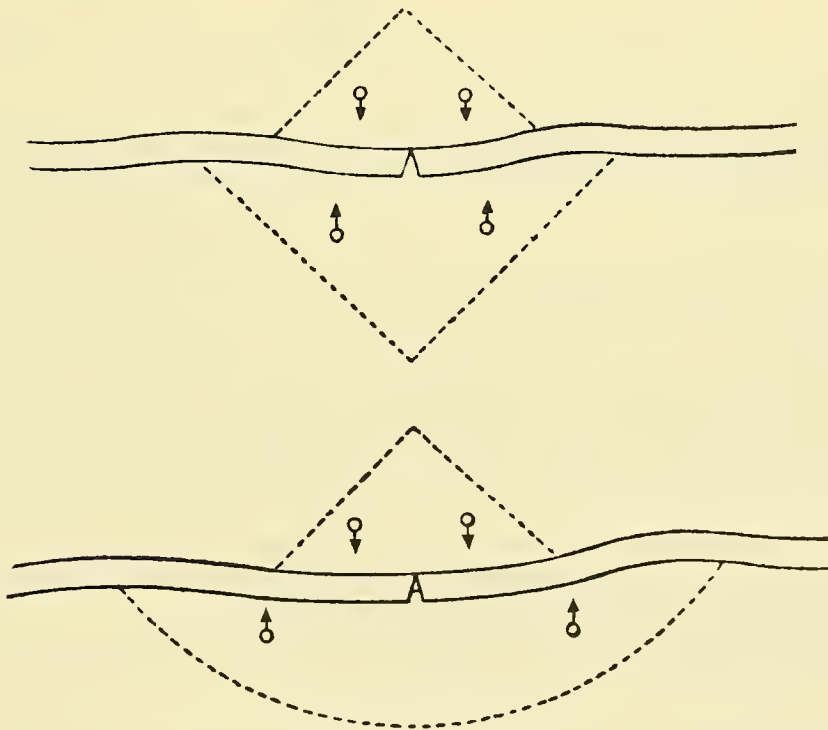

Figure 97. Scheme of a polar hummock according to Makarov.

In the same figure 97, it is shown, according to Makarov, the plan of a hummock which is leveled from below. It is clear that this leveling increases by the fact that the low temperatures of the blocks of ice which were packed under the ice at the time of the hummocking gradually increase under the influence of the temperature of the adjacent layers of water and due to this, the under-ice part of any ice hummock represents a uniform formation.

Very few determinations of the internal structure of hummocks have been made. Consequently, the observations which were carried out by Makarov at the time of the *Ermaĭ* in 1899 in the region to the north of Svalbard represent a great profit.

The ice in this region was made up chiefly of ice blocks of two sizes, with regard to thickness, 2 m and 1.4 m. The first occupies a water area of about 70 per cent; the second, about 25 per cent. The air holes and fissures were about 5 per cent. The ice heaps were made up of ice blocks of the same dimensions. Thus, the largest of the hummocks was composed of 2 m ice blocks, and its height over the ice surface was about 4-1/4 m. It was immutably shown in the measuring of the thickness of the ice by boring with the help of a steam bore, that the ice consisted of several layers which were separated from one another by layers of water. The results of one of these measurings is cited below, which was made on 7 August 1899 at 80°44' north, 90°05' east.

Snow	8 cm
Ice	328 cm
Water	60 cm
Ice	90 cm
Water	60 cm
Ice	20 cm
Total thickness	<u>658 cm*</u>

Makarov emphasizes that it is impossible to distinguish layer from layer when working with the steam bore if they lie close, and therefore it is impossible that the upper layer of ice consisted of two layers. The height of the above-water part of the measured hummock constituted 5.8 per cent of the total thickness.

When boring the ice in the gulf of Finland, which was carried out on 10 April 1899, Makarov discovered that this hummock consisted of 7 layers, the most powerful of which was a little more than a meter thick.

Otto Sverdrup (the Captain of the *Fram*) told Makarov that if one begins to make a hole in polar ice, water would appear in the hole at the place of solder in two adjacent ice blocks. Sverdrup cited as an example when even a 2 m thick ice block crept at the time of the hummocking on another ice block of the same type for a distance of 200 m, but the ice blocks did not entirely freeze together.

Nordenskjold also told Makarov that the lumps which form a hummock are badly welded together and the underwater parts are almost completely unsoldered.

*The spaces in the hummocks which were filled with water are called "water pockets." Sometimes these pockets are completely isolated.

Sverdrup gave Makarov extremely interesting and valuable information. During the third winter, a fissure was formed under the strip under the *Fram*. The fissure closed sometimes and at other times opened. As soon as the fissure opened, lumps of significant size began to float out from below. "This shows," says Makarov, recalling his conversation with Sverdrup, "that many lower lumps constantly travel. The current of the water and the movement of the ice change their direction so that if the migrating ice block stops under certain conditions, under others it can move from the spot."

It is clear or comprehensible that such traveling blocks falling under ice with a small thickness stop, and possibly freeze, and, in such a way contribute to the general equalization to the thickness of the ice.

It is necessary to add that the lumps which compose the under-ice part of the hummocks are not only transformed but are also gradually destroyed.

Let us assume that a strong and cold ice block is driven under the ice. From the beginning, it increases somewhat in its dimensions, owing to its low temperature, but after that, as the temperature of the ice block becomes equal to the temperature of the surrounding water, it grows crumbly and begins to disintegrate into component parts and begins to melt. The tidal currents have particular importance in this relation for the ice, which is immobile; but for floating ice, it is wind drift. The under-ice parts of the ice of the hummocks, parts which are produced below, are subjected to an interesting ablation by the water, which moves with a velocity different from that of the movement of the ice fields.

The model test, carried out by Makarov, is interesting and simple for the exposing of the influence of moving water in the destruction of ice.

Two pieces of ice approximately equal in weight were placed simultaneously into two tubs filled with water, with a temperature of about -1.2° . In the first tub, where the water was at rest, the piece of ice decreased in weight 6 per cent in a period of 3 hours; in the second, where the water, supplied from the bottom, circulated continuously and poured out over the rim, the ice decreased 50 per cent in the same amount of time.

The results of this test become clear if we recall the analyzed conditions in Section 62 of the balance of the system of ice in water. Owing to the phenomena which has been pointed out, the under-ice parts of the hummocks are all more destroyed with the course of time and the stress of the over-ice parts of the hummocks increase correspondingly.

It is necessary to add to this that newer and newer snow drifts are noted along every hummock in the course of time.

If through determination of the dimensions of over-ice parts of hummocks are made, there are less determinations of the form and deepening of the under-ice parts.

At the time of his voyage with Makarov on the *Ermaak*, Islyamov carried out measurements of the depth of the hummocks with a Thomson tube. Makarov cites the results of several such measurements in which the largest of the hummocks was equal to 13 m.

As Makarov points out, "It is necessary to assume that the Thomson tubes [during their broaching or piercing under the ice under the hummock fields] show passage in the ridges of the

hummocks which run under the water and that the lower points of the lower lumps stretch deeper than the tubes reach."

LITERATURE: 11, 23, 77, 88, 101, 105.

Section 102. Snow Cover on Ice

The snow which falls on the arctic ice in winter, due to the low temperature of the air, which prevails at this time, belongs to the type of wild or gritty snow. Often it includes a mixture: crystals of sea salt and specks of dust of ground origin.

Crystals of sea salt fall in the snow in two ways. First, as we have seen, in the leveling of the combs of waves, the spray often evaporates into the air and particles of salt are transferred by the wind for great distances. They serve as fine kernels of condensation and crystallization and finally fall with precipitation. Secondly, the surface of young ice (forming especially at low temperatures) is covered with brine, which, freezing, forms salty hoar frost or ice flowers, sometimes covers great areas, and consists of crystals of ice upon the tips of which are attached crystals of salt. During strong winds, these crystals are removed from a spot, rise, and are mixed with the snow particles which are already in the air. They then fall, appearing like salted snow.

Nansen noted that in some places, the snow on the ice of the Arctic Basin was extremely salty, and it was not possible to use it for checking the zero point of his thermometers. According to the observations of the *Zarya*, snow was sometimes so rich in salt that the water from it was entirely unsuitable for drinking. In other places, the prisms of salt were discovered easily by the turbidity of the melted water with the addition to it of some drippings of silver nitrate.

Dust specks of ground origin which fall on the surface of the ice are received chiefly during erosion and freezing out from tundra and clay-fan soils. These soils with drying give a thin dust which is easily transported great distances by the wind. Such dust forms greyish, yellowish or brownish deposits on the ice. It is clear that this dust is especially noticeable on littoral ice. According to the observations of the *Zarya*, the ice, free from snow and at the same time covered with dust, was encountered in the Buorknaya Gulf at a distance 15 miles from the shore. During the spring of 1939, at the time of a flight along the coast of Yamal, we saw signs of dust extending to the west from the hills of tundra which were free of snow.

The fate of snow depends on the surface upon which it falls.

If the snow falls on a comparatively warm surface of the sea which is clear of ice, then when melting, it cools the surface layers of the sea.

If snow falls on a surface of the sea either cooled earlier or cooled by the snow itself to a freezing temperature, the falling snow flakes appearing as kernels of crystallization accelerate the process of ice formation. With a great quantity of snow, as we have seen, a particular form of ice may even be caused, (*snezhura*).

If the snow falls on cold ice, covered with brine, then, soaking the salt, it freezes solidly to the cold ice, forming a characteristic dull grainy crust.

During low air temperatures, as was already discussed, the snow appears odd or gritty. Falling on the surface of smooth ice, it forms a thin, badly connected cover which is easily blown away by the wind. As a result of this, (according to observations of the *Zarya*) huge spaces of

grainy ice areas are caused in the region of the fast ice, which it seems, are polished somewhat from the friction of the masses of snow which move along it during snowstorms. In such areas, there can be observed often on the surface of the ice pancake and frozen masses of snow appearing as lumps or strips, just as they appeared on freezing. Particularly spacious areas of grainy ice were observed by the members of the *Zarya* expedition in April 1903 on the Gulf of Buorknayaya. It was difficult both for dogs and deer to run along this ice.

An observation which corroborates the wind migrations of the snow on the ice was made by Buinitskii on 13 December 1938 at the time of the drift of the *Sedov*. Here is what he says:

"The efflorescence of tracks occurs interestingly: the snow is swept around the tracks, and the snow remains under the track and is raised over the surrounding surface, preserving exactly the outline and the dimensions of the track. The 'growth' of tracks can be observed over the foot-step of a man as well as over that of a dog; the tracks of dogs effloresce significantly higher (2 times) than a man's. Here and there, they are similar to a row of very accurate cylinders which reach heights of 3.5 cm. This growth of tracks does not occur at all universally."

The snow, falling on hummock fields or transported to them with the flat fields, is stopped here, being trapped in the spaces between the box and forming snow drifts and zastrugi. Windward declinations of the snow drifts are strongly packed by the wind. In figure 98 the plans of snow deposition are shown with various forms of obstacles which are encountered by the wind. In figure 98, attention is turned to the snow pack, which is formed behind the obstacle which has its slowing side toward the wind and to the characteristic wind hollow before an obstacle with its steep slope to the wind.



Figure 98. Whirling eddy and drifting snow on contact with a wedge-shaped obstacle.

In nature, on sea ices where hummocks with their diverse forms and inclinations are the basic obstacles for the migration of snow, the form of the snow drifts is not any less diverse.

The power of the snow drift understandably depends on the quantity of the deposition. Thus, during the wintering of the *Zarya* at the Taimyr Strait, snow drifts reached a height of about 5 m. The ice sagged as a result of the weight of the snow and already at the beginning of March, water protruded along the *Zarya* from beneath the ice.

At the time of the wintering of that same *Zarya* in the Laptev Sea (in the Kotel'nyy Bay of Nerpal and on the island of Kotel'nyy) where the amount of deposition was significantly less than in the northeastern part of the Kara Sea, the snow drifts were also significantly less.

In the Central Arctic Basin, where the depositions are already less, the sizes of the snow drifts are not large. Thus, according to measurements of the *Sedov* which were carried out at the end of March and at the beginning of April 1939, the height of the snow in the snow drifts ranged from 30 to 140 cm and on flat places, on an average, from 4 to 15 cm.

Extremely characteristic are the wave-formed alluviums which are formed on the flat ice fields as a result of the affecting wind. These alluviums are made transversely and longitudinally. Transverse deposits are formed in the case of great masses of snow and remind one of the Helmholtz waves. Longitudinal deposits are formed with powerful winds and small quantities of snow appear as their characteristic form.

Padalka informed me that at the time of the flights over the region of Franz Joseph Land north at the end of March and at the beginning of April, all the snow deposited by wind was stretched out from southeast to northwest. This could be caused by the evidently predominant southeast winds and besides that by the absence of rotations of the individual ice fields. In the region between Franz Joseph Land, the wind-deposited snow was stretched out only in two directions, from the south to the north, from east to west. In the region to the north of Novaya Zemlya, no such correctness relative to the location of the wind-deposited snow was noted.

Snow cover on ice shows a great influence on the growth of ice. It has already been observed that according to the observations at the Northern Duina River in the winter of 1941-42 the ice with the surface clear of ice was at the end of winter 1-1/2 times thicker than the ice which was formed under the natural snow cover (thickness of 30 to 40 cm).

But, large masses of snow usually crush ice down to where water protrudes from beneath the base layer of ice. Mixing with this water, snow is transformed into ice, and in such a way, the general thickness of the ice increases (see also Section 85).

During the summertime, masses of snow which have collected on ice fields melt, and are the basic source of formation of snow puddles (snezhnitsa) and melt water lakes on them.

LITERATURE: 25, 77, 88, 107.

Section 103. Isostatic Phenomena

Ice formation in the sea, which has already been discussed, proceeds calmly and proportionally only under exceptional circumstances. Falling deposits are not proportionally distributed along the surface of the ice. In connection with this, the accretion of the ice from below does not proceed proportionally. Hummocking contributes the greatest transgressions to smoothness in the process of ice formation.

Let us assume that at a certain moment a previously flat ice field was broken as a result of hummocking blocks of ice packed over and under the ice. If the floatage of the blocks packed under the ice exactly counterbalances the weight of the blocks of ice which have been piled on the ice, no changes in the ice adjacent to the hummock are produced. If the weight of the above-ice part of the hummock shows more floatage than its under-ice part, the adjacent ice will sag downwards; if it is less, it will protrude upwards.

An interesting phenomenon exists in connection with this, which is called "isostasy" by the geologists, the question of which has been theoretically treated by Pratt and Airy for the crust of the earth.

Let the transverse section of the ice field be represented in figure 99 and let the upper and lower surfaces be dissected and let the densities along the vertical be unequal. The line *mn* represents the water line (level of the sea). Let us construct such a line on our section which would correspond to the water line of any vertical column cut out from the given ice field, if it would be

able to raise or sink such that the overall weight will be counterbalanced by Archimedes' force; in other words, so that everywhere the equation was satisfied

$$\frac{z}{h} = \frac{\delta_i}{\delta_w - \delta_i}, \quad (1)$$

where δ_i = the ice density,

δ_w = the water density,

z = the immersion of the in-the-water part of the ice blocks,

h = the height of its above-water part.

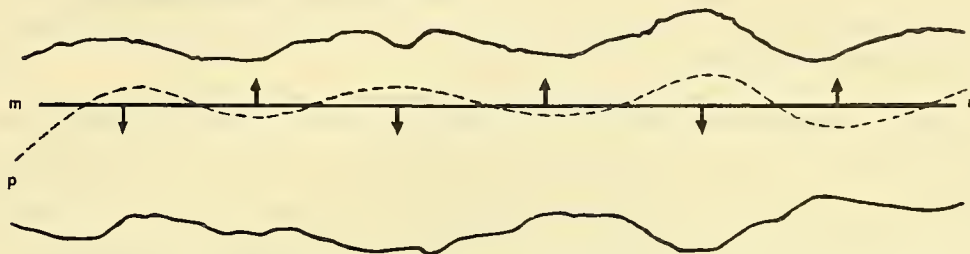

Figure 99. The water line (mn) and the isostatic line (pr) in the vertical pass of the ice field (diagram).

We shall call line pr , represented by a broken line in figure 99, the isostatic line. Referring our considerations to the entire ice field, we shall receive the isostatic surface. It is clear that everywhere where the isostatic line pr proceeds or passes higher than the water line, the isostatic forces there operate, directed downwards; there, where the isostatic line proceeds lower than the level of the sea, the isostatic forces are directed upwards, as is shown by the arrows in figure 99.

At points where the isostatic line coincides with the level of the sea, we get an isostatic balance. I call an ice formation isostatically counterbalanced at every point of which the isostatic surface coincides with the level of the sea.

It is assumed that there are not any ideally counterbalanced formations in nature. Fine deviations do not have any significance, however, since the forces being created cannot be sufficient for overcoming forces of cohesion (the equalization due to the flow of ice proceeds too slowly), but large deviations quickly bring vertical movements of separate parts of the ice, which level or even the balance.

The isostasy phenomena acquire particular significance in summer, when the cohesion of parts of the ice is weakened and when destruction of above-water parts of the ice proceeds particularly disproportionally. Isostasy at this time is basically connected with two processes: hummocking, and the flowing of water from the *snezhnitsa* (snow puddles) under the ice.

Let us represent for ourselves a hummocked field isostatically balanced. If we may assume that the above- and under-ice parts of the hummock consist of approximately equal blocks of ice and that the spaces between the ice blocks are filled with air in the parts of the hummock over the level of the ice and with water in the parts beneath the ice level and are located approximately systematically along the vertical with regard to the level of the sea; in other words, the coefficients of filling are equal, on any vertical of an isostatically balanced field, the correlations between the height of the ice hummock and its draught will be determined by formula (1) or by the

$$\frac{z_1}{h_1} = \frac{z_2}{h_2} = \dots = \frac{z_n}{h_n} = n. \quad (2)$$

In such a way with the received average proportion of the height of the above- and under-water parts, which is equal to 5, under the hummock, which is raised over the surface level of the ice field 1 m, the ice under the lower surface of the ice field must be theoretically submerged 5 m. The greatest height of an ice column observed at the time of the drift of the station "North Pole" was about 10 m. Consequently, the underwater part of this column during conditions of an isostatic balance must project from under the lower surface of the ice fields 50 m.

As we have seen, the hummocks do not usually appear isostatic. Their underwater part is washed out; the above-water parts of the hummocks press on the ice fields, creating their greater draught and results in formula (1).

Thus, the time of hydrological cuts, carried out by Khmyznikov, in the fall of 1928, in the Yanskom Bay and in the straits of the New Siberian Islands (Laptev, Eternikan, and Sannikov), the thickness of the above- and under-water parts of the well-developed fast ice were determined, considering them from the level of the water, which had filled the cut. It was shown at this time that the proportion of the emersion of the underwater part to the height of the above water part was equal on the average to 12, with a maximum of 17 and a minimum of 7. In such a way, the fast ice was shown to be significantly more submerged in the water than results from the formula. A similar phenomenon was also observed on the river where the water from the cut sometimes poured out along the surface of the ice. In rivers flowing to the north, such a phenomenon is usual in the spring and is explained by the hydraulic pressure -- the river, covered by a solid ice cover, flows as in a tube. In the fast ice, this phenomenon is related to the large area of ice, and indicates an overburdening of ice by an additional weight of snow. We have already seen in columns 5 and 6, table 70, that in Dixon Bay, the surface of ice in February 1944 was on the average .8 cm lower than the surface of the water.

This carving of the well-developed fast ice contributes to its breaking up in the spring and to the immersion of ice fields which will be discussed later.

In individual cases, hummocking proceeds so that more ice is packed under the ice than ought to be for isostatic balance. Besides that, we have seen that individual blocks of underwater parts of ice hummocks are sometimes interspersed under ice fields. Both in this and in other cases, the ice protrudes upwards.

On 24 November 1938, it was observed on the *Sedov* that the level of the water was lower than the surface of the ice by 1 to 1.5 m; after the ice in some places burst and broke, 10 to 15 m; trenches were formed with vertical walls of considerable height.

These facts prove that at points where recorded observations were carried out there was no isostatic balance: in the ice of the new Siberian Island straits, the isostatic surface passed lower than the level of the sea; on the ice field of the *Sedov* where the described fissures were formed, the isostatic line passed higher than the level of the sea.

It has already been noted that the vertical movements of individual parts of the ice field are increased by the isostatic balance, particularly in summer when the forces of cohesion counter-acting the hydrostatic forces are weakened. The following observation of the *Sedov* appears as a characteristic example of isostatic movement in the ices in the central part of the Arctic Basin.

On 5 July 1939 the water of the snezhnitsa (snow puddles) and lakes which were formed during the summer on the ice fields quickly began to run off under the ice, and on 9 to 14 July, the *Sedov*, together with ice to which it was frozen, was raised 36 cm over the level of the sea. I tried to analyze this phenomenon.

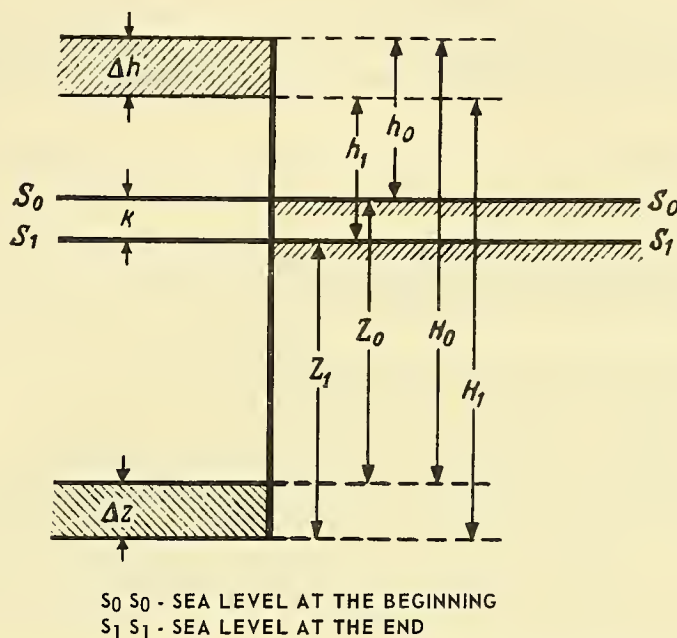

Figure 100. The vertical movements of ice fields in connection with thawing and accretion from freezing.

Let us assume that a certain part of the ice field remained the entire time isostatically balanced (figure 100). In such a case, in accordance with formula (1), we shall have, for the beginning moment:

$$h_0 \delta_h + z_0 \delta_z = z_0 \delta_w, \quad (3)$$

$$H_0 = h_0 + z_0, \quad (4)$$

and for some other moments, considering that it is possible to neglect the changes occurring in density.

$$h_1 \delta_h + z_1 \delta_z = z_1 \delta_w, \quad (5)$$

$$H_1 = h_1 + z_1. \quad (6)$$

From figure 100 it follows

$$h_1 = h_0 + k - \Delta h, \quad (7)$$

$$z_1 = z_0 - k + \Delta z, \quad (8)$$

where Δh = the change of the above-water height of the ice as a consequence of evaporation, of deposition, and of melting away, flowing of water under the ice, during the time between the observation,

Δz = the change of the underwater emersion of the ice with freezing and the melting of ice from below,

k = the change in the position of the level of the sea with regard to the ice. It is clear that all individual particles within the ice are shifted to this same value with regard to the level of the sea.

Substituting formulas (7) and (8) in formula (5) we derive

$$(h_0 + k - \Delta h) \delta_h + (z_0 - k + \Delta z) \delta_z = (z_0 - k + \Delta z) \delta_w. \quad (9)$$

Subtracting formula (3) from formula (9) and transposing the members, we derive

$$k(\delta_h - \delta_z + \delta_w) - \Delta h \delta_h + \Delta z(\delta_z - \delta_w) = 0. \quad (10)$$

Furthermore, from formulas (7) and (8) we get

$$H_1 - H_0 = \Delta H = \Delta z - \Delta h, \quad (11)$$

where ΔH = the overall change of the ice thickness.

During the winter, when ice thawing does not occur, the value ΔH is determined by the difference between the quantity of the fall in precipitation and evaporation, the deposition and the evaporation in the central arctic are not great in the winter, and we may disregard in the first approximation this difference and reckon

$$\Delta h = 0.$$

Furthermore, the difference of the densities of the above- and under-water parts of ice which is significant in summer, is small in winter. From this we may derive for winter

$$\delta_h = \delta_z.$$

In such a case, from formula (10) we shall derive

$$k = \frac{\delta_w - \delta_z}{\delta_w} \Delta z. \quad (12)$$

Considering the following values the most probable,

$$\text{therefore} \quad \delta_w = 1.02, \quad \delta_z = 0.90,$$

$$k = 0.11 \Delta z.$$

Thus, the increase in the thickness of ice by accretion from below to 100 cm causes a shift of the level of the sea with regard to the ice, and the increase of the height of the above-water part of the ice 11 cm in all, and the increase of the height of the under-water part 89 cm.

During the summer the processes which change the position of the isostatic line with regard to the level of the sea results in the following:

1. Evaporation and depositions or precipitations. It is possible to neglect in the first approximation the influence of these processes.
2. Accretions of ice from below due to the low temperature, which is already preserved within the ice. As we have seen, the thickness of the ice due to the secretion by freezing can thicken more than 5 to 10 per cent, so that we may also disregard for our purposes this phenomenon.
3. The decrease in the density of the above-water part of the ice in summer time can produce decreases in the salinity and increase porosity due to the increase in temperature.

The decrease in the density of ice (see Section 65) even with an increase of 20° in temperature does not exceed .03 per cent. For our purposes, it is possible to disregard this value.

The decrease in the density of the above-water part of the ice due to its decrease in salinity, due to the flow of brine from the salt capillaries and subsequent replacement of the formed vacuums by air may also be insignificant.

There is another matter, the increase in the dimensions of the salt capillaries which is due to melting, after all the brine flows from them. On the strength of the circumstance, sea ice is gradually transformed to a granular ice which approximates in form and density the neve ice.

Returning to formula (9), we note that with the quick raising of ice, the density of the part of the ice with a thickness k which had been raised over the level of the sea cannot be changed significantly. Therefore, formula (9) takes on the appearance

$$(h_0 - \Delta h) \delta_h + (z_0 + \Delta z) \delta_z - (z_0 - k + \Delta z) \delta_w, \quad (13)$$

and formula (10) resulting from (9) takes on the appearance

$$k\delta_w - \Delta h\delta_h + \Delta z(\delta_z - \delta_w) = 0, \quad (14)$$

where

$$\Delta h = \frac{k\delta_w + \Delta z(\delta_z - \delta_w)}{\delta_h}. \quad (15)$$

Furthermore, let us remember that the growth of ice in summertime from below, due to the low temperatures of ice, cannot exceed 20 cm, and the difference of the density of the water and the

submerged part of the ice cannot exceed 0.1. Consequently the value

$$\frac{\Delta z (\delta_z - \delta_w)}{\delta_w}$$

cannot be greater than 2 cm, and we have the right to disregard it for further references.

Therefore, from formula (15), we derive

$$\Delta h = k \frac{\delta_w}{\delta_h} . \tag{16}$$

Substituting the values $\delta_w = 1.02$, $\delta_h = .80$, and $k = 36$ cm (the rise of the hull 36 cm above the ice sea level, as observed by the *Sedov*) we get

$$\Delta h = 46 \text{ cm} .$$

It is clear that a 46 cm thaw cannot refer to some individual point of the ice field, but it is necessary to observe it as the average for the entire surface of the ice field. In even parts of the ice field, the value of melting will be less; in the raised parts (hummocks and ropaki) it will be more. It will be minimum under the snezhnitsa (snow puddles) where the water, being a foreign absorber of the heat of solar radiation, will protect it from melting.

That very same thing is related also to the change in the general thickness of ice. There, where ropaki, hummocks and snow drifts are on the ice fields, the decrease in the thickness was more significant. On the level places (on such where, for example, the measurements of thickness of the ice cover were carried out at the time of the drift of the *Sedov*) the changes of the ice thickness was the smallest.

The dimensions of the ice field in which the *Sedov* was frozen, are not known. If its area was only about 1 square km in all, 46 cm of melted ice had to give about 400,000 m of water, which filled the snezhitsa (melt pools). While this water remained in the snezhitsa (melt pools), vertical movements were caused only by a result of the summer freezing from below, due to the low temperatures of the ice itself, and this raising, as we have seen, would not exceed 2 cm (that is, it was completely imperceptible). Moreover, such a rise could only be completed very slowly.

From that moment, when large masses of water had begun quickly to leave the snezhitsa (melt pools) and run under the ice, the ice began to rise above the level of the sea and together with it the *Sedov*.

It is possible that this circumstance contributed to this rise, in that ice was packed during the winter under the *Sedov* with an overall thickness of 10 m, and "directly under" the *Sedov*, the isostatic line was somewhat lower than the level of the sea, but the influence of the rise of the isostatic surface cannot be determined in view of the lack of data.

LITERATURE: 74, 77, 133.

Section 104. Average Ice Thickness

Ice fields, as we have seen, according to origin, may be accumulations of ice or cakes of ice. The thickness of the first are more or less equal in their entire extent; the thickness of the second changes from point to point within extremely wide limits.

With the course of time, the ice of the hummocks can be transformed into a more or less level ice field by the action of the different order of balancing factors. Such, for example, appeared, according to observations of Soviet airplanes in the circumpolar region. But generally, especially in the periphery of the Arctic Basin and in the bordering seas, hummocks, a characteristic trait of the ice landscape.

I make the following assumptions for judging the average thickness of sea ices:

1. Ice fields are isostatically balanced at every point.
2. Hummocks are extended by bridges, whose transverse cut represents an isosceles triangle.
3. Blocks of ice comprising the above-ice and under-ice parts of the ice hummock are located in such a way that they comprise that same part of their volume which is occupied by these parts. In other words, if the volumes of the above ice and under ice parts of the ice hummock are correspondingly equal to v_h and v_z , then the volumes, being occupied by ice in these parts, are correspondingly equal to $k v_h$ and $k v_z$ where k is the coefficient of filling of the ice hummock. A cut of an even ice field with an ice hummock included in it is represented in figure 101.

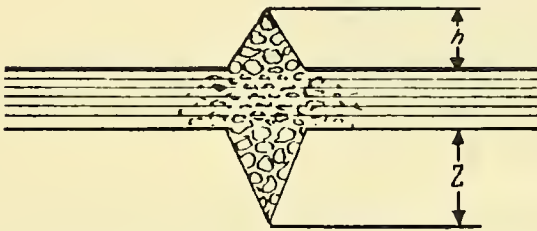

Figure 101. Above and under ice parts of ice hummocks in isostatically balanced ice.

It is clear that its average thickness in the limits of the hummock, that is, the thickness of the ice field, the above- and under-water parts of the ice hummock will be equally distributed in a layer uniform in density along the upper and lower surface of the field, will be equal to

$$i_{cp} = i + \frac{k}{2} (h + z), \quad (1)$$

where i = the thickness of the level ice,

h = the height of the above ice part of the hummock,

z = the height of the under ice part of the hummock,

k = the volume of the ice in a unit volume of the hummock.

But, if on each of its verticals, the hummock is isostatically balanced, the relationship exists between the heights of its above water and under water parts:

$$\frac{z}{h} = \frac{\delta_i}{\delta_w - \delta_i}. \quad (2)$$

Substituting this in formula (1) we get

$$i + \frac{1}{2} kh \left(1 + \frac{\delta_i}{\delta_w - \delta_i} \right) = i + \frac{1}{2} kh \frac{\delta_w}{\delta_w - \delta_i} . \quad (3)$$

Regarding on the average, that $\delta_w = 1.02$ and $\delta_i = .90$, and assuming that the above- and under-ice parts of the ice hummock represent heaps of blocks of ice with voids between them, because of which the density of the ice hummock is half the density of the level ice, in other words, assuming that the coefficient of filling is $k = 0.5$, we get from formula (3)

$$i + \frac{1}{2} \frac{1}{2} h \frac{1.02}{1.02 - 0.90} \approx i + 2h .$$

It is clear that if the ridges of the ice hummocks will touch one another, as is shown in figure 102, the average thickness will be equal to

$$I = i + 2h . \quad (4)$$

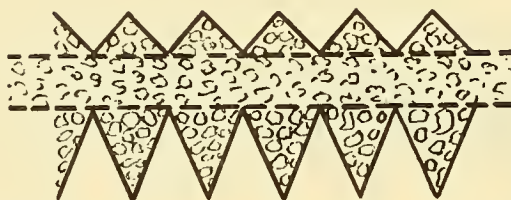

Figure 102. An isostatically balanced hummock field.

If the hummocking of the ice field is evaluated, as this is assumed by Gordienko, according to the 10 Mark system, then formula (4) takes on the appearance of

$$I = i + \frac{N}{10} 2h , \quad (5)$$

where N = the number of marks of hummocks.

In formula (5) we can regard i as the thickness of the level ice, as the thickness of the ice accumulations reckoned with sufficient accuracy according to the degree days of frost, characteristic for a given region. Almost with the same accuracy we can appraise the magnitude of the summer melting for the given region.

Whatever has to do with the marks of the heaping and the average height of the hummocks, can be determined best of all by ice-air reconnaissance and also by sleigh excursions.

Gordeev notes the following curious fact: in autumn 1937 at the time of the drift of the fleet *Sadko* the area of the ice of fall formation in a radius of 1 km around the ships was photographed in plan. For six months of the drift, this area contracted more than two times due to the hummocking, which occurred chiefly during the drift of the ice to the east. The average height of the hummocks was about 3 m, and the greatest about 6.5 m over the level of the sea.

Formula (5) gives an idea of the average thickness under the condition that the given region is completely filled with ice; in other words, under the condition that the quantity of ice in this region is 10 marks. With the thinned ice we receive a more general formula from formula (5)

$$I = \frac{n}{10} \left(i + \frac{N}{10} 2h \right), \quad (6)$$

where n = the average quantity of ice in marks or points.

Along with the idea of the average thickness of the ice, the idea of the average amount of ice in the basin or of a part of it rises by which we agree to understand the proportion of the actual area which is covered by ice (taking into consideration the measuring point system) to the general area of the examined part or

$$L = \frac{n}{10} \frac{q}{Q}, \quad (7)$$

where q = the area occupied by the ice,

n = the average marks of the ice,

Q = the general area of the examined region.

It is clear that the average iciness does not completely characterize the thickness of the ice.

Combining the ideas of the average thickness and iciness of the region, we receive the average power or force of the ice cover according to the formula

$$W = I \frac{q}{Q} = \frac{n}{10} \left(1 + \frac{N}{10} 2h \right) \frac{10}{n} L = \left(1 + \frac{N}{10} 2h \right) L. \quad (8)$$

I was assuming the derivation of these formulas that both the level as well as the hummock formations on any vertical are isostatically balanced and consequently the areas occupied by the above and under ice parts of the hummocks are equal.

LITERATURE: 41, 42, 77.

Section 105. Decrease in the Area of Ice with Hummocking

During the observation of the change of the area of ice on the White Sea and the reaction of the wind, the large areas of clear water, opened after each ice hummocking, surprised Somov and myself, and we made an endeavor at an approximate calculation.

Let us assume that a cut of the ice field in the direction of the wind is represented in figure 103; in other words, in the direction perpendicular to the direction of the ridges of the hummocks. In the figure,

L = the length of the ice field before the ice hummocking,

l = the length of the ice field after the hummocking process,

α = the length of the hummocked part of the field,

b = the decrease in the length of the field as the result of the hummocking, it is obvious that

$$L - l = b. \quad (1)$$

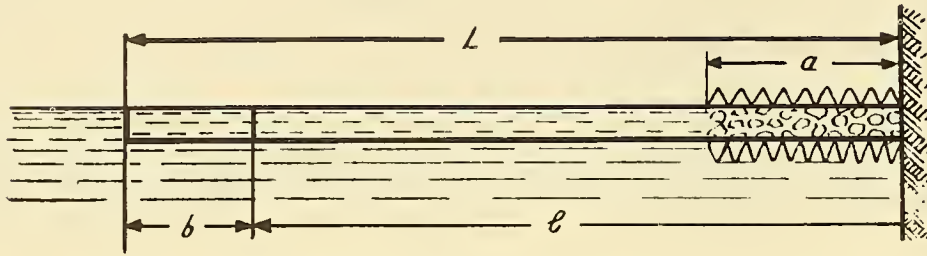

Figure 103. The increase in the area of the field with hummocking.

But since the decrease of the ice field leads completely to the formation of hummocks, then

$$bH = ka(h + z), \quad (2)$$

where H = the thickness of the ice field,

h = the average height of the above ice part of the hummock,

z = the average emersion of the under water ice part of the hummock,

k = the coefficient of filling of the hummocks; this coefficient under the condition of iso-static balance is equal to the above- and under-ice parts of the hummocks.

Substituting formula (1) in (2) we get

$$L - l = \frac{ka(h + z)}{H}, \quad (3)$$

but

$$\frac{a}{l} = \frac{N}{10}, \quad (4)$$

where N = the point of hummocking of the field.

Substituting formula (4) in (3), we get

$$\frac{l}{L} = \frac{1}{1 + k \frac{h}{H} \left(1 + \frac{z}{h}\right) \frac{N}{10}}. \quad (5)$$

If we substitute

$$k = 0.3, \quad \frac{h}{H} = 3, \quad \frac{z}{h} = 6,$$

then we get,

$$\frac{l}{L} = \frac{1}{1 + 0.6N}. \quad (6)$$

Let us assume that the ice field even up till then was hummocked from the beginning until N points and, later to M points. From formula (6) we can write

$$l_N = \frac{L}{1 + 0.6N}, \quad (7)$$

therefore

$$l_M = \frac{L}{1 + 0.6M},$$

$$l_M = \frac{1 + 0.6N}{1 + 0.6M} l_N.$$

Table 84 is calculated by me according to formula (7), from which it follows that, for example, if the field was ice hummocked up to 3 points, that is $N = 3$, and later it appears hummocked to 5 points, that is, $M = 5$, then

$$l_M = 0.70 l_N.$$

In other words, in the area of the field which is hummocked from 3 to 5 points, with the values received by us, contracts to 30 per cent.

TABLE 84. THE DECREASE IN THE AREA OF ICE WITH HUMMOCKING (IN PER CENT OF THE INITIAL AREA)

$N \backslash M$	0	1	2	3	4	5	6	7	8	9	10
0	100	62	45	36	30	25	22	19	17	16	14
1	-	100	73	56	47	40	35	31	28	25	23
2	-	-	100	78	65	55	48	42	38	34	31
3	-	-	-	100	82	70	61	54	50	45	40
4	-	-	-	-	100	85	74	65	57	53	48
5	-	-	-	-	-	100	87	78	69	63	57
6	-	-	-	-	-	-	100	89	79	72	66
7	-	-	-	-	-	-	-	100	90	81	74
8	-	-	-	-	-	-	-	-	100	91	83
9	-	-	-	-	-	-	-	-	-	100	91
10	-	-	-	-	-	-	-	-	-	-	100

We can derive the formula in some form from the same figure 103. As before, let

$$L - l = b.$$

but

$$bH = a(H_{\max} - H),$$

where H_{\max} - the average thickness of the ice hummocked part of the ice field, in which the field is not hummocked by the wind of a given force.

Furthermore, as earlier, we derive

$$\frac{a}{l} = \frac{N}{10},$$

$$\frac{l}{L} = \frac{1}{1 + \frac{N}{10N}(H_{\max} - H)}. \quad (8)$$

Let us assume that the initial thickness of the ice is $H = 15$ cm; the average thickness of the ice which is not hummocked by the given wind is $H_{\max} = 50$ cm. It is clear that the field stops being hummocked after its hummock becomes equal to 10 points. Substituting these values in formula (8) we derive $K = 0.3$.

However, the assumptions were approximated on the basis of which formulas (7) and (8) and table 84 are derived; it results from them that the open areas of water will be created even with small hummocking in the sea. A map of the position of the ice in the White Sea according to the data of air reconnaissance which was carried out on 17 April 1942 (figure 104) appears as the characteristic example. Such a situation has been created as a result of northwestern storms and great areas of clear water in the Kandalakscha Gulf and along the Karelian shore and also along the western shore of the funnel of the White Sea were formed exclusively as a result of hummocking.

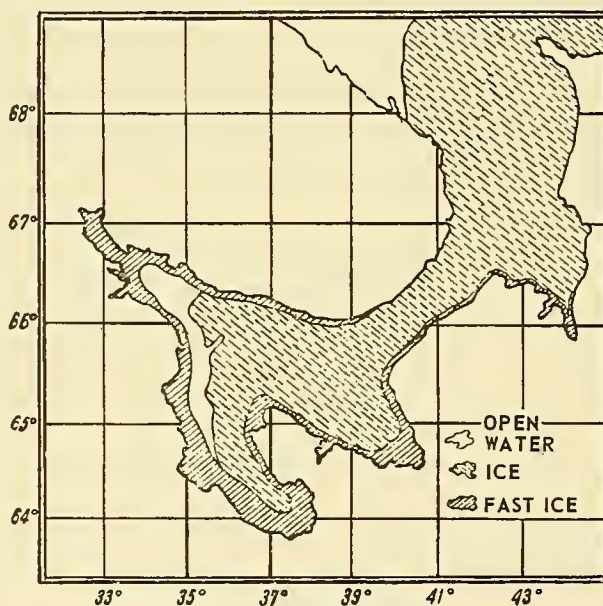

Figure 104. The position of the ice in the White Sea, 17 through 18 April 1942.

It is clear that open patches of water being cleared, sometimes at one shore and sometimes at another, and that evacuation of ice will create the possibility even of sea navigation in the dead of winter. But on the other hand, increased ice formation occurs in open spaces of water with strong freezing and in such a way, that the total power of the ice increases in the course of time.

LITERATURE: 77.

Section 106. The Increase in the Power of the Ice Cover as a Result of Drift and Ice Hummocking

As the observations of the *Fram* and the *Sedov* showed, parts of the ice which were formed exclusively as a result of accretion, can be preserved in the Arctic Basin for a long time (2 to 3 years) but all the same, they do not determine the basic masses of ice, but the ices of the pile-up.

An endeavor to consider the influence of ice hummocking and the cleared spaces of water which resulted from ice hummocking and drift, on the increase of the total force of the ice cover was made by Somov and later led to the quantitative expression in the work of Biriulin and Somov.

Calculating the average thickness of the ice as the quotient for the division of the general volume of ice by the area of the examined part of the sea, Somov points out that this thickness of ice is summed up from the interaction of the following factors:

1. Accretion from below due to heat emission into the atmosphere.
2. The bearing out of the ice from the sea and returning it from other seas.
3. Formations of young ice in clear water, which is caused as a result of drift and hummocking.
4. Ice melting.

It is natural that during the period of ice formation it is necessary to consider the first three factors, but during the period of melting, only the second and fourth.

Furthermore, for the solution of the problem, Somov makes the following assumptions:

1. The area of the sea is equi-dimensional to a certain rectangular sea, whose width is equal to the average width of the given sea, and the length is equal to the average length of the given sea.
2. The sea on three sides is bordered by shores; the fourth side of it is in free communication with the Arctic Basin.

The Laptev Sea answers such a condition in the first approximation (if possibility of an ice exchange with the Kara and the East Siberian Seas across the straits of the archipelagos of Severnaya Zemlya and the north Siberian Islands is disregarded).

3. The sea is encompassed at the same time by the drift (average for a 10 day period or for a month); the drift flows over the entire area of the sea with an equal velocity and in the same direction. This assumption has been indicated to some degree by the simultaneous drifts in the winter of 1937-1938 of the fleet of the ships: of the ice breaker *Lenin* in the southwestern part, and of the steamer icebreaker *Sadkov* in the northeastern part of the Laptev Sea.

4. With the drift of ice, which is accompanied by hummocking or carrying of ice from the sea, the sum of the areas of water free from ice is equi-dimensional to that area, which would be received as a result of the simultaneous movement of ice on the entire sea in the form of a solid cover with a given velocity and direction of drift.

5. If the Y axis is oriented along the principle direction of the ice exchange of the sea with an adjacent part of the Arctic Basin, the projection of the velocity of the drift on the Y axis (W_y) characterizes the velocity of the transport of ice beyond the bounds of the sea or the transport of ice from without. The projection also of velocity of drift on the X axis (W_x) characterizes only the hummocking within the bounds of the sea, thereby not changing the total quantity of ice in the sea. The changes in the quantity can be stipulated at the same time only by the accelerated accretion of young ice in the areas of clear water which are cleared off during the drift.

6. During the orientation of the projection of the velocity of the drift on the Y axis, the transport out of ice which is linked with the freezing of areas of clear water proceeds to the side of the Arctic Basin. In addition to this, no hummocks occur. In the case of the orientation of the projection of the drift on the Y axis, the location which is linked with the hummocking within the bounds of the sea, has the entrance of the ice into the sea laterally from the Arctic Basin, which is in contrast to the transporting out of ice. At the same time, three areas of water are not formed.

As a result of the appropriate calculation, Somov arrived at the following formula:

$$H_n = H_{n-1} + \Delta H_n + \frac{w_{xn}t}{2a} \Delta h \pm \frac{w_{yn}t}{b} (H_{n-1} + \Delta H) + \frac{w_y t}{2b} \Delta h_n, \quad (1)$$

where H_n = the average thickness of the ice in the sea at a given moment,

H_{n-1} = the average thickness of the ice in the sea at a preceding moment,

ΔH_n = the increase in the average thickness of the ice in the sea for an examined space of time,

Δh_n = the thickness of the ice which had been formed in clear water for an examined period of time,

$w_{xn}t$ = the transference of ice along the X axis for an examined period of time,

$w_{yn}t$ = the transference of ice along the Y axis for an examined period of time,

a = the length of the sea (along Y axis),

b = the width of the sea (along X axis).

The fourth component in the first part of the equation has a minus sign in the orientation of W_y to the side of the Arctic Basin and the plus sign in the orientation of its side in the sea. The last member of the right side enters only with the plus sign and only then when the preceding member has a minus sign. The last three members

$$\frac{w_{xn}t}{2a} \Delta h_n \pm \frac{w_{yn}t}{b} (H_{n-1} + \Delta H_n) + \frac{w_y t}{2b} \Delta h_n$$

for brevity are defined by means of A and are reckoned by the general correction for the average thickness of the ice in the sea due to the drift.

Thus formula (2) is derived:

$$H_n = H_{n-1} + \Delta H_n \pm A. \quad (2)$$

Somov's method was carried out by Biriulin and Somov for the calculation of the average thickness of ice in the southern part of the Laptev Sea for the past years. The borders of the region to which the calculations refer, are shown in figure 105.

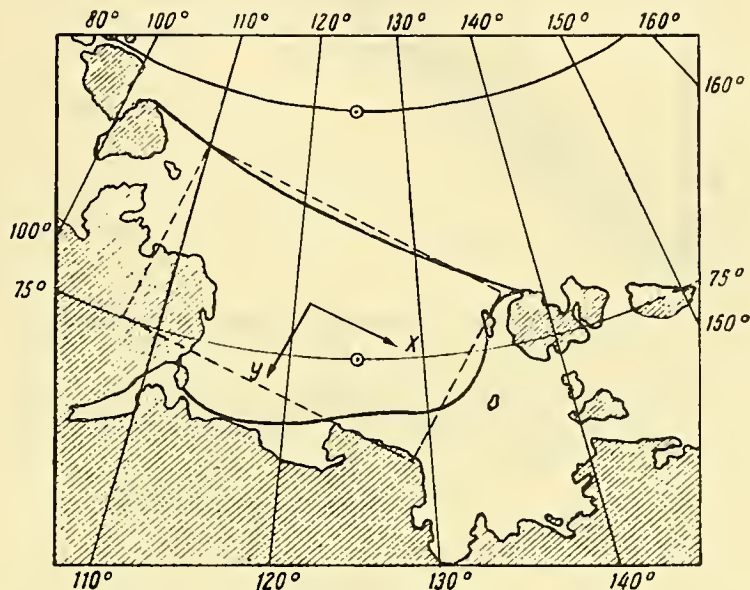

Figure 105. Borders of the examined part of the Laptev Sea.

The calculations of the accretion of ice were carried out according to the formula proposed by me, in which the necessary number of degree days of frost was computed as the arithmetical mean for the observations of the stations which were located on the periphery of the region and namely; the "Cape Cheliuskin," "Tiksi Bay," "Schalamrov" and "Koletsnoi Island."

Two points on latitude 75° and 80° along the meridian 125° were chosen for the calculations of the elements of the drift. According to my method (see Sections 135 and 136) and chiefly on the assumption that the wind drift occurs along the isobars and with a velocity inversely proportional to the distance between the isobars; according to monthly charts of pressures, the directions and velocities of drifts for 3 points were calculated and later averaged. The average thickness of the ice in the Laptev Sea without the calculations of the drift--according to formula (2)--and the average thickness of the ice with the calculation of the drift as shown in figure 106 according to Biriulin and Somov.

It is distinctly clear from the picture that the influence of the drift on the average thickness of the ice begins to significantly show an effect from February, gradually increasing in effect until May, inclusive. The difference between the thickness of the ice which is computed without reckoning of the drift and of the thickness which is computed with reckoning of the drift may reach 70 cm, which comprises about 40 per cent of the maximum thickness of the ice.

Proceeding from the average thickness of the ice to the total quantity of the ice in the sea, it is possible to conclude that due to the drift, 40 per cent of the total quantity of the ice which is formed in the course of the winter appears to be transported from the sea (until May).

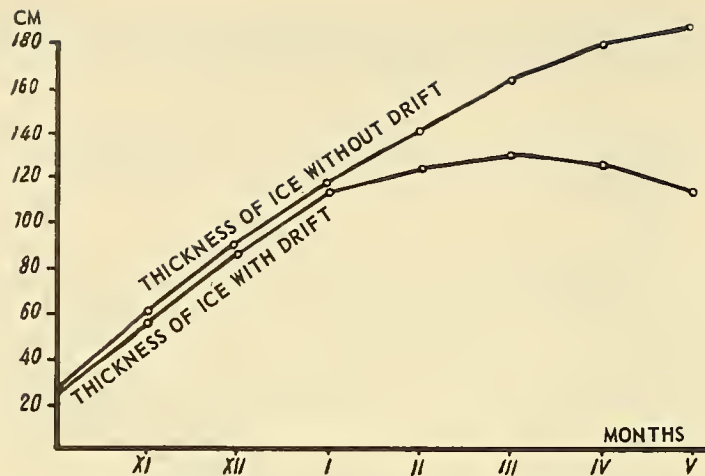

Figure 106. The average thickness of ice in the Laptev Sea with calculation and without calculation of the drift.

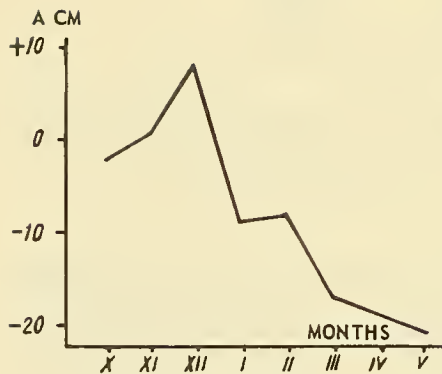

Figure 107. The correction of the average thickness of the ice for the drift.

Figure 107 confirms that material just discussed. In this figure, the average values of the total correction for the average thickness of the ice which is conditioned by drift, are drawn for a period of 4 years. It is seen from the graph that the negative correction increases in spring and reaches its maximum in May.

In Somov's method, as yet not entirely worked out, the correction for hummocking is absent. This correction is extremely complicated, but at the same time, it has an essential value.

LITERATURE: 18, 77, 123.

Section 107. The Influence of Hummocking of Ice

Every ice formation increases the salinity of the surface layers of the sea. For the calculation of this salt increase, I propose a simple formula.

$$\Delta S = \frac{0.9 S_0}{z} \Delta i, \quad (1)$$

where S_0 = the initial water salinity,

z = the depth of the layer, entrapped by vertical circulation during ice formation,

Δi = the increase in the thickness of the ice (with assumption that the salinity of the ice itself is equal to 0).

Carrying out formula (1) Dobrovolskii assumes that the ice formed is from time to time hummocked.

With such an assumption, the salinity after the first formation will be equal to

$$S_1 = S_0 + \Delta S, \quad (2)$$

where

$$\Delta S = \frac{0.9 S_0}{z} \Delta i.$$

After the first hummocking and the new formation of ice in the area of clear water, we derive

$$S_2 = S_1 + \Delta S_1, \quad (3)$$

where

$$\Delta S_1 = \frac{0.9 S_1}{z} \Delta i.$$

Substituting formula (2) and formula (3) we derive

$$S_2 = S_0 \left(1 + \frac{0.9}{z} \Delta i \right)^2. \quad (4)$$

After n hummockings and freezing accretions of ice of one and the same thickness, we derive

$$S_n = S_0 \left(1 + \frac{0.9}{z} \Delta i \right)^n.$$

Dobrovolskii uses, furthermore, formula

$$\Delta i = n \Delta i_i + (1 - n) \Delta i_w, \quad (5)$$

where n = the iciness in points,

Δi = the total increase in ice,

Δi_i = the increase in ice under the ice,

Δi_w = the increase of ice in clear water.

Dobrovolskii transposes formula (5) for convenience thusly

$$\Delta i = \Delta i_w - n (\Delta i_w - \Delta i_i). \quad (6)$$

Dobrovolskii also computes the sizes for Δi_w and Δi_i according to the formula proposed by me,

$$\Delta i = - (25 + i_0) + \sqrt{(25 + i_0)^2 + 8R}. \quad (7)$$

For illustration of his conclusions, Dobrovolskii solves the following individual example. At the initial moment, the thickness of a layer of water, attracted into a vertical circulation by the salt increase during ice formation, is equal to 25 m; the initial salinity of this layer is equal 30 o/oo, the number of degree-days of frost for the examined region is 5000.

In table 85 Dobrovolskii's computations are quoted for the following three cases:

1. 5000 degree-days of frost are realized in 20 series (each gradually at the rate of 250 degree days); after each series, hummocking occurs.
2. 5000 degree-days of frost are realized in 10 series at the rate of 500 degree days.
3. 5000 degree-days of frost are realized in series of 5 at the rate of 1000 degree days.

Examining table 85, we see that the less the iciness and the more often hummocking occurs, the stronger the increase in salt.

As Dobrovolskii correctly notes, the examined phenomenon can give some indications for the explanation of comparatively high salinity in the sub-surface (to 100 m depth) of the layers of part of the Arctic Basin during extremely low temperatures.

TABLE 85. THE SALT INCREASE IN THE ALYER 25 M THICK WHEN THICKENING OF ICE TO 150 CM WITH 5000 DEGREE-DAYS OF FROST AND WITH ICE OF VARIOUS POINTS

Points	Salinity in o/oo		
	I	II	III
10	31.35	31.22	31.16
9	31.77	31.57	31.44
8	32.23	31.91	31.67
7	32.76	32.36	31.95
6	33.21	32.71	32.26
5	33.67	33.07	32.48

LITERATURE: 45, 164, 165.

CHAPTER VIII

MELTING OF SEA ICE

Section 108. Phases of Weakening and Destruction of Sea Ice

Two processes constitute the main factors in the destruction of an ice cover--evaporation and melting. In the first, the ice is transformed into water vapor; in the second, into water.

Evaporation is proportional to the above-water surface of the ice. It is obvious that other conditions being equal, the more cut up the ice surface, the greater the evaporation.

Melting occurs as a result of the ice absorbing solar radiation or atmospheric heat in proportion to the above-water surface, and the absorbing of heat from the adjacent water in proportion to the sub-surface area of the ice.

Since the ratio of surface area of bodies to their volumes is greater when their dimensions are smaller, it is natural that the influence of evaporation and melting is felt primarily by small ice formations. In this connection, the breaking of ice fields into smaller parts by various factors acquires special significance. Breaking occurs more readily when the ice is less thick and tough. The firmness or solidity of the ice, as we have seen, depends in significant degree on the ice temperature. Therefore, breaking up is usually preceded by weakening of the ice due to absorption of the sun's radiation and heat from the atmosphere and the water.

Melting of ice starts first near the shores, partly due to the influence of shore drainage and soiling or dirtying of the littoral ice (which contributes to increased absorption of radiation), and partly due to the great crushing of the littoral, floating ice floes.

Weakening, breaking up, and melting of sea ice go forward in parallel fashion, and do not cease until the ice is completely demolished. Nevertheless, the process of demolition may be conditionally divided into stages of weakening and destruction.

1. The first phases of weakening of ice are the internal deformations which are brought about in the sea ice immediately after its temperature, having reached a minimum, begins to rise due to the influence of various factors. These internal deformations are accompanied by a descending movement of the brine and an increase in the ice porosity. With the appearance of the sun over the horizon in the spring, the shiny, silvery ice-rind (*kor'ka*) begins to form on the surface of the snow. Simultaneously, the accumulation of heat from solar radiation begins under the ice-rind. With continuing increase in the height of the sun and start of daily variation in air temperature there begins a reduction of the snow cover, settling of the hummocks, floating away of the sharply jutting sections of the ice floes, and development of thermal cracks which weaken the ice.

2. The next phase in the weakening process is the gradual melting of the winter ice cover and formation on the ice surface of snow-water puddles. In case of chance freezing, these water puddles are covered with a thin rind of ice which protects the water from cooling. Simultaneously the

foreign elements are washed away from the snow and ice into the deeper cavities of the water puddles, the raised parts of the ice become less saline due to washing by the thaw water of the brine from the salt cells, and the hummock contours become rounded.

3. After the individual deep spots in the snow puddle have melted through completely the snow water runs off under the ice with subsequent ice formation underneath the existing ice. The newly-formed ice eventually rises to the surface with the melting of old ice above. This phase concludes the weakening of sea ice.

4. The first phase of ice destruction is the breaking-up, under the influence of external forces, of the ice fields into more or less large sections along the lines of least resistance. The first movements of the ice cause the cracks to be made larger due to the hummocking of the contiguous parts. In the process of hummocking the individual floes are not fused into a single piece due to the fact that their temperature is high by this time. With the increase in quantity and size of the cracks the amplitude of movement of the ice is progressively increased.

5. The second phase of destruction is the rounding of the broken-up formations, the increase in size of the water spaces which form a belt around the individual ice chunks, and the formation of ice cornices and shoved-under floes, or *posdovy*. During this stage there is much movement of the ice back and forth. The last ice (*prapai*) ceases to exist as such and changes over to floating ice floes.

6. The next phase of destruction is the gradual decrease in vertical and horizontal dimensions of floes. There occurs simultaneously a decrease in total ice area due to the collisions of the separate fields and floes with each other, and due to the formation of hummocks.

7. In the open sea, in the course of destruction of ice, not only are the dimensions of individual floes decreased but also the total ice coverage. In this connection the washing action of the waves becomes effective. The recessing along the water-line becomes greater and greater, and the small floes finally acquire the very characteristic form of "ice lilies" and "ice ducks."

8. Under regular conditions of melting, the hummocked ice fields are gradually changed into smooth fields. Thus the thickness of the fields becomes less and less, and before disappearing completely, the ice becomes very similar to young "rind" ice, or *nilas*. Such a characteristic process was carefully traced in the spring of 1942 by the air-reconnaissance missions of Kotov and Morozov in the White Sea.

9. The final phase of destruction is the disintegration of the ice into separate pieces; e. g., ice crystals or rounded ice globules of uniform texture and the remains of the condensed cores of the hummocks.

In order to make possible comparisons in the practical usage of information on the degree of destruction of sea ice by thawing in spring and summer seasons, the following point scale has been worked out by Somov:

1 point - Complete absence of external signs of destruction. Breaks in the ice are sharp. Ice surface is white.

2 points - Small quantity of snow puddles; no cracks or drain holes present. If the ice is in such small fragments that snow-puddles cannot form, the very

fragmentation of the ice indicates the start of the first stage of destruction (mechanical).

- 3 points - Large quantity of snow puddles and some drain holes present. The edges of the floes are rounded, often forming an ice peak which hangs over the surface of the water. Ice surface is predominantly white.
- 4 points - Large quantity of drain holes and snow-puddles present, joined to each other by rivulets. Ice surface is often similar to lace. The arches between the drain holes are still white or dirty brown if there is any mineral-organic sediment on the ice. In brash ice there are often found mushroom-shaped floes with a noticeable list and with sub-surface "spurs" or "rams" (*taran*). The smallest floes are strongly saturated with water and are gray in color.
- 5 points - The ice is badly destroyed by thawing and sits deep in the water. There appear over the water only the higher parts of the floes very saturated with water and gray in color. The ice is very often seen in the form of amorphous, small fragments and it is impossible to distinguish their upper and lower surfaces. In such a case there is typically present, among the separate floes, a great quantity of extremely small ice chunks saturated with water, these being the remnants of broken-up floes. These ice chunks are somewhat reminiscent of "sludge-ice" (*kasha*). In certain instances the ice retains the dimensions of the large fields, thickly covered with drain-holes, similar in appearance to "lace" (level ice which has its origin in the spring). With a small visual angle such ice is difficult to distinguish from open water.*

Obviously, melting commences at different dates for different regions depending on climatic conditions. Generally speaking, the further north the later the date. In the case of far north regions, the ice can pass through only a few of the phases of melting before the beginning of winter cold. Thus, for example, the ice field on which the "North Pole" station was constructed in the course of the summer of 1937 went through the phases of formation of thaw-water puddles on its surface and flowing off of thaw-water under the ice. The ice which drifted with the *Sedov* in the course of the summer of 1939 also went through the stages of flowing off of thaw-water from the snow-puddles, draining, and new ice rising to the surface.

The most decisive of the above-enumerated phases in the thawing process are: appearance on the ice fields of the first water puddles, breaking of the large ice fields into smaller fields, and the first movements of the ice. The earlier these phases occur in any particular region of the sea, the earlier will occur the complete disappearance of the ice, other conditions being equal. At least, a decrease in ice area will occur sufficient for navigation purposes. The importance of these phases is determined by the oft-emphasized fact that while the snow and ice are the most perfect reflectors of radiant energy, water is an extremely effective absorber of it.

LITERATURE: 62, 77, 88.

*The above scale was worked out before the actual navigation of 1943. It has not yet been verified in practice and therefore cannot pretend to precision and accuracy.

Section 109. Initial Phase of Weakening of Ice

In sea ice, due to its physical and chemical peculiarities, melting commences from the moment when the ice temperature, having reached a certain minimum, starts to rise under the action of one or another factor. These factors are the absorption by the ice of the direct and diffused solar radiation, and of heat from the adjacent air and water layers.

During the polar winter the reception of radiant energy is zero and therefore the chance increases in temperature of the surface layers of ice are caused entirely by absorption of heat from the air. This absorption is by no means slight. Table 86 shows the average positive deviations from the mean monthly ice temperatures observed by Malmgen in January 1924 (author's computations).

TABLE 86. AVERAGE POSITIVE DEVIATIONS FROM MEAN MONTHLY ICE TEMPERATURES IN JANUARY 1924

Ice depth in cm	0	25	75	125	200
Temperature deviations in degrees Centigrade	2.4	1.6	0.6	0.2	0

From this table it may be seen that the positive deviation of temperature embraced the ice layer to a depth of 200 cm and raised its temperature on an average of 0.6°. If we consider that under low temperature conditions, sea ice has a specific heat equal to 0.5, we find that each square centimeter of ice surface in the case under consideration absorbed nearly 64 g/cal from the atmosphere during the month.*

The reflecting quality of the snow which covers the sea ice is the basic factor which determines the melting of the sea ice by the action of radiant energy. It is therefore clear that, generally speaking, melting commences earliest wherever the snow surface is solid or dirtied by one means or another.**

*Computations based on the original data published in Malmgren's "On the Properties of Sea Ice" from the Scientific Results of the Norwegian North Pole Expedition with the Maud 1918 to 1925, Vol. 1 and 1A, show that the temperature deviations in table 86 at 125 and 200 cm are 0.5°C and 0.4°C instead of 0.2°C and 0.0°C as given by Zubov. Furthermore, the amount of heat absorbed from the atmosphere per square centimeter of ice surface for the month should be 54 g/cal rather than 64, as shown by the following computation:

$$dQ = c \rho V \Delta T$$

where dQ = amount of heat absorbed,
 c = specific heat of ice,
 ρ = density of ice,
 V = volume of ice affected,
 ΔT = increase in temperature.

- Translator.

**Contrarily, a large amount of dirt or scattered stones on the ice, due to their low heat conductivity, will retard the melting of the ice.

This soiling is especially marked in coastal or shallow water ice where particles of shore origin fall onto the ice by one means or another and also on open sea ice where the ice surface is dirtied as a result of biological process. For example, Nansen noted that on 18 June 1895, when the *Fram* was at 81° 21' north in the midst of ice at least three years old, a dirty brownish ice was predominant.

Foreign particles embedded in the ice decrease its total reflecting capacity and become centers around which the melting is concentrated. However, even completely clean ice which is covered with clean snow will finally yield to the action of radiant energy since a certain part of this energy does penetrate and is absorbed. Obviously, the first to melt are the surface snow flakes, which fuse into a solid mass having great reflecting capacity (solar korka or ice-rind). The snow surface acquires at this time a blinding white color which gives rise to a painful eye inflammation in the early spring at polar stations - commonly known as "snow blindness." The horizon becomes indistinct and sometimes a strong refraction is observed. If the sky is covered with a thin cloud layer, the whole atmosphere appears to be filled with a peculiar silvery light, similar to the light reflected from a polished silver plate.

But the solar radiation, which falls onto the snow surface and fuses the surface flakes, at the same time penetrates into the snow and causes its settling or packing. Along with the packing the heat conductivity of the snow is increased and thus the heat transfer from the snow to the ice is hastened.

Despite the fact that in the early spring in the southern parts of the Arctic Basin the air temperature does not go above -10° during the day and often falls below -30° at night due to radiation, the first icicles and liquid drops of ice brine appear on the jutting prominences of hummocks which are turned toward the south and the sharp edges of the ice floes begin to melt and become rounded.*

With further raising of air temperature and increase in solar radiation the surface layer of the snow is saturated with water and its absorption ability is increased.

In case of a sudden cold spell, ice rind is always formed on the snow surface. This ice rind is of great significance for further melting. Actually, as we have seen, even very thin layers completely block the passage of long wave radiation. From this it follows that after an initial or repeated formation of ice rind on the snow cover over the ice, the radiant energy entering the ice is transformed into heat but cannot radiate back onto the atmosphere due to the "hot-house effect" of the ice rind.

Thus the heat is gradually stored up in the snow and ice, and makes itself felt in the temperature increase in that part of the ice which is lighted by the sun. In the deeper parts of the ice this heat is absorbed primarily not by the ice crystals themselves but by the foreign matter. This explains the fact, as we have seen, that pond ice which has formed under quiet or calm conditions acquires in thawing a typical honeycomb appearance and that all accretion ice, including sea

*On Sosnovets Island, 26 to 29 February 1928, a settling of snow due to influence of solar radiation was registered with a temperature of -15°. During the wintering of the Russian Polar Expedition in the Laptev Sea instances were observed of melting of sea snow in the sun with temperatures of -15° to -20°.

accretion ice, breaks up at the moment of complete destruction into separate long needles, which represent the remnants of the crystals.*

It is natural that the projecting parts of sea ice--the hummocks and snow hills--are the first to be subjected to thawing. The intensity of heating by direct solar radiation is directly proportionate to the sine of the angle of incidence of the sun's rays, which is why the vertical walls of ice, in polar regions are heated considerably more intensively than the horizontal surfaces. For the same reason, upon the first appearance of the sun over the horizon, even with very low air temperatures, ice stalactites and icicles appear on the heapings which face toward the south and hang out over the level ice.

Under polar conditions, as we have seen, the diffused solar radiation has particular importance. The surface area of heaped ice accumulations, subject to the influence of solar radiation, is considerably larger than the area which these heapings occupy on the level ice. Thus the diffused radiation also destroys the heaped-up masses in considerably greater degree than the level ice.

Destruction of the heaped accumulations is greatly increased by winds. With warm winds condensation occurs accompanied by a discharge of heat; with cold winds there is evaporation of the ice. In addition, the wind continually packs the snow by its pressure.

All these factors are most destructive to the steeply projecting slopes and gradually the angular and sharply-cut form of the hummocked or heaped-up fields disappears and is replaced by the smooth outlines of hills and ridges.

Thus, with the passage of time, the upper surface of even those fields, which were extremely hummocked in the beginning, commence to resemble more and more the form of sand dunes or "sheep foreheads" - geological forms created as the result of movement of glaciers. Such forms, of course, have their sloping side to the south and steep side to the north.

According to *Sedov* observations, we may conclude that if the level ice thawed to the extent of 50 to 70 cm from the top during the summer of 1939, the hummocks decreased in height by 2 to 3 m.

LITERATURE: 62, 77, 88, 104, 107.

Section 110. Snow Puddles and Lakes on Top of Ice

Simultaneously with the settling of the hummocks and snow on the ice surface, the first dark patches appear in the low places of the ice fields. These dark patches, consisting of snow saturated with water, are the initial forms of the snow puddles and over-ice ponds and lakes which are formed by thaw water flowing off into these low places from the surface of the nearby hummocks.**

*The falling apart into individual crystals in the thawing process is particularly characteristic of nilas ice (frozen sludge), which has not been subjected to hummocking. Ice which has undergone hummocking formation during its period of existence usually maintains the form of hard ice globules right to its final disappearance.

**In the majority of cases the ice fields consist of ice floes frozen together. These ice floes, due to their continual bumpings and rotations, usually have a rounded form and are bordered with small hummocks. For this reason, the low spots on the ice fields are the central parts of the ice floes which have fused to form a field.

Once having formed, these snow puddles usually continue to increase steadily in size during the polar summer. Actually, in the case of chance freezes, the protective action of the ice rind keeps the water from freezing.

The following observations testify to the importance of the role of such a protective ice rind in maintaining the high temperature of the water.

During the expedition on the *Sadko*, on 30 August 1935, a water temperature of 0.25° was observed in a water puddle on the light blue ice, the water being covered by an ice rind 10 cm thick. The highest water temperature observed in the puddles under the protective rind was 1.2°.

On 29 August 1939, according to observations of the *Sedov* a snow puddle was covered by a surface layer of ice 4 cm thick, separated from the lower 7.5 cm ice layer by a layer of very watery flaked ice (kasha) 2 cm in thickness. Under this entire ice layer the water temperature was 0.2°.

Inasmuch as the water temperature in the puddles on the ice gradually rises, and since the water is constantly shifted by winds and other factors, with the passage of time the accumulation of water in the ponds is caused not only by the melting of snow on the ice surface, but also on account of the melting of the ice layers which are in direct contact with the water in the pond.

At first, each individual water basin on the ice contains its own water and is isolated from the neighboring ponds and from the sea underneath the ice. Actually, some of the snow water runs off in the beginning into the cracks which are present in the sea ice. But upon meeting the ice layers whose temperature at this time is still considerably under the freezing point, this water freezes, stops up the cracks, and thus prevents the main body of water from running off under the ice.

Thus the first melting of snow on the ice cover brings out the appearance of fresh water basins on the ice, and these gradually increase in size and join one to another, so that by the end of this process the surface of the melting ice, when seen from a distance, has the appearance of a sea which is covered with small broken ice (figure 108).

Rising over the water, whose depth reaches one meter and over in certain parts of the southern regions of the Arctic Basin, there may be seen only the tops of hummocks, stamukhi, and chunks of many-year-old ice.*

When the ice is thus covered with thaw water puddles its resemblance to the open sea is still greater during a wind when the water surface is covered with ripples and small waves.

This phenomenon is especially typical of the pripai (fast shore ice) along the arctic coast and the islands, but it also takes place on the ice of the Arctic Basin. Thus, according to observations of the *Sedov* on 20 July 1939, all the snow disappeared from the surface of the ice, and within the range of visibility from the bridge it was possible to estimate that 40 per cent of the ice surface was covered with snow puddles.

*The *Soviet* in 1932 and the *Krasin* in 1935, in the Chukotsk Sea observed many-year-old ice with height of 4 to 5 m over the water and depth of 10 to 12 m. The fresh water puddles on this ice were as much as 6 m deep. On the ice field of the "North Pole" station, the dimensions of the largest puddle were: length 400 m, width 200 m, depth 2.4 m.

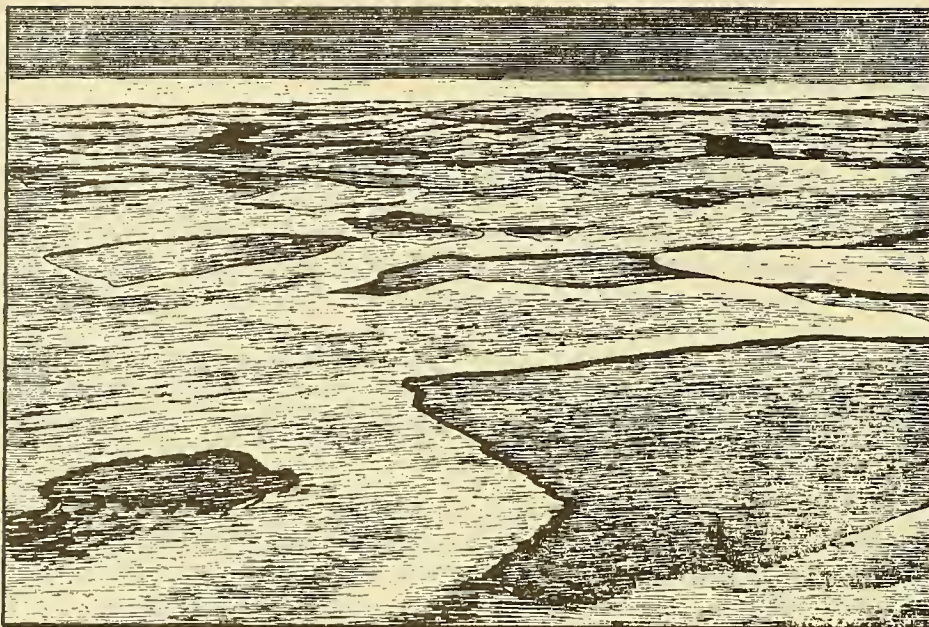

Figure 108. Snow puddles.

Naturally, all the foreign matter in the snow and ice is gradually washed off into the deepest parts of each individual water puddle. Organic life also accumulates and develops in these hollows. Due to the dark color of these accumulations, the absorption of heat is here intensified. These deep places gradually begin to grow in a vertical direction and when the ice temperature has risen sufficiently so that the fresh water does not freeze in the cracks, the bottom of the hollow finally reaches the sea water. Then the whole mass of snow water flows off precipitously under the ice, forming torrents and whirlpools as it goes. In one or two days the surface of the ice appears to become dry and come out from under the water. There remain on the ice surface only a few isolated water puddles, some above the sea level, (no through channels are present, hence the water is fresh), and some at sea level (through channels are present, water is saline).

The surface of the ice, which was levelled off at the start of thawing by the packing of the snow hills, presents an extremely irregular form after the flowing off of over-ice water. It is pitted with hollows and has a curvature typical of the washing process. After the ice dries, cracks often appear and the central parts of the ice under the water puddles--the thinnest parts--break apart and float off.

The appearance of surface water and its subsequent running off occurs most intensively in littoral ice. Here the melting begins earliest due to the dark surface of the shore and the dirtying of the coastal ice. The water formed from the snow cover on the ice unites with the water of the coastal flow. As a result there are formed the "coastal fringes of water" (*zaberegi*) which attain a width of 5 km in certain shallow regions, for example, along the Lyakhovski Islands. With passage of time, the ice under the coastal water fringe is more and more washed away and the coastal fringe becomes a "thorough coastal water fringe." This in turn, is transformed into a "coastal polynya."

Under arctic conditions such a coastal polynya may last the whole summer until freezing commences in spite of the large amount of ice in the sea. If the water is shallow and with strong wind pressure from the sea, huge ice blocks (*nesiak*) which sit deep in the water and stay close to the shallows check the pressure of the sea ice on the shore. Littoral islands perform the same function. Thus, navigation becomes a possibility in certain regions for shallow-draft boats close to the shore.

After the fresh water flows off under the ice and the ice dries due to its rising above sea level the thawing process goes on, as before, in most intensive fashion. This is especially true of the edges of ice which are adjacent to ponds of fresh and salt water and on the southern slopes of the individual heaped-up accumulations.

In the water puddles on the ice, where the intensive accumulation of solar heat occurs, the melting of ice or contact with the warmer water is hastened by its continuous movement. Water movements are caused partly by the wind, partly by unequal heating and cooling.

Burke remarks that the characteristic peculiarity of melting of flat type floes (*smorozi*), consisting of compressed and frozen together grated ice and finely broken ice, is their rapid breaking apart into separate pieces. Due to this, formation of snow puddles does not occur on ice fields of flat type floes. The water oozes through the thickness of the flat type floes and runs off under them. The entire floe becomes very rotten, although not watery, and is easily cracked through by a ship.

LITERATURE: 3, 11, 23, 62, 77, 88, 104.

Section III. Circulation of Water Caused by Ice

In order to represent more clearly the movement in the water adjacent to and touching the melting ice, let us suppose that an individual floe is floating in the sea. The sea water directly adjacent to the ice is slightly cooled and freshened (made less saline) by mixing with the thaw water. In the process of cooling and becoming less saline the water density either decreases or increases, depending on its salinity.

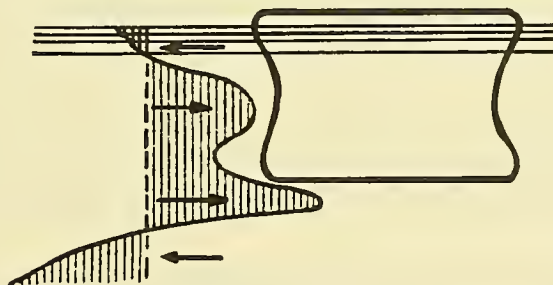

Figure 109. Circulation set up in water in contact with ice.

As a result of the change in density of the water directly adjacent to the ice a circulation is always set up, as has been corroborated by the experiments of Petterson and Sandstrom. This is indicated by arrows in figure 109. Thus, every ice chunk floating in the water acts as a sort of automatic pump which pulls to the ice chunk constantly changing water masses and thus, by this very act hastens the melting process. As a result, of this process "cornices" are formed above the waterline of every ice floe. These gradually break off and fall into the water.

Along with the thermal influence of winds on the water, there is felt a mechanical effect which results from the influence of wind, waves and current. The wave movement washes away the edges of the water puddles while the current hastens the circulation and drives the individual ice chunks from place to place, bumping them against each other. The circulation which is set up by the wind in polynyas and puddles, where ice of various sizes and shapes is floating, may sometimes be extremely complex. I have often observed how, when the wind springs up in certain polynyas, the first to start to move with the wind are the small ice floes having little inertia. Then, when the larger ice floes have started to move with the wind, the small floes start to be carried against the wind by the compensating current. This phenomenon continues until all the floes in the given polynya are driven towards its leeward edge.

LITERATURE: 62, 171.

Section 112. Second Phase of Weakening of Ice

The melting of ice is particularly increased when the air temperature, rising gradually, goes above 0° . Then an increased absorption by the ice of atmospheric heat commences. This heat may be either from heat of advection (carried hither from other regions of the sea or dry land), or local. From the very beginning of formation of water hollows on the ice, the sun's heat is expended partially on heating of the snow-water hollows and partially on evaporation. The air, which is saturated with moisture in the evaporation process, is carried over the comparatively cold surface of the ice, thus freeing the heat of condensation and causing the formation of fog and condensation of moisture on the surface of the snow. The snow is reduced and "eaten away" in this process. It is obvious that this process is stronger when the water area is large in comparison with the surface area of ice.

From this there clearly appears one more characteristic peculiarity of melting of the ice cover.

The first to start the thawing process is the "winter snow" which covers the ice, and the resulting thaw water flows away into the snow puddles. After this process the ice surface is free of snow. However, this phase lasts only a short time while the low winter temperatures are retained in the surface layers of the ice. With passage of time, due to penetration of the ice by solar radiation, the surface layer of ice starts to be destroyed and is changed first into porous ice and then into granular ice not very different in appearance from decomposing snow. According to the observations made by Gordienko on the ice of the Chuckchee Sea the average thickness of "snow" formed from the ice varies from 10 to 15 cm. This "summer snow" is continually destroyed from above by melting while its thickness is constantly increased from below on account of the penetration of atmospheric heat into the ice. Thus the thickness of the snow cover which is formed from the ice as a result of melting remains more or less constant for each region.

Along with thawing of the snow a strong desalinification or softening process of the higher parts of the ice floes occurs. The fresh snow-water flowing off through the ice capillaries at first freezes and thus blocks off the exits, but at the same time due to expansion on freezing, it causes formation of cracks in the adjacent parts of the ice. With the later rise in temperature the freezing of thaw water in the cracks ceases, and this thaw water commences to wash away very thoroughly the brine from the salt cells of the ice. Thus, a softening of all parts of the sea ice which lie above the water is gradually accomplished.

As has already been shown, the melting process begins first on the more soiled parts of the ice. In addition, the more saline the ice the greater its ability to absorb solar heat. We have noted that as a general rule the ice near the thermal and dynamic cracks (which are formed at low

air temperatures after formation of the solid ice cover) has the greatest salinity. It is natural that the ice in these cracks is weakest and is the first to melt. In this manner the dynamic and thermal cracks which form during the winter become the natural lines of cleavage of the ice in the spring.

In relation to the cleavage, the drain holes also are an important factor. Actually, the bottom of the thaw water puddles gradually becomes covered with such a large number of drain holes* that the ice becomes like a kitchen skimming spoon.

LITERATURE: 62, 77, 88.

Section 113. Influence of Micro-Organisms and Inorganic Inclusions on Destruction of Sea Ice

Both on the surface and within the ice there accumulate during the course of the winter all sorts of nutritive matter which is freed during melting and thus "fertilizes" the surrounding water.

In the first place, along with precipitation which falls onto the ice surface, compounds of nitrogen, phosphorous and silica are concentrated. With the subsequent evaporation of the snow and ice this material may remain on the ice surface and thus gradually be further concentrated.

Secondly, the accumulation of nutritive matter in the ice itself is explained by the peculiarities of the process of ice formation in the sea. We have seen that with sufficient cooling and mixing the initial colloidal ice particles are produced throughout the entire thickness of the layer involved in the vertical circulation. It is possible that these initial formations are produced around the minute particles of organic matter suspended in the sea water and around the turbidity of continental origin which is found even in those regions which are most remote from the continents.

The lumps of deep ice which are formed as a result of freezing together of the individual colloidal ice particles, after their size has increased to a certain limit, float up and bring with them to the surface the particles of organic matter and turbidity (muddiness) which later gradually freeze into the surface of the ice. This phenomenon acquires special significance, of course, in those cases where the mixing process reaches the very bottom--i. e., primarily in shallow regions.

The formation of deep ice in small fresh-water puddles, as we have seen, ceases with the formation of the solid ice cover. In the sea, however, this process actually continues throughout the water. In this manner the sea ice sucks in the nutritive matter from the atmosphere on the one hand, and on the other, the turbidity and organic matter from the entire water layer which is involved in the mixing process.

Along with the dissolved nutritive matter and organic matter, all sorts of planktonic organisms and bacteria are frozen into the ice. Certain of these die under the influence of the low temperatures but some few forms (primarily bacteria and spores which can withstand very low temperature) survive and begin to develop intensively with the start of the thawing. These organisms give rise to life both on the ice itself and in the water which results from the melting of the ice.

*The swinging or rocking movement of the ice is an important factor in increasing the size of drain holes. All of these are round in shape, which appears to be a result of their being washed by the thaw water.

Buktevich shows in the bacteriological research in the Greenland, Barents and Kara Seas that the greatest quantity of bacteria was found first in the regions of the contact of water masses of different physico-chemical character, and secondly, in regions of melting ice. The first is explained by the fact that the mixing of different waters creates unfavorable conditions for the plankton organisms which are typical of each separate water mass. The plankton thus partially die off and are thereby transformed from consumers of bacteria into material for feeding the bacteria. The second is explained by the accumulation of bacteria in the ice, as described above. This is best demonstrated by the following figures:

According to Buktevich, during the expedition of the *Sadko* in 1935, in one of the summer water puddles on the ice there were found 60,000 bacteria in 1 cc of water, while the maximum quantity of bacteria found in the waters of the Greenland, Barents and Kara Seas did not exceed 27,000 in 1 cc.

As has already been noted, a part of the dissolved nutritive material and organic matter is exuded back into the water together with the brine, but the larger inclusions remain in the ice and finally appear on its surface. Actually, as we have seen, the ice is formed from beneath, melts and is destroyed from the sides and top. It is estimated that in the Arctic Basin approximately the same quantity of ice accumulates by freezing from beneath. Thus, every particle frozen into the ice from below will appear on the surface in two to three years.

In the spring when the small puddles of thaw water are formed on the ice fields, the micro-organisms and in particular the plant life which have retained their vitality during their stay in the ice find unusually favorable conditions for their development in these small lakes--an abundance of light and an abundance of nutritive matter.

According to Palibin, little is yet known concerning the biology of this group of organisms. They are usually differentiated by the color which they impart to the snow or ice. The usual color of fresh-water or sea-ice organisms is yellow or dark yellow. This is explained by the large quantity of fat in the cellular content, facilitating the absorption of solar energy in the summer and somewhat protecting the organism from cold in the winter. In addition to yellow, there are also found green, red, and even black colors, due to the presence of various pigments in the cellular content of the organisms' protoplasm.

Thus, for example, the alga *Spherelia nivalis* causes a reddish tint in the snow in the second half of the summer, while the alga *Rasphidonoma navale* causes a greenish tint.

Besides the forms which exist in the ice, certain micro-organisms which are peculiar to sea ice develop during the summer in the ice itself and around it, and form communities. These are called "ice plankton" or "cryoplankton". Most important of the growing and living organisms is the group of ice diatoms of rounded or rhomboidal shape, very distinct from the usual forms of the open sea.

Diatoms as a rule are not found in a living condition on the ice surface, and the reddish-brown ice conditioned by the diatom colonies may be seen only at a certain depth (about a meter) on the bottoms of puddles which have formed on large floes, in cracks of the ice, and on the underwater projections of occasional floes.

Nansen notes that in the Arctic Ocean, when puddles of thaw water are formed on the ice surface under the influence of the sun's rays, dark patches appear on their bottoms. These patches consist of algae, mainly diatoms.

Nansen and Cram, having cultivated the sea collections of the *Fram* noted in addition to the diatoms the presence of infusoria and ciliates which feed on plant forms. Bacteria were also found.

Palibin, describing his observations on the *Erma*k in 1901, shows that the ice forms of diatoms found in the lower strata on the sea ice, completely support the opinion that the diatoms rise from the sea water and freeze into the lower surface of the ice. According to Palibin and Nansen, live diatoms are found only at a certain depth from the ice surface. However, Nansen considered that the diatoms were suspended on the border between the fresh and salt water. Palibin supposes that the most favorable medium for development of diatom forms is sea water of low salinity.

The yellowish-brown accumulations of diatoms, which represent small clumps of a slimy mass, absorb the solar heat and melt away a hollow underneath themselves the width of which is usually two or three times greater than the width of the diatoms. There is no doubt that along with the direct absorption of solar heat, the heating of the ice is caused also to a definite (although small) degree by the carrying on of life processes in the accumulations of organisms, these processes always being connected with output of a certain quantity of heat.

Gradually sinking lower and lower during the course of the summer, through the holes which they themselves are melting away, the diatoms are finally mixed with the sea water.

It should be noted that after formation of the first water puddles on the large ice fields and after the appearance of the first deposits of diatom slime, development continues during the entire polar summer.

The accumulation of diatoms on the ice sometimes reaches such proportions that the ice appears dirty over a large expanse of area and appears perforated in all directions.

During the expedition of the *Sadko* in 1935 the greatest accumulations of diatoms in the north-western part of Barents Sea were observed in the region beyond 80° north between Franz Joseph Land and Spitzbergen. Estimating by eye, at least 20 per cent of the entire ice area was covered with a reddish-brown deposit. Certain ice floes were so dirtied that one got the impression that they were formed right by the shore. Between Franz Joseph Land and Severnaya Zemlya the ice was much whiter and cleaner. This was explained by the fact that in the first region clear weather prevailed during our voyage, and in the second, cloudy weather. Clear weather, as we shall see later in Section 115, creates the appearance of cleanness of the ice; cloudy weather gives the appearance of dirtiness. In any case, in both regions the entire lower part of the ice, revealed when the icebreaker turned the floes over, was brown in color and the podsovy (shoved-under floes) and rams (under-ice projections) of certain of the ice chunks were dotted with accumulations of diatoms. There is thus no doubt, as Palibin has expressed it, that the micro-organisms play a large role in the summer destruction of polar ice.

It is obvious that quantitative calculation of the influence of micro-organisms and inorganic inclusions (dirtiness of the ice) on the hastening of melting is extremely difficult. Therefore the observations of Shestipyorov, made in the spring of 1937 on Cape Schmidt in the Chuckchee Sea, are of great interest. On 20 May areas of 1 square m of ice and 1 square m of snow were strewn with cinders and coloring matter in a thin layer. This decreased the albedo (light reflecting factor) to less than half and as a result the soiled ice by 8 July had melted 173 cm, the clean ice only 120 cm. The soiled snow had melted 48 cm by 6 June while the clean snow melted only 19 cm.

The hastening of melting of ice by dirtying its upper surface is employed in practice, in particular for freeing of vessels which have passed the winter in the ice. For this purpose a path

or road of gravel or cinder is strewn on the ice in the early spring between the ship and the open water. A rather considerable interval of time is required for the subsequent effect. During the German Antarctic Expedition of the ship *Gauss* (1901 to 1903), a strip of rubbish 10 m wide was scattered along the bow of the ship in order to facilitate the freeing of the vessel. During January a furrow formed under the layer of rubbish and the ice cracked along this furrow on 8 February and the ship was able to reach the open water.

LITERATURE: 24, 62, 107, 111.

Section 114. Breaking of Ice During Melting

The basic process which promotes the final destruction of the ice cover is the breaking of the ice fields and fast ice into smaller and smaller parts.

As we have seen in the preceding chapter, ice is broken apart by the wind, the currents and the waves at any time of the year but in the spring, when the ice is weakened by thawing; the fracture of ice requires less force and occurs with certain peculiarities. These peculiarities stem from the fact that the small chunks and grated ice, which are always formed in greater or lesser quantity during the breaking of the ice, melt very quickly and expanses of open water appear between the floes, thus giving the individual floes a certain freedom of movement.

Whatever the causes for the breaking up of the field into separate parts, it is natural that the outer contours of these parts will be accidental (random) and will have comparatively sharp angles.

Various forces will react in various ways on the broken-off parts. If the ice field, before the fracture, was moving with a certain speed and in a certain direction under the influence of current or winds, then the broken parts of this field, of various sizes and shapes, will move with various speeds and in various directions. Under the influence of the wind, for example, certain floes may begin to turn about in such a way that the wind pressure on the floe balances the resistance of the water and the coriolis force. Due to inertia, large ice floes start their movements by wind influence somewhat later and due to resistance of the water move slower than the small floes. Under the influence of ebb and flood tides, the individual parts of the broken-up ice field will sometimes press together, sometimes move apart, and so forth.

Thus immediately after the break-up of the ice field there are created the rotating and advancing movements of separate parts with various speeds and directions. These movements acquire particular importance in the case of comparatively open ice where they inevitably result in collisions. The first consequences of this are the rubbing off and breaking away of the more projecting and sharper corners of the floes. Just as sharp rocks and stones are rounded into small boulders and rounded pebbles by surf action rubbing them against each other, the movement of the floes and the collisions and rubbing one against the other give the individual floes an oval or rounded shape.

Another result of the movement and subsequent colliding is the thickening of the edges of the ice fields and the floes. In the collisions the sharp corners of the ice fields are partly broken-off and ground into small chunks and grated ice, partly driven down under the edges, and partly thrown up onto the edges of the colliding floes. In both cases the thickness of the edges of the floes is gradually increased. Similar processes, as we have seen, bring about the formation of small walls (raised rims) on the disks of pancake-type ice.

The pilots who made the flights between the Soloretzkie Islands and Archangel have informed me that during the flight of 10 April 1942, after a heavy three-day thaw, they saw for the first time during the winter, in the straits between Muksalma Island and Letnaya Zolotitsa River, ice floes of rounded shape with small walls (rims) of grated ice on the edges.

Somov noted three phenomena very typical of melting ice during the air reconnaissance of 21 May 1942 in the neck of the White Sea:

1. Almost complete absence of hummocks on the ice fields, although they were noted in previous reconnaissances. This observation of Somov, like other observations, confirms the fact that the hummocks are first to be destroyed in the spring season.

2. Decrease in area occupied by the ice fields and increase in number of small and large floes while the same percentage of ice is maintained, demonstrating the continual breaking of ice fields in the spring season.

3. Obvious predominance of four or five sizes of floes which has still not been explained. In this connection we may recall the surprising uniformity in shape and size of pancake-type ice.

If the ice is sufficiently open or scattered, particularly in the summer, along with the rounding of contours and thickening of edges after the breakup, it acquires a very characteristic shape due to the washing action of the waves. A hollow is formed along the water line in a complete girdle around the floe. Over this there is a comparatively small cornice which often breaks off and underneath it the subsurface ram (taran) juts out. Such rams on large ice blocks (nesiak) present a considerable danger for ships.

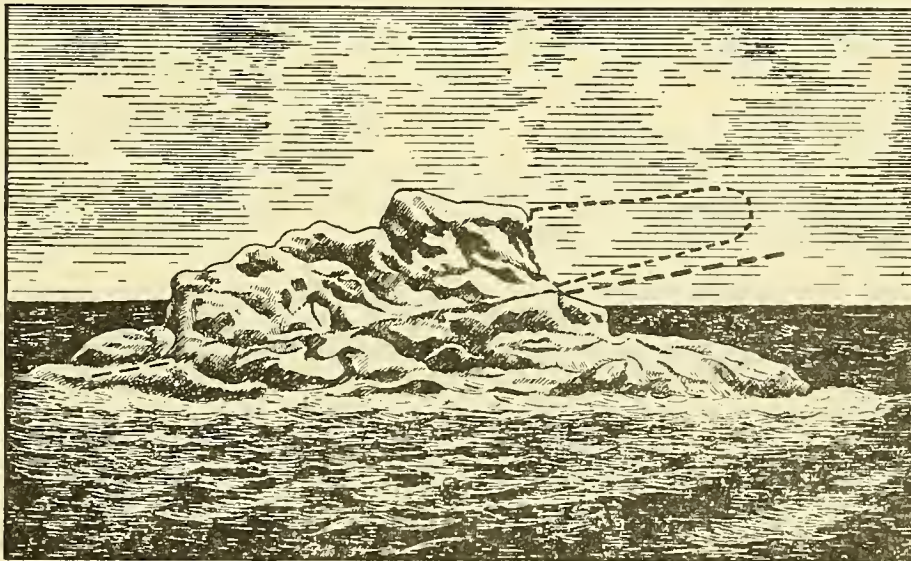

Figure 110. Destruction by waves of an ice block (nesiak) according to Burke.

Figure 110 shows the destruction of a separately floating ice block (nesiak) by waves according to Burke. When the cornice (shown on the figure by a dotted line) fell off, the original water line (also shown by dotted line) became inclined and a ram was formed on the ice block.

In regard to the break-up of fast ice, it is obvious that in spring and summer, when the fast ice has been weakened by the action of solar radiation and heat from the atmosphere, the breaking requires the application of less force than in the winter.

The break-up of fast ice in narrow straits, for example the straits of Matochkin Shar and Yugorski Shar, is extremely characteristic. The formation of ice here, like everywhere else, begins from the shores and gradually extends to the middle of the straits. The center part of the straits with its rapid current usually does not freeze for a long time, even with low air temperatures, since the ice particles which form on the surface of the open part of the straits are carried down under the ice already formed near the shores by the action of the turbulent currents, and they then adhere to the lower surface of this ice. As a result, in the spring the ice is thinnest and breaks up earliest in the central part of the straits. On the other hand, we have seen that melting also goes on comparatively rapidly by the shores. Thus, after the break-up, the ice cover of the straits naturally falls apart into two strips parallel to the straits' axis.

TABLE 87. CHANGE IN ICE THICKNESS AT KHABAROV (YUGORSKI SHAR) IN 1935

Date	Thickness of ice in cm		Temperature of air in °C		Temperature of water under the ice in °C
	Hole #1	Hole #2	Average	Maximum	
9 June	140	100	-0.4	0.1	-1.5
12 June	160	130	0.4	3.4	-0.7
14 June	160	100	0.3	1.5	0.1
17 June	160	78	0.6	5.6	0.2
20 June	148	63	7.2	11.5	0.4
23 June	132	45	1.4	5.0	0.4
25 June	123	33	2.2	3.3	0.5
27 June	100	20	3.5	7.1	0.4
28 June	Ice disintegrated		0.5	1.7	0.6

Table 87 shows the change in thickness of fast ice in the period of melting in Yugorski Shar at Khabarovo according to observations of Daniko in 1935.

From this table there is evident, firstly, the springtime accretion of ice at comparatively high air temperatures but low water temperatures, and secondly, the rapid decrease in ice thickness under the cumulate effect of water and air temperatures. Thus, in the space of 10 days, from 18 to 28 June, the thickness of ice in both holes decreased by 60 cm. In the entire 20 day period the thickness of the 140 cm ice decreased by 40 cm; the 100 cm by 80 cm.

LITERATURE: 23, 62, 77.

Section 115. Radiation and Thermal Effect of Air on the Ice

Let us suppose that a certain section of the sea is more or less equally covered with ice which is melting in place. During the melting both the vertical and horizontal dimensions of the floes will decrease.

Let us divide the melting of the ice into two processes, which we will analyze separately;

1. Melting of ice occurring exclusively from above on account of the heat of the atmosphere and solar radiation. This is typical of the large and massive ice fields in the central arctic and, to a certain degree, of fast ice before its breakup.

2. Melting of ice occurring from the sides and below exclusively on account of the warmth of the sea water adjacent to the ice which is particularly significant for floating ice composed of small ice fields and floes.

For analysis of the first case let us assume a level snow-free ice field and let us apply for our purpose the method employed by Kuzmin for calculation of melting of glaciers with certain alterations applicable for sea ice.

Let us image a right angle vertical parallelepiped with area of horizontal sections, s , and height, h . If the average temperature of the proposedly isolated volume of ice, during the period T , changes from t_1 to t_2 , then its heat contents from the same period changes by the value

$$c_i \delta_i h s (t_2 - t_1), \quad (1)$$

where c_i = specific heat of the ice,
 δ_i = density of the ice.

On the other hand, this change in heat content of the proposedly isolated volume of ice occurs through its upper and lower surfaces.

Thus the total heat balance is equal to

$$Q_s + Q_b + Q_i, \quad (2)$$

where Q_s = balance of heat flow through the upper surface, adjacent to air,
 Q_b = balance of heat flow through the lower surface, adjacent to sea water,
 Q_i = heat balance of processes going on in the given volume of ice.

Setting the terms (1) and (2) into an equation, we obtain:

$$Q_s + Q_b + Q_i = c_i \delta_i h s (t_2 - t_1). \quad (3)$$

Equation (3) is the equation of the heat balance of ice in a general form.

In order to simplify the further calculations, let us suppose, in the first place, that during the melting the average temperature of the ice chunk does not change.*

With such assumptions we obtain

$$Q_s + Q_i = 0. \quad (4)$$

The heat currents which penetrate through the upper surface of the ice stem from two sources: the radiation balance, Q_r , and the heat exchange between the ice and air, Q_a . Therefore the first member of the equation (4) can be represented in the form of the sum

$$Q_s = Q_r + Q_a, \quad (5)$$

where

$$Q_r = R + r(1 - A) - E, \quad (6)$$

$$Q_a = f[w(t_a - t_i)], \quad (7)$$

where R = direct radiation,
 r = diffused radiation,
 A = albedo (light reflecting factor),
 E = effective back radiation,
 w = wind speed,
 $t_a - t_i$ = difference in temperature of air and ice surface.

The second member of equation (4) is characterized by the processes of accumulation (precipitation and condensation) and the processes of ablation (melting and evaporation) which occur on the ice surface.

Evaporation and condensation are in actuality a single physical process. Let us designate the difference between them by the symbol D , prefixing the minus sign to this value when evaporation predominates and the body becomes cooler, and the plus sign when condensation predominates and the body becomes warmer.

If the melting is now considered for 1 square cm of surface and if the sum of the heat is expressed in small calories, we obtain

$$Q_i = dD - \lambda h \delta_i + z \Delta t, \quad (8)$$

*This assumption is actually not true, for although the temperature of the lower surface of the ice is always around the freezing point and the temperature of the upper surface remains around 0° during the melting period, the temperatures in the middle part of the ice remain for a long time below the freezing point of salt water. This explains the summer accretion of ice from beneath on account of heat conduction as we have already seen. Obviously, when we ignore the change of temperature within the ice, we also likewise ignore the influence of this change on the processes which occur at the lower surface of the ice.

where d = heat of evaporation,
 λ = heat of fusion,
 h = height of melted layer of ice,
 z = height in centimeters of layer of precipitation,
 Δt = difference in temperature of precipitation and temperature of ice surface, which is considered positive if the former is higher than the latter.

Substituting in equation (4), we obtain

$$Q_r + Q_a = dD + \lambda h \delta_i - z \Delta t, \quad (9)$$

or

$$h = \frac{Q_r + Q_a - dD + z \Delta t}{\lambda \delta_i}. \quad (10)$$

As we have already noted, since the quantity of precipitation in the arctic is small and the temperature of the precipitation is little different from the temperature of the sea surface, the effect of liquid precipitation falling on the surface of the ice consists not so much of a heating action as of a decrease in the albedo of the ice. As for the difference between evaporation and condensation, if it is considerable, then melting is lessened.

Kuzmin has shown that in the case of glaciers, on a warm, dry and sunny day when humidity is relatively low there is less melting than on a similar warm and sunny day with air condition close to saturation.

Ignoring precipitation, Kuzmin obtains from equation (10):

$$\frac{Q_r}{dD + \lambda h \delta_i} + \frac{Q_a}{dD + \lambda h \delta_i} = 1, \quad (11)$$

or

$$K_r + K_a = 1, \quad (12)$$

where K_r = coefficient of radiational influence,
 K_a = coefficient of thermal influence of air.

Kuzmin further shows that under the most favorable conditions of atmospheric transparency and with cloudless weather the layer of ice which is melted from radiational heat may amount to 4 to 5 cm a day on the southern glaciers of the USSR. If the coefficient of thermal influence of air is equal to .5, then the total daily melting may reach 8 to 10 cm. Judging from direct observations, this is a limiting value.

In cloudy weather the coefficient of thermal influence of air may very nearly approach unity.

We note that from equation (12) it follows that

$$\frac{K_a}{K_r} = \frac{Q_a}{Q_r}. \quad (13)$$

Concerning the value of this ratio, Kuzmin notes that two surface conditions of glaciers are well known. In the first case, when warm and cloudy weather has set in, melting occurs in such a way that the glacier surface becomes smooth and at the same time dirty, covered on top with

accumulations of dust particles and deposits of moraine matter. In the second case, with cold and clear weather all the dark deposits, warmed by the sun's rays, settle beneath and the glacier surface becomes snow-white and porous. On it appears ice globules, glassy ice surfaces, ice needles, etc. and thus there is formed a micro-relief on the surface of the glacier. Apparently this micro-relief is formed only under conditions when the coefficient of radiational influence is not less than twice as large as the coefficient way micro-relief is formed when the total heat of radiation energy falling on the glacier surface is at least twice as large as the positive heat-exchange with the air. The foregoing is also entirely applicable for sea ice.

While sailing near the northern coasts of Spitzbergen and Franz Joseph Land where the weather is continually cloudy in summer, the ice appeared dark and dirty.

This phenomenon explains the exceptional whiteness and sparkle of the ice fields in the early spring in the arctic under conditions of very low air temperatures and bright sunny weather.

The above considerations show what complexities are inherent in the process of thawing of ice from above. The matter is made still more complex by the fact that although there are instruments which permit of very accurate calculations of radiational balance for any point on the earth's surface, there are very few actual observations even at the polar stations and for ice far away from the coasts there are no observations at all. Conditions at the coastal stations are so different from those on the ice far removed from the shore that it is hardly possible to transpose the results of shore observations for the ice of the central parts of the basins without large corrections, which have not yet been determined.

Still more difficult is the problem of thermal influence of the air, conditioned by temperature and by the speed of wind. While we may deduce the wind speed from synoptic maps, this is considerably more difficult with respect to the temperature of the air.

LITERATURE: 77, 91, 93.

Section 116. Melting of Ice from the Top

The question of melting of ice from the top due to action of solar radiation and heat absorbed from the atmosphere is extremely complex from a theoretical point of view. No less difficult is the question of finding empirical formulas since we have at our disposal almost no observations of the melting of the ice. Therefore, until something else may be proposed, I consider it possible to use the following very approximate calculation.

Let f equal the quantity of heat actually absorbed by a unit of ice area in a unit of time, the quantity being made up of the radiational and thermal actions of the air on the ice. Let us suppose that all of this heat is used exclusively in reduction of the thickness of ice. It follows that for a unit of time dT , the heat absorbed by a unit of ice area will be equal to $f dT$. Due to this heat the thickness of ice should decrease by dh . From this we obtain the equation

$$f dT = \delta_i \lambda dh, \quad (1)$$

where δ_i = ice density,
 λ = heat of fusion.

In this formula the quantity of heat absorbed by the upper surface of ice is constantly changing and the fluctuations of this absorption are quite considerable.

It is known that the ice fields' ability to absorb heat increases with the passage of time as the ice fields become darker and are covered with snow puddles. The law of this increase is completely unknown to us. The absorption of heat from the air depends on the speed of wind, temperature and humidity of the air and also on other factors.

Let us make a rough assumption that the quantity of heat coming from above (as a result of radiation and heat exchange with the air) remains unchanged during the period of time under consideration and that the absorption ability of the ice increases proportionately with time, i. e., $f = bT$. Then we obtain from equation (1)

$$bTdT = \delta_i \lambda dh.$$

Integrating, we find that

$$\left. \begin{aligned} b \int_0^t TdT &= \delta_i \lambda \int_0^h dh, \\ \frac{b}{2} T^2 &= \delta_i \lambda h, \\ T^2 &= \frac{2 \delta_i \lambda h}{b}. \end{aligned} \right\} \quad (2)$$

In order to determine the coefficient, b , let us suppose, e. g., that in the given region the reduction of ice thickness due to melting continues from 21 May to 1 September; i. e., 100 days, and that the thickness of the ice fields decreases by 100 cm during this period.

Substituting in equation (2), $T = 100$ and $h = 100$, we obtain

$$b = \frac{2 \delta_i \lambda h}{T^2} = \frac{2 \delta \lambda}{100}. \quad (3)$$

Substituting equation (3) in equation (2), we obtain

$$T^2 = 100 h,$$

where T = time, expressed in days,
 h = melting, expressed in centimeters.

I have compiled table 88 according to this equation.

TABLE 88. APPROXIMATE REDUCTION OF ICE THICKNESS (DUE TO MELTING FROM ABOVE) IN CM, STARTING WITH 21 MAY

Date	May 21	June 1	June 11	June 21	July 1	July 11	July 21	Aug 1	Aug 11	Aug 21	Sept 1
Decrease in Ice Thickness	0	1	4	9	16	25	36	49	64	81	100

Similar tables may readily be compiled for any region, given the duration of the melting period and the thickness of melting ice, characteristic of the given region. Thus, for example, with $T = 40$ days and $h = 50$ cm, using equation (3) we obtain

$$b = \frac{2 \delta_i \lambda 50}{40^2}$$

and by equation (2),

$$T^2 = 32 h.$$

Observations show that in the seas of the Soviet Arctic the melting from above in August varies on the average from 1 to 3 cm per day. Piotrovich notes that in the Chuckchee Sea, at 70° north latitude and 182° east longitude, for the 24 hour period from 20 to 21 August 1935, approximately 3.5 cm of ice melted, the weather being completely clear and warm. Thus, the melting of ice from above is a slow but fundamental process for close ice, occurring at all times for ice of the central arctic and in the spring season for ice of the neighboring seas.

In the case of many-year-old ice this process is connected with an extremely typical vertical movement in the ice of all kinds of foreign matter. In many-year-old ice, which melts for the most part from above and which grows by freezing from below, all foreign matter which freezes to the lower surface of the ice in one way or another will finally appear on the upper surface. Many observers, including myself, have noted that the brown deposit on the ice consists of quartz. Many observers have been surprised to find comparatively large stones and even boulders on the surface of the ice far away from the shores, which can be explained by the phenomena described above.

LITERATURE: 68, 77, 115.

Section 117. Melting of Ice Due to Thermal Action of Water

While melting of close ice occurs for the most part from above (and from below if such ice is carried by the winds into warm waters), for open ice, on the other hand, great importance is attached to the melting due to heat accumulated from the water layers adjacent to the ice. This factor is greater the more open or scattered the ice is.

For simplicity of calculation in estimating the significance of this process I have made an extreme assumption; e. g. : in the melting process a reduction occurs only in the horizontal dimensions of individual ice floes equidistantly separated in the sea. This assumption is in part justified by the fact that the reflection from the water is very small, while that from snow and ice, on the other hand, is very great.

Let us suppose that the heat absorbed by the water is immediately and completely used in melting. This assumption more or less corresponds to reality with considerable percentages of ice, and is proven by the low water temperature near the ice during melting. This phenomenon is made possible by two processes: (a) the mixing or stirring of water caused by the wind and ebb and flood tides, and (b) the natural circulation which always results from the conjunction of water and ice of different temperature.

Let the heat absorbed by the water be equal to

$$mwdT,$$

where m = quantity of heat absorbed by a unit of water area in a unit of time,
 w = area of water surface between floes,
 T = time.

If this heat is expended entirely in melting, then, assuming that during melting a decrease occurs only in ice area and not in thickness, we obtain

$$mwdT = h\delta_i\lambda ds, \quad (1)$$

where h = ice thickness,
 δ_i = density of ice,
 λ = heat of fusion,
 ds = decrease in ice area.

If we denote $\frac{m}{h\delta_i\lambda} = a$, and bear in mind that the decrease in ice area, ds , is equal to the increase in area of open water, dw , we obtain

$$aw dT = dw,$$

$$\frac{dw}{w} = a dT.$$

Considering a as constant for a certain period of time and integrating, we obtain

$$\ln w = aT + C,$$

where C = an arbitrary value, determined by the condition that the initial moment the water area w_0

Thence it follows that

$$\ln w_t = \ln w_0 + aT.$$

Discarding the logarithms, we obtain

$$w_t = w_0 e^{aT}$$

or $w_t = w_0 e^{\frac{m}{h\delta_i\lambda} T}, \quad (2)$

where w_t = area of water at the instant T .

From the latter equation it follows that with a change of time in arithmetic progression, the area of water between the floes increases in geometrical progression.

The areas of water w_t and w_0 are most readily expressed in units of tenths of the entire area of the sea section under observation. Actually, if we consider the latter as being equal to 10, we obtain

$$\left. \begin{aligned} n_t &= 10 - w_t, \\ n_0 &= 10 - w_0, \end{aligned} \right\} \quad (3)$$

where n_t and n_o = quantity of ice in tenths.

We note further that by use of logarithms in equation (2) we obtain

$$\frac{\lg w_t - \lg w_o}{\lg e} \frac{\delta_i \lambda h}{m} = T. \quad (4)$$

From this equation it may be seen that, other conditions being equal, the time intervals in which percentage of ice of diverse thickness decreases equally are proportional to the thickness of ice and inversely proportional to the quantity of heat absorbed by the water.

TABLE 89. NUMBER OF DAYS NEEDED FOR REDUCTION IN PERCENTAGE OF ICE 100 CM THICK WITH HEAT ABSORBED BY WATER EQUAL TO 300 G/CAL/CM² PER DAY

$n_o \backslash n_t$	8	7	6	5	4	3	2	1	0
9	16	26	32	38	43	46	49	52	55
8	-	10	17	22	26	30	33	36	38
7	-	-	7	12	17	29	23	26	29
6	-	-	-	5	10	13	17	19	22
5	-	-	-	-	4	8	11	14	16
4	-	-	-	-	-	4	7	9	12
3	-	-	-	-	-	-	3	6	8
2	-	-	-	-	-	-	-	3	5
1	-	-	-	-	-	-	-	-	3

Table 89 is compiled from equations (2), (3) and (4) above with the assumptions that the ice thickness is equal to 100 cm, density is equal to 0.9 g per cubic cm, heat of fusion equals 80 g-cal per g, and quantity of heat absorbed by water and expended in melting equals 300 g-cal per square cm per day. From the table we find the number of days necessary for the initial ice percentage n_o to become the sought-for percentage n_t .

We may find the value for any thickness of ice by a simple multiplication of the figure from the table by the relation of the given ice thickness to that for which the table was compiled, i. e., ice thickness equal to 100 cm. Thus, for example, according to table 89, tenths ice 100 cm thick will become five-tenths ice in 22 days. Thence we obtain the fact that eight-tenths ice 200 cm thick will become five-tenths ice in 44 days.

In similar fashion we may find the figures for any quantity of heat absorbed by the water by simple multiplication of the figure from the table by the relation between 300 g-cal per square cm per day (the value for which the table was compiled) and the given quantity of heat. Thus, e. g., if we consider that only 150 g-cal per square cm per day is absorbed by the water, the table figure must be multiplied by 2.

In this manner we may readily obtain from table 89 the values for any quantity of heat absorbed by the water and for any thickness of ice.

TABLE 90. DECREASE IN THICKNESS AND PERCENTAGE OF ICE
COMPUTED FROM TABLES 88 AND 89

Date	May 21	June 21	July 10	July 22	July 30	Aug 5	Aug 11	Aug 15	Aug 19
Percentage	9	8	7	6	5	4	3	2	1
Thickness of Ice in cm	200	190	175	165	150	142	135	130	125

Table 90 shows the decrease in percentage and thickness of ice, computed by use of tables 88 and 89, reckoning the thickness of ice on 21 May as equal to 200 cm and concentration equal to nine-tenths.

By comparison of the aforementioned tables there may clearly be seen the importance for the melting of ice of the polynyas and tidal lanes whose water absorbs the heat and gives it up for melting of the ice. Thus, if there is nine-tenths ice 200 cm thick on 21 May with an average heat absorption by the water equal to 300 gram-calories per square centimeter per day, ignoring the melting of ice from above and below, the percentage will decrease to one-tenth by 1 September; i. e., in 100 days (as found from table 89). At the same time, if on 21 May we have ten-tenths ice, then by 1 September this ice will maintain its original concentration, and only its thickness will decrease (as found from table 88) from 200 cm to 100 cm.

It must be noted that table 88 is computed only for close, continuous ten-tenths ice. Table 89 presupposes that all the heat of solar radiation and of the atmosphere which is absorbed by the water is expended only in reducing the horizontal dimensions of the open ice. In actuality, with open ice the heat absorbed by water is used not only in reduction of horizontal dimensions but also in reduction of thickness of the ice. Thus, we have seen that even when the ice and water temperatures are the same, owing to the different values of vapor pressure over water and over ice, there cannot be an equilibrium in the atmosphere. A continuous evaporation will go on over the water, and over the ice a continuous condensation of vapor, with a corresponding transfer of heat of evaporation from water to ice.

This circumstance is not taken into consideration in the aforementioned equations and tables. The percentage of ice, entering into equation (3) as initial data, does not take into consideration the dimensions of floes. It naturally follows that nine-tenths brush ice melts away and is destroyed considerably faster than ice of the same percentage and thickness but consisting of large floes and fields, since with volume being the same, the area subject to action of radiation and heat from the atmosphere and water is considerably greater.

LITERATURE: 68, 77.

Section 118. Centers of Break-up and Melting

By approximate calculation, during the daylight season of the year at 70° north, the amount of direct and diffused solar radiation which reaches the sea surface is approximately 30 kg-cal per square cm (taking into consideration the cloudiness and transparency of the atmosphere). At 80° north the quantity of heat which reaches the sea surface is reduced to 20 kg-cal per square cm.

This quantity of heat (if it were all to be used in melting the ice) is sufficient at 70° north to melt away approximately 4 m of ice or to heat a layer of water 200 m thick 1.5°C. At 80° north it would melt away approximately 2.5 m of ice or would heat the same layer of water 1°C. To this there must be added the heat absorbed (by water and ice) from the air which is carried by the winds from the more southerly and warmer regions.

In order to emphasize more sharply the total significance of polynyas and water expanses free of ice for the heat conditions of the arctic, the following very approximate calculations are given.

We have seen that approximately 15×10^4 cubic km of warm Atlantic water pours into the Norwegian Sea annually. With the lowering of the temperature of this water by 1° approximately 15×10^{16} kg-cal of heat are set free.

Under the direct influence of this water, in the Norwegian, Greenland and Barents Seas about 2×10^6 square km area never freezes over. By the end of the polar summer this area increases to about 3.5×10^6 square km. If we assume that approximately 30 kg-cal per square cm reach the sea surface in the region of this water in a year and that approximately 24 kg-cal per square cm is absorbed by the water (taking the albedo as equal to 20 per cent), with an area of open water equal to 3.5×10^6 square km this amounts to approximately 84×10^{16} kg-cal in a year. In other words, even by extremely low calculations, the temperature of the whole mass of Atlantic water is raised by nearly 6° as a result of absorption of only the solar radiation. It is clear that if we take into account the heat absorbed by the polynyas and by the ice itself, and in addition the heat absorbed from the atmosphere, then the importance of the heat brought in by the Atlantic water still further decreases in comparison to the heat which accumulates during the summer in the Arctic Ocean itself.

It follows from the foregoing computation that the significance of the Spitzbergen and Norwegian currents, Siberian rivers and Pacific water (flowing into the Arctic Basin through the Bering Straits) lie not only in the fact that huge quantities of heat which have accumulated in the more southerly latitudes are carried into the Arctic Basin by these currents, but also in the fact that the open sea areas, free of ice, which are created by these currents at the beginning of spring, become excellent accumulators of heat.

Table 91 gives the temperature observations of the *Far Easterner* on 17 August 1932 in the Chuckchee Sea at 67° 36' north, 166° 27' east. Three days earlier the average temperature for the same depths at the warmest station in the Bering Straits was approximately 5°. This alone proves that the high temperatures at the aforementioned station are the result of local warming.

TABLE 91. WATER TEMPERATURES AT 67° 36' NORTH, 166° 27' EAST

Depth in meters	0	5	10	15	20	25	30	40	50
Temperature in degrees C.	9.9	9.9	8.7	5.5	4.5	4.6	4.8	4.7	4.8

Average temperature at this station to a depth of 40 m equals 6.3°.

The latter phenomenon becomes still more understandable if we recall that from the conditions of equilibrium of a water-ice system it follows that the mass of ice melted by the thermal action of the water is directly proportional to the mass of water which is involved in the process.

Still more striking are observations made by the *Perseus* on 5 September 1934 in Traurenberg Bay at 79° 58' north, 16° 48' east. See table 92.

TABLE 92. WATER TEMPERATURES AT 79° 58' NORTH, 16° 48' EAST,
5 SEPTEMBER 1934

Depth in meters	0	10	25	50	64
Temperature in degrees	4.9	5.1	5.0	4.2	4.2
Salinity in o/oo	32.7	33.9	34.0	34.5	34.5

This bay is isolated by underwater rapids from the waters of the Spitzbergen current which flows into the region to the north of Spitzbergen. The high temperature of its water is created locally as a result of absorption of solar radiation and heat from the air.

If we consider that the water temperature in this bay falls to the freezing point in winter, it then appears that during the summer season 40 kg-cal were absorbed here by each square cm of water surface. If we take into account the local conditions which make for little cloudiness and great transparency of the atmosphere in the summer season, this seems entirely possible.

On 19 August 1932 the *Rusanov* observed a surface temperature of 3.7° in the Shokalski Straits, and 5.3° in the Vilkitski Straits.

These examples show how considerable may be the warming of surface water in the ice regions of high latitudes under conditions of absence of ice. They force us to refer with particular care to the calculations concerning penetration of warm currents into the polar regions calculations based only on observation of surface temperatures. The high temperatures of the surface water in the majority of cases serves only to indicate an earlier clearing of ice from the sea.

Just as we can distinguish in every region of the sea certain areas in which ice formation begins earliest, we may also distinguish areas where the ice breaks up earliest and the sea is cleared of ice. From these areas as centers, other conditions being equal, opening and melting spreads out in a definite direction. The position of these centers of breakup and melting is determined by many physicogeographic factors.

Other conditions being equal, breakup begins earliest in the more southerly regions, near the shores, in regions of strong tidal currents, and particularly near the mouths of rivers. Melting of ice occurs quickest wherever, for one reason or another, there are large areas of clear water at the start of melting.

In the seas of the Soviet Arctic, on the average, the breakup of shore and fast ice occurs earliest in the southern Novozemelski Straits (in the latter third of June), and latest in the Vilkitski Straits (at the beginning of August). It is clear that after the breakup of the fast ice, the centers of breakup become also the centers of melting.

In the open parts of the arctic seas the conception of breaking up of sea ice is not applicable, since even in winter these areas are covered with broken-up floating ice floes.

From table 89 we have seen that with ice thickness equal to 100 cm and with absorption by water of 300 g-cal per square cm per day in 16 days nine-tenths ice will become eight-tenths ice, and five-tenths ice completely melts away.

In the explanation of table 89 it was shown that the time necessary for the transformation by melting of one ice percentage into another for any given ice thickness and any quantity of heat absorbed by the water could be obtained by multiplying the figures of the table by proper factors. From this it follows that under any conditions, provided they are the same in both cases, nine-tenths ice becomes eight-tenths ice in the same time interval as five-tenths ice melts away completely.

The aforementioned calculation once more confirms the importance of dispersion of ice for melting and in particular explains the ability of individual large floes to last throughout the polar summer.

It must be noted that it is considerably more difficult to thin out close ice than ice already opened and dispersed since the small and more movable ice formations are hindered in their movement by the larger ice formations which have greater inertia and are less movable. Therefore, ice floes of large area are not thinned out, but are as if broken into ice floes of smaller area but of similar degree of compactness. That is why, while navigating in the ice, one often meets separate strips and accumulations of close-ice alternating with more or less broad stretches of open water. This phenomenon is strengthened by the fact that each separate ice floe which appears in the midst of clear water in the summer time is extremely short-lived. Only large floebergs and icebergs are capable of existing, separately for a long time and can float for great distances, especially if their movement is connected with appropriate currents.

Thus we may consider that in the melting period we will meet for the most part either eight- to ten-tenths ice, or open water with scattered ice floes in the process of destruction, or in other words, one- to two-tenths ice. Only in the case of tidal phenomena and under conditions of complete lack of wind do we find ice of different compactness.

In this respect, the disposition of ice in the Kara Sea at the start of navigation in 1940 was extremely typical. In this case the pre-navigational air reconnaissance carried out in June established the presence of a strip of open ice stretching approximately from Dickson Island to Severnaya Zemlya. This strip subsequently became the basic region from which melting extended to the northwest. At the start of navigation the whole band became free of ice and thereby made navigation possible in the first navigational period. There is no doubt that this band of open-ice was formed as a result of breaking-up of ice fields by suitable winds.

Figure 112 shows the condition of ice in the southwestern part of the Kara Sea from 20 to 24 June 1943, according to observations of the icebreaker *Mikoyan* with additional data from simultaneous air reconnaissance. On the diagram there may clearly be seen the Novozemel'ski ice field of the Kara Sea which is beginning to be destroyed, the Yamalskaya and Ob-Yeniseikaya polynya and the strip of fast ice which still remains in the mouth of the Yeniseiskii Gulf, reaching from Oleni Island across Sibiryakova Island to Dickson Island. The same figure shows simultaneous observations of water temperature (denominator) and air temperature (numerator), made by the icebreaker *Mikoyan*. These observations merit particular attention. Actually, in a comparatively small stretch the water temperature varied within very wide limits--from 0.4° to 10.6° . During this time a southeast air current prevailed over the region under observation and consequently a more or less uniform air mass was drawn over the sea. Nevertheless, the air temperature over the sea also varied, in a small expanse, within very wide limits--from 0.7° to 10.6° . Most remarkable was the fact that despite the great differences in temperature of water and air in adjacent points of the area, the difference between the temperatures of water and air at one and the same point in the sea stayed within the limits of 2° with the exception of the region in direct proximity to Dickson

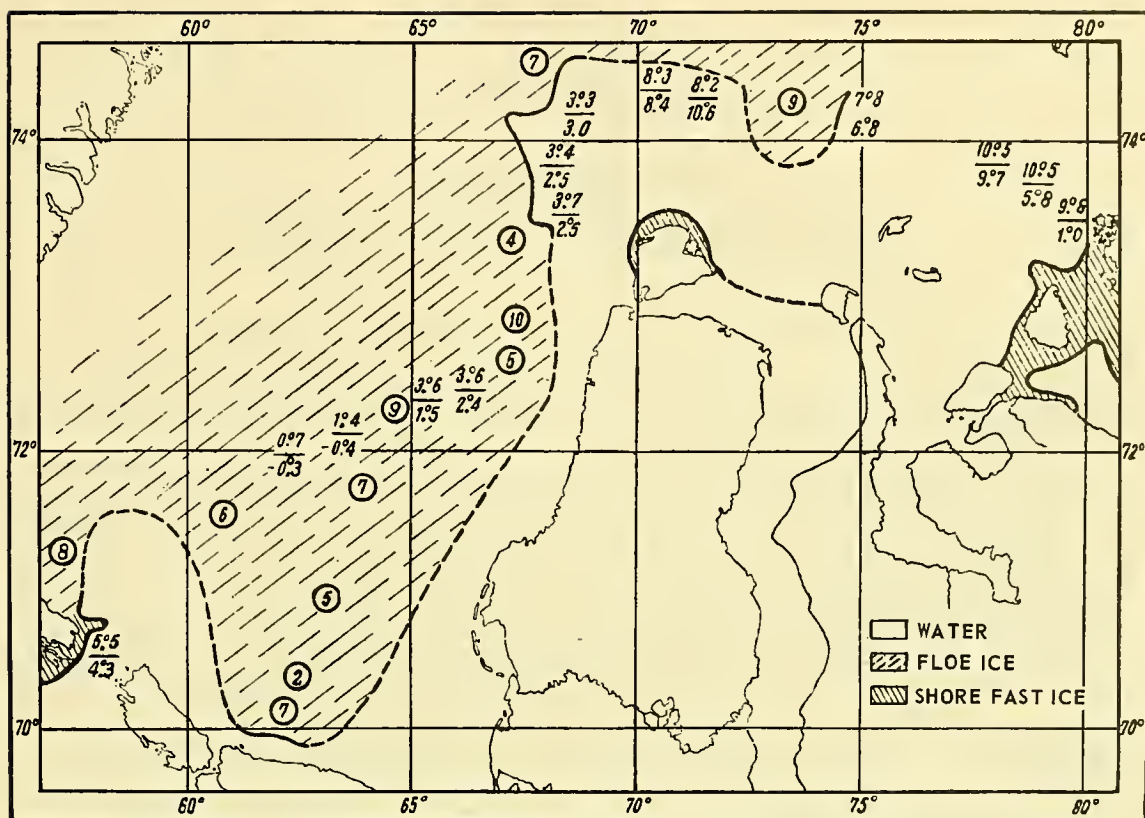

Figure 112. Condition of ice, temperature of air (numerator), and temperature of water (denominator) in the southwestern part of Kara Sea, 20 to 24 June 1943.

Island. In other words, the air temperature very closely followed the temperature of the underlying water surface.

Also worthy of attention are the very high water temperatures, up to 10.6°. Taking into consideration the early season of the year, and also the existence of an ice dam in the mouth of the Yeniseiskii Gulf, we must assume that such high temperatures are only partly due to the heat of the coastal current but are mainly created locally by the combined influence of solar radiation and advective heat of the atmosphere. It is clear that if such warm water is subsequently blown by the wind onto ice, there will then result a stronger washing-away of projecting edges of ice. If the wind starts to drive the ice into such warm water the small floes will completely disappear and the large floes be considerably destroyed. As has already been remarked, this accounts for the influence of polynyas and open water on the melting of ice.

LITERATURE: 62, 77, 82.

CHAPTER IX

TIDAL PHENOMENA AND ICE

Section 119. Certain Peculiarities of the Tides

Tidal phenomena are expressed in periodic variable movements of water particles in a vertical direction (variation in water level) and in a horizontal direction (ebb and flow currents).

As observations have shown, the tidal force of the moon and sun create tidal phenomena even in small and restricted sea basins, but basically these phenomena are generated in the belt of the World Ocean embracing the globe around the high parallels of the southern hemisphere. Here the tidal wave, continually stimulated and running from east to west, passes the southern ends of America, Australia and Africa. After rounding these extremities it spreads out to the north as a free wave. The tidal wave enters the Atlantic Ocean and here spreads out along the continental slope of Eurasia right to the North American archipelago. On its way this wave sends out branches into the individual surrounding seas.

The spreading of the ocean tidal wave into shallow seas discloses some curious peculiarities:

1. The tide-forming force of the moon and sun acts upon water particles practically independent of their depth below the ocean's surface. Therefore the entire water mass of the World Ocean takes part in the tidal phenomena. Since the tidal wave, as it spreads out, must pass sometimes over greater and sometimes over lesser depths, it develops that wherever the depth decreases from greater to smaller, the energy of the larger water masses is transferred to the smaller masses and the amplitude of the tide is correspondingly increased. Contrarily, with transfer from lesser to greater depth the amplitude is decreased.

The depth of the ocean changes most sharply on the continental slope. Here the tidal wave passes, in a short space, from the ocean depths to the lesser depths of the continental shallows. Obviously the amplitude of the tide is thereby sharply increased and the speed of the tidal current is proportionately increased. The same occurs with the further progress of the tidal wave along the continental shallows. This is diagrammatically illustrated in figure 113. It is natural that the larger amplitudes which are created at the borders of the ledges are slightly decreased in the subsequent level deep places.

2. The increase in amplitude of tide upon approaching the shores is attributable not only to the decrease in depth but also the decrease in width of the gulfs. Still another contributing factor is the interference created as a result of the reflection of the tidal wave from the shores and its addition to the waves arriving from other regions.

The explanation of high tides by local conditions, i. e., the configuration of the bottom and the shores, is well demonstrated by the example of the Bay of Fundy, where the width and depth decrease gradually. Correspondingly, the amplitude of the tide, which is equal to 4 m at the entrance to the bay, gradually increases to 16 m as it progresses into the body of the bay.

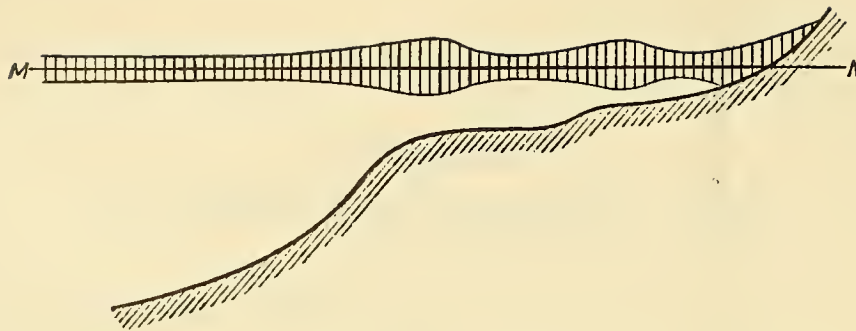

Figure 113. Diagram of changes in amplitude of the tide upon progressing into shallow water. Comparative value of amplitude is shown by the vertically hatched strip.

3. Every horizontal movement on the earth is deflected to the right in the northern hemisphere and to the left in the southern due to the force of the earth's rotation. This is also felt in the tidal phenomena. Thus, due to this influence of the earth's rotation, everywhere in the northern hemisphere the tidal amplitude is considerably greater on the right hand shores (with relation to the spreading of the tidal wave) than on the left hand shores.

Figure 114 shows the amplitudes of the spring tides along the shores of the White, Barents and Kara Seas, which confirm this phenomenon.

Depending on local conditions, the tidal variations of the water level and the current may be extremely diverse. Nevertheless, three basic groups of tidal phenomena may be noted: along the shore, in narrow straits, and in the open sea.

Along the shore the extreme levels usually coincide with the change of the tidal currents. The variations of level are of the greatest practical interest here.

In narrow straits the extreme levels coincide approximately with the maximum speeds of the tidal currents. The change of tidal currents occurs approximately at mean tide level. The horizontal orbits represent very nearly straight lines extending approximately along the axis of the straits. It is as if the water masses are carried back and forth along the axis of the strait.

In the open sea the variations of level have almost no significance. The horizontal orbits are nearly circular and the water particles, due to the deflecting force of the earth's rotation in the northern hemisphere, move in a clockwise direction. In regard to this my observations in the open part of the Barents Sea provide a typical example.

Figure 115 shows the horizontal orbits of water particles during the period of the tidal current at depths of 0, 25, and 50 m all in the same scale. These were obtained by simultaneous observations on 5-6 July 1928 at $73^{\circ} 16.6'$ north $38^{\circ} 24.5'$ east to depths of 260 m. In all cases the permanent current is excluded. In examining the drawings, attention is directed to the following:

1. The horizontal orbits of the particles are almost circular.

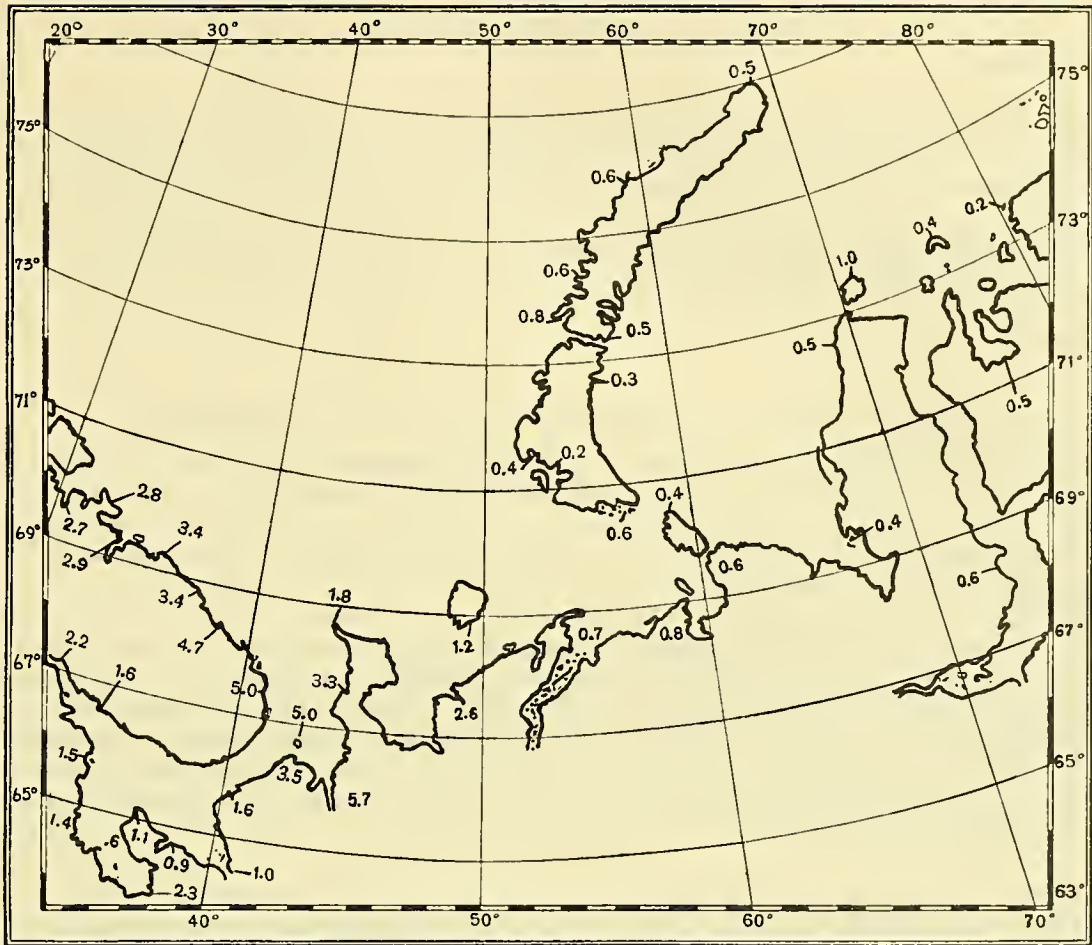

Figure 114. Amplitudes of spring tides in the White, Barents, and Kara Seas.

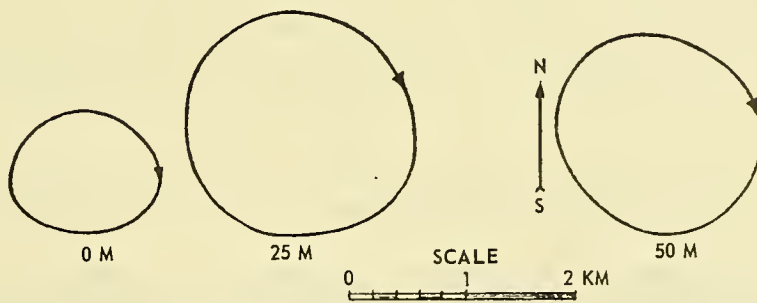

Figure 115. Horizontal tidal orbits in the Barents Sea far from shore.

2. In the surface layers the direction of the tidal currents is clockwise. (This also occurred at 100 m. Only at the very bottom, at a depth of 250 m, did the current shift in a counterclockwise direction).

3. The orbits of the particles increased rather than decreased with depth. The greatest speeds of the tidal current were observed at a depth of 25 m. These phenomena are explained firstly by the fact that the water is not able to attain a position of equilibrium and secondly by the inertia of the water masses. Thus, in the open sea and in the central parts of wide straits there is not found what is commonly referred to along the shores as "change of currents" or "slack water." Here the tidal currents never cease.

LITERATURE: 50, 51, 53, 54.

Section 120. Influence of Ice on Tidal Phenomena

In the case of a sea surface free of ice, the energy of tidal waves is expended in the end on destruction of the bottom and the shores and on heating of the sea. In a sea which is covered with ice this energy is expended, in addition, on all sorts of deformations of the ice cover--hummock formation, fracture, etc. It follows, therefore, that with the presence of ice all elements of the tidal phenomena are significantly changed.

In a sea free of ice the speed of tidal currents decreases with depth approximately parabolically. If the sea is covered with fast ice the tidal current is similar to the flow of a liquid between two plates; i.e., the graph of the distribution of speeds will also be approximately parabolic, but with its horizontal axis situated at the middle of the depth of the sea (if we consider friction with the ice and with the bottom as equal and the fluid as homogeneous). From the above, it follows that the average speed of the tidal current under the ice will be considerably less than the speed of the tidal current in a sea free of ice.

But the decrease in speed of tidal currents results in a proportional decrease in amplitude of the tide. The amplitude is also decreased in turn by the presence of the ice cover for creating the appropriate variations of level there is required a periodic bending of the ice cover first in one direction, then in the other, and part of the tidal energy is expended in this.

The investigations conducted by port discovery parties in the White Sea serve as a typical example in this respect (table 93).

TABLE 93. AMPLITUDES OF THE TIDE (IN METERS) IN THE KAMENAK AND PYA RIVERS

Date	14 June 1928	14 July 1928	6 February 1929
Pya	5.50	5.68	4.70
Kamenka	3.54	3.56	0.68
Ratio	1.55	1.60	6.91

In February at Mezenski Bay at the mouth of the Pya River there was loose ice, while at the mouth of the Kamenka fast ice. If we accept the fact that the ratio between the amplitudes in these two points should always be about 1.6, then in February the amplitudes of tide at Kamenka should have been about 3 m, while only 0.68 m was observed.

TABLE 94. AVERAGE AMPLITUDES OF THE TIDE (IN METERS) AT SOLOMBALA ON THE SEVERNAYA DVINA FOR 1917 TO 1929

Winter						Summer					
Nov.	Dec.	Jan.	Feb.	Mar.	Apr.	May	June	July	Aug.	Sept.	Oct.
0.53	0.51	0.45	0.37	0.42	0.37	0.31	0.56	0.70	0.68	0.72	0.64

Table 94 shows the monthly average amplitudes of the tide on the Severnaya Dvina, according to observations made from 1917 to 1929. From the table it may be seen that in the summer the amplitudes of the tide is almost twice as large as in the winter.

As a supplement, to the above table, the following should be noted:

In 1942 on the Severnaya Dvina at Solombala the normal tide continued until 10 May along with the *manikha** typical of this river. By that time the irregularity had already begun resulting in the level at Solombala reaching 200 cm (reckoning from the zero of 1881).

The amplitude of tide was at winter level, and varied from 25 to 45 cm. On 11 May the anomaly reached its peak (326 cm) and the river opened up at Archangel. On 14 May the level fell to 200 cm and the regular tide occurred again, once more with the characteristic *manikha*. On 16 May the Severnaya Dvina was finally cleared of ice but the amplitude continued to remain at its winter level. Such a situation continues, as a rule, right up to the complete clearing of ice from the neck of the White Sea. Actually, the tides on the Severnaya Dvina are only the result of the tidal wave passing through the neck of the White Sea from the Barents Sea. It follows that as long this wave is weakened by the ice in the neck of the sea the tide amplitude in the whole of the White Sea will remain small. This explains the comparatively small average amplitude of tide in May when the basin and Dvinski Bay are often completely free of ice while the neck of the White Sea is still not yet clear.

It is clear that the less ice present, the less noticeable are these phenomena. A part of the tidal energy is expended on moving and bending the ice and thus the tidal amplitude is correspondingly decreased. It is obvious also that sparse brash ice, which very strongly extinguishes the energy of wind waves, cannot have much effect on the energy of the very long tidal wave.

In addition to decreasing tidal amplitude and speed of tidal currents, the ice cover also has an effect on other elements of the tide. For example, according to the observations of Lyakhmitski, in the mouth of the Severnaya Dvina in 1915 and 1916 the difference in time of the tide between Solombala and Lapominskaya Gavan, which is equal to 1.5 hours in summer, increases to 3.5 hours in winter. It is calculated that the times of high and low tide in the period with complete ice coverage are approximately one hour later than the times of high and low tide in the summer season.

Table 95 shows the phase angles (according to Maksimov) of the main semidiurnal waves for certain points of the Soviet Arctic. From the table it is evident that with the presence of ice, the phases of the tidal waves are later in comparison with phases of the same waves in absence of ice.

*The phenomenon of *manikha* consists of the following: in the course of a rising tide the level stops rising or even declines for a certain time and then the increase in level continues again until fall tide.

TABLE 95. PHASE ANGLES OF THE PRINCIPLE SEMI-DIURNAL TIDES

Region	Russkaya Gavan		Mys Zhelaniya		Mys Chelyuskin	
	M ₂	S ₂	M ₂	S ₂	M ₂	S ₂
Clear of Ice	275°	331°	318°	354°	331°	20°
Ice Present	299°	346°	321°	9°	346°	28°

Thus, a preliminary computation of all elements of the tide requires a separate determination of the harmonic constants for a sea free of ice as well as for a sea covered with ice.

LITERATURE: 54, 77, 102.

Section 121. Influence of Tides on Freezing and Break-up of Sea

The tides are distinguished from the permanent currents by their periodicity in respect to speed and direction and by their great velocity gradients and the resulting extreme turbulence. The latter, in certain regions such as narrow straits, results in a complete mixing of the sea waters from the surface to the bottom which makes the tidal currents similar to river currents.

But we have seen that the larger the vertical gradients of density in the surface layers, the faster surface ice begins to form. From this it follows that the tides, by mixing the water masses, as a rule retard the start of ice formation. However, the tides subsequently continue to break up the ice cover and thereby an intensified ice formation goes on in the open expanses of clear water. Due to this the total quantity of ice is greater by comparison with the quantity of ice which would form in the given region in the absence of tides.

Great variations of tidal level are observed in Mezenski Bay of the White Sea and especially in the mouth of the Mezen River. For example, in the mouth of the Semzha River, a tributary of the Mezen, the greatest amplitude of tide is 11.7 m and the smallest is 2.9 m. Due to this, ice never forms on the Mezen below Mys Tolstik. With every flood tide the ice breaks up and hummocks toward the mouth of the river; with every ebb tide the ice is carried into the sea where it piles up on the coastal banks and shoals.

Fast ice does not form around Morzhovets Island due to the tidal current entering Mozenski Bay and rounding this island to the south and north. Branches of the current, meeting along the eastern side of the island, create there a strong tide rip in the summer and considerable hummocking and formation of stamukhi in the winter. In the straits of Matochkin Shar near Mys Uzki, where the depth is 25 to 20 m and the speed of tidal current reaches 5 knots, a polynya situated in the middle of the straits is quite typical. The polynya even lasts through the winter in particularly warm years. In normal winters it closes over with ice and opens up again in the spring.

Thus, in the period of ice formation the tides

1. Retard formation of initial ice forms until the whole water layer which is mixed together by the tides is cooled to the freezing point.
2. Hinder formation of fast ice and large ice fields.

3. Increase the quantity of deep ice and bottom ice.

4. Increase the total quantity of ice in the given region by comparison with the quantity of ice which might form in the same region under the same meteorological conditions but in the absence of tides. In the melting period strong tides, as a rule, assist in the destruction of the ice. In relation to this, not only are the variations in level a contributing factor, assisting in the break-up of fast ice, but also the gyrations of the ice which come about as a result of the tidal currents which have diverse directions even in comparatively nearby regions. The ice is thus crumbled into smaller and smaller parts as a result of which the total ice area subject to the action of radiation from the warm air and water is increased. In addition, the areas of clear water which are continually opening up due to the tidal disruptive pressures strongly absorb the solar radiation. This heat, stored up by the water, is subsequently expended in melting of the ice.

LITERATURE: 62, 77.

Section 122. Tidal Cracks (Treshchiny)

Tidal variations in sea level in the winter season make themselves felt in the freezing of the littoral shallow water right to the bottom and in formation of tidal cracks in the fast ice.

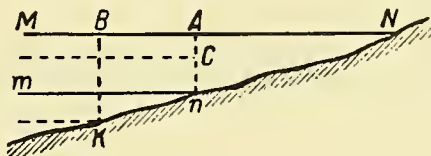

Figure 116. Diagram showing formation of tidal cracks in fast ice.

Let us suppose (figure 116) that MN is the level of high tide and mn the level of low tide and that a layer of ice of a certain thickness is formed at high tide (with sufficiently cold temperature). With the falling of the water level, the ice cover will also begin to drop, but at the very shore line there will remain a layer of ice broken off from the main ice mass. Irregular ice formations will thus become lodged along the whole slope of the shore, as the level drops down. This slope remains uncovered during low tide and the ice formations frozen to it become larger due to the water flowing along the slope. With the next rising of the water, new ice is added to the ice pieces frozen to the ground and in this manner the whole area ANn gradually becomes frozen through to the bottom.

Obviously, as long as the ice remains thin it will bend due to its plasticity, but as it becomes thicker and its strength increases, it will crack up with the crack parallel to the shore line. At full development this crack will trace an isobath equal to the amplitude of the tide in the given region of the sea. On this account, in case of great amplitude of tide, huge expanses of the shallow bank may be piled up with ice to the very bottom.

Between the isobaths n and k , the difference in depth of which is equal to the thickness of ice, the ice will partly lodge on the bottom during ebb tide and partly break off.

Thus, we will find in the coastal tidal belt: (a) a coastal strip of ice always lying on the ground, (b) a strip of ice closer to the sea lying on the bottom only during ebb tide, and finally (c) the basic ice mass of thickness AC , which is on the surface. These strips are separated from each

other by cracks which are called, with relation to the shore, interior and exterior tidal cracks (figure 116).

The steeper the angle of slope and the less the amplitude of the tide, the closer together will be the exterior and interior cracks. The more gradual the slope of the shore and the greater the amplitude of tide and thickness of ice, the further apart will be the tidal cracks and the more clearly defined.

Ice formation in the sea never occurs with identical intensity. This is explained in part by the changes in meteorological conditions but mainly by ocean conditions. Therefore, freezing goes forward by leaps or stages and each stage is characterized by a crack. According to observations of the *Zarya*, on a sloping shore stretching out over a great distance, the number of tidal cracks was sometimes as high as seven. Only two of these, those nearest the sea, were active (i.e., variations of level were noticeable in them). The other five had been active in the past but with the thickening of the ice they remained in the coastal strip of sea frozen through to the bottom. Usually the plane of the tidal cracks is vertical. Sometimes it inclines towards the shore and in very rare instances towards the sea.

The distance of the tidal cracks from the shore depends on the slope of the beach and the amplitude of the tide. In Kozhevnikov Bay (Khatangski Gulf) the tidal cracks are formed up to 1 to 1.5 m from the shore.

In shallow water the tidal cracks follow very closely the outlines of the coastline. This fact is sometimes used in winter surveys of routes at shallow coasts where it is impossible to identify the coastline otherwise.

In the case of spring tides and strong driving winds, the ice on the surface may be higher than the ice frozen to the bottom. Then the sea water rises above the latter and forms the so-called winter water-lanes along the coast (*Zabreg*). This water, mixing with the snow which covers the coastal ice and then freezing, forms (on the surface of the sea ice) snow ice which is distinguished by its dull white color. When the surface ice is driven off the shore it may actually be lower than the ice frozen to the bottom.

Analogous tidal cracks are formed around islands and ice formations which are lying on shoals. Usually in such cases there are several radial cracks present within the circular tidal crack. Similar circular and radial cracks are observed near individual shoals where the depth is less than the amplitude of the tide plus the greatest thickness of the ice cover. Over such shoals at the start of ice formation the ice cover at ebb tide has a slanting dome-shaped swelling. With subsequent growth and strengthening of the ice cover the circular crack, which encompasses the ends of the radial cracks, usually has its larger opening facing down, while the radial cracks, on the other hand, have the larger opening facing up.

With increase in amount of ice cover, the slope of the slabs which form a swelling over the sub-surface rock continually increases and in certain cases reaches 45° . The inclined slabs freeze together with the sea water which falls into the cracks between them. Thus a very stable formation is created rising to one or two m over the surface of the smooth ice with diameter up to 7 m and similar to a crater in form (figure 117). Such crater-shaped heapings of ice ("ice tents") are especially characteristic of rocky shores where the littoral zone contains many sub-surface stones. Analogous phenomena were observed by the Toll expedition along the low and declivitous shores of Zemlya Bunge over the shafts of sludge ice which had become soaked from long immersion in the water and were therefore heavy and prone to sink.

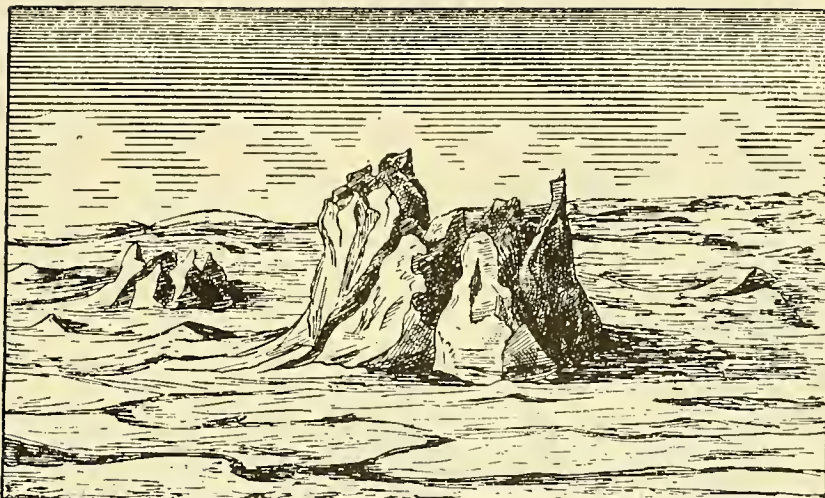

Figure 117. Crater-shaped hummocks of ice over shoals.

Fluctuations in sea level during winter are caused not only by tides but also by wind driving water towards and away from the shore. So, besides tidal cracks, wind-driven cracks are characteristic of the ice cover. The latter are particularly well developed and most typical when the bays are already covered with a rather firm ice cover and the adjacent sea is still free of ice. With a strong wind blowing towards shore the water covers the fast ice. When the wind blows off-shore, due to the lowering of the level, cracks are formed in the ice. These are typical in that they intersect perpendicularly entries into the gulfs, separate the gulf from its shallower bays, and stretch from one island to another across the straits. Such cracks appear in any month of the winter.

In most cases, however, the wind-driven cracks coincide with the tidal cracks. This may be readily followed, for example, on the Severnaya Dvina where the wind-driving effect considerably exceeds the tides. For example, in the winter of 1941-42 after the fast ice cover had formed, the amplitude of tidal fluctuations in level did not exceed 60 cm even in spring tides. The amplitude of wind-driven fluctuations of level, however, reached 101 cm in November, 79 cm in December, 62 cm in January, 76 cm in February, 76 cm in March, and 69 cm in April. As one can see, the wind-driven fluctuations of level on the Severnaya Dvina did not cease throughout the winter despite the fact that the entire sea was solidly covered with ice.

The fast ice cover was formed on the Severnaya Dvina on 3 November 1941 and the river ice broke up on 11 May 1942. During this time the maximum level (tidal plus wind-driving effects on shore) was observed on 30 November and was equal to 210 cm while the minimum level was observed on 8 February and was equal to -2 cm (relative to the "zero of 1881"). Thus, the absolute amplitude of variation in the ice period was 212 cm which made for sharply defined cracks, winter water-lanes along the coast, freezing of the ice to the shore and to mooring lines, etc.

Figure 118 shows, according to Voeikov and Stolyarov, the location of tidal cracks in Tiksi Bay in the winter of 1933-34. These cracks ran between all the prominent parts of the shore and along the coastline and remained open all through the winter. With severe freezing young ice was often pressed out of them forming ridges from 10 to 15 cm high and 2 to 2.5 cm thick. Due to the lack of connection with the shore, the ice in the central part of the bay remained afloat.

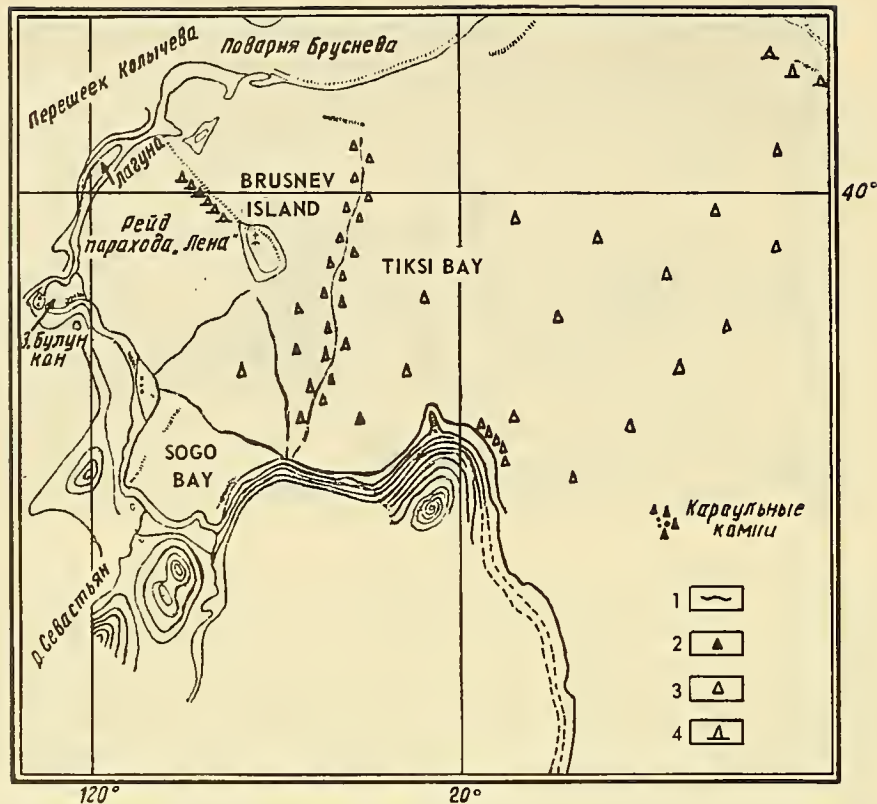

Figure 118. Tidal cracks in Tiksi Bay -- winter of 1933-1934.

Figure 119 shows the ice profile made in Archangel on 8 December 1941 from the pier of the port of *Ekonomiya* to the shallows. Typical in the figure are the increase in ice thickness alongside the pier and swelling of ice over the shallows. These elements, as we have seen, are completely explained by tidal and other variations of level and must be taken into consideration in practice.

In cases when ships must pass enforced or intentional winterings along natural shores or quays in harbors where strong tides occur, the ship should first of all be placed for the winter in such a way that it will in no case freeze into an ice zone where tidal or wind-driving cracks appear but will remain completely in ice which is always afloat.

During the wintering the hull of the vessel, particularly an iron hull, due to the great heat-conductivity of iron will always have its sub-surface part frozen over and frozen to the surrounding ice. If the vessel freezes into the ice in such a manner that a part of its hull is in fast ice and the other part in floating ice, the unavoidable stresses may injure the hull. There have been cases where ships passing the winter alongside harbor piers in Archangel have ignored these factors and in the spring tides have listed up to 25°.

Tidal cracks are important also in construction of all types of roads and crossings on the ice. A particular type of construction is required which will assure a smooth descent and ascent from the shore and return. This is particularly important in laying of railroad lines. In fact, the sharp

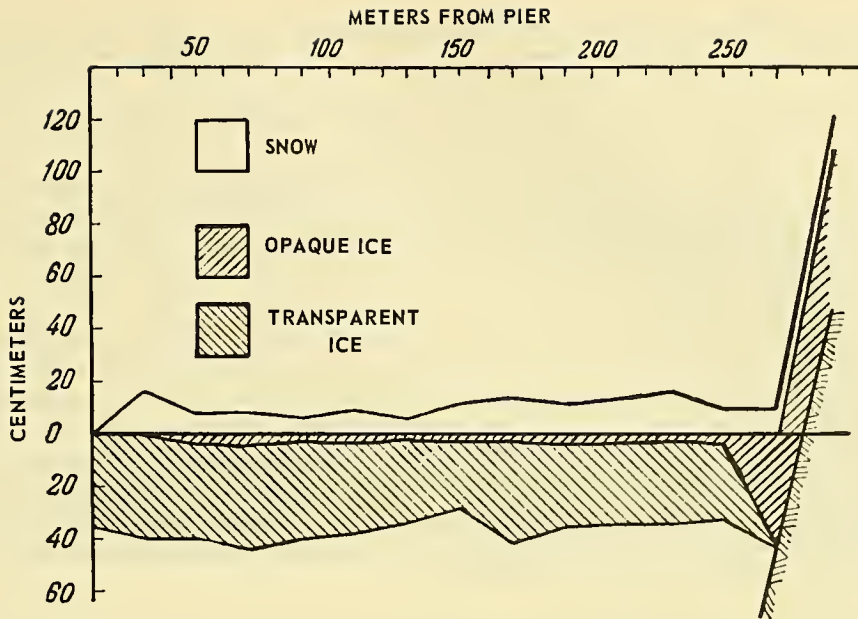

Figure 119. Ice profile on the Kuznechika River from the pier of Ekonomia to the shoals.

breaks unavoidably created by the great vertical fluctuations of floating ice cannot be permitted for railroad lines. Therefore, the smoothness of the part of the road which traverses the ice must be constantly regulated by laying down or removing special packings.

Finally, tidal fluctuations of ice are extremely harmful for piles which are driven into the bottom and which freeze to the floating ice. Each lowering of the level usually causes only a slight bending of the ice by the pile. With every rise of the level, the floating ice tries to pull the pile from the bottom.

LITERATURE: 36, 62, 77, 87.

Section 123. Tidal Variations in Level and Stamukhi

As we have seen, stamukhi are ice formations of comparatively large vertical dimensions which are moved through the seas by winds and currents and finally become fast on shoals and sub-surface banks.

Let us suppose that a huge ice block has become fast on a certain shoal at low tide. It is clear that as soon as the flood tide begins, the stamukha will be torn away from the shoal and carried by the flood tide to a slightly lesser depth where the start of ebb tide will leave it. Subsequently the stamukha will continue to be torn from a shoal at flood tide and left in a more shoal spot at ebb tide, gradually approaching a depth where it will remain on the shoal even at high tide. Obviously, if the stamukha begins its stepwise approach to the shore at neap tides, then at the spring tides it will again be pulled from the shoal and move still closer to the shore. The same

may occur in the case of wind-driven changes of level. As a result, the stamukha will attain a stable position only at the highest water level of the given region, whether tidal or wind-driven.

Along a shallow shore where, in addition, the tidal and wind-driven variations of level are sharply defined, the stamukha may travel considerable distances before it finally stops. It is natural also that as a result of this travelling, the ratio of sub-surface depth to height above water, which for ice blocks is about 5, may for the stamukha become equal to 2 or even 1. The tidal movements of stamukhi are particularly noticeable in Mezenski Gulf where the flood tides are great and where the spring tide amplitudes are several times greater than those of the neap tides.

In high latitudes the stamukhi are massive formations and many of them survive the short polar summer. While the tides assist in increasing the size and solidity of the stamukhi in winter, in the summer they assist in destroying them. First of all they strongly alter their shape. Actually, in the course of time the fluctuations of level and accompanying tidal currents wash away a hollow at the height of the variations of level. This hollow girdles the stamukha on all sides at a height somewhat greater than the amplitude of the tide and is bordered from above by a sharply traced cornice and from below by a rounded base washed by the water. The hollow which encircles the stamukha gradually penetrates deeper and deeper into the ice and the stamukha acquires its characteristic mushroom shape with fanciful outlines.

If the stamukha sits near a shore which is open to wave movement the action of the tidal fluctuations in level is considerably strengthened but the cornice is quickly destroyed by the shock of the waves and the cap of the mushroom becomes considerably smaller than its base. In places shut off from wave movement the cap of the mushroom keeps its dimensions for a long time and the cornice crumbles away only due to its own weight.

Stamukhi, as we have seen, consist of extremely heterogenous ice floes cemented together by freezing of thaw water mixed with snow. Therefore, their individual parts represent formations of diverse durability and present different resistance to the washing action of the water. In this connection, the stamukhi are washed by the water in many different ways. The upper cap may rest on one or several pillars so that transverse grottoes and bridges are formed in the stamukha. These shapes are especially diverse when the stamukhi are located in places closed off from wave movement where the upper cap can be retained longest.

LITERATURE: 62, 77. .

Section 124. Tidal Movements of Sea Ice

Due to the influence of the tide, floating ice is in constant movement and it traces ingenious patterns. Individual fields and ice floes sometimes collide, press together and hummock up, sometimes drift apart and become sparse. The greater the tidal amplitude in the given region the more sharply are these movements defined. With spring tides they are greater than with neap tides, and in calm or weak wind conditions they are clearer than in strong winds.

During the drift of the icebreaker *Lenin* in the southwestern part of the Laptev Sea in the winter of 1937-38 some interesting observations of tidal movements of ice were made. The shallow depth of the drift region (about 45 m) permitted the use of an extremely simple, but at the same time accurate, method of determination of elements of drift, namely, by the length of a paid-out line.

There were 2,022 such determinations made. Hourly wind observations, 137 observations of pressure of ice, 6 daily, 12 twice-daily and 30 serial oceanographic observations, as well as numerous instrumental observations of current, enabled them to throw light on the dynamics of the drift of ice with great thoroughness.

Storozhev notes that all the observations of the icebreaker *Lenin* show that the drift of ice due to tidal currents in the Laptev Sea is 4 to 6 hours later and its speed smaller than the tidal currents. As a result of such great retardation compared with the semi-diurnal tidal current which occurs in the Laptev Sea, an almost opposite current is observed at a slight depth in the sea. In the case of weak ice drift and strong tidal currents, the top surface of the layer of opposite currents rose almost to the surface of the sea; with strong drift and weak currents it descended deeper.

In the course of a day the ice, as well as the tidal currents, described closed curves, counterclockwise near the mouth of Khatangski Gulf and clockwise in the central part of the sea, far from the distorting effect of the shores. The speed of the tidal drift of ice reached 1.3 knots along the shores. The speed of the tidal drift of ice reached 1.3 knots along the shores and only 0.7 knots in the open part of the sea. The effect of tides on the drift of ice was especially sharply felt in the spring tides and with little wind. However, even during winds of average force the tidal movements were well marked.

Figure 120 shows (according to Storozhev), with progressive vectors for various hours of lunar time, the tidal currents at the surface of the sea, at 15 m, and at the bottom, observed at the mouth of the Khatangski Gulf at $74^{\circ} 44'$ north, $112^{\circ} 38'$ east. Figure 121 shows the tidal currents at the surface of the sea and at the bottom in the open part of the sea at $75^{\circ} 26'$ north, $122^{\circ} 20'$ east.

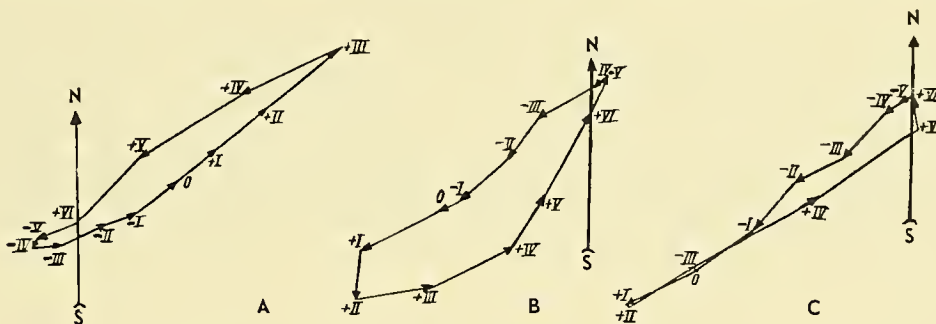

Figure 120. Semidiurnal tidal currents in the Laptev Sea at $74^{\circ} 44'$ north, $112^{\circ} 38'$ east, 24 and 25 November 1937.

The observations of the icebreaker *Lenin* are valuable for their completeness. They have verified previous observations. The basic conclusions which may be drawn from the *Lenin* observations and from others are as follows:

1. In the open parts of the sea the tidal drift of ice in the northern hemisphere is in a clockwise direction. Exceptions to this rule may often be observed near the shores.
2. The speeds of tidal movements of ice are considerably less than the speed of the tidal currents observed under the ice and considerably less than the speed of surface tidal currents observed in the same region in the absence of ice.

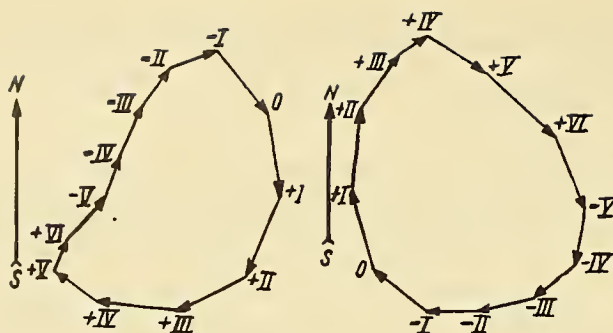

Figure 121. Semidiurnal tidal currents in the Laptev Sea at $75^{\circ} 26'$ north, $122^{\circ} 20'$ east, 7 to 9 February 1938.

3. Tidal movements of ice and tidal currents at a depth under the ice do not coincide in direction and sometimes may be directly opposite.

LITERATURE: 77, 120.

Section 125. Pressing Together and Thinning Out of Ice Due to Tides

As has already been noted, tidal movements of ice cause pressures forcing the floes together or driving them apart.

Nansen notes in his diary, on 13 October 1893, that arctic explorers have repeatedly emphasized the connection between compression of ice and the tides. He states that according to observations of the *Fram* the tidal compression was especially noticeable in the spring tides and was greater at new moon than at full moon. During the course of 24 hours the ice was twice pulled apart and twice pushed together. In the neap tides the tidal pressures were nearly imperceptible. In addition, Nansen shows that the tidal pressures attained their greatest force and regularity at the start of the drift, near the open sea to the north of Siberia, and at the end of the drift when the *Fram* was approaching the Greenland Sea. In the Arctic Basin proper these phenomena were imperceptible. Exactly similar occurrences were noted on the *Sedov* during its drift across the Arctic Ocean.

It must be noted that the increased tidal pressures at the start of the drift of the *Fram* and *Sedov* are properly explained not so much by their proximity at that time to a sea free of ice, as by the fact that they were then over the continental slope, where the tides are more sharply defined (due to sharp change of depth) than they are over the level depths of the ocean.*

Figure 122 shows the movements of particles along the vertical and the outer form of a regular tidal wave. From examination of the figure it may be seen that at point a , where the

*Tidal pressures in regions of strong tides present a considerable danger to navigation. For example, on 7 February 1944 the steamship *Mosta*, leaving Nagayevo Bay accompanied by a line icebreaker, was crushed by the ice at $58^{\circ} 26'$ north, $151^{\circ} 26'$ east. The winds at this time were weak but there were spring tides. It is well known that the amplitudes of the tide are very great along the northern shore of the Okhotsk Sea. For example, in Nagayevo Bay the amplitude of the tide reaches 4.3 m and in Penzhinskaya Guba it increases to 11.3 m.

change from flood tide current to ebb tide occurs, the currents go apart and the deep layers rise toward the surface and the ice consequently thins out. At point *b*, on the other hand, the currents come together, the deep layers drop down and the ice presses together.

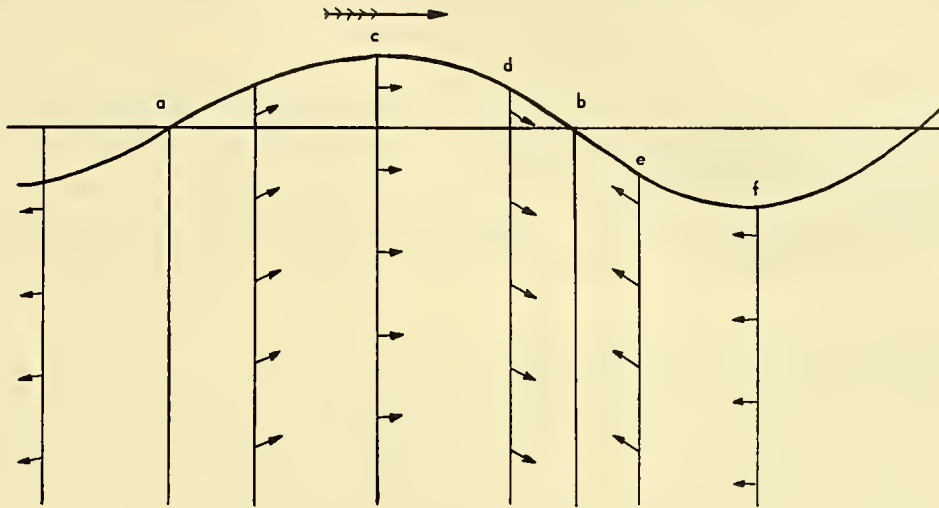

Figure 122. Diagram of movement of particles along a vertical section for a tidal wave.

If we closely examine figure 122, which is typical of normal tide, we see that at the point of high water (point *c*) the flood tide current attains its greatest speed, at point *d* its speed is less, at point *b* it is equal to zero, at point *e* the ebb current has already started, reaching its maximum speed at point *f*, etc. From this it follows that the ice between points *c* and *f* will lag behind the ice which is located at the same moment at point *c*. Consequently, on this whole section of the profile of the flood-tide wave, a thinning of ice is observed, which reaches its maximum at point *a* where the currents move apart. Analogously, on the section of the profile *c b f*, the ice is carried along towards point *b* by the tidal currents from both sides, and at point *b* the compression is most intense. The simple diagram shown in figure 122 is greatly distorted by the shores.

Long ago I have shown that a line which joins points of the sea in which changes of currents occur simultaneously will be parallel to the line of the front of the tidal wave, or in other words, the cotidal lines.*

It is also obvious that the forces which drive the floes together or apart are especially sharply defined at the point where the floating ice meets the shore or the fast ice.

If a tidal wave enters a strait whose depth gradually decreases towards the shore (which is the most usual case), the actual appearance and location of clear spaces of open water becomes complicated. Actually, the speed of the tidal wave is directly proportional to the square root of the depth of the region. It follows that the position of the crest of the tidal wave in such a strait will be slightly curved, with the convex side in the direction of movement of the tidal wave. It thus happens

*In December 1942 during the drift of the trawler 65 along the Zinni shore of the White Sea it was noticed that the open water spaces, during the tidal thinning of ice, extended approximately perpendicular to the tidal currents.

that high tide and low tide do not occur simultaneously along a transverse section of the strait and this causes the difference in time of change of current. For example, while the flood tide is still continuing along the shore, the ebb tide may already have begun in the central part of the channel, etc. These facts, as well as the influence of the deflecting force of the earth's rotation, have a substantial effect on the direction of the tidal currents.

The different times of start of flood tide and change of tidal current, the channel currents and compensating currents caused by this, and likewise the currents caused by the deflecting force of the earth's rotation – all these bring about the meeting of currents of different directions, as a result of which eddies and whirlpools are formed.

The complexity of these phenomena in nature hardly permits the making of appropriate theoretical calculations. Obviously, direct observations in such a case can be of inestimable value.

The broad observations made during the drift of the icebreaker *Lenin* verified the correctness of the considerations which I have discussed.

It is clear that the winds, which also bring about compression and thinning of ice, strongly distort these phenomena. This is especially true in the case of strong winds and also for changing winds. Storozhev has noted (and this is new and important in the study of drift of ice in the Laptev Sea), as a result of observations of the drift of the icebreaker *Lenin*, that there is a relationship between direction of wind and the hastening and retarding of tidal pressures relative to the theoretical times.

For example, it was determined that winds of a northerly direction hasten the start of tidal compression of ice and, conversely, retard the start of thinning of ice. Winds of a southerly direction have the opposite effect. Winds of a westerly direction hasten the start of compression and also lengthen its duration. These winds also retard the start of thinning. Winds of over 7 to 8 m/sec can independently cause compressions destroying the orderly system of tidal compressions.

Storozhev notes at the same time that the maximum height of hummocks which formed as a result of tidal pressures lasting not over 2 to 3 hours did not exceed 2.5 to 3 m while the greatest observed height of hummocks was up to 8 m.

It was also noted that the pressure ridges in the Laptev Sea are extended from west to east in the central part of the sea and from west northwest to east southeast in the southwestern part of the sea. This agrees with the position of cotidal lines of the sea.

During a flight over the Laptev Sea from the icebreaker to Tiksi Bay in early April 1938 Storozhev testifies that clearly-defined open water spaces were seen in strips and also pressure ridges with predominant direction along the cotidal lines.

LITERATURE: 54, 55, 62, 77, 107, 126.

Section 126. The Concept of Ice Time

The changes of tidal compression and thinning have long been used in navigation in ice fields. For example, we had to use the tidal thinning effect for movement forward during navigation in ice on the fragile motor-sail ship *Knipovich* while rounding Franz Joseph Land in 1932. During the approach from the east towards Franz Joseph Land through solid ice on the icebreaker *Sadov* in 1935 we also made broad use of this phenomenon.

In both cases, with calm conditions, the tidal compressions and thinnings occurred alternately with amazing regularity and we could count on them in advance. This fact gave me reason to propound the concept of "ice time." By this is understood the average time interval between the time of upper meridian passage of the moon and the next following compression of ice in the given point of the sea. Thus, the concept of "ice time" is analogous to the concept of "high water lunitidal interval," by which is understood the average time interval between meridian passage of the moon and the following high tide.

Just as the lunitidal interval for every port is determined by observations, and the longer the series of observations the greater the accuracy, so also for determination of ice time appropriate observations are necessary. In determining the lunitidal interval all cases of wind-caused raising of level must be excluded. Likewise, in determining the ice time, cases of wind compression of ice must be excluded.

After the ice time is determined for a number of points of the region under investigation we are able to plot the lines of simultaneous flood-tide compression in the given region, or the "ice lines," in exactly the same way as we plot the cotidal lines--lines of simultaneous high tide or lines of position of the crest of the tidal wave in lunar hours counting from the time the moon passes through the meridian in the given place.

TABLE 96. INTERVAL BETWEEN FLOOD-TIDE TO EBB-TIDE MOVEMENT OF ICE RELATIVE TO CULMINATION OF MOON (MERIDIAN PASSAGE) IN THE LAPTEV SEA

Date	Interval
25 November 1937	8 h 16 min
2 December 1937	9 h 17 min
9 December 1937	8 h 16 min
18 December 1937	8 h 14 min
26 December 1937	7 h 34 min
7 January 1938	5 h 50 min
11 January 1938	7 h 14 min
15 January 1938	6 h 00 min
19 January 1938	7 h 13 min
3 February 1938	6 h 15 min
7 February 1938	7 h 19 min
8 February 1938	5 h 14 min
14 February 1938	6 h 45 min
17 February 1938	6 h 13 min

Average - - - - - 7 h 11 min

In table 96, extracts are given from the table computed by Storozhev from which it may be seen that the change from flood-tide to ebb-tide drift of ice--which corresponds to the thinning of the ice--occurred on the average of 7 hours 11 minutes after the culmination (meridian passage) of the moon. This time interval must be considered as the ice time for the drift region of the ice-breaker *Lenin*.

LITERATURE: 54, 77, 126.

Section 127. Significance of Tidal Phenomena in Navigation in Ice

Several examples have already been cited of the possibility or even necessity of using the periodic tidal phenomena for navigation among ice floes.

The greatest need for this is experienced in a sea like the White Sea. Here the tidal phenomena are sharply defined and navigation in certain years continues throughout the entire winter, thus encompassing all the phases of the ice cover (its formation, period of existence, and destruction) and where navigation is carried on under diverse ice conditions (in fast ice and among floating ice).

A very typical example of navigation in fast ice was the navigation in the channel made by icebreaker in the mouth of the Severnaya Dvina, along the Maimaksa River and along the Severnaya Dvina up to Bakaritsa.

It must be considered that although the floating ice is here divided from the ice frozen to the shore by a tidal crack, the channel made by the icebreaker divides the floating ice into two parts to a considerably greater degree than the tidal cracks divide floating ice from the shore. Therefore, with every rise of the river level due to high tide to effect of wind the channel expands slightly and, contrarily, with every fall of the level it contracts slightly. From this it follows that it is easier for the icebreakers to break the channel and conduct ships along it when the level is up than when it is down.

The situation on the border of the fast ice and floating ice is no less typical. Here much depends on the direction of the edge of the fast ice relative to the front of the tidal wave, or in other words, relative to the direction of cotidal lines in the given region.

In the case of the mouth of the Severnaya Dvina and the Letini shore of the Dvinski Gulf, the cotidal lines, extending from east to west, approach these points from the north. Thus, at the mouth of the river with the start of ebb-tide there begins a gradual receding from the edge of the fast ice and a thinning of the floating ice reaching its maximum at the time of change from ebb to flood-tide and sometimes making a sharply defined polynya bordering the fast ice. For example, such polynyas 50 to 80 m in width, were found by air reconnaissance on 22 January 1942 at the mouth of the Severnaya Dvina. It is by no means possible to explain their presence by winds since for several days before this the prevailing winds, although weak, had been of northerly components.

As the flood tide develops, the thinning of ice is gradually eliminated and by the end of flood tide the floating ice approaches close to the fast ice creating the flood-tide compression and sometimes causing hummock formation.

Along shores which extend in the direction of propagation of the tidal wave, as for example along the Zimni shore of the White Sea, the tidal compressions and thinnings occur according to the general rules; that is, the thinning begins with the start of slowing of the flood-tide current, reaches its maximum at the change from flood-tide current to ebb-tide and then the floes gradually begin to come together. At the point of change from ebb-tide current to flood-tide the maximum compression occurs. All these changes in the entire expanse occur with the speed of propagation of the tidal wave.

Keeping in mind the recorded phenomena and the fact that the tidal currents are stronger when the amplitude of the tide is greater, we may, for example, compare the navigational conditions among the ice floes in the neck of the White Sea along the Terski and Zimni shores.

It is considered that navigation is generally more advantageous along the Terski shore for two reasons: first, the Terski shore is deeper and there are fewer sub-surface dangers along it; second, in the neck of the White Sea in winter westerly and south-westerly winds prevail which act as decompressive winds for the Terski shore. To this must be added the fact that the Terski shore is the right-handed shore with relation to the direction of propagation of flood-tide waves which enters the neck of the White Sea from the north. It follows that theoretically (and this is verified by direct observations) the tidal amplitudes are greater on the Terski shore than on the Zimni shore. Thus, the tidal compressions and thinnings are more sharply defined along the Terski shore. As a result, the ice is more broken here and navigation by correct use of tidal thinning is easier. For the same reason, navigation in the ice is more difficult along the Zimni shore than along the Letni shore, other conditions being equal. The influence of the decompressive south winds is felt even more along the Letni shore than along the Terski shore. It must be further noted that, other conditions being equal, travel from the Barents Sea into the White Sea (with use of tidal phenomena) is in the same direction as the propagation of the wave. It follows that during the compressions the vessel will drift along with the ice into the White Sea and during the thinnings the vessel will go against the White Sea into the Barents Sea. The vessel is carried backwards during the compressions and during the thinning it goes along with the ebb-tide current.

The speed of propagation of the tidal wave is determined by the equation of Lagrange and Airy, as follows:

$$c^2 = gp,$$

where g = acceleration of gravity,

p = depth of water.

Employing the approximate values for the neck of the White Sea, $p = 40$ m and $g = 10$ m/sec², we obtain

$$c = 20 \text{ m/sec} = 72 \text{ km/hr} = 39 \text{ knots}$$

The spreading from Barents into the White Sea occurs with approximately this same speed not only for the crest of the tidal wave but also for any point of its form and in particular the point where the flood tide changes to ebb tide, or in other words, the point where the maximum thinning of ice is observed.

From this it follows that if we could assume that a ship could travel among the ice with a speed of 39 knots, then, while going from the Barents into the White Sea it could continually travel in ice thinned by tidal action. Obviously, we cannot make the same assumption for the case of sailing from the White Sea into the Barents. Thus, the tidal factors are favorable for navigation from Barents to White Sea and are unfavorable in the reverse direction. To the above must be added the fact that navigation from the Barents to the White Sea is more favorable along the Terski shore for the added reason that a gentle permanent current runs from the Barents Sea along this shore while along the Zimni shore, on the other hand, there is a permanent current from the White Sea. It is clear that wind conditions can radically alter the picture presented above.

LITERATURE: 54, 55, 62, 77.

Section 128. Tidal Ice Maps

It is clear that tidal compressions and thinnings of ice are particularly characteristic in narrow straits with very fast tidal currents and jagged shores and irregular bottom relief. Due in the periodicity of currents and resulting large horizontal gradients of speed, the water here moves with great diversity of speed and direction in closely adjacent points so that the deep water is thereby raised and lowered. Wherever the deep masses are raised upwards, a thinning of ice is observed and wherever the surface layers are forced down an accumulation of floes is found. With the change from flood-tide to ebb-tide the picture may change to the reverse in certain regions but in other regions it remains permanent and typical for the given region.

As an example, figure 123 shows one of the diagrams compiled by Burke for the neck of the White Sea for 3 hours after high water at Sesnovets Island. The diagram was compiled on the basis of the "Atlas of Tidal Currents in the neck of the White Sea" and of Burke's personal observations.

Burke shows that a peculiarity of the ice cover in the neck of the White Sea is its turbulent condition due to the strong tidal currents.

The wind is a second factor in the movement of ice. However, despite the wind action, the regular tidal shifting of ice is not completely upset but only altered.

In the region under consideration, the ice as a general rule is thinned by the ebb-tide current running north and, conversely, is concentrated or pressed together by the flood-tide which runs south. The strongest compression occurs in the regions where the currents meet. Regular changes and thinnings of ice do not occur in identical degree in all regions of the sea. There are regions where close ice predominates. According to local terminology, such a region is called a *kolob* if it is located along the shore and an *ostrog* if it is distant from the shore. There are regions, called *razdeli*, where scattered ice is predominant regardless of the force and direction of the wind.

The approximate positions of kolobi, ostrogi and razdeli in the neck of the White Sea are shown in figure 124 (according to Burke).

It is clear that such maps have great importance in navigation in ice and many delays and failures can be explained by the absence of such maps.

LITERATURE: 21, 54, 62.

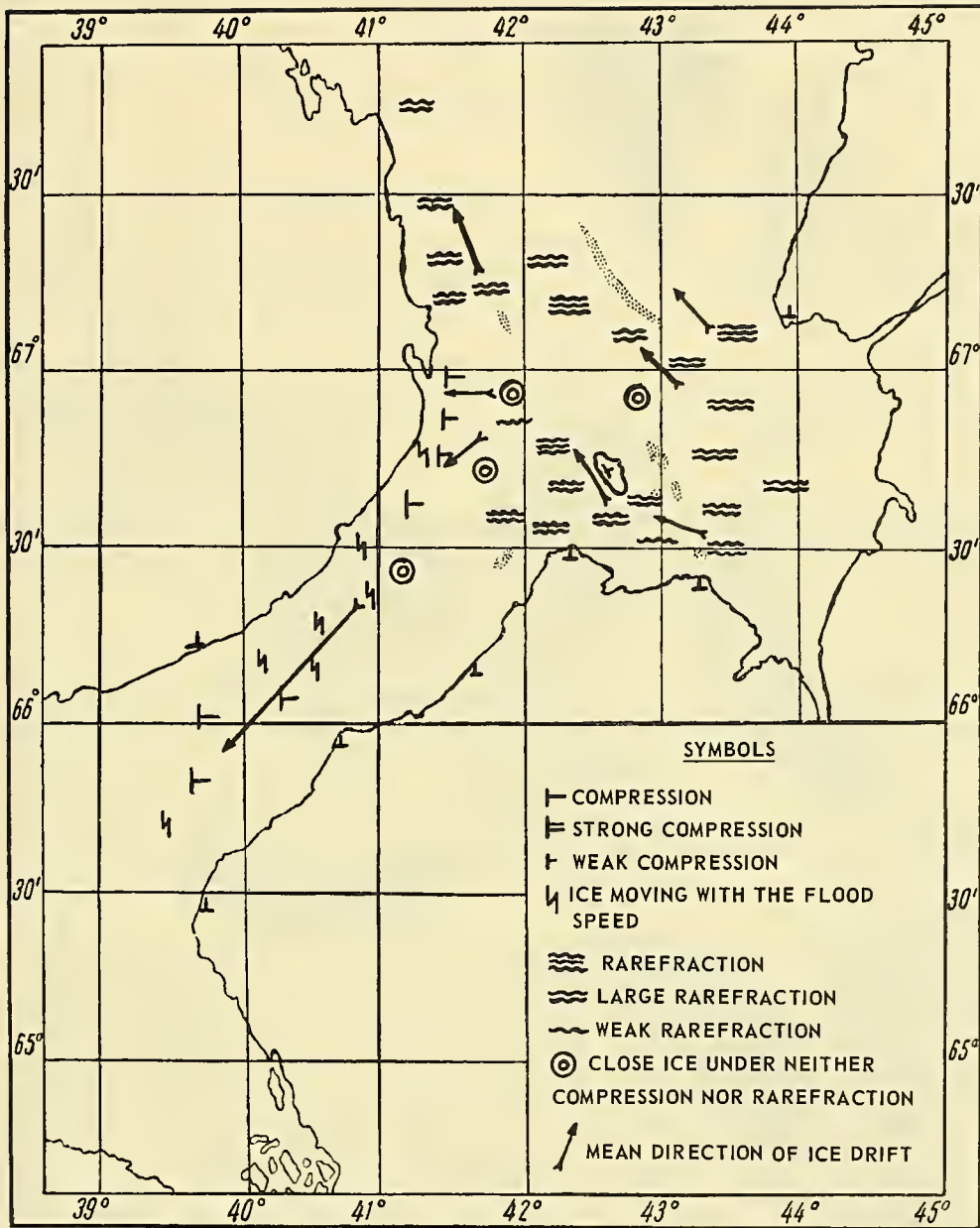

Figure 123. Diagram of tidal compressions and thinnings of ice in the neck of the White Sea for three hours after high water at Sesnovets Light.

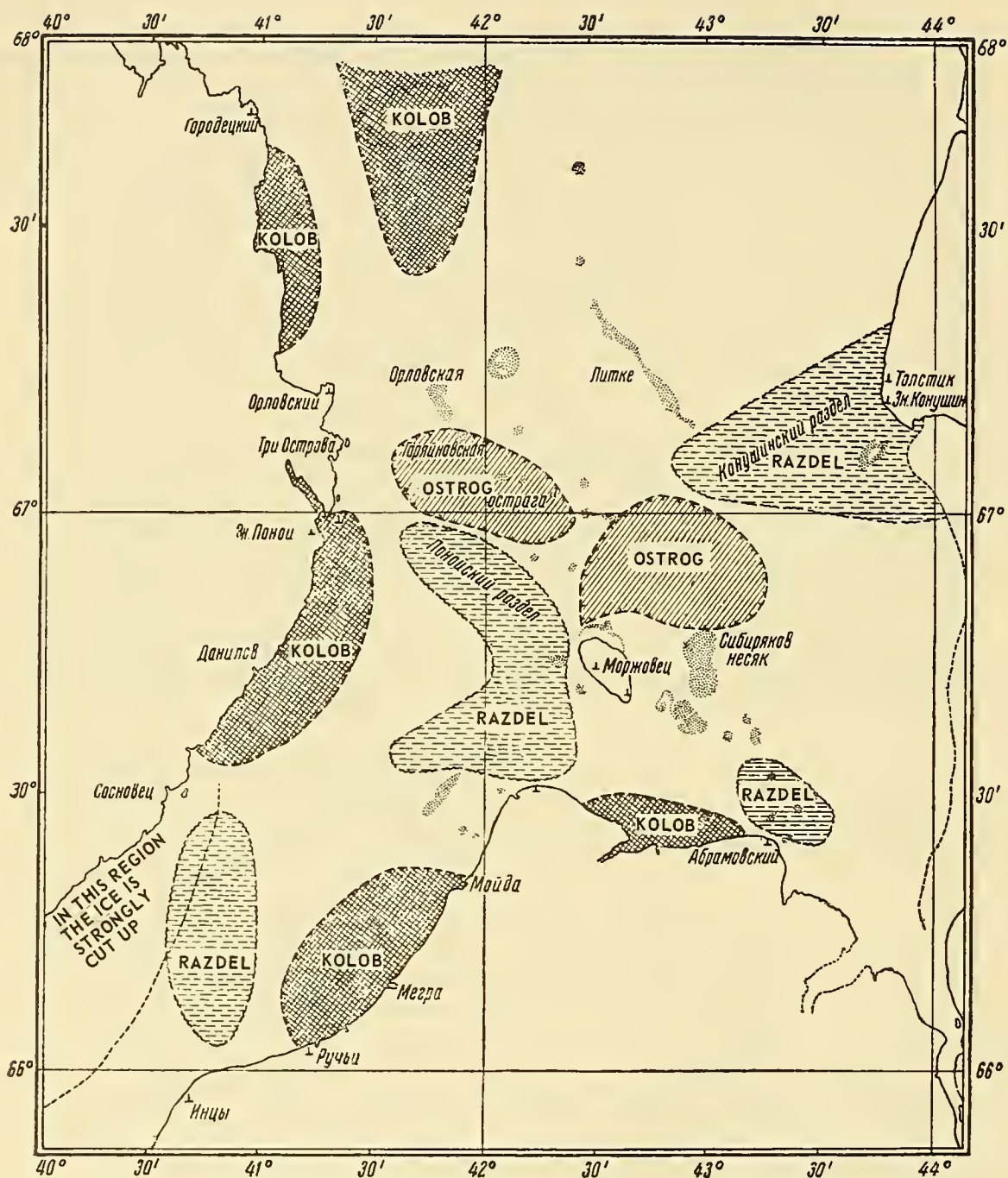

Figure 124. Positions of *kolobi*, *ostrogi* and *razdeli* in the neck of the White Sea, February to April.

CHAPTER X

SEA CURRENTS AND ICE

Section 129. Certain Peculiarities of Sea Currents

Sea currents are divided into permanent currents, periodic currents and temporary currents. The permanent and periodic currents (if tidal currents are excluded) determine the general circulation of the oceans and seas. Temporary currents only alter or distort this circulation.

Among the factors causing the permanent currents are unequal distribution and variations of temperature and salinity and prevailing winds. The coastal flow is also a factor in the creation of permanent currents in small basins. Temporary currents arise in connection with temporary alterations of atmospheric pressure, temporary winds, etc.

Whatever the reasons causing the permanent currents, they are only slightly different from each other in respect to the character of their movements, i. e. , in respect to the vertical distribution of speed and direction. They are more substantially different in respect to temperature and here they are conditionally divided into warm, cold, and neutral currents.

The temperature of a warm current is higher than the water temperature created by local conditions; the temperature of a cold current, lower. From this it follows that the temperature of a warm current is lowered as it progresses, while that of a cold current is raised. One and the same current in different geographical coordinates may be warm, cold, or neutral.

The deep Atlantic current is a warm current in the Arctic Basin where its temperature does not exceed 3°. The Peru current, running north along the Pacific coast of South America and having a temperature of about 22° at the equator, is a cold current.

But warm currents, as a general rule, carry their water from ocean regions where evaporation exceeds precipitation. As a result, the water of the warm current is not only warmer but usually more saline than the local water. This factor is very sharply felt in such currents. Cold currents, on the other hand, flow from regions where the water is freshened by precipitation, coastal flow, and melting of ice. Typical examples of such currents are the East Greenland and Labrador currents. Due to this, the density of surface water is very little different for warm and cold currents. However, the density of surface strata of warm currents increases as the temperature is lowered while the density of surface strata of cold currents decreases as the temperature is raised. In such currents as the East Greenland and Labrador the decrease in density of upper layers assists in melting the ice carried into or formed in the sea, as well as the icebergs.

Great importance is attached to the gradual raising of density of upper layers of warm currents bringing about convective mixing and thereby involving the entire water mass of such a current in an exchange of heat with the atmosphere. The latter phenomenon is especially noticeable in the winter. As has already been noted in the chapter "Melting of Ice," the importance of the West Spitzbergen and Norwegian currents and of currents from the Pacific Ocean is not only due to the

fact that they carry a huge quantity of heat from solar radiation and advective heat of the atmosphere during the summer season.

The importance of the cold currents, particularly such as the East Greenland and Chuckchee currents, lies not only in the fact that they carry arctic ice into the warmer regions, but also in the fact that their surface layers, at the start of freezing, are comparatively fresh due to the thawing of ice, their temperature is close to the freezing point, and in addition, they always carry a greater or smaller number of ice fragments--the cores of future ice formation.

The outline of the coasts and the deflecting force of the earth's rotation have a great influence on the direction of the permanent currents. Thus, in certain seas which are bordered by fairly large archipelagos and which are connected with other basins by fairly wide straits, very curious circulations are produced. I have determined these for the northern hemisphere using the following simple rules:

1. In the central part of the basin a cyclonic (counter-clockwise) movement is produced. The light water (in vertical section) is driven out in wedge fashion, with the wide side of the wedge towards the shore, while the heavy deep water is raised up in the center of the basin with the dome-shaped swelling towards the top. In certain cases (with thin surface layer and great speed of current), the deep water may even come up to the surface.

2. Around large archipelagos and islands, currents are created which round the archipelagos in a clockwise direction (anticyclonic).

3. If you look down the length of sufficiently wide strait and stretch your right hand forward and left hand back, the direction of your outstretched hands will show the directions of currents along the corresponding shores.

The greatest peculiarities are found in currents created by temporary winds when the water cannot obtain the equilibrium determined by the coasts and the water masses when not influenced by the given wind. Theory and observations mark the following factors in such currents:

1. In the northern hemisphere the surface wind-caused current deviates towards the right at a considerable angle. (According to Ekman's theory, at a distance from the coast the angle of deviation is equal to 45° for all speeds of wind and currents and for all geographic latitudes). Near the coasts, however, the current may deviate toward the left.

2. The sub-surface currents deviate from the surface current in the same direction as the surface current deviates from the wind and the speed of current decreases with depth according to the logarithmic law.

3. The speed of the surface current is approximately one fiftieth ($1/50$) the speed of wind.

Currents similar to wind-caused currents are created under ice fields which are drifting under the force of shortlived winds.

It must be emphasized that the aforementioned peculiarities are characteristic only of wind-caused currents, i. e., those created by temporary winds where the sea level is not yet inclined under influence of deflective force of the earth's rotation. In currents which are caused by permanent or prevailing winds, as for example the North Atlantic Drift and the East Greenland current

(which I term "drift currents" as distinguished from wind-caused currents), the light surface water due to deflective force of earth's rotation is forced towards the right-hand shores (looking down the current), sea level is raised in the direction of the shore and the direction of currents along the vertical is almost unchanged.

LITERATURE: 57, 62, 77.

Section 130. Movement of Ice in Sea Currents

The movement of ice floes which have the largest part of their volume submerged in the water, in the absence of wind, is determined by the direction and speed of the currents of the given region of the sea and has the following peculiarities:

1. Individual ice formations (icebergs, floebergs) sometimes have considerable draft. Obviously, such an ice formation will move according to the resultant movement of the water layers in which it is submerged.

2. The circulation of water masses includes both the horizontal and the vertical movement of water. It is natural that the ice, participating as it does in only the horizontal movements, in certain cases will move separately from the movement of the surface water.

3. The areas occupied by ice, as well as the horizontal dimensions of individual floes, undergo seasonal changes and long-term changes. Therefore, the ice movement in rivers may experience interruptions (ice formation, blocking, etc.), depending on local conditions.

As a general rule, the speed of sea currents gradually decreases with depth. Therefore, the greater the draft of the ice, the slower its movement by comparison with movement of surface water. Thus the icebergs and floebergs which sit deep in the water usually move slower than the surrounding fragments of the broken ice fields and from the side it sometimes seems that they are completely without movement, as if they were sitting on a shoal. It is due to this that surf may often be seen at the ends of some icebergs and this creates the impression of movement. Since in some few cases the deep currents may be distinctly different from the surface currents in both speed and direction, and may even be in an opposite direction, icebergs and floebergs may sometimes be observed drifting across or even against the current.

Ice formations of large horizontal dimensions may drift into an area where there are two surface currents which are different in speed and direction. In such cases the ice acquires a rotary movement along with the forward movement. This occurrence is especially typical in comparatively narrow straits and where many eddies and whirlpools are formed. Rotating ice is constantly observed in the Datski Straits, Khinlopen Straits, Straits of Franz Joseph Land, neck of the White Sea, and in other straits. We have seen, in particular, that the rotation of ice by sea currents has been proven for the ice of the Chuckchee Sea.

The fact that the circulation of water masses includes both horizontal and vertical shifting of water while the ice can move only in a horizontal direction results in an accumulation of ice wherever there are points or lines of junction of sea currents in which the surface water layers are descending. Conversely in points or lines of divergence of sea currents we observe a thinning of sea ice and formation of polynyas. This phenomenon may be permanent, periodic, or temporary.

Since every movement in the northern hemisphere deviates to the right and in the southern hemisphere to the left, due to Coriolis force, every current which washes a right-hand coast in the

northern hemisphere carries ice towards the shore and creates an accumulation of floes and a compression. Conversely, a current which washes a left coast carries the ice from the shore and sets up a thinning action forming polynyas. In open parts of the sea, due also to Coriolis force, in the center of the anticyclonic currents where the water masses descend, accumulation of ice occurs with resulting compression. In the center of the cyclonic currents we observe sparse ice and on the periphery, close ice.

Regions of sinking and rising of water masses, causing corresponding accumulations or thinning of ice, are also formed along the lines of contact of sea currents of opposite direction. Sinking results from meeting of these currents, rising from separation or moving away from each other. The formation of many ice massifs and their appearance even in the summer months of years of little ice is explained by precisely these existent systems of sea currents.

Examples of such massifs are the Spitzbergen massif in the northwestern part of the Barents Sea, the Nova Zemlya massif in the southwestern part of the Kara Sea, the Taimyr massif which extends to the south along the axis of the deep hollow from the north into the Laptev Sea, the Yanski massif which blocks the western entrance to Laptev Straits at the start of summer navigation, and others. In regions of calm the ice also lasts very long in the summer time, but here the typical mark of the ice massif--compactness of ice--is usually less clearly noticed. In the melting and destruction process the percentage of ice decreases at more or less an equal rate.

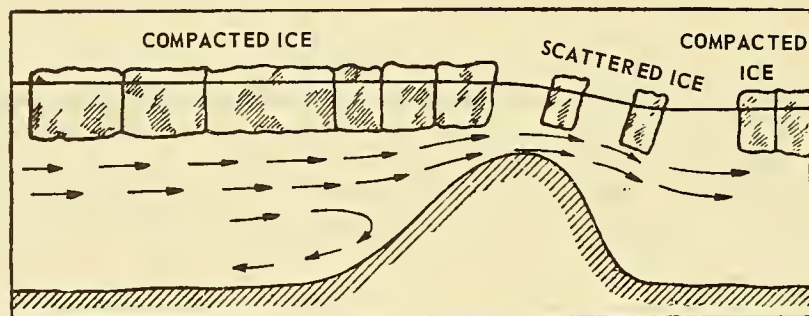

Figure 125. Thinning of ice behind shoals.

Figure 125, borrowed from Burke, shows the formation of thinned areas and polynyas behind shoals which lie in the path of permanent currents. Even more sharply noticeable are the thinnings and polynyas behind islands which lie in the path of the currents.

Of great interest is the formation of thinned areas and polynyas in the regions where the speed of permanent currents is increased for one reason or another. For example, here is what Badigin notes in his diary during the drift on the *Sedov*. The ship was at that time at $86^{\circ}09'$ north, $96^{\circ}00'$ east. "To our west a clear area opened up of unprecedented proportions. This was a whole lake over a kilometer in width. Its length extended to the limits of visibility..... The clear area appeared a few days ago..... Now the width of the clear area has reached 2 kilometers."

This clear area, first decreasing in size and then increasing, remained near the *Sedov* until the end of the drift. Such a phenomenon in the drift region of the *Sedov* was not accidental. According to observations of the *Fram*, the quantity of polynyas and clear areas also increased in

proportion as the vessel neared the straits between Spitzbergen and Greenland, which is due to the increase of speed of surface arctic current in that direction.

Special attention must be paid to the effect of the deflective force of the earth's rotation on the movement of ice carried by sea currents. When the water is stratified and after the steady state has been attained, the inclination of sea level balances the Coriolis force and the horizontal movement of water particles toward or away from the shore ceases. Let us consider an ice floe which is drifting along toward the west in such a current. The Coriolis force will act on it and due to this the flow will move in a shoreward direction despite the fact that the fixed current is moving along the shore. The speed of the ice-floe's approach to shore due to the Coriolis force will be balanced by the hydrodynamic resistance, depending on the shape and size of the submerged part of the floe. With stratified water and a steady current, even if the wind has a shoreward component, the water particles will not move shoreward. Obviously, in such a case the movement of the floe due to Coriolis force will be hastened by pressure of wind on the part of the floe projecting over water.

Figure 126 shows the position of ice edges in Chuckchee Sea, 13 to 25 July 1943, according to observations made on the skiff *Smolny*. In 1943 in the Chuckchee Sea there was little ice and therefore the effect of the Chuckchee current in distributing the ice was quite clearly evident. From the figure may be seen the deep bay of clear water which was formed by the Pacific current and the ice tongue (carried by the Chuckchee current) which extended along the continental coast.

Sea currents are not only important in the distribution of ice in a given region, but also assist, to a certain degree, in the distribution of certain types of bottom deposits connected with ice. Bottom ice, as it rises, often carries up to the sea surface some bottom particles which are frozen to it. In its pressure on the shore and on shoals the ice tends to plow up the bottom. In this process not only small particles but also occasional rocks and clods may be affixed to the ice. This phenomenon is especially significant in glaciers descending towards the sea. *

Subsequently, when the ice is torn from the shore and carried by currents to regions where it melts and is destroyed, these foreign inclusions fall to the bottom and here form peculiar bottom deposits.

According to our observations on the *Sadko* in 1935, in the central, deep water of the Greenland Sea at a depth of 2000 to 3000 m, an underwater ridge stretches in a meridional direction, made up of coarse-grained sand, pebbles and boulders. The origin of this ridge is no doubt connected with the fact that in this area the ice, carried from the Arctic Basin and bringing with it fragments of rock, meets the warm water of the Spitzbergen current and is thus destroyed, the rock fragments falling to the bottom. The fact that these fragments form a ridge instead of being dispersed comparatively equally along the eastern part of the Greenland Sea, is one proof of the antiquity of the system of currents in Greenland Sea, in particular the East Greenland current and Spitzbergen current. It also proves the comparative stability of the position of the eastern ice edge in Greenland Sea.

The bottom deposits in the Barents and Kara Seas belong to the type of glacial sea deposits. Grains of sand and rocks, carried by the ice, may often be found in them.

*On 17 August 1899 in the region to the northwest of Spitzbergen, Makarov discovered an iceberg whose whole surface was covered with boulders up to 1 m in diameter.

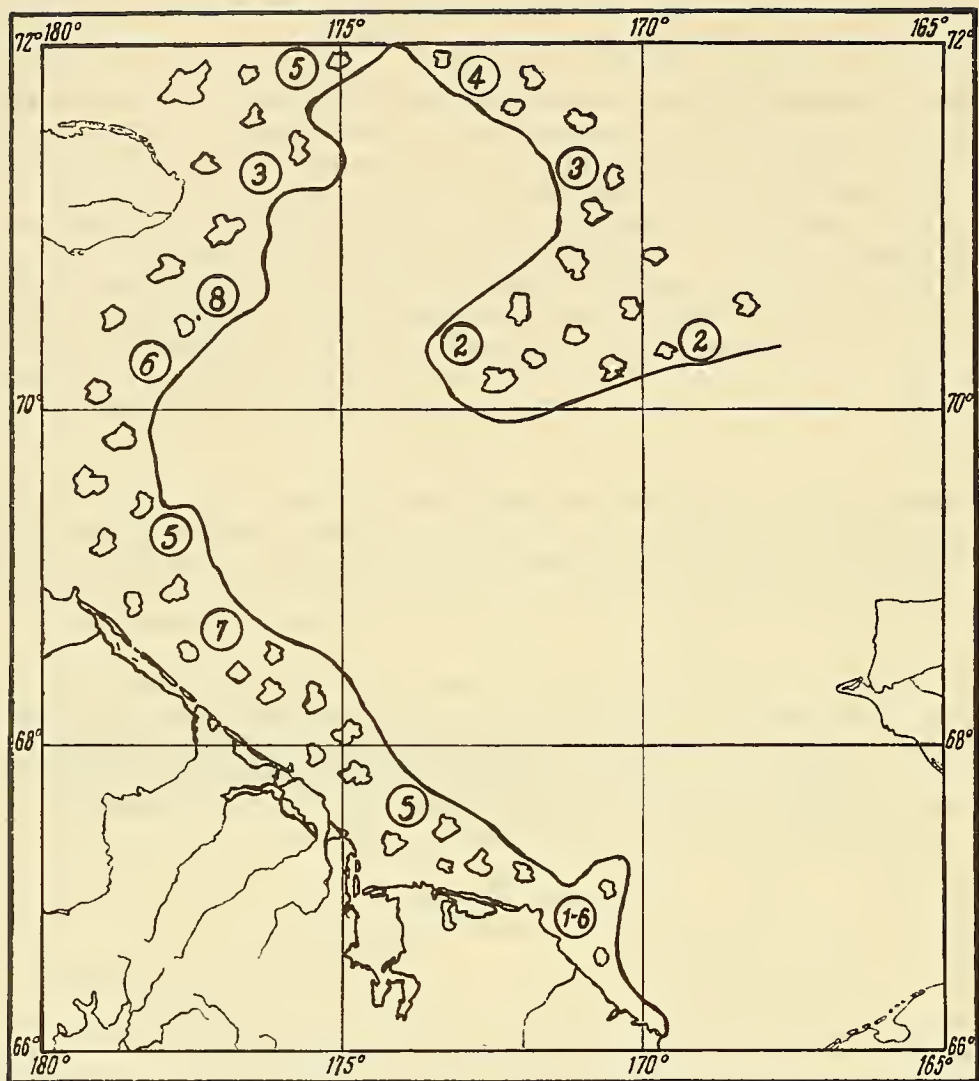

Figure 126. Ice conditions in the Chuckchee Sea, 13 to 25 July 1943.

Tanfilev noted that in 1884 some divers, examining a cutter which had sunk in 1807 on the Copenhagen route, discovered that the cutter and other sunken vessels alongside it were filled with stones, which could only have been carried there by ice.

LITERATURE: 11, 25, 55, 62.

Section 131. Currents and Fast Ice

As has already been mentioned, the speed of sea currents usually decreases with depth. In particular, the speeds of coastal currents decrease with depth according to the parabolic law.

The sea currents extending vertically to the bottom undergo friction not only with the bottom but also with the lower surface of the ice. Theoretically, since the current speeds are equal to

zero at the bottom and at the lower surface of the ice, the graph of speeds under the ice should represent a parabola with its horizontal axis running through the middle of the depth of the current.

For comparative purposes there are shown in Figure 127 the graphs of current speeds of the Volga at Kamyshin, constructed by Polyakov as a result of averages of 1162 summer and 913 winter observations.

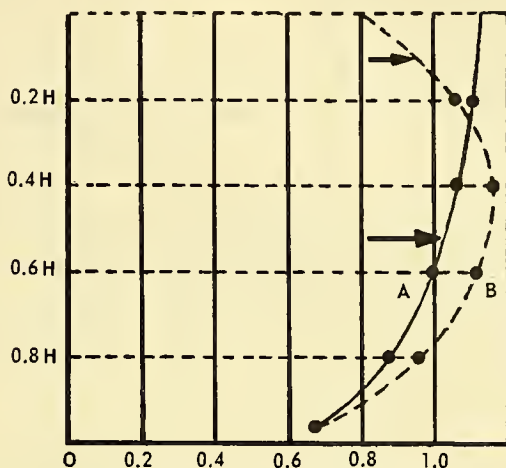

Figure 127. Graphs of average current speeds of the Volga River at Kamyshin. *A* -- open river. *B* -- river under ice.

As may be seen from this figure, the graph of speeds at the lower ice surface shows greater speeds than at the bottom, which, according to Polyakov, is due to the greater roughness of the bottom at Kamyshin by comparison with the roughness of the lower ice surface. It is evident that similar phenomena are also seen in sea currents which flow under fast ice.

Sea currents in their turn have a constant dynamic effect on fast ice, and if the current is warm, a thermal effect as well. The dynamic effect consists in a washing away and smoothing of the lower surface of the fast ice. It has already been shown that in calm regions, in the period of ice formation, the lower surface of the ice is brush-shaped and the water directly adjacent to this surface is filled with a quantity of ice particles of diverse shapes and sizes. With the presence of currents, all these particles are carried into the interstices of the lower surface of the ice, which they then fill up. In addition, as they flow around the sub-surface projections of hummocks the sea currents gradually wash them away. It is clear that the effect of the sea currents in this respect cannot, however, be compared with the washing away effect of tidal currents.

Due to the thermal action of currents, ice formation is retarded in the freezing period, while in the melting period the destruction of the fast ice cover is hastened. Table 87 set forth the water temperatures in Yugorski Shar before its breakup in 1935. From the table it may be seen that the water temperature under the ice began to rise from the 12 June and on 28 June the ice, which was almost one meter thick, broke open. The high temperatures of the water under the ice was not caused by local conditions. This warm water was carried there from the Pechorski Sea.

LITERATURE: 77, 116.

CHAPTER XI

WIND AND THE DRIFT OF ICE

Section 132. The Wind Drift of Ice

All observers are struck by the speed with which ice, both close ice and scattered ice, reacts to any change in the wind speed and direction.

For example, it takes but a few hours of fresh wind of the proper direction to change the entire ice situation in a given region beyond recognition. Of course, this change is determined by the geographic conditions, the contour of the coast line, the bottom relief, the system of steady currents, the distribution of temperature and the salinity of the water in the given region, etc.

Despite the great complexity of the wind movement of ice, one may distinguish three characteristic cases:

1. The wind drift of close ice.
2. The wind drift of an isolated floe.
3. The wind drift of scattered ice.

In the first case, the wind, exerting pressure on the ice cover, causes the ice cover to drift. In turn, the drift of the ice cover causes a current in the water masses beneath it and this current is subject to the same laws of vertical distribution of velocity and direction as the current caused by the direct action of the wind. In this connection, a very complex resistance arises, the resistance offered by the water to the wind drift of ice.

In the second case, the wind causes a wind current with which the ice flow moves. However, since the action of the wind on the floe is stronger than on the equivalent water surface, the flow acquires its own wind motion.

The third case, the wind motion of scattered ice, is intermediate between the first and second cases and depends on the concentration of the ice. Furthermore, this type of drift exhibits features which appear because floes of different form and size drift at different speeds and in different directions, depending on the force and direction of the wind.

In addition, one must distinguish wind drift during the freezing period and during the thaw period. In the first case, when there is hummocking in connection with drift, the new expanses of open water which appear are rapidly covered over with ice and thus the total amount of ice increases. In the second case, expanses of open water also appear, but the heat from solar radiation accumulates rapidly in these spaces and this results in a decrease in the total amount of ice.

Theoretical investigations of the wind motion of ice are seriously hampered by lack of knowledge of the vertical distribution of wind velocity and direction over the open sea as well as over ice fields and also by the lack of knowledge of the vertical distribution of water velocities immediately below the lower surface of the ice.

However, it is quite clear that if a stream of air sets ice in motion, the moving ice, in turn, will exert an influence on the layers of air above it.

In this respect, the observations of Efremov are very interesting. They were made in July 1939, during the drift of the *Sedov* in the Arctic Basin, in the region between 85°23' and 85°50'30" north and 58°27' and 64°21' east (table 97).

TABLE 97. WIND SPEEDS AT VARIOUS HEIGHTS ABOVE THE SURFACE OF ICE
(IN PER CENT OF THE WIND SPEED ON THE BRIDGE OF THE SHIP)

Wind in M/Sec	Height Above the Ice in M							Number of Cases
		0	0.5	2.0	6.0	12.5	18.0	
	0-1	0.0	13.0	0.9	14.8	100	143.5	2
	1-2	29.4	60.0	68.0	86.6	100	130.0	5
	2-3	20.9	45.1	65.0	89.5	100	132.1	12
	3-4	26.7	49.9	63.0	84.4	100	115.4	20
	4-5	38.3	56.3	69.4	82.5	100	119.2	20
	5-6	41.2	56.4	72.0	87.3	100	119.2	20
	6-7	40.1	51.7	70.2	76.3	100	113.6	10
	7-8	41.9	50.0	62.2	83.6	100	115.2	2
	8-9	39.1	52.1	65.6	76.0	100	103.9	7
	9-10	38.8	49.4	68.7	84.9	100	109.2	4
	Average	25.6	51.2	66.2	81.2	100	112.2	102

From the table it is evident that the wind speed at the surface of the ice on an average was 24 per cent of the wind speed measured on the bridge of the *Sedov* 12.5 m above the surface of the ice.

During the drift of the station "North Pole" ("Severnyi Polius"), the wind speed was measured at a height of 2m. From the table it is evident that on an average one may consider that the wind speed was about 66 per cent of the wind speed at the height of the *Sedov* bridge.

Theoretical concepts indicate that the wind direction should also differ at different heights above the surface of the ice, but to my knowledge no supporting investigations have been made as yet.

The problem of the magnitude and direction of the hydrodynamic resistance offered by the water to the ice under various circumstances is equally complex and as far as the theoretical concepts go we must rely on fairly well-founded assumptions.

LITERATURE: 62, 72, 77.

Section 133. The Drift of Close Ice Fields

The first systematic investigations of the drift of close ice fields were made by Nansen during the expedition on the *Fram* in 1893 to 96. These investigations were particularly important in that the drift of the *Fram* passed over a deep part of the ocean, far from the distorting influence of the coastline.

In analyzing his observations, Nansen established that the ice drifts at a considerable angle to the right of the wind (if we exclude the influence of any steady current) and he ascribed this phenomenon to the deflecting force of the earth's rotation.

To exclude the influence of steady currents, Nansen used the following example. He proposed that when the air particles (wind) pass over the ice in various directions they intersect their own path and the ice fields (if we assume a linear relationship between the drift speed and the wind speed and the absence of sea currents in the given region) should also intersect their own path. From the difference in the geographical coordinates of the *Fram* and the time intervals between the return of the wind to the same point in space, Nansen calculated the direction and velocity of the steady current.

The linear relationship between the drift velocity and the wind speed was established by Nansen from the following concepts. If we consider that the wind pressure on the ice is proportional to the square of the wind speed, while the hydrodynamic resistance of the ice to motion is proportional to the square of the drift velocity, during steady motion these forces should balance.

Proceeding from these concepts, we may write $mw^2 = nc^2$, where m and n are the coefficients of proportionality or

$$a = \sqrt{\frac{m}{n}} = \frac{c}{w},$$

where a is the wind factor, c is the drift velocity and w is the wind speed.

Nansen's supposition is supported by the data of table 98, from which it is evident that the wind factor did not show a dependence on wind speed.

TABLE 98. WIND FACTOR AND THE DRIFT ANGLE ACCORDING TO THE OBSERVATIONS OF THE *FRAM*

Wind Speed In M/Sec	Drift In Miles Per Day With A Wind Speed	Wind Factor	Drift Angle
0-2	0.95	0.0205	+ 9°50'
2-4	0.76	0.0164	+30°28'
> 4	0.94	0.0201	+34°27'

In his final account, Nansen arrived at the results shown in table 99 for the drift of the *Fram* from 7 November 1893 to 27 June 1896.

To obtain the data of table 99, Nansen processed 76 drift segments in which the wind factor varied from 0.0002 to 0.0596, on an average 0.0182; the drift angle varied from +80° to -63°, average +28°. Unfortunately, I was not able to ascertain at what height above the ice the wind observations were made on the *Fram*.

TABLE 99. RESULTS OF OBSERVATIONS OF THE *FRAM* DURING ITS DRIFT FROM
7 NOVEMBER 1893 TO 27 JUNE 1896

Resultant wind direction	341°
Resultant total drift direction	340°
Drift angle	-1°
Angle between the current and the resultant of the wind	+25.5°
Angle between the resultant of the wind and pure wind drift	+37.5°
Average wind speed	0.757 m/sec
Average drift velocity	1.07 miles/day
Average velocity of the steady current	0.73 miles/day
Average drift	0.52 miles/day
Wind drift caused by a wind speed of 1m/sec	0.69 miles/day
Wind factor	0.0148

Average of the 76 Segments Investigated by Nansen

Wind drift	2.98 miles/day
Wind drift caused by a wind speed of 1m/sec	0.85 miles/day
Drift angle	28°

Using Nansen's observations as our basis we can consider that on an average over deep sea and far from the distorting effect of land, the wind drift of ice obeys the following laws:

1. The drift of ice in the Arctic Basin deviates approximately 28° to the right of the wind direction.
2. The wind factor is approximately 0.02, or, in other words, the pure wind drift is approximately 50 times slower than the wind speed which causes the drift.

In what follows, departures from these values are usually assumed to indicate steady currents of corresponding velocity and direction or the presence of obstacles (islands, underwater shoals) which change the normal wind drift of the ice.

The discovery of Vize Island (in the northern part of the Kara Sea) shows how fruitful a comparison of the wind direction and the wind drift of ice fields can be.

As early as 1924, Vize pointed out some features of the wind drift of the vessel *Svyataya Anna* caught in the ice off the Yamal Peninsula in 1912 and then carried off together with the ice northward into the Arctic Basin where the ship disappeared without a trace.

Analyzing the drift features of the *Svyataya Anna* between 77° and 80° north and between 72° and 78° east, Vize concluded that they could be explained by the presence of land between 78° and 80° north to the east and not far from the line of drift of the *Svyataya Anna*. Such land was actually discovered by the expedition on the *Sedov* in 1930. It proved to be an island situated between 79° 39' and 79° 32' north and 76° 46' and 77° 20' east. Appropriately, this island was named Vize.

After Nansen, two more expeditions drifted over the deep Arctic Basin, the ice station "North Pole" (1937-38) and the *Sedov* (1937-40).

Figure 128, by Shirshov and Fedorov, shows the drift of the ice field station "North Pole" from 3 to 8 August 1937, (about 88° north, 3° west). The drift is sketched on the basis of astronomical determinations and direct instrument readings of the drift elements. The figure also shows the observed wind directions for that period.

It is evident that the drift of the ice fields was very responsive to the wind and to any change in the wind. Consequently, the ice field described zig-zags and even loops. Furthermore, Shirshov and Fedorov noted winds of various directions affected the drift in various ways over the entire drift path beginning at the North Pole and ending in the region of Jan Mayen Island. The ice field responded rapidly and readily to winds causing a southerly drift and they reacted relatively poorly to winds causing a northerly drift. Shirshov and Fedorov explained this phenomenon (noted and explained by Nansen previously) as follows: the movement of the ice field is determined by two factors,

1. by the action of temporary and variable winds, the temporary drift in various directions and
2. by the collective action of the prevailing winds over the Arctic Ocean and the hydrological factors which create the general circulation of the ice and waters of this ocean - the main drift from the Pole to the Greenland Sea and farther south along the coast of Greenland.

In cases where the temporary wind drift and the main drift coincide in direction, the drift velocity of the ice field increased. Otherwise, it decreased sometimes to 0; in the case of a strong wind drift northward, the ice field even moved northward.

The drift of the *Sedov*, which to a certain extent repeated the drift of the *Fram*, also confirmed the simple laws stemming from Nansen's investigations. In my figure 129, I show the wind path and the drift of the *Sedov* from 1 September 1938 through 1 January 1939.*

A comparison of the wind and drift paths shows that they are strikingly similar. Where the wind direction is nearly constant, the ice moves approximately in one direction. Where the wind direction and speed vary, the ice describes zig-zags and loops. The figure 8's described by the wind and the ice between 2 and 26 September and the zig-zags between 10 and 30 November 1938 are particularly characteristic in this respect. Under steady winds, the direction of drift differs from the wind direction only in that it veers to the right, as already established by Nansen.

Individual exceptions to this rule do not change the essence of the phenomenon. The origin of such deviations is understandable. The movement of ice depends not only on the local wind but also on wind blowing nearby. Large ice fields set in motion take on a great inertia which brief or weak winds may not necessarily overcome. Under the influence of the preceding wind situation,

*The scale of the wind speed on the sketch is 50 times smaller than the scale of the drift velocity; in other words, in constructing the diagram it was assumed that the wind factor was 0.02.

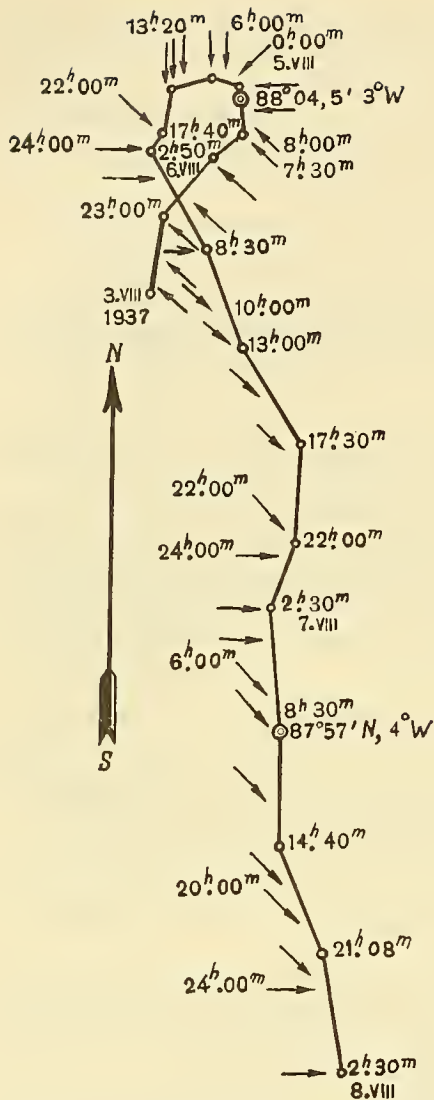

Figure 128. The relationship between wind direction and the drift of station "North Pole" from 3 to 8 August 1937.

compressive forces may be created in some directions and scattering forces in others, promoting or impeding drift, etc.

To continue the study, I analyzed the drift of the *Sedov* from 1 September 1938 through 1 January 1940, i. e., the period when the *Sedov* was over great ocean depths and far from the distorting influence of the coast. During that time, 5764 measurements of wind speed and direction were made on the *Sedov*. In the analysis, I found that I could use 378 drift segments included between complete astronomical determinations and that I could calculate the resultant winds for these segments.

In processing this extensive material I found that the wind path often intersected itself. This allowed me, using Nansen's method, to calculate the elements of the steady current at various regions of the drift. First of all, I became convinced that the drift velocity is a linear function of the wind speed.

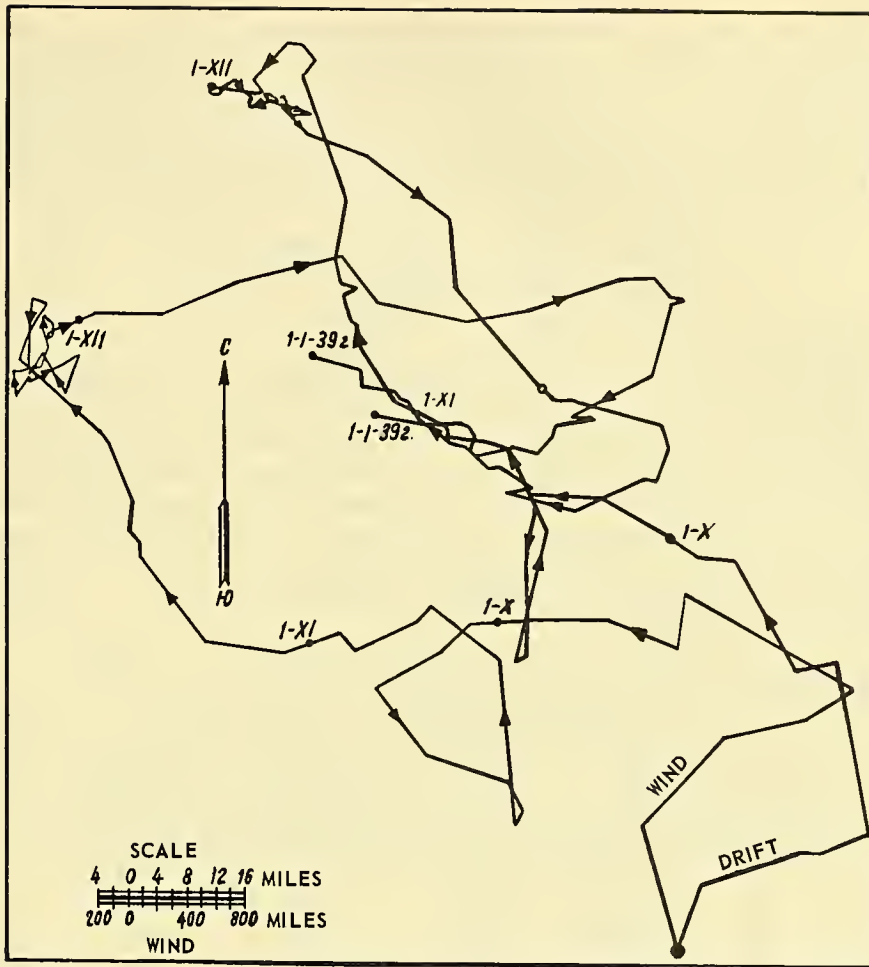

Figure 129. The wind path and the drift of the *Sedov* from 1 September 1938 through 1 January 1939.

TABLE 100. TRUE DRIFT ANGLES AND WIND FACTORS VS. WIND SPEEDS DURING THE DRIFT OF THE *SEDOV*

Wind Speed In M/Sec	Number of Cases	Wind Factor			Number of Cases	Drift Angle		
		Average	Maximum	Minimum		Average	Maximum	Minimum
0-1	8	0.034	0.104	0.010	9	28°	170°	3°
1-2	21	0.019	0.064	0.002	21	13	166	0
2-3	41	0.016	0.038	0.001	42	34	150	6
3-4	59	0.013	0.034	0.001	58	23	130	2
4-5	58	0.013	0.034	0.002	60	24	82	1
5-6	52	0.015	0.045	0.003	51	39	77	4
6-7	51	0.015	0.027	0.004	51	28	83	1
7-8	34	0.016	0.021	0.007	34	26	50	3

Table 100. (Continued)

Wind Speed In M/Sec	Number of Cases	Wind Factor			Number of Cases	Drift Angle		
		Average	Maximum	Minimum		Average	Maximum	Minimum
8-9	21	0.015	0.022	0.011	21	38	174	6
9-10	16	0.015	0.021	0.005	16	32	53	3
10-11	8	0.017	0.023	0.014	8	40	60	20
11-12	2	0.020	0.022	0.019	2	46	68	24
12-13	2	0.016	0.017	0.015	2	42	51	33

Table 100 gives the wind factors of drift and the drift angles for various wind speeds.

Comparing the data of table 100 with the data of table 98, which was compiled by Nansen, one may say that within the limits of accuracy of the observations the relationship between the drift velocity and the wind speed is linear and the drift angle does not depend upon the wind speed. It should be emphasized that the influence of the steady current was excluded from table 100.

Table 101 shows the elements of the steady current combined by regions, on the basis of 39 intersections of its own path by the wind.

TABLE 101. STEADY CURRENT ELEMENTS ALONG THE PATH OF DRIFT OF THE *SEDOV*

Number of Combinations	Mean Coordinates		Steady Current	
	Latitude	Longitude	Direction (of Movement)	Velocity In Miles/Day
2	84° 10'	133°	250°	0.55
2	84 40	123	280	1.0
13	85 30	126	270	0.8
3	86 30	108	310	0.9
8	85 40	70	270	1.1
4	86 00	70	260	0.8
1	86 30	45	226	2.5
1	86 00	40	225	1.1
2	85 20	30	215	1.2
1	84 30	20	205	1.6
2	84 00	10	220	1.5

We are struck by the fact that during the drift of the *Sedov* west of 70° east, all intersections of the wind path (17 cases) show a steady southwesterly current, while during the drift east of 70° east in 17 of 22 cases, the steady current ran northwest, and in one case even northeast. However, if we examine the drift of the *Sedov* only in the region north of 85°40' and east of 70°, in all cases we find a northerly steady current. This should not be considered a chance finding by any means, but it requires a more profound analysis than I was able to make by the time this book went to press.*

*Libin informs me that the steady current in the region of operations of the expedition on the airplane N-169 (approximately 80° north and 183° east), ran in a compass direction of 273° at a velocity of 2.4 miles/day.

Of course, a comparison of the observed wind and drift paths gives the wind factor and the drift angle created by the joint action of the wind and the steady current. Also it is clear that if we know the elements of the steady current, it will not be difficult to obtain the corresponding for the pure wind drift.

Table 102 gives the average monthly drift angles and the wind factors for drift of the *Sedov*.

TABLE 102. MEAN MONTHLY DRIFT ANGLES AND WIND FACTORS
DURING THE DRIFT OF THE *SEDOV*

Month	Number of Cases	Wind Factor		Drift Angle	
		Observed	True	Observed	True
1938					
September	9	0.016	0.015	32°	36°
October	14	0.017	0.014	49	45
November	32	0.017	0.013	16	24
December	30	0.020	0.017	39	37
1939					
January	38	0.016	0.016	25	31
February	25	0.015	0.014	-3	8
March	31	0.018	0.014	29	25
April	28	0.015	0.013	26	29
May	23	0.015	0.015	34	26
June	20	0.026	0.018	39	19
July	19	0.014	0.014	15	42
August	18	0.019	0.016	-6	31
September	14	0.020	0.018	18	14
October	24	0.016	0.013	15	35
November	125	0.023	0.017	29	27
December	28	0.022	0.018	46	34
Average for drift	378	0.018	0.015	25	29

Figures 130 and 131 show the frequency of repetition of purely wind (steady current excluded) drift angles and wind factors, expressed in per cents. The results obtained indicate that random causes are excluded sufficiently well by a large number of observations.

Figure 130 shows that in 88 per cent of all cases the drift angle was positive (to the right of the wind direction) and that in 80 per cent of all cases it was between 0° and 70°. As an average of all 378 cases we found that the true drift angle was 29° to the right of the wind direction. Let us recall that Nansen obtained a true drift angle of 28° for 76 cases. This agreement undoubtedly permits us to regard the results obtained as sufficiently reliable.

Figure 131 shows that the true wind factor varies from 0.005 to 0.025. Only about 5 per cent of the cases lay outside these limits. The average of 378 cases was 0.015. According to Nansen, this factor was 0.018 for 76 cases.

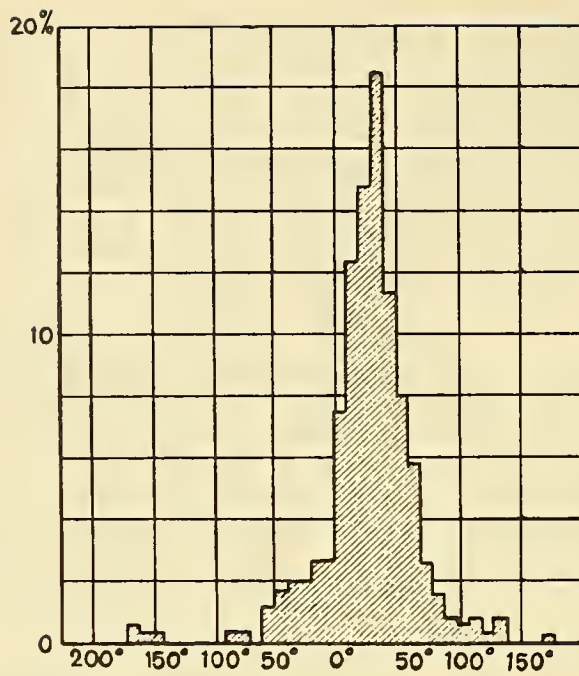

Figure 130. Frequency of repetition of purely wind drift angles during the drift of the *Sedov*.

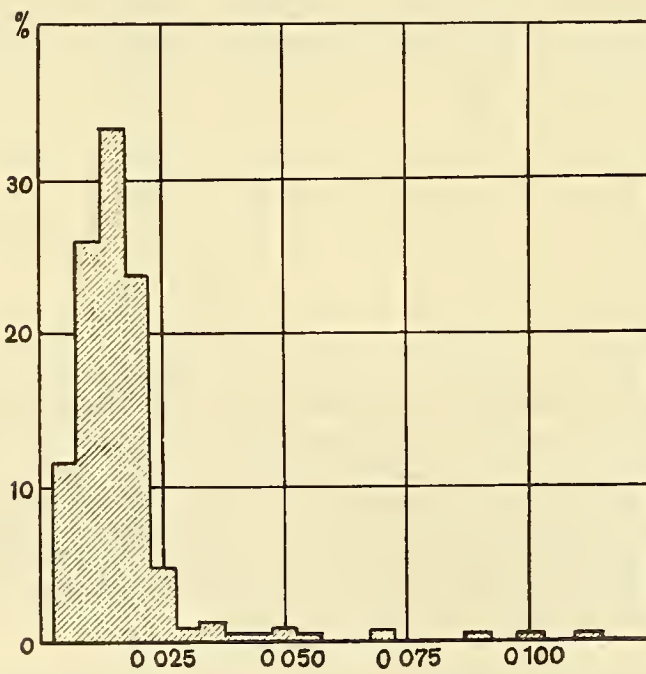

Figure 131. Frequency of repetition of wind factors during the drift of the *Sedov*.

As we see, according to Nansen the true wind factor is somewhat higher. I have already mentioned that I do not know at what height above the ice the wind observations were made on the *Fram*. It is quite natural that on the *Sedov*, where the wind measurements were made at a height of 12.5 m, i. e., at a height probably greater than the height at which the observations were made on the *Fram*, the wind speed would be greater and this would be reflected in the comparatively smaller wind factor.

Thus, rounding off and summing the data obtained by Nansen from his analysis of 76 drift segments of the *Fram* and my analysis of 378 segments of the *Sedov* drift, I find that in the Arctic Basin far from the coastline and over great ocean depths the average angle of drift is 30° to the right of the effective wind and that the drift velocity is 0.02 of the wind speed causing the drift.*

In table 102, one is struck by the small true drift angle obtained for February when the *Sedov* drifted from 85° 36' north to 86° 20' north with prevailing southerly winds. One gets the impression that during this time there was some obstacle to the north of the *Sedov* drift, obstructing its northward course. This obstacle evidently consisted of great masses of pack ice similar to the one on which station "North Pole" was established. However, this question also requires further analysis.

In conclusion one should note the following. It has already been pointed out that Nansen attributed the rightward deflection to the deflecting force of the earth's rotation. However, Nansen noted that the surface layers of water, deflected by the Coriolis force to the right in the northern hemisphere, causes a current in the subsurface layers which is deflected even farther to the right. Ekman's theory of wind currents, based on Nansen's findings, indicates that if one ignores the inclination of the sea level, the angle of deflection of a pure wind surface current is not a function of geographic latitude and is always 45°. At the same time, Ekman also developed a theoretical angle between wind and ice drift, namely;

$$\tan \alpha = 1 + 2 \nu \delta_i \sqrt{\frac{\omega \sin \varphi}{\mu \delta_w}},$$

where ν is the ice thickness, δ_i the density of the ice, μ the viscosity coefficient and δ_w the density of the water.

If we substitute in this formula $\sin \varphi = 1$, $\delta_w = 1$, $\omega = 0.0000758$, $\mu = 200$, $\delta_i = 0.9$ and $\nu = 300$ cm, we get

$$\tan \alpha = 1.162$$

*Libin informs me that the average true drift angle was 31° and the average true wind factor 0.017 in the region of operations of the N-169 expedition (80° north 183° east).

or

$$\alpha = 49.3^\circ$$

Observations made in nature show that the drift angle is actually almost 2 times smaller than Ekman's theoretical angle.

LITERATURE: 28, 30, 62, 64, 70, 72, 112, 164.

Section 134. The Combined Influence of Winds and Currents

We have seen that on an average we can assume the wind factor to be 0.02 for close ice fields. For the conversion of wind speed in m/sec into numbers on the Beaufort scale, let us take a simple but sufficiently accurate formula

$$w = 2n - 1, \quad (1)$$

where n is the wind force on the wind scale and w the wind speed in m/sec. However, 1 m/sec = 1.945 knots or approximately 1 m/sec = 2 knots. Thus,

$$c = 0.04 (2n - 1), \quad (2)$$

where c is the speed of the wind drift of the ice in knots or

$$C = 2n - 1 = w, \quad (3)$$

where C is the speed of the wind drift of the ice in miles/day.

From table 103 in which the relationships between the wind force according to the Beaufort scale and m/sec, and the wind drift speeds of the ice expressed in knots and miles/day, one can get a good picture of the influence of the wind and the sea currents (excluding currents caused by this same wind) on the drift of the ice. For example, if in a given region we observe a current (permanent, tidal, gradient, etc.) which reaches a velocity of 0.5 knots, a wind force of at least 7 will be required to cause the ice to drift against the current. On the other hand, a favorable wind will correspondingly accelerate the drift. Some observed cases of ice drift can only be explained by the above.

It has been proven that there is a steady southeast current along the Chuckchee coast with a velocity that reaches 1 knot.

TABLE 103. RELATIONSHIPS BETWEEN WIND AND DRIFT

Wind		Drift	
M/Sec	Wind Force (Beaufort Scale)	Knots	Miles/Day
3	2	0.12	3
4		0.16	4
5	3	0.20	5
6		0.24	6
7	4	0.28	7
8		0.32	8
9	5	0.36	9

Table 103. (Continued)

Wind		Drift	
M/Sec	Wind Force (Beaufort Scale)	Knots	Miles/Day
10		0.40	10
11	6	0.44	11
12		0.48	12
13	7	0.52	13
14		0.56	14
15	8	0.60	15
16		0.64	16
17	9	0.68	17

In 1942, the steamships *Molotov* and *Iskra* were caught in ice drifting with this current and the icebreaker *Stalin* was approximately the same distance from the Chuckchee Coast but 54 miles farther southeast.

From 0600 hours on 5 October through 0600 hours on 6 October, these vessels drifted parallel to the coast for 60 miles, i. e., at a rate of 2.5 knots. During this time, the northwesterly, therefore favorable, wind reached a force of 8.

Considering the velocity of the southeast current to be at least 1 knot, which amounts to 24 miles per day, and adding a wind drift of 15 miles per day according to table 103, we find that the total drift should be at least 39 miles per day. However, the velocity of the steady current was undoubtedly increased by such a strong wind. Furthermore, the surface of the ice which surrounded the vessel was very rough at that time (fragments of old ice reinforced with young ice) which created a large roughness factor and increased the wind factor. Finally, in the southeast part of the sea, that is ahead of the drift of the vessels, there was still little ice, which also increased the wind factor. This accounts for the high drift value. As soon as the wind force decreased to 3-4, the drift speed (the icebreaker *Stalin*, 6 to 10 October) decreased to 25 to 30 miles/day.

The drift of the steamship *Chelyuskin* in the same Chuckchee Sea in November of 1933 is more striking (see figure 159).

We know that the southeastern current of the Chuckchee Sea, on reaching Bering Strait does not enter Bering Strait but turns northward and joins the northern current directed from the Bering Sea through Bering Strait into the Chuckchee Sea.

On 4 November 1933, driven by a strong northwesterly wind, the *Chelyuskin* together with the ice in which it was caught was carried out of the Chuckchee Sea into the Bering Strait. After passing across the line Cape Dezhnev-Ratmanov Island (Mys Dezhnev - Ostrov Ratmanova), the northwesterly wind decreased to a force of 4-5. In this connection:

1. The wind ceased to exceed the influence of the steady northern current.

2. The reduction of the wind force resulted from a corresponding reduction of the atmospheric pressure gradient. This latter circumstance created a gradient current which intensified the steady northern current.

As a result, the ice driven from the Chuckchee Sea by a strong wind (counter to the northerly current) into Bering Strait began to return to the Chuckchee Sea and the *Chelyuskin* drifted northward against the wind 21 miles on the first day (24 hour period) and 30 miles on the second day.

LITERATURE: 38, 77.

Section 135. Drift Along the Isobars

In making a careful study of the drift of the *Sedov* toward the end of 1938, I noticed that it was always approximately parallel to the isobars on the ten day and monthly maps of atmospheric pressure distribution over the Arctic Basin.

As an example, below I give the following characteristic incidents from the drift of the *Sedov*.

From 1 November 1938, through 1 February 1939, southeasterly winds prevailed in the region of drift. The ship drifted north-northwest. The high pressure region was situated approximately east-northeast of the *Sedov* at this time. However, in individual periods the wind changed abruptly.

Figure 132 shows the position of the isobars during the first ten days of December 1938. The arrow on the map shows the general direction of drift of the *Sedov* for the ten-day period. It is clear from the figure that the ship drifted exactly along the isobars. The high-pressure region was situated above the Taimyr Peninsula at this time. The *Sedov* was under the influence of westerly and southwesterly winds and thus it drifted northeast, leaving the high pressure region to the right of it.

In the third ten days of January 1939 (figure 133), the low-pressure region was situated above the Kara Sea, while the high-pressure region was in the vicinity of the Pole. Correspondingly, the *Sedov* drifted almost directly westward.

Figure 134 shows a map of the mean monthly atmospheric pressure above the Arctic Basin for January 1939. On this map, the double arrow shows the actual drift of the *Sedov* for that month. As we see, the drift coincides exactly with the isobar.

Thus, my investigations established the following simple rule: above the deep sea, far from the distorting influence of the coast, the pure wind drift of close ice follows the isobars, and is such that the high-pressure region is to the right of the drift direction and the low pressure region is to the left.

These conclusions have been verified by Filippov, Petrichenko, Somov and others. Petrichenko and Somov, in particular, indicated that nine of the fourteen mean monthly and mean ten-day charts which they examined showed complete agreement between the direction of drift and the direction of the isobars. A subsequent examination of the charts which did not show agreement between the isobars and the drift revealed that this lack of agreement was due solely to the approximate construction of the isobars in the region of drift of the *Sedov*.

In what followed, I excluded the steady current from the drift of the *Sedov* and from an analysis of 45 ten-day pressure maps. I found the average deviation of the true wind drift from the isobar to be approximately 5° , which must be considered very satisfactory in view of the inaccuracy of the isobar plots. The direction of the isobar taken for a comparison was based on a synoptic map with an accuracy of about 10° .

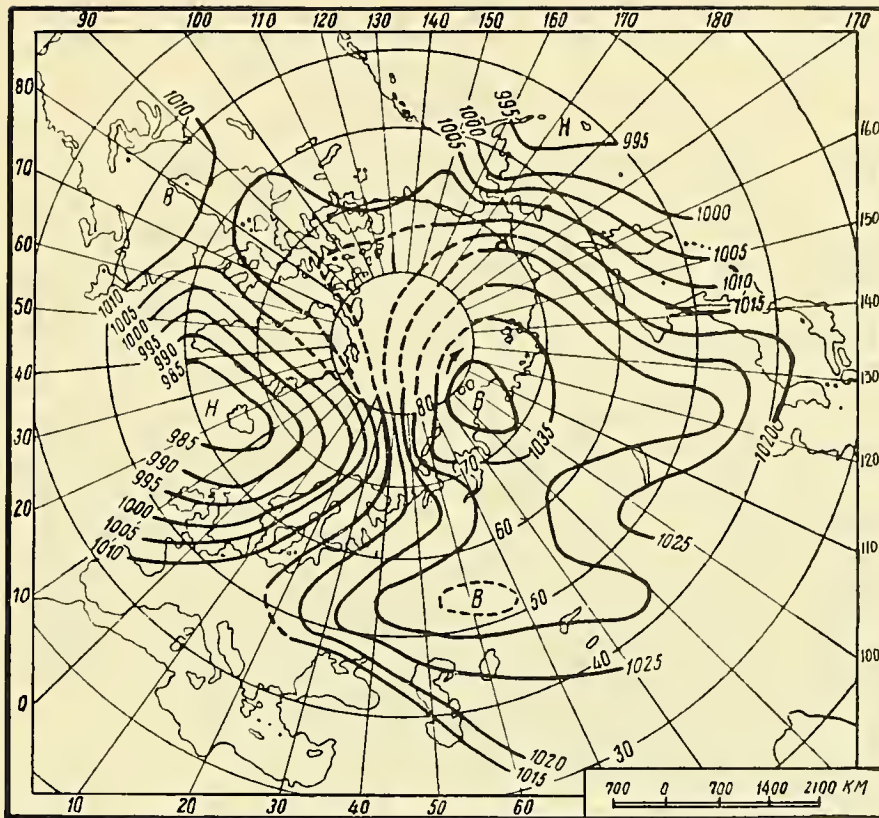

Figure 132. Distribution of atmospheric pressure over the Arctic Basin for the first ten days of December 1938.

The rule about the direction of the ice drift along the isobars, which I developed empirically, also has a theoretical basis.

We know that at heights of 500 to 1,000 m above the earth's surface, as indicated by direct observations, the wind direction coincides with the isobars (geostrophic wind). On approaching the earth's surface, the wind approximates more and more the pressure gradient because of friction with the earth's surface.

Theoretically, at the earth's surface the angle between the wind and the gradient is 45° . Consequently, if the theoretical calculations are valid, clearly the theoretically pure wind surface current and the pure wind drift of the ice should pass along the isobars, because the pure wind surface current, according to Ekman, does not depend on latitude and deviates 45° to the right of the wind direction at the earth's surface in the northern hemisphere, while the wind direction at the earth's surface, according to Taylor, deviates 45° to the left of the isobars.

Hesselberg conducted painstaking theoretical and empirical investigations of the deviation of the wind from the isobars. He pointed out that movement of the pressure systems will cause variations of the drift angle, depending on the position of the observation point with respect to the center of the given pressure system. Table 104 gives some results of Hesselberg's investigations.

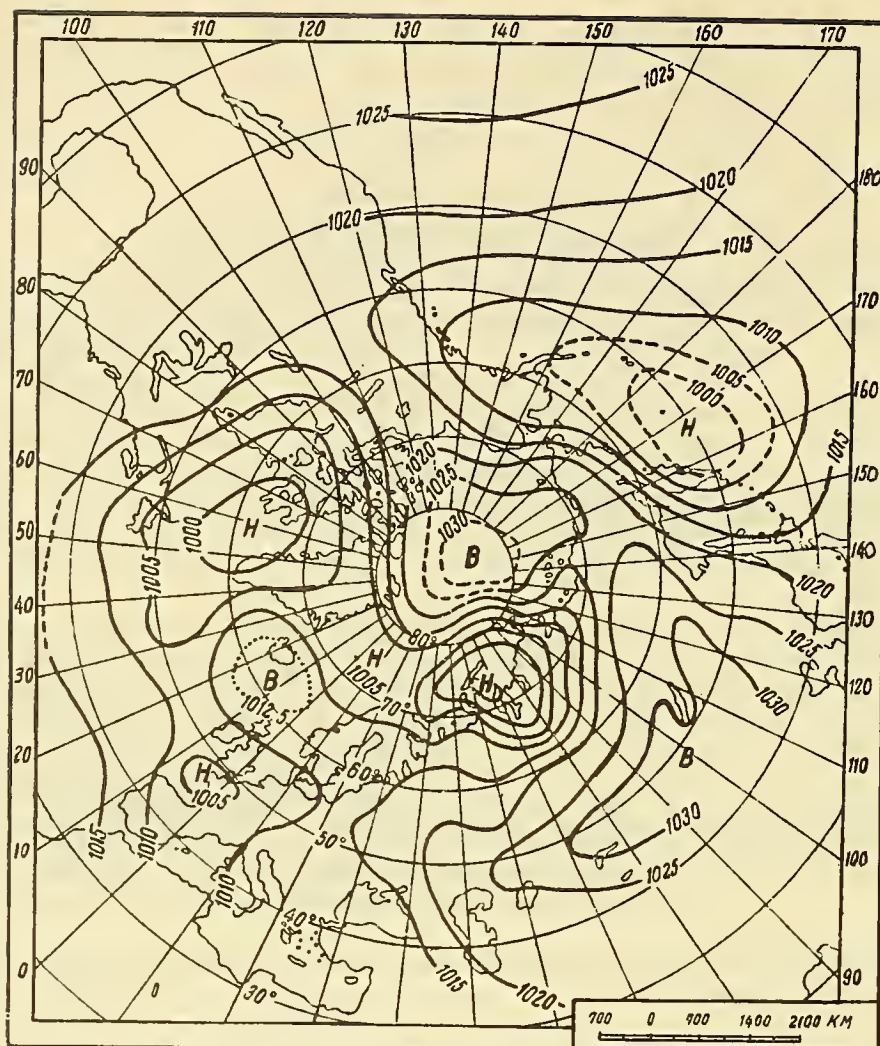

Figure 133. Distribution of atmospheric pressure over the Arctic Basin for the third ten days of January 1939.

TABLE 104. MEAN DEPARTURES OF THE WIND FROM THE ISOBAR

Region	Forward	Backward	To The Right	To The Left
Cyclone				
Inner Region	23° (22°)	62° (49°)	44° (41°)	30° (23°)
Outer Region	61° (65°)	34° (46°)	49° (60°)	44° (47°)
Anti Cyclone	48° (53°)	64° (61°)	63° (72°)	41° (43°)

In this table the drift angles obtained from processing the observations are indicated in parentheses, and the angles not included in parentheses are those computed by Hesselberg on the basis of the theoretical formula.

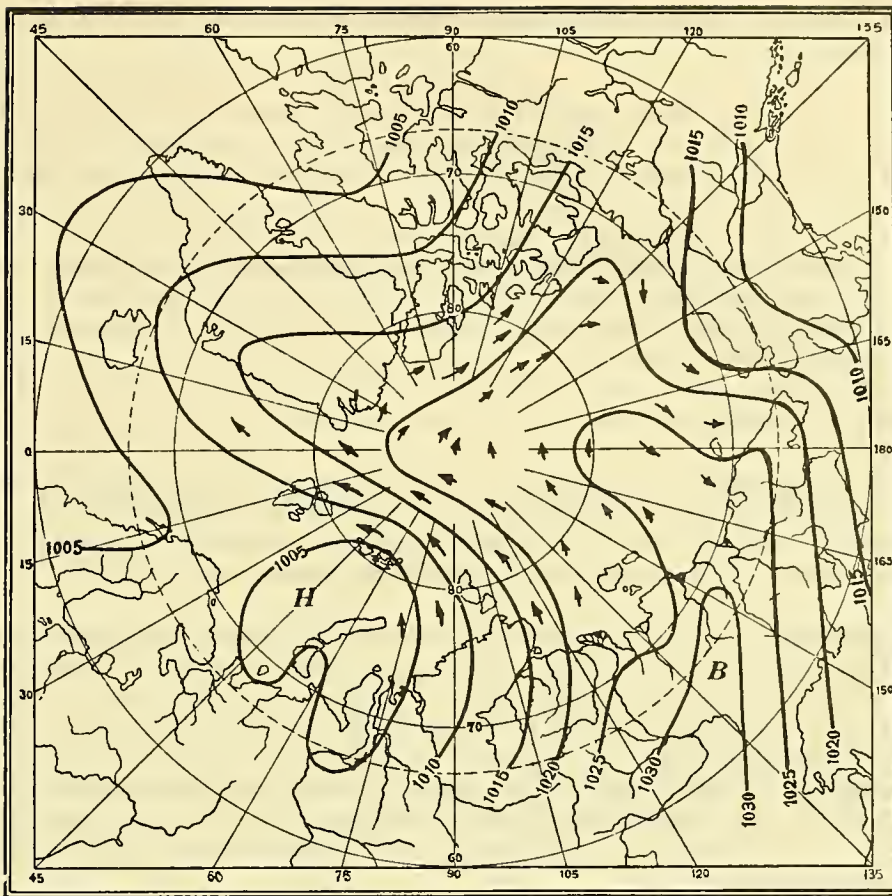

Figure 134. Distribution of atmospheric pressure over the Arctic Basin in January 1939.

On my request, Sauskan made some calculations to determine the angle of deflection of the wind from the isobar over the ice of the Laptev Sea. These computations were based on the synoptic charts and on the wind observations made on ships drifting in that sea in 1937. Based on random material (in all, 257 cases were examined), they indicated that the most probable departure of the wind from the isobar was about 35° in an anticyclone situation and about 37° in a cyclone. In the anticyclone situation the most frequent angle of deflection was between 20° and 30° , in a cyclone situation between 30° and 40° .

At the Arctic Institute, Karelin checked the departure of the wind from the isobar against daily synoptic maps. He found the average angle of deflection of the wind from the isobar, (calculated as the arithmetic mean of 1,467 observations at arctic meteorological stations), to be 24° to the left of the isobar.

We know that on regular synoptic maps the isobars are drawn with some consideration of wind direction. Therefore, it was quite proper that the Arctic Institute processed the most reliable ship observations as well as the shore observations. The ship observations did not form part of the regular synoptic maps. It was found that the mean angle of deflection of the wind from

the isobar, calculated as the arithmetic mean of 317 observations conducted on board ship, was 28° to the left of the isobar.

Let us recall that if the steady current is excluded, the mean drift angle of the ice, according to Nansen is 28° to the right, while I found an average drift angle (also excluding the steady current) of 29° in my analysis of the drift of the *Sedov*. Thus the Arctic Institute confirmed my assertions.*

It should be emphasized that the movement of ice along the isobars (in the general case, moving in space) means that at each given moment the actual drift of ice at each point in the sea is tangential to the isobar passing through the given point. Consequently, at each given moment the isobars are the flow lines of the ice drift.

LITERATURE: 64, 70, 72, 77, 84, 156.

Section 136. The Rate of Drift Along the Isobars

In 1938, after establishing the law of ice movement along the isobars, I raised the question of the relationship between the drift of ice and the pressure gradient.

We know that in the case of a geostrophic wind the pressure gradient is balanced by the Coriolis force:

$$2\omega W \sin\varphi = -\frac{1}{\rho_a} \frac{\partial p}{\partial x}, \quad (1)$$

Where ω is the angular velocity of the earth's rotation, W is the geostrophic wind velocity, φ the geographic latitude, ρ_a the air density and $\partial p / \partial x$ the horizontal gradient of atmospheric pressure.

From formula (1) we get

$$W = -\frac{1}{2\omega \sin\varphi} \frac{\partial p}{\partial x}. \quad (2)$$

If we know the conversion factor for calculating the geostrophic wind in terms of wind at the earth's surface, formula (2) would allow us to calculate the wind drift speed from ordinary pressure maps.

However, the question of the wind speed at the earth's surface is a very complex problem.

According to Brent, the wind speed at the earth's surface is about 0.7 in the case of weak winds and 0.6 of the geostrophic value in the case of strong winds. As Khromov has observed, the aerological observations in northern Europe have shown that the wind speed at the earth's surface is 0.46-0.48 of its speed at 1,000 m. Finally, as we have seen from Efremov's observations, in the layer closest to the surface of the ice, the wind speed changes so much that in the final analysis doubts arise as to just which wind speed should be considered.

As a first approximation I calculated that

$$\begin{aligned} W_0 &= 0.5 W, \\ c &= 0.02 W_0, \end{aligned}$$

*As Gordienko has reported to me, the drift of ice along the isobars has been confirmed by numerous instrument observations in the Chuckchee Sea.

Where W_0 is the wind speed at the earth's surface, c is the speed of the wind induced drift of the ice.

On this assumption, I obtained

$$c = \frac{0.01}{2 \rho \omega \sin \varphi} \frac{\partial p}{\partial x}, \quad (3)$$

and, further, considering the air density up to the height of the geostrophic wind to be constant and equal to 0.0013, Somov and I obtained the following for the Arctic Basin

$$c = 13,000 \frac{\partial p}{\partial x}, \quad (4)$$

Where c is the average drift of ice fields in kilometers per month; $\partial p / \partial x$ is the pressure gradient expressed in millibars per kilometer and taken from the monthly pressure map.

These considerations led me to formulate one more simple rule, namely: over the deep sea, far from the distorting influence of the coast, the speed of pure wind drift of close ice is directly proportional to the atmospheric pressure gradient and thus it is inversely proportional to the distance between the isobars drawn through the same pressure intervals.

It seems to me that my laws of the relationship between ice drift, the direction of the isobars and the magnitude of the pressure gradient are a considerable step forward compared with the relationships between ice drift and wind which have been studied heretofore. Of course, in the cycle--pressure gradient creates wind, wind creates drift--it is most difficult and controversial to determine the wind elements (direction and speed), values which change greatly depending on the height at which the observation is made above the ice field. The laws which I have proposed exclude the wind elements which are difficult to determine from the examination and allow one to concentrate on the study of the departures from these rules caused by local conditions.

LITERATURE: 19, 67, 70, 72, 77, 135.

Section 137. Comparison of the Computed and Observed Drifts

As we have seen, the coefficient 13,000 in formula (4) of section 136 is highly arbitrary and calculations have shown that it is too high. The only way to make it more exact is to compare drifts computed from formula (4) with account taken of the steady current, and the observed drifts.

Such calculations were made at my request by Somov for the drifting station "North Pole", the icebreaker *Sedov* and the ship *Lenin* from the moment their drift began.

Figure 135 shows the results of the computations. The dashed line indicates the computed drift, the solid line the true drift, and for convenience in comparison the true drift is also shown as total movements for the month. The computed drift was based on mean monthly pressure maps for the northern hemisphere compiled by the Central Weather Institute (1938 and 1939) and by the Interdepartmental Bureau of Ice Forecasting (for 1937). The direction of the isobars was taken from the pressure chart with accuracy up to 10 per cent.

It should be noted that the isobar plots on the mean monthly pressure charts are very approximate, especially in the central part of the Arctic Basin. Nevertheless, the calculated and observed drifts of the *Sedov* agree well, despite the unavoidable accumulation of errors inherent in sequential computation of a theoretical drift. This agreement of the results of the observed two

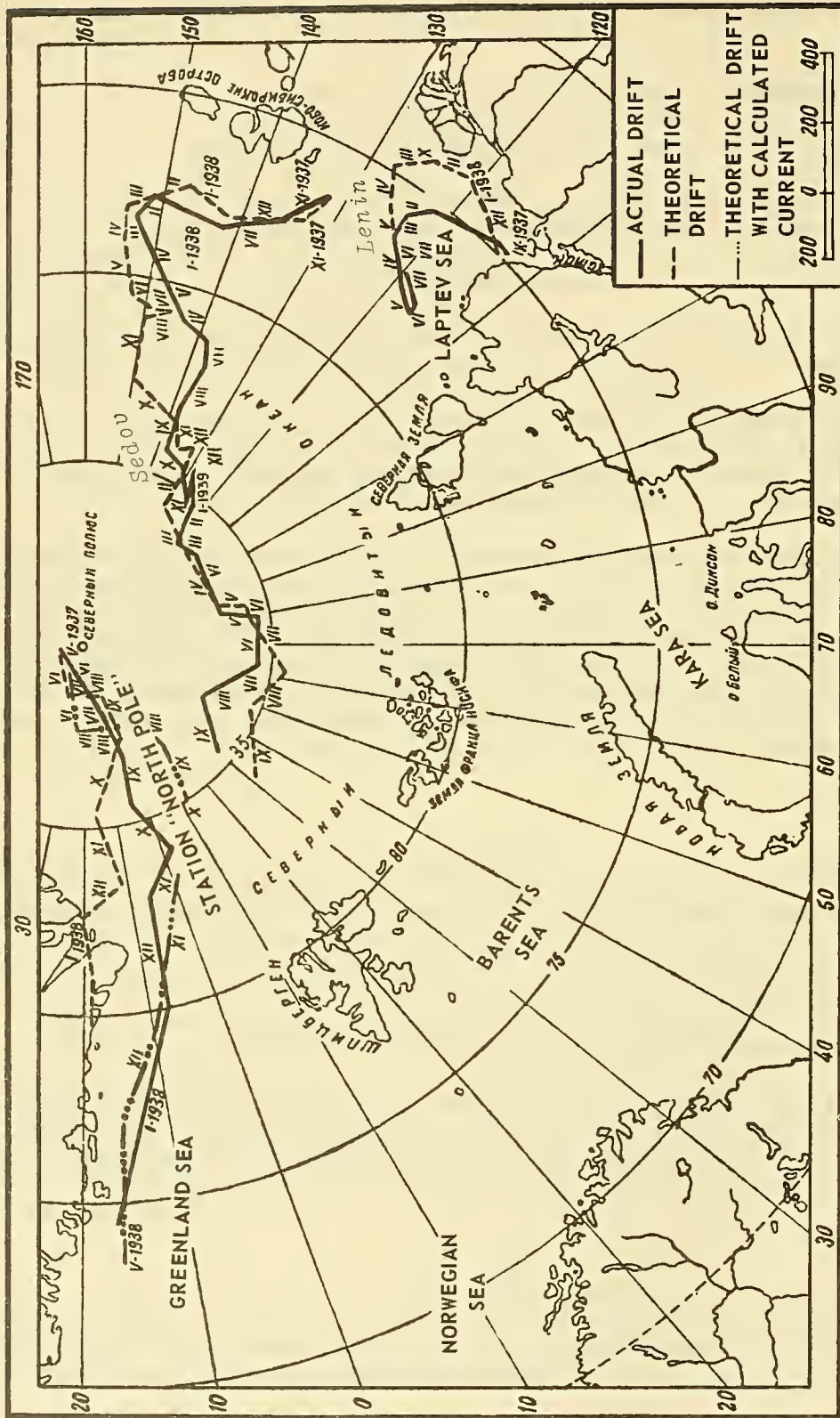

Figure 135. The computed and the observed drifts of station "North Pole," the *Sedou* and the icebreaker *Lenin*.

year drift and the calculated drift shows that the errors in calculating the individual monthly movements were not of a systematic nature, i. e., they were not in the method, but were chance errors caused merely by the inaccuracy of the initial material and the approximate nature of the calculations.

The objectivity of the results obtained proves that the compilers of the mean monthly pressure maps, which are based on calculations, had no idea that these maps would be used to compute drifts. Furthermore, one might say that the isobars on the daily synoptic maps are drawn with consideration of wind direction and thus the agreement between ice drift and direction of the isobar is taken into account in advance, but this objection does not apply to the mean monthly and mean ten-day pressure maps, because the isobars on such maps are drawn only with respect to the average pressure, without consideration of wind.

The complete agreement between the final points (plotted on the chart) of the calculated and observed drift of the *Sedov* indicates that the coefficient assumed in the calculations was approximately 20 to 30 per cent too high. Actually, the drift of the *Sedov* was not purely a wind drift and the steady current carried the *Sedov* westward at a rate of approximately 25 miles per month. This circumstance must be kept in mind in further considerations.

An examination of figure 135 shows that the computed drifts of the station "North Pole" (dashed line) and of the icebreaker *Lenin* depart considerably from the observed drifts. This does not indicate that the established relationship between the distribution of pressure and the drift elements is inaccurate, but rather, it confirms the relationship. Actually, all that has been said applies to drift which is practically unaffected by the coastline, the bottom relief and powerful steady currents. These factors were taken into account to a certain extent during the drift of the *Sedov*, but not during the drifts of station "North Pole" and the icebreaker *Lenin*.

Powerful steady currents, basically north to south, were observed in the drift region of the station "North Pole". It is quite natural that under such circumstances the calculated drift would not coincide with the actual drift, which consists of pure wind drift created by local winds and the drift caused by steady currents.

Figure 135 shows the drift of the station "North Pole" (dash dot) calculated by the method outlined above, but with the introduction of a correction for the steady current (taken from table 105) in every monthly movement. Table 105 was compiled on the basis of the data of station "North Pole".

TABLE 105. ELEMENTS OF STEADY CURRENTS IN THE DRIFT REGION OF STATION "NORTH POLE"

Month	Mean Coordinates		Current Elements	
	Latitude	Longitude	Direction	Velocity In Miles/Day
(1937)				
May-June	89° 00'	20° W. L.	160°	1.4
July	88 10	10° W. L.	95	2.2
August	87 30	5° W. L.	180	1.2
September	78 50	8° E. L.	185	5.0
October-November	86 10	0° E. L.	155	1.2

Table 105. (Continued)

Month	Mean Coordinates		Current Elements	
	Latitude	Longitude	Direction	Velocity In Miles/Day
December	84° 00'	5° E.L.	180°	2.2
January, 1938	81 20	6° E.L.	180	3.4

The calculated drift corrected in this way agrees with the observed drift, although the discrepancies which appear indicate that the coefficients are somewhat too high.

In the case of the drift of the *Lenin*, the nature of the discrepancies clearly indicate that the decisive role here was played by the immediate proximity of the coastline. Actually, during the entire winter the observed drift deviated to the left of the computed drift, namely in the direction in which it should have deviated with a coastline to the right. Possibly, in this case the shoals also played a part. It is quite probable that the rule of ice drift along the isobars is not fully applicable to ice over shoals. It is easy to show that if the shoals did have a substantial influence on the direction of wind drift, it would deflect the drift to the left of the isobars.

It has already been noted that figure 135 was constructed without consideration of the steady current in the drift region of the *Sedov*. After the elements of the steady currents in the drift region of the *Sedov* had been computed, it appeared that there was some possibility of determining the coefficient which connects the speed of pure wind drift with a distance between the isobars by empirical methods. I did this for the ten-day pressure maps, and on an average of 35 cases examined I found:

$$c = \frac{1000}{x},$$

where c is the pure wind drift of ice fields (steady current excluded), expressed in miles/ten days; x is the distance in miles between the isobars on the ten day pressure charts, drawn every 1 mb.

It should be emphasized that 37 cases are too few to establish a sufficiently reliable factor of proportionality between the pressure gradient or the distance between isobars and the speed.

In view of this, I feel personally that the law of movement along the isobars (in the deep part of the Arctic Basin at any rate) may be considered sufficiently proven, but further data are required to determine the factor of proportionality between the pressure gradient and the drift speed.

Thus, I suggest that the maps of computed and observed drift given here as well as other maps constructed on the basis of these formulas should be examined merely as an application of a new method and an indication of the possibilities offered by this method. Further, although the schemes obtained on the basis of the proposed method cannot be regarded as having an absolute value, the relative data obtained by the new method certainly merits attention.

It should be noted that attempts at a practical application of this method for short range ice forecasting have already been made and have yielded positive results. For example, in the summer of 1940 Ovchinnikov successfully traced the movements of ice edges in the Kara Sea, using the law of movement of ice along isobars and calculating the ice drift speed from the atmospheric pressure

differences at the various polar stations. In the winter of 1941-1942, Somov successfully traced the wind drift of ice masses in the White Sea, using both my laws and my coefficients.

The following may serve as an example of the possibilities of employing my method. On 27 March 1943, during a flight north of Rudolf Island (Franz Joseph Land), the navigator of the plane *Padalka* reported that dozens of icebergs were sighted between 84° and $84^{\circ} 30'$ north, the number of icebergs decreased westward. However, in 1937, during several flights not a single iceberg was seen in that region and in general no icebergs were sighted on the meridian of Rudolf Island (Ostrov Rudol'fa) thus the question arises: from where did the icebergs come?

At my request and upon my suggestions, Karelin solved the problem by the "reverse approach," namely: knowing the end point, he calculated the initial point on the isobar charts. He found that the icebergs were brought from the west coast of Severnaya Zemlya. In his calculations, Karelin did not consider the steady surface current which carried the *Fram* and the *Sedov* from east to west. If he had done this, undoubtedly his calculations would have shown that these icebergs were brought from regions adjacent to the east coast of Severnaya Zemlya, where large accumulations of icebergs are observed some years.

LITERATURE: 67, 70, 72, 77.

Section 138. The Drift of Ice During the Passage of Pressure Systems*

During the passage of pressure systems, the wind at one in the same point on the earth's surface changes speed and direction continually. In this connection, the wind drift of ice also changes correspondingly. The cyclone is the most sharply defined pressure system. Let us examine the influence of the passage of a cyclone on the movement of ice in the northern hemisphere, and let us make the following simplifying assumptions:

1. The isobars in the cyclone are circular.
2. The ice drifts along the isobars at a velocity proportional to the pressure gradient.
3. The ice floes are free to move in any direction and have no inertia (they begin to drift soon after they enter the cyclone region and they stop drifting as soon as they leave this region).

Figure 136 shows the drifts of ice floes which are equidistant at the initial moment of drift and on a line perpendicular to the cyclonic motion. The pressure is the same throughout the cyclone region. The cyclone is moving at a constant speed. The drift speed of the ice floes is assumed to be $1/25$, $1/10$, $1/5$ and $1/2$ of the rate of movement of the cyclone.

Figure 137 shows a more complex case. It is assumed that the pressure gradient in the cyclone region varies according to the law depicted in this figure. The speed of the ice floe drift, varying according to this same law, becomes so small at a certain distance from the center of the cyclone that in practice it can be neglected.

Figure 138 shows the curvature of the lines parallel and perpendicular to the path of the cyclone and equidistant at the initial moment. It is proposed that the isobars of the cyclone are

*This section was written after the book had been submitted to the printer, thus, not all the conclusions were reached which might have been reached in a more thorough treatment and the conclusions reached were not formulated precisely.

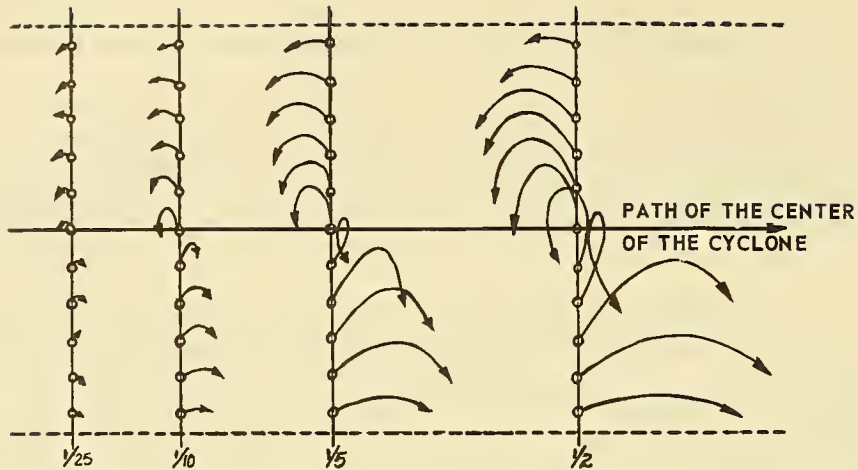

Figure 136. Schemes of the drift of ice floes during the passage of a cyclone with circular isobars and with a constant pressure gradient.

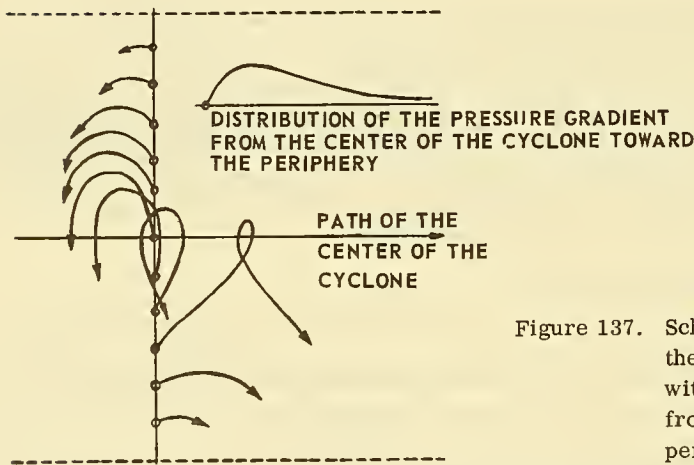

Figure 137. Scheme of the drift of ice during the passage of a circular cyclone with pressure gradients changing from the center toward the periphery of the cyclone.

circular, the pressure gradient constant. The curvature of the lines is shown for the moment when the center of the cyclone, moving from left to right, reaches point 0. The curve *ACB* is the most probable curvature of the line perpendicular to the path of the cyclone, after the passage of a cyclone of given force and velocity. Figure 138 gives an idea of the direction and the strength of the forces acting on the ice during the passage of the cyclone. At points where these lines converge, we should expect hummocking; at points where they diverge we should expect scattering of ice.

An examination of the figures will show that despite complexities the drifts of the individual ice floes during the passage of cyclones of various structure and moving at various speeds, do obey certain laws, namely:

1. The slower the movement of the cyclone, the more complex and the longer are the paths described by the ice floes.

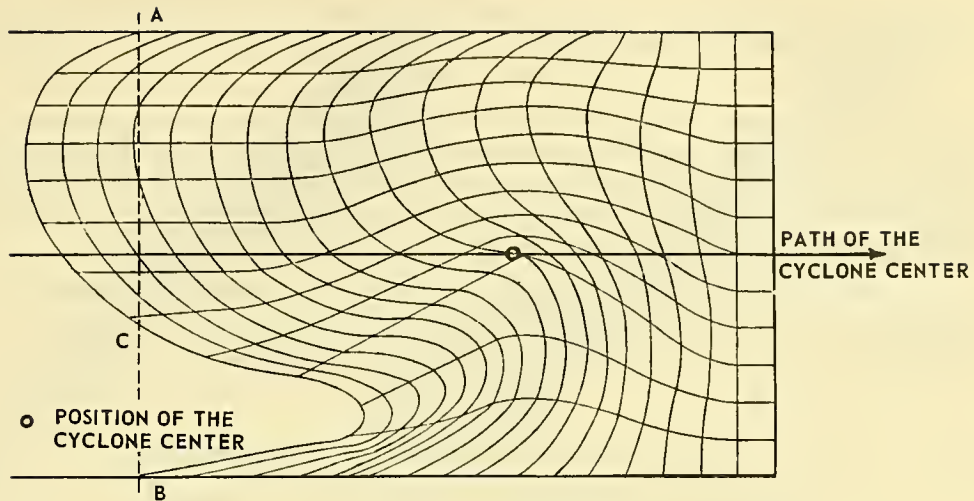

Figure 138. Curvatures of lines perpendicular and parallel to the path of the cyclone.

2. All floes describe trajectories whose directions of convexity lie to the right of the path of the cyclone.

3. All left-hand floes (to the left of the cyclone path at the initial moment) and some of the right-hand floes (to the right of the path of the cyclone at the initial moment) describe counterclockwise trajectories; and remaining floes follow clockwise trajectories. The slower the cyclone movement, the greater will be the number of floes which describe counterclockwise trajectories. In the case of a stationary cyclone, all floes will describe counterclockwise trajectories.

4. Before the center of the cyclone crosses the initial line of the floes, all floes move upward (according to the orientation of the figures) and then they begin to move in the opposite direction. In this connection, when the center of the cyclone approaches the initial line of the floes, concentration occurs on the left side of a cyclone path and scattering on the right. After the cyclone center passes over the initial line, the floes begin to move in the opposite direction and after passing through the entire cyclone region they are almost the same distance from the center of the cyclone as at the initial moment.

5. The displacements of the floes in a direction perpendicular to the path of the cyclone are considerably smaller than their displacements parallel to the path of the cyclone. From figure 138 it is evident that the horizontal distances between the left-hand floes gradually increases during the passage of the cyclone and consequently a right-to-left scattering of the ice occurs to the left of the cyclone path. On the other hand, the horizontal distances between the right-hand floes decrease more and more as the cyclone passes over, which inevitably leads to a concentration of the ice and also to hummocking when the ice floes become sufficiently close packed. Here, as can be seen from figure 138, a ridge of hummocks forms in connection with the passage of the cyclone and moves from left to right at a rate equal to the rate of movement of the cyclone. Other conditions being equal, the slower the cyclone moves, the larger this ridge will become. Thus, during the passage of a cyclone the left-hand ice fields break up and their parts scatter, while the right-hand ice fields hummock.

6. Since ice floes move in different directions even when their drift speed is the same (see figures 136 and 138), they rotate when they come into contact with each other. Of course, rotation of the floes is even more certain when the floes move at different speeds (figure 137).

7. If the individual ice fields are so large that one must consider the difference in the wind direction at their edges, the fields will rotate as follows, as is evident from an examination of the figures: floes situated both to the right and to the left but near the path of the cyclone center will move counterclockwise, those situated on the periphery of the cyclone region and to the right and left of the path of the cyclone center will move clockwise.

8. As can be seen from figure 138, which depicts the curvatures of equidistant lines parallel and perpendicular to the movement of the cyclone at the initial moment, there are three main directions of movement of the floes (on the map) during the passage of a cyclone:

- 1) Upward.
- 2) From right to left in the upper region of cyclone influence.
- 3) From left to right in the lower region of cyclone influence.

Reduction of the horizontal distance between scattered floes may be expressed only in concentration. However, if the ice is close-packed and thick enough so that the wind characteristic of the cyclone can produce only slight hummocking, the floes which are already in the cyclone region, on drifting from left to right, will encounter floes before them which have not yet entered the cyclone region. Thus, floes may be set in motion and begin to hummock long before the wind begins. This phenomenon, hummocking preceding a wind, has frequently been noted by polar researchers (see Section 95).

The phenomena in the region above the sphere of influence of the cyclone may prove to be still more interesting. Here, under these same conditions (great concentration and thickness of the ice, limiting intense hummocking) ice drift and hummocking may occur during a complete still. Such cases have also been observed frequently by polar researchers.

Thus far we have examined the movement of ice during the passage of a cyclone over an unlimited ice area.

Let us assume that the vertical dashed line AB (on the left) in figure 138 is the edge of ice before the passage of the cyclone. Of course, after the passage of the cyclone the position of this ice edge will be depicted by the extreme left-hand curve of figure 138. In section AC , the ice edge will be scattered, while in section CB it will be concentrated.

Now let us assume that the path of the circular cyclone with a constant pressure gradient intersects a straight channel filled with ice at an angle of 45° (figure 139). Naturally, in this case the movements of the floes will be restricted by the coastline and this will intensify the scattering effect in some places and the hummocking in others. Let us assume, further, that during hummocking the length of the ice fields in the direction of movement of the cyclone and at the wind force characteristic of this cyclone will not be reduced by more than $1/4$.

Figure 139 shows the path of the center of the cyclone, the limits of its influence, the regions of compression and scattering of the ice and also the direction of rotation of the ice fields. By modifying the position of the coastline and the directions of the cyclone paths relative to it one may approximate natural conditions. Under the given assumption, even a case as schematic as the one depicted in figure 139 can be applied, for example, to the Kara Sea. If the paths of the cyclone centers move from west to east somewhere in the region of Cape Zhelaniya (Mys Zhelaniya), the

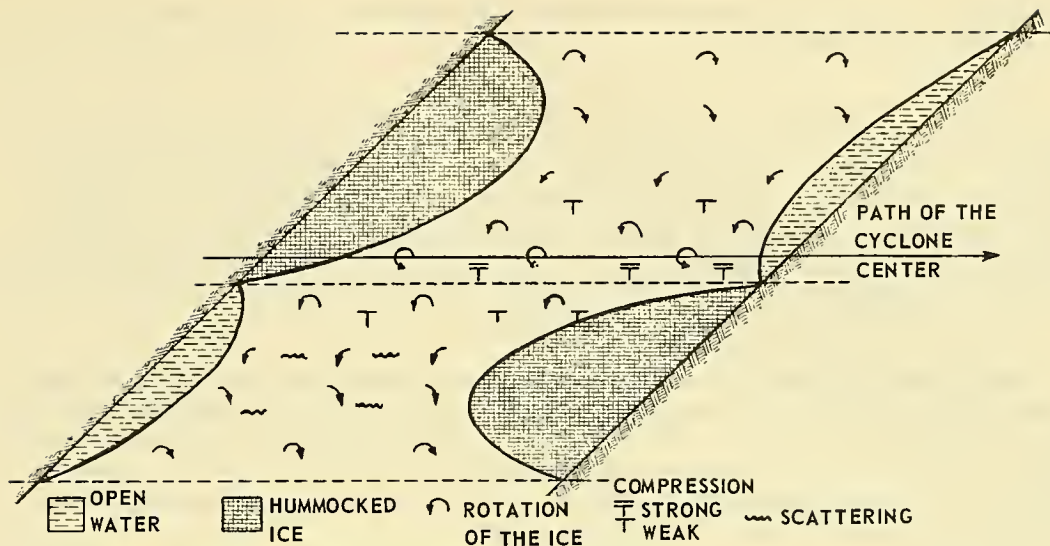

Figure 139. Diagram of the position of regions of hummocking, *polynyas* and rotation of the ice during the passage of a cyclone over a rectangular channel.

Novaya Zemlya lead will result. If the paths of the cyclone centers pass approximately along the parallel of Yugorskii Shar, the Yamal lead will form, etc.

In such calculations, one must remember that the ice edges will not move toward the shore or the shore ice at the same rate of speed, given the same wind force, because of compaction and hummocking. For example, considerably less time is required to bring ice from a concentration of 5/10 to 6/10 than is required to bring it from a concentration of 8/10 to 9/10. Of course, the same thing applies to hummocking. It seems reasonable to assume that these phenomena follow the logarithmic law, but thus far we have no supporting observations.

LITERATURE: 77.

Section 139. The Drift of an Isolated Ice Floe

As direct observations have shown, individual icebergs, floes, and small ice fields may drift at a speed as great as 1.5 knots or 80 cm/sec and more during fresh winds, i. e., the wind drift speed of isolated floes and fields may be 2 to 3 times greater than the velocity of the wind-driven current which forms simultaneously.*

In 1935 to 1937, Shestiperov, observing the wind drift of ice floes in the Chuckchee Sea by means of a theodolite set up on Cape Schmidt (Mys Schmidt) at an elevation of 48 m above sea level, noted that the mean wind factor during winds which blew along the coast (in either direction) varied

*On an ice-free sea the energy of the wind acting on the surface of the sea is expended on the formation of waves, on mixing, the formation of currents and the heating of the sea. Where there is an ice cover, the wind energy is not expended on the formation of waves, and thus there is less mixing. However, the uneven surface of the ice offers high resistance to the wind, which explains the relatively rapid drift of the ice.

from 0.035 to 0.040. The maximum speeds of the floes observed at the same wind force gave a wind factor of 0.08 - 0.10.*

In individual cases the wind drift of ice may be considerably stronger than this. For example, Lavrov pointed out that on 2 July 1928, the icebreaker *Malugin* caught in the ice of the north-western part of the Barents Sea drifted westward (toward Ostrov Nadezhda) at a rate of 1 knot under an easterly wind of force of 6-7. When the wind, maintaining a force of 6-7, changed to northerly, the *Malugin* together with the ice moved along Ostrov Nadezhda at 3-4 knots and at a distance of 3 or 4 miles to the south of this island (toward the open sea). Calculations of the southward drift yielded a wind factor of 0.15. Probably this intensive drift of ice was not purely wind drift. Nevertheless, these figures are striking.

I have made the following assumptions to arrive at an approximate solution of the problem of the wind drift of an isolated ice floe. First, I have assumed that in the beginning the wind drives the ice floe but the water remains immobile. Thus, at first I examine only the actual wind drift of the floe. This assumption is based on the following: direct observations have shown that an individual floe is set in wind motion at a considerably greater rate of speed than the wind current would allow and that subsequently it moves even faster.

Furthermore, the wind current in the sea is not created immediately. Struiskii has shown (on the basis of 2836 observations of winds and currents in the Caspian Sea) that frequently there are no currents even during quite strong winds, and sometimes there are currents that run counter to the wind.

This is explained by the inertia of water masses and chiefly by the presence of residual currents.

The second assumption I have made to simplify the problem concerns the form of the ice. Actually, since the above water part of a floe is subject to wind action while the underwater part of the floe is subject to the resistance of water, in our theoretical treatment we can select the form of the underwater and above-water parts of the floe such that the floe can move in various directions with respect to the wind, as a sail, set in different ways, can move a sailing vessel in various directions. Therefore, let us select a floe shape which will be indifferent with respect to a sail and resistance of water, namely a cylinder with a vertical axis.

If we assume that the water is immobile and that the drift will occur after a certain time interval, three balancing forces will act on the floe: F -wind pressure, R -hydrodynamic resistance in the direction opposite that of the drift and K -the Coriolis force directed (in the northern hemisphere to the right of the drift) perpendicular to the drift, in other words perpendicular to force R (figure 140).

Under such assumptions, the drift angle can be obtained from the formula:

$$\tan \alpha = \frac{K}{R} . \quad (1)$$

The Coriolis force is:

$$K = m 2\omega c \sin \varphi = \delta_i \pi r^2 h 2\omega c \sin \varphi \quad (2)$$

*Once, during a strong wind, an isolated floe was observed to drift at a speed of 120 cm/sec or 2.33 knots (wind factor 0.12).

where ω is the angular velocity of the earth's rotation, φ the geographic latitude, c the drift speed, $m = \delta_i \pi r^2 h$ the mass of the floe, δ_i the density of the ice, r the radius of the base of the floe and h the height of the floe.

The hydrodynamic resistance to the movement of the floe can be divided into three parts: 1) wave, 2) drag and 3) surface resistance.

I neglect the wave resistance, since the speed of the ice drift with respect to the water is small. The drag coefficient may be considered proportional to the vertical area cross-section of the underwater part of the floe and the second power of the drift speed of the floe. Since even in the case of icebergs the vertical dimensions of the underwater part are negligible compared with the horizontal dimensions, I have also neglected the drag resistance in the first approximation.

The surface resistance is also proportional to the surface of the interface water-ice and the second power of the speed. For a cylindrical floe we may consider the surface resistance to be:

$$R = k \pi r^2 c^2, \quad (3)$$

where πr^2 is the area of the base, k is the proportionality factor and c the speed.

Substituting formulas (2) and (3) in formula (1), we get

$$\tan \alpha = \frac{\delta_i \pi r^2 h}{k \pi r^2 c^2} 2\omega c \sin \varphi = A \frac{h}{c} \sin \varphi, \quad (4)$$

where A is a proportionality factor.

From this formula it follows that

1. The drift angle of the actual wind drift of the floe is a function of geographic latitude, reaching its maximum at the pole.
2. The drift angle increases with increasing vertical dimensions of the floe.
3. The drift angle decreases as the drift speed of the floe increases; since the drift speed of the floe is a function of wind speed, the stronger the wind is, the smaller the drift angle of the floe will be.

The speed of the actual wind drift of the floe, of course, is a function of the "sail power" of the floe, in other words it is a function of the ratio of the heights of the underwater and above-water parts of the floe. Direct measurements of the actual wind drift of icebergs, made by the International Ice Patrol off Newfoundland, give the following drift speeds of isolated icebergs (table 106) in miles per day, given in cm/sec in parentheses, according to Smith.*

From table 106 it is evident that Smith considers the true wind drift speed of the ice to be about directly proportional to the ratio of the above-water height of the iceberg to the underwater part and, furthermore, proportional to the wind speed. Taking the average wind force of 4 to 5 to be 7.5 m/sec and a wind of force 6-7 to be 12.5 m/sec, I computed the wind factors given in table 107 on the basis of Smith's table.

*In this table Smith has ignored the influence of the current. Furthermore, here and elsewhere in his discussions Smith does not consider the Coriolis force; in other words, he considers the actual drift speed of the ice to be governed by the wind. The last line of the table refers to the wind drift of a vessel off Newfoundland.

TABLE 106. SPEED OF PURE WIND DRIFT OF ICEBERGS

Ratio of the Underwater to the Above-Water Parts of the Iceberg	Wind Force	
	4-5 Points	6-7 Points
5	1.5 (3.2)	2.3 (4.9)
4	1.8 (3.9)	2.8 (6.0)
3	2.2 (4.7)	3.7 (7.9)
2	3.7 (7.9)	5.7 (12.2)
1	7.3 (15.6)	11.3 (24.2)
0.7	11.0 (27.5)	17.0 (36.4)

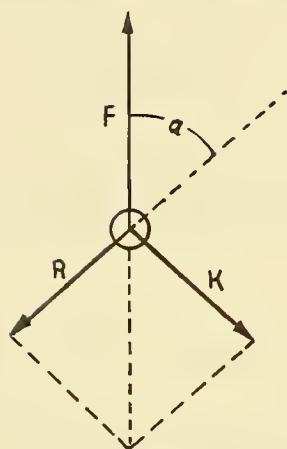

Figure 140. Pure wind drift of a cylindrical floe.

TABLE 107. THE WIND FACTORS OF ICEBERGS OF VARIOUS DISPLACEMENTS

Ratio of the Underwater to the Above-Water Height of the Iceberg	5	6	3	2	1
Wind factor	0.004	0.005	0.006	0.010	0.020

Now let us assume that the iceberg actually drifts in the wind current. Of course, an iceberg will be carried along by this current at an average velocity corresponding to its underwater and above-water contours.

The velocity of the wind current, as follows from Ekman's theory, decreases very rapidly with depth and in the high and middle latitudes at a depth of 50 to 100 m it reverses its direction, becomes practically zero. Thus, the deeper an iceberg sits in the water, the slower will be the drift speed imparted by the current and the more it will be deflected to the right.

Thus, according to Smith's computations, a wind of force 6 to 7 will establish a wind current to a depth of 100 m in 1 to 2 days, and the average current at a depth of 40 m will move in a direction 72° to the right of the wind and at a velocity of 5.3 cm/sec.

Below I give a selection from Smith's computations for a wind force of 6 to 7 (table 108).

TABLE 108. ELEMENTS OF THE WIND DRIFT OF ICEBERGS, WITH A WIND FORCE OF 6 TO 7

Ratio of Under-water Part of Iceberg to Height	Actual Speed of Drift Icebergs With Wind in Cm/Sec	Velocity of Movement With the Current in Cm/Sec	Resultant in Cm/Sec	Drift Angle
From 3 to 5	5.3	6.4	9.2	40°
From 1 to 2	18.0	7.9	21.8	29

As Kireev points out, the wind factor for vessels standing broadside is almost independent of the wind speed and is 0.063 for ships drawing <3 m; 0.056-0.040 for a ship drawing 3 to 7 m and 0.038-0.036 for a ship drawing more than 7 m drift.

Individual floes react differently to the wind. Small floes are quickly set in motion as the wind begins. Large floes, especially deep riding floebergs and icebergs, remain at rest or retain their residual motion for long time intervals.

Thus, in a wind current, the current action has the following consequences:

1. The lower the floe rests in the water, the greater the angle of drift of the floe from the wind direction and the surface current.
2. The smaller the underwater portion of a floe, the greater its drift speed.

The wind action has the following effect:

1. The smaller the ice floe is and the smaller the ratio of the underwater part to the total height, the faster the floe will move.
2. The greater the drift speed of the floe and the greater the wind speed, the smaller the drift angle.

From these assumptions it follows that the total drift of floes caused by the wind current and the wind is as follows: the greater the underwater portions of the floe are and the greater its size, the slower its drift speed and the greater the drift angle. In other words, the deeper the floe rests in the water and the greater the size of the floe, the more it will be subject to the influence of steady currents and wind currents, and the smaller the underwater portion of the floe and the size of the floe, the greater will be the direct influence of the wind.*

In examining the actual wind drift of isolated floes, I assumed that the floes were cylindrical with a vertical axis. Now let us assume that scattered floes are elliptical in the horizontal plane,

*Gordienko has informed me that these simple assumptions have been confirmed by instrument observations in the Chuckchee Sea.

which is closer to the facts observed in nature. Actually, as we have seen, individual floes, experiencing constant collisions, gradually assume a more or less regular oval shape.

For simplicity's sake, I propose that at the moment the wind begins to act on the floe only two forces are operative: the motive force of the wind F and the hydrodynamic resistance R (figure 141). These forces are opposite in direction, and are applied to the corresponding centers of the lateral surfaces of the floe. In the general case, they are applied at an angle to the surfaces.

Dividing each of these two forces into their components, one perpendicular and the other parallel to the lateral surface of the floe and neglecting the influence of the forces slipping along the lateral surfaces of the floe, we get a pair of forces that strive to rotate the floe such that the wind pressure and the resistance of the water will be parallel to the minor axis of the floe.*

For the same reason, a ship with its motor stopped stands broadside to the wind.

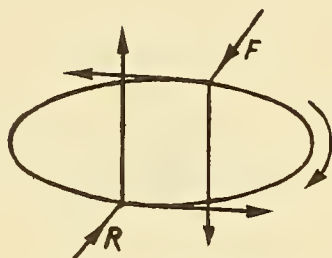

Figure 141. The rotation of an elliptical ice floe due to wind action.

Thus, when the wind begins, at first, each floe rotates and then begins to move.

LITERATURE: 56, 59, 62, 77, 86, 94, 117, 127, 171.

Section 140. The Drift of Scattered Ice

The drift of scattered ice depends on the concentration of such ice and accordingly can approximate the drift of close pack ice (in which the form of the individual floes is unimportant) or the drift of an isolated floe (in which the form plays a very distinct role).

As we have seen, floes of various sizes drift at various speeds and at various angles to the wind even when their external form is identical. The motions of individual floes which differ sharply in size and shape differ even more. This greatly complicates the investigation of the drift of more or less scattered ice, where one must consider the collisions of floes.

Sverdrup, in analyzing his observations of the wind drift of ice in the East Siberian Sea during the expedition on the *Maud* (1922 to 1924) and the observations of Brennecke in the Weddell Sea (1911 to 1912), concluded that the following forces determine the speed and direction of ice drift after the motion has become steady:

1. The friction between air and ice direction with the wind.

*If the forces were parallel to the major axis of the floe, the equilibrium would not be stable.

2. The Coriolis force, directed perpendicular to the drift and proportional to the drift speed and the mass of the ice.
3. The friction between ice and water.
4. The internal resistance of the ice caused by the collision of individual ice floes moving differently. Sverdrup assumes that this force is proportional to the drift and acts in a direction opposite that of the drift.

Two approaches may be used to solve the problem.

First, the ice may be regarded as a thin film which moves together with the surface waters. Consequently, the mass of the ice and therefore the Coriolis force acting on the ice can be ignored. In this case, the problem is solved by determining the elements which cause the water-ice friction. This force may be calculated from the wind speed, because in the case of steady motion the three forces, air-ice friction, ice-water friction and the internal resistance of the ice should balance. Sverdrup used this approach to analyze Brennecke's observations in the Weddell Sea on the drift of thin scattered ice.

Using the second approach, one may neglect the force of the ice-water friction, in other words one may neglect the mass of the wind current layer. Sverdrup used this method to analyze his observations made on the *Maud* expedition for the drift of the close-packed and relatively thick ice of the East Siberian Sea. Here the internal resistance of the ice was great. It reduced the drift and rendered the ice-water friction negligible.

Sverdrup introduced the internal resistance of the ice into the examination to explain why the drift angle of the ice was smaller, according to his observations, than that required by Ekman's theory. However, introduction of the resistance force should also have involved a reduction of the speed of the wind drift or, in other words, of the wind factor, but the observations showed otherwise.

Figure 142 shows the results of Brennecke's observations of the wind drift of relatively thin (about one meter thick) and scattered ice fields in the Weddell Sea. These observations show the connection between the wind factor (dashed line), the drift angle (solid line) and the wind speed. From the figure it is evident that the drift angle decreases with increasing wind speed, while the wind factor remains nearly constant with increasing wind speed.

Let us also note here that Brennecke's observations show that the wind current affected only a very thin layer of underwater ice. At a depth of just 2 m, the current deviated 19° from the ice movement, and the velocity of the wind current was only 58 per cent that of the ice drift. At a depth of only 25 m the wind drift was practically 0.

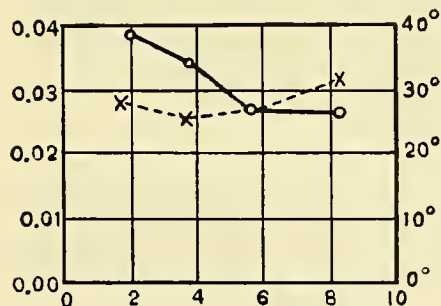

Figure 142. The relationship between the wind speed in m/sec (lower scale), the drift angle of the ice (scale on the right) and the wind factor (scale on the left) in the Weddell Sea.

Table 109 shows the average wind factors in the East Siberian Sea, according to Sverdrup's observations from 1922 to 1924. The table indicates that the wind factor from July to September is considerably greater, which is explained by the greater unevenness of the upper layers of ice and by the fact that they are thinner and also by the greater free movement of the ice in the summer period due to the greater number of open leads.

TABLE 109. ELEMENTS OF THE WIND DRIFT OF ICE
IN THE EAST SIBERIAN SEA

Winter Months (November-March)						
Ice thickness about 3.5 m						
Average wind speed in m/sec	1.62	2.43	3.46	4.34	5.69	7.52
Wind factor	0.0185	0.0143	0.0108	0.0154	0.0174	0.0229
Number of observations	19	35	21	14	12	5
Summer Months (July-September)						
Ice thickness about 2 m						
Average wind speed in m/sec	1.41	2.40	3.38	4.25	5.68	7.45
Wind factor	0.0405	0.0289	0.0307	0.0181	0.0218	0.0378
Number of observations	41	9	17	6	4	2

According to Sverdrup, if one considers only the winds that are sufficiently prolonged and which insure steady motion, during the period 8 August 1922 through 17 March 1924, the wind factor varied from 0.0108 to 0.0275, while the drift angle varied from 26° to 47°. The average values for the whole period of observation were: wind factor 0.0204, drift angle 37°

During a wintering on Mys Schmidt (Cape Schmidt) in the Chuckchee Sea (1938 to 1940), Gordienko made many observations of the wind drift of ice. These observations were made with two theodolites mounted on the shore at a given distance from each other and from the actual drifting ice. In addition, Gordienko used observations of the wind drift of ice made on Mys Schmidt by Shestiperov. Gordienko compiled a table of wind factors as a function of the concentration and hummocking of ice on the basis of his processing of these observations (table 110).

From the table it is evident that ice with a concentration of 1/10 drifts approximately 4 times faster than ice with a concentration of 9/10 and that the drift speed increases with hummocking.

TABLE 110. THE WIND FACTORS OF ICE DRIFTS AS A FUNCTION OF CONCENTRATION (n) AND HUMMOCKING (m) OF THE ICE. THE FACTOR IS MULTIPLIED BY 10^4

$m \backslash n$	1	2	3	4	5	6	7	8	9
1	90	80	70	60	50	40	35	30	25
2	180	160	140	120	105	90	70	60	50
3	270	245	220	200	175	150	125	100	80
4	360	330	295	260	230	195	160	130	100
5	450	410	370	330	290	250	210	170	130
6	540	490	440	395	350	305	260	210	160
7	630	575	520	465	410	355	300	245	190
8	720	650	600	540	475	410	350	285	220
9	810	740	670	590	520	450	390	310	245

LITERATURE: 62, 77, 173, 174.

Section 141. Wind Strips of Ice

Ice of low concentration and different shapes and sizes exhibits several more characteristic features of wind drift.

Let us assume that at the initial moment and complete absence of wind, ice floes of various form and size are distributed evenly over a certain sector of the sea. When the wind begins, all the floes gradually begin to move. First they all turn such that their major axes are approximately perpendicular to the motion and second they begin to move at different rates of speed and in different directions depending on their size, shape and depth below water level.

Naturally, after a certain time interval the small floes, which began to move earlier (because of their smaller inertia) and which move faster, gradually overtake the larger floes and either slip through the intervals between the large floes or come into contact with the windward sides of the large floes. Gradually, the individual free spaces between the floes become filled with the floes arriving "from windward" and strips of ice form in the examined sector of the sea. These bands extend in a direction approximately perpendicular to the wind direction and consist of ice floes of various sizes driven together (figure 143).

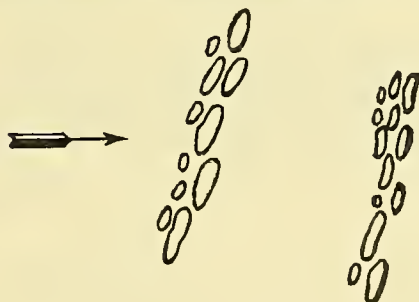

Figure 143. The wind drift of ice strips and the size distribution of floes.

Naturally, in such strips of ice the floes will arrange themselves by size: the largest floes on the leeward side of the strip, the smaller floes on the windward side. The stronger the wind, the closer packed will be the individual strips. If the wind slackens and especially if the wind ceases,

the strips will begin to drift apart, because the larger floes will continue to move by inertia, while the smaller floes will stop.

With each change in the wind, the floes will regroup and new elongated strips will form correspondingly.*

The distance between the individual strips may vary greatly, from tens of miles to several miles, depending on the quantity of ice and the size of the main floes which form on the leeward side of each strip.

If there is a coastline or immobile ice on the leeward side of the strips moving in this manner, the individual strips, gradually moving on shore or onto the ice, will cause compression and subsequent hummock formation due to the loss of the inertia of each individual strip. Of course, the lines of hummock formation will run parallel to the strips of ice.

The wind formation of ice strips does not cease even in winter, except that in winter the individual floes driven into strips quickly fuse together as a unit and drift as a new ice formation. When the wind ceases, the strips do not break apart but remain large individual fields until they are broken up by storms of sufficient force. In winter during stills the open spaces of water between the strips becomes covered with young ice and subsequently in large ice fields strips of stronger (old) and weaker (young) ice alternate.

LITERATURE: 62, 77.

142. Compressive and Dispersive Winds

Let us assume (figure 144) that MN is a shoreline (or immobile ice). On drawing line AC at an angle α (drift angle of the ice in the given region) to line MN , we find that with any wind from sector $OABC$ the wind movement of the ice will have a velocity component directed toward the shore and therefore these winds will be compressive with respect to the shore, while winds from sector $OADC$ will be dispersive. Further, the greatest compressive forces will occur with a wind from B toward O and the greatest dispersive forces will occur with a wind from D toward O .

Going into further detail, we find that when the winds are from sector AOB , the drift angle of the ice will be greater and with winds from sector BOC smaller than the angle of ice drift in the open sea. Actually, with a wind from E toward O , the drift speed of the floe (moving at a theoretical angle of inclination to the wind direction) has two components: one perpendicular to the shoreline and the other parallel to the shore from point M toward point N . Consequently the first component will be damped by the resistance of the shoreline and the second will somewhat increase the total drift angle. Naturally, when the wind is from sector COB , we will get the opposite picture and individual cases, such as a possible zero drift angle or even an ice drift to the left of the direction of the acting wind in the northern hemisphere.

*In my opinion, the elongation of the open leads (razvodya) in a direction approximately perpendicular to the direction of the wind explains the brilliant navigation in ice performed by sailing vessels in the past. I confirmed this, during a voyage during which we rounded Franz Joseph Land in 1932 on the motor sailing vessel *Knipovich*.

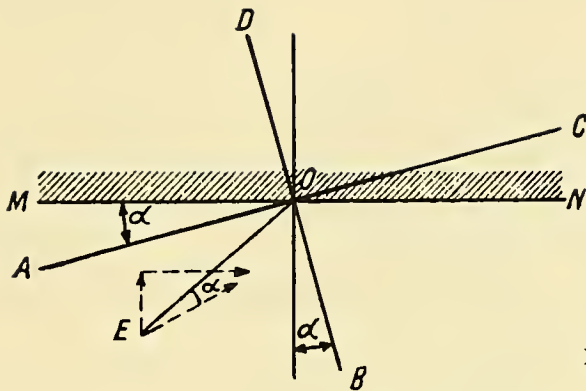

Figure 144. A sector of compressive and dispersive winds with respect to the shoreline or to moving ice.

Figure 145 shows the relationship between the wind direction, the wind drift of ice and the ice concentration. The sketch was made by Shestiporov on the basis of 580 series of observations made by him at Mys Schmidt in the Chuckchee Sea with a theodolite. From this sketch, in which the thick arrows indicate direction and force of the wind at the time of observation and the thin arrows indicate the direction and speed of the wind drift of the ice, we can see that generally the drift angle increases as the concentration of the ice decreases (greater freedom of motion of the floes) and second that the wind drift of the ice is deflected to the left of the wind direction in the case of northerly and northwesterly winds, and by the orientation of the coastline in this region (compass direction 130-310°).

The configuration of the coast along the Chuckchee Sea where Shestiporov conducted his observations is very straight, hence the winds can be separated into compressive and dispersive components very simply on the basis of logical judgments. In other regions, where the coastline is sinuous, only observations can reveal whether a wind is compressive or dispersive and such observations must be made for various amounts of ice in the adjacent regions of the sea and under various synoptic conditions.

There are characteristic phenomena associated with compressive and dispersive winds relative to the edge of floating ice.

During compressive winds, the ice edge is highly consolidated and stretches in a relatively even and stable line for a great distance. Usually, the ice is close packed at the very edge while at some distance from the edge it is less compact. Thus, the edge of the pack acts somewhat as a break-water. In the case of dispersive winds, the edge becomes scattered. On the seaward side of this type of ice edge, one finds small floes greatly eroded by the wind and waves and on passing farther into the ice the number of floes and the size of the floes gradually increase.

During dispersive winds, very often whole strips of ice consisting of floes of various size and form detach from the edge. In these strips, which stretch in a direction approximately perpendicular to the wind direction, the floes usually group as indicated above; i. e., the larger floes are found on the leeward.

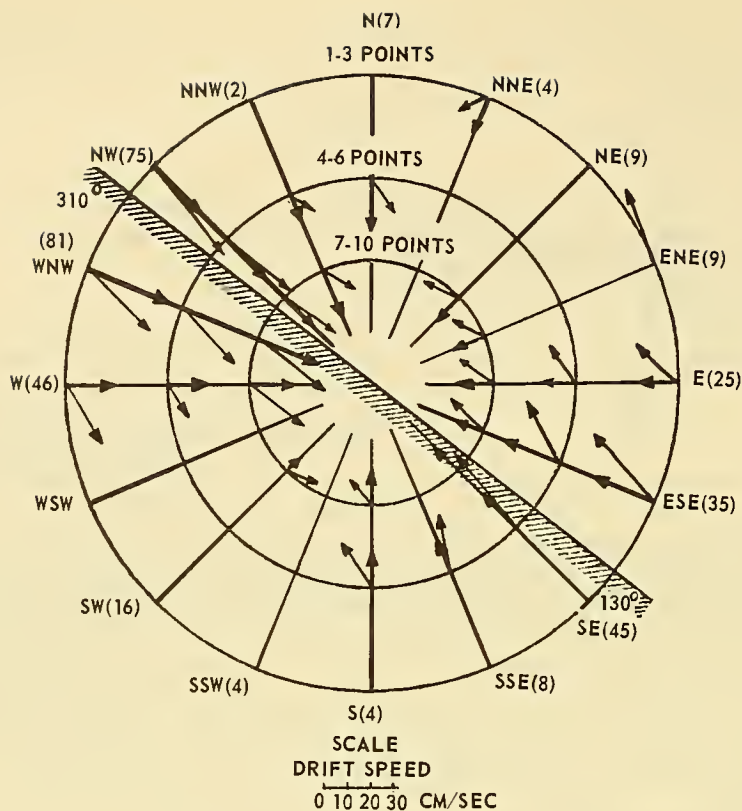

Figure 145. Relationship between the force and the direction of the wind, the drift angle and the drift speed and the amount of ice concentration in tenths at Mys Schmidt. The figures in parentheses indicate the number of observations.

With neutral winds (i.e., winds blowing approximately along the ice edge) the individual floes, which have broken free from the edge, group and form characteristic ice tongues which stretch approximately perpendicular to the edge. If a neutral wind becomes compressive, the seaward end of these ice tongues turns inward and presses against the edge of the pack. When the neutral wind becomes dispersive, the tongues turn away from the pack and are carried out to sea. Until their final regrouping, they are reminiscent of the dispersed strips of ice, but they differ from the latter by a difference of 90° in orientation as well as in the disposition and size of the floes.

Equally characteristic phenomena occur during offshore and onshore winds. Every compressive (onshore) wind in general causes compression and a massing of ice along the shore. If there is a small amount of ice in a given region, as in summer, and if the waters are highly stratified (as in the case of ice regions), the upper layer is sometimes completely driven toward the shore and a wind countercurrent forms in it. Along the line of impact of the wind sea current and the wind coastal countercurrent, a line of immersion may be created along which the ice brought from the sea accumulates and forms a special strip along the coast.

In some cases, the open water along the coast may persist for a long period of time even in presence of powerful compressive winds and large amounts of ice. For this to occur, the coastal waters must be quite fresh (as a result of melting and the influx of coastal waters) and then warmed

intensively. Naturally, under such circumstances a thick and very light layer of water forms along the shore, and in this layer a circulation occurs counter to the wind and keeps the floating ice away for a long period of time. Such a situation is not very probable in winter, because in winter the waters are less stratified.

However, during onshore winds in coastal waters a circulation is created with horizontal axes approximately parallel to the shoreline. These circulations, thanks to friction along the bottom, raise the sea level at the shoreline. The resistance to friction increases in proportion to the square of the velocity, and therefore the velocity of the onshore current does not increase in proportion to the wind speed, as in the case of currents in the open sea. Furthermore, the speed of the actual wind drift of ice is not a function of nearness to the shore and thus the drift of ice toward the shore is not decelerated by the shore as much as the movement of the coastal waters, and continues even after the movement of the coastal waters in this direction has ceased.

In the case of offshore (dispersive) winds, the ice becomes scattered or leads form which stretch along the coast or the edge of the immobile ice.

LITERATURE: 62, 77.

Section 143. Wind Leads and Polynyas

Wind and polynyas form along the shore, or at the edge of shore ice and may be temporary (in the case of temporary offshore winds occurring during the passage of pressure systems) or constant (in the case of prevailing offshore winds).

The temporary wind and polynyas are sometimes highly important for navigation in long straits.

Figures 146 a and b show the ice situation in Vilkitski Strait according to aerial reconnaissance data for 8 and 24 July 1943.

We know that in Vilkitski Strait there is a stream of ice carried out from the Kara Sea by a steady current into the Laptev Sea. This flow of ice increases with favorable westerly winds and decreases with easterly counter winds. Furthermore, winds cause this stream to shift sometimes to the north and sometimes to the south.

During the natural synoptic period from 1 through 7 July 1943, the isobars in Vilkitski Strait stretched northwest-southeast, and the center of the pressure high was situated above the southwest part of the Kara Sea, while the low-pressure center was located over the New Siberian Islands. The reconnaissance of 8 July shows that an enormous polynya formed off the south coast of Bolshevik Island as a result of north-northwest winds and the ice drift southeast.

From 8 through 13 July, the isobars in the region of Vilkitski Strait stretched almost from north to south, the high pressure region was situated above the northern part of the Laptev Sea. In the synoptic period which began 21 July, the isobars were situated approximately as they had been in the period from 8 through 13 July. Corresponding to this position of the isobars, the ice pressed against Bolshevik Island. From 14 through 21 July, the isobars in Vilkitski Strait stretched from northeast to southwest, the high pressure center was situated in the southwest part of the Kara Sea and the ice correspondingly pressed against the continental coastline.

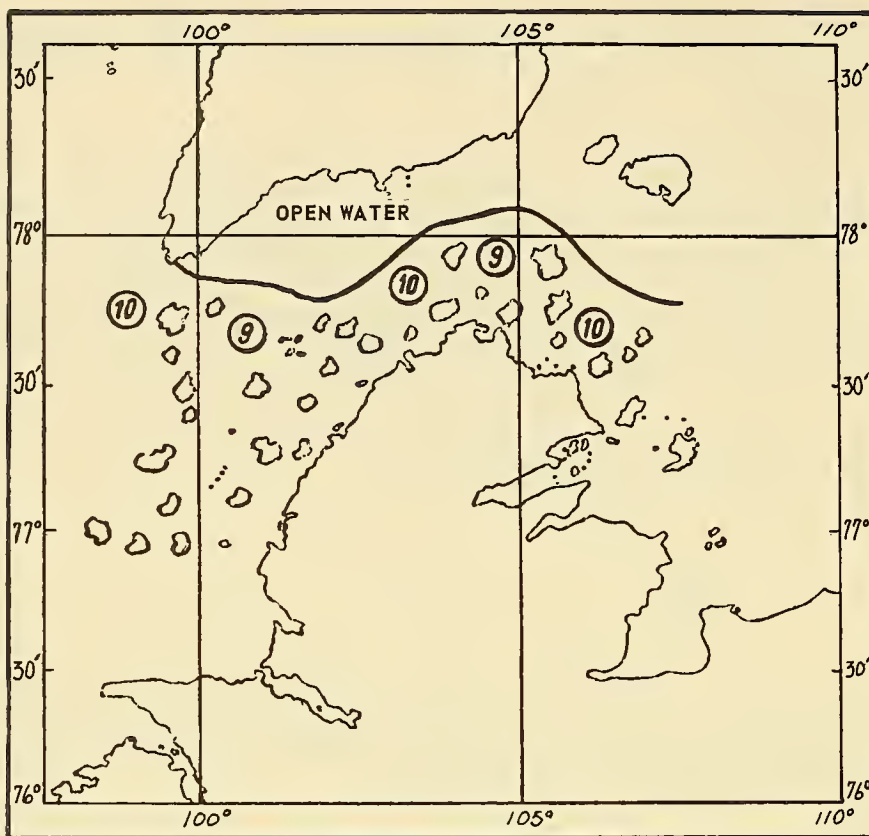

Figure 146a. State of the ice in Vilkitski Strait on 8 July 1943.

The aerial reconnaissance of 8 July coincided with the end of the synoptic period and therefore the ice situation was quite clear: an accumulation of ice off the coast of the mainland and open water off the southern coast of Bolshevik Island. The aerial reconnaissance of 24 July fell to the middle of the synoptic period, therefore the preceding period was completely opposite with respect to the position of the isobars and the resultant ice drift. This made the disposition of the ice relatively indistinct. Just the same, we can see that on 24 July off the continental coast there were either open leads on polynyas or very scattered ice, i. e., a situation diametrically opposed to the one observed on 8 July. Undoubtedly such phenomena have a very substantial influence on the possibilities of navigation of Vilkitski Strait. Ship captains do not always have aerial reconnaissance data by any means nor do they always have good synoptic maps. Therefore, on passing through such straits as Vilkitski, Sannikov and Laptev one must always keep a close watch on the wind and to emerge windward as much as possible.

As already pointed out, prevailing winds create more or less permanent leads or polynyas. These are especially conspicuous on the leeward shore of capes which stretch out into the sea and on the leeward side of individual islands.

Southwesterly winds prevail in the neck of the White Sea (Gorlo Belogo Moria) during winter, creating at least scattered ice here if not polynyas or leads. This is also why such openings form off the Summer Coast (Letni Bereg) of the White Sea, as has been noted by Timonov.

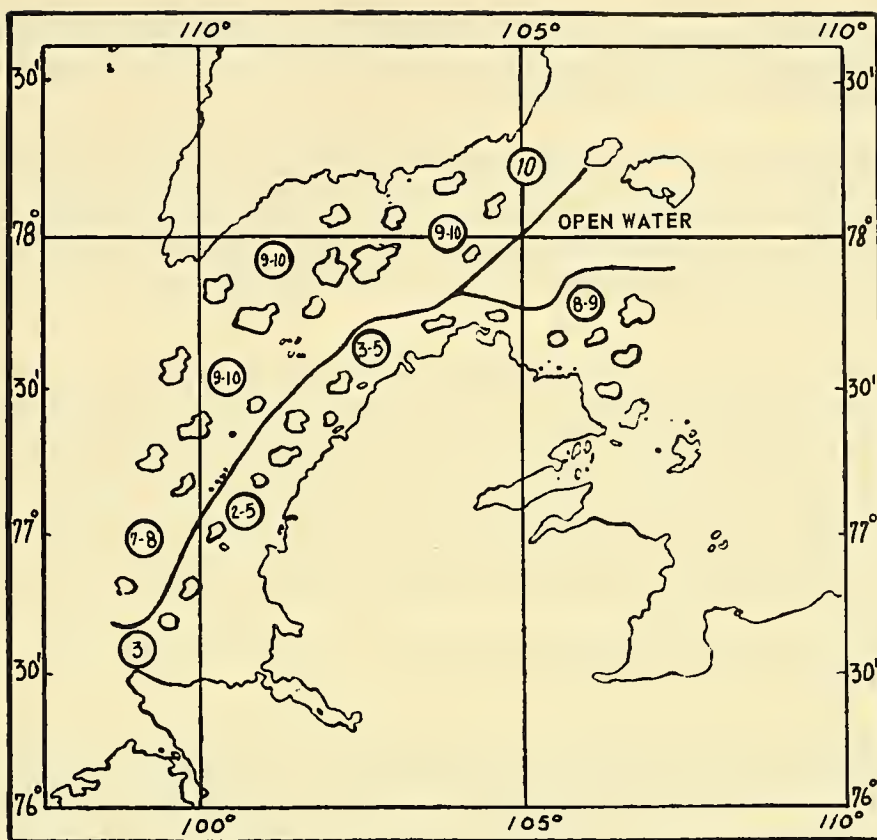

Figure 146b. State of ice in Vilkitski Strait on 24 July 1943.

However, prevailing winds create a steady drift of ice in approximately the same direction. For example, the large polynyas created by the combined influence of the prevailing winds and the steady drift of ice were often observed by the Ushakov Expedition of 1930 to 1932 off the northwest coast of Severnaya Zemlya, permanent polynyas and leads are also a common phenomenon northwest of Franz Joseph Land, as noted as far back as the Weyprecht - Payer Expedition.

One of the main reasons for the formation of this so-called great Siberian lead is the prevalence of easterly leads which create a steady northwest drift of pack ice, i.e., from the shore toward the shore ice. This has been traced northwest, north and northeast of the New Siberian Islands, and is called the New Siberian Lead, and in the region to the north of the Kolyma region, this is called the Kolyma Lead.

In winter, both these stretch discontinuously along the northern edge of the developed shore ice and sometimes are situated farther north or south depending on the conditions of the shore ice. Under the influence of northerly winds these leads sometimes become covered with ice arriving from the north and then intense hummocking occurs along the line of contact. However, in general, both are constant phenomena.

The New Siberian Lead was first described by Hedenstrom, who traveled along the ice in March and April 1810 from Cape Kamennyi on New Siberian Island 40 miles to the northeast and was

stopped by an ice-free expanse of open water. Later, this was noted by Sannikov in 1811 and was studied by the expeditions of Anjou in 1821 to 23, Matthiesen, Brusnev and others in 1902 to 03. In Wrangel's opinion, the Kolyma Lead discovered by the Wrangel Expedition in 1820 to 23 is directly connected with the New Siberian Lead.

It should be noted that in the spring of 1938, the airplanes of the Alekseev Expedition, in flying to a convoy of ships which was drifting in the region to the north of the New Siberian Islands (the ships *Sadko*, *Malygin* and *Sedov*) did not find any trace of the New Siberian Lead. However, this is not surprising, because the westerly winds which had prevailed before the flights, continued in this region. They closed the leads and caused a prolonged eastward drift of the convoy after it had rounded Kotelnyi Island.

The great Siberian Lead, as already pointed out, is caused chiefly by prevailing winter winds, which are dispersive with respect to the edge of the pack. However, the offshore wind phenomena are always accompanied by the lifting of deep water layers toward the surface of the sea or even by their emergence onto the surface. In the Arctic Basin, the warm deep Atlantic waters are found at a depth of 75 to 250 m from the surface, depending on the region and the general thermal state of the arctic. The heat of these deep waters, which rise as a result of the offshore phenomena and are mixed by convection or by the wind, aid in melting and retard ice formation. Thus, the effect of the offshore phenomena is intensified and the leads become more stable.

Akkuratov's data on the polynyas and open leads in the ice at high latitudes in the arctic are very interesting.

On 15 July 1939, during his flight to the Laptev Sea, a 10/10 ice concentration prevailed from the coast to 74° north. Farther to the north, almost to 76° north, the ice concentration did not exceed 2/10. On the traverse of Pronchishcheva Bay (Bukhta Pronchishcheva), open water appeared. An ice edge of 2/10 concentration of small to large blocks of ice was moving eastward. The open water which stretched to the meridian of the western island of Komsomolskaya Pravda had extended north and northeast toward the horizon beyond the range of visibility.

In Shokalsky Strait the ice concentration was 10/10, while at 79° 30' north and 103° east open water appeared with individual accumulations of ice 1/10 to 3/10. The lead ran northeast beyond the horizon. Along this parallel it extended from the 104th to 116th meridian. From there the lead ran southward to Pronchishcheva Bay.

On 27 to 28 July of that same year, open water was discovered at 78° 53' north 121° east. The ice edge stretched southeast to northwest. Open water extended farther to the coast of Severnaya Zemlya, passing north and south in a broad band.

In Akkuratov's words, on 3 August 1939, ships could have passed through open water from Semenovskiy Island (Ostrov Semenovskiy) around the New Siberian Island to Ambarchik Bay (Bukhta Ambarchik), while ships plying the Laptev Strait (Proliv Lapteva) experienced difficulties.

On 9 July 1940, Akkuratov saw much open water in the Laptev Sea at 78° north and 125° east. The lead extended beyond the 130th meridian (130° east). Thus, the same open water phenomenon was observed in this region, as was observed on the other in 1939.

Further, during a flight over the East Siberian Sea on 12 to 13 July 1940, north of the Ostrov Novaya Sibir up to 76° north, open water stretched northwest and northeast beyond the limits of visibility.

During a further flight northward, the 9/10 ice became less concentrated as 82° north was approached, within the limits of visibility of the aircraft, becoming 7/10, and the edges of the floes became rounded. Small fields, small floes and broad leads with ice of small size prevailed.

The reasons behind the ice conditions observed by Akkuratov in 1939 and 1940 have not yet been analyzed.

LITERATURE: 37, 62, 77, 88.

CHAPTER XII

CIRCULATION OF WATER AND ICE OF THE ARCTIC BASIN

Section 144. Certain Information Concerning the Balance of Water and Ice

As we have seen, the Arctic Basin consists of a central, deep water part which is bordered by the Kara, Laptev, East Siberian and Chukchi Seas north of the European-Asiatic continent and by the Beaufort, North American and Lincoln Seas north of the North American continent.

In the western hemisphere, of these seas, only the North American is a sea in the full sense of the word. In the eastern hemisphere, only the southwestern part of the Kara Sea may be so regarded. All the other seas are, in relation to the central Arctic Basin, only gulfs with extremely wide mouths. In these sea-gulfs there are hardly any obstacles which would limit the exchange of water and ice between them and the Arctic Basin proper. Only the Kara Sea presents a slight exception, since the *Sadkol* shoals which extend in a meridional direction, and Ushakov Island, situated on them, divide the northern part of this sea into two parts, eastern and western. These parts in turn represent sharply defined gulfs. On account of this the circulation of water and ice in the Central Arctic Basin has a strong influence on the corresponding circulation in the adjacent seas and is in its turn determined by the circulation in the latter.

But while the Arctic Basin is closely connected with the seas and gulfs directly adjacent to it, its connection with the adjacent basins of the World Ocean is extremely limited. It is connected with the Pacific Ocean by the narrow and shallow Bering Straits. The Arctic Basin is connected with Baffin Bay of the Atlantic Ocean through numerous, but very narrow and shallow straits of the North American archipelago. Due to this, the water exchange and ice exchange between the Arctic Basin and Baffin Bay is so insignificant that it may be ignored for all considerations.

The water and ice exchange between the Arctic Basin and Barents and Greenland Seas is more significant.

In considering the water and ice balance of the Arctic Basin, in the first approximation we may ignore precipitation and evaporation. This assumption is evidently justified if we take into consideration the fact that for the balance we must consider only the advective precipitation, i. e., water from precipitation which has been carried in from other basins. Local precipitation which falls as a result of local evaporation and subsequent condensation must clearly be excluded from the balance.

Coastal flow or drainage is the first factor which determines the balance of the Arctic Basin. The coastal drainage, plus the slight but indubitable excess of precipitation over evaporation, defines the character of the general circulation in the Arctic Basin as a drainage circulation. Such a circulation is of course most strongly felt in the Kara and Laptev Seas.

The second factor which determines the general circulation in the Arctic Basin is convective phenomena. Due to their low salinity, the surface arctic waters have a low density, despite their

low temperature. Thus, in the areas of contact of these waters with the denser ocean water, convection currents are set up. Due to local conditions (i. e. , shallow depths), such currents are absent in the Bering Straits and in the straits of the American archipelago, nor in the straits which connect the Arctic Basin with the Barents Sea are they considerable. They are sharply expressed (again due to local conditions) only between Greenland and Spitzbergen (due to presence of great depths and saline Atlantic water). Unfortunately it is not yet possible to show the significance of convection currents in the Arctic Basin.

A third factor which determines the general circulation in the Arctic Basin is wind conditions. Wind behavior is connected with the distribution of pressure and experience seasonal and long term variations. It is clear that the general circulation is determined not by local or short-lived winds, but by the distribution of winds over the whole Arctic Basin and over the ocean basins communicating with it.

So, the general circulation of water and ice in the Arctic Basin is extremely complex. In it the drainage circulation, convective circulation and wind-drift circulation are superimposed one on the other.

It is characteristic of the Arctic Basin that the drainage and convective circulations are set up in the water masses and are transmitted to the ice. The wind-drift circulations are transmitted from the ice to the water masses. But in every circulation of water masses, in addition to the horizontal, there are also vertical components which are particularly pronounced in areas of sinking and rising. Since the vertical components are absent in the movement of ice, the circulation of ice is different in this respect from the normal circulation of water masses.

As we have seen, the coastal drainage of rivers which drain into the Arctic Basin diminishes in the direction west to east. The total coastal drainage of the Asiatic coast is equal to 2,500 to 3,000 cubic km per year. A second peculiarity of the coastal drainage is the variability of its quantity from year to year. The third and most important peculiarity of the coastal drainage of Asiatic rivers is its sharply defined seasonable quality.

The intensity of the coastal drainage in the summer season is of great importance for navigation along the arctic coast. Due to the drainage, the arctic ice not only melts intensely in the summer season but also moves away from the coast. The greater the drainage, i. e. , the more westerly, the more distinct this phenomenon. The drainage also moderates the unfavorable effect of monsoon winds which flow from land to sea in the winter and from sea to land in the summer.

It has already been pointed out that with our level of knowledge it is impossible to determine the role of purely convective currents in the general circulation of water and ice in the Arctic Basin. Existing observations make it possible, but only extremely roughly, to calculate the water exchange through the main straits which connect the Arctic Basin with adjacent basins.

Thus, in June, July and August the flow into the Chuckchee Sea through Bering Straits comprises, according to Ratmanov, approximately 95 per cent of the whole water exchange between the Arctic Basin and the Bering Sea. The speed of the surface current reaches 3 to 3.5 knots. The east-west cross section area of the straits is about 2.5 square km. Assuming the average speed of the Pacific current (increasing in summer and decreasing in winter due to the development of the Aleutian low pressure cell) at about one km per hour, we find that the influx of Pacific water through Bering Straits can not exceed 20,000 cubic km per year. The Pacific current in Bering Straits is not a convection or drift current. It is a compensation current caused by the flow of water from the Arctic Basin into the Greenland Sea.

Data on the water balance of the straits which connect the Arctic Basin with the Barents Sea is also extremely limited. Using an indirect method, Sokolov calculated that in the autumn of 1931, through the straits between Spitzbergen and Franz Joseph Land, the water balance, positive for the Arctic Basin, was about 30 cubic km per day, while between Franz Joseph Land and Novaya Zemlya the negative balance was about 6 cubic km per day. In the Novaya Zemlya straits, the influx of water from the Barents Sea exceeds the outflux of water into this sea from the Kara Sea. Thus we may calculate approximately that the influx of water into the Arctic Basin from the Barents Sea comprises about 11,000 cubic km per year.

There is not as yet one complete transverse section across the straits between Greenland and Spitzbergen. This fact makes it impossible to compute even roughly the water balance in these straits. It is only known that almost the entire water mass on the continental shelf along the east coast of Greenland is made up of surface arctic water flowing from the Arctic Basin into the Greenland Sea, while the part of the Greenland-Spitzbergen straits which is adjacent to Spitzbergen between Greenwich meridian and the shore is filled with Atlantic water which is entering the Arctic Basin.

Mosby states that the quantity of Atlantic water with temperature above 1.5° entering the Arctic Basin is equal to 1,200,000 cubic m per second which amounts to about 38,000 cubic km per year. Berezkin has estimated the quantity of this water, with temperature above 4° at about 130,000 m per second which amounts to about 4,000 cubic km per year.

Taking into account the influx of water from the Bering and Barents Seas, we may conclude that the flow of water from the Arctic Basin into the Greenland Sea, for the maintenance of the balance, must exceed the influx of Atlantic water into the Arctic Basin by 30,000 cubic km per year at the very least.

In figure 147 there is represented a comparative chart of drifts of the station "North Pole" and icebreaker *Sedov* before their entry into the Greenland Sea. In this figure the extraordinary parallelism of both drifts is worthy of attention. This gives a slight basis for considering that the speed of the East Greenland current is more or less constant across the width of the straits.

According to determinations of Shirshov and Pedorov, the speed of the permanent current at 81° north lat. was about 3.4 miles per day or about 2,300 km per year. Let us assume that the depth of this current is 0.2 km. The ultimate overflow will then be equal to about 230 square km per year. Assuming that at 81° north lat. this current is confined within the limits from 8° east long. to 12° west long., or within 20° of parallel (which comprises about 350 km), we find that the arctic current carries into Greenland Sea at least 80,000 cubic km of water per year, of which (with average ice thickness about 2 m) about 2,500 cubic km is represented by arctic ice.

The latter figure is obtained in the following manner: the ice, as well as the extreme surface of the arctic current, move considerably faster than the basic mass of the current. E.g., the station "North Pole" during December, 1937 moved to the south with an average speed of about 10.4 km per day, while the *Sedov* in December, 1939 moved south in the same region with an average speed of 9.3 km per day. Taking 10 km per day as the average speed of ice drift in December, the width of the ice current as 550 km, and the average ice thickness as 2 m (taking polynyas into consideration), we find that in December about 220 cubic km of ice was carried out of the Arctic Basin. The ice is probably not carried out of the Arctic Basin with the same speed in all months of

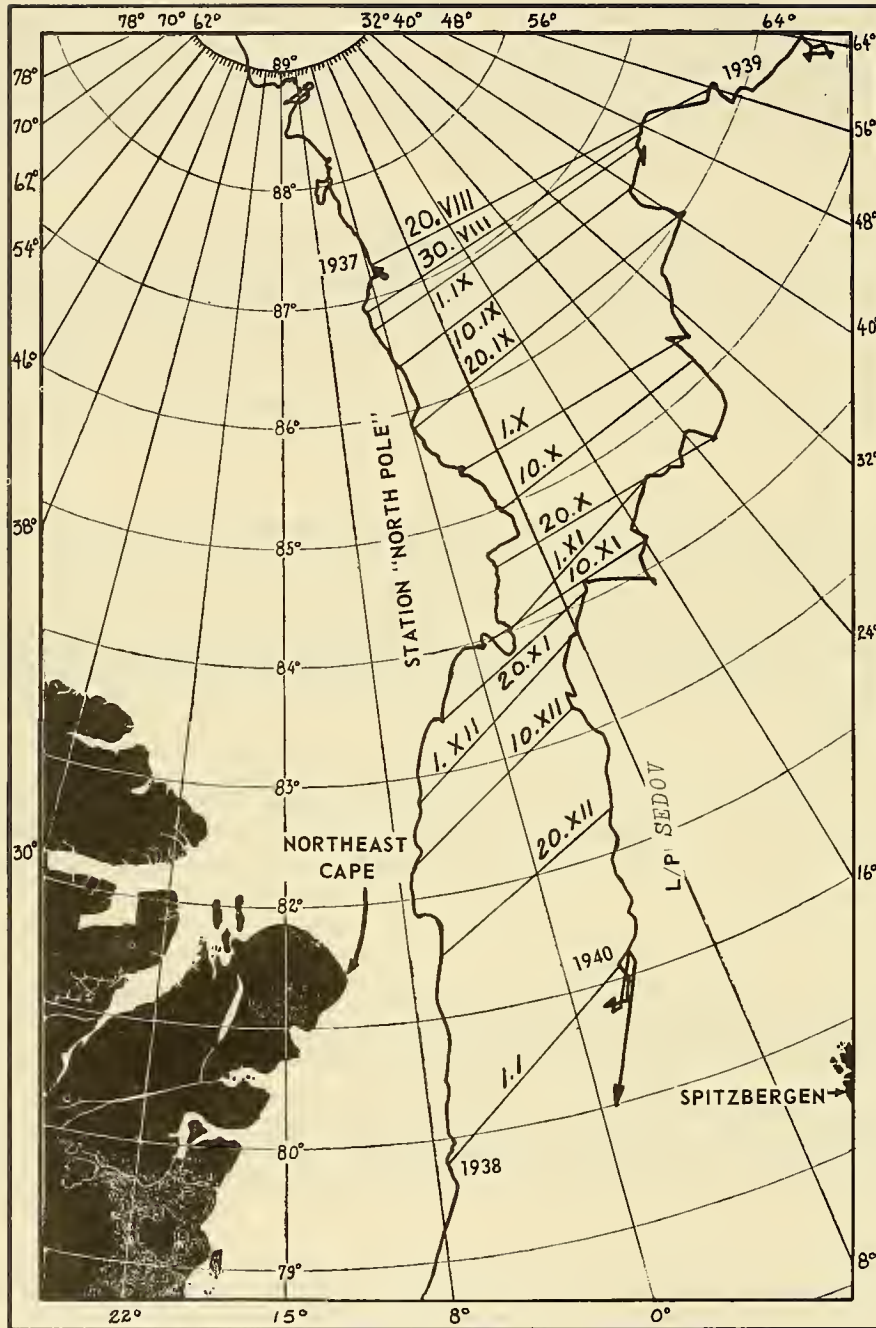

Figure 147. Diagram of the drift of station "North Pole" and the *Sedov* before entering the Greenland Sea.

the year, since December is precisely the time when the north winds along the east coast of Greenland are noted for their special force and constancy. Thus, the annual outflow of ice from the Arctic Basin into Greenland Sea can hardly exceed 2,500 cubic km per year.

LITERATURE: 16, 62, 71, 77, 112, 118.

Section 145. Coastal Siberian Waters

Coastal Siberian waters is the term conventionally employed for the waters of low salinity formed mainly by the mixing of the coastal drainage water of Siberia with the water of oceanic origin which enters the Siberian coastal seas from the adjacent parts of the World Ocean.

In order to define the limits of this water we must first of all establish the upper limit of its salinity. Obviously, any limitation will be more or less arbitrary. I am personally inclined to accept a salinity of 25 o/oo for this limit. There is some basis for such a choice in the fact that, as we have seen, the freezing point of water of salinity less than 24.7 o/oo (as with fresh water) is lower than the temperature of greatest density.

The distribution of the coastal Siberian waters is extremely typical. If we exclude the lower end of Baidaratskaya Bay and the delta areas of the small rivers which empty into the Kara Sea, where extremely low salinities may be found, then the main region of the coastal Siberian waters in the Kara Sea is the region bordered (in the summer) by approximately the 76th parallel on the north and the 73rd on the south. Its western boundary is the east coast of the northern island of Novaya Zemlya, the eastern boundary is the mainland coast from Yamal to the 95th meridian. The total area of this water is about 250,000 square km and the thickness of the layer, as a rule, is not over 15 m. The annual river drainage into this area covers it with a layer about 6.3 m deep.

In the Laptev and East Siberian Seas the 25 o/oo isohaline stretches from the east coast of the Tamiyr Peninsula to the east approximately along the 76th parallel, goes around the New Siberian Islands on the north and then descends towards Chaunskaya Bay, thus embracing an area of approximately 650,000 square km. Here also, as a rule, a salinity of 25 o/oo is not found deeper than 15 m. The annual river drainage onto this area covers it with a layer about 1.5 m deep.

In the Chuckchee Sea a salinity of less than 25 o/oo may be found only near the shore and, therefore, the coastal Siberian waters do not play a large role.

Thus, the coastal Siberian waters are mainly concentrated in two regions--the Kara Sea and New Siberian Islands regions, although they move to a considerable distance (200 to 300 km) from the main areas of their creation (mouths of the Ob, Yenisei and Lena Rivers). They flow out in a sort of thin layer along the sea's surface. In shallow depths they extend down to the sea bottom. Over great depths, at their lower surface there is created a sharply defined layer of change of salinity, which in the summer season delimits the depth of dispersion of wind-caused mixing and in winter the depth of dispersion of vertical winter circulation. In connection with all the above-noted facts, the coastal Siberian waters display curious peculiarities in their thermal and saline conditions.

We have seen that the main heat-containing water masses of coastal drainage of the Siberian rivers empty into the sea during the shore polar summer. This facilitates the break-up and destruction of the ice cover in the delta regions and the formation of the delta polynyas. The constantly observed Ob-Yenisei polynya, for example, is of such origin. The water of these polynyas

absorb solar radiation, which is intense in this season of the year (on account of the polar day) and in turn become centers of melting of the surrounding ice and centers of accumulation of heat. As a result, the surface temperature of coastal Siberian waters in certain regions where the ice disappears early often rises to 10°C and higher. Since the temperature of these waters drops in the winter to the freezing point, it follows that an annual temperature range of 10° to 12° for these waters is not at all surprising.

We have already seen that in the ice formation process, salinification is directly proportional to the salinity of the water from which the ice is formed, directly proportional to the thickness of the ice, and inversely proportional to the thickness of the surface layer which is involved in vertical circulation in the ice formation process. From this it is clear that in connection with the slight thickness of the layer of coastal Siberian waters, the annual range of salinity of coastal Siberian waters reaches 10 o/oo and in shallow regions the value is even larger. Thus in the Laptev Straits at the end of August 1932, the *Sibirya* observed surface salinities from 12.40 to 14.28 o/oo. At the end of March 1928, in the same straits with ice thickness up to 189 cm, Khmyznikov observed salinities from 19.43 to 2.63 o/oo.

Such a combination of considerable annual ranges of temperature and salinity of the coastal Siberian waters is one of their remarkable peculiarities.

The next peculiarity of the coastal Siberian water, which has already been mentioned, is the sharply defined layer of change of salinity at their lower surface. Thus, for example, on 9 August 1932 at 73°55' north, and 81°06' east, the *Sibirya* observed the following:

at 0 m, $T = 8.12^\circ$ and $S = 13.20$ o/oo,

at 5 m, $T = 7.70^\circ$ and $S = 13.83$ o/oo and

at 10 m, $T = 0.41^\circ$ and $S = 28.86$ o/oo.

This means that between the levels of 5 m and 10 m the 1 m gradients are: temperature about 1.5°, salinity 3.00 o/oo, and density about 2.4.

If we assume that temperature, salinity and density between 5 m and 10 m vary in a linear fashion, it is then evident that the critical depth of vertical winter circulation at this station is equal to about 6 m, while the freezing index is 4.8 kg-cal per square cm. Further, a simple calculation shows that in order for the vertical winter circulation to descend to a depth greater than 6 m, formation of ice 146 cm thick is necessary. Thus, despite the comparatively high surface temperatures which are evident towards the end of the polar summer, the coastal Siberian waters are very quickly covered over with ice.

As has already been noted, ice which grows uninterruptedly (with respect to meteorological conditions) in the Kara Sea region of the coastal Siberian waters, reaches a thickness considerably greater than 150 cm only in occasional years. In case of hummocking, the average ice thickness rarely exceeds 300 cm. But at the station under consideration, the vertical circulation extending down to 6 m requires formation of ice 146 cm thick, i. e., approximately the limiting thickness. Simple calculations show that with ice formation of thickness 300 cm, the vertical winter circulation descends only to 7 m, causing the surface layers to be salinified to 19.60 o/oo. At the *Sibirya* station at a depth of 7 m, the interpolated values are: $T = 4.78^\circ$ and $S = 19.84$ o/oo.

Thus we see that the vertical distribution of temperature and salinity in the coastal Siberian waters is of such a nature that the formation of a warm intermediate layer is almost inevitable under conditions of uninterrupted ice formation. A slight and insignificant temperature inversion with simultaneous normal vertical distribution of salinity was observed by Khmyznikov in the early spring in the New Siberian Straits and in the Lanski Gulf. There is no doubt that in addition to the convective mixing, frictional mixing is also a large factor in fixing the vertical distribution of temperature and salinity. While the direct effect of wind and waves ceases in the winter, the action of the tides and the wind-driving phenomena, as well as the effect of sea currents, remains, although in altered form. In addition there is the strong frictional mixing caused by the wind movement of the ice. Very little has as yet been done, however, in the study of all these questions.

Figure 148 shows the annual variation of temperature and salinity of the coastal Siberian waters.

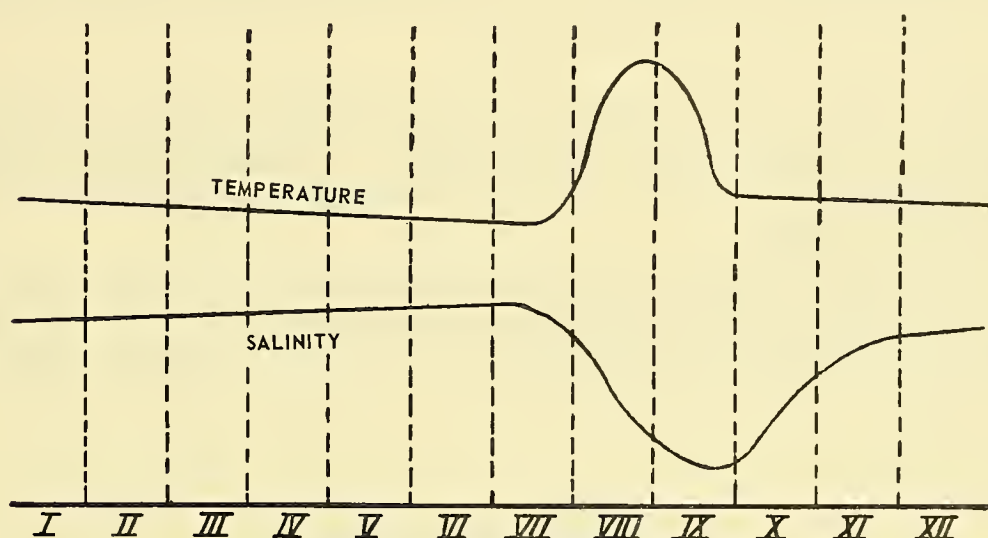

Figure 148. Diagram of the annual variation of temperature and salinity of the Siberian coastal waters.

In the beginning of October, on the average, the temperature falls to the freezing point and then continues to descend slightly (in connection with the lowering of the freezing point upon salinification due to ice formation) right to the end of June or beginning of July. The rise in temperature starts in July, at first slowly, and then proceeds faster and faster as the ice disappears. By the end of August the temperature reaches its maximum and in the middle of September begins to fall, at first slowly, and then faster and faster to the freezing point.

Due to the outflux of the coastal drainage and the melting of ice, the salinity naturally attains its minimum at the moment when the sea is cooled to the freezing point, and then, with the start of ice formation it begins to rise, at first rapidly, and then slower and slower right to the start of melting and the appearance of the flood waters. After this the salinity commences to decrease, at first slowly due to the thawing, then faster in connection with flooding and melting, and then slowly again in connection with melting of the remains of the ice cover.

Such a pattern of the seasonal variation curves of temperature and salinity of the coastal Siberian waters, caused by the high latitudes and by the hydrometeorological conditions, is also one of their remarkable peculiarities.

It must be noted that surface salinity of less than 25 o/oo may be found not only in the regions described, i. e., the delta areas of the Siberian rivers. For example, the *Sibiryakov*, following along the east coast of Severnaya Zemlya and the Taimyr Peninsula in 1932, observed surface salinities which in one case fell to 2.20 o/oo. But these were salinities which occurred in polynyas due to melting of comparatively close ice (6/1 coverage or more), with no wind and in comparatively warm weather. Such "drops" of water of low salinity, appearing in summer in a certain few regions of the Arctic Basin in connection with melting of ice, are usually eliminated with the first fresh wind which sets the ice in motion and thus effects a mixing.

It has already been noted that since the indices of freezing of the coastal Siberian waters are not large, directly after the commencement of cold weather the ice formation begins very quickly. Obviously, the first ice to be formed will be from the "drops of melt water," especially if even small vestiges of ice have been preserved in them.

But the general circulation of such seas as the Kara and Laptev includes a ceaseless transfer of ice and surface water out into the Arctic Basin. New ice formation is continually occurring on the water areas which have been opened up by this transfer. It is therefore natural that many consider that the main mass of Arctic ice is formed on the broad shallows of the Asiatic coast from the coastal Siberian waters.

Compensating for the decrease of the coastal Siberian waters, water of Atlantic origin enters these seas in deep currents from the Barents Sea and from the central Arctic Basin. Approaching the shallows, it flows up onto them and as a result of mixing with a small amount of coastal flow the waters form new masses of coastal Siberian water.

LITERATURE: 77.

Section 146. Arctic Surface Water

Figure 149 shows, according to Shirshov, the vertical distribution of temperature, salinity and specific volume, observed at 86°09' north lat. and 0°58' east long. The vertical distribution of oceanographical characteristics has approximately the same character in other regions of the deep water part of the Arctic Basin.

Depending on the observation region, approximately down to a depth of 50 to 150 m the temperature is almost the same at all levels around the freezing point. Below these levels the temperature increases sharply, at depths from 100 to 300 m passes through zero and at depths from 300 to 500 m it reaches its maximum. Below 300 to 500 m there begins a decrease in temperature, at first rapid, and then slower and slower. At a depth of about 900 m the temperature again passes through zero. At the lower depths of the deepest observation areas, the temperature increases slightly at the bottom.

The salinity increases sharply but more or less regularly from the surface down to a depth of 50 to 150 m within the limits from 30 to 34.5 o/oo. Below these levels there begins a very slow increase of salinity descending towards the bottom.

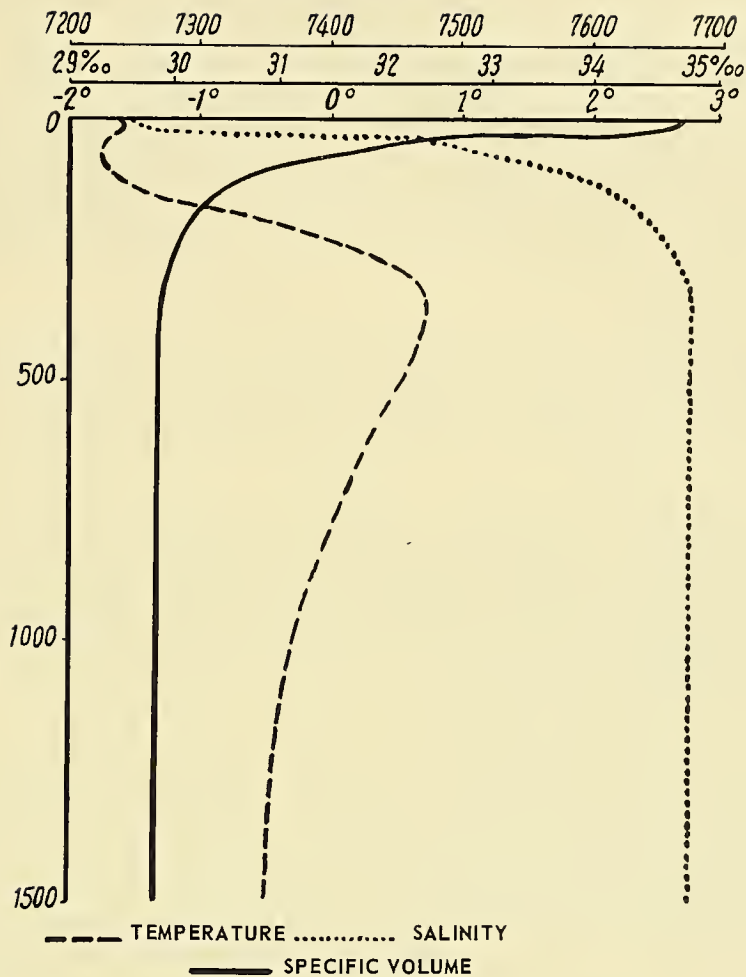

Figure 149. Vertical distribution of temperature, salinity and specific volume at 86°09' north latitude and 00°58' east longitude.

In accordance with such a distribution of temperature and salinity we will conditionally accept as the basic characteristics of arctic surface water: low temperature (below -1°) and salinity from 30 to 34.5 o/oo. These characteristics remain almost unchanged throughout the whole year (with the exception of the southern limits of arctic surface water which will be discussed below).

As has already been shown, the lower level of extent of surface arctic water is at different depths in different regions of the Arctic Basin. According to our observations on the *Sadko* in 1935 at 82°41.6' north, 87°03' east, it occurred at a depth of about 75 m. According to observations of the Libin-Cherevichny expedition in April 1941 in the region about 81° north along the meridian of Wrangel Island it descended to a depth of about 175 m. Observations of the station "North Pole" in 1937 in the Arctic Basin showed that it lay at a depth of about 150 m. In the Greenland current, which consists mainly of this surface arctic water, it was found at a depth of about 120 m.

On the periphery of the Arctic Basin, in regions where the warm Atlantic water hardly penetrates, the lower boundary of arctic surface water descends even deeper, sometimes to the very bottom. For example, at the northernmost observation point of the *Sibiryakov* in 1932, at 81°28' north, 96°54' east, at a depth of 200 m there was observed $T = 1.38^{\circ}$ and $S = 34.67$ o/oo. According to our observations on the *Knipovich* in 1932, in the region of Franz Joseph Land at 81°34' north, 52°05' east this boundary limit descended to the bottom, i. e., to 520 m. In the regions of penetration of warm Atlantic water into the Barents and Kara Seas, where there is sufficiently intense summer heating, and where the seasonal variations of temperature and salinity of the topmost layers are not significant, the arctic surface water forms a cold intermediate layer in the summer. In the central part of the Arctic basin the seasonal variations of temperature and salinity, according to Nansen, do not extend deeper than 60 m and are extremely slight.

The near freezing-point temperatures of arctic surface water and the vertical distribution of salinity in it indicates that extremely complicated processes are involved in its formation. In particular they are wind-caused mixing, a more intensive salinification during the winter over the shoals, but mainly, the melting process as a result of interaction of water and ice.

Nansen established that the arctic surface water moves toward the straits between Greenland and Spitzbergen and the speed of this current increases as it approaches the straits, reaching a speed of 1.0 to 1.5 miles per day right at the straits. It was established also that the Atlantic water moves in at subsurface depths in approximately the opposite direction, with speed decreasing from these straits, where its speed is also about 1.0 mile per day. It follows that between the levels of 0 and 400 m there is a level where the speed of the current is equal to zero. Evidently the depth of this level lies between 75 and 100 m.

In addition, the ice, being subjected to wind action, moves in diverse directions and with diverse speeds, amounting in some instances to 15 miles per day. In this process the ice naturally carries along in its movement the surface water down to a certain depth. For example, the instrumental observations of Shirshov and Pedorov showed that such a wind-caused current in the Arctic Basin as a rule is clearly defined to a depth of 25 to 30 m and only in rare instances does it embrace a layer deeper than 50 m. Usually, after a certain interval of time, a wind-caused counter-current is set up somewhat deeper (at depth of 50 to 74 m) and this again will embrace the layer from 35 to 125 m only in case of prolonged and rapid drift. Thus we see that in the upper layer of the Arctic Basin there exist extremely large current velocity gradients which, however, are not sufficient for elimination of their great stability.

Nansen considered that the low salinity of the surface layers in the drift region of the *Fram* was due to the fact that these layers are formed as a result of mixing of Atlantic water for the most part with water of the Siberian rivers. This explanation is correct, but the influence of the river water in this phenomenon is not basic and decisive.

Let us assume that wind-caused mixing is completely absent in a certain region. Let us assume further that a layer of ice is formed in this region. The entire layer which is involved in vertical winter circulation is of course salinified. During the summer, after the ice has completely or partially melted away, the extreme upper layer becomes entirely fresh. Now, if we assume that there exists in the given region even a slight mixing due to wind, then as a result, the layer of thaw water mixes with the lower layers and gradients of salinity are formed. But the thickness of ice which forms during the winter and melts away during the summer varies from year to year and in different regions. Masses of ice are constantly carried away from the regions of their formation and melting and they move faster than the water at the lower boundary of the vertical winter circulation. If we recall that the eddy heat-conductivity is greater than the eddy diffusion,

we may then consider that as a result of these processes there is created the distribution of temperature and salinity which is observed in the surface layers of the Arctic Basin.

From an examination of the vertical distribution of velocities in the upper layers of the Arctic Basin (from 0 to 400 m) we see that the velocity, let us say, between levels 75 and 100 m, although also in the direction towards the straits between Spitzbergen and Greenland, is considerably less than the speed of the topmost layers. From this it follows that the water which lies at a depth of 75 to 100 m is "older" than that of the upper layers. And since, other conditions being equal, more ice is formed during the winter, the greater is the depth of the vertical circulation, it follows that these layers will retain traces of the most intense ice formation for a very long time.

As we have seen, there are regions in the Arctic Basin where the floating ice during the course of the winter is constantly carried away from the shore and from the fast ice. In these regions there occurs a more intense ice formation, and as a result, a more intense salinification of surface strata. There are also other factors in the Arctic Basin (besides the coastal drainage and decompressive currents and winds) which have an influence on freshening and salinification of surface strata. Worthy of attention in this respect are the phenomena connected with the concept of limit to the thickness of many-year-old ice. Actually, if ice is carried by currents or winds into regions where its thickness is less than the limit thickness of ice of this region, here there will occur a supplementary ice formation and consequently a salinification. Conversely, if ice is carried into a region where its thickness is greater than the limit thickness, melting will commence, and as a result, a freshening of surface strata. Thus, the surface arctic water has its main origin not only in the mixing of river water with Atlantic water, but is also caused by other extremely complex processes, the most important of which is the melting of ice segments which jut out deeply from under the lower surface of the ice fields. Here we may only emphasize that a level upper surface of pack ice fields (absence of hummocks or smoothing over of them) compels us to assume that the lower surface of the pack fields is also levelled by the washing action of the water.

Upon analyzing the distribution of salinity observed by the expedition in 1935 in the Kara Sea, I was struck by the following circumstance. At the numerous observation points in the northern part of this sea the salinity of the cold surface layers was everywhere lower than, for example, in the oceanographic sections located more to the south, and in particular, along the section which traversed the whole of the Kara Sea at about 79° north.

It turned out that a peculiar belt of surface water of comparatively high salinity was located between Franz Joseph Land and the central part of Severnaya Zemlya. I explain the origin of this belt of increased salinity in the following way:

1. In the region of increased salinity, the deep Atlantic water (flowing here as a deep current from the central arctic) rises to the surface due to the decrease in depth of the sea, and mixing with the surface water, increases its salinity.

2. The region of increased salinity is located at approximately the transition point from the great ocean depths to the lesser depths of the continental shelf. On this account, here exactly should be observed great tidal amplitudes, great speeds of tidal currents, and consequently, increased lateral mixing.

3. In the region of increased salinity the ice during the winter season is constantly broken off and carried away to the north by winds. On account of this, intensive ice formation occurs here entailing the salinification of the surface layers.

The observations of the station "North Pole" confirmed by ideas about the presence of a belt of water of relatively high salinity, embracing, at least in the European-Asiatic sector, the central part of the Arctic Basin. Actually, the lowest salinity of arctic surface water appeared near the North Pole and it increased toward the south. In addition, the salinity of arctic surface water in the drift region of the station "North Pole" was less than the salinity at the northern observation points of the *Sadko* in 1935.

More striking is a comparison of salinities observed in Chuckchee Sea with salinities in the Arctic Basin in the region to the north of Wrangel Island. In the whole of Chuckchee Sea, including the Bering Strait, even in summer the 32 o/oo isohaline does not descend below 30 m. In addition, from the Bering Straits to Wrangel Island there stretches a tongue of water of salinity over 33 o/oo. But to the north of Wrangel Island the level of the 32 o/oo isohaline gradually descends. At 73°30' north, 184°30' east it descends to 40 m and finally, at the oceanographical observation points between 78°27' and 81°32' north, 176°32' and 190°10' east, it descends to 60 m.

There is now a complete basis for assuming that in the central part of the Arctic Basin the surface water is not salinified, but on the contrary is freshened. This remarkable and hitherto unnoticed phenomenon may be explained only by the fact that the summer melting here exceeds the winter freezing.

For a definitive decision on this question, however, there is needed a more precise analysis of existing observations than I have as yet made. In any case, the stability of the arctic surface water is increased by this freshening thereby hindering the deep diffusion of vertical winter circulation with the lower waters.

How limited this exchange is may be judged by the following: In summer there are very many diatoms in the ice of the Arctic Basin and in the surface water. However, in the bottom deposits of the deep part of the Arctic Basin, according to T.I. Gorshkov, diatoms are not found.

LITERATURE: 47, 77, 112, 164, 165.

Section 147. Atlantic Water

Although conjectures concerning the entry of Atlantic water into the Arctic Basin had been expressed even before the *Fram* expedition, Nanson was the first explorer to find this water in the arctic and explain its significance.*

In the Arctic Basin and its surrounding seas we find water of various temperatures and various salinities. We have seen that the water exchange of the Arctic Basin with the Pacific Ocean is extremely limited. The water exchange with the Barents Sea is slightly greater, but the main exchange is with the Greenland Sea. In other words, the entire saline supply of the Arctic Basin is of Atlantic origin.

*Refer to the well known report "On Through to the Pole" by Makorov which he wrote in 1897 before the publication of the results of Nansen's expedition.

Having only the temperature observations of the *Fram*, and expressing regret that there had not been published the specific gravities which would have made it possible to determine immediately the source of the warm stratum which was found, Makarov says: "We may say that the warm water at 200 to 800 m should be more saline than the surface water or otherwise it would rise upwards and not remain below. Since there are in the Arctic Ocean many reasons for decrease of salinity, it is therefore evident that the water which occurs at the 200 to 800 m layer comes from the southern latitudes."

We have also seen that the coastal drainage and ice behavior play a large role in the formation of the water in the Soviet Arctic seas. The Atlantic water in them is therefore greatly diluted. The question arises as to what can be considered as Atlantic water in the arctic? It is clear that the limits both of temperature and salinity of this water can be only extremely arbitrary.

According to Nansen, the signs of Atlantic water in the arctic are, first, positive temperature, and second, high salinity (about 34.0 o/oo). The salinities determined by Nansen turned out to be somewhat too high. Let us take, therefore, as the lower limit of salinity of Atlantic water a salinity of 34.5 o/oo.

Figure 150 shows, according to Dobrovolski, the isotherms of the warm Atlantic layer at a level of 300 m. The observations of the station "North Pole", the *Sedov*, and those of ships which worked on the periphery of the Central Arctic Basin were employed for compiling this drawing. For the region to the north of Wrangel Island, the drawing was completed with data of the Libin-Cherevichny expedition of 1941.

Table 111 shows the averaged values of temperature and salinity in the work region of the Libin-Cherevichny expedition of 1941. Table 112 shows the vertical distribution of oxygen at one of the observation points of this expedition.

In both tables the warm Atlantic water is clearly defined. The maximum temperature was observed at a level of 500 m and was equal to 0.72° with salinity 34.97 o/oo. Thus we may now consider that the penetration of warm Atlantic water into the region to the north of Wrangel Island has been decisively proven.

As may be seen from table 112, the content of oxygen, supersaturating the water in the upper levels, decreases comparatively little in the warm Atlantic layer. This fact indicates a small expenditure of oxygen in this layer for oxidation processes, in particular for life activity of organisms.

From figure 150 it may be seen that the basic core of Atlantic water extends to the east from the straits between Greenland and Spitzbergen, swerves to the right, and puts out tongues into the troughs as it goes from the great depths into the northern parts of the surrounding seas. Two tongues enter Barents Sea from the north--one between Spitzbergen and Victoria Island and the other between Victoria Island and Franz Joseph Land. Two tongues also jut into the northern part of the Kara Sea--one between the *Sadko* shoals and Severnaya Zemlya, and since the depths are greater in the western trough than in the eastern, the warm layer here extends more to the south.*

In the Laptev Sea only one tongue has been noted, and since the great depths here extend farthest to the south, the warm layer also penetrates more to the south than in all the other troughs.

The maximum temperature of the warm layer is not always found at the same level. Over great depths it is generally observed at 400 m. On the periphery this depth decreases and in the region to the north of Novaya Zemlya it drops to 150 m. Thus, in the furrows which stretch out from the central basin, the Atlantic layer climbs up along the continental slope and further onto the continental shelf.

*The first signs of warm Atlantic water entering Kara Sea from the north were discovered by Makarov in 1901. This fact was conclusively established by the *Sedov* in 1930.

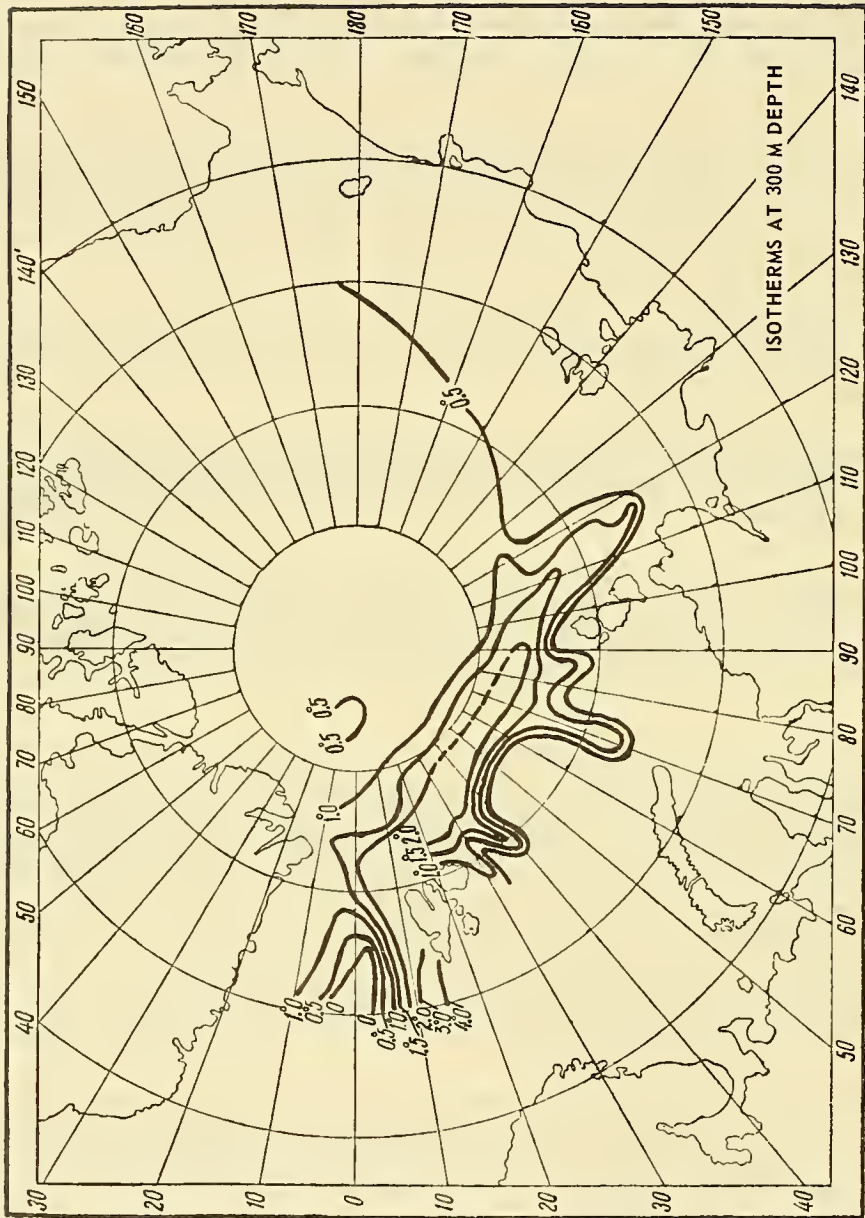

Figure 150. Isotherms at 300 m depth in the Arctic Basin.

TABLE 111. AVERAGE VALUES OF OCEANOGRAPHIC FEATURES IN THE REGION BETWEEN 78°27' AND 81°32' NORTH, 176°32' EAST AND 169°50' WEST ACCORDING TO THE OBSERVATIONS OF THE AIRPLANE N-169 EXPEDITION, 2 THROUGH 28 APRIL 1941

Depth in meters	t°	$S\ o/oo$	Depth in meters	t°	$S\ o/oo$	Depth in meters	t°	$S\ o/oo$
0.5	-1.70	31.60	150	-1.31	34.08	700	0.24	34.83
2	-1.66	29.32	200	-1.05	34.48	750	0.16	34.09
5	-1.65	30.40	250	-0.36	34.62	800	---	34.90
10	-1.66	30.48	275	-0.21	34.70	850	0.05	---
20	-1.68	---	300	0.15	34.78	900	0.00	34.92
25	-1.68	30.91	350	0.47	34.83	1000	-0.06	34.95
30	-1.68	---	400	0.60	34.91	1250	-0.28	---
50	-1.61	31.74	500	0.62	34.89	1300	-0.29	34.97
75	-1.56	32.48	550	0.59	---	2000	-0.41	34.96
80	-1.56	---	600	---	34.89	3000	-0.31	34.96
100	-1.54	32.78	650	0.49	34.96	3350	---	34.99

TABLE 112. VERTICAL DISTRIBUTION OF OXYGEN AT 79°53.5' NORTH, 169°59' WEST ON 28 APRIL 1941 ACCORDING TO OBSERVATIONS OF THE N-169 EXPEDITION

Depth in meters	t°	$S\ o/oo$	O_2	$O_2\ o/o$
2	-1.70	31.11	9.16	104.9
10	-1.69	31.00	9.10	104.4
25	-1.68	30.95	9.33	107.5
250	---	34.67	7.32	89.7
300	0.15	34.81	7.24	90.2
500	0.70	---	7.25	91.8
750	0.20	---	7.19	89.9
1000	-0.06	34.94	7.40	92.2

It must be noted further that the thickness of the warm layer (within the limits of positive temperatures) decreases in a direction towards the periphery. For example the average thickness of the warm layer in the drift regions of the station "North Pole" and icebreaker *Sedov* and in the region north of Wrangel Island was about 600 m; in the northern part of the Laptev Sea about 400 to 520 m, in the northern part of the Kara Sea about 300 m, and north of the Spitzbergen Franz Joseph Land line about 280 m. Thus the thickness of the Atlantic layer everywhere decreases as it moves into the lesser depths.

Figure 151 shows an oceanographic section between Franz Joseph Land and Vize Island approximately along 79° north made by us in 1932 on the *Knipovich*. This drawing gives a graphic idea of how the Atlantic water moves along the St. Anna trough to the south towards Novaya Zemlya.

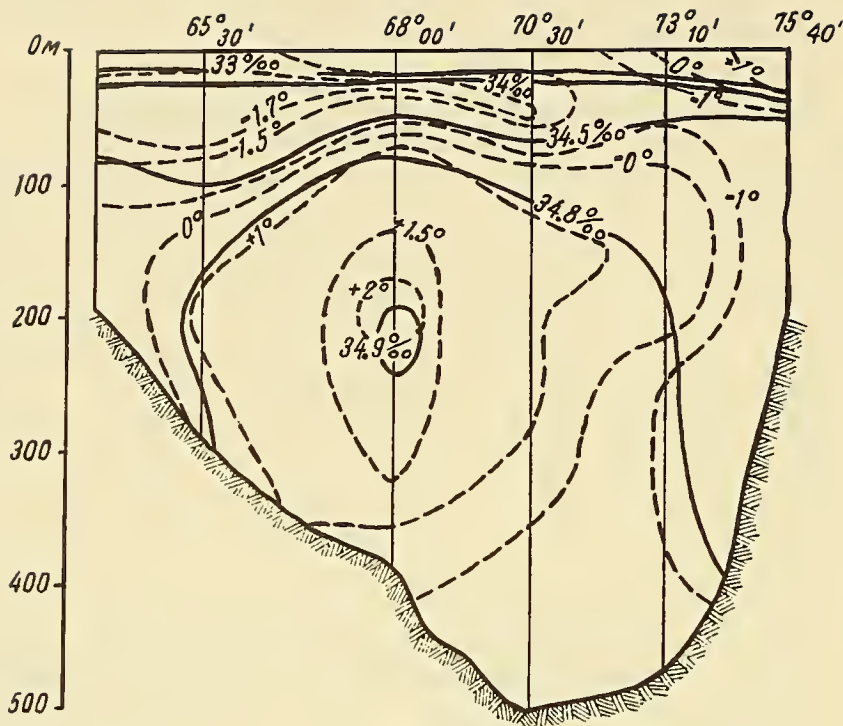

Figure 151. Temperature and salinity of a section along 79° north latitude in the Kara Sea between Franz Joseph Land and Vize Island.

Figure 152 is an oceanographic section which I have constructed according to preliminary data obtained by the *Sedov*. From the drawing we see how during the *Sedov's* drift toward the north the temperature of the warm layer dropped, and during the drift to the south the temperature rose.

Returning to figure 150, on which the isotherms are drawn at intervals of 0.5° , we see that in an easterly direction the distance between isotherms is large, while in a southerly direction the isotherms are close together. The same occurs also for all other depths and testifies to the fact that the Atlantic water when passing over great depths cools considerably slower than when it rises up onto the continental shelf. This fact will become still clearer if we take into consideration the fact that as the warm layer rises up onto the shelf its thickness simultaneously decreases. The cooling of the warm layer, of course, occurs basically in a vertical direction.

Calculations made by Dobrovolski have shown that the quantity of heat which the warm layer gives off in an upward direction, that is, in the final result into the atmosphere, amounts in all to about 3 kg-cal per square cm per year. This value is extremely small in comparison with that for example, in the Barents Sea between North Cape and the meridian of Kolski where every square cm of sea surface gives off about 120 kg-cal per year. It must be emphasized, however, that the heat

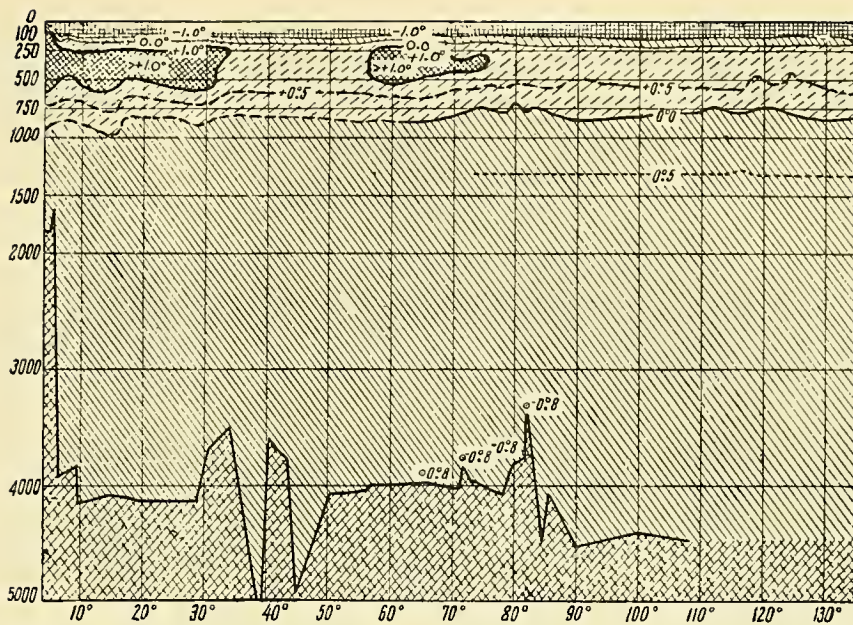

Figure 152. Depths and Oceanographic Section in the Arctic Basin along the drift track of the *Sedov*.

given off by the sea to the atmosphere in the Arctic Basin is made up not only of the heat which is lost by the warm layer. During the course of the summer the ocean here stores up a considerable quantity of heat as a result of the rise in temperature of the ice, melting of a part of its thickness, and some heating of the water between floes and under them. During winter, the heat which has accumulated in the summer returns to the atmosphere.

Finally, we must recall that huge masses of ice are carried out of the Arctic Basin every year into the more southerly latitudes and mainly into the Greenland Sea. Ice in the sea is actually concentrated cold which has accumulated during the winter. Every gram of ice represents 80 calories. If we accept very cautiously the fact that every year there is carried out of the Arctic Basin an area of only one tenth of its whole ice cover, of thickness about 300 cm, or in other words, about 30 cm of ice from the whole area of the Basin, then this likewise amounts to about 3 kg-cal per square cm.

More remarkable with respect to the warm layer is the fact that in the central part of the basin the temperature of the layer steadily decreases in a northern and eastern direction, but the depth of the maximum remains practically unchanged. Observations made up to this time show the occurrence of such a maximum at a depth of about 400 m.

If the vertical coefficient of mixing were the same in both the upper and the lower layers, then, since the temperature gradient is greater in the upper layers than in the lower, the depth of the temperature maximum would of course descend with the passage of time. The fact that this maximum remains at approximately the same depth despite the lowering of the temperature of this maximum over the course of time, proves that here an equilibrium is comparatively quickly reached; i. e., the flow of heat directed upwards from the warm layer is equal to the flow of heat directed downwards from this layer. This may be explained only by the fact that, despite the observed difference of temperature gradients, and despite the fact that the gradients of horizontal speed are

greater in the upper layers than in the lower (which also intensifies the mixing), causes exist which retard the diffusion of heat upwards. It is not difficult to see that these causes consist of the fact that the stability of the layers located above the warm layer is very great, while the stability of the strata below it is very slight.

LITERATURE: 45, 72, 77, 101, 164, 165.

Section 148. Deep Water

We have seen that water of positive temperature and high salinity in the Arctic Basin is conventionally considered as Atlantic water. The conventionality of such a designation is particularly marked in determination of the boundary between intermediate Atlantic and deep water which, as we shall see below, is properly called Greenland water.

Actually, all temperature-salinity curves constructed for observation stations of the Arctic Basin show that homogeneity in respect to salinity (from 34.7 to 34.9 o/oo) commences approximately at depths of 300 to 400 m. The lower limit of positive temperatures is found, at a distance from the shores, at depths of 700 to 800 m, while uniformity in temperature (from 0.5° to 0.9°) commences at a depth of 1,500 m.

The fact must be noted, nevertheless, that the greatest temperature gradients below the level of the Atlantic water axis are located everywhere at depths of 500 to 800 m. Thus the lower zero isotherm coincides approximately with the lower limit of the large temperature gradients. There is every basis for supposing that the large vertical temperature gradients are a result of comparatively large velocity gradients. We may consequently consider that in the Arctic Basin the Atlantic water is separated from the deep Greenland water by a zone of lateral mixing.

The origin of the deep water of the Arctic Basin was analyzed in detail by Nansen in connection with the *Fram* observations. In addition, during the expedition on the *Veslem* in 1912, Nansen made a series of observations for the purpose of checking his original conclusions and he arrived at the same results. These conclusions are as follows:

1. The deep water of the Arctic Basin is warmer than the deep water of the Greenland sea at the same depths. Proceeding from this fact, Nansen came to the conclusion that between the north-eastern end of Greenland and the northwestern end of Spitzbergen there must exist an underwater ridge on which the depth must not exceed 1500 to 2000 m. This ridge must limit the water exchange between the deep water of the Greenland Sea and the Arctic Basin and must explain the comparatively high temperatures of the deep water of the Arctic Basin by comparison with the deep water of the Greenland Sea.

The existence of such a ridge is unquestionable but it has not yet been proven by direct observations. It has been decided to call it the Nansen ridge.

2. The deep water of the Arctic Basin is formed in the Greenland Sea from Atlantic water at approximately 75° north and at 0° longitude as a result of vertical winter circulation. It then passes over the Nansen ridge and goes on to spread out along the bed of the Arctic Basin.

Nansen illustrates his conception of the origin of the deep water of the Arctic Basin with a diagram of an oceanographic section (figure 153), made from the Faeroe Islands north, approximately along the Greenwich meridian.

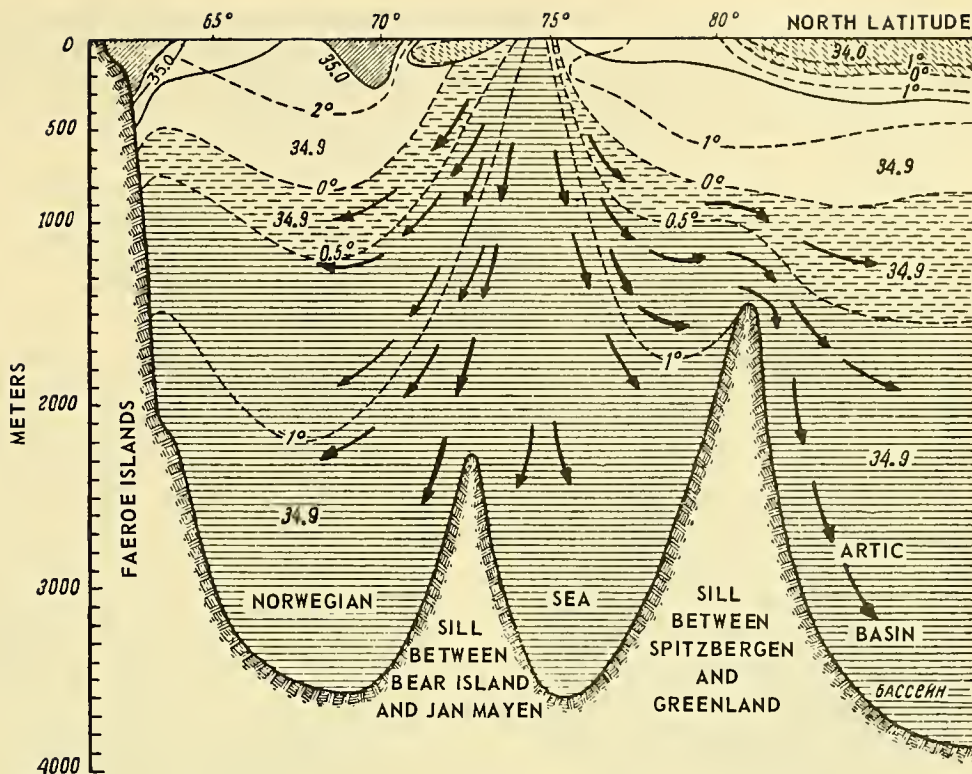

Figure 153. Oceanographic Section from Faeroe Islands through the Greenland Sea and Arctic Basin.

3. In the Arctic Basin proper the deep Greenland water evidently moves in the same direction as the intermediate Atlantic water (although considerably slower), describing a closed circulation around the Pole.

In its course around the Pole this water is partly heated by the internal heat of the earth from below and partly by the heat of the Atlantic water from above and it is cooled by the new entry of water from Greenland Sea.

There is as yet little data at our disposal which would refute or would substantially supplement these conclusions of Nansen. We may only point out that the absence of diatoms in the silt of the deep part of the Arctic Basin, which has already been noted above, likewise testifies to the fact that the arctic deep water is actually reprocessed Atlantic water.

Figure 154 shows (according to Nansen) an oceanographic section extending along the axis of the Spitzbergen current. Here may be seen not only the distribution of deep water in the Greenland Sea but also the diagram of penetration of warm Atlantic water into the Arctic Basin.

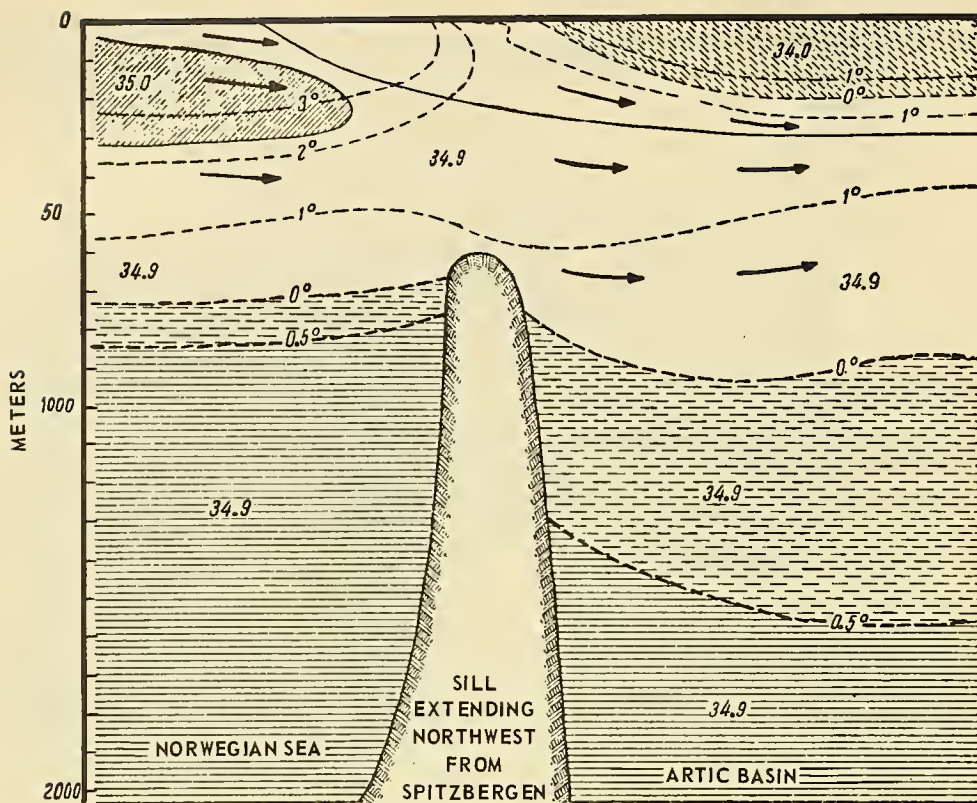

Figure 154. Oceanographic Section along the Axis of the Spitzbergen Current through the Greenland Sea and Arctic Basin.

LITERATURE: 61, 164, 165.

Section 149. Drift of Vessels and Buoys

It is clear that the general circulation of arctic ice is linked with the arctic surface current, which is in turn caused in part by this circulation. This circulation is most fully evident from examination of the drift of vessels and buoys along with the arctic ice.

Such drifts are schematically shown in figure 155.

The following peculiarities of these drifts are worthy of attention:

1. From Point Barrow and up to the straits between Spitzbergen and Greenland there is a constant drift from east to west. This drift is confirmed by:

a) drift of ship *Karluik* in 1913 to 1914 for a distance of about 500 miles, approximately from Point Barrow to Wrangel Island.

b) drift of ship *Zhannetta* in 1879 to 1881 for a distance of about 730 miles from Wrangel Island to the New Siberian Islands.

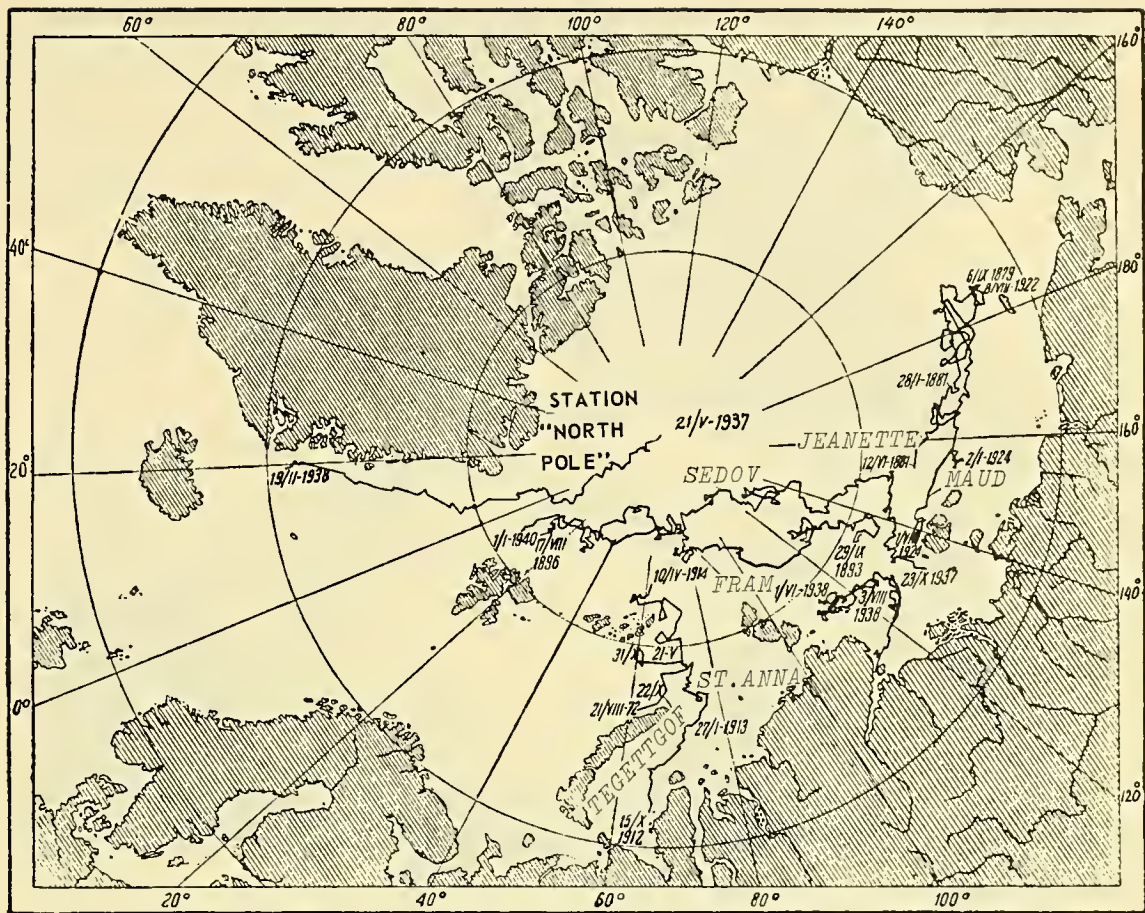

Figure 155. Drift of ships together with ice in the Arctic Basin.

c) drift of icebreaker *Sedov* in 1937 to 1940 for a distance of about 1500 miles from the New Siberian Islands to the strait between Spitzbergen and Greenland.

From this list and from figure 155 we see that the drifts of the ships *Zhannetta* and *Maud* on the one hand, and those of the *Fram* and *Sedov* on the other, while differing in details, generally repeat each other. This testifies to the stability of the general movement of ice from east to west along the continental slope of the Eurasian continent - a movement which Lomonosov wrote about and which Nansen employed so brilliantly for his expedition on the *Fram*.

2. The drift of the ship *St. Anna* in 1912 to 1914 from the Kara Sea, and drifts of icebreakers *Sadko*, *Sedov* and *Malygin* in 1937 to 1938 from the Laptev Sea, demonstrate the transfer of ice from these seas into the central part of the Arctic Basin and their subsequent conjunction with the general drift of arctic ice from east to west. The same phenomenon is confirmed by figure 156, on which are shown, according to Vize, the most probable routes of buoys thrown onto the ice by Soviet expeditions.

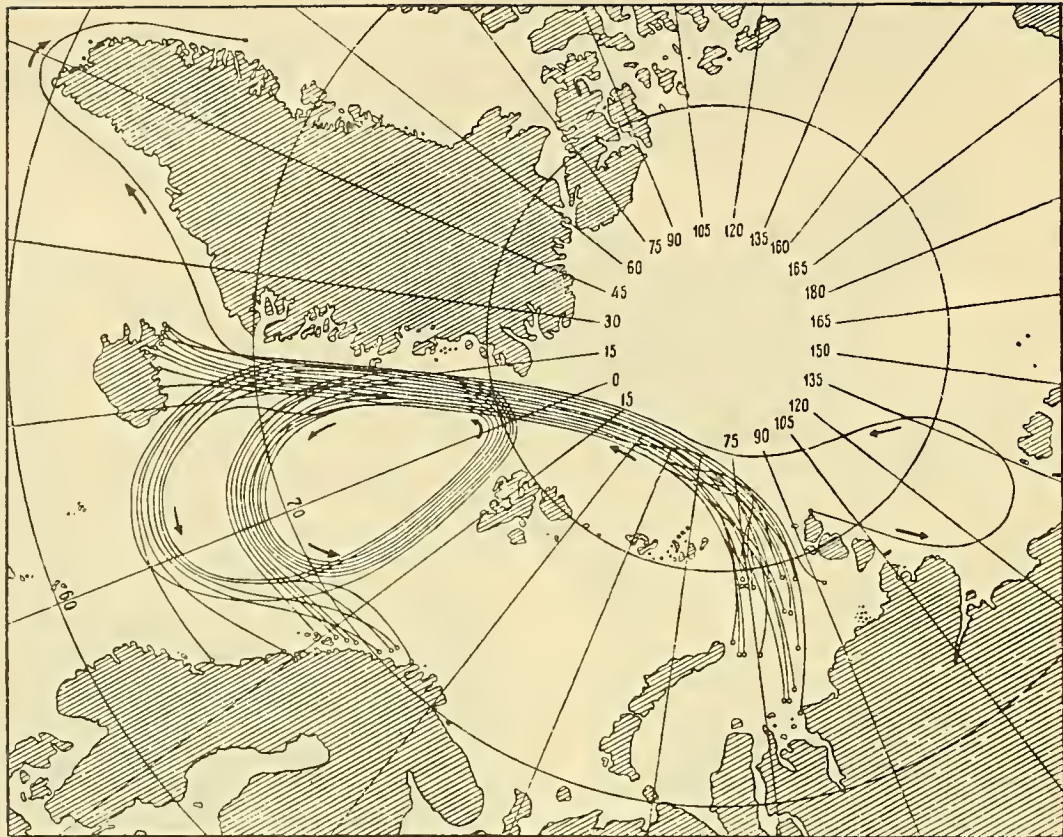

Figure 156. The probable drift of buoys in the Arctic Ocean.

Thus, from examination of drifts of vessels and buoys it appears that if one goes from Franz Joseph Land in a direction towards the Pole, he would first cross ice carried out of the Kara Sea (up to approximately 84° north), and then he would cross ice carried out of the Laptev Sea (up to approximately 86° north).

At the same time there is no indication of to what extent such seas as the East Siberian and Chuckchee are connected with the basic drift of arctic ice. From this it follows, apparently, that the Kara and Laptev Seas on the one hand and the East Siberian and Chuckchee on the other are quite different in respect to water exchange and ice exchange with the Arctic Basin. In the case of the first two seas, although they have their own circulations, they are nevertheless very closely connected with the circulation of the Arctic Basin. Characteristic of these seas is a great transfer of ice from them into the Arctic Basin. We recall that it is in exactly these two seas that coastal drainage plays the greatest role. In the East Siberian and Chuckchee Seas there is apparently no significant ice-exchange with the Arctic Basin. It is possible that in the case of these seas the inflow of ice even exceeds the outflows.

3. The drift of the camp of the Andre expedition in 1897 shows that a section of ice enters the northwestern part of the Barents Sea from the Arctic Basin.

4. In addition to the ice circulation connected with the basic circulation of the Arctic Basin, each sea has its own ice circulation in an approximately counter-clockwise direction. This is demonstrated by the drift of the ship *Tegettgof* in 1872 to 1873 from Novaya Zemlya to Franz Joseph Land in the Barents Sea, by the drift of the ships *Dimfna* and *Varna* in 1882 to 1883 in the Kara Sea (figure 157), by the drift of the caravan of the icebreaker *Lenin* in 1937 to 1938 in the southwestern part of the Laptev Sea, and by the drift of the steamship *Chelyuskin* in 1933 to 1934 in the Chuckchee Sea (figure 158).

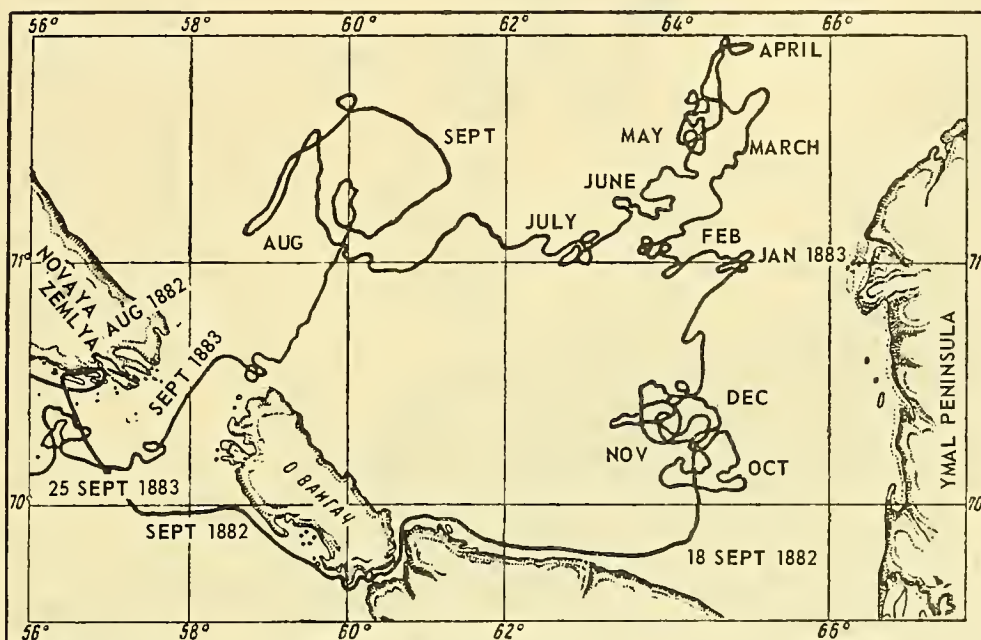

Figure 157. Drift of the *Dimfna*.

5. The ice exchange between neighboring seas is likewise demonstrated by drifts of certain vessels. Thus, the ship *Dimfna* was carried by the ice out of the Kara Sea through the "Kara Gates" into the Barents Sea. The ship *Belgica* in the summer of 1907 was carried out of the Kara Sea from the straits of Matochkin Shar through the "Kara Gates" into the Barents Sea. The ice-breaking steamship *Solovei-Bodimitovich* in February 1920 was carried from the Barents Sea into the Kara Sea likewise through the "Kara Gates" (figure 159). In the summer of 1937 many vessels, including the *Sadko* and a whole caravan of ships headed by the icebreaker *Lenin*, were carried by the ice from the Kara Sea into the Laptev Sea.

6. As may be seen from the drift of the station "North Pole" in 1937 to 1938 and that of the *Sedov* in 1937 to 1940, there is an ice drift in a direction from the North Pole into the strait between Greenland and Spitzbergen.

7. According to the observations of Peary during his expedition from the North American coast to the North Pole, the ice drift along the north coast of Greenland was also directed into Greenland Sea.

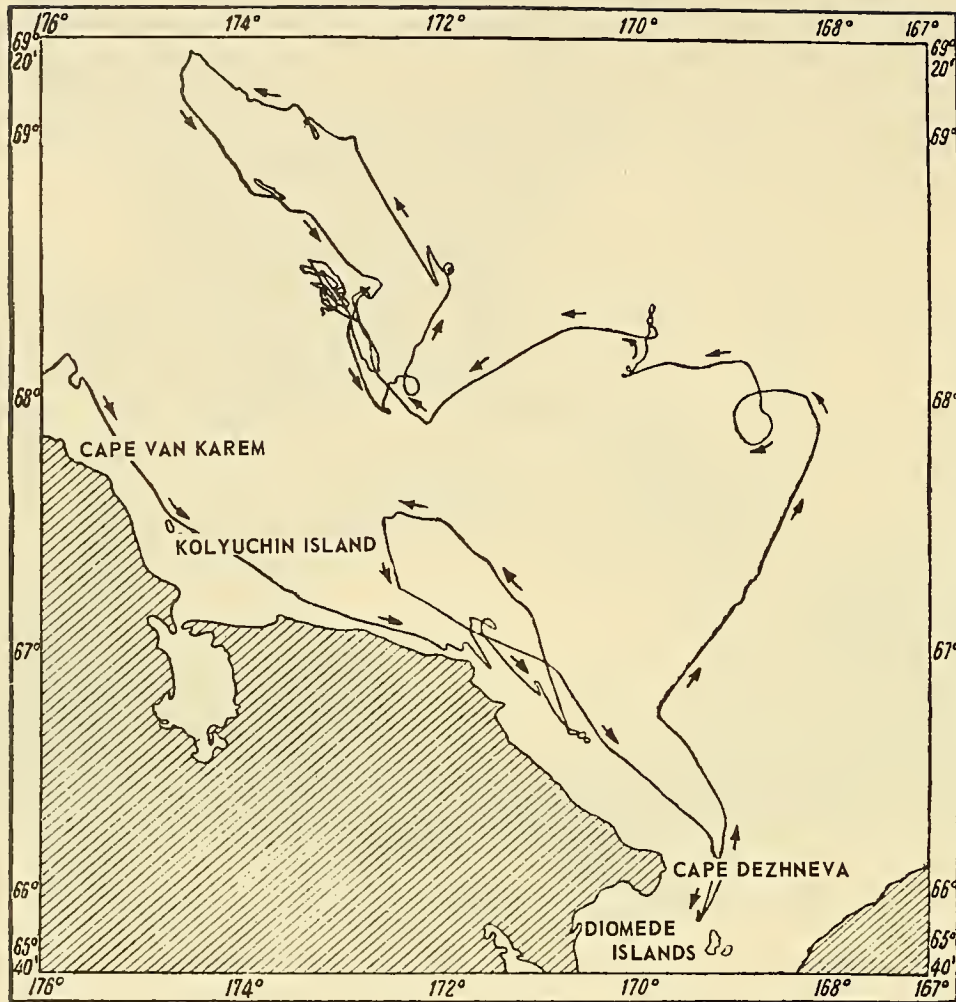

Figure 158. Drift of the *Chelyuskin*.

Thus, the general scheme of drift of arctic ice appears fairly clear, and at first glance, simple: from the coast of Alaska, from the North Pole, and from the coasts of the North American Archipelago into Greenland Sea. However, there is very weighty evidence that the ice drift occurs according to a more complex scheme. It is proposed, for example, that the ice drift along the continental slope of Alaska and Asia from east to west is only a part of a broad anticyclonic movement with its center at approximately 83° - 85° north, 170° - 180° west. Such a supposition was first expressed as a result of the work of the polar expedition on the ship *Zarya*. Information since received does not contradict, but to a certain degree even confirms this proposed scheme.

Figure 160 shows, by means of arrows, surface currents in the Arctic Ocean. For compilation of this chart I have used maps of currents of the following authors: Smith (Baffin Bay), Meyer (North Atlantic), Nansen (Norwegian Sea), Berezkin (Greenland Sea), Sakolov (Barents Sea), Kireyev (Kara Sea), Lappo (Laptev Sea), Ratmanov, Gakkel, and Khmyznikov (Chuckchee Sea).

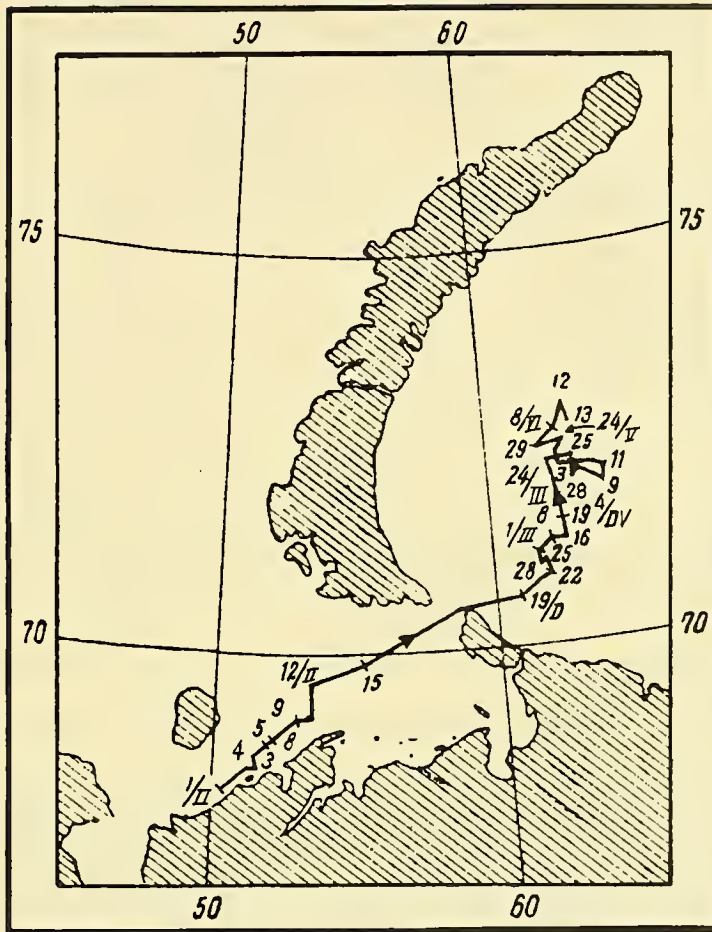

Figure 159. Drift of the *Solouei-Budimirovich*.

Examining figure 160, we see that the more a given sea has been studied, the more complex its circulation appears. This can only mean that the circulation of ice in the Central Arctic Basin is hardly as simple as we have hitherto believed.

One feature of the general circulation of ice in the Arctic Basin is worthy of special mention. The drift of ice depends on two factors: Sea currents and wind. It is obvious that ice which rides with approximately 4/5 of its thickness in the water is carried along by surface sea currents. It is also clear that this ice is subject to wind action, which drives it ahead, blowing against the projections and uneven parts of the ice field. But the effect of these factors is not equally felt in different regions. In regions of strong permanent currents, for example in the Greenland Sea, the influence of wind is weakened. In the Central Arctic Basin, where permanent currents are weakly defined, the drift of ice submits easily to the wind.

During the drift of the *Sedov* determinations of the true course of the ship were taken regularly. These observations made it possible to follow a most interesting phenomenon: no matter what loops and zigzags the ship described while drifting along with the ice toward the west, it

The *Sedov*'s drift parallel to itself is by no means surprising. The *Fram* and the station "North Pole" in exactly similar fashion experienced no rotation, although they too described fantastic zigzags under influence of the wind. Such a three-fold concurrence demonstrates with sufficient conclusiveness that in the drift are great ice areas participating simultaneously which moves in the same direction, obeying winds of the same strength and direction.

Finally, we also find confirmation of this condition in the surprising similarity of the drifts of the *Sadko* and *Lenin* caravans in the Laptev Sea in 1937 to 1938, the drifts being different only in the details. Both caravans, being subjected to the same winds, repeated the same zigzags.

During this type of movement, which was generally parallel to itself, the *Sedov* occasionally made a turning movement relative to the general direction. The amplitude of such turns from July through December 1939 was up to 23° . These turns may be explained not only by local causes connected with formation of local polynyas and water openings, but also by more general causes.

Thus, for example, these turns could be caused by the fact that the ice which moves from the New Siberian Islands towards Greenland as it drifts southwest pushes its southern edge into the northern end of Severnaya Zemlya, Franz Joseph Land and Spitzbergen, thus making the ice turn counter-clockwise. In drifting northwest, the ice runs into the more massive polar ice which is located in the region north of Franz Joseph Land, approximately above the 86th parallel.

LITERATURE: 31, 62, 70, 72, 77.

Section 150. Atmospheric Pressure Over the Arctic Basin

We have seen that the drift of ice is determined by the winds and by the effect of the earth's rotation, and that in the final result it proceeds along the isobars and with a speed inversely proportional to the distance between them. Thus, the distribution of atmospheric pressure which determines the direction of the air currents is reflected in a most decided fashion on the general and local circulation of ice.

The most important centers of atmospheric action for the arctic are:

1. The Iceland low - a deep barometric depression located in the northern part of the Atlantic Ocean, slightly south of Iceland. From this center, a trough of low pressure stretches to the north-east, extending in winter to Severnaya Zemlya and in autumn even to the New Siberian Islands. This trough is formed by the northeast movement of cyclones which have formed on the southern periphery of the Icelandic low.

2. The Aleutian low - situated in the northern part of the Pacific Ocean. It is sharply defined in the winter, while in the summer it is replaced by an area of slightly increased pressure. This low has considerably less influence on the Arctic Basin than the Icelandic low and its sphere of influence extends for the most part, only into the Chuckchee Sea.

3. The East Siberian high - extremely sharp defined in the winter. In January its center is situated at approximately 60° north, 120° east. In summer this high is completely eliminated and in its place is located an area of decreased atmospheric pressure.

The reversibility of the Siberian high and Aleutian low explains the monsoonal character of winds in the Japan and Okhotsk Seas and likewise the monsoonal character of winds of the Soviet Arctic. This feature is most clearly evidenced in the Laptev and East Siberian Seas. In the Chuckchee Sea it is slightly obscured by other and stronger factors.

According to Vize, a change of winds from the Atlantic - continental group (south, southwest, west) to winds of the Polar group (north, northeast, east) occurs along the whole Soviet coast in April, and a reverse change in September. Figure 161 shows the variability of intensity of winds of Polar and Atlantic-continental groups according to Vize.

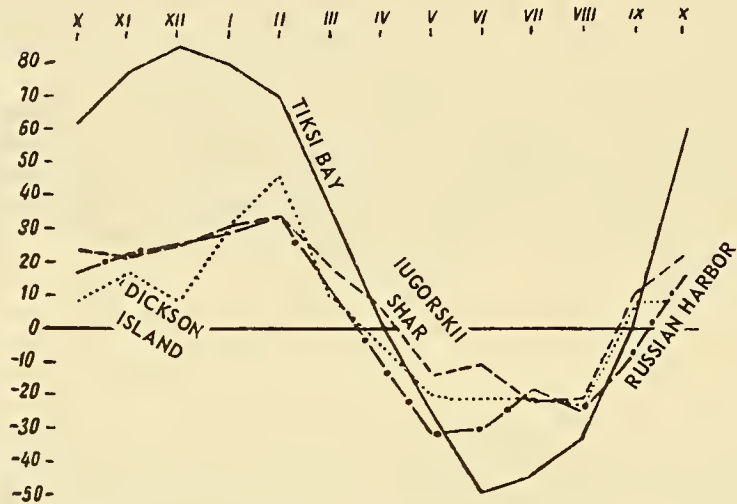

Figure 161. Variability of intensity of Atlantic, continental and polar winds.

4. The Arctic high - located over the Central Arctic Basin, and the Greenland and Canadian highs which are part of its system. Little is known of the formation of this system.

It would be natural to assume that the Greenland and Canadian highs, located over large land expanses, should be especially clearly defined in the winter like the East Siberian high. In the summer the Canadian high, like the East Siberian, should be replaced by an area of decreased pressure. The arctic high itself, on the contrary, should be lessened in the winter, since despite the fact that the Arctic Basin is almost completely covered with ice, it nevertheless transmits to the atmosphere a considerable amount of heat in the winter during formation of additional ice layers. In the summer on the other hand, the arctic high should to all appearances join up with the Greenland high and occupy a greater expanse.

Figures 162 to 165 show the seasonal distributions and in figure 166 the annual distribution of atmospheric pressure over the Arctic Basin. These charts were compiled by Dzerdzeyevski as the average for 1937 to 1939. Three years is too short a period to permit us to ascribe climatologic significance to these maps. Their advantage lies in the fact that, in contrast to other maps, they are based on actual observations in the central arctic, made by the station "North Pole" and the icebreaker *Sedov*.

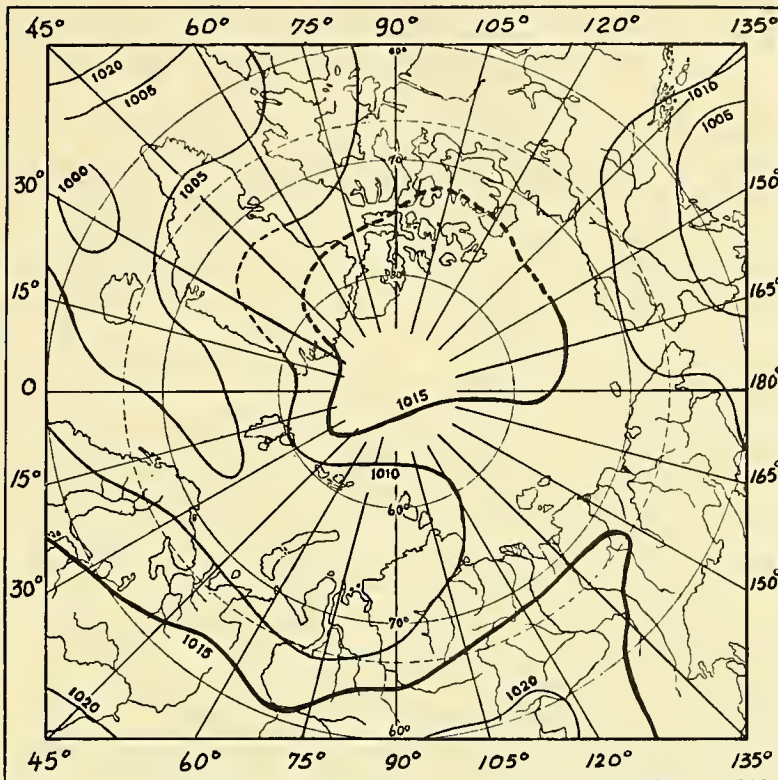

Figure 162. Average atmospheric pressure for September through November, 1937 to 1939.

From these maps it is evident that on the average, over the entire year, the Arctic high is sufficiently defined and is separated from the East Siberian high by a belt of low pressure joining the Iceland and Aleutian lows.

In summer, however, contrary to expectations, an area of low pressure is clearly marked in the region extending from the Pole towards the New Siberian Islands.

But the distribution of atmospheric pressure determines the general circulation of ice. If the position of highs and lows varies from season to season, the circulation of ice and its general behavior also varies in accordance.

Anomalies in distribution of pressure have a still greater practical importance for the quantity and distribution of ice along the course of the Northern Sea Route. One of the maps of pressure anomalies compiled by *Kirsh* at my request is shown further in figure 193.

LITERATURE: 70, 72, 77.

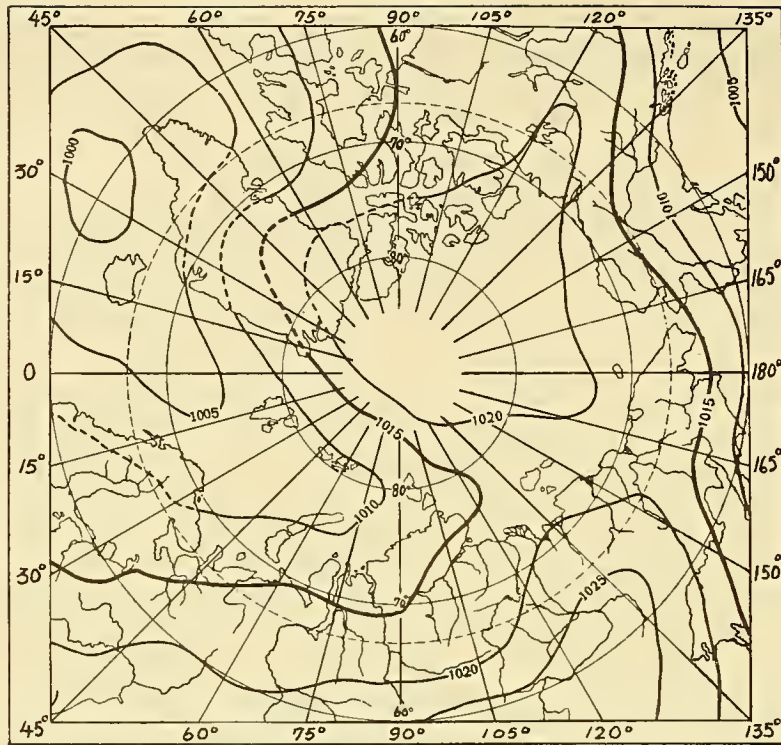

Figure 163. Average atmospheric pressure for December through March, 1937 to 1938.

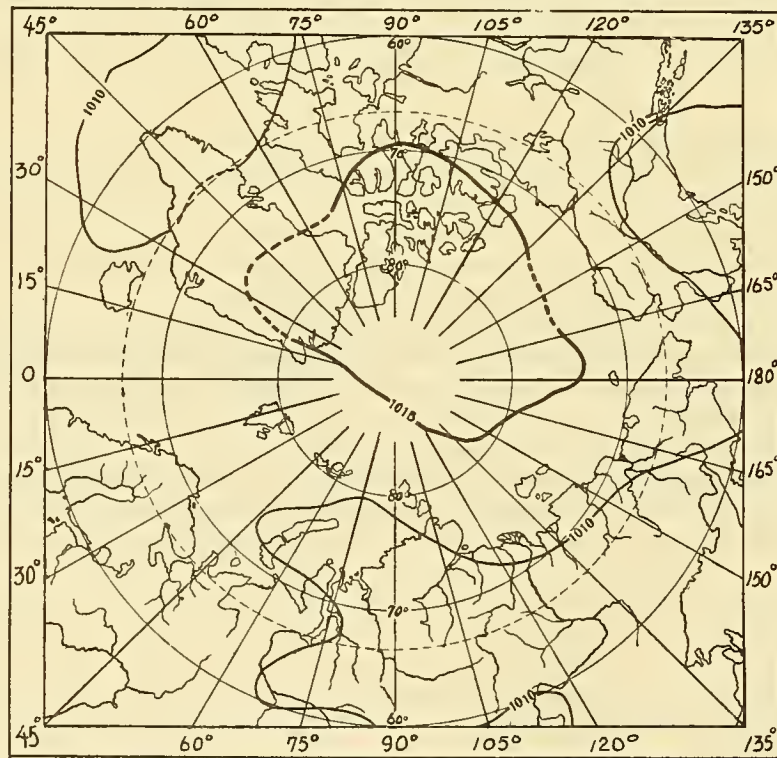

Figure 164. Average atmospheric pressure for April through June, 1938 to 1939.

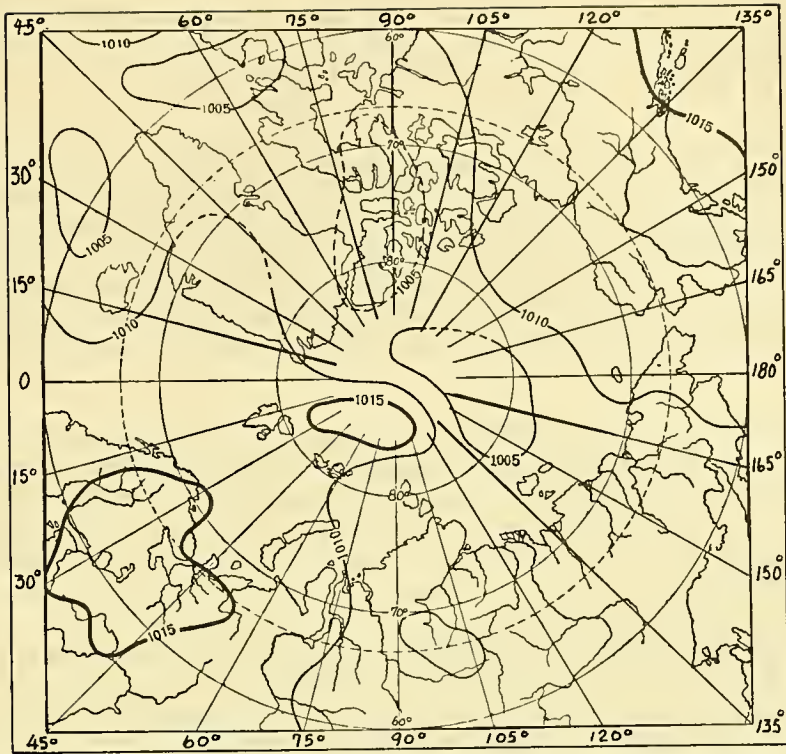

Figure 165. Average atmospheric pressure for June through August, 1938 to 1939.

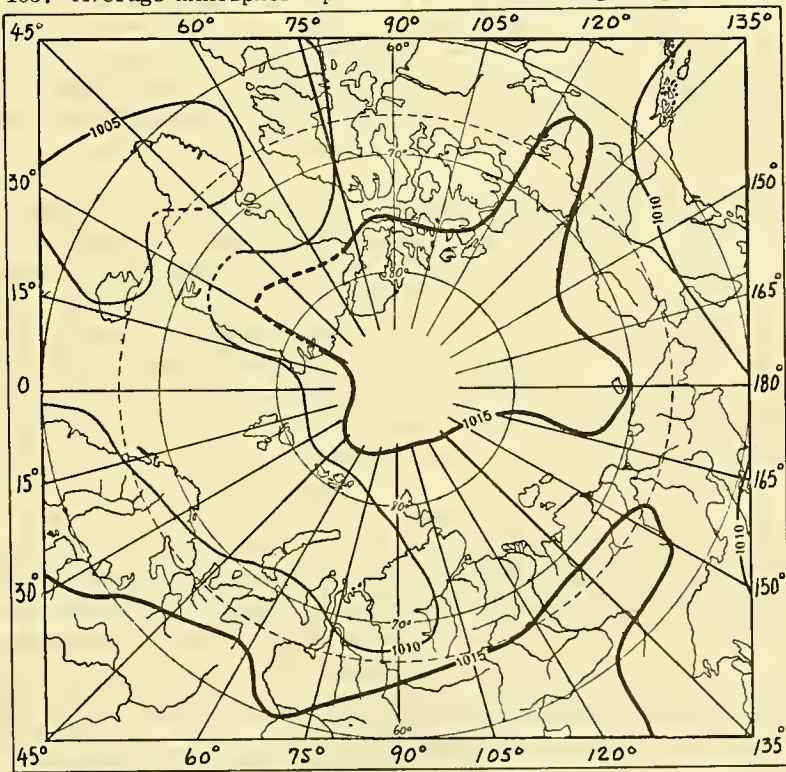

Figure 166. Average atmospheric pressure for 1937 to 1939.

Section 151. Atmospheric Turbulence

Maps of pressure distribution give us an idea of the direction and intensity of winds, while maps of pressure anomalies show the deviations from average conditions.

But when we average the data for any particular time interval, we thereby exclude all variations of the observed factor in the same value but with opposite sign. Thus, measuring the factors of sea currents at one particular geographical point of the sea and then adding up the results, we automatically exclude all periodic currents, and, in particular, tidal currents. These very tidal phenomena, however, may be reflected in a most decided fashion on sea behavior and on ice conditions.* The same reasoning may obviously be applied to the atmosphere. For the study of ice behavior as conditioned by winds, it is necessary to know not only the direction and intensity of winds but also their variability in time.

The study of wind roses may be employed for solution of this problem. But it is difficult to translate the wind roses into figures which may be manipulated in the future. Besides, wind roses which are constructed for shore stations may have little resemblance to the wind roses for the same time interval constructed for even the nearest points of the open sea. It is well known that winds are distorted by local conditions. I have therefore preferred to use a different method, as follows, recalling that:

1. Atmospheric pressure is a meteorological factor which is most simply and accurately determined by, and at the same time least dependent on local conditions.
2. All other meteorological factors are either connected with pressure or depend on it directly, which is why the isobars are the basic lines on a synoptic map.
3. A sharp change in pressure always brings about a sharp change in the weather, and in particular, a change in direction and velocity of wind. I have conjectured that we may assume that a pressure change at any geographical point is an index of variability of weather, or in other words an index of atmospheric turbulence.

Let us suppose that on the barograph record at moment t_1 we have a pressure p_1 , and at moment t_2 a pressure p_2 . Let us call a the straightline distance between points on the barograph tape defined by the coordinates t_1 and p_1 and the coordinates t_2 and p_2 . Let us suppose now that the atmospheric pressure at the given point of the earth's surface has changed from moment t_1 to moment t_2 not in a straight line, but in a more or less complex curve. Using a curve measuring instrument, let us take from the barograph record the length of this curve in the same scale as straight line a , and call it b . The ratio $b/a = k$ will be the index of atmospheric turbulence** at the given point for the given time interval. Obviously this index is not less than 1.

*A theory of turbulence of sea in the same sense as we here speak of turbulence of the atmosphere has not as yet been propounded, but it should by all means be put forward. Here we may note only that the wind-caused turbulence of the sea is in part characterized by atmospheric turbulence while tidal agitation is characterized by the length of the orbit of a particle for the tidal, phase, etc.

** (Editor's Note--perhaps "index of large-scale variability in pressure" would be a better phrase here since turbulence in a meteorological sense refers to the irregular local transitory variations in the general airflow and is manifested as gustiness, bumpiness, updrafts and downdrafts).

If we plot on a geographical map the indices of atmospheric turbulence for the same time interval but for different points of the earth's surface, and if we draw the appropriate isolines, we will then obtain the characteristics of individual regions for various months, seasons, and years.

It is not difficult to see that if we take an individual cyclone, during the time of its passage we will find the greatest atmospheric turbulence along the course of its center. Generalizing further, we may say that the indices of turbulence are greater along cyclone paths than along anticyclone paths, since cyclones move faster than anticyclones and the pressure gradients in them are greater. Further, in seasonal pressure regions the turbulence is greater than in permanent regions. The latter fact must be particularly emphasized. In stationary cyclones and anticyclones no matter how great the pressure gradients (and consequently the winds), the indices of turbulence are very close to unity, that is, to their least possible value. The index of atmospheric turbulence attains its greatest value at points of intersection of the paths of pressure system centers.

Thus, while the averaged charts of isobars give a conception of the direction and intensity of air currents, maps of "isoturbulence" of atmosphere which are constructed for the same time interval given us give us an idea of the variability of these currents.

Individual phases of ice behavior depend in the highest degree on the winds. If strong and variable winds of diverse directions prevail in the pre-winter period, we may then expect a strong wind-caused mixing of the upper sea layers in this period, and as a result, a later start of ice formation and massive ice up to the start of melting. If a frequent change of wind velocity and direction takes place in the melting period, we may expect a comparatively early and complete removal of ice from the given sea area. In other words, for navigation in the arctic, most advantageous are: least possible turbulence of atmosphere in pre-winter and winter periods and most possible turbulence in pre-navigational period. From this arises the possibility, in my opinion, of using the theory of atmospheric turbulence for long-term ice forecasts.

The above-described method of computation is extremely cumbersome and can be adopted only in special cases and for special observations. For the answer to practical questions we may assume that the atmospheric turbulence is characterized by the average daily variation in atmospheric pressure for the 10-day period, month, season, or year. Since synoptic maps are most completed compiled in the weather bureau for 7 o'clock in the morning, it is therefore most convenient in practice to consider as the pressure change for the day, the pressure change from 7 o'clock of the preceding day to 7 o'clock of the given day.*

As an example, table 113 shows the barometric observations of certain polar stations for 1934 to 1935 (compiled by the author).

Examining table 113, we see that the minimum monthly turbulence was observed on Chetyryokhstolboboï Island in June 1936 and was equal to 2.9 mb/day, while the maximum was observed in Yogorski Shar Straits in December 1934, and was equal to 2.9 mb/day, while the maximum was observed in Yogorski Shar Straits in December 1934, and was equal to 9.2 mb/day. It is obvious that the turbulence may be greater in certain few 10 day periods. Thus, in the third 10 day period of December 1934, the turbulence in Tikhaya Bay was up to 12 mb/day, while from 25 to 26 October 1934 the pressure at the same station changed quickly by 30.6 mb which was accompanied by a southwest wind of 16 m/second.

*Obviously, to obtain such a conventional index of atmospheric turbulence for a longer period (10 days, month, season, year, etc.), we must add the absolute daily pressure changes and then divide the sum obtained by the number of days.

TABLE 113. CONVENTIONAL INDEX OF ATMOSPHERIC TURBULENCE (MB/DAY)

Month and Year	Name of Station						
	Tikhaya Bay	Yugorski Shar	Maresale	Dickson Island	Cape Chelyuskin	Tiksi Bay	Chetyryokhstolbovoi Is.
Sept. 1934	5.3	5.5	5.6	4.7	4.9	3.7	4.4
Oct. 1934	7.0	6.6	6.3	7.2	6.5	6.1	5.1
Nov. 1934	6.3	7.1	5.6	6.7	4.7	4.3	4.2
Dec. 1934	8.5	9.2	7.6	7.7	5.9	3.5	5.2
Jan. 1935	7.7	7.7	8.2	6.5	5.9	5.9	7.6
Feb. 1935	5.1	5.7	5.3	7.3	6.0	8.2	6.2
Mar. 1935	6.4	7.4	6.8	5.6	4.9	4.1	4.8
Apr. 1935	3.3	6.0	5.8	4.8	4.0	4.0	3.2
May 1935	4.7	6.9	8.0	7.4	4.5	4.6	4.0
June 1935	3.6	4.8	5.0	4.8	3.8	4.7	2.9
July 1935	3.8	3.7	3.3	5.5	4.3	3.8	4.0
Aug. 1935	4.7	3.9	3.9	4.7	4.0	4.9	4.0
Year	5.6	6.2	6.0	6.1	5.0	4.8	4.6

The average yearly computation of atmospheric turbulence varies still less from point to point: from 4.6 mb/day on Chetyryokhstolbovoi Island to 6.2 mb/day in Yugorski Shar Straits.

The data of the above table pertains to only one year. We may nevertheless observe that the atmospheric turbulence is greater at stations west of Cape Chelyuskin than at stations east of it, which fits perfectly into our conception of the agitating effect of Atlantic water. Further indication is the fact that at all the stations shown, the minimum atmospheric turbulence was observed in the summer (June to September); the maximum in the winter (December to February).

Figure 167 shows the curve of the seasonal pattern of monthly many-year indices of atmospheric turbulence on Dickson Island which I have computed for the time interval from 1916 through 1938. It is clear from the figure that the curve has two minimums. The first, or smallest, occurs in January. In the Dickson region at this period, due to the homogeneity of the underlying surface (ice) and the absence of daily temperature change (polar night), more or less calm atmospheric conditions are created. The second and considerably deeper minimum comes in July, which is likewise explained by homogeneity of conditions--water surface free of ice and polar day.

In comparing data from individual years with the many year seasonal pattern of turbulence, it appears that the general pattern of variability is basically preserved, but phase displacements are observed in individual years, and this is reflected to a certain degree in ice conditions.

As has already been noted, after the indices of atmospheric turbulence for the 1 day period, month, season, or year have been computed and plotted on the geographical map, we may draw the isolines of turbulence according to the data obtained. I have done this for the seas of the Soviet Arctic for June and July of 1939 (figures 168 and 169).

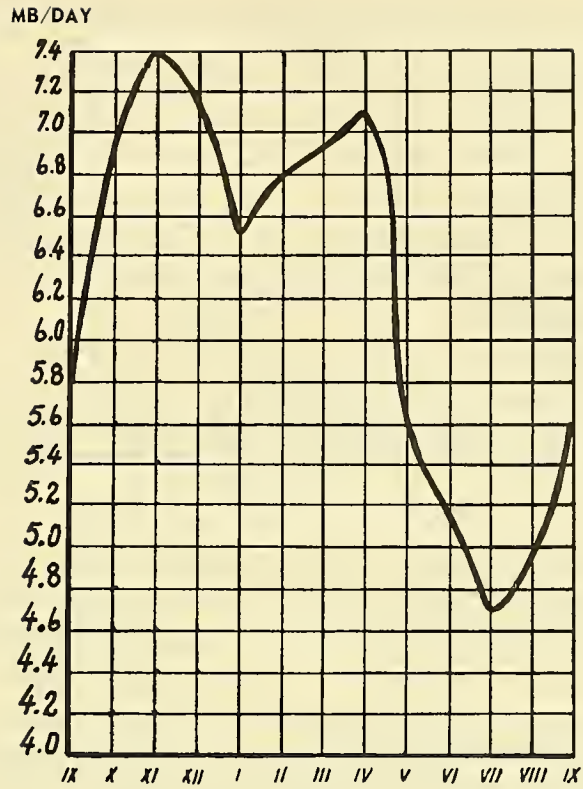

Figure 167. Atmospheric turbulence for Dickson Island from 1916 to 1938.

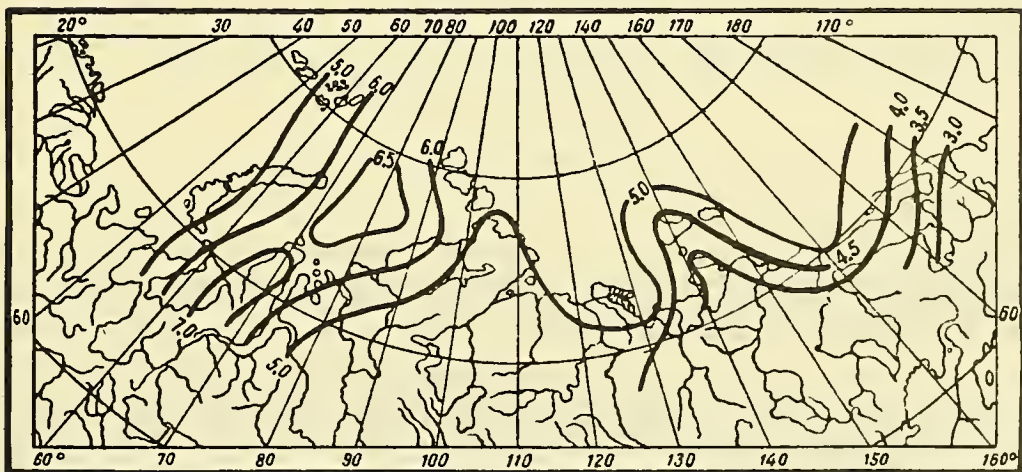

Figure 168. Isolines of atmospheric turbulence in June 1939.

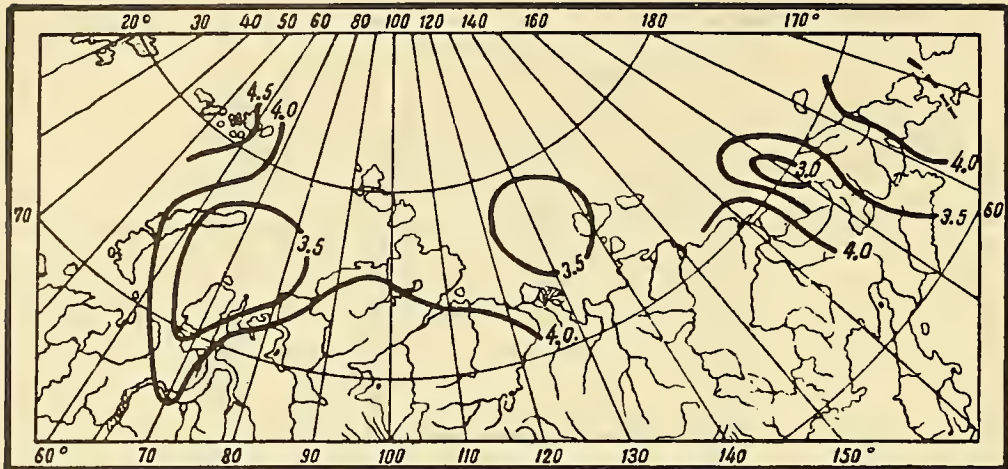

Figure 169. Isolines of atmospheric turbulence in July 1939.

In June the greatest atmospheric turbulence was observed in the Kara Sea. Consequently, in this month the paths of pressure system centers in the main, intersected here. In July the atmospheric condition was considerably quieter; the maximum turbulence was observed at Franz Joseph Land, the minimum by Chaunskaya Guba.

Obviously, the more fully developed the net of meteorological stations in the given region and the less the time intervals between pressure measurements which are used for computing atmospheric turbulence, the more accurate will be the results obtained. Thus, if we compute atmospheric turbulence according to pressure observations for four fixed times, we observe the effect of fast moving pressure systems which might be missed in computing turbulence by daily pressure changes.

It must be noted that the theory of atmospheric turbulence, particularly in its application to calculating changes in ice conditions and for ice forecasts, is a new undertaking and we have therefore not yet obtained all the results which it may provide.*

LITERATURE: 69, 77, 151a.

*During proofreading of this book, at the instance of Dzerdzeyevski, I became acquainted with the interesting article of Sigurd Evjen, "Barometric Fluctuations and Long-term Forecasts", which I had unfortunately not seen until then.

The propositions which I have set forth here coincide fully with those of Evjen with only this difference, that Evjen operates with totals of turbulence, while I divide these totals by the number of items and thus obtain an index of turbulence. Further, Evjen considers it possible to use the observed atmospheric turbulence for forecasts of 6 to 7 and more days ahead. I consider it possible from the atmospheric turbulence over the preceding period to judge the ice condition at the present moment.

Section 152. Variation in Ice Circulation From Year to Year

The distribution of atmospheric pressure over the earth and in particular over the Arctic Basin varies not only from season to season, but also from year to year. In connection with this, the ice circulation, which is determined by the pressure pattern likewise varies from year to year, and within fairly large limits.

At my request, Somov traced the drift of arctic ice for 1937 and 1938, basing his work on the rules which I have derived, that is, that ice moves along the isobars and with a speed inversely proportional to the distance between isobars. The results of these calculations are shown in figures 170 and 171.

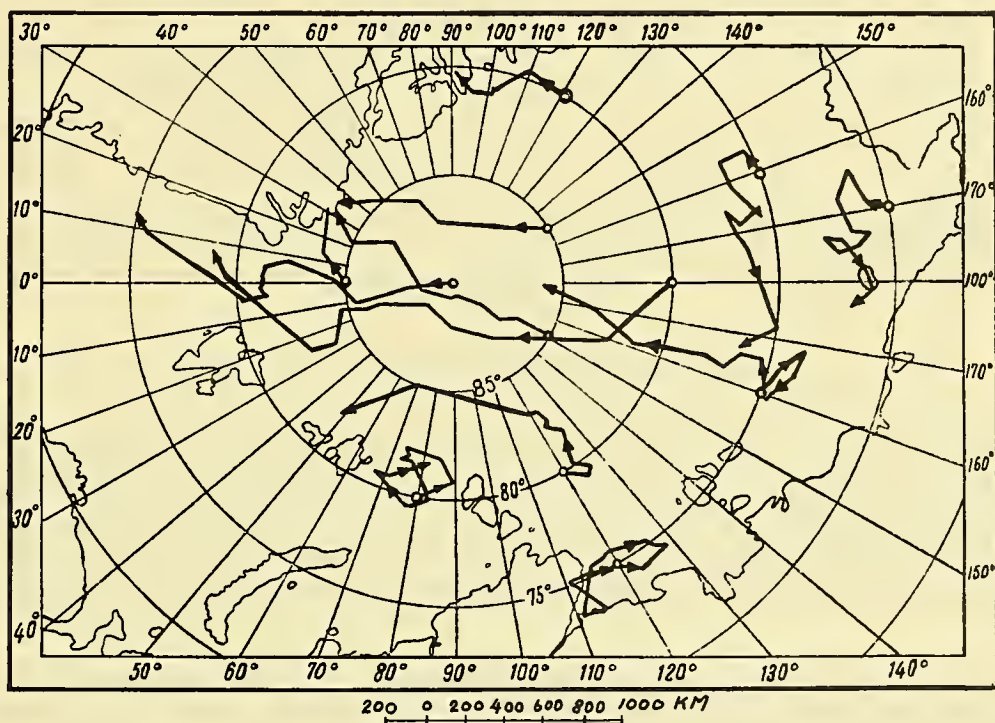

Figure 170. Computed drift of arctic ice in 1937.

The small circles on these charts show the positions (for both years) on 1 January of individual floes whose movements were subsequently traced. Their drifts were then computed from the monthly pressure maps by consecutive vectors.

It goes without saying that the maps which are shown must be considered as extremely rough approximations. In compiling them no account was taken of permanent currents nor of the effect of land and islands on the wind-caused drift of ice. Nevertheless these maps at least give some idea of the fact that the transfer of ice into Greenland Sea was greater in 1937 than in 1938.

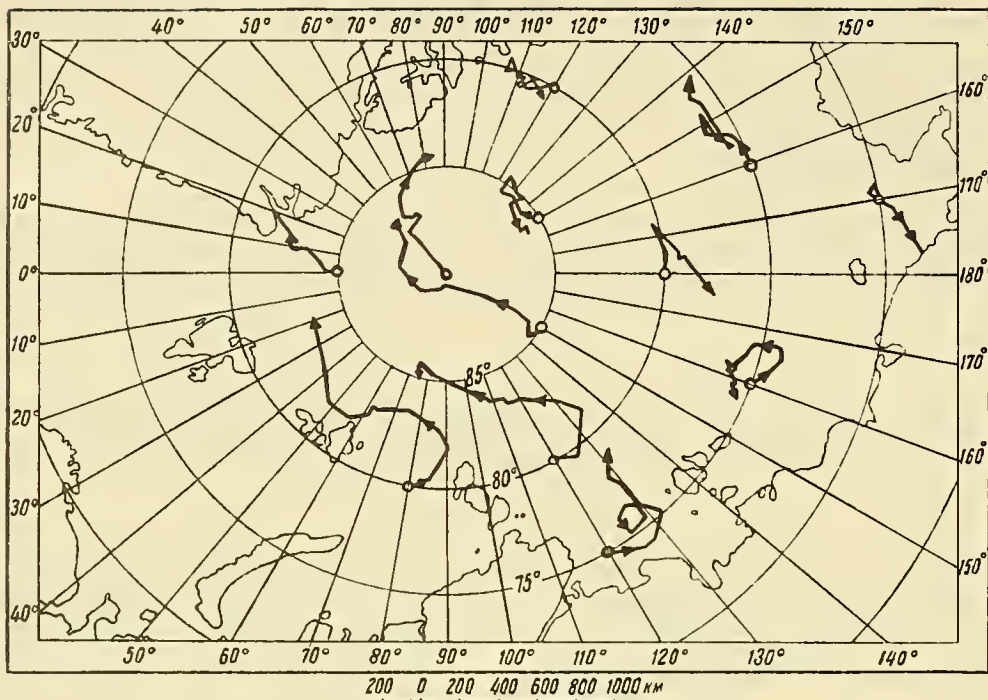

Figure 171. Computed drift of arctic ice in 1938.

But the main thing which these maps show is that there can be no question of any simplified diagram of ice movement according to the principle of shortest distances. On the contrary, it must be assumed that in the Central Arctic Basin there is a complex system of circular movement, subject to considerable variations both in time and in the area over which movement occurs. This very complexity of the drift diagram (especially its variability in time) is responsible for the appearance of areas of hummocking and thinning, areas of stagnation and areas of increased drift speed.

The observed dependence of ice drift in the Arctic Basin on distribution of atmospheric pressure permits us to elaborate our conceptions of the nature of currents in this basin. The general scheme of atmospheric circulation over the Arctic Basin is such that it guarantees an ice movement (in the greater part of the basin) in the direction of the Greenland Sea. The ice circulation sets in movement the surface layers of water which lie under the ice. The effect of the wind over the whole area of the Arctic Basin is responsible for a surface current which is strengthened in the Greenland Sea by the prevailing north winds.

The water deficit in the Arctic Basin (which arises in connection with the northerly winds) intensifies the deep Atlantic current, which is formed as a convection current and a drift current, and apparently transforms it to a considerable degree into a compensation current.

As may be seen from figures 162 to 166, the nature of the atmospheric circulation may vary from season to season in such a way that intensification of drift may involve only separate scattered area. For example, the increased transfer of ice out of the region adjacent to the Bering Strait may correspondingly increase the amount of water entering the Bering Sea, but may not be reflected on an increased transfer of ice into Greenland Sea and increased entry of Atlantic water.

It has already been shown that the water exchange of the Arctic Basin and the Greenland Sea is determined by many factors: positive fresh water balance, difference of densities, etc. But the determining factor is undoubtedly the transfer of ice from the Arctic Basin into the Greenland Sea and the water deficit in the Arctic Basin which is due to this ice transfer.

In other words, the basic factor responsible for the general circulation of arctic ice is the nature and intensity of atmospheric circulation over the Arctic Basin and over the basins of the World Ocean adjacent to it.

LITERATURE: 67, 70, 72, 77, 122.

Section 153. Ice Circulation in the White Sea*

In respect to its geographic position, shape, bottom topography and other features, the White Sea occupies quite a peculiar place among the northern seas of the Soviet Union.

The distinguishing feature of the White Sea is the separation of its deep part (basin), with depths up to 340 m, from the Barents Sea by a long, narrow and shallow strait (neck). This fact makes the White Sea a sea, in the full sense of the word, in contrast to the other seas of the Soviet Arctic.

In the neck of the White Sea, in the region of Three Islands a very narrow (about 1 to 2 miles) trough over 40 m deep connects the deeper parts of the White and Barents Seas. The distance between 20 m isobaths here is also extremely small (about 8 miles). In addition, in the same region, approximately to the east of the 42nd meridian, there are a number of low, rocky islands. Ice accumulations form on these islands in the winter, and floating, detached hummocks (nesiak) adhere to them. In this manner, to the east of Terski-Orlovski Cape an obstacle is created to ice movement, both wind-caused movement and movement resulting from currents. This is particularly noticeable in the spring. Here the ice remains longest and hinders navigation at a time when ice has already disappeared in the basin and neck of the White Sea.

Figure 172 shows the condition of ice in the neck of the White Sea, illustrating the above (data from air reconnaissance made on 14 April 1943). All the remainder of the White Sea was practically free of ice.

The next distinguishing feature of the White Sea is the strong tides, thanks to which even Onega Bay, which is separated from the basin by the ridge of the Solovetsky Ostrova, and which is shallow and has a great number of coastal islands, does not freeze up completely even in severe winters.

*The White Sea, small in size and capable of being covered by air reconnaissance in several hours, is an amazingly convenient field for all sorts of observations of the dynamics and heat budget of the ice cover. Systematic observations of this sort were begun in 1941 and 1942, and there is no doubt that the results of these observations may be applied to the ice of the arctic seas. This fact is partly responsible for the insertion of a special paragraph into the present book.

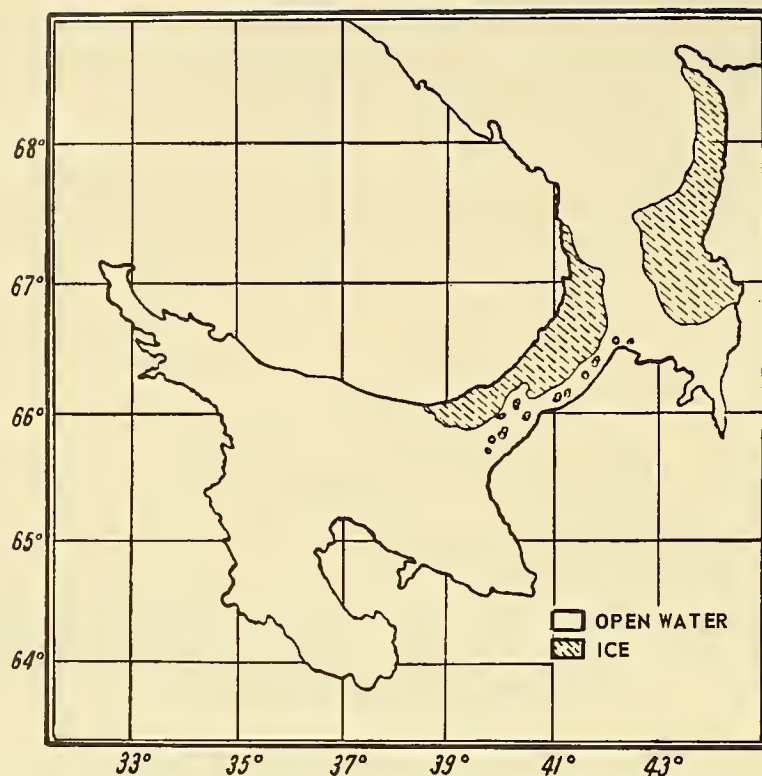

Figure 172. Ice distribution in the White Sea, 14 April 1943.

In figure 104 we showed the ice conditions in the White Sea on 17 to 18 April, 1942. Comparing figures 104 and 172, which show approximately identical dates of the year, we see a striking difference in the ice conditions. In the first case almost the entire sea was filled with ice, in the second there is hardly any ice. I will subsequently return to the question of variability of ice behavior.

The winter of 1941-42 was in general unusually severe in the White Sea, and the possibility of navigation, even for powerful icebreakers, was determined for the most part by synoptic conditions. The following example is descriptive.

By 13 January the Finno-Scandinavian high pressure cell developed in the north of the European part of the USSR, and the Ob low over the basins of the Ob and Yenisei Rivers. As a result of such a distribution of pressure centers, strong northerly winds prevailed over the basin of the White Sea, attaining a force of 6 to 7 (0700, 18 January). As a result, an edge of heavy ice descended in the neck of the White Sea almost to the parallel of the Ponoï, proceeded approximately along the middle of the neck and thence into the basin itself, descending almost to the Solovetsky Ostrova.

The whole of the Dvina Bay was stopped up with such hummocked and compressed ice that even such a powerful icebreaker as the *Lenin* was practically unable to move in the southern part of Dvina Bay.

Reports of about the same nature were received from the icebreakers *Sibiryakov* and *Litke* which were at that time in the White Sea near the Letni shore.

Figure 173 shows the distribution of ice in the White Sea from air reconnaissance made on 17 February 1942. These ice conditions were created as a result of south and southeast winds which prevailed over the White Sea from about 25 January, when a strong anticyclone prevailed with its center over the Ural region and affecting a great part of European USSR.

Starting 27 January, the icebreaker *Lenin* had the same task as for the period from 12 through 18 January--to bring out vessels stuck in the ice of Dvina Bay. What had been very difficult for the *Lenin* from 12 through 18 January was easily accomplished over the period 29 January to 4 February. During this period the icebreaker reached 65° 36' north, 39° 05' east.

From these examples we may see what an effect the wind has on the distribution of ice in the basin of the White Sea and its bays, and to what extent navigation of even powerful icebreakers in this sea is affect by the winds.

Figure 174 shows the drift of the steamship *Soroka* (solid line), from 16 December 1941 from the fast ice at Molotovsk to 8 January 1942 at 66° 09' north, 41° 00' east. Also the drift of the trawler *T-60* (dotted line) from 1 through 5 January 1942, going from 65° 52' north, 38° 45' east to 67° 06' north, 41° 30' east. Both of these drifts, one along the Zimni shore and the other along the Terski shore, occurred with south winds.

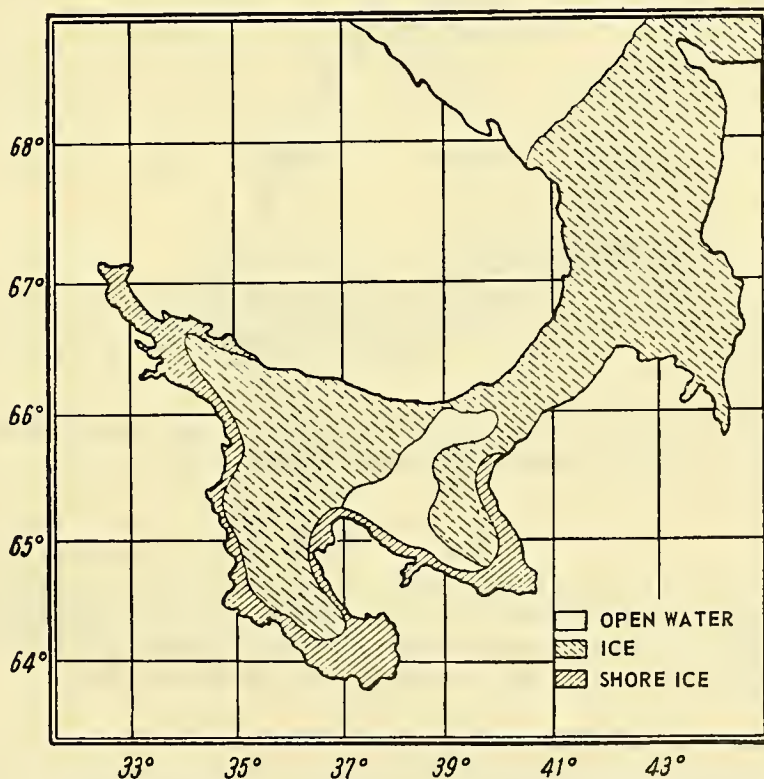

Figure 173. Ice distribution in the White Sea, 17 February 1942.

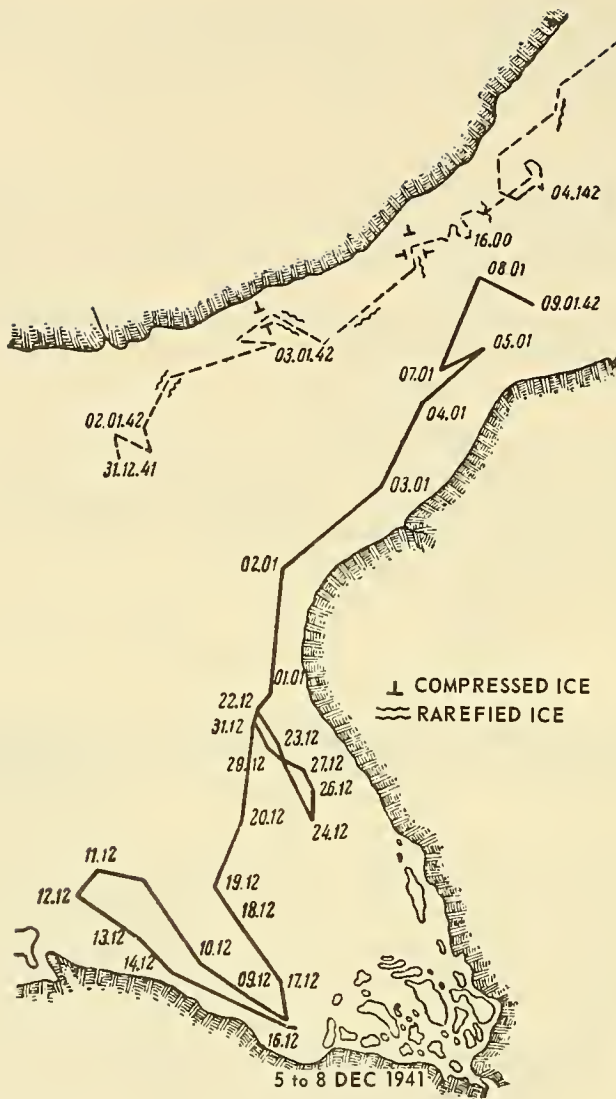

Figure 174. Drift p/x *Soroka* from 16 December 1941 to 8 January 1942 and the trawler *T-60* from 1 to 5 January 1942.

Figure 175 shows the averaged isobars from 1 through 5 January 1942. We find a very good coincidence of isobar directions and drift directions. It must only be emphasized that such a concurrence of directions of drifts and isobars results from the fact that the ice, in the course of its drift along the isobars, did not encounter obstacles (shores, islands and fast ice).

If we examine carefully the drift of the trawler *T-60*, we see that the ice moved not only under wind influence, but also under influence of the tidal currents, describing closed curves for the most part clockwise. In order to exclude the effect of tidal phenomena, let us take a portion of the drift from 00 hours on 2 January to 0230 on 4 January, comprising 50 hours, or in other words,

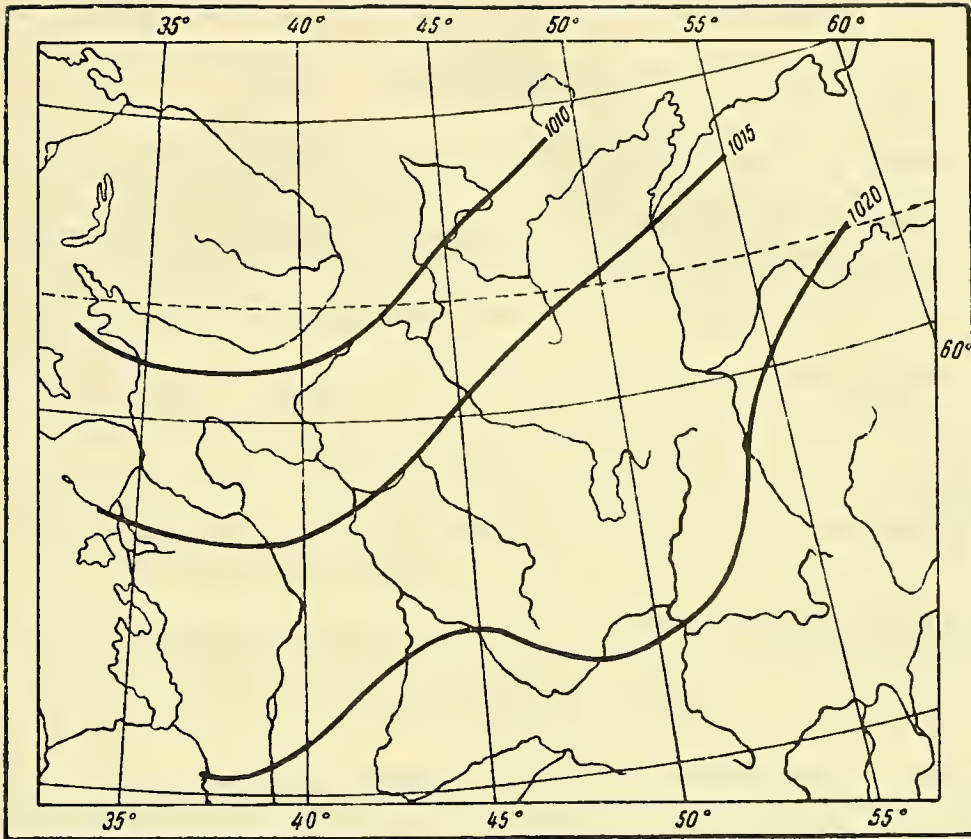

Figure 175. Averaged isobars over the White Sea from 1 through 5 January 1942.

two lunar days.* During this time the trawler drifted parallel to the axis of the neck of the White Sea, approximately northeast for a distance of about 40 miles, i. e., with a speed of about 0.8 knots or about 15 km per hour.

As has already been noted, at this period the isobars were extended along the axis of the neck, and the distance between isobars, drawn at intervals of 1 mb, was on the average about 15 km.

Considering that the drift is directly proportional to wind velocity which itself is inversely proportional to the distance between isobars.

we obtain

$$c = \frac{A}{x} \quad (1)$$

*The author evidently ignores the additional 30 minutes - Translator.

where c = speed of drift in km/hr

x = distance in kilometers between isobars drawn at intervals of 1 mb

A = coefficient of proportionality.

Substituting in equation (1) the values: $c = 1.5$ km/hr = 36 km/day = 1,080 km/month, and $x = 15$ km, we obtain the following value for the coefficient A :

$$c \text{ (km/month)} = 16,200 \frac{\Delta P}{\Delta x} \text{ (mb/km)} \quad (2)$$

We recall that from analysis of the drift of the icebreaker *Sedov*, I obtained the following equation:

$$c \text{ (km/month)} = 13,000 \frac{\Delta P}{\Delta x} \text{ (mb/km)} \quad (3)$$

Comparing equations (2) and (3) we see that their numerical coefficients are extremely close and differ only within the limits of accuracy of the corresponding measurements.

For a sea such as the White Sea, it is more convenient to use not equation (2) but the following:

$$c \text{ (km/day)} = 540 \frac{\Delta P}{\Delta x} \text{ (mb/km)} \quad (4)$$

If we assume that the speed of ice drift is the same along the whole width of the neck (approximately 46 km), we then find that the size of the ice area carried out of the neck of the White Sea per day for the period under consideration is as follows:

$$q \text{ (km}^2\text{/day)} = 46 \text{ km}^2 \quad (5)$$

$$c \text{ (km/day)} = 25,000 \frac{\Delta P}{\Delta x} \text{ (mb/km)}^* \quad (6)$$

Equation (3), (4), and (5) refer to a case when the isobars run parallel to the axis of the neck of the White Sea. But the isobars may run in various directions and may intersect the neck at various angles. For the general case we may write as an approximation

$$c \text{ (km/day)} = 540 \cos \beta \frac{\Delta P}{\Delta x} \text{ (mb/km)} \quad (7)$$

$$q \text{ (km}^2\text{/day)} = 25,000 \cos \beta \frac{\Delta P}{\Delta x} \text{ (mb/km)} \quad (8)$$

where β = angle between direction of isobar and axis of the White Sea. If the area of increased atmospheric pressure is east of the neck of the white Sea, then angle β is considered positive, if it is west of the neck, negative.

*Editor's Note: Undoubtedly equations (5) and (6) should be

$$q \text{ (Rm}^2\text{/day)} = 460 \quad (5)$$

$$c \text{ (Rm/day)} = 25,000 / x \text{ (mb/Rm)} \quad (6)$$

It is clear that if we employ a certain average thickness for the ice carried out, we will then obtain its volume by the equation:

$$V (\text{km}^3/\text{day}) = h (\text{km}) \times q (\text{km}^2/\text{day}) \quad (9)$$

From the example chosen we see how great is the importance of the neck in the ice behavior of the White Sea. In the winter season, and especially in the second half of winter, southerly winds prevail here, in particular as follows: In Dvina Bay from December through April, southeasterly; in Mezen Bay, southerly with slight deviation to the east; in Onega Bay, southeasterly; in the basin and neck, southwesterly. Such a wind regime results from the synoptic situation which prevails during the winter in the regions adjacent to the White Sea, namely, an area of increased pressure located in the region to the north of the Caspian Sea, and Icelandic lows passing along the southern part of the Barents Sea.

As we see, the normal winter wind regime favors the transfer of ice out of the White Sea through the neck and out of Mezen Bay into the Barents Sea where the ice melts away. At the same time the north winds do not carry new ice into the White Sea, because before the month of April (when melting has already begun in the White Sea proper) there is not yet any ice in the regions of Barents Sea adjacent to the neck. The role of these winds is therefore confined to redistribution of the ice, its thickening and hummocking.

Returning to equations (6) and (7), we see that when the isobars are not parallel to the axis of the neck, the ice in its movement should drift into the shore or the fast ice and should form hummocks. Obviously, if we have a stationary isobars for a certain interval of time, there should result a more or less steady movement and distribution of ice.

Let us suppose, for example, that over the entire White Sea the isobars run from southwest to northeast, that is, parallel to the axis of the neck, which as we have seen, is the most natural condition for the winter months. With isobars in such a position, the ice should drift from Onega Bay into the basin and from the south shores of Kandalaksha Bay and Dvina Bay towards the northern shore. Only the ice which is carried out of Onega Bay between Zhizhghih Island and Solovetskya Ostrova moves directly into the neck of the White Sea. The ice located east of Zhizhghih Island, approaching Zimnegorski Cape, divides into two parts; one goes into the neck, the other partially hummocks, partially drifts south along the Zimni shore. On the other side the ice which is carried out of Onega Bay between Solovetskya Ostrova and the Karelian shore (an extremely small drift, incidentally) and the ice which drifts from the Karelian shore along the isobars, both run into the Murmansk shore and create here massive hummocks. Thus, with the isobar position as mentioned, along the whole Letni shore, along the north shore of Solovetskya Ostrova, along the Karelian shore, along the south shore of Kandalaksha Bay, and along the Murmansk shore a thinning of ice results and in winter a substitution of new ice for the old. On the other hand, along the Kandalaksha and Zimni shores the ice becomes more concentrated and its movement is conditioned by wind-driving.

Actually, the ice, in its movement from the south shores of the White Sea, carries with it the surface layer of water. As a result, offshore driving sets in at these shores, which in turn causes compensational currents, forming, together with the offshore currents, whirlpools with horizontal and vertical axes. While the first are not accompanied by horizontal ice movements but only by hummocking, the second, on the other hand, cause a drift of ice sometimes even against the wind.

Thus, the general circulation of ice in the White Sea is determined by synoptic conditions and is altered by the configuration of shores and by compensational currents.

Basically the ice of the White Sea is constantly being pushed out through the neck of the White Sea into the Barents Sea. This removal of ice sometimes increases, sometimes decreases, and only in rare instances ceases altogether. In connection with the constant removal of older ice, along the shores of the White Sea polynyas are constantly being formed and these are covered over with young ice in the winter season. Thus, in the spring the old ice (November and December origin) may be found only in the most stagnant zones of this sea, namely, along the Zimni shore and near Morzhovets Island.

LITERATURE: 77.

CHAPTER XIII

SEASONAL AND LONG-TERM FLUCTUATIONS OF ICE ABUNDANCE

Section 154. Ice Abundance

The quantity of ice cover in the sea is a function of the area occupied by ice, ice thickness and solidity. Most indicative and easiest to observe is the area occupied by the ice. It is determined either in percentages with respect to the sea area, or in tenths.

Seas may be classified, firstly, by the origin of the ice encountered in them, and secondly, by the length of time in which ice is found in the given region.

In respect to origin of ice, I divide the individual ice regions of the World Ocean into the following basic groups:

1. Regions where the ice is entirely or predominantly of local origin. Such, for example, are the Barents, Kara and White Seas.
2. Regions where the ice is entirely or predominantly not of local origin, but is carried in by winds and currents from other regions. Thus, for example, is the region south of Newfoundland where icebergs are constantly being carried which originated along the shores of Baffin Bay and which have consequently completed a journey of 2000 to 3000 km.

In respect to time during which ice is found, I divide the ocean ice regions into "ice regions," "freezing regions," and "ice-free regions." Ice regions are in turn subdivided into polar and sub-polar regions. In both of these the ice usually remains throughout the entire year, representing an essential feature of the sea picture. In the polar regions, open water never exceeds in area the sea area covered by ice. In other words, the ice abundance of these regions is never less than one-half. In the subpolar regions the quantity of ice decreases considerably in the summer season and in the most favorable years it disappears completely.

Freezing regions are completely cleared of ice in the summer season. In respect to the extent of time in which they are covered with ice they are subdivided into freezing seas of greater and lesser ice abundance. To the first group belongs, for example, the White Sea, where ice is found during more than half the year. To the second group belongs, for example, the Gulf of Finland, Sea of Azov, and the northern part of the Caspian Sea.

In ice-free regions ice is found only under exceptional conditions.

The greatest anomalies in ice distribution are caused by ocean currents. Figure 176 shows the average monthly positions of the ice edge in the summer in the Greenland and Barents Seas. From the chart we can see how far north the influence of the Spitzbergen and Norwegian currents extend.

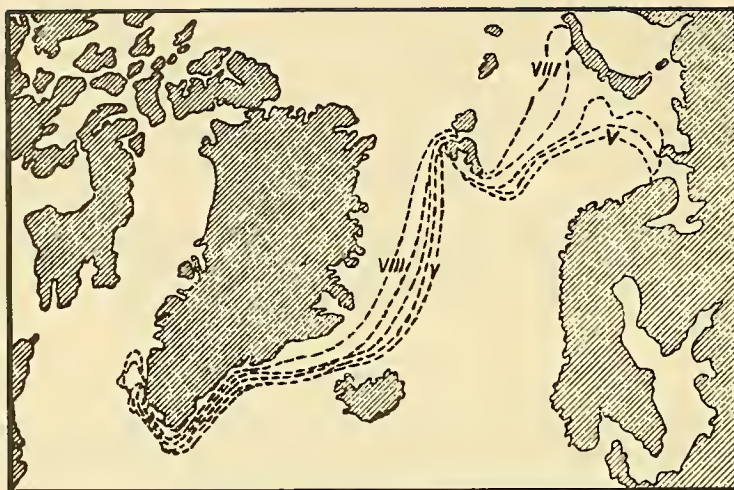

Figure 176. Average monthly positions of ice edge for five summer months (April to August) in the Greenland and Barents Seas.

The relatively great ice accumulations (ice massifs) in the northwestern parts of the Greenland and Barents Seas and the more or less broad expanses of clear water in the southeastern parts are characteristic of the adjacent seas of the northern hemisphere caused by the cyclonic movement of surface water which is usual in the northern hemisphere. This is due not only to the warm Atlantic water pouring into these basins from the south, as occurs in the Greenland and Barents Seas, but also to the fact that in the southern parts of the adjacent seas the melting of ice and heating of water is more intensive.

The cyclonic movement of surface water and the effect of the Coriolis force is seen also in the fact that along the southern and eastern shores of straits there is usually found an absence of ice or a considerably lesser amount than along the western and northern shores.

Sometimes the effect of sea currents is felt in a different manner. Most typical in this respect is the so-called "northern water" of Baffin Bay. Sailing into the northern part of this bay in the summer, very often after several days or even weeks of struggling with the ice, a large expanse of clear water opens up, extending almost to Smith Sound. Smith gave the correct explanation of this phenomenon: A rather swift current runs south from the straits, but this cannot break up the massive fast ice which forms in the sound proper. However, all the ice which forms south of the sound during the winter is carried south by this current until it runs into the ice in the central part of the bay.

Thus, due to the effect of sea currents, ice-free regions may sometimes be located at higher latitudes than ice regions. Thus, for example, the ocean area along the coast of Newfoundland (46° north), where icebergs are usually found throughout the entire year, must be considered a region of sub-polar ice abundance. On the other hand, the eastern part of the Greenland Sea, where due to the effect of the warm Spitzbergen current ice is only occasionally found at any time of the year right up to 80° north, must be considered an ice free region.

The example cited is not unique. Even in various regions of the same sea we sometimes find different types of ice abundance. Barents Sea is a typical example in this respect: The region of the sea south of 75° north and west of 40° east approximately, is an ice-free region; the region

south of 75° north and east of 40° east is a region of sub-polar ice abundance, while north of 75° but east of 40° is a region of polar ice abundance.

Figure 177 shows the position of the ice edge in the Greenland and Barents Seas in May 1936, according to observations of Soviet vessels, while figure 178 shows the position in October to December of the same year.

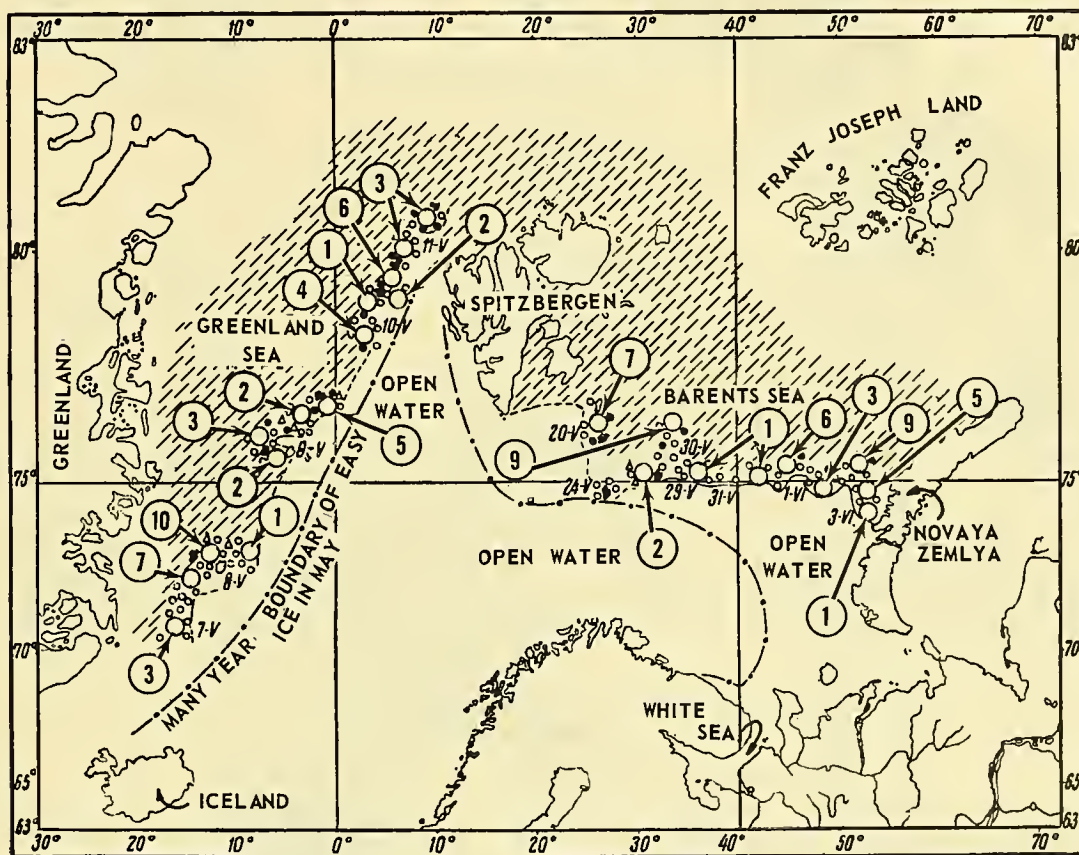

Figure 177. Ice conditions in the Greenland and Barents Seas, May 1936.

The ice conditions on the course of the Northern Sea Route in mid-September 1936 are shown in figure 179.

In these figures the numbers in circles indicate the quantity of ice in tenths. The nature of the ice (size of floes) is shown by conventional symbols.

Figure 179 is more or less typical for ice conditions in the seas along the Northern Sea Route in that it clearly shows the two ice regions of this route which determine its passability. The first is the region of Vilkitski Strait. The Norwegian current and the drainage of the Ob and Yenisei rivers have their effect to the west of it, while east of it is a region exposed to the influence of the Lena river. The second ice region is in Long Strait. West of it is the Lena region, comparatively mild in respect to ice, while east of it is the area under the influence of the Pacific Ocean current entering through the Bering Strait.

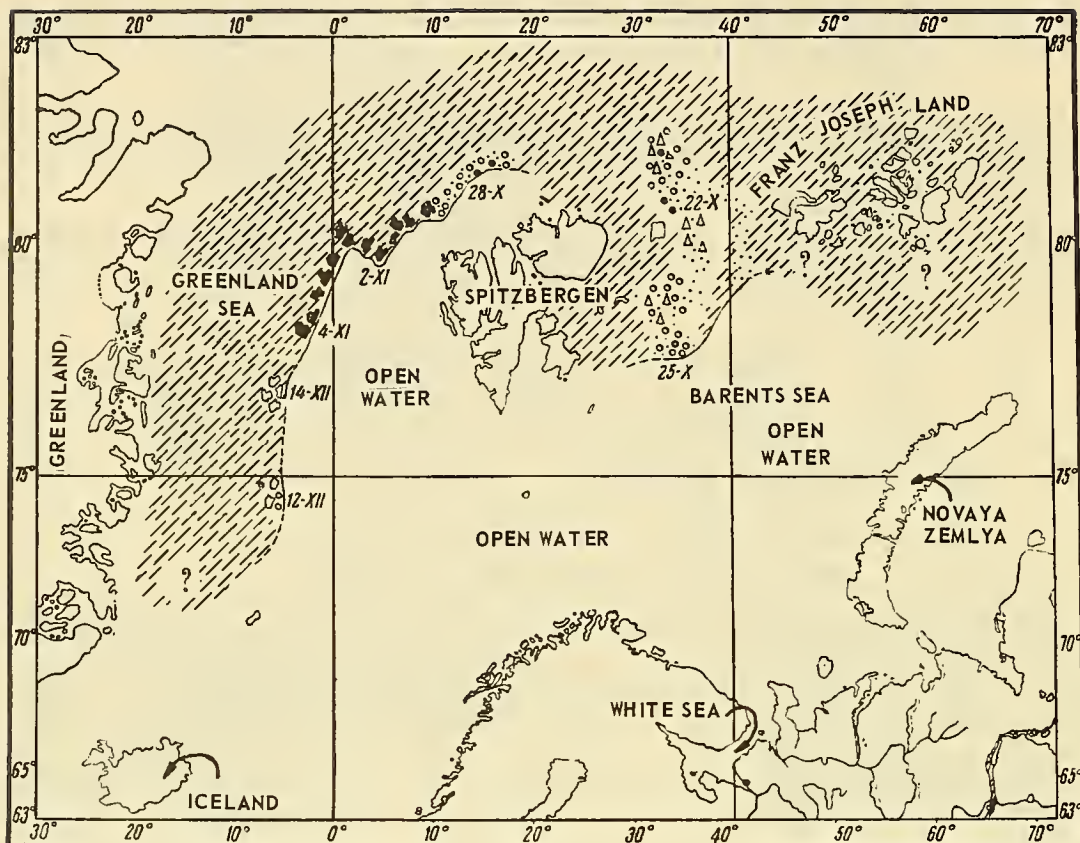

Figure 178. Ice conditions in the Greenland and Barents Seas, October to December 1936.

LITERATURE: 62, 77, 85, 171.

Section 155. Seasonal Fluctuations

Figure 176 showed the average many-year positions of the ice edge in the Greenland and Barents Seas. Worthy of attention in this figure are the very slight shifts of the ice edge in the Greenland Sea (basically from east to west in the summer and in the reverse direction in the winter), and the considerable movements of the ice edge in the summer to the northeast in the Barents Sea.

Common to both seas is the fact that the ice, in the majority of cases, remains in the massifs which at the end of the summer are concentrated in the northwest regions of these seas. The edge is here well-defined, due to the fact that each individual floe which is torn away from the massif by a decompressive wind falls into the warm water of the Spitzbergen or Norwegian current and there melts very quickly. This causes a rapid reduction of the area of ice which is carried out of the Arctic Basin into the Greenland Sea.

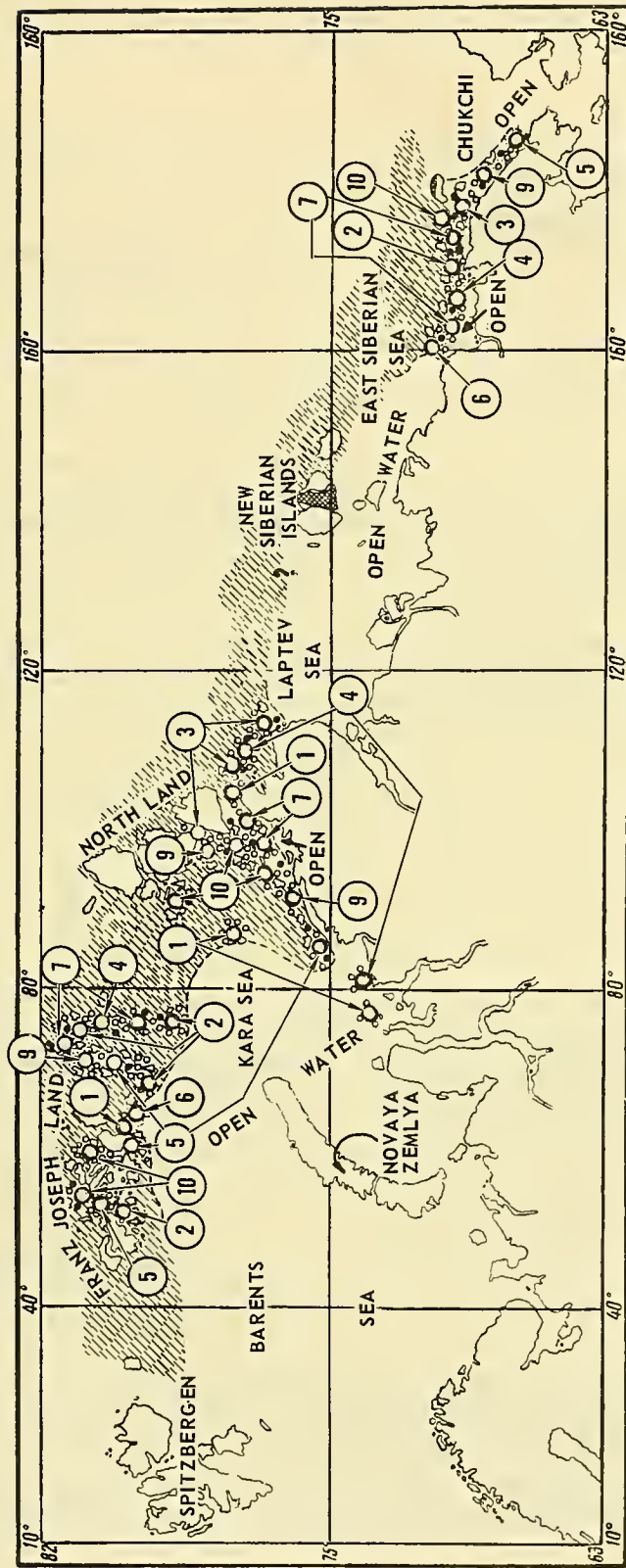

Figure 179. Ice conditions along the Northern Sea Route in mid-September 1936.

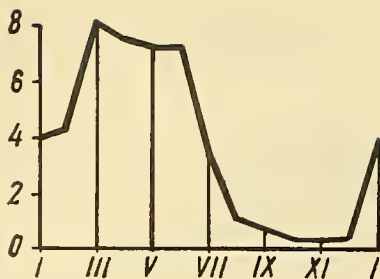

Figure 180. Average quantity of floating ice drifting past Iceland.

Figure 180 shows, according to Brooks and Kennell, the average seasonal variation in ice abundance along the coast of Iceland for the period 1901 to 1924, as indicated by the floating ice drifting south past Iceland along with the East Greenland current.

Figure 181 shows, according to Meeking, the average seasonal variation of floating ice along the coast of Newfoundland. The main February maximum is caused here by the movement of ice from Davis Strait to this region. The lesser May maximum is caused by floating ice likewise carried here from Davis Strait, but retarded in its southward movement by the slower moving icebergs which are imbedded in the floating ice.

Figure 182 shows the average seasonal variation in the quantity of icebergs carried out of Davis Strait into the Newfoundland region as observed by the International Ice Patrol from 1900 to 1928.

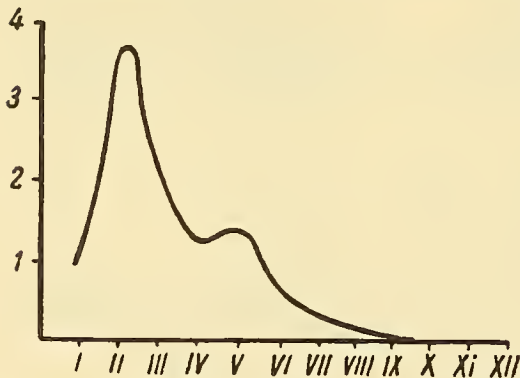

Figure 181. Seasonal variations in the quantity of sea ice descending from the north into the region south of Newfoundland.

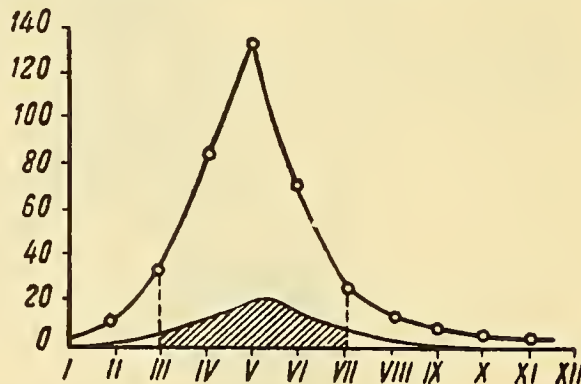

Figure 182. Average number of icebergs south of Newfoundland (upper curve). Icebergs south of Grand Banks, according to Smith (lower curve). Ice season lasts from middle of March to middle of July.

From the figures cited we may clearly see the peculiar seasonal variation of quantity of ice carried by the East Greenland and Labrador currents. On all the curves, the maximum quantity of ice falls in the summer months.

The same sort of picture may be seen along the south coast of Spitzbergen, where the ice which has formed in the northwest part of the Barents Sea drifts around South Cape and then,

carried along by the proper winds and the Spitzbergen current, runs north along the southwest coast of Spitzbergen sometimes to Icefjord, and beyond. Such ice here bears the name of "southern ice."*

Table 114 lists the average long-term (1900 to 1928) areas of clear water in Barents Sea in thousands of square km and in percent of the total sea area (1,360,000 square km).

TABLE 114. AREAS OF CLEAR WATER IN THE SUMMER MONTHS
IN THE BARENTS SEA (1900 TO 1928)

Month	April	May	June	July	August	Average
Thousands of square km	350	460	590	860	1060	670
Per Cent	26	34	43	63	78	49

Examining the average monthly positions of the ice-edge (figure 176) we see that they correspond well with the relief of the bottom shoal areas, which, other conditions being equal, are regions of ice accumulation. Here ice formation begins earliest, while melting caused by the heat of the Atlantic water proceeds most slowly because of its slow drift. With the setting in of cold winter, the ice border gradually moves to the south and west, and this process occurs faster over shoal areas than over the deep regions. By April, when the ice borders on the average have reached their most southern and western positions, only the southwest part of the sea with depths over 200 m remains free of ice. By May the border moves slightly to the north and east but is generally similar to the ice border in April. In June the border runs slightly to the north of Bear Island, passes south of the central shoal area and very typically goes around the shoal area at Gusinaya Zemlya from the west. In July, all of Barents Sea south of 75° and 76° north becomes ice-free. In August, the border moves approximately one degree to the north. On the average, the ice border recedes fastest from June to July and its movement north is considerably slower than its movement east and northeast. In other words, it moves faster along the direction of movement of the Norwegian current than in the regions where the Atlantic water, forming a cyclonic movement, turns to the west.

It must be noted, however, that such conceptions as the area of clear water or of ice, or a more southerly or more northerly position of the ice edge in the Barents Sea, are extremely relative conceptions and may be used only with definite reservations. It is known, for example, that with prolonged north winds (as occur with cyclones which pass to the northeast between Franz Joseph Land and Novaya Zemlya), the edge of Barents Sea ice descends towards the south and in such cases huge expanses of clear water sometimes form between the ice accumulations at the edge and Franz Joseph Land.

Thus, on 13 May 1936, during the flight of Vodopyanov between Franz Joseph Land and Cap Zhelania, clear water was found to extend for 250 km along the flight course. In June 1937, the *Sadko*, going towards Franz Joseph Land from the south, came out of the ice at 77° 30' north, 51° 20' east and found clear water for more than 270 km. Thus, the area of clear water south of the

*Taking into account this southern ice which sometimes flanks Bear Island from the south, I always advise that in sailing from Murmansk to Barentsburg early in the spring, the following should be considered as a guiding rule. Select a course from Murmansk to Bear Island. If ice is met on approaching the island, never enter this ice but skirt it keeping the ice on the right to the latitude of Barentsburg itself (78° north), and only then turn into Barentsburg.

edge often decreases at the expense of an increase of the clear water area in the north and vice versa. From this it likewise follows that it is sometimes considerably easier to get to Franz Joseph Land under conditions of a very southerly position of the Barents Sea ice-edge than when the ice-edge is very far north and when the ice at Franz Joseph Land itself may be extremely compressed.

Nevertheless, most typical of Barents Sea ice conditions is when the easiest route to Franz Joseph Land lies directly from the south along the great deeps (at approximately 40°-50° east). Meanwhile there is still some ice in the west, remaining on the shallower depths of the Persens shoals (Spitzbergen massif). In the east there is ice which has been carried from the northeast out of the northern part of the Kara Sea and which remains in the shallows along the southeast coast of Franz Joseph Land (northeast massif).

We find a different distribution of ice in the Kara Sea. It must be considered that during the winter months practically all of this sea, like the other seas of the Soviet Arctic, is covered with floating ice. This picture remains until about June, after which the ice starts to fall apart into massifs, the main ones being:

1. Southwestern or Novaya Zemlya massif, situated between Novaya Zemlya and the Yamal Peninsula.
2. Northeastern massif, northeast of Dickson Island.
3. Northern massif, in the northern part of the sea, combining with the ice of the central Arctic Basin. The axis of this massif passes along the Sadko shoals, dividing the northern part of Kara Sea into two parts.

The northeastern and northern massifs in some years are not separated from each other.

These main massifs are sometimes divided into smaller ones.

On this account we cannot speak of an ice-edge in the Kara Sea in the same sense as we do, with certain allowances, in relation to Greenland and Barents Sea.

The existence of the Novaya Zemlya massif, which in certain years remains until the following winter, and its movement (due to winds) determines the navigational conditions from Barents Sea into the mouths of the Ob and Yenisei Rivers. Sometimes the southern route through Yugorski Shar is most favorable. In other cases a middle route through Matochkin Shar, and in a few cases, the northern route around the north end of Novaya Zemlya is most advantageous. The Novaya Zemlya massif sometimes breaks up completely by the end of the summer.

Figure 183 is a probability chart of the presence of ice in the southwestern part of the Kara Sea in the first half of September (according to Vize). The map was compiled from observations over 13 years. The existence of the Novaya Zemlya massif may be traced on it.

Figure 184 is a chart of probability of presence of ice in the northeastern part of Kara Sea for the period 1930 to 1936, compiled by Lvov at my request. It must be noted that in the Novaya Zemlya region the map of Lvov does not agree with that of Vize, since these maps were compiled for different periods.

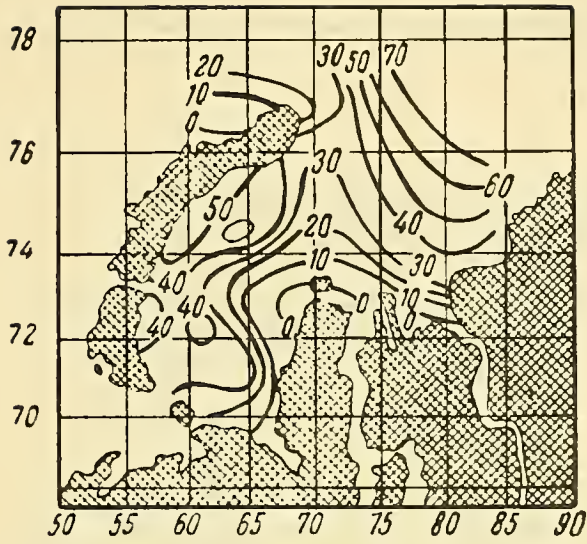

Figure 183. Probability of the presence of ice (in percentages) in the western part of the Kara Sea in the first half of September.

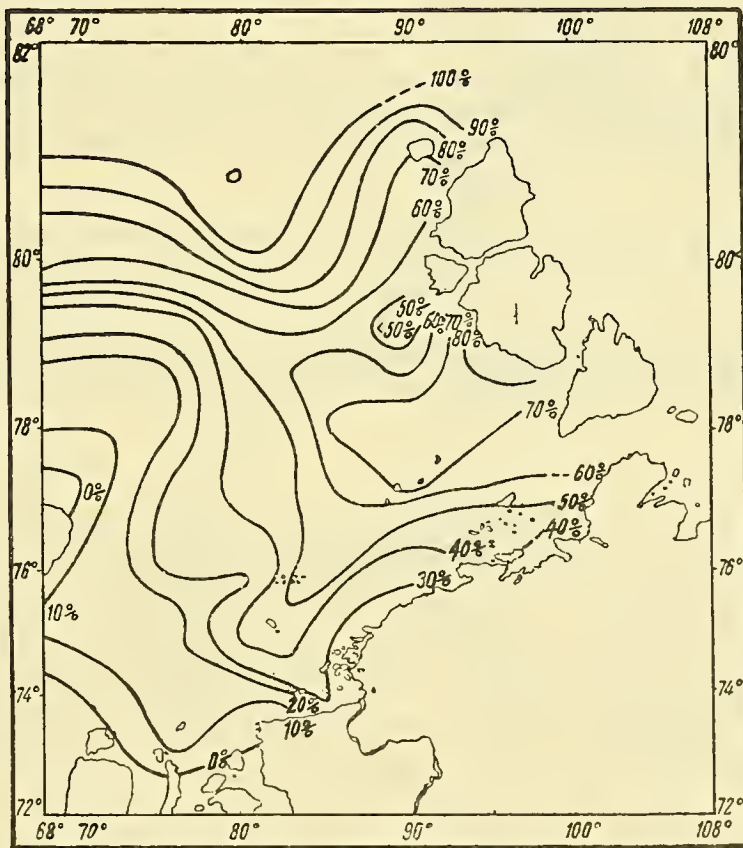

Figure 184. Probability of the presence of ice in the northeastern part of the Kara Sea in the navigational period.

The areas of open water in the Kara Sea for 1930 to 1936, in thousands of square km (according to calculations of Belinski) is shown in Table 115.

TABLE 115. AREAS OF OPEN WATER IN SUMMER MONTHS
IN THE KARA SEA (1930 TO 1936)

Month	July	August		September		Average
	2nd half	1st half	2nd half	1st half	2nd half	
Thousands of square km	270	360	490	620	720	490

In contrast to Barents Sea, where the area of open water observed is never less than 120,000 square km, in the Kara Sea almost the entire sea is completely covered with floating ice by November. Open water remains longest in the straits between Franz Joseph Land and Novaya Zemlya, due to the heat and uniformity of the warm Atlantic water which pours into this region.

Most characteristic of the Laptev Sea in the summer season is the Taimyr ice massif, which descends south along the east shores of Severnaya Zemlya and the Taimyr Peninsula. In some years this massif descends south to the mainland, sometimes recedes to the north leaving a passage for ships along the shore, and sometimes the southern part of it breaks apart into smaller massifs which are separated from each other by expanses of open water.

The average areas of open water in Laptev Sea in thousands of square km (according to calculations of Belinski) is shown in Table 116. These areas are mainly concentrated along the west coasts of the New Siberian Islands and their existence is due primarily to the heat of river waters.

In the East Siberian Sea the ice-edge is sharply defined. It stretches in the summer from the New Siberian Islands to the Bear Islands. Thus the coastal expanse of open water gradually narrows from west to east.

TABLE 116. AREAS OF OPEN WATER DURING THE SUMMER
MONTHS IN LAPTEV SEA (1932 TO 1936)

Month	July	August		September		Average
	2nd half	1st half	2nd half	1st half	2nd half	
Thousands of square km	130	180	310	370	400	280

A typical example of the condition of the ice in the East Siberian Sea at the end of July and beginning of August 1934 is shown in figure 185. The seasonal change in ice abundance is expressed here by the ice-edge moving away to the north during the summer.

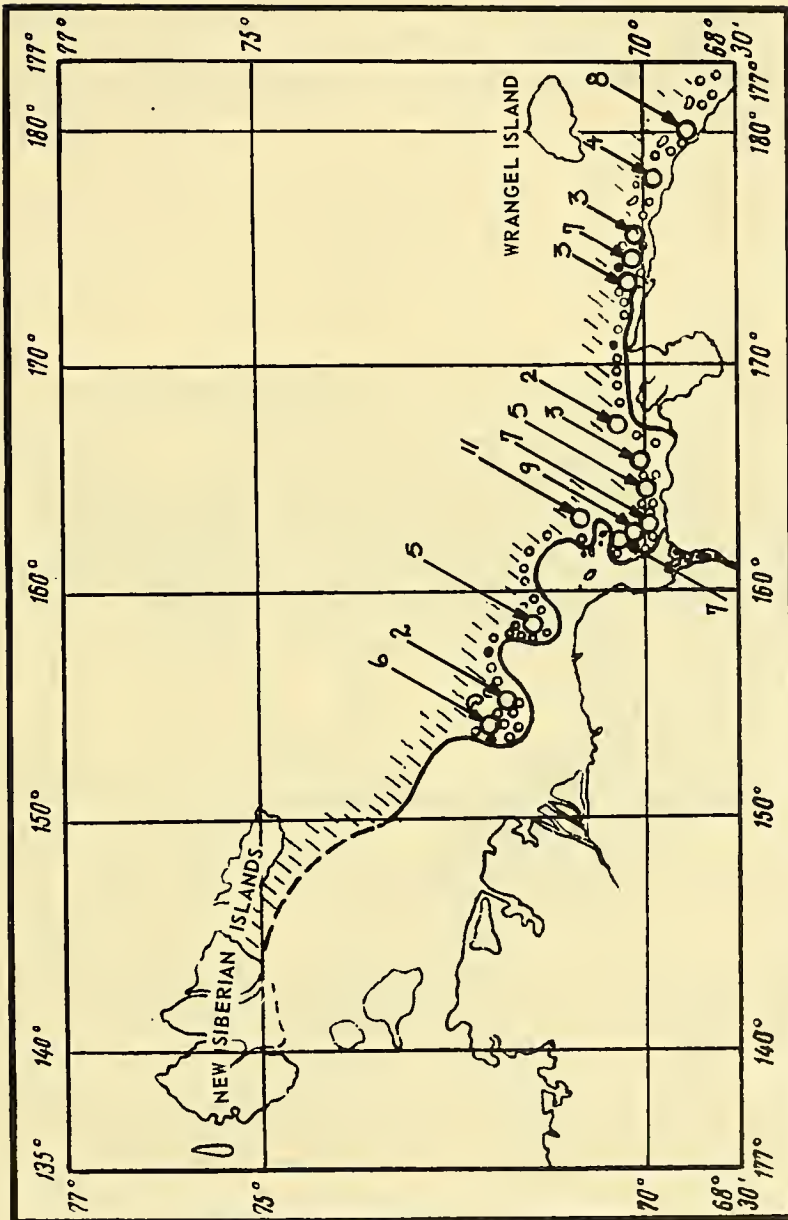

Figure 185. Ice conditions in the East Siberian Sea at the end of July and the beginning of August 1934.

Figure 186 shows a map of the probability of the presence of ice during the navigational period in Chuckchee Sea, compiled from observations from 1930 to 1936, while in table 117 we have the average monthly areas of open water for 1924 to 1938. A comparison of figure 186 and table 117 gives a clear idea of the change in ice abundance and an indication of the influence of Pacific Ocean water on the ice conditions of this sea.

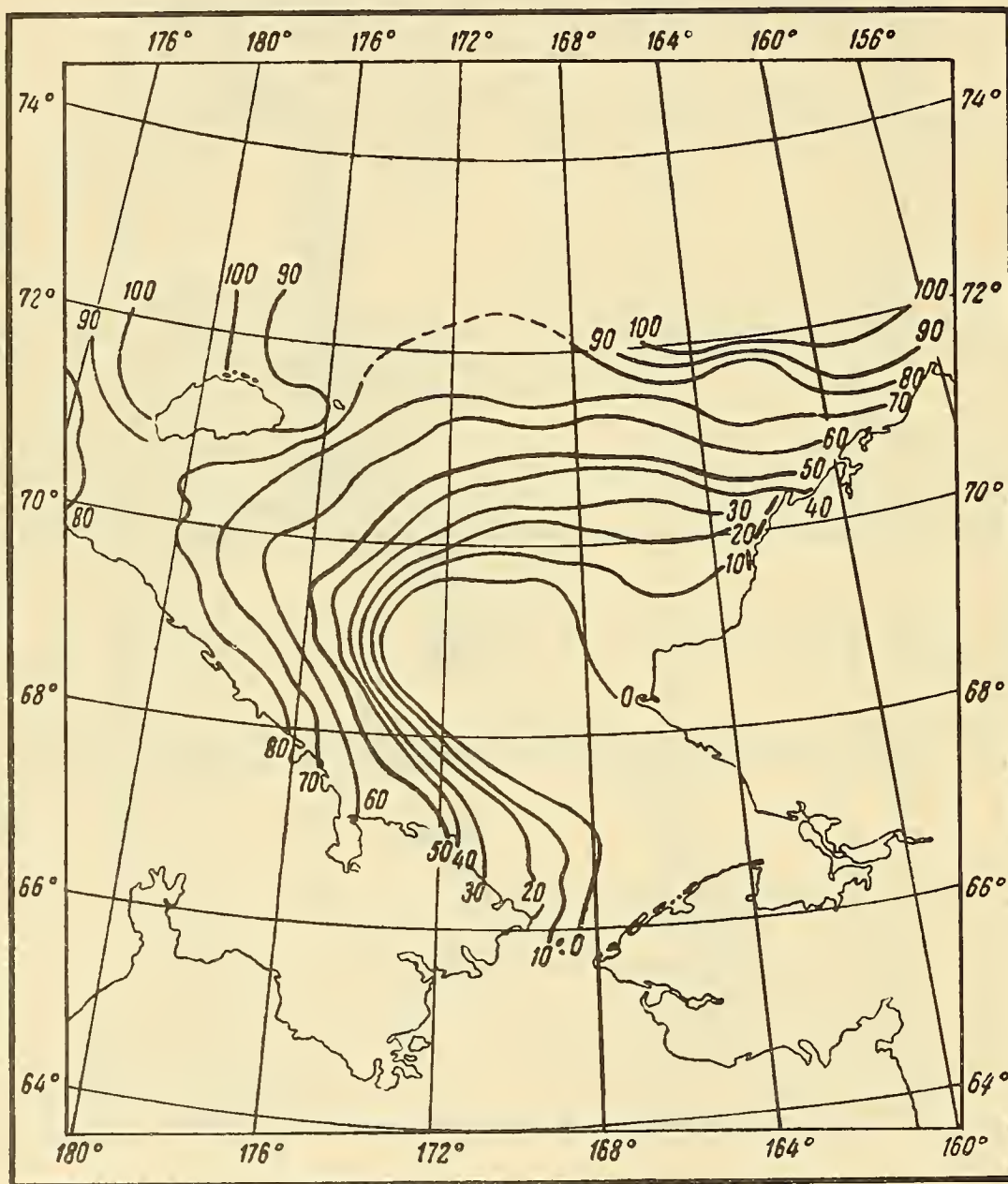

Figure 186. Probability of the presence of ice in the Chuckchee Sea during the navigational period.

TABLE 117. AREAS OF OPEN WATER DURING THE SUMMER MONTHS IN CHUCKCHEE SEA (1924 TO 1938)

Months	July	August	September	Average
Thousands of square km	172	237	290	250

In examining the above-cited figures and tables it must be remembered that all of them have only a relative significance for navigation. The determining factor for navigation is not the quantity of ice in the whole area of the sea but its distribution along the course of the Northern Sea Route.

From tables 114 to 117 it follows that, on the average, in the seas of the Soviet Arctic from the Barents Sea to the Chuckchee, 1,500,000 square km of ice melt away annually. If we take the average ice thickness as equal to 2 m (taking polynyas into consideration), we obtain 3,000 cubic km.

LITERATURE: 32, 77, 85, 147, 150, 160, 171.

Section 156. Long Term Fluctuations

The data cited above give an indication of a certain average ice-abundance of the given region. In certain years, however, as observations show, extremely sharp deviations to one side or the other of the norm may occur, and what is more, in only a few cases are we able to explain these deviations. Thus, for example, it is known that from 1892 to 1897 a considerable increase in quantity of ice was observed in the antarctic. A similar ice "eruption" reoccurred in the antarctic in 1922. Typical for the Barents Sea was the ice "eruption" of 1929, when a few individual icebergs went as far as the Murmansk coast. The greatest quantity of floating ice in the Barents Sea was noted in 1901, 1912, and 1917.* Conversely, 1930, 1931 and 1932 were exceptionally low in ice quantity.

In the region south of Newfoundland there was very little ice in the years 1881, 1917, 1924 and 1931, while 1890, 1909, 1912 and especially 1929 were years of ice "eruptions."

Table 118 shows the maximum and minimum areas of open water in August in the seas of the Soviet Arctic. From the table we may see how much the quantity of ice and area of open water fluctuates from year to year.

A number of hypotheses have, of course, been advanced to explain the above noted anomalies, but in proportion to the prolonged period of observations and the accumulation of data they are, so far, all of little value.

Some consider the fluctuations of ice-abundance to be periodic. Thus, Meinardus defined a periodicity of 4.5 years for the Greenland floating ice. Brooks and Kennell, recomputing the data of Meinardus, consider the period as 4.76 years. Vize obtained a similar period independently of Brooks and Kennell.

*In the middle of August 1903, the western ice-edge in the Pechor Sea extended from the Gulyaevskie Islands to the west coast of Novaya Zemlya and beyond in a 30 mile strip to the north along the west coast of Novaya Zemlya to Matochkin Shar.

TABLE 118. MAXIMUM AND MINIMUM AREAS OF OPEN WATER
IN THOUSANDS OF SQUARE KM IN AUGUST IN SEAS
OF THE SOVIET ARCTIC

Sea	Barents	Kara	Laptev	Chuckchee
Years	1900-1928	1930-1936	1932-1936	1924-1938
Maximum Areas	1333	720	290	307
Minimum Areas	816	180	100	151

Basing his work on the results of ship navigation in the Kara Sea and also on certain biological indications, Burke found that two periods may be distinguished for the ice of the Kara Sea: one a thirty-year period, the other a three-year period. The warm thirty-year periods alternate with cold thirty-year periods, and on the general cold or warm background every third year is comparatively low in ice quantity.

Thus, according to Burke, the period from 1869 to 1898 was a warm one for the Kara Sea and the following years were especially low in ice quantity: 1869, 1872, 1875, 1878, 1881, 1884, 1887, 1890, 1893, 1896. The period from 1899 through 1929 was a cold one, but the following years were distinguished by comparatively low ice quantity: 1899, 1902, 1905, 1908, 1911, 1914, 1917, 1920, 1923, 1925, 1926. According to Burke, a warm period again began in 1929, and the years 1929, 1932, 1935, etc. were distinguished by low quantity of ice. Thus Burke considered that the warming of the Kara Sea will attain its maximum around 1943 and 1944 while cooling will not commence until 1959.

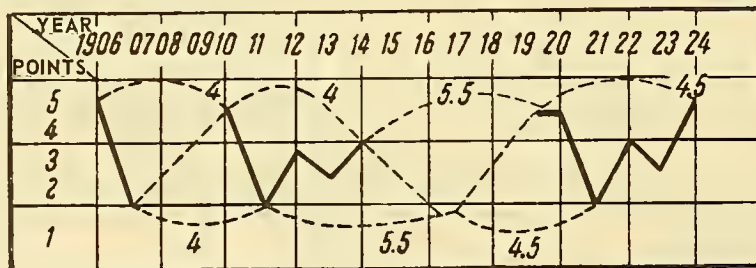

Figure 187. Fluctuations of ice abundance in the East Siberian Sea.

Vize, after analyzing the ice abundance of the seas to the east of the Kolyma River and north of Bering Strait from 1906 to 1924 comes to the conclusion that the periodicity of ice abundance of 4 to 5 years which has been observed by the Chuckchee is confirmed. He considers that it amounts on the average to 4.6 years (figure 187), that is, almost exactly equal to the periodicity found along the shores of Iceland.

Figure 188 shows, according to Itin, the ice abundance in the Kara Sea and in the sea to the east of the Kolyma River. Itin employed a 5-point classification system after analyzing the navigability of these seas in various years. Despite the incompleteness of the data and the somewhat unreliable evaluation of ice quantity in certain years, the law of "ice opposition" of the Kara and

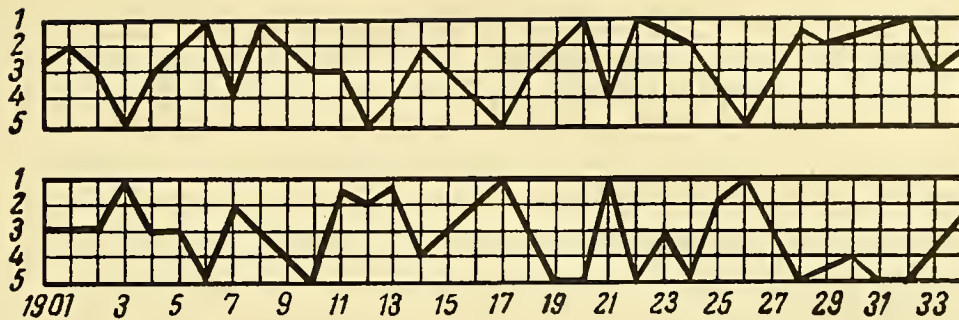

Figure 188. Graph of comparative ice-abundance in the Kara Sea (upper curve) and in the sea east of the Kolyma River (lower curve).

Chuckchee Sea, that is, low ice quantity in the Kara Sea corresponding to high ice quantity in the Chuckchee Sea and vice versa, is quite evident.

I, personally, have not been able to note a periodicity of short cycles in my investigations into the ice abundance of seas of the Soviet Arctic.

LITERATURE: 22, 32, 34, 77, 78, 119.

Section 157. Certain Factors which Determine the Ice Abundance of the Arctic Ocean

We may conditionally divide into several groups the factors which govern the ice abundance of the Arctic Ocean. Some of these may act in the same direction over very long time intervals and are connected with world-wide variations in climate. To this group belong astronomical and geological factors. A second group acts over a series of years and sometimes over scores of years and is connected with climatic fluctuations. To this group belong temporary changes in the general circulation of the atmosphere and hydrosphere over the entire globe. Finally, a third group consists of factors which change the ice abundance from year to year. To this group belong the temporary changes in circulation of atmosphere and hydrosphere in the Arctic Basin itself and in the atmospheric and oceanic centers of action which exert the greatest influence on conditions in the Arctic Ocean. The last group of factors is obviously of the greatest practical interest. We must not forget, however, that fluctuations in ice abundance from year to year are superimposed on a definite background created by factors acting over great time intervals.

Also we must not forget the influence of the ocean which smooths out the sharp fluctuations of atmospheric conditions. This remark refers particularly to the influence of extensive, deep and uniform ocean regions, since it is only in such regions that quantities of heat are absorbed or given off which are sufficient for an essential change in synoptic processes. An example of this is the Atlantic (Gulf Stream) current and its offshoots, meeting all the above-listed conditions.

LITERATURE: 77.

Section 158. Astronomical Factors

Of the astronomical factors which exert an influence on ice abundance, of greatest interest are the variations in the sun's activity which are connected with the 11-year sun spot period and the periodic variations in mutual relations of the earth, moon and sun.

Clayton points out the influence of quantity of sun spots on atmospheric pressure and consequently on the distribution of precipitation. The fluctuations in level of certain lakes, depending mainly on quantity of precipitation, show a striking concurrence with the changes in sun spots. It is remarkable that Lake Ladoga, for example, has more water at the time of the sunspots minimum than at the maximum, while Lake Victoria in Middle Africa is the reverse. This is due entirely to the different pressure pattern which occurs in connection with these lakes as a result of solar activity.

Memery goes somewhat further in his investigations. He notes that since 9 sun spot periods equal 100 years and if the quantity of sun spots affects the weather, approximately every 100 years (we note that 100 years almost corresponds to three of the 35-year periods of Bruckner) the weather should repeat itself. Memery confirms this assumption by means of thirteen sharp deviations in seasonal weather from the norm for the period 1888 to 1928 which corresponds to similar seasonal weather deviations for the period 1788 to 1828. In connection with this, in his work which was printed in 1928 Memery warned of severe winters expected in 1929 and 1930, which, as we know, was very strikingly confirmed for the winter of 1929-30.

On the other hand Memery attempts to explain why, since we have an 11-year sun spot period, we do not have an 11-year weather period. Memery shows that the quantity of sun spots varies extremely irregularly during one single year. It sometimes increases, sometimes decreases, and the yearly maximum sometimes falls in the summer, sometimes in the winter. In 1928 the maximum of solar activity fell in August and this caused positive deviations of temperature in that summer. Whenever the minimum of sun spots falls in the winter we must expect negative deviation of temperature in that winter.

In studying the long term changes in ocean level we discover two factors: first, the average yearly levels of separate parts of the ocean and particularly the levels of individual semi-closed seas differ from each other by more or less considerable amounts. Secondly, the average yearly levels increase or decrease over a large expanse of the shore. This phenomenon is most typical, of course, in the semi-closed seas.

Thus, for example, along the whole coast of the Baltic Sea, including its bays, the average yearly level was lower than the average long-term level in 1891, 1897, 1901, 1904, 1908, etc. and higher than the average long-term level in 1893, 1899, 1903, etc.

The latest American investigations show that the increase or decrease of average annual level occurs along the entire coastline of the U.S.A., both on the Atlantic and Pacific. In all Pacific Ocean ports the increases and decreases in average yearly level fall in the same years. In all Atlantic ports these variations of the average yearly likewise fall on the same years, but these are different from the corresponding years on the Pacific coast. According to Marmer, for example, the highest levels on the Atlantic coast of the U.S.A. fell in 1902, 1910 and 1919.

L'Allemand and Prevaux's special research on the results of French levelling work shows that the long-term fluctuations in level are periodic and are connected with lunar periods. We may thus consider it certain that the long-term variations in ocean level, in any case in a certain part of it, are connected with long-term variations in the tide-producing forces of the moon and sun.

But variations in level, especially when occurring simultaneously over a large ocean expanse, are caused by great shiftings of the appropriate water masses. These shiftings are reminiscent in character of the shiftings connected with wind-caused phenomena. The surface water, moving into the shore or into a separate sea, raises the water level. At the same time the

reverse current of deep water out into the open ocean is intensified. When the surface water recedes, the phenomenon occurs in reverse. The similarity of tidal phenomena and wind-caused phenomena lies also in the fact that comparatively small changes in surface level are accompanied by very great amplitudes of rise and fall of deep water.

Petterson first called attention to the internal waves of large period in his study of the seasonal vertical fluctuations in salinity in the Danish Strait and at the same time he connected the period of these fluctuations with periods of astronomical phenomena.

Danus called the tidal on-shore driving "transgressions." Comparing the conclusions of Petterson, L'Allemand, Prevaux and others, he found that the basic periods which determine the nature of transgressions of surface water (on-shore driving) and deep water (off-shore driving) are as follows: 1 — 4.65 — 9.3 — 18.6 — 111 years, etc. Actually, when Petterson studied the long-term fluctuations in catch of fish in the Danish Strait he found a period of 111 years. Dorsey Thomas found that the maximum catches of fish at Edinburgh occurred every 18.6 years, etc.

The largest astronomical period to have an effect on the ice abundance in the Atlantic sector of the arctic, as analyzed by Petterson, is equal to 1,800 years. Every 1,800 years the sun, moon and earth are in one plane and on one straight line under conditions of shortest distance from the earth to sun. At such moments the tide-forming force reaches its maximum intensity and on account of this the maximum disturbances of equilibrium are provoked both in the atmosphere and in the hydrosphere.

Such mutual positions of the heavenly bodies occurred in the years 2100 and 360 before our era and in the year 1433 of our era.* The historical research of Petterson indicates that great climatic and oceanographic variations occurred around these years in the North Atlantic.

The Norwegian Vikings in the 10th and 11th centuries evidently experienced no difficulties due to ice when sailing to Greenland. Eric the Red, in the course of his voyage of 984 to 987, passed along the east coast of Greenland from Angmagsalik to the southern extremity of Greenland. In these times, according to Petterson's opinion, the East Greenland current was as free of ice as is the East Iceland current at the present time, and the Greenland ice did not go past Cape Farewell into Baffin Bay. The climate of Greenland in those times was similar to the present climate of Norway in the same latitudes. Starting with the year 1261 the first written indications appear of an ice blockade of Iceland.

At the same time there began some very severe winters in Norway and catastrophic floods on the east coasts of the North Sea.

LITERATURE: 62, 77, 101, 148, 149, 159, 163.

Section 159. Geological Factors

Nansen paid great attention to the discussion of the effect of geological factors on the ice abundance of the Arctic Ocean. He considered that the oceanographic conditions in the Arctic Basin very obviously exert a great influence on climate.

The arctic water, of low salinity and below temperature, protects the lower-lying Atlantic water from cooling and thus makes the arctic climate more severe. If this layer did not exist, the

*The Soviet author does not employ "B. C." and "A. D." - Translator.

vertical circulation would be intensified and this would partially increase the entrance of Atlantic water into the Arctic Basin.

Considering that the layer of surface arctic water is formed partly by precipitation but chiefly by coastal drainage, Nansen came to the conclusion that if the Siberian and American rivers had emptied into the Pacific or Atlantic Ocean in the early geological periods, arctic surface water would be warmer. But, adds Nansen, such great changes in the direction of coastal drainage could barely have occurred in comparatively recent geological periods. It seems to me that Nansen somewhat exaggerates the role of coastal drainage in this respect. Actually, we have seen that on account of repeated melting and freezing as well as for other reasons, the arctic surface water in the central part of the Arctic Basin is fresher (less saline) than on the periphery.

Nansen considered that possible variations in depth and outlines of shores and sea bottom in the northern seas might be another cause of variation in climate.

The underwater ridges between Greenland, Iceland and Norway, and likewise between Novaya Zemlya, Franz Joseph Land, Spitzbergen and Greenland certainly retard the water exchange between the Atlantic Ocean and the Arctic Basin.

In recent geological periods there were evidently fluctuations of sea level along the coasts of the North Atlantic, Norwegian Sea, and the Arctic Basin, reaching amplitudes of 1000 m at the very least. The lowering of the land level and the ocean bottom brought about a milder climate in the arctic regions, particularly in Scandinavia and to some extent in Northern Russia and Siberia.

On the other hand, a lowering of sea level, let us say by 500 m, would cause still greater changes. The Baffin, Greenland and Norwegian Seas would be almost completely cut off from the Atlantic Ocean. The warm Atlantic water would not enter these seas and the ice would not be carried out of these seas into the Atlantic. Under such conditions a glacial period would begin in Scandinavia and its climate would become like the present climate in southern Greenland.

However, in Nansen's opinion, such fluctuations in sea level and other variations in the circulation of the hydrosphere in the northern seas cannot explain the tremendous changes in climate noted by geologists in Spitzbergen, the New Siberian Islands, western Greenland, etc.

LITERATURE: 62, 77, 165.

Section 160. Climatic Factors

There are as yet no complete and generally accepted hypotheses to explain the short-term and long-term deviations from the norm of ice abundance and their connection with variations in hydro-spheric and atmospheric conditions. This is, of course, due to the unusual complexity of the question. Actually, while the behavior of the trade winds in the Atlantic Ocean affects the behavior of the Gulf Stream, and while the intensity of the southwestern air current affects the behavior of the North Atlantic drift, the Gulf Stream and the North Atlantic drift on the other hand cause the maximum anomalies of air temperature and pressure which are to be observed on the earth's surface.

Of greatest importance for the ice abundance of the seas in the Soviet sector of the arctic, due to their eastern position relative to the northern part of the Atlantic Ocean, are the temperature conditions of the Gulf Stream and its offshoots. The Atlantic water not only heats the Arctic Ocean but also, by indirect influence, creates the temperature and wind conditions of the air masses.

Thanks to the work of Nansen we know that underneath the cold and non-saline surface water of the central part of the Arctic Basin lies the warm Atlantic water. The speed with which this warm water moves to the east may be determined from the following considerations, which are partially confirmed by the studies of Dobrovolski: It is believed that about 4 years is required for polar ice to move from east to west--from Bering Strait to Greenland Sea--and it is natural to assume that the same time interval is necessary for movement of Atlantic water in the reverse direction, i. e., from Spitzbergen to Bering Strait.

We have as yet by no means discovered how the subsequent eastern passage of deep Atlantic water along the continental slope of the Siberian coast affects ice conditions in the corresponding regions. There is no doubt, however, that the temperature of this water does have an influence on ice abundance, for these reasons: first, because this water is involved in one way or another in the vertical circulation which accompanies ice formation, and second, because this water (after mixing with other water) comes out on the surface of the sea in certain definite areas, as a result of driving phenomena which are caused by one factor or another.

This discussion must be supplemented by the following. The presence of anomalous warm or anomalous cold water in one sea region or another brings about an anomalous distribution of meteorological conditions, in particular pressure patterns and as a result, a distribution of winds. But if the sea temperature is connected on the one hand with ice abundance and on the other with a pressure pattern, there should then be a certain dependent relationship between pressure and ice abundance. Therefore the efforts to find this relationship from observations of ice abundance and pressure distribution are quite understandable.

Meinardus came to the conclusion that a weak air circulation in the north Atlantic from August to February accounts for the comparatively small quantities of floating ice at Newfoundland in the following spring, and the converse is also true. Meeking considered that the pressure gradient across the ice current along the shores of Labrador in the preceding winter is the main factor which determines the boundaries of floating ice in the northwest part of the north Atlantic.

Lesgaft, studying ice conditions in the Kara Sea from 1869 to 1911, determined that with comparatively favorable ice conditions in the north and in the southeast of the Barents Sea, favorable conditions are established likewise in the northern part of the Kara Sea, north of the northern end of Novaya Zemlya and in Matochkin Shar. Likewise, unfavorable ice conditions in the northern and southeastern parts of the Barents Sea are associated with unfavorable conditions in the northern part of the Kara Sea. From such facts Lesgaft concluded that in these parts of the Arctic Ocean the ice conditions are regulated by one general principle. Ice conditions in the southern part of Kara Sea do not depend on the ice conditions of the Barents Sea and are determined by the pressure gradient at Cape Karmakula-Obdorsk.

Vize subsequently showed that an increase of pressure in northern Greenland and north of Iceland in June or July corresponds to a great quantity of ice in the Barents Sea in the following August, the converse also being true.

The authors mentioned above have noted that small ice quantity is the result of an appropriate distribution of atmospheric pressure. Other authors, for example Brooks and Kennell, found on the contrary a connection between ice abundance in the polar seas and the subsequent pressure distribution in Western Europe. It must be noted that these are only apparent contradictions, since, as we have often noted, the general circulation of the atmosphere is very closely connected with the general circulation of heat in the ocean.

In the final result, for the European-Atlantic sector of the arctic, the various combinations of mutual action of atmosphere and hydrosphere along the routes of the Atlantic water have their effect on the location of paths of cyclones which arise in the region south of Iceland and have an effect on the intensity of atmospheric circulation. Seherhag shows, for the period 1921 to 1930, that the Iceland and Aleutian lows deepened by almost 5 mb in the winter, while the pressure in the whole subtropical zone increased (figure 189). The transfer of polar maritime air from the Atlantic into Barents Sea increased in accordance.

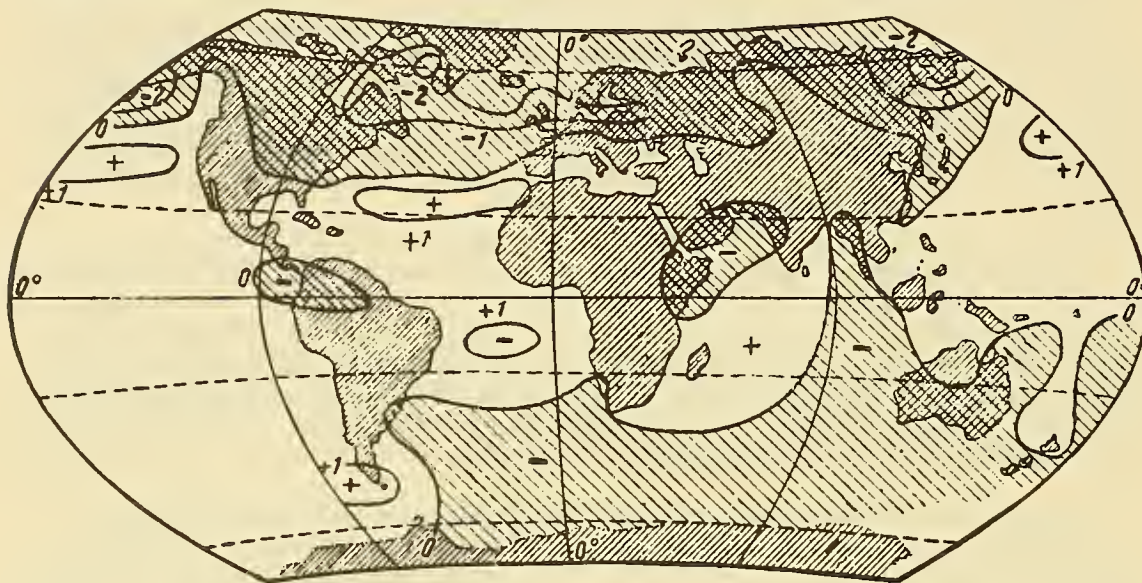

Figure 189. Anomalies of atmospheric pressure for 10 year period from 1921 to 1930 (in mb) according to Seherhag.

On the other hand, the warmer Atlantic waters themselves and the absence of ice bring about an increase in atmospheric circulation, and the cyclone paths accordingly run further north. More northerly cyclone paths create warmer conditions in the European-Atlantic sector of the arctic.

LITERATURE: 29, 49, 77, 99, 100, 161, 162, 170.

Section 161. Synoptic and Oceanographic Factors

We have already seen that as a general rule the ice abundance of a given region is a combination of the ice abundance due to local ice and that due to ice exchange with adjacent seas. The ice abundance due to local ice depends on:

1. Meteorological conditions (in the broadest sense of the term) in the period of ice formation and melting.
2. Water exchange with neighboring seas insofar as this water exchange exerts an influence on temperature conditions of the sea.

Since meteorological conditions and water exchange vary from year to year within fairly wide limits, it is therefore natural that ice conditions should also vary considerably. What is more,

with the same average annual meteorological conditions and water exchange, the ice conditions may be different, owing to a phase displacement in these conditions.

Ice abundance due to local ice is easily subjected to analysis. Actually, in the first approximation we may here consider that the main factors which determine ice abundance are as follows:

1. Ice abundance and temperature in the basin at the start of winter cooling. The less ice present and the higher the sea temperature, or more accurately, the greater the index of freezing, the less ice abundance may be expected in the following year.

2. Synoptic conditions in the period of cooling and ice formation. The decisive factors at this period are air temperature and wind force. The speed of cooling of the sea is directly proportional to the severity of the weather, depending on air temperature and wind force, while the thickness of ice which will form with uninterrupted growth is proportional to the number of degree-days of freezing. In addition, the stronger the winds the more intense is the hummocking of ice. It has already been pointed out that in the border seas of the Soviet sector of the arctic the thickness of ice growth which forms during the winter exceeds 2 m only in the most northerly regions, while the average thickness of hummocking ice in the same regions reaches 4 m. It is clear, therefore, that the less the number of degree-days of freezing, and the less the total severity of weather in periods of cooling and ice formation, and finally, the less the index of turbulence of the atmosphere, the less ice abundance may be expected in the subsequent year.

3. Synoptic conditions in the period of weakening of ice. The decisive factors in this period are the temperature and humidity of the air and the force of the wind. Break-up occurs after the ice has become sufficiently weakened by melting under influence of currents, tides and wind. The earlier the ice weakens (due to air temperature, humidity and solar radiation), and the earlier the break-up occurs (which is always hastened by the wind), the less ice abundance may be expected in the sea.

4. Synoptic conditions in the period of ice destruction. After the first movements of the ice have begun, wind force and direction acquires great significance. While the most favorable wind directions may be determined before the first ice movement in each individual sea, in the period of ice destruction particular importance is attached not only to wind force but also to the variability of its direction. Actually, the more often a wind of identical force changes its direction, the greater will be the amplitude of movement of individual floes, the greater will be spring hummocking, and the more broken-up the ice will be (other conditions being equal). The quantity of solar energy expended in melting of ice is directly proportional to the area of open water. We recall, in addition, that when warm air flows over ice, a comparatively thin cushion of cold air forms over the ice. When the wind is sufficiently strong this cushion is demolished. Thus, the stronger the wind and the more variable its direction in the period of ice destruction, or in other words, the greater the index of atmospheric turbulence, the less ice abundance may be expected in the period of navigation, provided navigation is generally feasible in the given region.

5. Synoptic conditions in the period of navigation. In case of low ice quantity in a sea, the synoptic conditions during navigation have no particular significance, but they become decisive when the ice is very abundant. The wind again plays the main role here. Its force and, more important, its direction, which determines the location of ice, may be favorable or unfavorable for the use of sea routes within or across this area. It has already been noted that the ice abundance of a sea in respect to ice of exclusively local origin is dependent, in addition to the above-listed conditions, on water exchange with neighboring seas. The greater this water exchange, the greater obviously will be the effect of water exchange on ice abundance.

Water exchange of seas, just like other meteorological and oceanographical processes, experiences seasonal and long-term fluctuations, while within any single year, in certain limits, it undergoes phase displacements. These variations may be expressed both in volume and heat of the currents and these together may be reflected on fluctuations in ice abundance.

In analogous fashion to the water exchange, coastal drainage exerts a great influence on ice abundance of shallow seas. For example, in the coastal regions of the Kara, Laptev and East Siberian Seas the coastal drainage is a primary factor in the ice quantity, changing the latter as a result of the force and time of onset of spring flooding.

More complicated are the fluctuations in ice-abundance in seas and regions where a more or less intensive ice exchange with neighboring seas occurs,

In the Barents Sea, ice of local origin predominates. The movement of ice out of this sea and the movement of ice into it from the Arctic Ocean and the Kara Sea are slight and nearly balance each other. Therefore the main factors determining the ice abundance of this sea are the heat conditions of the Norwegian current and the meteorological conditions which are to a great extent regulated by the heat conditions of Atlantic water.

In the Kara Sea, besides the synoptic conditions, the Ob and Yenisei and other rivers are of great importance for the southern part of the sea. The ice exchange with Barents Sea is slight, and the coming and going of ice is almost balanced. The ice exchange of this sea with the Arctic Ocean and the Laptev Sea, however, is quite another matter. Fluctuations in the loss of ice may be considerable in certain years, and these very fluctuations, especially in the pre-navigational period, may perhaps play the most important role in the ice conditions of this sea.

These fluctuations and the carrying away of ice are determined not only by fluctuations in the state of the Kara Sea itself but are also connected with the circulation of air masses over the adjacent parts of the ocean, over the Barents and Laptev Seas, and in particular over the central part of the Arctic Ocean.

In the northwestern part of the Laptev Sea the most important factor is the entry of ice from the Kara Sea and the Arctic Ocean, while in the southeastern part the most important factor is the water condition of the Lena River. The entry of ice will vary to a considerably greater extent than the conditions of the Lena water, and therefore the ice conditions in the southeastern part of this sea are subject to considerably less fluctuation from year to year than those in the northwestern part.

The East Siberian Sea is protected from ice movement from the north by islands and shallows, and therefore its ice abundance depends mainly on hydrometeorological conditions. It is quite a different matter with respect to Long Strait and Chuckchee Sea. Wind conditions in the summer season are the basic determining factor as to whether these waters will have a great deal of ice or be completely ice free during the navigational period.

Appropriate observations and studies show that the spring season processes have the greatest effect on ice abundance in the arctic seas during navigation. Arctic navigation began unusually early in 1943 and continued under extremely favorable conditions. In this connection the following data are of interest.

Figure 190 shows the anomalies in melting of the snow cover in Siberia in 1943. In certain regions the snow cover melted 30 days earlier than normal. This is an extremely favorable

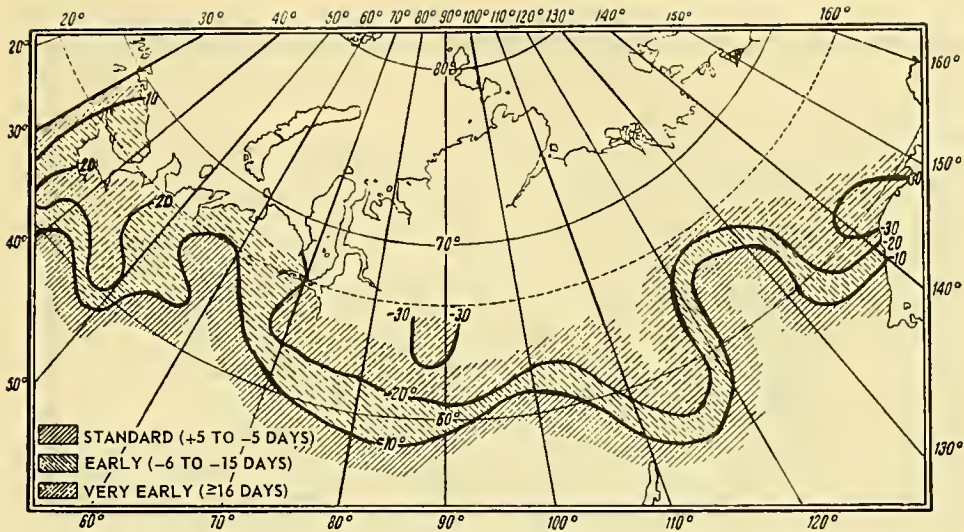

Figure 190. Anomalies of melting of snow cover in Siberia in the spring of 1943 (in days).

circumstance. Actually, under these circumstances the air masses which are carried from the south into the arctic do not expend their heat along the way in melting of the snow. In addition, the ground which is bare of snow acts as a good absorber of solar radiation and transmits the stored-up heat to the air.

Figure 191 shows anomalies in the break-up of rivers in the Arctic Ocean Basin. With the exception of the rivers Olenyok and Khatanga, where the break-up of the deltas was retarded by a slight cold spell which set in June, the break-up of rivers in 1943 occurred everywhere on an average of 10 days earlier than normal. In certain instances the anomalies amounted to 17 days. As a rule the break-up of rivers occurred in characteristic fashion, with moderately low water levels. This fact indicates that in the break-up process the most important factors were not dynamic (hydraulic pressure), but thermal (positive anomalies of air temperature). It is clear that the earlier the break-up of rivers occurs, the earlier will the coastal drainage begin to exert its favorable influence.

Figure 192 shows the anomalies of air temperature over the Soviet Arctic seas in May 1943. As may be seen from the drawing, all the seas (except for the northern part of the Barents Sea) had positive anomalies and the anomaly exceeded the normal by 6.6° on the coast of Chuckchee Sea.

Figure 193 shows the anomalies of atmospheric pressure in May 1943. The area of greatest negative anomaly (up to 8 mb) was located north of Severnaya Zemlya. This caused an increase in the transfer of air masses from west to east in the region west of the New Siberian Islands and an increase in north to south movement of air masses in the region east of these islands.

Figure 194 shows in mb the anomalies of atmospheric turbulence. It may be seen from the drawing that in May 1943 this turbulence was extremely high in all the seas of the Soviet Arctic. While the average May atmospheric turbulence fluctuates within the limits of 2.7 to 4.5 mb, in May 1943 the positive anomaly amounted to 2.5 mb (Cape Zhelania).

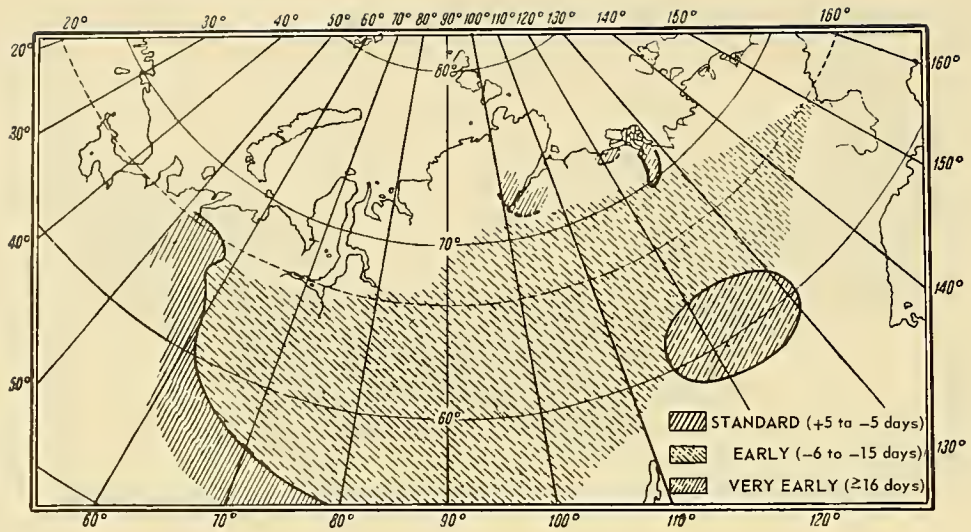

Figure 191. Anomalies of break-up of Soviet rivers that empty into the Arctic Ocean, spring 1943 (in days).

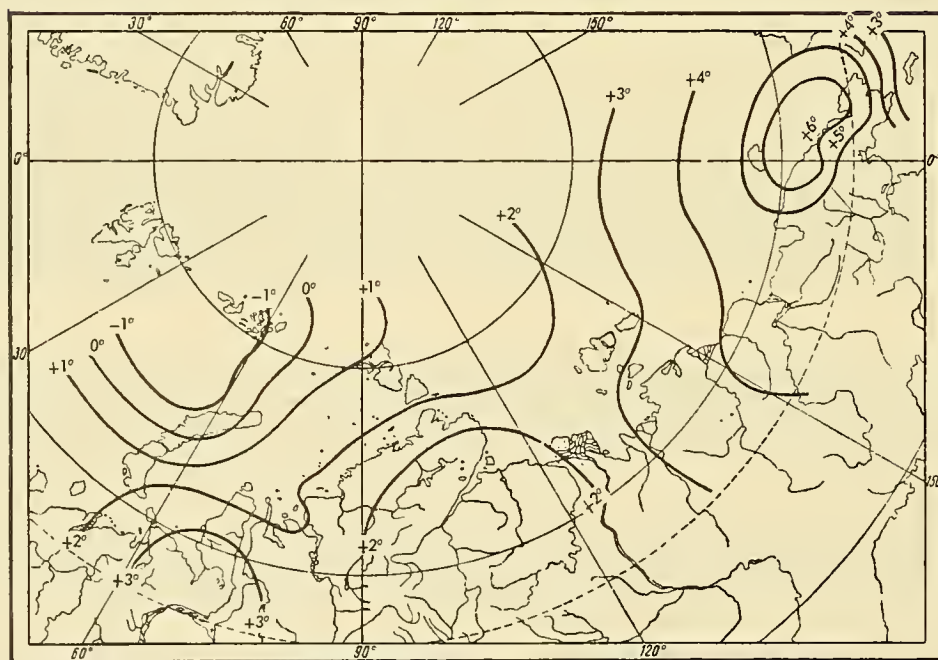

Figure 192. Anomalies of air temperature over the Soviet sector of the arctic in May 1943 (in degrees).

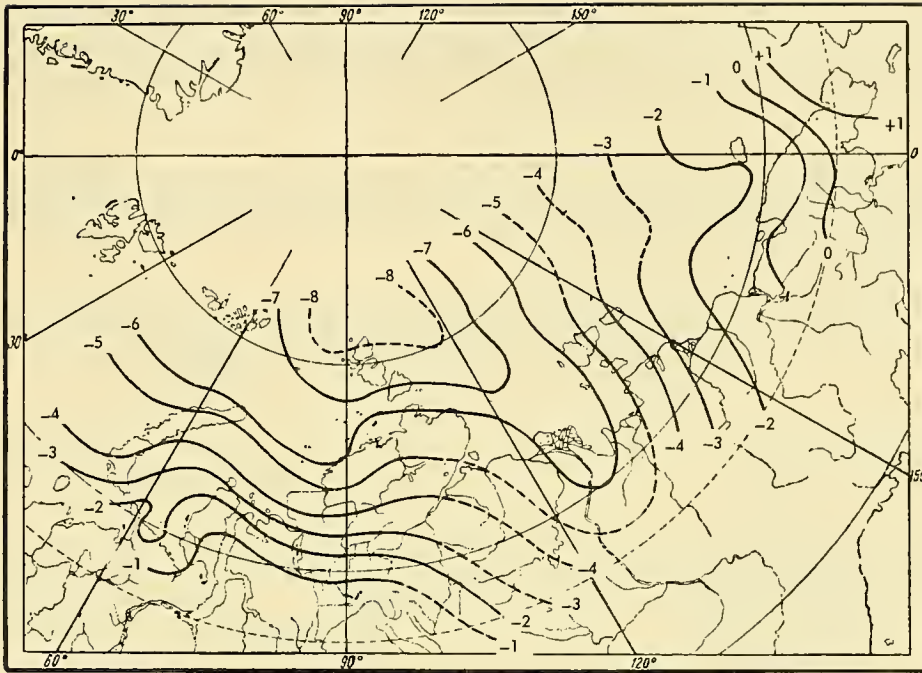

Figure 193. Anomalies of distribution of atmospheric pressure over the Soviet sector of the arctic in May 1943 (in mb).

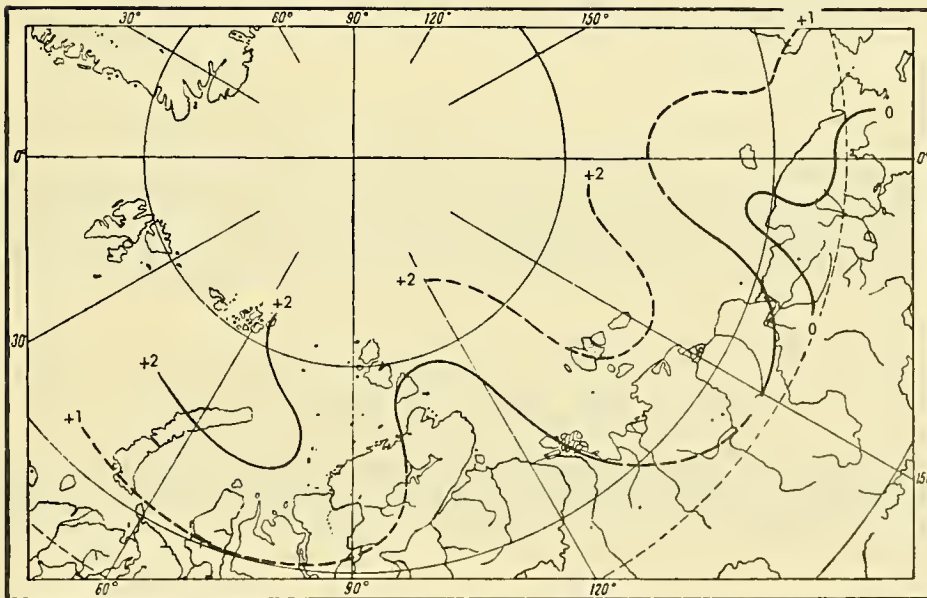

Figure 194. Anomalies of atmospheric turbulence over Soviet Arctic seas in May 1943 (in mb).

Atmospheric turbulence is characterized by variability in force and direction of wind. In May 1943 increased atmospheric turbulence and increased air temperatures were observed. This conjunction of favorable dynamic and thermal factors in the final result caused the favorable conditions for the springtime destruction of the ice.

Finally, in table 119 there are listed the anomalies of air temperatures passing through -2° and through 0° on the coast of the Arctic Ocean. These data are extremely approximate but they are typical in the respect that these transits took place everywhere earlier than the normal. This refers especially to the Kara and Chuckchee Seas.

TABLE 119. DEVIATIONS FROM AVERAGE DATES OF TRANSIT OF AIR TEMPERATURE THROUGH -2° AND 0° C AT STATIONS OF THE SOVIET ARCTIC - SPRING 1943 (IN DAYS)

Station	-2°	0°
Pt. Zhelania	6	--
Yugorski Shar	13	12
Uedineniya Island	7	24
Dickson Island	15	17
Pt. Chelyuskin	8	17
Tiksi Bay	9	3
Pt. Chalaurova	4	2
Pt. Shelagskii	13	10
Wrangel Island	15	8
Pt. Schmitt	15	12
Pt. Uellen	19	25
Kara Sea	10	17
Laptev Sea	6	3
Chukotsk Sea	16	14

Worthy of particular attention is the fact that in 1943 all the anomalies noted were favorable for navigation, that they extended to all the seas, and that in actuality navigation was extremely easy in 1943 along the entire course of the Northern Sea Route. The total area of clear water at the end of the navigational period in the Kara, Laptev, East Siberian and Chuckchee Seas amounted to almost 2,000,000 square km which is unprecedented in the history of the arctic. The ice opposition of the Kara and Chukotsk Seas (which was mentioned in Section 156) did not take place in 1943.

LITERATURE: 27, 58, 62, 77.

Section 162. Warming of the Arctic

Along with the fluctuations in ice abundance in each individual sea from year to year, in late years a most interesting phenomenon has been observed--a warming of the arctic, as evidenced by a gradual and universal decrease in ice abundance. The main evidences of this general warming of the arctic are:

1. Receding of glaciers and "melting away" of islands. According to the testimony of Wegener, all the Greenland glaciers which descend into Northeast Bay and Disko Bay, have been

receding since approximately the beginning of the present century. In particular the Jakobshavn glacier receded about 20 m during the period 1880 to 1902. As has already been mentioned, the glaciers of these two bays produce the main mass of the Greenland icebergs. Receding of glaciers during recent years has likewise been observed on Spitzbergen, Franz Joseph Land, and Novaya Zemlya.

On Franz Joseph Land during recent years several islands have appeared as if broken in two. It turned out that they had been connected up to that time by ice bridges.

During voyages on the *Perseus* in 1934 and the *Sadko* in 1935, I carefully compared the descriptions of glaciers on Jan Mayen and Spitzbergen in some English sailing directions of 1911 with what I observed and everywhere I noted a great decrease in size of glaciers.

Ahlman explored the glaciers of Spitzbergen in 1934 and found that these glaciers are now melting faster than they grow on account of fall of snow. Ahlman terms the rapid receding of the Spitzbergen glaciers "catastrophic."

Sungin informed me that the southern boundary of permafrost in Siberia is everywhere receding northward. In 1837 this boundary, for example, ran somewhat south of the town of Mezen and was found at a depth of 2 m. In 1933 the Academy of Sciences Expedition found this boundary at the village of Semzha 40 km further north.

The washing away of the Lyakhoskiye Ostrova and the disappearance of Vasilevski Ostrov in the Laptev Sea belong to the same type of phenomena.

2. Rise of air temperature. Since 1920 the average temperature of the winter months has steadily increased on the coasts of Baffin Bay, the Greenland Sea (Jacobshavn), Spitzbergen, Bear Island, Barents and Kara Seas. Even in the winter of 1928-29, when there was bitter cold in Europe, the winter temperature on Spitzbergen and Bear Island was only slightly under normal. Vize points out that at Vardo (northeast Norway) the average annual air temperature starting with 1918 is higher than the average for the century. The year 1926 represents an exception with temperature lower than normal by 0.2° .

Starting with 1930, in the whole arctic sector from Greenland to Cape Chelyuskin there has not been a single anomaly of average annual and monthly winter temperatures, while the positive anomalies have been very high. Thus, for example, in the winter of 1934-35 the positive anomalies of average monthly temperature in the region from Dickson Island to Cape Chelyuskin were from 4° to 10° . In November 1935 the positive anomaly on Spitzbergen amounted to 10° .*

Vize points out that if one compares the average air temperatures on the *Fram* and *Sedov* when the position of these vessels more or less coincided in respect to coordinates (average latitude of the *Fram* was $81^{\circ}59'$ north longitude, $113^{\circ}26'$ east; *Sedov*, $82^{\circ}48'$ north, $121^{\circ}30'$ east) and in respect to season (November 1893 to August 1895 for the *Fram*; November 1937 to August 1939 for the *Sedov*), it turns out that the average annual air temperature on the *Sedov* was 4.1° higher than on the *Fram*. In the six months from September through February this difference even amounted to 7.5° .

*The deviation of average air temperatures from the 50 year averages exceeded $+4^{\circ}$ in January to March, 1921 to 1931.

3. Rise in temperature of Atlantic water which enters the Arctic Basin. This rise is most clearly seen in existent systematic observations along the meridian of Kola (33°30' east). Taking the average temperatures of this section at depths of 0 to 200 m from 69°30' north to 72°20' north, and dividing existing observations into two periods, cold (1900 to 1906) and warm (starting with 1921), I have obtained a rise of average temperatures for May and August of about 0.7°. From this it follows that on the average a column of water of the Norwegian current 1 square cm in section and 200 m high has 14,000 g-cal more heat supply at the present time than at the start of the present century.

The warming of Atlantic water in the arctic is likewise seen in the following condition: in the regions adjacent to Spitzbergen and Franz Joseph Land there has recently been observed a rise of the lower boundary of the cold intermediate water layer from a depth of 150 to 200 m, as observed at the start of the present century, to a depth of 75 to 100 m in the present period.

The warming of Atlantic water is still more sharply seen by comparing temperature observations at the deep water observation stations which the *Fram* and *Sedov* made at almost the same geographical points. Figure 195 shows the vertical distribution of temperatures at two of such points from which may be seen the extent of the warming of Atlantic water during the past 40 years. At none of the observation stations of the *Fram* in the Arctic basin did the temperatures of deep Atlantic water exceed 1.13°. On the *Sadko* in 1935 we observed a temperature of Atlantic water of 2.68°, while according to observations of the *Sedov* in 1938, temperatures of Atlantic water even in regions North and east of the *Fram* drift (i. e., where it should have colder) were up to 1.8°.

Table 120, borrowed from Shokalski, shows the average yearly temperatures of surface water in the Florida current (in the region bounded by 25° to 30° north and 79° to 80° west) in Yucatan Strait (in the region bounded by 21° to 23° north and 84° to 87° west) and in the Gulf of Mexico (in the region bounded by 21° to 25° north and 90° to 94° west).

From the table it may be seen that the temperature of surface water and of Gulf Stream water has steadily risen starting with the first decade of the present century.

A rise in temperature of surface water has likewise been noted in other ocean regions which are under the influence of the Gulf Stream and the North Atlantic Drift, as may be seen from table 121 (likewise taken from Shokalski).

4. Decrease in ice abundance. We may judge about the decrease in ice abundance in the Greenland and Barents Seas from the ice maps of the Danish Meteorological Institute. According to Karelin's reckoning, the ice area in the Greenland Sea in April to August for the period 1921 to 1938 is 15 to 20 per cent less than for the period 1898 to 1920. From my calculations, the ice abundance in the Barents Sea for the same months from 1920 to 1933 was 12 per cent less than for the period 1900 to 1919.

It must be remembered that the ice in the Barents Sea is mainly of local origin. A decrease in its quantity is connected with a rise of temperature and speed of the Norwegian current.

Vize shows that the southern part of the Kara Sea (south of the parallel of Matochkin Shar), from the year 1929 has been free of ice in September of every year while for the period 1869 to 1928 the probability of finding ice in this part of the sea in the first half of September was about 30 per cent.

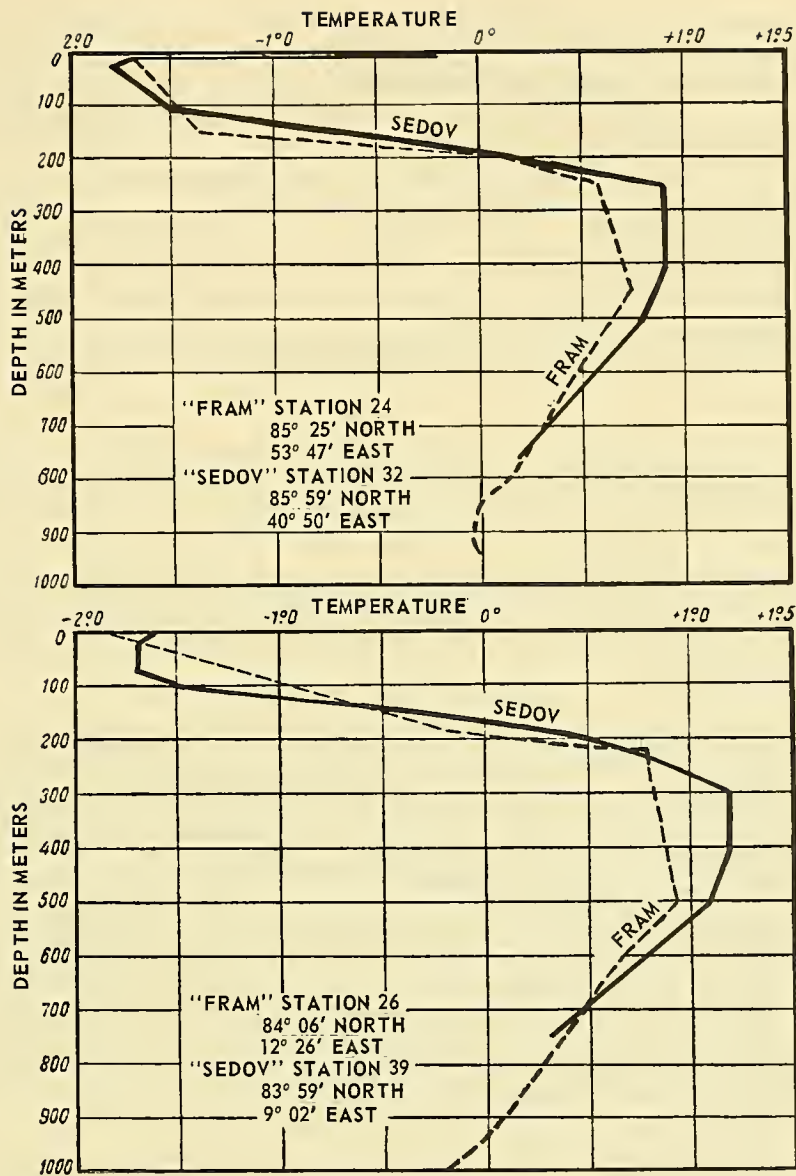

Figure 195. Vertical distribution of temperatures at closely situated observation stations of the *Fram* and *Sedov*.

In earlier times and at the start of the present century, polar ice often approached the shores of Iceland and there interfered with fishing and navigation. For the past 25 years ice has not appeared in significant quantities.

The Strait of Yugorski Shar froze over on the average about 24 November before the warming of the arctic. The average date of final freeze over from 1920 to 1937 was 25 January; that is, 2 months later.

TABLE 120. AVERAGE TEMPERATURE OF SURFACE WATER

Year Region	1912 to 1918	1919 to 1925	1926 to 1933	Temperature Rise
Florida Current	25.90° C	26.11° C	26.33° C	0.43° C
Yucatan Straits	26.77	26.71	27.03	0.26
Gulf of Mexico	25.24	26.09	25.88	0.64

TABLE 121. AVERAGE TEMPERATURES OF SURFACE WATER
IN THE ENGLISH CHANNEL

Years	1903 to 1911	1912 to 1919	1920 to 1947	Temperature Rise
Temperatures	11.7°	11.8°	12.1°	0.4°

The decrease in ice abundance has been felt in an increase in amplitudes of tides (which are generally dampened by the ice cover). For example, Vize shows that on Franz Joseph Land and on Dickson Island the amplitudes of the tide have increased by 20 per cent to 30 per cent during the period of warming of the arctic.

5. Increase in speed of drift of ice. The main mass of ice in the Greenland Sea is carried there from the Arctic Basin. The decrease in its quantity is likewise connected with an increase in speed and rise in temperature of the Norwegian and Spitzbergen currents, and with wind action. At first glance it would appear, however, that a decrease in ice abundance in the Greenland Sea should indicate a decrease in transfer of ice into the Greenland Sea from the Arctic Basin. The facts, however, indicate the reverse. During recent years Soviet sea expeditions have thrown out numerous buoys in the Greenland, Barents and Kara Seas in order to study sea currents and the drift of sea ice. Many of these buoys were subsequently found on the shores of Greenland, Iceland and Norway, and it turned out that all the buoys which were put out after 1933, upon calculation, show speeds of current and drift three to four times greater than before 1933. The drift speed of the station "North Pole" was 2.4 times greater than had been expected. The *Sedov* drift began and ended considerably further south than the *Fram* drift and ran further north, but the *Fram* drift lasted 1,055 days while the *Sedov* drift lasted only 812 days.

The decrease in ice quantity in the Greenland Sea along with the increase in transfer of ice into this sea from the Arctic Basin unquestionably shows a considerable intensification of the factors which determine the destruction and melting of ice in this sea, or in other words, an intensification of the appropriate action of atmosphere and ocean.

6. Change in cyclone routes. There is no doubt that the increase in air temperatures, increase in Atlantic water temperatures, intensification of ice drift, etc. are closely connected with an intensification of atmospheric circulation, and in particular with a change in cyclonic activity in the high latitudes.

Vize shows that the Atlantic cyclones are now shifting considerably north (by several hundred km) from their courses in the period before the warming of the arctic. This is felt in changes in wind conditions. For example, in Yugorski Shar before 1920 winds of easterly components (cold) prevailed, while after 1920 southwesterly winds (warm) began to prevail.

7. Biological signs of warming of the arctic. It is known that during the past years, fish (of fishing industry varieties) have ranged further and further to the north. For example, starting with 1929 cod in large quantities have appeared along the shores of Spitzbergen and Novaya Zemlya. In connection with this, the fish catch is increasing in the northern waters.

Thus, according to data of the International Council for the Study of the Sea, the catch of fish has increased in the Barents Sea. The fishing industry has likewise grown along the shores of Greenland, while from the water which washes Norway, Bear Island and Spitzbergen in recent years there has been taken 20 per cent of all the fish caught by north and northwest Europe in the Atlantic Ocean. The increase in catch of fish has occurred mainly as a result of mastering of the Bear Island fishing banks. Thus, during recent years the center of gravity of world fishing has gradually shifted into the Arctic waters, and this unquestionably must be ascribed in considerable degree to the warming of these waters.*

In addition, the investigations of Knipovich and the Oceanographical Institute show that in connection with the warming of the Barents Sea, many heat-loving bottom organisms, in particular certain Echinodermata, are now found in regions where these organisms were not found by the Northern Scientific Industrial Expedition which worked in the Barents Sea in the period 1900 to 1906. Basing his conclusions on these facts, Knipovich says: "In a matter of fifteen years or in an even shorter time interval there occurred a change in distribution of specimens of sea fauna such as is usually associated with long geological intervals."

8. Ship navigation. A ship passing through an ice region is not always an indication of greater or lesser ice abundance of that region. The proper choice of course and time of passage may assure the success of the operation while an incorrect choice of these conditions by a ship of the same type may create the impression of great quantities of ice. Thus, for example, a vessel which attempted to traverse the Northern Sea Route at any cost in August 1936 would have gotten the impression that the route was completely impassable due to ice. On the contrary, a through passage of the Northern Sea Route in the second half of September of that year did not present particular difficulties. In addition, it is very difficult to compare navigation along the Northern Sea Route at the start of the present century, for example, and at the present time, because the Northern Sea Route is now much better equipped technically. The widely developed net of radio and weather stations, ice reconnaissance by ships and planes, hydrographic equipping of the route, new navigational maps, and finally, accumulated knowledge and experience make present-day navigation considerably easier. We may nevertheless point out a number of ship voyages which could hardly have been accomplished in the preceding cold period. Among these are: our voyage on the sail-motorboat *Knipovich* around Franz Joseph Land in 1932, the rounding of Severnaya Zemlya by the icebreaker *Sibiriyakov* in the same year, through passages by ordinary steamships of the whole Northern Sea Route in 1935 (no ice being found on the route), etc. Further we know that starting with 1930 there was not a single year when it would have been impossible to round Novaya Zemlya from the north even in a ship which was entirely unsuited for navigation in ice. At the same time we know that the icebreaker *Yermak* in 1901 attempted to round Cape Zhelania from the west and was unsuccessful, although the *Yermak* spent almost a month in a struggle with the ice while waiting at the northwest shores of Novaya Zemlya.

*Mackerel formerly were not found north of Nordkapp, yet in 1937 was caught at Matochkin Shar. Dolphin were formerly not found east of Kaninski Peninsula, but were seen in 1933 east of Taimyr.

We may also recall the ship *Foka* of the *Sedov* expedition which in 1912 could not reach Franz Joseph Land and was forced to winter along the northwest shores of Novaya Zemlya. In the same year the ship *St. Anna* of the Brusilov expedition was caught in the ice along the shores of Yamal Peninsula after it had been carried there by the ice drift towards the central part of the Arctic Ocean.

We could cite numerous such examples, but the foregoing are sufficient to show that the navigational conditions, at least in seas such as the Greenland, Barents and Kara which have been more completely studied as to ice conditions, have become incomparably easier during the past 10 to 20 years than in previous years.

Due to insufficiency of observations, the question of warming of the arctic in its whole broad connotation has been propounded only very recently, namely in connection with preparation for carrying out the Second International Polar Year, when I had to plan the sea expedition routes in advance. Certain phenomena connected with warming of the arctic had been noted earlier. For example, Knipovich was the first to turn his attention to the high temperatures of the Barents Sea in 1921. This warming was then confirmed in 1923 by our voyage on the *Perseus* to Franz Joseph Land without meeting ice.

Still more remarkable is the fact that the warming of the arctic is not confined to any particular region. In actuality, the same signs of warming of the atmosphere and hydrosphere are found in the Bering Strait in the Pacific Ocean as in the western sector of the Soviet Arctic.

A warming of the antarctic is evidently also going on simultaneously, although there are as yet no data to permit reliable judgement concerning this.

On the background of general warming of the arctic we are observing warmer years and colder years, but there are not signs as yet that this warming is terminating, and this question, in connection with a deeper analysis of the causes of the warming, is one of the most interesting problems of contemporary oceanography.

LITERATURE: 14, 33, 35, 58, 62, 70, 72, 77, 144.

CONCLUSION

A multitude of factors act in different ways on hydrospheric and atmospheric conditions. In certain years and periods these factors may coincide in their direction of action and cause striking deviations from the average climatic and oceanographic conditions. Certain of these factors have been noted and their actions studied. Other factors have likewise been noted, but their meaning has not yet been properly evaluated due to insufficiency of data and too short time range of observations. Finally, as more detailed examinations are made and disseminated around the world, more and more new factors appear.

Along with the continual accumulation of factual material goes a deeper and deeper development of theoretical questions which permits, on the one hand, a summing up of the results of observations, and on the other, verifying the hypotheses reached. The development of this process will be hastened if it is realized that only constant, systematic, multifold observations of hydrospheric and atmospheric conditions, made simultaneously at many points, can give us the shortest road and the cheapest road (in the final result) to the solution of the important theoretical and practical questions concerning the causes of long-term and seasonal fluctuations in ice abundance in the various seas and concerning forecasting of such conditions in advance.

The importance of ice in the life of the world is sufficiently defined by the fact that about 2 per cent of the water on the earth is in solid form. Ice has particular importance for life in the ocean.

During the great periods of freezing, the accumulated ice broke through the earth's crust with its weight. With the onset of the warm periods, the melting of ice occurred faster than the return upheaval of the land, and the ocean flooded the hollows which were formed, thus creating the epicontinental seas.

Present day ice likewise reacts on ocean conditions in a most substantial manner. Due to ice, the shoreline and relief of bottom near the shore changes. The products of destruction of the shores, not only in the form of fragmented material but also in the form of great blocks of shore rock, are carried by ice far out from the shores and fall to the bottom of the open sea. Ice formation and melting change the salinity of the ocean. Ice creates favorable biological conditions in certain regions, unfavorable in others, and in certain regions the transfer from one type of condition to the other is seasonal in nature. The influence of ice on climate is very great. The sea covered by ice is not only protected from deep winter cooling but is also isolated from summer heating.

The great quantities of heat given off in the process of ice formation mitigate the winter air temperatures, while the heat absorbed in melting lowers the summer temperatures of the corresponding ocean regions. The constant transfer of ice from the polar areas into the lower latitudes is of still greater climatic significance. The quantity of ice which forms and melts away in place, and the quantity carried out of the polar regions changes from year to year to a considerable degree, and significant changes in world weather are connected with this.

The ice in the sea directly reflects on the practical activity of man, making navigation difficult in certain regions. Icebergs carried by the Labrador current into the Atlantic Ocean are, in certain years and months, a constant threat to sea routes of communication between the main ports of Europe and America.

Ice in the sea is of particular interest to the Soviet Union. Ice is a common occurrence in all the seas of the Union. The Gulf of Finland freezes over every year. In the coastal part of the Black Sea ice appears almost every year. The Sea of Azov freezes over solid in certain years. The northern part of the Caspian Sea freezes over every year. On the Soviet shores of the Pacific, down to the most southerly, ice likewise is found every year. All the border seas of the Soviet sector of the arctic become so covered with ice that in winter and early summer navigation here is impossible for even the strongest icebreakers in existence today.

Sea ice has acquired particular importance for the USSR in connection with the discovery of the Northern Sea Route and in connection with the flights from Moscow over the North Pole to America, initiating the Northern Air Route. Sea ice is the greatest obstacle in mastering the Northern Sea Route. In mastering the Northern Air Route the greatest obstacles are the meteorological conditions over the ice fields of the arctic; these conditions are strongly dependent on the state of these ice fields. Meanwhile, our knowledge of sea ice and of the laws which regulate its behavior, its movements and its spread, is extremely scanty, although it is increasing every year. To assist in the solution of the problem of sea ice is the modest but basic purpose of the present book.

BIBLIOGRAPHY

1. Abel's, G. "Izmereniia plotnosti snega v Ekaterinburge zimoiu 1890/91 g." (Measurements of snow density in Ekaterinburg during the winter of 1890-91), St. Petersburg, Akademiia Nauk, Volume 69, 1892. 24 pp.
2. Akkuratov, V. Na novykh trassakh (Over new routes). 1941.
3. Alekseev, N. N. "Kostrovam Vrangelia i GERAL'da p/kh Sovet'" (To Wrangel and Herald Islands on the steamer Soviet), Severnyi Morskoi Put', No. 5: 22-72, 1936.
4. Al'tberg, V. Ia. "Donnyi led i problemy Angary i Bol'shoi Volgi" (Anchor ice and problems of the Angara and the Great Volga), Gosudarstvennyi Gidrologicheskii Institut, Izvestiia, No. 39-40: 36-55, 1931.
5. Al'tberg, V. Ia. Podvodnyi led (Anchor ice). 1938.
6. Antonov, N. D. "Kolichestvo tepla vnosimoe rekami v Karskoe more" (The amount of heat carried into the Kara Sea by rivers), Vsesoiuznyi Arkticheskii Institut, Trudy, 35: 23-50, 1936.
7. Antonov, V. S. and M. I. Zotin. "Kratkii ocherk zhidkogo i teplovogo stoka rek v moria Sovetskoi Arktiki" (A brief review of the liquid and heat drainage of rivers into the Soviet Arctic), 1941.
8. Arnol'd-Aliabev, V. I. "O nekotorykh osobennostiakh ledianogo pokrova Finskogo zaliva po dannym nabludenii s ledokolov" (Some characteristics of the ice cover in the Gulf of Finland according to data obtained during icebreaker observations), USSR, Gidrograficheskoe Upravlenie, Zapiski po Gidrografii, 56, 1925.
9. Arnol'd-Aliabev, V. I. "Issledovanie prochnosti l'da Finskogo zaliva v 1923, 1927, i 1928 gg." (Investigation of the ice strength of the Gulf of Finland in 1923, 1927 and 1928), Glavnaia Geofizicheskaiia Observatoriia, Izvestiia, No. 2: 15-28, 1929.
10. Arnol'd-Aliabev, V. I. "L'dy Finskogo zaliva po dannym issledovaniu s sovetskikh ledokolov za period 1922-1923 gg" (The ice of the Gulf of Finland, according to Soviet icebreaker data of 1922-1923), IV. Gidrologicheskaiia Konferentsiia Balticheskikh Stran, Trudy, 1933.
11. Badigin, K. S. Na korable "Georgii Sedov" cherez Severnyi Ledovityi okean; zapiski kapitana (Across the Arctic Ocean on the Georgii Sedov; captains' notes). Moscow, Izdatel'stvo Glavsevmorputi, 1940. 605 pp.
12. Barabonov, G. V. and A. I. Richter. "Deistvie l'da na gidrotekhnicheskie sooruzheniia v Nevskoi gube (The effect of ice on hydraulic equipment in Neva Bay), IV. Gidrologicheskaiia Konferentsiia Balticheskikh Stran, Trudy, 1933.
13. Barnes, Howard T. Ledotekhnika (Ice engineering). Translated from the English. Originally published by the Renouf Publishing Co., 1928.

14. Berg, L. S. "Nedavnie klimaticheskie kolebaniia i ikh vliianie na migratsii ryb" (Recent climatic fluctuations and their effect on fish migration), Problemy Fizicheskoi Geografii, 1935.
15. Berezkin, Vl. A. "Vliianie priliva na gidrologicheskii rezhim gorla Belogo moria" (The influence of tides on the hydrological conditions in the entrance of the White Sea) USSR, Hidrograficheskoe Upravlenie, Zapiski po Hidrografii, 56: 81-114, 1929.
16. Berezkin, Vl. A. "Grenlandskoe more i Severnyi Poliarnyi bassein" (The Greenland Sea and the Polar Basin), Vysokoshirotnaia Ekspeditsiia na Sadko v 1935, Trudy, 1(1): 11-184, 1939.
17. Bernshtein, S. A. "Ledianaia zheleznodorozhnaia pereprava" (Railroad ice crossing), Trudy Nauchno-Tekhnicheskogo Komiteta Narodnogo Komissariata Putei Soobshcheniia, 84: 36-82, 1929.
18. Biriulin, G. M. and M. M. Somov. "Vliianie dreifa na ledovitost' moria Laptevykh" (The effect of drift on the ice conditions of the Laptev Sea), Problemy Arktiki, No. 7-8: 5-12, 1940.
19. Brunt, D. Physical and Dynamical Meteorology, 2nd ed., Cambridge, England, Cambridge University Press, 1939.
20. Bruns, B. P. "Nabliudeniia nad protsessami obrazovaniia i taianiia morskogo l'da" (Observations on processes of formation and melting of sea ice), Vsesoiuznyi Arkticheskii Institut, Trudy, 83: 75-97, 1937.
21. Burke, A. K. Atlas kart sostoianiia l'dov szhatii i razrezhenii v severnoi chasti i Gorle Belogo moria i v raione ostrova Morzhovets (A map atlas of ice conditions, pressure, and open areas in the northern part and in the neck of the White Sea and in the region of Morzhovets Island), 1932.
22. Burke, A. K. "O periodichnosti v ledovom rezhime" (Periodicity in the ice regime), Sovetskaia Arktika, No. 5: 86-88, 1936.
23. Burke, A. K. Morskie l'dy (Sea Ice). Leningrad, Izdatel'stvo Glavsevmorputi, 1940. 95 pp.
24. Butkevich, V. S. "Bakterial'noe naselenie arkticheskikh morei" (The bacteria population of arctic seas), Vysokoshirotnaia Ekspeditsiia na Sadko v 1935. Manuscript.
25. Veinberg, B. P. (Weinberg), V. Ia. Al'tberg, V. E. Arnol'd-Aliabev, and M. P. Golovkov. Led. Svoistva, vozniknovenie i ischeznovenie l'da (Ice. Properties, origin and disappearance of ice). Moscow, Gosudarstvennoe Izdatel'stvo Tekhniko-Teoreticheskoi Literatury, 1940.
26. Velikanov, M. A. Gidrologiia sushi (The hydrology of dry land), 1937.
27. Vize, V. Iu. "L'dy v Barentsovom more i temperatura vozdukh v Evrope" (Ice in the Berents Sea and air temperatures in Europe), Tsentral'noe Gidrometeorologicheskoe Biuro, Izvestiia, 3: 1-30, 1924.

28. Vize, V. Iu. "O poverkhnostnykh techeniakh v Karskom more" (Surface currents in the Kara Sea), Tsentral'noe Gidrometeorologicheskoe Biuro, Izvestiia, 3, 1924.
29. Vize, V. Iu. "Znachenie rezhima l'dov vesnoi v Grenlandskom more i vostochnogo Islandskogo tekhniia dlia temperatury vozdukh v posleduiuschiuzimu v Evrope" (The significance of the spring ice cycle in the Greenland Sea and in the east Icelandic current to the air temperature in Europe in the following year), Rossiiskii Gidrologicheskii Institut, Izvestiia, No. 14, 1925.
30. Vize, V. Iu. "K voprosu ob ostrovakh v severnoi chasti Karskogo moria" (The question of islands in the northern part of the Kara Sea), Issledovaniia Morei SSSR, No. 14, 1931.
31. Vize, V. Iu. "O dreife l'dov v Poliarnom basseine" (Ice drift in the Polar Basin), Gosudarstvennyi Gidrologicheskii Institut, Zapiski, 10: 327-336, 1933.
32. Vize, V. Iu. Moria Sovetskoi Arktiki (Soviet Arctic Seas). Moscow, Izdatel'stvo Glavsevmorputi, 1948, 413 pp. (Revised edition of 1939).
33. Vize, V. Iu. "Poteplenie Arktiki i prilivo-otlivy" (Tides and the warming of the Arctic), Problemy Arktiki, No. 5: 37-42, 1939.
34. Vize, V. Iu. Klimat morei Sovetskoi Arktiki (The climate of the Soviet arctic seas) Moscow, Izdatel'stvo Glavsevmorputi, 1940. 123 pp.
35. Vize, V. Iu. "O poteplenii klimata Poliarnogo basseina" (The warming of the climate of the polar basin), Problemy Arktiki, No. 4, 1941.
36. Voikov, A. and V. Stoliarov. "Zimnii gidrologicheskii rezhim bukhty Tiksi 1933-1934 gg" (The winter hydrological regime of Tiksi Bay, 1933-34), Glavnoe Upravlenie Severnogo Morskogo Puti, Gidrologicheskoe Upravlenie, Trudy.
37. Vrangel', F. P. Puteshestvie po severnym beregam Sibiri i po Ledovitomu moriu, sovershennoe v 1820, 1821, 1822, 1823 i 1824 gg., ekspeditsiiu, sostoiavsheiu pod nachal'stvom flota leitenanta Ferdinanda Fon-Vrangelia (Expedition along the north Siberian coast and in the Arctic Sea during the years 1820-1824, under command of navy lieutenant Ferdinand Von Vrangel'). St. Petersburg, A. Boridin Co., 1841.
38. Gakkel', Ia. Ia. and P. K. Khmyznikov. "Rezhim Chukotskogo moria po nabliudeniim vo vremia dreifa Cheliuskina i lageria Shmidta" (Conditions of the Chuckchee Sea from observations during the drift of the Cheliuskin and Camp Shmidt). Nauchnye Resul'taty Rabot Ekspeditsii na Cheliuskine i v Lagere Shmidta. Ed. by O. Iu. Shmidt and Ia. Ia. Gakkel', Moscow, Isdatel'stvo Glavsevmorputi, 1938. Vol 2, pp. 105-108.
39. Georgievskii. "Otchet o rabote gidrometeorologicheskoi stantsii na myse Shmidta za 1936-1937 gg" (Report of the work of the hydrometeorological station at Cape Shmidt for 1936-1937).
40. Golovkov, M. P. "K petrografii l'da Karskogo moria" (The petrography of ice in the Kara Sea), Vsesoiuznyi Arkticheskii Institut, Trudy, 60: 7-40, 1936.

41. Gordeev, V. "O chem govorit dreif karavana Sadko" (What the drift of the Sadko tells us), Sovetskaia Arktika, No. 2: 77-79, 1939.
42. Gordeev, V. "Ledianaia podushka Sedova" (The Sedov's ice cushion), Sovetskaia Arktika, No. 8: 54-56, 1940.
43. Guterman, I. G. Osobennosti stroenia atmosfery nad poliarnymi oblastiami (Peculiarities of atmospheric structure over polar regions). Leningrad, Izdatel'stvo Glavsevmorputi, 1938. 79 pp.
44. Deriugin Iu. and B. Bruns. "Sostav i Prochnost' l'da u mysa Zhelaniia" (Structure and strength of the ice at Cape Zhelania), Manuscript, 1937.
45. Dobrovolskii, A. D. "Vliianie glubinykh atlanticheskikh vod na rezhim Arkticheskogo basseina" (The effect of deep Atlantic waters on the cycle of the Arctic Basin), Doctoral Dissertation, 1941.
46. Drogaitsev, D. A. "Nekotorye obosnovaniia teplovogo vozdeistviia podstilaiushchei poverkhnosti na atmosferu" (Some principles of the warming effect of the underlying surface on the atmosphere), Problemy Arktiki, No. 2, 1941.
47. Zubov, N. N. "K voprosu o proiskhozhdenii promezhutochnogo kholodnogo sloia v poliarnykh vodakh" (The origin of the intermediate cold layer in polar waters), Morskoii Nauchnyi Institut, Trudy, 4(2): 45-68, 1929.
48. Zubov, N. N. "Plotnost' ili udel'nyi ob'em" (Density or specific volume), USSR, Gidrograficheskoe Upravlenie, Zapiski po Gidrografii, 58, 1929.
49. Zubov, N. N. "Srednie temperatury gidrologicheskikh razrezov po Kol'skomu meridianu i ledovitosti Barentsova moria" (Average temperatures of hydro-logical cross sections along the Kola meridian and the iciness of the Barents Sea), USSR, Gidrograficheskoe Upravlenie, Zapiski po Gidrografii, 59, 1930.
50. Zubov, N. N. "Vliianie otkloniaiushchei sily vrashcheniia Zemli na amplitudu prilivov in na skorosti prilivo-otlivnykh techenii" (The effect of the deflecting force of the earth's rotation on the amplitude of tides and the rate of tidal currents), USSR, Gidrograficheskoe Upravlenie, Zapiski po Gidrografii, 61, 1930.
51. Zubov, N. N. "K voprosu o vliianii otkloniaiushchei sily vrashcheniia Zemli na amplitudu prilivov i na skorosti prilivo-otlivnykh techenii" (The question of the effect of the deflecting force of the earth's rotation on the amplitude of tides and the rate of tidal currents), USSR, Gidrograficheskoe Upravlenie, Zapiski po Gidrografii, 63, 1930.
52. Zubov, N. N. Nekotorye svoistva morskogo l'da (Some properties of sea ice). 1932.
53. Zubov, N. N. "Gidrologicheskie raboty Morskogo nauchnogo instituta v iugozapadnoi chasti Barentsova moria letom 1928 g. na e/s Persei (Hydrological work of the Marine Scientific Institute in the southwestern part of the Barents Sea during the summer of 1928 on the expeditionary ship Persei), Gosudarstvennyi Okeanograficheskii Institut, Trudy, 2(4): 1-83, 1932.

54. Zubov, N. N. Elementarnoe uchenie o prolivakh v more (Elementary study of tides in the sea). 1933.
55. Zubov, N. N. "Nekotorye soobrazheniia o plavanii vo l'dakh Poliarnogo basseina" (Certain considerations on navigation in the ice of the Polar basin), USSR, Hidrograficheskoe Upravlenie, Zapiski po Hidrografii, No. 2, 1933.
56. Zubov, N. N. "K voprosu o dvizhenii l'dov pod vliianiem vetra" (The effect of wind on ice movement), Severnyi Morskoi Put', No. 1: 78-83, 1934.
57. Zubov, N. N. Dinamicheskii metod obrabotki okeanologicheskikh nabludeni (A dynamic method for processing oceanographic observations), 1935.
58. Zubov, N. N. "Problema dolgosrochnykh ledovykh prognozov" (The problem of long-range ice forecasts), Sovetskaiia Arktika, No. 1: 24-30, 1935.
59. Zubov, N. N. "Soobrazheniia o dvizhenii l'dov pod vliianiem vetra" (Wind effect on ice drift), Issledovaniia Morei SSSR, No. 21: 113-119, 1935.
60. Zubov, N. N. "Ob ustoichivosti sloev v more" (The stability of the layers in the sea), Meteorologiiia i Hidrologiiia, No. 8, 35-43, 1936.
61. Zubov, N. N. "O predel'noi tolshchine mnogoletnykh l'dov" (The maximum thickness of perennial ice), Meteorologiiia i Hidrologiiia, No. 4: 123-131, 1938.
62. Zubov, N. N. Morskie vody i l'dy (Sea water and ice). Moscow, Gidrometeoizdat, 1938. 451 pp.
63. Zubov, N. N. "O normal'noi tolshchine morskikh l'dov v raionakh ikh vynosa" (The normal thickness of broken coastal ice), Problemy Arktiki, No. 5: 43-45, 1939.
64. Zubov, N. N. "O dreife l/p Sedov, s 1 sentiabria 1938 g. po 1 fevralia 1939 g." (The drift of the icebreaker Sedov from 1 September 1938 through 1 February 1939), Severnyi Morskoi Put', No. 2: 45-51, 1939.
65. Zubov, N. N. "O pokazatele zamèrznaniia moria" (The freezing index of sea water), Problemy Arktiki, No. 4: 5-12, 1939.
66. Zubov, N. N. "O peredache temperaturnykh anomalii okeana na rastoianie" (The remote transmission of ocean temperature anomalies), Meteorologiiia i Hidrologiiia, No. 5: 69-63, 1939.
67. Zubov, N. N. and M. M. Somov. "Dreif l'da tsentral'noi chasti Poliarnogo basseina" (Ice drift in the central part of the Arctic Basin), Problemy Arktiki, No. 2: 51-68, 1940.
68. Zubov, N. N. "O skorosti taianii l'dev" (The rate of ice melting), Problemy Arktiki, No. 5: 13-18, 1940.
69. Zubov, N. N. "O pokazatele nespokoinosti atmosfery" (An indicator of atmospheric turbulence) Meteorologiiia i Hidrologiiia, No. 3, 1940.

70. Zubov, N. N. V tsentre Arktiki (In the center of the Arctic). Moscow Izdatel'stvo Glavsermorputi, 1940. 391 pp.
71. Zubov, N. N. and A. V. Everling. Moria zemnogo shara - Ukazatel' geograficheskikh nazvanii (Seas of the world - an index of geographical names). Volume 1, Bol'shoi Sovetskoi Atlas Morei.
72. Zubov, N. N. and K. S. Badigin. Nekotorye predvaritel'nye itogi nauchnykh rabot, provedennykh na ledokol'nom parokhode Sedov (Some preliminary summations of the scientific works conducted on the icebreaker Sedov). A supplement to K. S. Badigin's Na Korable G. Sedov cherez Severnyi Ledovityi Okean, Moscow, Izdatel'stvo Glavsevmorputi, 1940. 605 pp.
73. Zubov, N. N. and N. I. Chigirin. Okeanologicheskie tablitsy (Oceanographic tables). Leningrad, Gidrometeoizdat, 1940.
74. Zubov, N. N. "O vertikal'nykh dvizheniiakh l'dov v sviazi s izmeneniem ikh tolshchiny" (Vertical movements of ice with relation to a change in its thickness), Problemy Arktiki, No. 12: 42-50, 1940.
75. Zubov, N. N. and K. M. Sirotov. Okeanologicheskie grafiki (Oceanographic charts), 1941.
76. Zubov, N. N. Osnovy ustroistva dorog na ledianom pokrove (The fundamentals of road construction on the ice cover), 1942.
77. Zubov, N. N. Rukopisi (Manuscripts).
78. Itin, V. A. "Kolebaniia ledovitosti arkticheskikh morei SSSR" (Fluctuations of the ice conditions of the Soviet arctic seas), Sovetskaia Arktika, No. 1: 74-78, 1936.
79. Kalesnik, S. V. Ledniki, ikh rol' i znachenie v zhizni zemli (Glaciers, their role and significance in the life of the earth), 1936.
80. Kalitin, N. N. "Opyt izucheniia radiatsionnykh svoistv snegovogo pokrava" (An experiment in the study of the radiation characteristics of the snow cover), Glavnaia Geofizicheskaiia Observatoriia, Izvestiia, No. 1-2, 1932.
81. Kalitin, N. N. Aktinometriia (Actinometry). Leningrad, Gidrometeorologicheskoe Izdatel'stvo, 1938. 324 pp.
82. Kalitin, N. N. "Summarnaia radiatsiia v Arktike" (Total solar radiation in the Arctic), Problemy Arktiki, No. 1: 36-43, 1940.
83. Karelin, D. B. "Ledovyi pokrov poberszhiia Sovetskoi Arktiki" (The ice cover of the Soviet Arctic coast), Meteorologiya i Gidrologiya, No. 2: 43-50, 1937.
84. Karelin, D. B. "O sviazi vetra s gradientom davleniia arkticheskikh moriakh" (The relationship of the wind to the pressure gradient in the arctic seas), Problemy Arktiki, No. 2, 1941.
85. Karelin, D. B. "Ledovitost' Grenlandskogo moria" (The iciness of the Greenland Sea), Problemy Arktiki, No. 2, 1941.

86. Kireev, I. A. "Vetrovoi dreif 1/p Sedov pri plavanii v razrezhenom l'du" (The wind drift of the icebreaker Sedov while cruising through scattered ice), Severnyi Morskoi Put', No. 4: 5-35, 1936.
87. Kolesnikov, A. G. "O skorosti narastaniia l'da v more" (The rate of ice accretion in the sea), Problemy Arktiki, No. 9: 1926, 1940.
88. Kolchak, A. V. Led Karskogo i Sibirskogo morei (The ice of the Kara and Siberian Seas). St. Petersburg, Russkaia Poliarnaia Ekspeditsiia, 1900-1903 gg., 1909. 169 pp.
89. Komorovskii, A. N. "Struktura i fizicheskie svoistva ledianogo pokrova presnykh vod" (The structure and the physical characteristics of a fresh-water ice cover), 1932.
90. Korunov, M. M. "Raschet ledianykh pereprav" (Calculation of ice crossings), Avtobronetankovyi Zhurnal, No. 11: 62-67, 1940.
91. Kuz'min, P. P. "Staivanie lednikov i teplovoi balans" (The thawing of glaciers and the heat balance), Zhurnal Geofiziki, 7 (4): 272-283, 1937.
92. Kuz'min, P. P. "Teplootdacha moria v vozdukh putem konveksii" (The heat transmission of the sea to the air by convection), Meteorologiya i Gidrologiya, No. 2, 28-38, 1938.
93. Kuz'min, P. P. "Protsessy teploobmena, abliatsii i stoka s lednikov v basseine reki Zeravshana" (Heat exchange processes, ablation and run-off from glaciers in the Zeravshan River Basin). Doctoral Dissertation, 1941.
94. Lavrov, A. M. "Sostoiani l'da vostochnykh beregov Sval'barda (Iiun' i iiul', 1928)" (The state of the ice on the eastern shores of Svalbard), Nauchno-Issledovatel'skii Institut po Izucheniiu Severa, Trudy, No. 45: 56-81, 1929.
95. Laktionov, A. F. "O svoistvakh morskogo l'da" (The properties of sea ice), Nauchno-Issledovatel'skii Institut po Izucheniiu Severa, Trudy, No. 49: 71-96, 1931.
96. Laktionov, A. F. "Aisbergi v raione Severnoi Zemli" (Icebergs in the region of Severnaya Zemlya), Problemy Arktiki, No. 9: 92-94, 1940.
97. Lange, Iu. V. "O ponizhenii tochki zamerzaniia vody v kapilliarakh i o zavisimosti temperatury zamerzaniia vody ot diametra kapillara" (Lowering of the water freezing point in capillaries and its dependence on the diameter of the capillary), Pervyi Gidrologicheskii S'ezd, Trudy, 7-14 May, 1924.
98. Lebedev, I. "Vliianie rek na l'dy arkticheskikh morei" (Effect of rivers on ice of the arctic seas), Sovetskaia Arktika, No. 7: 95-97, 1938.
99. Lesgaft, E. "L'dy Karskogo moria i dostupnost' ego dlia soobshcheniia s Siber'iu" (Kara Sea ice and its accessibility for contact with Siberia), Zapiski po Gidrografii, 37: 161-260, 1913.
100. Lesgaft, E. "L'dy Severnogo Ledovitogo okeana i morskoi put' iz Evropy v Sibir'" (Ice of the Arctic Ocean and the sea route from Europe to Siberia). 1913.

101. Makarov, S. O. Ermak vo l'dakh; opisanie postroiki i plavanii ledokola Ermak i svod nauchnykh materialov, sobrannykh v plavanii (The Ermak in the ice fields; description of the construction and voyages of the icebreaker Ermak and a summary of scientific results from the voyages). St. Petersburg, Tipografiia Sanktpetersburgskogo aktsionnogo obshchestvo pechatnogo dela v Rosii E. Evdokimov, 1901. 507 pp.
102. Maksimov, I. V. (ed.). "Materialy k izucheniiu prilivov arkticheskikh morei SSSR" (Data for studying the tides of Soviet arctic seas), Vsesoiuznyi Arkticheskii Institut, Trudy, Vol. 36, Parts I and II, 1933.
103. Maksimov, G. S. "O mertvoi vode" (Stagnant water), Gosudarstvennyi Hidrologicheskii Institut, Izvestiia, No. 7, 1923.
104. Malmgren, Finn. "O svoistvakh morskogo l'da" (The properties of sea ice), from the Scientific Results of the Maud Expedition, 1918-1925, 1 (5), 1927.
105. Morozov, N. Rukovodstvo dlia plavanii vo l'dakh Belogo moria (Handbook for ice navigation in the White Sea). Petrograd, 1921. 69 pp.
106. Mul'tanovskii, B. P. "Zagadka Arktiki" (Enigma of the Arctic), Vsesoiuznoe Geograficheskoe Obshchestvo, Meteorologicheskii Vestnik, No. 1: 2-17, 1926.
107. Nansen, Fridtjof. "Sredi l'dov vo mrake poliarnoi nochi" (Amidst ice and darkness of the Polar night), From Die norwegische Polar expedition, 1893-1896. Leipzig, Brockhaus, 1897. (Translated from the German by A. A. Kruber).
108. Obolenskii, V. N. Osnovy meteorologii (Principles of meteorology). 1933.
109. Ovchinnikov, I. G. Ledovitost' Chukotskogo moria (Iciness of the Chuckchee Sea). Doctoral work, Moskovskii Hidrometeorologicheskii Institut, 1938.
110. Ostrovskii, B. G. Beloe Moria (The White Sea). 1937.
111. Palibin, M. A. "Mikroorganizmy kak razrushiteli poliarnykh l'dov" (Microorganisms as destroyers of polar ice), Tsentral'noe Hidro-Meteorologicheskoe Biuro, Izvestiia, Vol. 5, 1925.
112. Papanin, I., E. Krenkel', P. Shirshov and E. Fedorov. "Nauchnye raboty na dreifuishchei l'dine" (Scientific work on a drifting floe), Sovetskaia Arktika, No. 12, 1937.
113. Pinegin, V. A. "Predvaritel'noe soobshchenie ob issledovanii prochnosti rechnogo l'da v sviazi s temperaturnymi izmeneniami" (A preliminary report on the investigation of the durability of river ice in relation to temperature changes), Soobshchenie o nauchno-tekhnicheskikh rabotakh v Respublike, 1924.
114. Pinegin, V. A. "Ob izmenenii modulia uprugosti i koeffitsienta Puassona u rechnogo l'da pri szhatii" (Changes in the elasticity modulus and Poisson's coefficient in river ice during compression), Nauka i Tekhnika, No. 3-4, 1927.
115. Piotrovich, V. V. "Kratkie rezul'taty gidrofizicheskikh nabliudeni na ledokole Krasin" (A short description of hydrophysical observations on the icebreaker Krasin), Nauchnye raboty ekspeditsii na ledokole Krasin v 1935, pp. 99-111, 1936.

116. Poliakov, B. V. "Gidrologicheskie issledovaniia Nizhnei Volgi" (Hydrological investigations of the Lower Volga), 1938.
117. Ratmanov, G. E. "Gidrologicheskie raboty ledokola Krasin v 1935" (Hydrological work of the icebreaker Krasin in 1935), Nauchnye raboty ekspeditsii na ledokole Krasin v 1935, pp. 19-58, 1936.
118. Ratmanov, G. E. "K gidrologii Beringova i Chukotskogo morei" (Hydrology of the Bering and Chuckchee Seas), Issledovaniia Morei SSSR, No. 25: 10-118, 1937.
- Zubov lists this as part of Trudy Ekspeditsii na "Krasine" 1935. We have not been able to confirm this (Tr. note).
119. Sviatskii, D. S. "Kolebaniia klimata" (Climate variations), Mirovedenie, No. 4, 1926.
120. Scoresby, V. Podemnye zapiski o plavanii na severnyi kitovyi promysel (A daily log of a trip to the northern whaling grounds). Translated from the English. 1825.
121. Sovetov, S. A. Obshchaia gidrologiia (General Hydrology). 1935.
122. Somov, M. M. "O postroenni skhemy dreifa l'dov v poliarnom basseine" (The elaboration of a scheme of the ice drifts in the Polar Basin), Problemy Arktiki, No. 5: 25-32, 1939.
123. Somov, M. M. "K voprosu o srednei tolshchine l'da okrainnykh moriakh" (The mean thickness of the ice in peripheral seas), Problemy Arktiki, No. 6: 11-20, 1939.
124. Somov, M. M. "K teplovomu rezhimu Nordkapskogo techeniia" (The warm cycle of the Nordkapp current), Meteorologiia i Gidrologiia, No. 2, 112-120, 1938.
125. Somov, M. M. "O vliianii atlanticheskikh vod na ledovyi rezhim Karskogo moria" (The effect of Atlantic waters on the ice cycle in the Kara Sea), Problemy Arktiki, No. 3, 1941.
126. Storozhev, N. M. "Dreif l'dov v more Laptevykh pod vlianiem prilivootlivnykh iavlenii" (Ice drift in the Laptev Sea under the influence of tides), Problemy Arktiki, No. 3: 69-83, 1940.
127. Struiskii, N. N. "Sviaz' mezhdru deistvuiushchim vetrom i poverkhnostnym techeniem" (The relation between the acting wind and surface current), USSR. Gidrograficheskoe Upravlenie, Zapiski po Gidrologiia, Vol. 63, 1930.
128. Tanfil'ev, G. I. Moria: Kaspiiskoe, Chernoe, Baltiiskoe, Ledovitoe, Sibirskoe i Vostochnyi okean. Istoriia issledovaniia, morfometriia, gidrologiia, biologii (The Caspian, Black, Baltic, Arctic, Siberian Seas and the Pacific Ocean. The history of exploration, morphology, hydrology and biology). Moscow, Glavnauka NKP RSFSR, 1931. 246 pp.
129. Timonov, V. E. Primechaniia k russkomu perevodu "Ledotekhnika" Barnes (Remarks on the Russian Translation of Barnes' "Ice Engineering"), 1934.
130. Trofimov, A. V. "Podlednaia i podvodnaia osveshchennost' v verkhnykh gorizontakh moriakh" (Under-ice and under-water illumination in the upper levels of the sea), Zhurnal Geofiziki, 4(17): 444-465, 1935.

131. Fakidov, I. "Kolebaniia ledovogo pokrova" (Vibrations of the ice-cap of Polar seas), Nature, 134(3388): 536-537, 1934. (Letters to the Editor).
132. Fritsman, E. Kh. "Priroda vody i tiazhelaiia voda" (The nature of water and heavy water), 1935.
133. Khmyznikov, P. K. "Nekotorye dannye o zimnem rezhime v 1927-1928 prolivov arkhipelaga Novosibirskikh ostrovov i Ianskogo zaliva" (Conditions during the 1927-1928 winter in the straits of the New Siberian Islands and Yana Bay), Issledovaniia Morei, SSSR, No. 15: 33-62, 1932.
134. Khmyznikov, P. K. "Arkhipelaga Novosibirskikh ostrovov" (Archipelago of the New Siberian Islands), in Materialy k lotsii moria Laptevykh i Vostochnosibirskogo moria, Leningrad, Izdatel'stvo Glavsevmorputi, 1937.
135. Khromov, S. P. Vvedenie v sinopticheskii analiz (An introduction to synoptical analysis), 1937.
136. Tsurikov, V. L. "K voprosu o prochnosti l'da" (The question of the strength of ice), Severnyi morskoi put', No. 16: 45-74, 1940.
137. Chernigovskii, N. T. "O radiatsionnykh svoistvakh snegovogo pokrova i l'da arkticheskikh morei" (Radiation penetrating the snow and ice cover of the arctic seas), Problemy Arktiki, No. 6: 31-38, 1939.
138. Chernigovskii, N. T. "Opyt opredeleniia radiatsionnogo balansa Karskogo moria" (Experimental calculations of radiation of the Kara Sea), Problemy Arktiki, No. 3: 92-97, 1940.
139. Chigirin, N. I. "Sistema ugol'noi kisloty v vodakh severnago Poliarnogo basseina i Grenland-skogo moria" (Carbon dioxide of the Polar Basin and the Greenland Sea), Vysokoshirotnaia ekspeditsiia na Sadko, 1935 g., Trudy, 1(1): 197-274, 1940.
140. Shaffernak, F. Gidrologiia (Hydrology). Translated from the German, 1938.
141. Shenrok, A. M. "K voprosu ob obrazovanii donnogo l'da" (The problem of anchor ice formation), Gosudarstvennyi Gidrologicheskii Institut, Izvestiia, No. 64: 57-58, 1934.
142. Shepelevskii, A. A. "O raspredelenii i izmenenii s techeniem vremeni plotnosti v snegovom pokrove" (The distribution and gradual changes of the density in the snow cover), Vsesoiuznyi Arkticheskii Institut, Trudy, 110: 15-31, 1938.
143. Shokal'skii, Iu. M. Okeanografiia (Oceanography), 1917.
144. Shokal'skii, Iu. M. "O rezul'tatakh sovokupnosti rabot v severnykh vodakh Sovetskogo Soiuz a ikh blizhaishikh zadachakh a takzhe o rabotakh Sovetskogo Soiuz po vtoromu mezhdunarodnomu poliarnomu godu" (The general results of work done in the northern waters of the Soviet Union, future tasks, and the work of the Soviet Union in the Second International Polar Year), Vsesoiuznoe Geograficheskoe Obschestvo, Izvestiia, 71(10): 1448-1465, 1939.
145. Arnol'd-Aliabev, V. I. "The external friction of ice", International Geodetic and Geophysical Union. Association of Scientific Hydrology, Bulletin, 23: 563-570, 1936.

146. Brooks, C. F. "The ice sheet of Central Greenland", Geographical Review, 13: 445-453, 1923.
147. Brooks, C. E. P. and Winifred A. Quennel. "The influence of Arctic ice on the subsequent distribution of pressure over the eastern North Atlantic and western Europe", Great Britain Meteorological Office, Geophysical Memoirs, No. 41, 1928. 36 pp.
148. Clayton, H. H. World Weather. New York, The MacMillan Company, 1923. 393 pp.
149. Le Danois, E. "Les transgressions océaniques" (Ocean crossings), Office Scientifique et Technique de Pêches Maritimes. Revue des Travaux, Vol. 7, No. 4, 1934.
150. "The state of the ice in the arctic seas", Det Danske Meteorologisk Institut.
151. Drygalskii, E. "Grönlands Gletcher und Inlandeis" (Greenland's glaciers and inland ice), Gesellschaft für Erdkunde zu Berlin, Zeitschrift, pp. 1-62, 1892.
- 151a. Evjen, S. "Barometerschwingungen und langfristige Prognosen" (Pressure variations and long-range forecasts), Geofysiske Publikasjoner, 4(1): 1-14, 1927.
152. Ewing, Maurice, A. P. Crary and A. M. Thorne, Jr. "Propagation of elastic waves in ice", Part I, Physics, No. 5: 165-168, 1934.
153. Helland-Hansen, B. The ocean waters, Internationale Revue der gesamten Hydrobiologie und Hydrographie, 3, Hydrographisches Supplement, No. 1, 1910-12.
154. Helland-Hansen, B. "Einige hydrographische Methoden" (Some hydrographic methods), Skandinaviske Naturforskeres Mode, No. 16, Christiania, 1916. 903 pp.
155. Hesselberg, T. and H. U. Sverdrup. "Die Stabilitätsverhältnisse des Seewassers bei vertikalen Verschiebungen" (The stability ratios of sea water during vertical displacements), Bergens Museums Aarbok, No. 15, 1914/15. 16 pp.
156. Hesselberg, T. "Über das Verhältnis zwischen Druckkraft und Wind" (The relationship between pressure and wind), Geofysiske Publikasjoner, 9(8), 1-35, 1932.
157. Knudsen, M. Hydrographische Tabellen, (Hydrographic tables). Copenhagen, 1901.
158. Krummel, O. Handbuch der Ozeanographie (Handbook of Oceanography). Vol. 1, 1907. Volume 2, 1911.
159. Lallemand, C. H. and E. Prevot. "Variations lentes du niveau moyen de la mer sur le littoral français" (Slow variations of the average water level on the coast of France), Academie des Sciences, Comptes Rendus, 188(22): 1345-1348, 1929.
160. Mecking, Ludwig. "Die Treibeiserscheinungen bei Neufundland in ihrer Abhängigkeit von Witterungsverhältnissen" (Drift ice phenomena near Newfoundland and their dependence on weather conditions), Annalen der Hydrographie und maritimen Meteorologie, 35: 348-355, 396-409, 1907.

161. Meinardus, Wilhelm. "Periodische Schwankungen der Eistrift bei Island" (Periodic variations of ice drift near Iceland), Annalen der Hydrographie und maritimen Meteorologie, 35: 148-162, 227-239, 278-285, 1906.
162. Meinardus, W. "Über Schwankungen der nordatlantischen Zirkulation und damit zusammenhängende Erscheinungen" (Variations of the circulation in the North Atlantic and related phenomena), Meteorologische Zeitschrift, 22(9): 398-412, 1905.
163. Memery, H. "Les variations solaires font prévoir des hivers froids en 1929 et en 1930" (The solar variations which forecasted the cold winters of 1929 and 1930), Talence, France. Observatoire, Bulletin, Ser. 2, No. 4, 1928.
164. Nansen, F. "The Oceanography of the north Polar basin", Scientific Results of the Norwegian North Polar Expedition, 1893-1896, 3(9), 1902.
165. Nansen, F. "The oceanographic problems of the still unknown arctic regions", American Geographical Society, Problems of Polar Research, pp. 2-14, 1928.
166. Pettersson, Sven Otto. "The properties of water and ice", Nordenskjöld, N. A. E. Vega-ekspeditionens vetenskapliga iakttagelser, 2: 247-323, 1883.
167. Pettersson, Sven Otto. "Changes in the oceanic circulation and their climatic consequences", American Geographical Society, Geographical Review, No. 1, 1929.
168. Ringer, W. E. "Über die Veränderungen in der Zusammensetzung des Meereswassersalzes beim Ausfrieren" (Changes in the composition of sea-water salt during freezing), (Text in German), Conseil permanent intern. exploration mer, Rapp. 47: 226-231, 1928.
169. Royen, N. "Istryck vid temperaturhöjningar" (Ice pressure with increasing temperatures), Hyllningsskrift tillägnad F. Vilh. Nansen, Stockholm, Gunnar Tisells Tekniska Forlag, 1922. pp. 357-371.
170. Scherhag, R. "Die Zunahme der atmosphärischen Zirkulation in den letzten 25 Jahren" (The increase of atmospheric circulation during the last 25 years), Annalen der Hydrographie und maritimen Meteorologie, 64(9): 397-407, 1936.
171. Smith, Edward H. "Arctic ice with especial reference to its distribution to the North Atlantic Ocean". U. S. Coast Guard, The Marion Expedition to Davis Strait and Baffin Bay, 1928, No. 19, part 3, 1931.
172. Stefan, J. "Über die Theorie der Eisbildung insbesondere über die Eisbildung im Polar-meere" (The theory of ice formation, especially in the Polar seas), Annalen der Physik, 42: 269-286, 1891.
173. Sverdrup, H. U. "The wind drift of the ice on the North Siberian Shelf", Scientific Results of the Maud Expedition, 1918-1925, Vol. 4, No. 1, Bergen, John Grieg, 1928.
174. Sverdrup, H. U. "Die Eistrift im Weddellmeer" (The ice drift in the Weddell Sea), Annalen der Hydrographie und maritimen Meteorologie, 56(9): 87-89, 1928.
175. Sverdrup, H. U. The Norwegian North Polar Expedition with the Maud, Meteorology, 1, 1933.

176. Sverdrup, H. U. "On the evaporation from the oceans", Journal of Marine Research, 1(1): 3-14, 1937-38.
177. Wayprecht, K. "Die Metamorphosen des Polareises" (The metamorphoses of polar ice), Austro-Hungarian Arctic Expedition of 1872-74, 1879.
178. Whitman, W. G. "The elimination of salt from sea-water ice", American Journal of Science, Series 5, 11(2): 126-132, 1926.
179. Wright, C. S. and R. E. Priestly. Glaciology, London, British Antarctic Expedition 1910-1913, Harrison and Sons, 1922. 581 pp.

