



# **Fisheries Centre Research Reports**

---

*2001    Volume 9    Number 4*

## **Fisheries Impacts on North Atlantic Ecosystems: Models and Analyses**

---

**Fisheries Centre, University of British  
Columbia, Canada**

ISSN 1198-6727

**Fisheries Impacts on  
North Atlantic  
Ecosystems:  
Models and Analyses**

*Fisheries Centre Research  
Reports*

*2001 Volume 9 Number 4*

*edited by*

*Sylvie Guénette,*

*Villy Christensen*

*&*

*Daniel Pauly*

*published by*

*The Fisheries Centre, University of British Columbia*

*2204 Main Mall*

*Vancouver, B.C., Canada*

*ISSN 1198-6727*



## Director's Foreword

---

Who would have thought that every single one of the major international agencies set up with such hope in the 1950s and 1960s to manage fisheries on North Atlantic fish populations would have been found, by 2000, to have totally failed in their mandate? This series of reports<sup>1</sup>, presenting the output of the first two-year phase of the *Sea Around Us* project (SAUP), makes a detailed and solid case for this spectacular and depressing failure.

Two questions immediately arise. Why did this happen? What can we do in future?

A search for causes raises many further questions. Were stock assessments misleading? Or did they miss the big picture by ignoring ecosystem effects? Were unreported catches large enough to cause declines invisible to conventional stock assessment? Was the ability of fish population age structure to buffer climate fluctuations ignored? Did political pressure cause quotas approved by scientists to be raised? Was industry locked into serial depletion by area, species and habitat? Was industry driven by a perverse economic investment ratchet? Was industry seduced by subsidies that turned money-losing fisheries into money-makers? It is quite likely that all of the above apply and the work reported here addresses many of these questions.

The Fisheries Centre at the University of British Columbia supports research that first clarifies, and then finds ways to mitigate, the impacts of fisheries on aquatic ecosystems. Only with such insight of how whole aquatic ecosystems function can management policies aim to reconcile the extraction of living resources for food with the conservation of biodiversity, with the maintenance of ecosystem services, with amenity and with other multiple uses of aquatic ecosystems. Indeed, the present dire state of marine ecosystems and their fisheries around the globe signals a pressing need for what may be termed the 'ecosystem imperative'.

Although ecosystem agendas of this kind has recently become embodied in the legislative goals of many nations, and are an integral part of the *FAO Code of Conduct for Responsible Fisheries*, in practice there have been few attempts to work out how it might actually be done. In sponsoring the SAUP, the Pew Charitable Trusts<sup>2</sup> of Philadelphia, USA, have devoted a significant amount of support to an ambitious pilot project focused on the North Atlantic that aims to address this question.

The research team<sup>3</sup> of senior scientists, postdoctoral research assistants, graduate students, consultants and support staff commenced work in late 1999.

This first two-year phase has focused on the fisheries and ecosystems of the North Atlantic. Members of the team have been excited and challenged by the unprecedented scope of the research work. Most of the methods used to tackle the problem are new<sup>4</sup>, and many of the measures developed by the team have been translated into a revolutionary new mapping system. In addition a book for the general public is being published<sup>5</sup>.

These reports are the latest in a series of *Fisheries Centre Research Reports* published by the UBC Fisheries Centre. A full list is shown on our web site at [www.fisheries.ubc.ca](http://www.fisheries.ubc.ca), and the series is fully abstracted in the *Aquatic Sciences and Fisheries Abstracts (ASFA)*. The research report series aims to focus on broad multidisciplinary problems in fisheries management, to provide a synoptic overview of the foundations and themes of current research, to report on research work-in-progress, and to identify the next steps and ways that research may be improved. *Fisheries Centre Research Reports* are available on request for a modest cost-recovery charge. Please contact the Fisheries Centre by mail, fax or e-mail to 'office@fisheries.ubc.ca'.

**Tony J. Pitcher**

*Professor of Fisheries*

*Director, UBC Fisheries Centre*

---

1 Zeller, D., Watson, R. and Pauly, D. (eds.) (2001) *Fisheries Impacts on North Atlantic Ecosystems: Catch, Effort and National/Regional Data Sets*. Fisheries Centre Research Reports 9 (3): 254 pp.

Gu nette, S., Christensen, V. and Pauly, D. (eds.) (2001) *Fisheries Impacts on North Atlantic Ecosystems: Models and Analyses*. Fisheries Centre Research Reports 9 (4): 344 pp.

Pitcher, T.J., Sumaila, R. and Pauly, D. (eds) (2001) *Fisheries Impacts on North Atlantic Ecosystems: Evaluations and Policy Exploration*. Fisheries Centre Research Reports 9 (5): 94 pp.

2 The *Sea Around Us* project is a Fisheries Centre partnership with the Pew Charitable Trusts of Philadelphia, USA. The Trusts support non-profit activities in the areas of culture, education, the environment, health and human services, public policy and religion. Based in Philadelphia, the Trusts make strategic investments to help organizations and citizens develop practical solutions to difficult problems.

3 A list of SAUP team members may be found in Annex 1 of Zeller *et al.* (2001).

4 Pauly, D. and Pitcher T.J. (eds) (2000) *Methods for assessing the impact of fisheries on marine ecosystems of the North Atlantic*. Fisheries Centre Research Reports 8(2): 195pp.

5 *In a Perfect Ocean*. D. Pauly and J. Maclean. Island Press. (in press).

## Preface and Acknowledgement

---

The present report is the second part of the scientific output of the first phase of the Sea Around Us Project<sup>1</sup> targeting the North Atlantic. This project was initiated and is funded by the Pew Charitable Trusts, Philadelphia, USA, and designed to investigate the impacts of fishing on marine ecosystems. To this aim, the project collected and analysed catch data and ecosystem information, and has developed a suite of analytical tools during its early phase, including ecosystem models<sup>2</sup>. This task has been undertaken in collaboration with a global network of scientists providing data, expertise and peer review<sup>3</sup>. An important feature of the approaches and methods used to produce these results is that they do not compete with the elaborate single-species methodology traditionally used in fisheries management. Thus, we are able to build on the findings of fisheries science, and to complement traditional approaches.

The following report, available as electronic PDF file, free of charge from our web-site ([www.fisheries.ubc.ca](http://www.fisheries.ubc.ca)), contains three sections:

1. The first section, on biomass trends, presents a synthesis of 23 mass-balance (Ecopath) models for the period from 1880 to the 1990s (with emphasis on the second part of the 20<sup>th</sup> century), explains the methodology used to construct and validate models based on ancient data sets, and illustrates this with a model of the North Sea in the 1880s;
2. The second section presents models describing ecosystems of the Western Atlantic: Lancaster Sound, West Greenland, the Gulf of Maine, as well as the Middle Atlantic and the southern coasts of the United States. The Gulf of Maine and the Lancaster Sound models represent the mid 1980s, the others the late 1990s.
3. The third section presents models of Icelandic waters (at two time periods, 1950 and 1997), the Faroe Islands and ICES area Vb (late 1990s), the Azores Archipelago (late 1990s), the Bay of Biscay, France (1970 and 1997), and the Atlantic coast of Morocco (mid-980s).

We thank the Pew Charitable Trusts for the ongoing support of the Sea Around Us project, and the project team for their dedication. We would also like to thank all the external collaborators and colleagues for their willingness to work with us, and for their efforts in constructing the models and providing useful data in a timely manner.

**Sylvie Gu nette, Villy Christensen and Daniel Pauly**

---

<sup>1</sup> The other reports on the output of the Sea Around Us Project cover the catch data, and policy evaluation (see Foreword).

<sup>2</sup> See Pauly, D. and Pitcher, T. 2000. Methods for Evaluating the Impacts of Fisheries on North Atlantic Ecosystems. Fisheries Centre Research Reports 8 (2), 195pp.

<sup>3</sup> See Annex 1 of Zeller *et al.* (2001).

## TABLE OF CONTENTS

DIRECTOR'S FOREWORD	i
PREFACE AND ACKNOWLEDGEMENTS	ii
TABLE OF CONTENTS	iii
<b>PART 1. ANALYSIS OF BIOMASS TRENDS</b>	
Estimating fish abundance of the North Atlantic, 1950 to 1999 <i>Villy Christensen, Sylvie Gu�nette, Johanna J. Heymans, Carl J. Walters, Reg Watson, Dirk Zeller and Daniel Pauly</i>	1
Ecosystems of the past: how can we know since we weren't there? <i>Villy Christensen</i>	26
Representing trophic interactions in the North Sea in the 1880s, using the Ecopath mass-balance approach <i>Steve Mackinson</i>	35
<b>PART 2. NORTHWEST ATLANTIC</b>	
A model of the Lancaster Sound Region in the 1980s <i>Elisabeth Mohammed</i>	99
Multispecies interactions in the West Greenland marine ecosystem: importance of the shrimp fisheries. <i>S�ren Pedersen and Dirk Zeller</i>	111
The Gulf of Maine, 1977-1986 <i>Johanna J. Heymans</i>	128
A 'straw-man' Ecopath model of the Middle Atlantic Bight continental shelf, United States <i>Thomas A. Okey</i>	151
A preliminary Ecopath model of the Atlantic continental shelf adjacent to the southeastern United States <i>Thomas A. Okey and Roger Pugliese</i>	167
<b>PART 3. NORTHEAST ATLANTIC</b>	
Constructing the Icelandic marine ecosystem model for 1997 using a mass balance modeling approach. <i>Asberr Natoumby Mendy and Eny Buchary</i>	182
Preliminary reconstruction of the Icelandic marine ecosystem in 1950 <i>Eny Buchary</i>	198
A preliminary North-east Atlantic marine ecosystem model: Faeroe Islands and ICES area Vb. <i>Dirk Zeller and Katia Freire</i>	207
Ecosystem model of the Norwegian and Barents Seas. <i>Are Dommasnes, Villy Christensen, Bj�rnar Ellertsen, Cecilie Kvamme, Webj�rn Melle, Leif N�ttestad, Torstein Pedersen, Sigurd Tjelmeland and Dirk Zeller</i>	213
The Azores Archipelago in 1997 <i>Sylvie Gu�nette and Telmo Morato</i>	241
The Bay of Biscay, France; 1998 and 1970 models <i>Cameron Ainsworth, Bridget Ferriss, Emily Leblond and Sylvie Gu�nette</i>	271
A preliminary, model of the Atlantic coast of Morocco for the mid-1980s <i>Richard Stanford, Kristin Lunn and Sylvie Gu�nette</i>	314



## ***PART I: ANALYSIS OF BIOMASS TRENDS***

---

### **ESTIMATING FISH ABUNDANCE OF THE NORTH ATLANTIC, 1950 TO 1999**

***Villy Christensen<sup>1</sup>, Sylvie Gu nette,  
Johanna J. Heymans, Carl J. Walters, Reg  
Watson, Dirk Zeller and Daniel Pauly***

<sup>1</sup> Fisheries Centre, University of British Columbia,  
2204 Main Mall, Vancouver, BC, Canada, V6T 1Z4  
e-mail: v.christensen@fisheries.ubc.ca

#### **ABSTRACT**

We estimate the biomass of high trophic-level fish in the North Atlantic at a spatial scale of 1/2 degree latitude by 1/2 degree longitude over the time period from 1950 to 1999, based on 23 spatialized, ecosystem models, each constructed to represent a given year or short period from 1880 to 1998. We extract over 7800 data points that describe the abundance of high trophic-level fishes as a function of year, primary production, depth, temperature, latitude, ice cover, and catch composition. We then use a multiple linear regression to predict the spatial abundance for all North Atlantic spatial cells for each year from 1950 to 1999. The results indicate that the biomass of high trophic-level fishes has declined by two-thirds during the fifty-year period. Catches increased from 2.4 to 4.7 million tonnes annually in the late 1960s, and subsequently declined to below 2 million tonnes annually in the late 1990s. The fishing intensity for high trophic-level fishes tripled during the first half of the time period, and remained high during the last half of the time period. We estimate that the high trophic-level species contributed 53% to the value of total fish landings in 1950, and that this declined to 29% by the end of the century. Comparing the fishing intensity to similar measures from 35 assessments of high trophic-level fish populations from the North Atlantic, we conclude that the trends in the two data series are similar. Our results raise serious concern for the future of the North Atlantic as a diverse, healthy ecosystem; we may soon be left with only low trophic-level species in the sea.

*“You see something and then you try everything you can think of to make it go away; you turn it upside down and inside out, and push on it from every possible angle. If it’s still there, maybe you’ve got something”*

*K.C. Cole (1998, p.96)*

#### **INTRODUCTION**

How is the world doing today? We often tend to stick to *Terra firma* when reflecting on this question, but the oceans have a role to play as well. We know that global climate is closely linked to the oceans circulation patterns, and that the oceans serve as a major food source, two roles too important to jeopardize. In that connection, it has been comforting to hear, as we have for decades, that the food supply from the oceans keeps increasing, but that comfort is beginning to erode with reports that the global catches have been decreasing for the last decade (Watson and Pauly, 2001). We hear of a fisheries crisis in the North Sea, in Northeastern Canada, actually we have heard of fisheries crises about everywhere regularly for the last couple of decades. What is happening to the fish in the ocean?

We have to be concerned for several reasons, with food supply being a major factor. But, our concern goes beyond this: we have seen drastic changes in ecosystem structure in a number of marine systems, a notable example being the Black Sea (Daskalov, 2002), and there is fear that ecosystems may change to alternate stable states if severely disturbed. We have also seen repeatedly that once fish populations’ collapse, it may take decades for them to rebuild, perhaps because depensatory effects may lead to such changes in ecosystem states (Walters and Kitchell, 2001).

To minimize the risk of adversely impacting the oceans, we should seek to maintain healthy ecosystems, a notion that is already widely incorporated in many countries’ laws and policy directives, (e.g., Canada’s Ocean Act, U.S.’ Stevens-Magnussons Act, and the E.U. Common Fishery Policy), as well as in the UN Convention on the Law of the Sea, where nations have accepted a mutual obligation to consider the impact of their policies on marine ecosystems; to take all appropriate actions to preserve the marine environment; and to manage ecosystem resources based on the interdependence of the system components. An important part of this is to maintain sufficient stock sizes at all trophic levels as a safety margin, avoiding the process of fishing down the food web, where predatory species are gradually eliminated (Pauly *et al.*, 1998), since the hope that we may be able to replace the predators in the sea is unfounded (Christensen, 1996). Perhaps we should make comparisons to stock portfolio theory: a safe portfolio is diversified, hedging a bet on many different sectors. Our living marine resources should be managed in a similar way if we are to

see but short-term gain and long-term loss; mining is not a viable option for managing living resources.

How much fish is there then in the sea? This is a crucial question for management of individual stocks in individual areas, and in that context a question for which we have at hand a suite of approaches for addressing it. Our interest in the present study is, however, wider: we are asking the question with regard to all species in a large area: How much fish is there in the North Atlantic?

Even before embarking on an attempt to quantify the total fish biomass, we know that whatever answer we may produce will be fairly uncertain. However, just as is the case for stock assessments, the biomass of fish in itself is not of real importance; what is relevant is how the biomass of fish has changed over time. Recognizing this *a priori*, we refine the question: How has the biomass of fish in the North Atlantic changed over the last fifty years?

We will examine a time period stretching half a century – partly because we cannot expect to see any clear trends if the time period is too brief, and partly because the fifty year period will cover the period following the relative peace (for the fish) of the Second World War up through a period with strong industrialization and expansion of the North Atlantic fisheries, and onwards to the years of fisheries collapses that have characterized the end of the 20<sup>th</sup> Century across the North Atlantic.

Estimating basin-level abundance of fish is a novel idea, as fisheries science has so far always worked on smaller scales (Pauly and Pitcher, 2000), and we are not familiar with any previous attempts we could use for guidance. Fisheries science does not have much tradition of addressing questions at such level, at least not questions that go beyond the amount of catches that may be extracted from the oceans (Pauly, 1996). In recent years, however, we have seen more interest in reconstructing prior states of ecosystems (an early example of this is given in Christensen and Pauly, 1998), and find it important to look beyond our own time horizon when evaluating the state of the oceans (Pauly, 1995).

In seeking to estimate total fish abundance, we may take two different routes. One is a bottom-up approach, where we would attempt to estimate the abundance of the individual species and sum these abundances up to the North Atlantic level. Such an approach is, however, not likely to

succeed; for one, we only have abundance estimates for a few populations of fish, and the chance of actually going out and measuring how much fish there is in the sea is a formidable task, beyond the capacity of any research group. Instead, we adopt a modeling approach, where we use a number of spatial ecosystem models to quantify how much life there is in the area and at the point in time characterized by each model. We then use the physical and biological properties of the ½ degree latitude by ½ degree longitude grid cells in the area covered by the individual models in a multiple linear regression to search for patterns that may predict how abundance is distributed over space and time.

In order to estimate the abundance of fishes in the North Atlantic, it is necessary to adopt a suitable level of aggregation, the species level being too detailed. One option is to summarize the abundance of fishes by trophic level. We know the average trophic level for each group from either diet composition studies, (e.g., through FishBase) or from ecosystem models, (e.g., Ecopath), and the models tell us how individual groups are distributed between trophic levels. Hence, it becomes feasible to estimate the abundance of fish at, e.g., trophic level 4. However, we do not have much knowledge about the fish abundances at the lower trophic levels, e.g., for the forage fishes. This reflects the fact that forage fishes have been of little interest historically, and that the sampling methods in general use are unable to sample small fishes reliably.

Indications about historic abundances of, e.g., menhaden in Chesapeake Bay, points to the sea being full of forage fish, while some studies indicate that the abundance of forage fishes may have increased in recent time, due to cascading effects caused by decreasing predator abundance as a result of human exploitation, e.g., for capelin in the Newfoundland area, (Carscadden *et al.*, 2001), and for small pelagics in the Black Sea, (Daskalov, 2002). However the evidence for cascading in marine ecosystems is inconclusive (Pace *et al.*, 1999; Pinnegar *et al.*, 2000), and while the jury is out, we avoid the controversy by not dealing here with the lower trophic levels.

Thus, in this study, we focus our attention on high trophic-level fishes, and emphasize that this focus reflects the understanding that these organisms serve as indicator species for the health status of marine ecosystems. The pattern emerging from studying human impact on a variety of system shows repeatedly that the top predators are the first to go when fishing turns intensive – be it



groupers on a coral reef, bluefin tuna in the Gulf of Maine, or Atlantic cod in the Barents Sea.

As tools of analysis for assessing the biomass of fish in the North Atlantic, we have constructed a series of ecosystem models of North Atlantic ecosystems as part of the *Sea Around Us* project (SAUP), and use these together with published models from various areas in the North Atlantic to obtain a wide spatial and temporal coverage. The models have varying levels of spatial coverage and details. This paper provides an outline for how such a strategy has been implemented to address basin-level questions, and presents results from the data extraction that has been conducted, based on these models.

## METHODOLOGY

The methodology we have used to predict the biomass of fish in the North Atlantic relies on a combination of ecosystem modeling, information from hydrographic databases, statistical analysis, and GIS modeling. A flowchart for this approach is presented in Figure 1 to guide further reading.

### Ecosystem models from the North Atlantic

The available information about biomasses at the ecosystem level is very incomplete, making it necessary to rely on modeling to obtain a coherent picture of the distribution and abundances of fish in the North Atlantic. We can base the modeling on the array of information that is available at the population level, mainly due to stock assessments made as part of the regulatory process. In addition, we have information from research surveys (which serve as a major information-provider for the assessments) as well as from biological oceanographic studies. A major part of the biological and ecological information required for construction of the ecosystem models is available from the FishBase database, available online at [www.fishbase.org](http://www.fishbase.org). The aim of the modeling efforts is to combine such information to derive a realistic picture of biomasses and their interaction in a series of ecosystems throughout the North Atlantic.

In the present study we rely on ecosystem models constructed using the widely distributed Ecopath with Ecosim (EwE) approach and software, for which Christensen and Walters (2000) and Pauly *et al.* (2000) give overviews in term of capacity and limitations. Ecopath models are intended to summarize the abundances and interactions of all

major functional groups in an ecosystem, along with detailed descriptions of how we exploit such ecosystems through fishing activities. A typical Ecopath model (such as the bulk of those on which this study is based) may include 25 to 40 functional groups ranging from primary producers to marine mammals, and incorporating a number of fishing fleets for which catches, discards and bio-economical details are provided.

The present study is based on a total of 23 ecosystem models, all of which are available from the first author (see also [www.ecopath.org](http://www.ecopath.org)). The models describe 15 geographic areas, and are all made to represent a given year or short time period between 1880 and 1998 (see Table 1). Many of the models incorporate time series information in addition to the year-specific information on which the model description is based (see references in Table 1 for further details). The time series information is used to assess how well the model can replicate trends over time in the ecosystem, as part of what may be considered a validation procedure. This, however, has limited implications for the present study, which does not incorporate the time-dynamic aspects usually considered when using the Ecosim routine of EwE (see Walters *et al.*, 1997; Christensen and Walters, 2000; Walters *et al.*, 2000).

For nearly all models, the time periods have been chosen to best take advantage of available data sources. Notably, the start of biomass data from stock assessment has often dictated the period to be used for the models. The only models that break with this trend are the two historic models for the North Sea (1880s), and for the Newfoundland area (1900). We have included these models to provide extremes on the temporal scale, and fully realize that the biomass estimates used in these models are more uncertain than those in the more current models. Therefore we also investigate the impact that these (and other models) have on the overall results, as is described in more detail below.

We have also sought to include models that are extreme with regard to other characteristics; a notable example is the Lancaster Sound model from Northeastern Canada. Reflecting the typical characteristics of such an arctic system, the model includes a variety of marine mammal groups, but only very limited amounts of high trophic-level fish; in addition a large part of the area is covered by ice for a good part of the year.

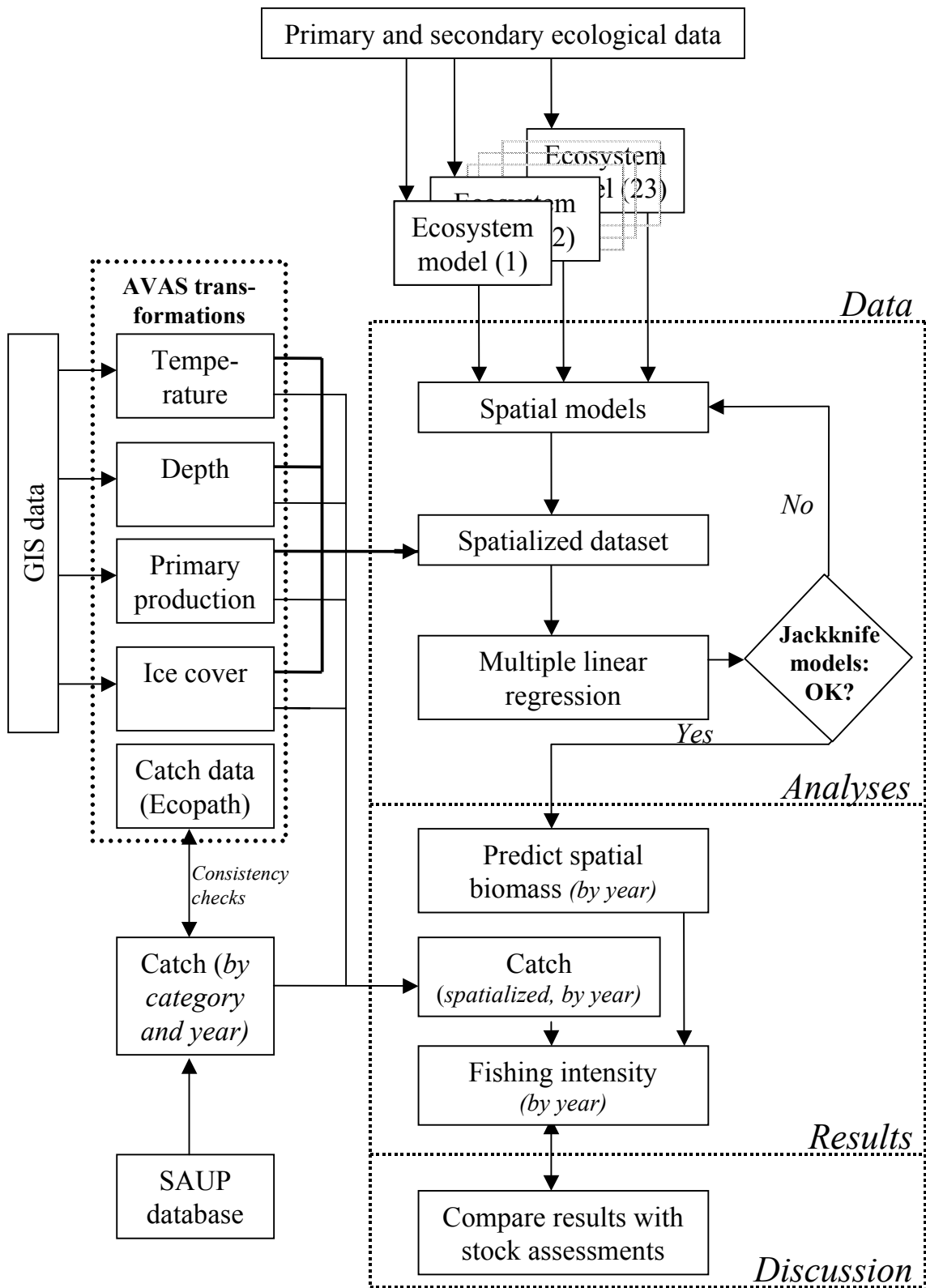

**Figure 1.** Schematic overview of the methodology used for predicting the biomass of high trophic-level fish in the North Atlantic.

**Table 1.** Overview of ecosystem models used for estimating abundance patterns of predatory fish in the North Atlantic. The third column indicates the number of half-degree spatial cells covered by each model. The lists of fish groups indicate the selection used for estimating abundance. Dem. is demersal, Grl. is Greenland, L is large, med is medium, pel. is pelagic, pisc. is piscivorous, pred. is predatory, S is small, TL is trophic level, trans. is transient. See the individual models for further information about the groups.

Area	Year	Cells	Fish groups with TL > 3.75	Reference
North Sea	1880	369	Bluefin tuna, Halibut and turbot, Saithe, Cod, Whiting, Sharks, Other pred. fish, Rays and skates, Sturgeon.	Mackinson, this vol.
Newfoundland (2J3KLNO)	1900	563	Haddock, Horse mackerel, Salmon and seatrout, Gurnards, Mackerel, West mackerel, Brill, Other prey fish	Heymans <i>et al.</i> , in prep.a)
Faeroe Islands	1961, 1997	132	Grl. halibut, Cod, Saithe, Other deep water, Other dem. fish	Zeller and Reinert, this vol.
North Sea	1963, 1974	369	Saithe, Cod, Whiting, West mackerel, Haddock, O. predators, Raja, Mackerel, Gurnards, Horse mackerel, Herring,	Christensen <i>et al.</i> , in prep.
Gulf of Biscay	1970, 1998	51	Extra L pelagic, L sharks, Tuna-like fish, L deepwater, S Sharks	Ainsworth <i>et al.</i> , this vol.
Lancaster Sound	1980	169	Grl. Halibut	Mohammed, this vol.
North Sea	1981	369	Saithe, O.pred.fish, Whiting, Cod	Christensen, 1995
Scotian shelf	1982	160	Dem. piscivores, Trans. pel., Halibut, Dogfish, Cod, Silver hake, Pollock	Bundy in prep.
Gulf of Maine & Georges Bank	1982	77	Summer flounder, L pelagic feeders, Bluefin tuna, Bluefish, Cod, L. Demersal feeders, Pollock	Heymans, this vol.
Morocco	1984	99	L pelagic, L dem. sharks/rays, Very L dem. comm., L deepwater comm., L and med bathypelagic, Very L dem., Sm. dem. sharks/rays	Stanford <i>et al.</i> , this vol.
Chesapeake Bay	1985	4	Blue fish, Summer flounder, Weak fish, Striped bass	Baird and Ulanowicz., 1989
Gulf of St. Lawrence (4RS)	1986	58	Grl. halibut, L cod, Skates, L pelagics	Morissette, this vol.
Newfoundland (2J3KL)	1986	563	Grl. halibut, Cod, L pel. Feeders, Skates, Pisc. S pel. feeders	Bundy <i>et al.</i> , 2000
US South Atlantic States	1996	81	Billfishes, Sharks, Tuna, Mackerel, Snappers, Groupers, Jacks, Pel. pisc., Dem. pisc., Benthic pisc.	Okey and Pugliese, this vol
Norwegian-Barents Sea	1997	2307	Cod	Dommasnes <i>et al.</i> , this vol.
Newfoundland (2J3KLNO)	1997	563	Grl. Halibut, Dogfish, Pollock, Transient pelagics, Cod, Transient mackerel, L dem. pisc., Skates	Heymans, <i>et al.</i> , in prep. b)
Greenland, west coast	1997	218	Grl. Halibut, Cod	Pedersen and Zeller, this vol.
Iceland	1997	288	Grl. Halibut	Mendy and Buchary, this vol.
Azores	1997	240	Pelagic L pred., Deepwater L, Sharks L, Coastal L pred, Dem. L pred, Phycis phycis, Pagellus bogaraveo, Coastal M pred, Sharks M, Dem. M inv, Rays, Dem. M pred, Pel. M pred,	Guénette and Morato, this vol.
US Mid Atlantic Bight	1998	48	Billfishes, Tunas, Bluefish, Goosefish, Striped bass, Weakfish, Coastal sharks, Spiny dogfish, Jacks, Benthic piscivores, Snapper / grouper, Black seabass, Dem. piscivores, Cods and hakes, Redfish	Okey, this vol.

Our initial selection of available models included two that we later chose to exclude from the analysis. One of these described the Icelandic waters in 1950, but did not include any biomasses that were based on empirical data. The other, from the Cantabrian Sea, covered the narrow shelf area only, and our half by half degree spatial cells did not represent this area in a realistic fashion; hence we would attribute the biomasses to unrepresentative depths.

Because of the uncertainty about abundance of small fish in the North Atlantic in general, we find it premature to estimate their abundances from the models on which this study is based. Instead we focus on the larger, predatory fish for which much more information is available, notably through stock assessment and research surveys. We define predatory fishes as those fish groups for which the trophic level is estimated at 3.75 or above. This effectively means that we include all

fish groups that predominantly eat prey species that feed on fish, zooplankton and/or small benthic organisms, (i.e., we excluded all primarily planktivorous, herbivorous and detritivorous fishes).

A list of fish groups included in the high trophic-level fish category is presented in Table 1, which illustrates that the species included are those of main interest for human consumption. This is demonstrated by comparing the value of the landings of high trophic-level fish species to the total value of the landings in Figure 2. It may be noted from the figure that in 1950, the high trophic-level fish contributed more than 50% to the total landing value, and that this had declined to 29% by the end of the century. The figure also demonstrates the overall importance of the cods and their high trophic-level relatives (mainly haddock and saithe).

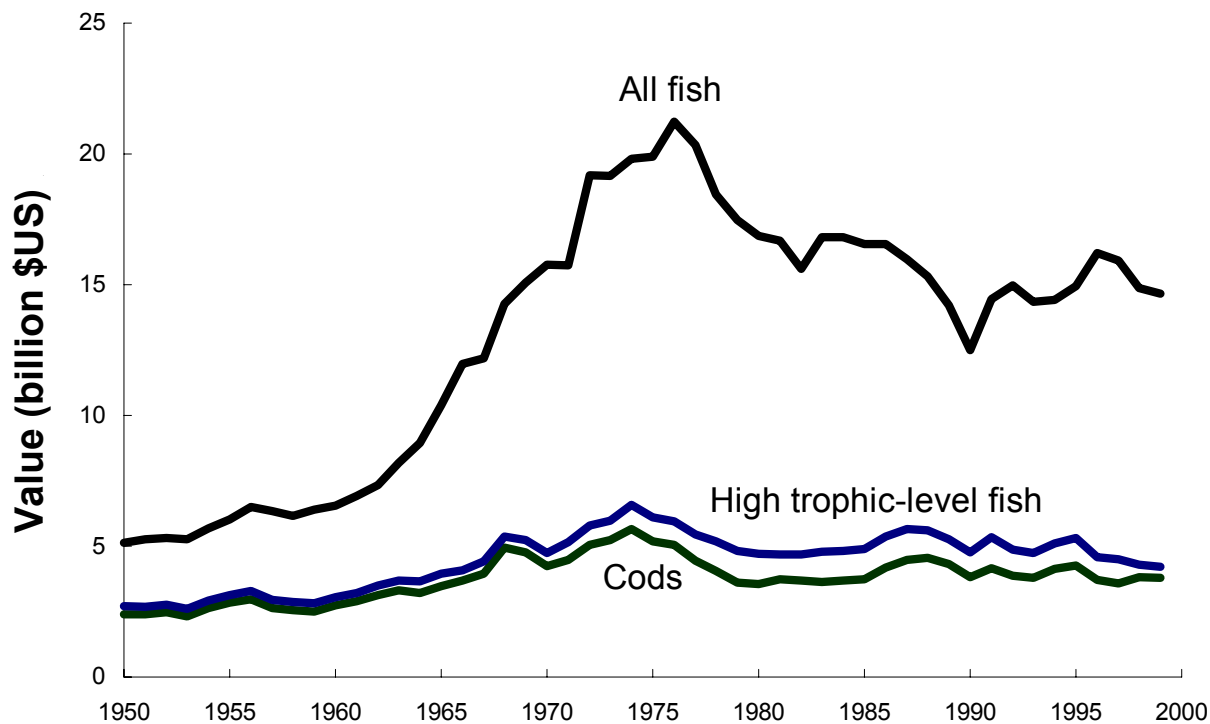

**Figure 2.** Value of total fish landings, of high trophic-level fish (TL  $\geq$  3.75) in the North Atlantic (as defined in Figure 3) during the second half of the 20<sup>th</sup> Century. The figure illustrates that the major contribution comes from cod and its close relatives. Overall, the value of high trophic-level fishes decreased from 53% of the total landing value of fish to 29% during the time period. Prices are year specific but converted to 2000-values using the U.S. consumer price index. See (Sumaila and Watson, 2002) for details about the value of landings.

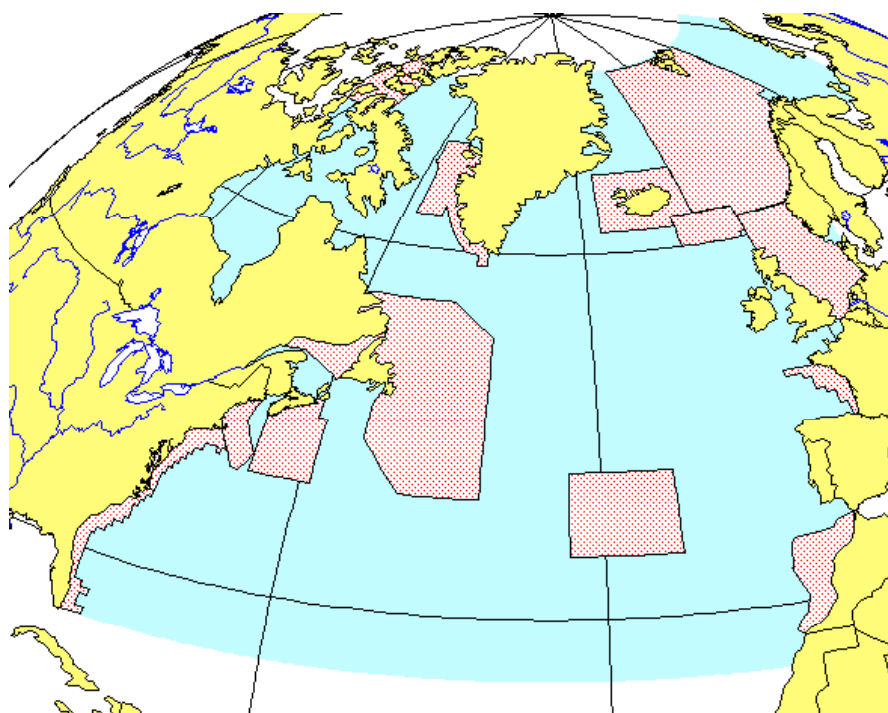

**Figure 3.** Map of the 15 geographic areas in the North Atlantic for which a total of 23 ecosystem models (shaded polygons, red in color) were used to obtain estimates for a total of approximately 18,000 half degree by half degree spatial cells (shaded background, light blue in color). The total water area included in the analysis is 28 million km<sup>2</sup>. The models for the Newfoundland/Grand Banks area off Canada do not all cover the same area.

We also exclude marine mammals and birds as well as high trophic-level invertebrates from our analysis. Marine mammals are better dealt with in a separate study using a different methodology (see Kaschner *et al.*, 2002), while for marine birds and invertebrates, it is a consequence of their representation being fairly superficial in the ecosystem models we have at hand. We also note that the biomasses involved for these groups are negligible in any case.

The definition of the trophic level cut-off point chosen here is somewhat arbitrary, and indeed a few models groups are included which we would not normally consider predatory, while in a few other cases some groups one would expect to see included have been excluded. The reason for this may well be that the trophic level estimation depends on how well the diets (from which the trophic levels were estimated) have been defined; this is something we have not been able to standardize completely between models. However, the general patterns emerging from the selections are very much in accordance with expectations, e.g., few species (but fairly high biomasses on continental shelves) in the colder, northern areas as compared to the more species-rich, warmer, southern areas. We believe the sheer mass of information will outweigh the few

cases where the trophic level estimates were problematic.

### Assigning models to strata

The ecosystem model coverage of the North Atlantic is incomplete, precluding simple scaling of flows and rates from the individual ecosystem to the basin level, and calling for a stratification scheme. The scheme we have chosen builds on the structure that is applied for catches and other data in the SAUP databases:  $\frac{1}{2}$  by  $\frac{1}{2}$  degree spatial cells (Watson *et al.*, 2002).

Each of the ecosystem models covers a distinct geographic area consisting of a variable number of the half-degree spatial units (see Figure 3). As part of the present study, we have constructed a spatial model for each ecosystem using the Ecospace model incorporated in the EwE software (Walters *et al.*, 1999). Ecospace, in essence, incorporates an Ecosim model in each spatial, non-land cell – of which there are for instance 369 in the North Sea model represented in the right panel of Figure 4. In total, the models covered 24% of the area of the North Atlantic, with the coverage reaching 40% in the depth strata where most concentrations of high trophic levels occur (Table 2).

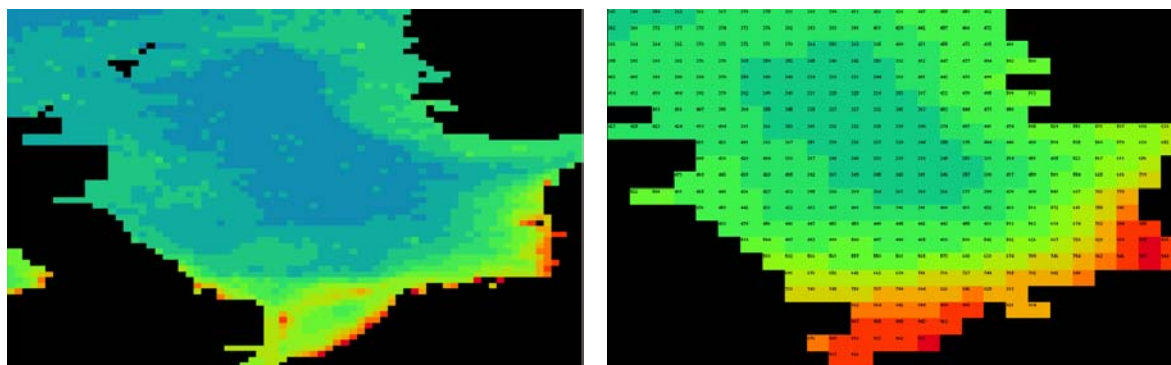

**Figure 4.** Patterns of annual primary production in the North Sea at two different resolutions scaling from high at the coasts in southeast to low in the central parts of the area. The left panel shows estimated productivity at a one-sixth degree scale based on SeaWIFS data, as made available by the EU Joint Research Centre. The right panel shows how this information is averaged, scaled to the original mean, and represented using 1/2 by 1/2 degree cells in the Ecospace models of the North Sea. The demise of the Shetland Islands is unintentional, reflects a consequence of using a coarse map, and does not represent any actual event.

**Table 2.** Area covered by Ecopath models from the North Atlantic, total area and proportion of total area covered by Ecopath models. All areas are in 10<sup>3</sup> km<sup>2</sup>.

Depth (m)	Sampled stratum	Total area	Proportion sampled
0-10	73	200	0.37
11-50	472	1150	0.41
50-100	576	1408	0.41
100-200	754	2177	0.35
200-1000	1413	3507	0.40
>1000	3567	19683	0.18
Total	6855	28124	0.24

Exchange between spatial cells is modeled for each time step (typically monthly), while accounting for food availability, predation and fishing patterns. The Ecospace models were constructed based on general information about habitat and depth preferences for the functional groups of the ecosystems. Primary production was distributed spatially based on SeaWIFS data as described below, while fishing effort was distributed spatially based on distance to coast, depth zone preferences of fleets, and fish abundance.

For each of the spatial model the cells were distributed between habitats based on depth only. The following depth strata were used for all models: (1) <10 m; (2) 11-50 m; (3) 51-100 m, (4) 101-200 m; (5) 201-1000 m, (6): >1000 m, see Table 2. Depth information at the 1/2 by 1/2 degree scale was obtained from the ETOPO5 dataset available on the U.S. National Geophysical Data Center’s Global Relief Data CD ([www.ngdc.noaa.gov/products/ngdc\\_products.html](http://www.ngdc.noaa.gov/products/ngdc_products.html)) as implemented in the *Sea Around Us* project database ([www.fisheries.ubc.ca/](http://www.fisheries.ubc.ca/)

[projects/saup](#)), and obtained by linking Ecospace to a GIS system, see Figure 5.A.

The predicted distributions in Ecospace models show marked sensitivity to primary productivity patterns, and these have in general not been well described in previous Ecospace models. To improve on this, we cooperated with the Institute for Environment and Sustainability of the European Commission’s Joint Research Centre in Ispra, Italy, to make global primary productivity maps based on SeaWIFS data available to ecosystem modelers. The primary productivity maps are based on a model that incorporates the SeaWIFS estimated chlorophyll, photosynthetically active radiation, and sea surface temperature patterns (Hoepffner *et al.*, MS), based on the model of Behrenfeld and Falkowski (1997). The maps are available on a monthly and quarterly basis from October 1997 onwards ([www.me.sai.jrc.it](http://www.me.sai.jrc.it)), but for the present study, a one-year production average representing 1999 was used, as this was the only yearly average available (Figure 5.B).

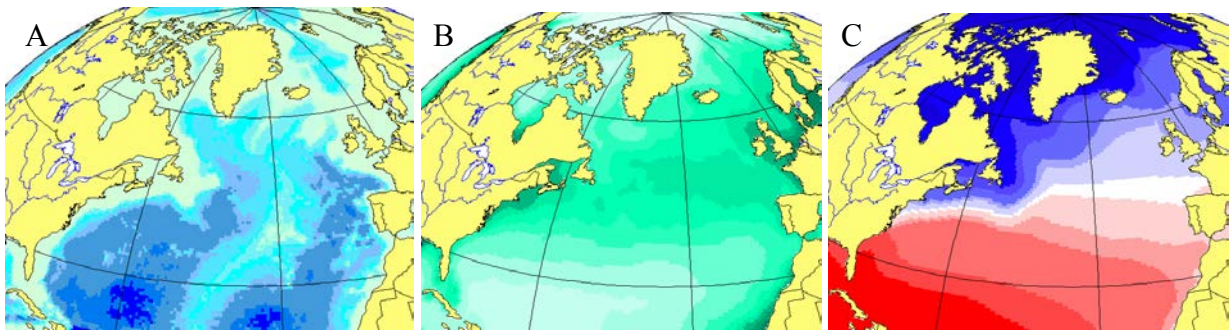

**Figure 5** (A) Depth, (B) primary production and (C) temperatures (at 10 m depth) in the North Atlantic. Data sources are the same as mentioned above for the respective variables. The depths scale from light being low depth to dark being deep, with the lightest intensity representing the zone down to around 400 meters, i.e., the zone where most of the fishing for demersal species takes place. Primary Production (B) scales from light being low productivity to dark representing high productivity. The temperatures are coldest (blue) in the arctic region, and the color scale is linear.

The primary productivity maps have a spatial resolution of approximately  $1/6$  degree, while the database used for the present study operates with  $1/2$  degree latitude by  $1/2$  degree longitude cells, i.e., with a resolution of one ninth of the SeaWiFS resolution. Therefore, a facility was included in Ecospace that aggregates the finer resolution maps, averaging, while maintaining the overall mean, and prepares the basemap for the Ecospace modeling (for details, see the EwE User's Guide, available at [www.ecopath.org](http://www.ecopath.org)).

Temperatures at 10 meters depth were obtained from climatology based on the NOAA World Ocean Atlas 1998 ([www.nodc.noaa.gov/OC5/wod98v2.html](http://www.nodc.noaa.gov/OC5/wod98v2.html)), as implemented in the *Sea Around Us* project database (see Figure 5.C). Ice cover information was obtained from the U.S. National Snow and Ice Data Centre, Boulder, Colorado ([www.nsidc.org/index.html](http://www.nsidc.org/index.html)), in form of monthly limits of sea ice coverage.

### Fisheries catches

There is a relationship, but not a simple one, between fish biomasses and how much fish one can catch. If catches are high, there at least must have been some high biomasses present to support these catches. However, high biomasses may also be associated with low catches, if the reason is low fishing effort. We do not, however, have reliable data on development of fishing effort over time for the North Atlantic as a whole, nor for any major parts of the basin; hence it is not straightforward to derive overall biomass levels from total catches. We expect, however, that the catch composition will change as a function of the biomass level of the preferred fishing target: i.e., of the high trophic-level species. It is by now well established that fisheries expansions go hand in hand with the process of

'fishing down the food web' (Pauly *et al.*, 1998), and we can therefore use the catch composition by spatial unit to draw inferences about the overall biomass of high trophic-level fish species, (see below).

The catches entering the regression analyses come from the ecosystem models, which in turn have utilized numerous sources (see model references in Table 1). For this purpose a routine has been added to the Ecopath software that allows allocation of catches of ecosystem groupings to the catch categories used in the SAUP database, as described further below. In order to carry out this allocation, we extracted catch distributions by ISSCAAP categories (see [www.fao.org](http://www.fao.org) for details of this classification) for the years and areas covered by the individual models, and used this to guide the distribution for the groups where the allocation was not obvious.

The catches in the SAUP database are used for predictive purposes based on the biomass regression. The main source for the catches is the FAO catch database ([www.fao.org](http://www.fao.org)), with information added from the Statlant database maintained by ICES ([www.ices.dk](http://www.ices.dk)), as well as from ICES assessment working group reports. Spatial distribution of the catches was undertaken using an elaborate, rule-based procedure implemented and described by Watson and Pauly (2001) and Watson *et al.* (2002). For this, the statistics were progressively disaggregated based on known distributions for the taxa, hydrographic conditions, and on where reporting countries were permitted access through fisheries agreements in the individual years.

The catches are distributed in twelve categories: (1) anchovies, (2) herrings, (3) perches, (4) tunas and billfishes, (5) cods, (6) salmoniformes, incl.

smelts and capelin, (7) flatfishes, (8) scorpionfishes, incl. redfish, (9) sharks and rays, (10) crustaceans, (11) molluscs, and (12) 'other' groups.

For the regression analysis in the present study, we merged herrings and the salmoniformes (the latter being totally dominated by capelin). There are indications, both from the catches and ecological studies, that capelin replaced herring during the 1970s-1980s when herring abundance in the northern Atlantic was low. Also, the two species serve as important forage species for the high trophic-level species considered in this study. We chose to combine the two invertebrate groups, (10) and (11), in the regression analysis based on the expectation that high invertebrate catches are associated with low biomass levels of high trophic-level catches (an effect of 'fishing down the food web'), and noting that it did not have any observable effect on the regressions; hence, one less variable is to be preferred.

Finally, when examining the regression it was clear that the overall catches of tuna and billfishes shows very little trend over the fifty year period under study (linear slope 0.1% of intercept,  $r^2 = 0.01$ ,  $\text{std} = 12\%$  of mean). This is in accordance with expectations as the catch composition of tuna have changed over the fifty year period; indeed we now have evidence for declining trophic levels of catches within the tunas (Pauly and Palomares, MS). Illustrative of this is that bluefin tuna catches were estimated to 38,000 tonnes in 1960 and 100 tonnes in 1999, while the decrease was compensated for by increased catches of smaller, lower trophic-level tunas, so as to maintain (within 1%) the total tuna catch. Thus, the tuna and billfish category turned out not be a significant predictor of the biomass of high trophic-level fishes, and the category was omitted as a predictive variable from the regression analysis.

### Regression analysis

All regression analyses were performed using multiple linear regression using the S-Plus 6 software (Anon., 2001b). Prior to performing the regression analyses, we used an additive and variance stabilizing transformation (AVAS), as implemented in S-Plus, to study how individual variables are best transformed to obtain linearity (Figure 6). AVAS seeks for transformations,  $\Theta(y)$

$= \phi_1(x_1) + \phi_2(x_2) + \dots + \phi_p(x_p) + \varepsilon$ , which provides a good additive model approximation for the data,  $y_i, x_{i1}, \dots, x_{ip}$ , for  $i = 1, 2, \dots, n$  observations, while seeking to achieve variance stabilization. Based on the AVAS analyses, we concluded that logarithmic transformations were suitable for primary production and biomass, while no transformations were required for year and latitude. For depth, indications pointed to the use of a quadratic transformation (truncated at 5000 meter to avoid extrapolation). Ice cover was treated as a categorical variable (no ice cover, ice cover part of the year, and ice cover year-round) and hence required no transformation. The various catch categories, as defined above, were transformed using logarithmic transformations (catch in  $\text{kg}\cdot\text{km}^2\cdot\text{year}^{-1}$ , with  $1 \text{ kg}\cdot\text{km}^2\cdot\text{year}^{-1}$  added to enable log-transformation of catches of zero).

As data material for the regression analysis, we extracted 7811 records based on the  $1/2$  by  $1/2$  degree spatial cells of the 23 ecosystem models. Each of the records included estimates of biomass and catch of high ( $\geq 3.75$ ) trophic level, depth, distance from coast, water temperature at 10 meters depth, ice cover category, number of seamounts and reefs, primary production, upwelling index, catch by each of the catch categories defined above, latitude, and year of the model. The upwelling index we used was based on latitude and basin-specific temperature anomalies (V. Christensen, unpublished data).

We were not able to use the following as predictive variables: distance from coast (it appears that the North Atlantic is so accessible that any fishing ground will be exploited; fishing was indeed the reason Europeans started crossing the Atlantic regularly); number of seamounts and reefs (both are negligible), and the upwelling index (there are no significant upwelling cells in the study area, hence, no effect can be expected). Further, we could not demonstrate any effect of temperature, probably because of the inclusion of the latitude and ice cover terms.

To prevent the records extracted from models covering large areas from swamping those from other models, the records were included in the regression analysis using a weighting factor, the inverse of the square root of the number of non-land cells in the models to which the given record belongs.



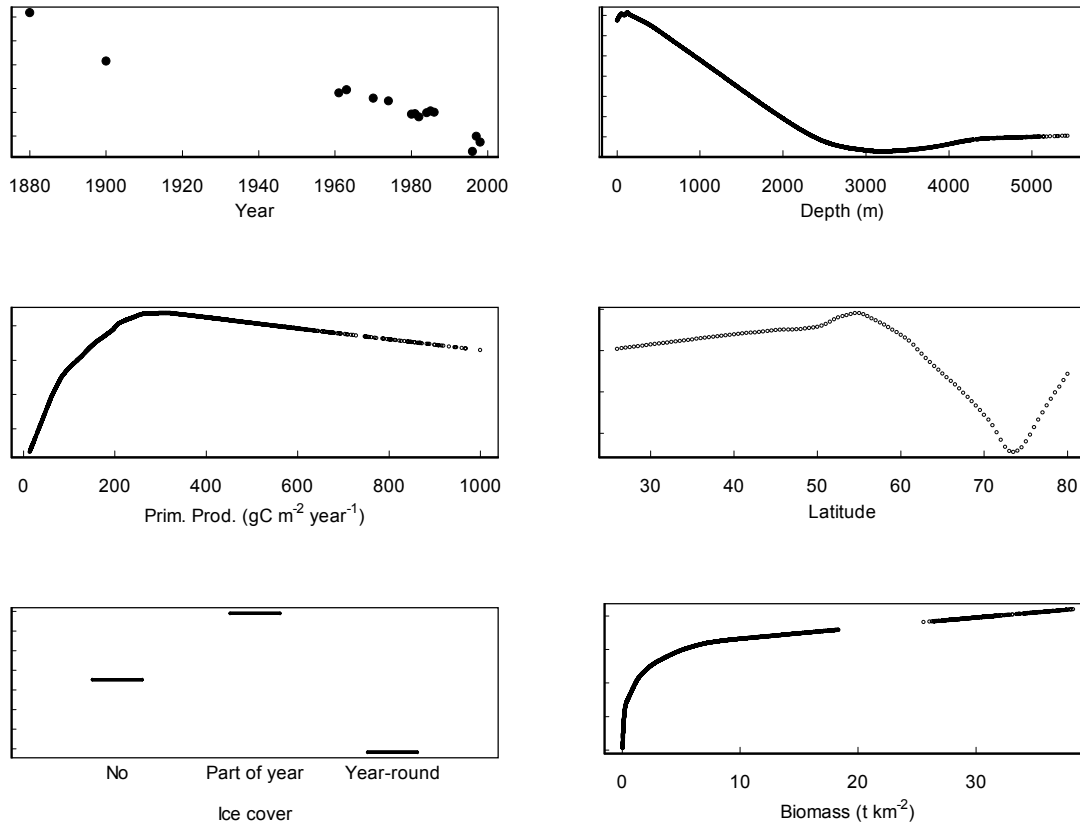

**Figure 6.** AVAS transformations indicating how parameters (X-axis) may be transformed (Y-axis indicate biomass, linear scale) to linearize the individual parameters while considering their joint effects. Results indicate that no transformations are required for year and latitude, while a quadratic transformation is acceptable for depth, and log-transformations for primary production and biomass. Ice cover is treated as a categorical variable.

The multiple linear regression takes the following form,

$$\log(\text{Biomass}) = a + b_1 \cdot \text{year} + b_2 \cdot \log(\text{PP}) + b_3 \cdot \text{Depth} + b_4 \cdot \text{Depth}^2 + b_5 \cdot \text{Latitude} + b_6 \cdot \text{ICE}_{\text{PartOfYear}} + b_7 \cdot \text{ICE}_{\text{YearRound}} + b_8 \cdot \log(\text{Catch anchovies}) + b_9 \cdot \log(\text{Catch herring and smelts}) + b_{10} \cdot \log(\text{Catch perciformes}) + b_{11} \cdot \log(\text{Catch cods}) + b_{12} \cdot \log(\text{Catch flatfishes}) + b_{13} \cdot \log(\text{Catch scorpionfishes}) + b_{14} \cdot \log(\text{Catch invertebrates})$$

where,

$a$  is the regression intercept, and  $b_1$  to  $b_{14}$  the slopes to be estimated by the regression;

Biomass is the predicted biomass of predatory fishes ( $\text{g} \cdot \text{m}^{-2}$ );

PP is the average primary production ( $\text{gC} \cdot \text{m}^{-2} \cdot \text{year}^{-1}$ );

Depth is the average depth (m);

Latitude is the latitude of the observation;

$\text{ICE}_{\text{PartOfYear}}$  and  $\text{ICE}_{\text{YearRound}}$  are categorical parameters that takes the value 1 if the cell is ice-covered part of the year or year-round, respectively, and the value 0 if not; and

Catch variables are in  $\text{kg} \cdot \text{km}^{-2} \cdot \text{year}^{-1}$  with 1  $\text{kg} \cdot \text{km}^{-2} \cdot \text{year}^{-1}$  being added to accommodate log-transformations for zero catches.

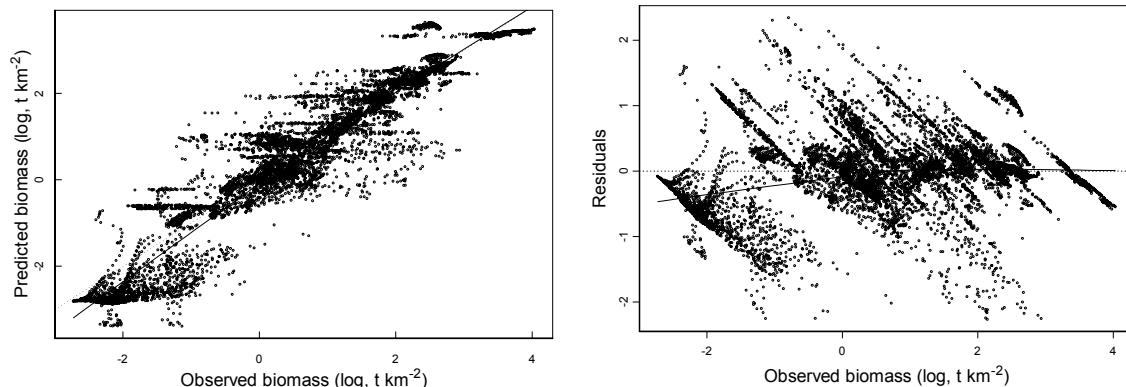

**Figure 7.** *Left.* Observed versus predicted biomass (log-scales, t-km<sup>-2</sup>) for predatory fish in the North Atlantic during the second half of the 20<sup>th</sup> Century. *Right.* Plot of residuals (predicted - observed biomass, log-scale) versus predicted biomass (log-scale, t-km<sup>-2</sup>) for predatory fish in the North Atlantic during the second half of the 20<sup>th</sup> Century.

**Table 3.** Parameters estimates and associated test statistics for a multiple linear regression predicting the biomass (log, g·m<sup>-2</sup>) of predatory fishes (TL>3.75) in the North Atlantic during the second half of the 20<sup>th</sup> Century. The primary production (PP) is in log, gC·m<sup>-2</sup>·year<sup>-1</sup>, while catches are in log, kg·km<sup>-2</sup>·year<sup>-1</sup>. Depth is included with a linear and a quadratic term. The variable are arranged after t-value (value relative to standard error, given) corresponding to adjusted partial slopes (Blalock, 1972).

Variable	Value	Std. error	t-value	Pr(> t )
Year	-0.017415	0.000255	-68.3	0.0000000
(Intercept)	35.873360	0.541	66.3	0.0000000
Latitude	-0.0458485	0.000858	-53.4	0.0000000
Depth	-0.0009162	0.0000194	-47.2	0.0000000
Catch, anchovies	-0.2390645	0.00731	-32.7	0.0000000
Catch, herring and capelin	0.1216986	0.00387	31.5	0.0000000
Catch, scorpionfishes	0.116684	0.00382	30.5	0.0000000
Catch, perches	-0.1420623	0.00472	-30.1	0.0000000
Catch, cods	0.1119097	0.00495	22.6	0.0000000
Depth <sup>2</sup>	0.000000089	0.000000005	19.5	0.0000000
Catch, flatfish	0.0520826	0.00350	14.9	0.0000000
Ice cover, year-round	-0.2849061	0.0224	-12.7	0.0000000
Catch, invertebrates	-0.0269938	0.00290	-9.3	0.0000000
Primary production	0.1646445	0.0195	8.4	0.0000000
Ice cover, part of year	0.0381208	0.0115	3.3	0.0008919

The multiple R<sup>2</sup> of the regression is 0.859 with 7796 degrees of freedom. The F-statistic is 3389 on 14 and 7796 degrees of freedom, with a p-value of 0. [Given spatial autocorrelation, we do not really believe our cells to provide true degrees of freedom; yet the results indicate that the regression is fairly robust]. The Residual standard error is 0.1280 on 7796 degrees of freedom. All parameters are highly significant (P < 0.001).

Summing up the regression results, we conclude that the predictive variables are able to explain the major part of the variance in the dataset (R<sup>2</sup> =

0.86), and the slopes have the right sign for the variables where we had expectations about their impact. The t-values give indications for the internal ‘ranking’ of the parameters, i.e., which ones matter most (or where the probability of exceeding the t-value by chance is smallest). Due to co-variation between variables, we acknowledge that any interpretation of the ‘rankings’ should be treated with extreme caution. We find that the highest t-value is associated with the year parameter, followed by the intercept, latitude and depth.

Primary production has a surprisingly low  $t$ -value, partly reflecting that depth and primary production show covariance, and partly that we do not have models covering the Gulf Stream region across the North Atlantic where primary production and depth are both fairly high (see Figure 5).

As with any other multiple regression or statistical model, results depend on the input data, and we need to consider what we included in the analysis, both with regard to outliers and to predictive variables. To study this further, we have conducted a series of analyses where we sampled the original datasets. This is described in more detail in the following sections.

### Effect of individual models on the regression analyses

The regressions we obtain will depend on what observations (here: ecosystem models) we include. To study the robustness of the regressions we have analyzed the data using a jackknife approach (Sokal and Rohlf, 1995), omitting one model at a time from the regression. Subsequently, we used the jackknifed models to provide estimates of biomass over time (see Figure 1). The results from the jackknife analyses are presented in Table 4, while Figure 8 shows the biomass trends resulting from the jackknifing. The jackknife approach can be used in a formal context for estimating confidence intervals of biomasses, but because of the small

number of observation groupings (models) and the use of a logarithmic scale, the confidence intervals that could be derived here are too wide to be meaningful. We do not find that the standard method for estimating confidence intervals based on jackknifing is applicable to the analyses in the present study, and hence, we are for the time being not able to associate confidence intervals with the results.

Figure 8 shows that omitting the Lancaster Sound model would lead to nearly twice as high biomass estimates for the North Atlantic basin, and illustrates the importance of including extremes (here a temperature extreme with low fish biomasses) in the multiple linear regressions. The model, which if omitted, would result in the second highest biomasses, is the one for the Norwegian Sea and the Barents Sea, for which the same can be said.

The most noteworthy finding from the jackknife analyses is that while the absolute estimates of abundance is sensitive to in- or exclusion of individual models; the overall trends over time show remarkably little sensitivity to model deletion. Hence, the overall conclusions from the present study are not very sensitive to the selection of models. Rather, they are emergent properties based on many models.

Table 4 mainly serves to illustrate the degree to which the intercepts and slopes change as a result of the jackknife exercise.

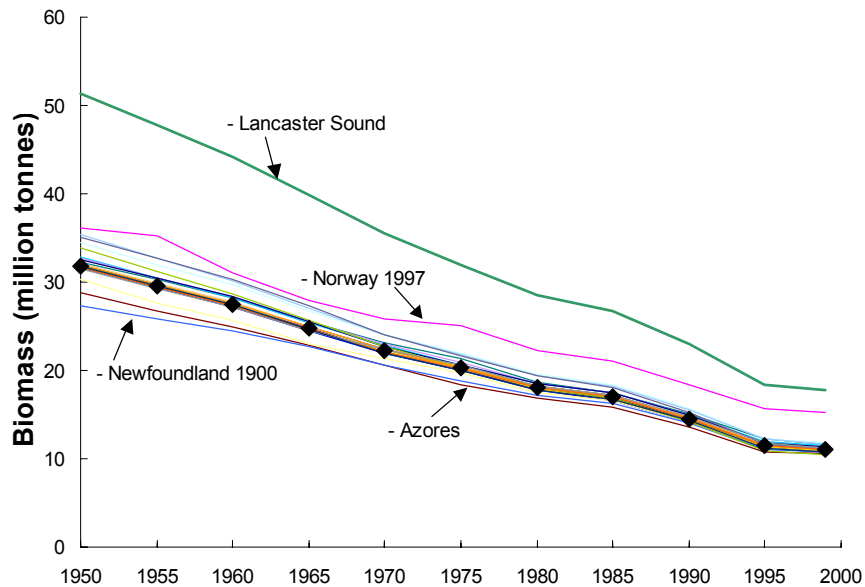

**Figure 8.** Illustrates the effect of excluding individual models from the regression analysis in a jackknife fashion (excluding one model at a time and repeating the regression analysis and predictions over time). The thick line with diamond markers indicates the regression with all models included. Jackknifed models are indicated only for the few cases generating strong deviations from the mean trend.

**Table 4.** Effect on the parameters of the regressions for estimating biomass of high trophic-level fishes in the North Atlantic based on jackknifing of the models included in the analysis.

	<b>Including all models</b>	<b>Azores 97</b>	<b>Biscay 70</b>	<b>Biscay 98</b>	<b>Chesapeake Bay 85</b>	<b>Faroe Islands 61</b>	<b>Faroe Islands 97</b>	<b>Gulf of St. Lawrence 86</b>
(Intercept)	35.873	31.999	35.879	35.879	35.880	36.718	35.629	35.828
year	-0.017	-0.016	-0.017	-0.017	-0.018	-0.018	-0.017	-0.017
Prim. prod.	0.165	0.334	0.165	0.165	0.183	0.151	0.152	0.214
Depth (10 <sup>3</sup> )	-0.916	-1.039	-0.916	-0.916	-0.923	-0.917	-0.933	-0.932
Depth <sup>2</sup> (10 <sup>7</sup> )	0.890	1.190	0.890	0.890	0.920	0.880	0.950	0.920
Latitude	-0.046	-0.031	-0.046	-0.046	-0.044	-0.046	-0.047	-0.047
Ice, part	0.038	0.054	0.038	0.038	0.041	0.025	0.069	0.078
Ice, all	-0.285	-0.225	-0.285	-0.285	-0.279	-0.296	-0.293	-0.259
Anchovies	-0.239	-0.251	-0.239	-0.239	-0.178	-0.237	-0.232	-0.246
Herring, capelin	0.122	0.174	0.122	0.122	0.121	0.117	0.140	0.116
Perches	-0.142	-0.196	-0.142	-0.142	-0.119	-0.140	-0.152	-0.139
Cods	0.112	0.094	0.112	0.112	0.086	0.114	0.106	0.114
Flatfish	0.052	0.090	0.052	0.052	0.058	0.053	0.055	0.046
Scorpionfishes	0.117	0.099	0.117	0.117	0.118	0.122	0.108	0.125
Invertebrates	-0.027	-0.018	-0.027	-0.027	-0.021	-0.029	-0.039	-0.023

**Table 4, continued.**

	<b>Greenland west coast 97</b>	<b>G. of Maine / Georges Bank 82</b>	<b>Iceland 97</b>	<b>Lancaster Sound</b>	<b>Morocco 84</b>	<b>Newfound land 1900</b>	<b>Newfound land 85-87</b>	<b>Newfound land 95-00</b>
(Intercept)	35.507	35.892	37.340	39.363	36.406	29.193	34.817	35.674
year	-0.017	-0.017	-0.018	-0.018	-0.018	-0.014	-0.017	-0.017
Prim. prod.	0.166	0.179	0.194	-0.232	0.140	0.189	0.162	0.168
Depth (10 <sup>3</sup> )	-0.906	-0.918	-0.974	-1.036	-0.848	-0.893	-0.918	-0.910
Depth <sup>2</sup> (10 <sup>7</sup> )	0.860	0.900	1.040	1.080	0.680	0.840	0.940	0.860
Latitude	-0.047	-0.045	-0.049	-0.048	-0.050	-0.043	-0.047	-0.046
Ice, part	0.025	0.041	0.080	-0.032	0.039	0.024	0.035	0.042
Ice, all	-0.277	-0.279	-0.276	-0.119	-0.265	-0.247	-0.286	-0.284
Anchovies	-0.234	-0.323	-0.221	-0.198	-0.249	-0.222	-0.233	-0.241
Herring, capelin	0.130	0.125	0.102	0.121	0.128	0.096	0.130	0.124
Perches	-0.150	-0.124	-0.134	-0.146	-0.141	-0.146	-0.160	-0.144
Cods	0.117	0.087	0.128	0.107	0.111	0.145	0.115	0.109
Flatfish	0.047	0.057	0.040	0.065	0.049	0.070	0.059	0.052
Scorpionfishes	0.114	0.120	0.107	0.108	0.123	0.107	0.118	0.119
Invertebrates	-0.033	-0.023	-0.037	-0.050	-0.026	-0.029	-0.039	-0.028

**Table 4, continued.**

	<b>North Sea 1880</b>	<b>North Sea 81</b>	<b>North Sea 63</b>	<b>North Sea 74</b>	<b>Norwegian-Barents Sea 97</b>	<b>Scotian shelf 80-85</b>	<b>US South Atlantic States</b>	<b>US Mid Atlantic Bight</b>
(Intercept)	39.655	36.757	35.656	35.488	24.918	37.694	36.174	36.235
year	-0.019	-0.018	-0.017	-0.017	-0.013	-0.018	-0.017	-0.018
Prim. prod.	0.187	0.160	0.173	0.169	0.414	0.180	0.118	0.153
Depth (10 <sup>3</sup> )	-0.916	-0.934	-0.926	-0.912	-0.679	-0.981	-0.941	-0.911
Depth <sup>2</sup> (10 <sup>7</sup> )	0.880	0.920	0.910	0.890	0.650	1.070	0.930	0.880
Latitude	-0.044	-0.046	-0.046	-0.045	-0.020	-0.048	-0.049	-0.046
Ice, part	0.026	0.034	0.039	0.039	0.081	0.017	0.029	0.039
Ice, all	-0.275	-0.281	-0.282	-0.283	-0.426	-0.260	-0.294	-0.297
Anchovies	-0.239	-0.242	-0.239	-0.239	-0.185	-0.237	-0.259	-0.229
Herring, capelin	0.115	0.120	0.120	0.121	0.168	0.075	0.123	0.124
Perches	-0.151	-0.136	-0.145	-0.148	-0.111	-0.142	-0.124	-0.147
Cods	0.129	0.101	0.116	0.115	0.180	0.155	0.100	0.112
Flatfish	0.056	0.045	0.051	0.052	-0.128	0.039	0.052	0.050
Scorpionfishes	0.107	0.135	0.114	0.109	0.087	0.124	0.115	0.123
Invertebrates	-0.020	-0.022	-0.025	-0.019	0.003	-0.008	-0.020	-0.033

**Effect of catch composition on the regression analyses**

In an exercise analogous to the jackknifing for quantifying the effect of excluding individual models from the regression analyses, we have investigated the effect of excluding each of the nine individual catch categories from the regressions. Omitting individual catch categories was found to have negligible impact on the estimated biomasses of high trophic-level fish in

the North Atlantic, as can be seen from Figure 9. Nearly all the predicted biomasses fall close to the original regression (which is marked with diamonds in the figure).

The effect that omitting catch categories has on the intercepts and slopes of the biomass regressions is shown in Table 5. As might be seen, the intercepts and slopes of the regressions omitting individual catch categories are fairly stable across the analyses.

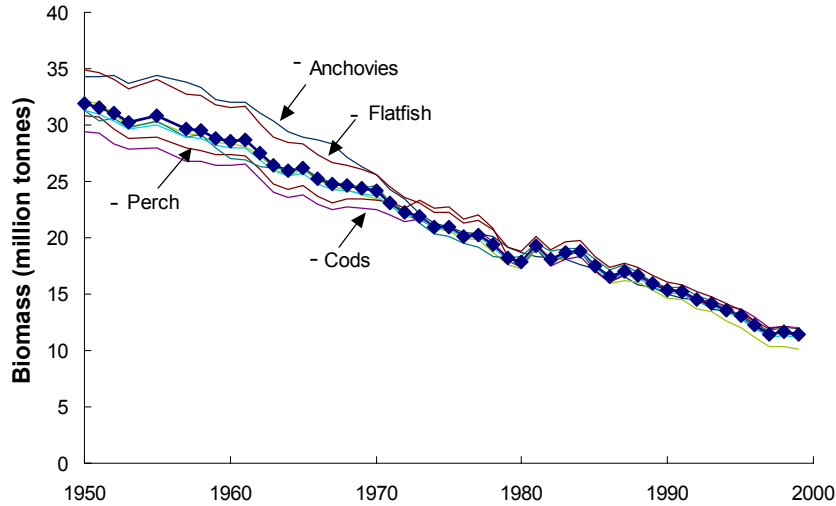

**Figure 9.** Effect on the estimated biomass of high trophic-level fish in the North Atlantic of omitting individual catch groupings from the regression analysis. The thicker line with diamond markers is based on the original regression including all catch categories (the data marked 'None' in Table 5). Groups that when omitted have any noticeable impact on the results are indicated.

**Table 5.** Effects on parameters (intercept, slope and correlation coefficient) of multiple linear regression of omitting individual catch categories from the regressions. The column headings indicate the catch category that was omitted from each of the 10 regressions made. The catch categories are the same as discussed earlier.

Variable	None	Anchovy	Herring	Perches	Cods	Flatfish	Scorpion	Invert.
(Intercept)	35.873	36.756	40.308	42.314	35.596	37.111	31.426	36.680
year	-0.017	-0.018	-0.020	-0.021	-0.017	-0.018	-0.015	-0.018
Prim. Prod.	0.165	0.052	0.246	0.104	0.214	0.167	0.155	0.188
Depth (10 <sup>3</sup> )	-0.916	-0.901	-0.945	-0.951	-0.933	-1.006	-0.811	-0.924
Depth <sup>2</sup> (10 <sup>7</sup> )	0.890	0.860	0.940	1.030	0.950	1.060	0.720	0.910
Latitude	-0.046	-0.047	-0.040	-0.047	-0.041	-0.050	-0.043	-0.044
Ice, part	0.038	0.036	0.002	0.056	0.041	0.034	0.048	0.019
Ice, all	-0.285	-0.372	-0.281	-0.262	-0.278	-0.280	-0.318	-0.259
Anchovies	-0.239		-0.234	-0.294	-0.294	-0.225	-0.218	-0.258
Herring, capelin	0.122	0.119		0.085	0.142	0.122	0.128	0.106
Perches	-0.142	-0.181	-0.096		-0.083	-0.139	-0.198	-0.128
Cods	0.112	0.165	0.148	0.029		0.132	0.183	0.111
Flatfish	0.052	0.038	0.053	0.047	0.074		0.088	0.051
Scorpionfish	0.117	0.105	0.123	0.161	0.157	0.136		0.117
Invertebrates	-0.027	-0.053	0.012	0.000	-0.026	-0.026	-0.027	
r <sup>2</sup> -Squared:	0.859	0.859	0.841	0.842	0.850	0.855	0.842	0.857

The overall conclusion from the two series of regression analyses that omitted parts of the data is that the results are robust with regards to the slope of the resulting biomass trends, whereas the absolute values of the predicted biomasses are more uncertain. This is in line with the general expectation for this form for multiple regression, i.e., we expect to be able to distinguish change better than we can predict absolute values.

### Predicting biomass of predatory fishes

We have derived a linear regression to predict the abundance of high trophic-level fishes in the North Atlantic based on information from a number of ecosystem models dispersed over the region and in time from the late 19<sup>th</sup> Century through to the end of the 20<sup>th</sup> Century. The regression is based on a total of 18,024 spatial units of 1/2 by 1/2 degree, and uses year, depth, primary production, temperature, ice cover, and catch quantity and composition to predict the biomass.

For predictive purposes we then established a spatialized database including the same information for all spatial units globally and for all years from 1950 through 1999. For the present analysis, however, we use the database only to predict biomasses in the North Atlantic region to avoid extrapolation beyond the area covered by the ecosystem models in Table 1.

Based on the biomass regression analysis applied to the North Atlantic in 1950, 1975 and 1999 the maps in Figure 10 can be derived. These maps, prepared using ArcView GIS 3.2, indicate how biomasses were predicted to be distributed in the three years represented, and are intended to describe general patterns only. They will obviously miss out on specific events, such as the emergence of a big year-class of a major population for obvious reasons, however, they will capture the big picture. The maps indicate a strong decline in biomass over the fifty-year period studied; we will return to this theme below.

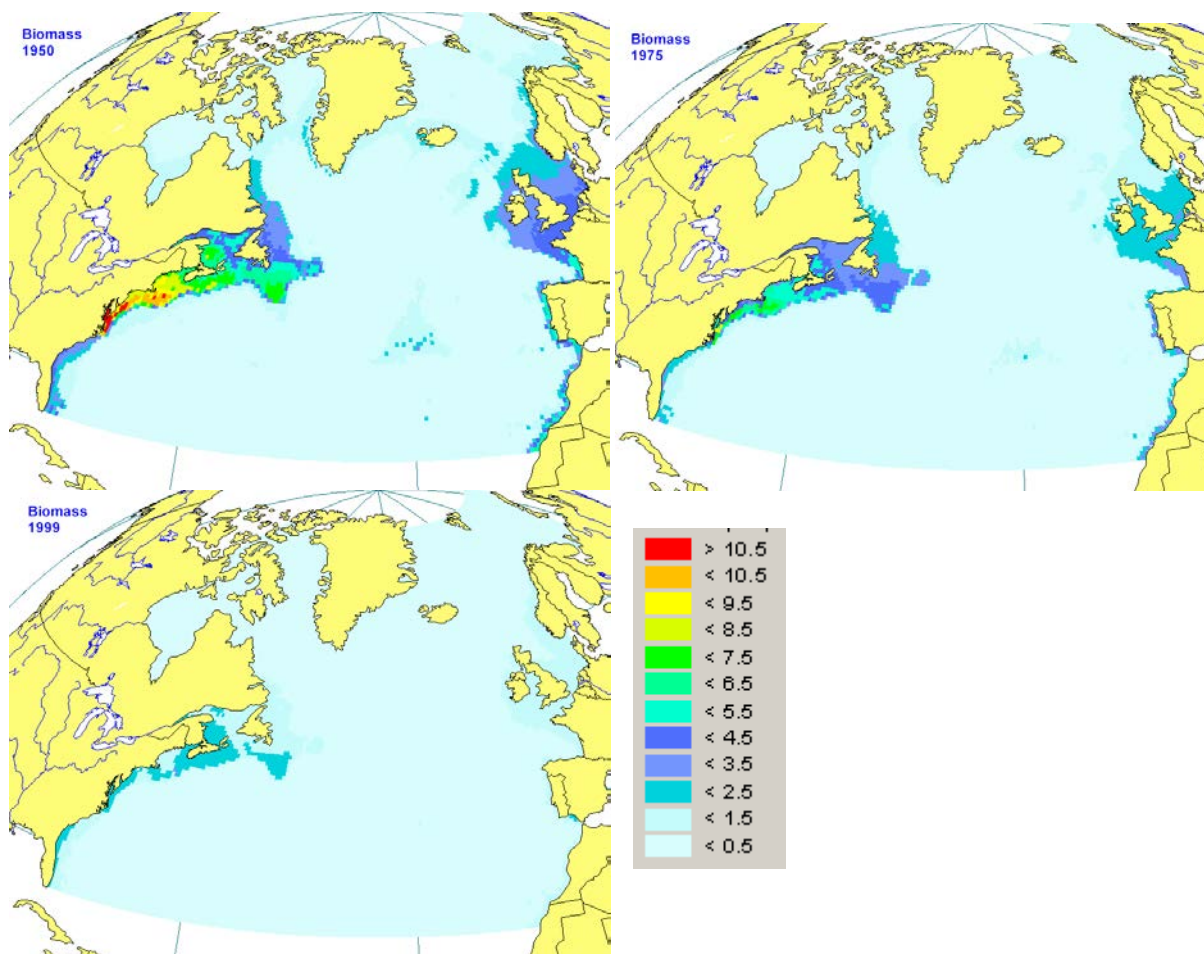

**Figure 10.** Biomass distributions for high trophic-level fish in the North Atlantic in 1950, 1975 and 1999. The distributions are predicted from linear regressions based on primary production, depth, temperature, year, ice cover, latitude, and catch composition. Units for the legend are t-km<sup>-2</sup>.

## Catches

The catches of high trophic-level species, i.e., of the main species of interest for human consumption, as demonstrated in Figure 2, increased steadily from 1950 through to the end of the 1960s, and have declined as steadily ever since (Figure 11). The catch level in the late 1990s was thus lower than in 1950, in spite of major development in catch capacity and technological progress, along with geographic expansion across the North Atlantic region.

The estimated spatial distributions of the high trophic-level catches are mapped in Figure 12. They are based on the rule-based method for distribution of catches described by (Watson and Pauly, 2001) and (Watson *et al.*, 2002), but applied only to fish species with a trophic level of 3.75 or more.

## Fishing mortalities

The catch figure and catch maps (Figure 11 and Figure 12) by themselves paint a dire picture of what has happened in the North Atlantic area

over the past fifty years, but they do not directly address a major question: “Do we catch less because there are less fish, or is it due to catch restrictions imposed to limit catches?” In order to address this question, we need to derive measure of how fishing effort has developed over time. Ideally we would have a direct measure of the fishing effort, but such information is pathologically poor, even in this well-studied and highly regulated region. *In lieu* of a direct measure, we will revert to a classic estimation. Beverton and Holt (1957) describe the ratio of catch to biomass for a population as a direct measure of fishing intensity, and the catch/biomass ratio, commonly described as ‘fishing mortality’, is indeed the method of choice in fisheries assessment for regulating fishing effort. We emphasize that the measure of fishing mortality we have derived here is not directly comparable to the mortality rates commonly reported, as the absolute level of the biomasses estimated here is associated with considerable uncertainty. Therefore, we prefer to interpret the measure as a relative index of ‘fishing intensity’ only, especially since Beverton and Holt proposed this term for use in spatial applications.

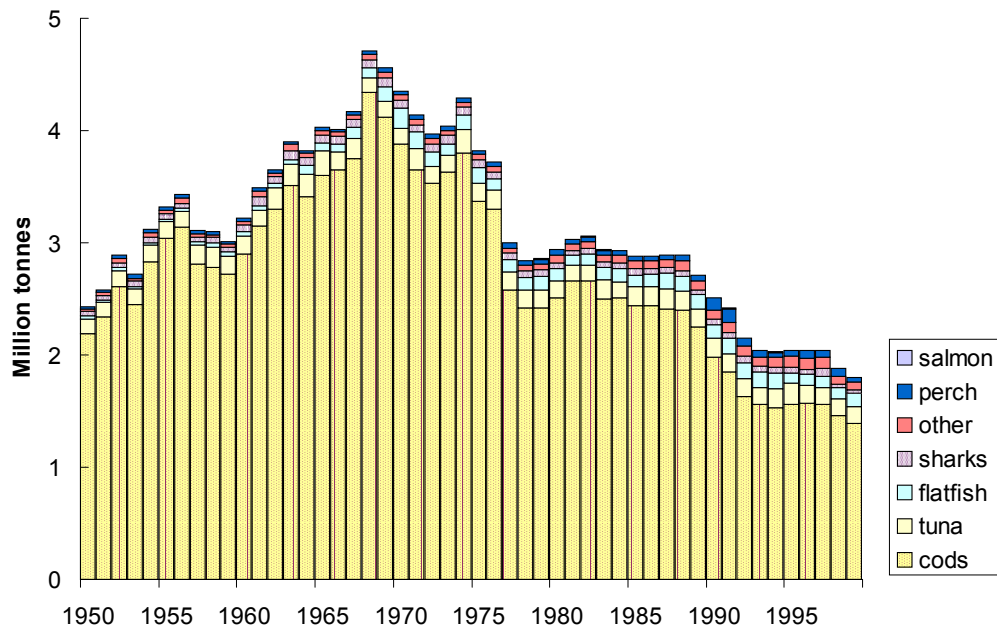

**Figure 11.** Annual catches of high trophic-level fish in the North Atlantic during 1950 to 1999. Primarily based on catch data from FAO (see Watson *et al.*, 2001, for details). The catches include only fish species with a trophic level of 3.75 or more. The trophic levels are mainly based on diet compositions, and are extracted from FishBase.

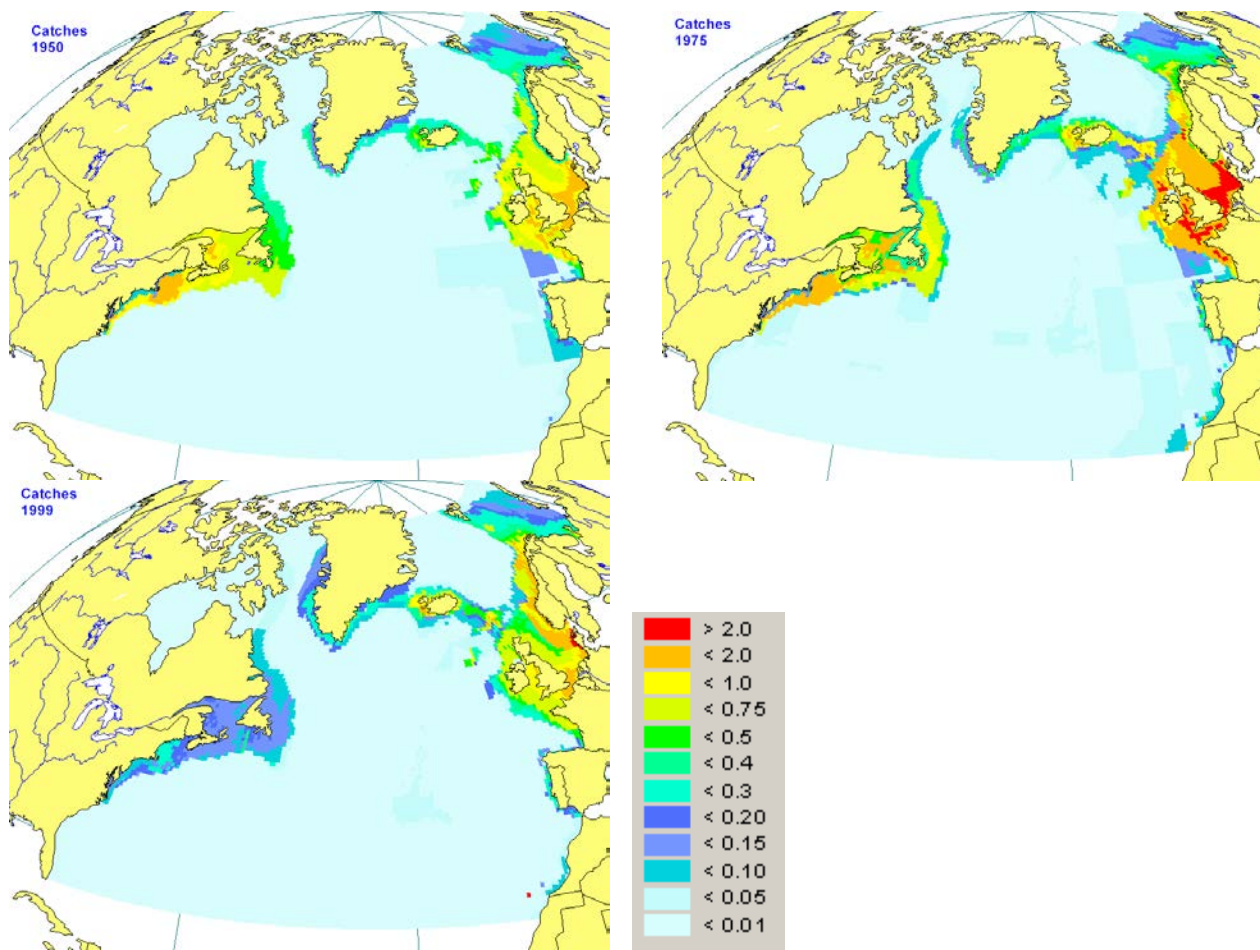

**Figure 12.** Predicted catch distributions of high trophic-level fishes in the North Atlantic in 1950, 1975 and 1999. The catches are based on FAO catch data information supplemented with other sources using a rule-based system for spatial allocation (Watson et al. 2001), and are here extracted for fish with trophic level  $\geq 3.75$  (based on trophic levels in FishBase). Units for the legend are  $t \cdot km^{-2} \cdot year^{-1}$

Combining information about catch and biomass levels over time, we obtain the results shown in the maps in Figure 13 and in the plot in Figure 14. The figure neatly summarizes trends over the last fifty years for high trophic-level fishes in the North Atlantic. Biomasses are found to have been declining steadily over the period at a rate that was slightly lower in the first twenty years than in the last thirty years. The catches peaked in the late 1960s, and have declined steadily since to the extent that the level in 1999 was lower than in 1950. The resulting measure of fishing intensity, estimated as the ratio between catch and biomass,

provides part of the explanation. Fishing intensity increased with catches, and has remained nearly constant since the late 1960s, while both catches and biomasses declined steadily (Figure 14).

How long can this continue? There are no indications in the results of a slowing down in the declining biomass trend. Indeed, the decline was lower during the period up to the peak in catches in 1968, and higher since. The results thus predict that high trophic-level fishes will be all but gone from the North Atlantic region within a few decades if the current trend continues.



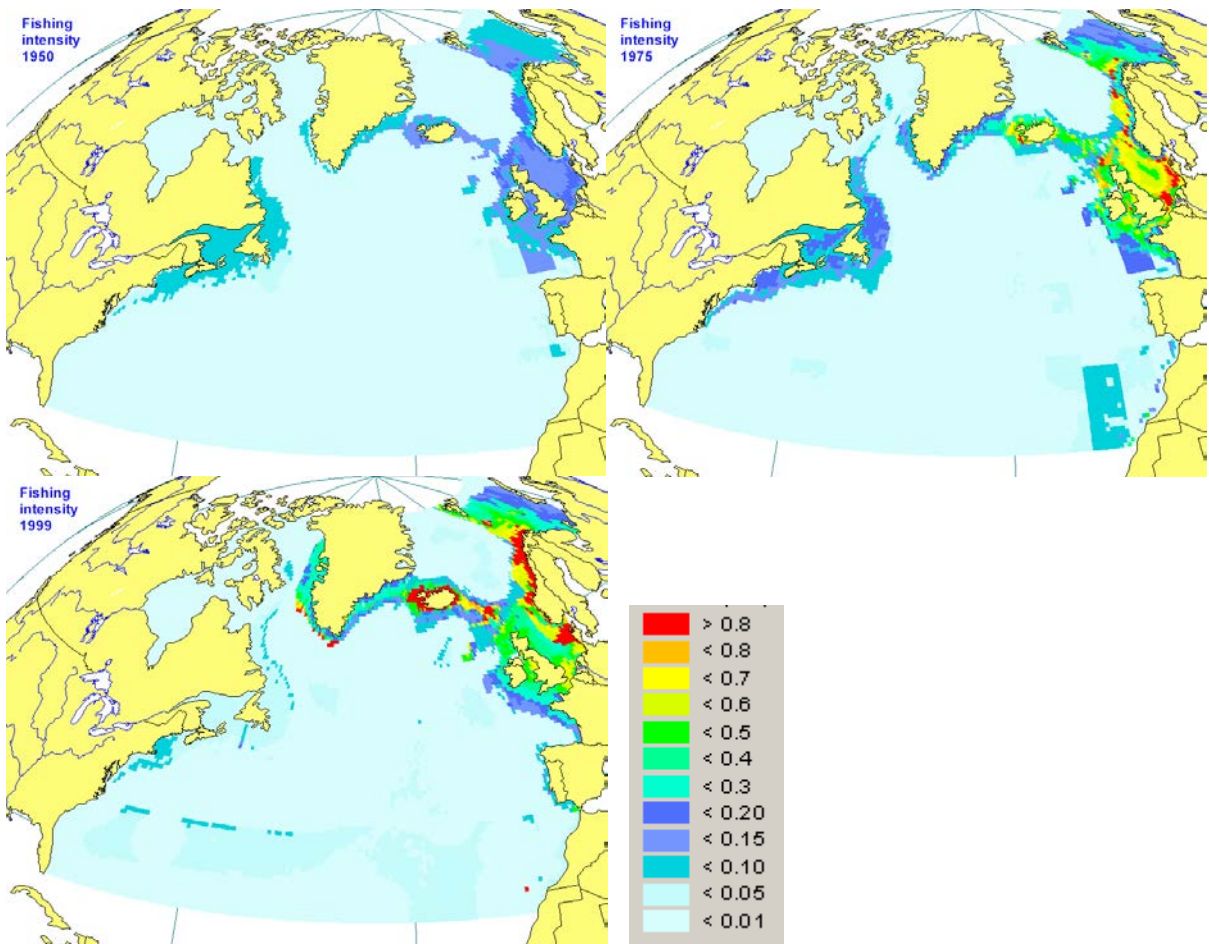

**Figure 13.** Estimated fishing intensity for high trophic-level fishes ( $TL \geq 3.75$ ) in the North Atlantic region in 1950, 1975 and 1999. The fishing effort is derived from spatial estimates of biomasses (Figure 10) and catches (Figure 12). Units for the legend are  $\text{year}^{-1}$ , but the measure should be seen as a relative measure only.

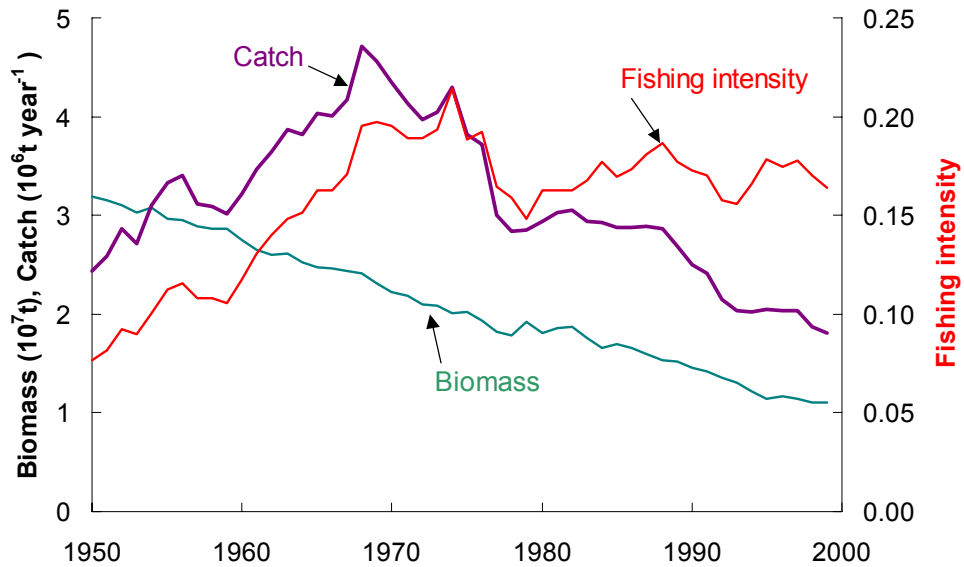

**Figure 14.** Estimated catch ( $10^6$  tonnes-year $^{-1}$ ) and biomass ( $10^7$  tonnes) of high trophic-level fishes in the North Atlantic during 1950-1999. The ratio between catch and biomass is an expression of fishing intensity (Beverton and Holt, 1957).

## DISCUSSION

Overall we estimate that the biomass of high trophic-level fish species in the North Atlantic declined by two-thirds during the second half of the 20<sup>th</sup> century. We should ask then, how reliable is this estimate? We note that the finding seems to be fairly robust to the extent that it did not matter much if we omitted part of the data material on which the estimate is built. However, despite the jackknifing that led to Figure 8, we are at present unable to assign a formal confidence interval to the estimate. It is also a fairly difficult task to find supportive evidence in the form of bottom-up approaches summing up the biomasses of all major fish populations in the North Atlantic. This is reflective of the varying time periods for which assessments have been made for the many populations in the area. Thus, some form of modeling is needed to fill in the blanks, i.e., to provide estimates for the years where none have been made. Also, far from all stocks are being assessed, making a bottom-up estimate likely to be an underestimate.

While waiting for a bottom-up approach, we can examine some trends from various stock assessments in the North Atlantic (Figure 15).

Assembling the plots in Figure 15 was done by going through the majority of the recent stock assessments made for the North Atlantic, and extracting biomass time series for high trophic-level fishes. The most difficult task in doing this was to decide which populations to include here – virtually all showed the same patterns, be it target or non-target species: massive decline during the period for which assessments were made, and a present critical state of the stocks (see Table 6 for an overview of the state of affairs for the majority of the high trophic-level species under ICES auspices). In contrast, there were very few populations that did not show a clear decline (such as, e.g., cod at the Faroe Islands, see Figure 15). Some groups show increases due to what may be replacement or cascading, but these were mainly intermediate trophic-level species; very few high trophic-level species show increase – exceptions may be some small sharks and rays, but for these, it is fairly uncertain whether the mechanism involved is predator removal or simply that more food has been made available, notably in form of the massive discarding that appears to go hand in hand with stock depletions and the subsequent collapses.

**Table 6.** Status of high trophic-level fish stocks in the Northeastern Atlantic according to the ICES Advisory Committee for Fisheries Management (ACFM, 2001). Only two smaller stocks (of saithe) are considered within safe biological limits (SBL).

Species	Area	State of stock/exploitation
Cod	NE Arctic (I, II)	Stock is outside of SBL
Cod	Norwegian coastal	Spawning stock is at a historical low
Saithe	NE Arctic (I, II)	Stock within SBL following good year classes
Redfish	NE Arctic (I, II)	Stock considered outside SBL
Greenland halibut	NE Arctic (I, II)	Stock considered outside SBL
Cod	Greenland (XIV, NAFO 1)	Stock is outside SBL
Cod	Icelandic waters (Va)	Stock near historic low
Greenland halibut	Greenland (V, XIV)	Stock harvested outside SBL
Saithe	Icelandic waters (Va)	Stock considered outside SBL
Cod	Faroe Plateau (Vb1)	Stock harvested outside SBL
Haddock	Faroe (Vb)	Stock outside SBL
Saithe	Faroe (Vb)	Stock harvested outside SBL
Cod	West of Scotland (VIa)	Stock remains outside SBL
Haddock	West of Scotland (VIa)	Stock harvested outside SBL
Haddock	Rockall (VIa)	Stock remains outside SBL
Cod	North Sea (IV, VIId, IIIa)	Stock outside SBL
Haddock	North Sea (IV, IIIa)	Stock being harvested outside SBL
Saithe	North Sea (IV, IIIa, VI)	Stock is within SBL
Anglerfish	North Sea (IV, VI)	Stock is harvest outside of SBL
Cod	Kattegat (IIIa)	Stock considered outside SBL
Cod	Kattegat (IIIa)	Stock considered outside SBL
Cod	Irish Sea (VIIa)	Stock remains outside of SBL
Haddock	Irish Sea (VIIa)	Stock harvested outside of SBL
Whiting	Irish Sea (VIIa)	Stock remains outside of SBL
Cod	VIIe-k	Stock outside of SBL
Hake	Southern (VIIx, IXa)	Stock outside SBL
Hake	Northern (IIIa, IV, VI, VIII, VIIIa,b,d)	Stock is outside SBL

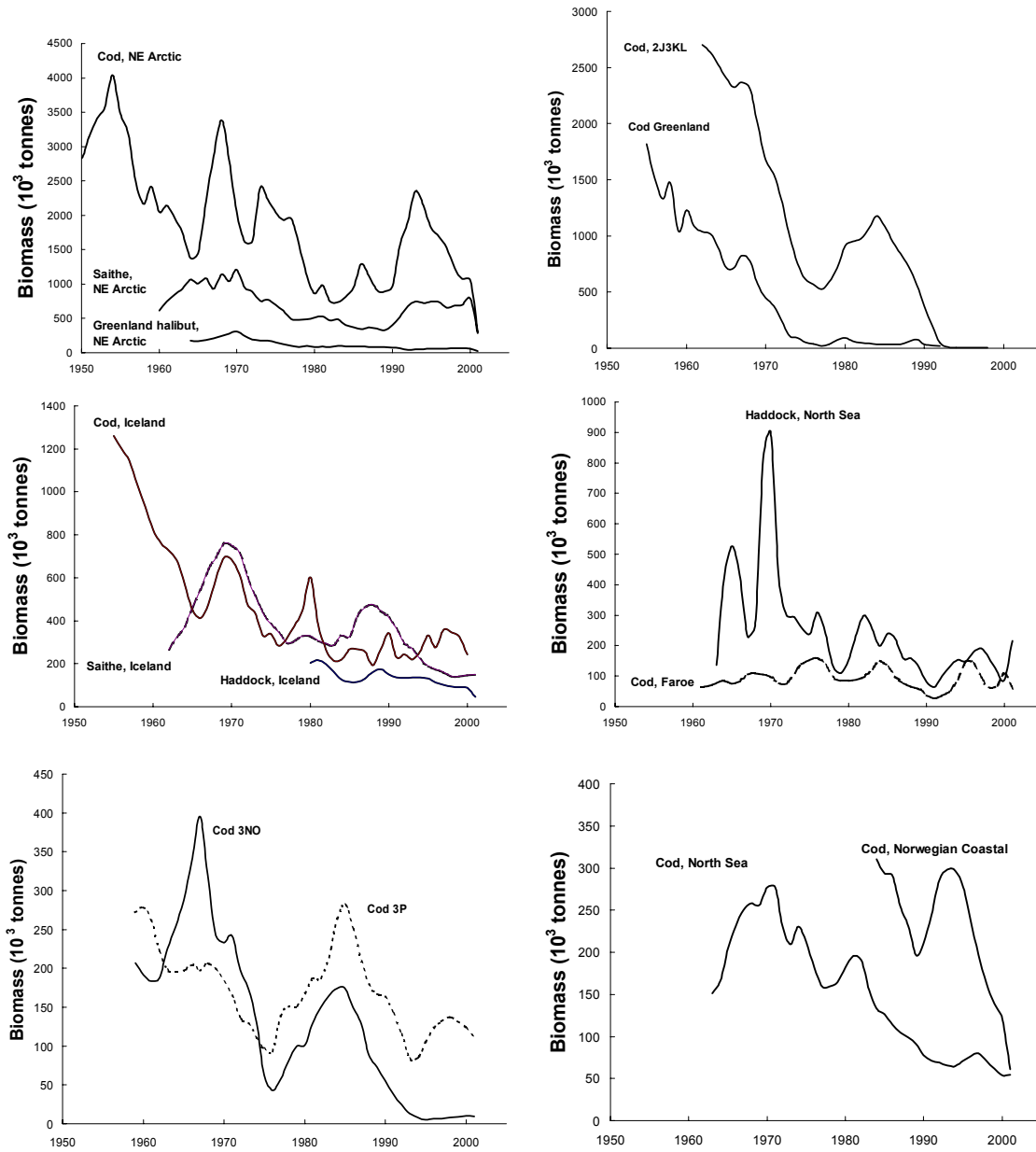

**Figure 15.** Trend over time (1950-2001) in biomass (thousand tonnes) of a variety of high trophic-level fish stocks in the North Atlantic. Based on ACFM (2001), Lilly *et al.* (1998), Lilly *et al.* (2001), NAFO (2000), Anon. (2001a), Bratley *et al.* (2000), O'Brien and Munroe (2001) and ICCAT (2001).

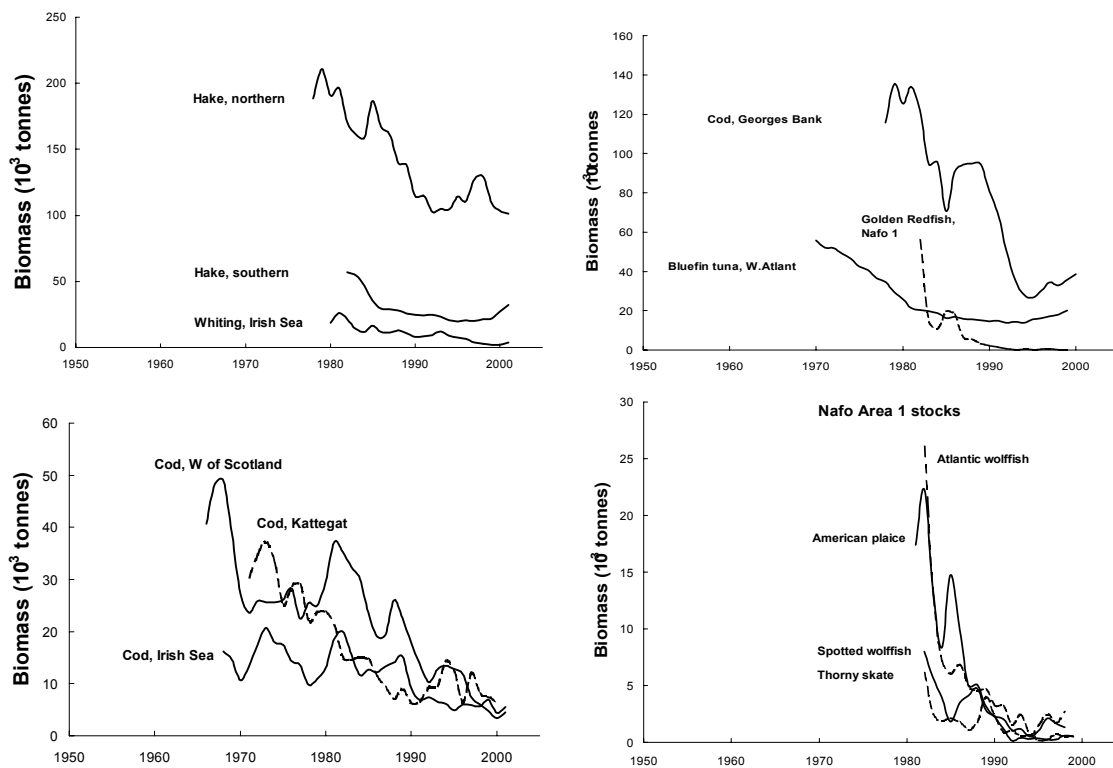

Figure 15. Cont.

The pattern that seems to emerge when examining biomass trends for a variety of North Atlantic fish populations is one of massive decline, indicating that the decline over time we estimated in this study is at least a feasible scenario. This is also the conclusion reached when examining the trends for the high trophic-level species included in the stock-recruitment database assembled by R. Myers (available at <http://fish.dal.ca/~myers/welcome.html>), as indicated in Figure 16, which gives a summary of the trends for a large number of populations from the database.

Our study indicates that fishing intensity in the North Atlantic increased through the 1950s and 1960s, and has remained at what appears to be an unsustainably high level ever since. For comparison, the trend for fishing mortality in 35 populations in the North Atlantic based on stock assessments is compared to the fishing intensity from our study (Figure 14) in Figure 17. We conclude from the graph that the two sets of fishing intensity, (i.e., mortality) bear much similarity.

Several observations require mentioning when examining Figure 17; one is the different scaling of the two Y-axes. Fishing intensity is calculated as the annual catch over the biomass, and while our study indicates a ratio approaching 0.20

year<sup>-1</sup>, the indications of fishing mortalities from the assessments are three times higher. This indicates that the biomasses we estimate are considerably higher than those originating from averaging over the assessed stocks. This apparent difference may have several causes, of which two bare mentioning. First is that only some populations are subject to stock assessment, and these tend to be the ones with highest exploitation rates. Secondly, biomass estimates based on regressions with log-transformations are quite uncertain, and indeed, we trust the trend in biomass more than the face value of the estimates. We do not know, at present, which of the two explanations contribute most toward an explanation, but we do expect both factors to be contributing.

We are aware that the mean fishing intensity of assessed stocks presented in Figure 17 should not be interpreted as the mean fishing intensity for high trophic-level fish in the North Atlantic. For this, the fishing intensities should have been weighted according to population sizes. However, our intention is rather to discover something about the average population – since the measure of fishing intensity is calculated as catch over biomass, it is a measure of exploitation rate and, as such, an ecologically more representative measure.

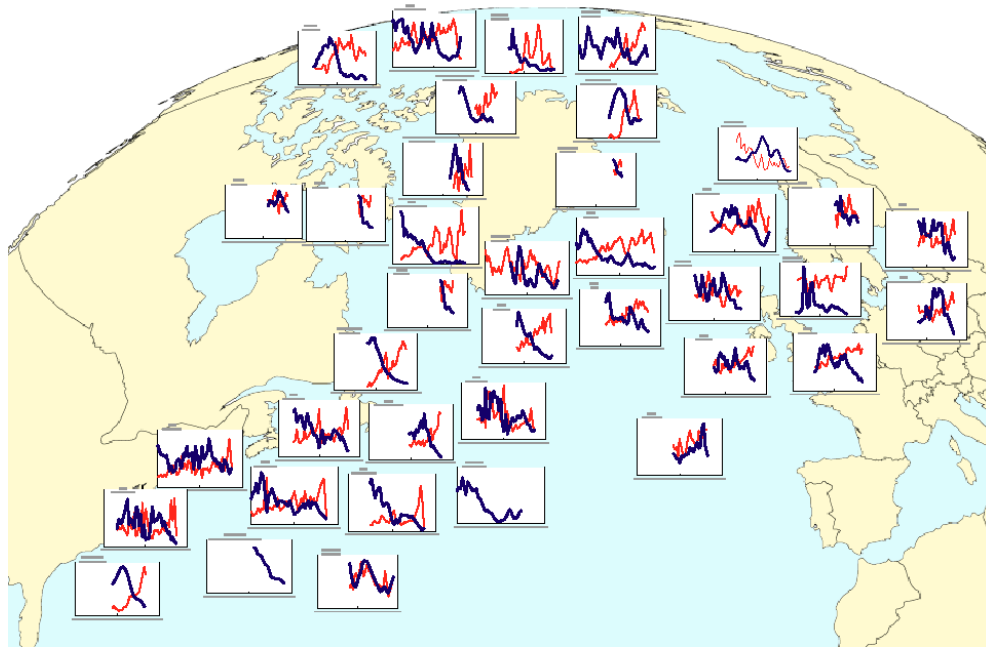

**Figure 16.** Trend over time in biomass (thick, dark lines) and fishing effort (thin lines) from assessments of major resource species in the North Atlantic, including many of the commercially important, high trophic-level species that are the focus of this study. The horizontal axes span the second half of the 20<sup>th</sup> Century. The general trend of decreasing biomasses and increasing fishing effort is in line with the findings reported here. Based on data from the database assembled by R. Myers (<http://fish.dal.ca/~myers/welcome.html>).

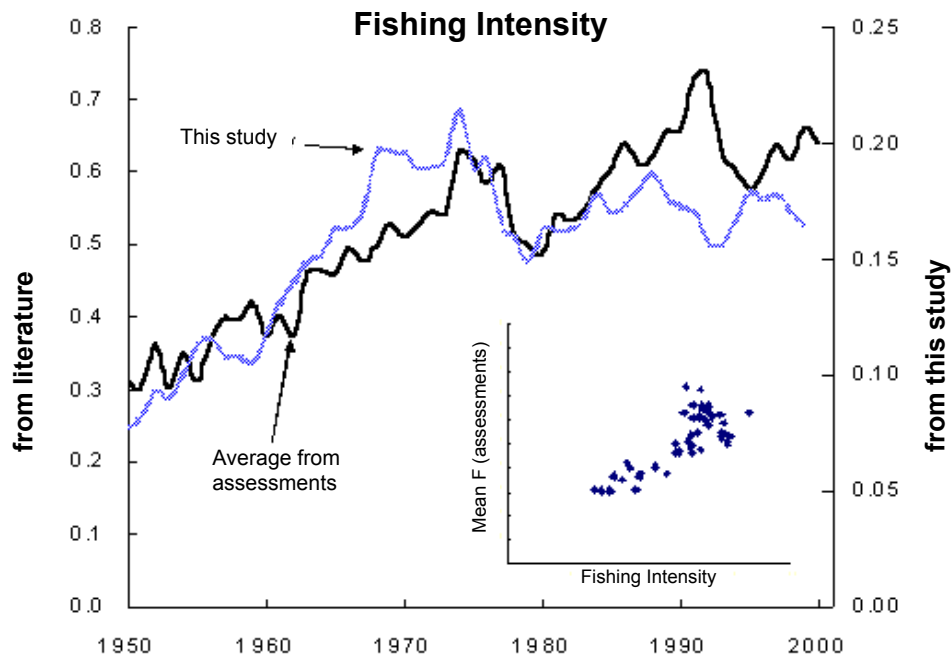

**Figure 17.** Trend in fishing intensity (mortality) for assessments of 35 populations of high trophic-level fish species from the North Atlantic, (solid line, primary Y-axis, year<sup>-1</sup>). These fishing intensity rates are from the same sources as the biomasses in Figure 15. The lighter thick line (secondary Y-axis, year<sup>-1</sup>) indicates the fishing intensity from the present study (Figure 14). The insert shows the series of fishing intensity plotted versus each other, with the values from this study on the X-axis.

The maps and figures presented here indicate that fishing intensity and catch levels have been higher in the Northeastern Atlantic than in the Northwestern Atlantic. Yet, the decline in biomass of high trophic-level fish has been most severe in the northwestern part of the basin. This may seem inconsistent, but may well result from the waters of the northwest being colder, deeper, and less productive than in the northeast, i.e., that the New World waters are less resilient to fishing pressure than those in the Old World. The maps of hydrographic and productivity patterns in Figure 5 lends some credibility to such a hypothesis. If this observation has any merit, it means that care should be exercised when transferring experience on managing Northeastern Atlantic stocks to the Northwestern Atlantic.

We were in the present study not able to reliably estimate the abundance of forage fishes, and chose to omit these from the results. This is reflective of our limited knowledge of these groups, and is indicative of fisheries science focusing on the exploited target species, and largely ignoring the ecology of the systems on which the fisheries rely.

Ecosystem models may indeed help one to draw inferences about prey abundance from predator demand. We can conclude that if the biomasses of predatory fishes were indeed much higher in past ecosystems (as all evidence points to) they must have been consuming more than today's impoverished fauna would lead one to think. However, we do not know if this demand was met by a higher biomass of the forage species and/or by higher mortality rates for the groups. On the other hand, we can be certain that the product of these two, i.e., the production of prey species must have been higher. We note in passing that there are ways of obtaining supporting evidence – egg and larval surveys have been conducted for a century, and even if they were rather sporadic in the early part of the 20<sup>th</sup> Century, there is a widespread coverage of standardized egg surveys from the 1960s through to the 1980s. Unfortunately, the surveys have typically focused on target species only, and the eggs or larvae of the species of lower trophic-level species may not have been analyzed. Since the samples are stored in many laboratories, it is at least in principle still possible to obtain such information given sufficient interest and resources. Another source of evidence may come from the size compositions of forage species from 'old' diet composition studies of predatory fishes. Based on the size distributions, mortality rates can be estimated

given growth parameters (which are readily available, e.g., from FishBase). However, old diet compositions studies have a tendency to focus on presence or absence, and not much on prey size compositions.

We have developed and applied a methodology to assess the state of the high trophic-level fish populations of the North Atlantic, and have concluded that the biomass of these commercially and ecologically important species are dwindling rapidly. We stress that what happens to the high trophic-level species serves as an indicator for what we do to the ocean, and hence we conclude that all is not well with the ocean.

#### ACKNOWLEDGEMENTS

This contribution is a result of the *Sea Around Us* project ([www.fisheries.ubc.ca/projects/saup](http://www.fisheries.ubc.ca/projects/saup)) initiated and funded by the Pew Charitable Trusts ([www.pewtrusts.com](http://www.pewtrusts.com)). Dr. Joshua S. Reichert, Director of the Environment program of the Trusts posed several challenges to us in the conceptualization phase of the project, including the question: "What is the health status of the North Atlantic?" It is the quest to answer his question that lead to this publication.

Carl Walters and Daniel Pauly acknowledge support from Canada's National Scientific and Engineering Research Council. We thank Alida Bundy, Nicolas Hoepffner, Paul Fanning, George Lilly, Ransom Myers, Don Stansbury, Rashid Sumaila, Hreiðar Valtýsson, and other colleagues for making data available, and helping us access and/or interpret it. We thank Tony Smith for providing useful comments on the manuscript.

#### REFERENCES

- ACFM, 2001. Report of the ICES Advisory Committee on Fisheries Management.
- Anon., 2001a. Report of the North-Western Working Group. ICES, CM 2001/ACFM:20.
- Anon., 2001b. S-Plus 6 for Windows Guide to Statistics, Volume 1. Insightful Corporation, Seattle, WA.
- Baird, D., and Ulanowicz, R. E. 1989. The seasonal dynamics of the Chesapeake Bay ecosystem. *Ecological Monographs*, 59(4):329-364.
- Behrenfeld, M. J., and Falkowski, P. G. 1997. Photosynthetic rates derived from satellite-based chlorophyll concentration. *Limnology and Oceanography*, 42:1-20.
- Beverton, R. J. H., and Holt, S. J., 1957. *On the dynamics of exploited fish populations*. Chapman and Hall, London., 533 pp.
- Blalock, H. M., 1972. *Social Statistics*. McGraw-Hill, New York. 583 pp.
- Brattey, J., Cadigan, N. G., Lilly, G. R., Murphy, E. F., Shelton, P. A., and Stansbury, D. E., 2000. An assessment of

- the cod stock in NAFO Subdiv. 3Ps in October 2000. DFO Canadian Stock Assessment Secretariat, Research Document 2000/134.
- Bundy, A., Lilly, G., and Shelton, P. A., 2000. A mass balance model of the Newfoundland-Labrador Shelf. Canadian Technical Report of Fisheries and Aquatic Sciences 2310.
- Carscadden, J. E., Frank, K. T., and Leggett, W. C. 2001. Ecosystem changes and the effects on capelin (*Mallotus villosus*), a major forage species. Canadian Journal of Fisheries and Aquatic Sciences, 58(1):73-85.
- Christensen, V. 1995. A model of trophic interactions in the North Sea in 1981, the Year of the Stomach. Dana, 11(1):1-28.
- Christensen, V. 1996. Managing fisheries involving predator and prey species. Reviews in Fish Biology and Fisheries, 6(4):417-442.
- Christensen, V., and Pauly, D. 1998. Changes in models of aquatic ecosystems approaching carrying capacity. Ecological Applications, 8(1):S104-S109.
- Christensen, V., and Walters, C. J., 2000. Ecopath with Ecosim: methods, capabilities and limitations. pp 79-105. In: Methods for assessing the impact of fisheries on marine ecosystems of the North Atlantic. Ed. by D. Pauly and T. J. Pitcher. Fisheries Centre Research Report 8(2).
- Cole, K. C., 1998. The universe and the teacup: The mathematics of truth and beauty. Harcourt Brace and Co., New York. 214 pp.
- Daskalov, G. M. 2002. Overfishing drives a trophic cascade in the Black Sea. Marine Ecology Progress Series, 225:53-63.
- Heymans, J.J. in prep.a). A Picasso-esque view of the marine ecosystem of Newfoundland and southern Labrador in 1500 and 1900. In: Ecosystem Models of Past and Present in the Hecate Strait and Newfoundland Shelf. Ed. by J. J. Heymans, C. Ainsworth, and T. J. Pitcher, Fisheries Centre Research Reports.
- Heymans, J.J. in prep.b) The marine ecosystem of Newfoundland and southern Labrador (2J3KLNO) in 1985-1987 and 1995-1997. In: Ecosystem Models of Past and Present in the Hecate Strait and Newfoundland Shelf. Ed. by J. J. Heymans, C. Ainsworth, and T. J. Pitcher, Fisheries Centre Research Reports.
- Hoepffner, N., Bouvet, M., and Mélin., MS, F., Global marine primary production from space. Joint Research Center of the European Commission, (nicolas.hoepffner@jrc.it)
- ICCAT, 2001. Report of the ICCAT SCRS. West Atlantic Bluefin tuna stock assessment session, (Madrid, Spain - September 18 to 22, 2000). Detailed Report.
- Kaschner, K., Watson, R., Christensen, V., Trites, A. W., and Pauly, D., 2001. Modeling and Mapping Trophic Overlap between Marine Mammals and Commercial Fisheries in the North Atlantic. pp 35-45. In: Fisheries Impacts on North Atlantic Ecosystems: Catch, Effort, and National and Regional Data Sets. Ed. by D. Zeller, R. Watson, and D. Pauly, Fisheries Centre Research Report 9(3).
- Lilly, G. R., Shelton, P. A., Brattey, J., Cadigan, N., Murphy, E. F., Stansbury, D. E., Davis, M. B., and Morgan, M. J., 1998. An assessment of the cod stock in NAFO Divisions 2J+3KL. DFO Canadian Stock Assessment Secretariat, Research Document 98/15. 102 pp.
- Lilly, G. R., Shelton, P. A., Brattey, J., Cadigan, N. G., Healey, B. P., Murphy, E. F., and Stansbury, D. E., 2001. An assessment of the cod stock in NAFO Divisions 2J+3KL. DFO, Canadian Stock Assessment Research Document 2001/044.
- NAFO, 2000. Report on Standing Committee on Fisheries (STACFIS), June 2000.
- O'Brien, L., and Munroe, N. J., 2001. A Report of the 4th Transboundary Resources Assessment Committee Meeting Assessment of the Georges Bank Atlantic Cod Stock for 2001. Northeast Fisheries Science Center, Reference Document 01-10.
- Pace, M. L., Cole, J. J., Carpenter, S. R., and Kitchell, J. F. 1999. Trophic cascades revealed in diverse ecosystems. Trends in Ecology & Evolution, 14(12):483-488.
- Pauly, D. 1995. Anecdotes and the shifting baseline syndrome of fisheries. Trends in Ecology & Evolution, 10(10):430.
- Pauly, D. 1996. One hundred million tonnes of fish, and fisheries research. Fisheries Research (Amsterdam), 25(1):25-38.
- Pauly, D., Christensen, V., Dalsgaard, J., Froese, R., and Torres, F., Jr. 1998. Fishing down marine food webs. Science, 279(5352):860-863.
- Pauly, D., Christensen, V., and Walters, C. 2000. Ecopath, Ecosim, and Ecospace as tools for evaluating ecosystem impact of fisheries. ICES Journal of Marine Science, 57(3):697-706.
- Pauly, D., and Palomares, M. L. D., MS, Fishing down marine food web: it is far more pervasive than we thought. Presented at the Conference of Sustainability of Fisheries, held on November 26-28, 2001 at the Rosenstiel School of Marine Sciences, University of Miami.
- Pauly, D., and Pitcher, T. J., 2000. Assessment and Mitigation of Fisheries Impacts on Marine Ecosystems: A Multidisciplinary Approach for Basin-Scale Inferences, Applied to the North Atlantic. pp 1-12. In: Methods for assessing the impact of fisheries on marine ecosystems of the North Atlantic. Ed. by D. Pauly and T. J. Pitcher. Fisheries Centre Research Report 8(2)
- Pinnegar, J. K., Polunin, N. V. C., Francour, P., Badalamenti, F., Chemello, R., Harmelin-Vivien, M. L., Hereu, B., Milazzo, M., Zabala, M., D'Anna, G., and Pipitone, C. 2000. Trophic cascades in benthic marine ecosystems: lessons for fisheries and protected-area management. Environmental Conservation, 27(2):179-200.
- Sokal, R. R., and Rohlf, F. J., 1995. Biometry: The Principles and Practice of Statistics in Biological Research. W. H. Freeman Company, 877 pp.
- Sumaila, U. R., and Watson, R., 2001. Mapping catch values from marine ecosystems with emphasis on the North Atlantic. pp 12-17. In: Fisheries impact on North Atlantic marine ecosystems: Catch, effort and national and regional data sets. Ed. by D. Zeller, R. Watson, and D. Pauly, Fisheries Centre Research Report 9(3).
- Walters, C., Christensen, V., and Pauly, D. 1997. Structuring dynamic models of exploited ecosystems from trophic mass-balance assessments. Reviews in Fish Biology and Fisheries, 7(2):139-172.
- Walters, C., and Kitchell, J. F. 2001. Cultivation/depensation effects on juvenile survival and recruitment: implications for the theory of fishing. Canadian Journal of Fisheries and Aquatic Sciences, 58:39-50.
- Walters, C., Pauly, D., and Christensen, V. 1999. Ecospace: Prediction of mesoscale spatial patterns in trophic relationships of exploited ecosystems, with emphasis on the impacts of marine protected areas. Ecosystems, 2(6):539-554.
- Walters, C., Pauly, D., Christensen, V., and Kitchell, J. F. 2000. Representing density dependent consequences of life history strategies in aquatic ecosystems: EcoSim II. Ecosystems, 3(1):70-83.
- Watson, R., Gelchu, A., and Pauly, D., 2001. Mapping fisheries landings with emphasis on the North Atlantic. pp 1-11. In: Fisheries impact on North Atlantic marine ecosystems: Catch, effort and national and regional data sets. Ed. by D. Zeller, R. Watson, and D. Pauly. Fisheries Centre Research Report 9(3).
- Watson, R., and Pauly, D. 2001. Systematic distortions in world fisheries catch trends. Nature, 424:534-536.

## ECOSYSTEMS OF THE PAST: HOW CAN WE KNOW SINCE WE WEREN'T THERE?

**Villy Christensen**

Fisheries Centre, University of British Columbia  
2204 Main Mall, Vancouver, BC, Canada, V6T 1Z4  
e-mail: v.christensen@fisheries.ubc.ca

### ABSTRACT

Most reconstructions of historic abundances for marine organisms have been done on a species by species basis. It is argued here that assembling such reconstructions and working at the ecosystem level makes it more feasible to evaluate the consistency of historic estimates. If we construct ecosystem models of past ecosystems based on present ecology and historic exploitation patterns, we can use information about system form and function to evaluate past abundances. This can in turn be used to describe the parts of the systems for which we do not have information. A modeling approach, Ecopath, which has been used for such ecosystem reconstructions is presented, and it is discussed how it can be used for historic and pre-historic reconstructions. Application is exemplified through a case study of the Strait of Georgia ecosystem, British Columbia, Canada, where ecosystem models were constructed to represent the present, a hundred, and five hundred years ago. The model construction was part of a multidisciplinary project, including fisheries ecologists, marine historians, archaeologists, economists, along with fishers and others with local knowledge of a system and its history who, jointly parameterized, evaluated and discussed the models and the ecosystems they represented. The reconstruction serves to provide a baseline for evaluation of present day ecosystems and the human impact on these.

### INTRODUCTION

Humans have exploited the living resources of the seas for thousands of years and have altered their ecosystems throughout this period (see Pitcher, 2001, for a recent review). Information about past ecosystem composition is sparse as quantitative information on marine populations rarely go back more than a few decades, or in the form of time series of catches a few hundred years at the best.

Human exploitation tends to remove top-predators through 'fishing down the food web'

eventually leading to a concentration on prey species (Pauly *et al.*, 1998a). Where we have time series spanning the history of exploitation, we often find that the abundance of upper trophic level species decrease with 1-2 orders of magnitude (MacIntyre *et al.*, 1995), e.g., in the Gulf of Thailand where the depletion of the resources was relatively well described (Christensen, 1998). Often, however, we do not have time series at our disposal, and humans tend to evaluate based on personal impressions, not on records from the past. This leads to a 'shifting baseline' syndrome (Pauly, 1995), which has implications for how fisheries management is viewed. Where it in general has been appropriate to focus on 'sustainable development' for humans, this goal is not necessarily appropriate for marine ecosystems. The overwhelming majority of marine populations are severely depleted (Ludwig *et al.*, 1993), and focusing on how to sustain such depleted states is shortsighted. Instead focus should be on rebuilding ecosystems as a new goal for fisheries management (Pitcher and Pauly, 1998). The question then becomes, how can we then know what it is we want to reconstruct, i.e., what was out there before we started fishing?

As a starting point recall the ecology textbooks from our university days. Eugene P. Odum (1971) in his 'Fundamentals of Ecology' described how ecosystems develop over time. An example could be a clear-cut, nutrient-rich meadow in a temperate climate zone; depending on conditions such a system may develop into a full-grown deciduous or conifer forest in the course of a few hundred years. The development is not deterministic, but depends on chance and circumstances; still, we have expectations to how the forest may look over time from now and for hundred of years to come, given that we leave it to itself, and that there are enough bits of forests around to supply seeds.

In a similar way we have expectations to how marine ecosystems may develop if we leave them undisturbed for a length of time. Such expectations build on how ecosystems 'mature' over time. Quantifying a series of ecosystem indices (see Table 1), Christensen (1995) ranked 41 published mass-balance models of aquatic ecosystems in term of their maturity *sensu* Odum. The study included representations of ecosystems before and after a major disturbance, and it was concluded that disturbance tend to lead to a decrease in system maturity.



**Table 1.** Major tendencies describing the development incurred during ecosystem development, based on a selection of Odum's (1969) 24 attributes of maturity. These ecosystem indices can all be quantified using the Ecopath model.

<b>Ecosystem attributes</b>	<b>Developmental stages</b>	<b>Mature stages</b>
Gross production/biomass	High	Low
Biomass supported / energy flow	Low	High
Total organic matter	Small	Large
Niche specialization	Broad	Narrow
Size of organism	Small	Large
Mineral cycles	Open	Closed
Nutrient exchange rate, between organisms and environment	Rapid	Slow
Role of detritus in nutrient cycling	Unimportant	Important
Nutrient conservation	Poor	Good

Our knowledge of past systems is indeed incomplete, and we therefore need to utilize the circumstantial evidence that may be available. An important part of this may come from considerations of ecosystem maturity. We can assume undisturbed ecosystem to be mature *sensu* Odum. The implications of this are that all niches should be filled; that a major part of the energy flows should be through detritus-based food webs; that primary production should be efficiently utilized; that the total system biomass/energy throughput ratio should be high, etc. (Christensen and Pauly, 1998). Based on this and on an assumption of mass-balance, i.e., where the available prey production has to meet the food required by predators, and on whatever information may be available from historical sources on past exploitation and its resource base, we can assemble a picture of the ecosystem as it may have been. Further, by using a variety of tools, we can validate that the picture is indeed consistent with the available information and constraints set by resource ecology and thermodynamics.

Reconstruction as outlined here relies on an ecological modeling approach, which will be described in more detail below. Its use will further be demonstrated using the Strait of Georgia, British Columbia, Canada, as an example of how models of past ecosystems can be constructed. Model construction relies heavily on input from a diverse array of sources, including fisheries ecologists, marine historians, archaeologists, economists, along with fishers and others with local knowledge of a system and its history. As such, it is one of a few existing methodologies where multi-disciplinarity is a requirement and not just wishful thinking.

## ECOSYSTEM MODEL CONSTRUCTION AND EVALUATION

### Mass-balance modeling: Ecopath

The approach described here for reconstruction of ecosystems relies heavily on mass-balance ecosystem modeling. This implies the main assumption (or truism) that the energy uptake for a given ecosystem group has to balance the energy expenditure. For any given group this can be expressed:

$$\text{Consumption} = \text{production} + \text{respiration} + \text{unassimilated food} \quad \dots 1)$$

We may in turn express the production term of this equation as:

$$\text{Production} = \text{predation} + \text{catch} + \text{migration} + \text{biomass accumulation} + \text{other mortality} \quad \dots 2)$$

These equations serve as the backbone (master equations) for an ecosystem modeling approach and software called Ecopath with Ecosim (Christensen and Pauly, 1992; Pauly *et al.*, 2000), which has been widely used for modeling of marine ecosystems over the past decade. In total more than 2500 scientists in 125 countries have registered as users of the software (freely distributed through [www.ecopath.org](http://www.ecopath.org)), and some 150 models have so far been published based on the approach. In the Ecopath approach, the second master equation is used to link predator and prey based on the fact that the

predation term can be calculated as the sum of the consumption by all predators.

If we as an example know that a top predator consumes  $10 \text{ t}\cdot\text{km}^2\cdot\text{year}^{-1}$  based on its biomass and consumption rate, and if we from diet studies know that this consists of, say, 40% zooplankton and 60% anchovies, we can calculate that the top predator will consume  $6 \text{ t}\cdot\text{km}^2\cdot\text{year}^{-1}$  of anchovies. This information, derived independently of the information we may have on anchovy production can be used as an element in the second master equation to estimate the total production of anchovies.

If we describe all groups in an ecosystem, and we know all catches, etc., we can set up a set of linear equation corresponding to Equation 2. With perfect knowledge, this gives us  $n$  equations (if there are  $n$  groups in the system) with no unknown parameters. The system of equations would be overdetermined. In the real world we do not have perfect knowledge, and we instead can leave one of the parameters in Equation 2 as unknown for each group in the ecosystem. This leads to  $n$  equations with  $n$  unknown.

The unknown parameter for each equation, (i.e., for each ecosystem group) can in theory be any of the terms in Equation 2. Most application of Ecopath so far have, however, set the parameter for which we have least knowledge and least possibility of estimation to be the unknown. The parameter in question is the term called 'other mortality', which describes the production terms not covered by the other terms of the equation, e.g., mortality due to disease or old age. The other mortality will be a small term in most cases, and where we do not have information about either the biomass, production or consumption rate of a group, we can leave such a parameter as unknown, and input an assumed value for other mortality, (e.g., 5% of production). The Ecopath software will then balance all the flows in the system and in the process calculate whatever parameter has been left unknown for each group. The result is that we always end up with a balanced model of the flows in the ecosystem, even if we do not know everything about all parts of the system. [Note that in practice, other mortality is related to 1-EE, with EE being the 'ecotrophic efficiency', see the contributions in this volume].

The mass-balance constraint should, as hinted to above, not really be seen as a questionable assumption but rather as a filter. One gathers all possible information about the components of an ecosystem, of their exploitation and interaction

and passes them through the 'mass-balance filter' of Ecopath. What comes out in the other end is a possible picture of the energetic flows, the biomasses and their utilization. The more information used in the process and the more reliable the information, the more constrained the picture will be.

If we for example know the biomass and consumption rate of zooplankton, we can calculate how much phytoplankton they require on an annual basis. If we do not have an estimate of primary productivity we have to take the estimate of primary production required to feed the zooplankton at face value and use it as basis for our estimate of the primary production. If, however, we have an estimate of the primary production we can compare demand and supply, and if they do not match, we can start examining the reliability of the estimates in more detail. We would also question if there are other populations in the ecosystems that should be considered. This illustrates that the more information we have, the more constrained our model will be, and the more comfortable we can feel about the predictions that may later originate from the model. It should also be clear that when we compare estimates of demand and supply at the ecosystem level, we add a dimension to the data evaluation process, a dimension that is not addressed when working only at the population level.

### ***Addressing uncertainty***

Some major advantages of the modeling approach outlined above include that it relies on readily accessible data of the type routine gathered and analyzed by fisheries scientists and marine biologists, and also that it is fairly simple to construct a model even if one has only incomplete information about the resources. A consequence of this is that it is in practice always possible to construct an ecosystem model of a given area even in data-sparse situations. But how good is the model then?

There are formal ways of describing the uncertainty involved in the model construction and parameterization. For this Ecopath, relies on two independent, but inter-linked approaches. The first is a module where the pedigree of all the input parameters can be defined (Table 2). Each type of pedigree is associated with a confidence interval, and once the pedigrees have been described a different module applies a Monte-Carlo technique to generate a large number of parameter representations sampling at random from the confidence intervals of the input parameters. Each of the model realizations are

evaluated using a series of mainly physiological constraints, and statistics from the accepted runs are then gathered to derive parameter confidence intervals for input as well as for estimated parameters. Using a sampling-importance-resampling scheme in a Bayesian context, the confidence intervals can be further constrained (McAllister *et al.*, 1994).

Further, a formal sensitivity analysis evaluates all possible input-output combinations highlighting where consideration of input parameter uncertainty is most required. Jointly, these approaches make evaluation of model uncertainty both explicit and transparent, yet it remains a relatively simple and versatile approach.

**Table 2.** Example of options for definition of pedigree for diet compositions in Ecopath. For each group in an ecosystem one of these options is used to define the pedigree of the diet. The confidence intervals (Cf.int.) are default values, and can be changed during input. They are used to describe parameter uncertainty in the balanced ecosystem model.

Option	Cf.int (%)
General knowledge of related group/species	±80
From another model	±80
General knowledge for same group/species	±60
Qualitative diet composition study	±50
Quantitative but limited diet composition study	±30
Quantitative, detailed, diet composition study	±10

### Reconstructing historic states

The starting point for reconstruction of historic states will preferably be based on the present state of the given ecosystem. We have considerable information about global fish resources, their biology and ecology, most notably through database on finfishes called FishBase, available online at [www.fishbase.org](http://www.fishbase.org). Using FishBase, it is possible to extract a list of all species occurring in any given area along with direct access to a good deal of the parameters required for ecosystem modeling. With this background, with information of other key components, (e.g., primary productivity from SeaWIFS data, and on cephalopods from [www.cephbase.org](http://www.cephbase.org)), and with knowledge of the exploitation of the resources (see [www.fao.org](http://www.fao.org) and [www.fishbase.org](http://www.fishbase.org) if local information is not readily available), the foundation for the model construction is laid.

Once the present day model is constructed, the next task is to draw up a list of ecosystem species or groupings for the historic state. This includes considerations of whether there are additional groups to be included or, for that matter, if there may be groups in the present models that have been introduced, or for other reasons may not have been there in past times.

The next step is to gather historic information about utilization and abundance of the ecosystem species or groupings. We may not know very much about the fishing operations of centuries ago, but there are traces left to be picked up – as presented for the Strait of Georgia below (see also Mackinson, this vol.).

Where we can construct time series of human exploitation we have the basic information at hand needed to estimate population sizes using assorted tools from the battery of stock assessment methodologies developed over the past century, see, e.g., Smith (1994), and Hilborn and Walters (1992). With such information construction of ecosystem models using Ecopath becomes straightforward.

The data requirements for the model construction are:

- A list of ecosystem species/groups;
- Historic catch levels and, where available, also size composition of catch;
- Abundance estimates for as many groups as possible;
- Consumption rates for all groups (present day rates acceptable); and
- Diet compositions for all groups (present day diets acceptable).

Ranges are acceptable for all input parameters, apart for time series.

Model construction includes a balancing stage, during which the internal consistency (demand vs. supply, physiological constraints) of the input data is checked in detail. This feeds back to the input data, and serves to identify where there are problems that requires further attention or changes to the input parameters. The resulting model, after having passed the mass-balance filtering procedure, will be internally consistent, and the uncertainty related to all parameters will be explicit.

Once a draft historic model has been constructed, balanced and evaluated, a series of analyses can be conducted to examine compatibility with known time series where such are available. This is done using the time-dynamic simulation model Ecosim (Walters *et al.*, 1997; 2000), which in turn can be used as an extra loop feeding back to the parameterization process described above.

### **Reconstructing the unfished state**

As described above, it is by far the easiest to construct a model when information is sparse – as it will be when dealing with pre-historic states. We are, in such situations, much less constrained by prior knowledge during model construction, but of course it is at the cost of the model being less reliable compared to where we have a richness of information. Let us as an example consider how the ecosystem of the Strait of Georgia may have looked two thousand years ago. How would we go about constructing such a model?

We should first of all consider how the climate might have been: warmer, colder, or similar. Such information is readily available, e.g., from tree growth rings. Based on this we can choose an ecosystem structure that is fitting for the climate, and we can draw up a list of ecosystem groups that may have been present. In addition to extant groups this would include humpback whales, sea otters and Steller sea cows, groups that once served important ecological roles in the Strait. We can assume that there was some fishing in coastal areas, and that this was concentrated on the larger species, that pinnipeds would have been exploited, etc. We can also assume that the biomasses of the top predators would have been considerably higher than presently.

Further, we can assume that the total primary production should have been roughly similar to the current level. This sets a limit for the amount

of basic food that was produced, and hence for how much we can ‘blow’ up the ecosystem, and still have enough to feed the intermediate consumers required to sustain high biomasses of top predators. Obviously, different assumptions would produce different results, and we can through comparisons of the results evaluate how sensitive the findings are to each of the assumptions.

Christensen and Pauly (1998) used a similar approach to estimate how much two present day ecosystem models (of the Gulf of Mexico and the Central Eastern Pacific) could be increased given no fishing and much higher levels of the top predators. They concluded that it would be possible to increase the biomass of top predators by an order of magnitude or more, which in turn would require a six to seven times increase in overall consumer biomass, and that present day primary production would be able to sustain this. Comparing fifteen ecosystem indicators for the two ecosystem states, the present and the pre-historic, they also concluded that all of the indicators pointed to the pre-historic states as being more mature *sensu* Odum (see above) than the present day systems.

A more rigorous form of reconstruction is possible using the Ecosim model of the Ecopath with Ecosim software (see Walters *et al.*, 1997; 1999; 2000). Taking as basis a (historic or present day) model, and adding a very low abundance of groups that would have been present in the pre-historic ecosystem, a simulation can be run where the fishery is reduced to the limited pre-historic level. The simulation is run until a new ecosystem state is reached. This state, in turn, can be output as an Ecopath model and used for comparing with the historic states.

If abundance estimates are available, or can safely be assumed for some groups the simulations can be forced to accommodate these as absolute values, adjusting abundance of all other groups for consistency, but doing so within the limits set by available primary production. Using this approach it is possible to generate a representation of the pre-historic information that is consistent with all available information about the biology and ecology of the ecosystem resources, as well as with what is known of the resource utilization over time.

## RECONSTRUCTION OF ECOSYSTEMS: THE STRAIT OF GEORGIA

The ecosystem used here to exemplify reconstruction of ecosystem is the Strait of Georgia, a semi-enclosed area along the western coast of Canada, several hundred kilometers long and up to fifty kilometers wide. Based on a three-month pilot project followed up by a multidisciplinary workshop, three ecosystem models were constructed (Pauly *et al.*, 1998b) to describe the current state of the Strait of Georgia, how it may have looked a hundred years ago (before the onset of commercial fisheries), and five hundred years ago (before first contact of native people with Europeans and the expansion of the fur trade). Prior to the project, workshop material in form of ecological studies of all important (energetically as well as commercially) fish species as well as of all other important ecosystems groupings, from primary producers to seabirds and whales was collated and analyzed. Information on presence, exploitation and abundance of living organisms were obtained from historical records, newspapers, fisheries statistics, linguistic and archaeological (including petroglyphs and pictographs) studies, and environmental knowledge from aboriginal people and fishers living around the Strait.

The quantitative information gathered was used to prepare initial ecosystem models for the two more recent time periods. A two-day multidisciplinary workshop subsequently reviewed the material and assessed the suitability of the ecosystem models for the reconstruction process. The purpose of the model construction is to describe policy options for management, including an evaluation of the gains that may be obtained from rebuilding the ecosystem populations to levels comparable with the historic baseline values, and comparing this with what may be obtained by preserving the status-quo, which we may call 'sustainability' or 'preserving misery' (Pitcher, 1998).

The methodology for ecosystem reconstruction described here has been under development for several years, and in summary relies on three principal components: (1) identification of data sources and descriptions of stocks, interactions, and exploitation; (2) construction of ecosystem models giving representative time snapshots; and (3) policy exploration for management. These components are described in more detail below.

## INFORMATION SOURCES FOR ECOSYSTEM RECONSTRUCTION

As outlined above the data sources to be used for ecosystem reconstruction are diverse and include information with a high variation in precision and uncertainty. It should be stressed, however, that by using a variety of information and by applying triangulation to the extent possible the consistency of the data can be checked, and this can in turn be used to direct the model building and evaluation by adding measures of uncertainty to all input data irrespective of the source.

For the Strait of Georgia case, and indeed for this type of ecosystem reconstruction in general the types of information introduced below are of interest (Wallace, 1998b).

### Exploitation time series

For marine ecosystems in general the by far most important form of human impact is through fishing, whaling, and other ways of extracting living resources. Information on such extraction is also the most important type of data required for ecosystem modeling, and fortunately enough, it is for many systems possible to create extensive databases documenting the extraction in historical times. In developed countries, fisheries statistics are often available from the second half of the nineteenth century, (even if they may be buried in paper piles, and out of sight for present assessments), while extractions in earlier times may need to be reconstructed based on indirect information.

For the Strait of Georgia, the most valuable source of historical catch information was a series of reports by the regional Inspector of Fisheries, published annually from 1875-1944. The reports described the amount of fish caught, the district where the catches come from, and gave a summary of major events in the fishery for the year. Later catch series mainly came from the publications of the Department of Fisheries and Oceans. In addition, there are a number of published time series for individual species. Figure 1 presents an overview of the species/groups and time periods for which time series were available for the Strait, and is intended to demonstrate that a variety of sources are indeed available, and that these together gives information about a good deal of the ecosystem resources.

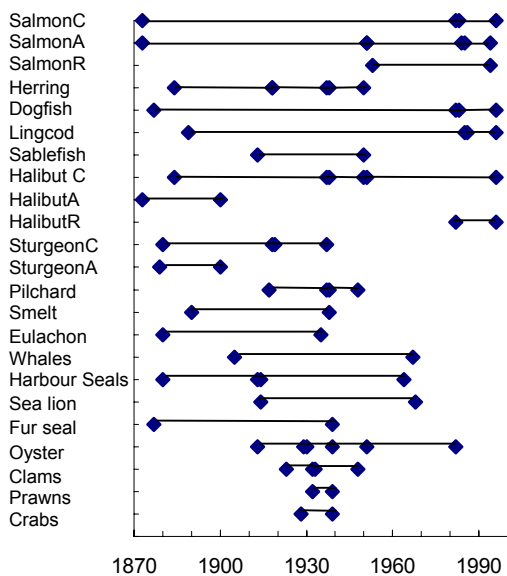

**Figure 1.** Overview of time series used for reconstruction of the Strait of Georgia ecosystem. ‘C’ indicates commercial, ‘A’ aboriginal, and ‘R’ recreational fishery. Based on Wallace (1998a; 1998b).

Once time series for the exploitation of the commercially important populations have been assembled it is possible to use standard fisheries assessment techniques to obtain population stock estimates, e.g., using virtual population analysis or age synthesis models. Stock estimates are of importance as input parameters for the ecosystem models.

### Historical and archeological sources

Explorers tend to describe what they see, and later readers often try to discredit what may seem incredible abundances. Some for example have wondered if Eric the Red excelled in Public Relation or whether the climate of ‘Greenland’ was different when he advertised. Many will tend to buy the PR explanation, if only due to the “shifting baseline syndrome” described by Pauly (1995). However, historic accounts, carefully evaluated, may indeed be used to evaluate past distributions and abundances.

Where accounts give details of exploitation, e.g., the amount extracted using a given gear in a given time, or abundances in the form of sightings per time, (e.g., for birds or marine mammals), it is possible to use standard fisheries assessment methodologies to derive estimates of catches or abundances (see, e.g., Jackson *et al.*, 2001). These in turn may be useful for ‘anchoring’ other parts of the ecosystems as described in more detail below.

The most important source about historic diets comes from archaeological studies of middens. In the Strait of Georgia these have for instance shown that salmon and shellfish were the most important seafood for the native populations, and also that bluefin tuna in prehistoric time were caught in the Strait (Mitchell, 1988).

An additional historical source exists along the coast of British Columbia in form of petroglyphs and pictographs created by native or ‘First Nation’ people. As described by Williams (1998), petroglyphs and pictographs may be used to provide information of human interaction with animal and fishes over a long time span. Indications are that the images may be coded using a coherent visual language, a language now forgotten, but perhaps open to decoding.

### Printed media

For the reconstruction of the Strait of Georgia ecosystem, newspapers from the late 1800s proved a valuable source. Most notably, the whaling industry was regularly described, and an estimate of the whale populations of the strait was obtained from these sources. Further, photographs were used to provide information about presence of certain species in the area, and in the case of rockfish (*Sebastes* spp.), even to produce an estimate of catch per fisher per hour, i.e., catch per unit effort or CPUE.

Printed maps and charts provided information about past occurrences and importance of ecosystem groupings, e.g., ‘Porpoise Bay’ indicating the porpoise may have once been abundant in a given area. Where cross-validation of sources is possible, i.e., where several independent sources are consistent, this form of information may be used to indicate that a group was present and probably abundant, and that it should therefore be included in historic ecosystem models for the area under consideration.

### Traditional environmental knowledge

An important part of the Strait of Georgia project was to combine quantitative information about ecosystem resources with traditional aboriginal knowledge, and to use this combination to improve the ecosystem models. As part of this a series of interviews were held with First Nation elders to describe the activity, and to obtain information about the ecosystems and their exploitation (Salas *et al.*, 1998).

The interviews focused on deriving information about what the main resources in the Strait of Georgia were, and whether these resources were exploited. A species list was drawn up prior to the interviews, and the elders were questioned about each of the species included. Information about the fisheries focused on their intensity, on their character (commercial vs. subsistence), and on whether there were any management systems and trading networks in place. Also, information was sought about population size and the level of consumption of marine resources, along with information about observed changes in their abundance and the potential causes. The interviews confirmed that the First Nation people have considerable knowledge of their environment, and that such knowledge can indeed be of use for improving the understanding of the ecosystems and their use.

### Information synthesis and evaluation

The Strait of Georgia project started out by gathering the information introduced above, and subsequently two initial ecosystem models were constructed to describe the present state and the state prior to the expansion of commercial fisheries, i.e., of the late 19<sup>th</sup> Century. With this as background material, a two-day workshop was held with participants from a variety of disciplines and with the purpose of discussing species abundance at present, a hundred years ago, and five hundred years ago, before the expansion of the fur trade.

The workshop started out with presentations of the methodology, of the draft ecosystem models and their assumption, of factors contributing to environmental regime shifts, of oral traditions and cultural protocols among First Nations, of resource abundance and development of fisheries, and an evaluation of past salmon abundance. As conveyed through this shopping list, the intention with the presentation was to give an overview of the information gathered and of how it could be used by the participants.

The participants subsequently split randomly into two groups, both tasked with the same challenges:

- Evaluate which species may have been lost from the Strait of Georgia during the last 500 years;
- Draw species distributions plots for the cases where the distribution may have changed radically over time;
- Evaluate the abundance of the major ecosystem groups relative to their present abundance;

- Examine the draft ecosystem model and evaluate if the list of groups included should be modified, e.g., by adding, merging or splitting groups;
- Identify information sources for past aboriginal harvest of non-salmon species;
- Suggest methods to improve the approach and discuss how to improve the incorporation of traditional knowledge.

The working groups spent most of the time available on discussions of the third of the points above, the previous abundances of the major ecosystem groups. Interestingly, the conclusions reached by the two groups were very similar, lending some degree of objectivity or at least 'convergent subjectivity' to the process.

The cooperation between a diverse group of ecosystem stakeholders, including government and academic researchers, fishers and First Nation people observed during this study was free of conflicts. This is due to the objective of the work having been to seek visions for how the ecosystem resources should be managed in the long-term, and is an example of what has been termed 'patrimonial mediation' (Babin, 1999). We infer from this that it is crucial, when seeking to settle a conflict, to start by discussing and agreeing on the long term, and only subsequently work backwards towards the present and its more pressing issues.

Based on the workshop recommendations, further information was gathered on missing pieces and additional analysis were performed. With this as background, the two initial ecosystem models were improved, and a third, tentative, model describing the state prior to contact between First Nation people and Europeans was constructed. The methodology and the findings are described in more detail by Pauly *et al.* (1998b).

This 'Back to the Future' methodology has been applied since then to one additional area, Hecate Strait also in British Columbia (Beattie *et al.*, 1999). A new multidisciplinary project at a larger scale currently applies the methodology in a comparative fashion to an ecosystem at the Canadian west coast and one at the Canadian east coast (Pitcher *et al.*, 2002).

## ACKNOWLEDGEMENT

This contribution was originally presented at the Census of Marine Life "History of Marine Animal Populations" Workshop, Esbjerg, Denmark, 19-22 February 2000. My thanks to the participants of the 1998 "Back to the future" workshop at the First Nations House of Learning, notably its director Jo-ann Archibald for a most inspiring activity. The paper has benefited from discussions with and comments by Daniel Pauly.

## REFERENCES

- Babin, D., 1999. Managing pluralism of renewable resources: patrimonial mediation and subsidiarity. In: Proceedings of the EXPO'98 Conference on Ocean Food Webs and Economic Productivity. ACP-EU Fisheries Research Report (5): 87 p. pp. 60-61, Ed. by D. Pauly, V. Christensen, and L. Coelho,
- Beattie, A., Wallace, S., and Haggan, N. (eds.), 1999. Back to the Future: Reconstructing the Hecate Strait Ecosystem. Fisheries Centre Research Report 7(3), 65 pp.
- Christensen, V. 1995. Ecosystem maturity - towards quantification. *Ecological Modelling*, 77(1):3-32.
- Christensen, V. 1998. Fishery-induced changes in a marine ecosystem: insight from models of the Gulf of Thailand. *Journal of Fish Biology*, 53:128-142.
- Christensen, V., and Pauly, D. 1992. Ecopath II - a Software for Balancing Steady-State Ecosystem Models and Calculating Network Characteristics. *Ecological Modelling*, 61(3-4):169-185.
- Christensen, V., and Pauly, D. 1998. Changes in models of aquatic ecosystems approaching carrying capacity. *Ecological Applications*, 8(1):S104-S109.
- Hilborn, R., and Walters, C. J., 1992. Quantitative fisheries stock assessment. Choice, dynamics and uncertainty. Chapman and Hall, New York, 570 p.,
- Jackson, J. B. C., Kirby, M. X., Berger, W. H., Bjorndal, K. A., Botsford, L. W., Bourque, B. J., Bradbury, R. H., Cooke, R., Erlandson, J., Estes, J. A., Hughes, T. P., Kidwell, S., Lange, C. B., Lenihan, H. S., Pandolfi, J. M., Peterson, C. H., Steneck, R. S., Tegner, M. J., and Warner, R. R. 2001. Historical overfishing and the recent collapse of coastal ecosystems. *Science*, 293(5530):629-638.
- Ludwig, D., Hilborn, R., and Walters, C. 1993. Uncertainty, resource exploitation, and conservation: Lessons from history. *Science*, 260:17-18.
- MacIntyre, F., Estep, K. W., and Noji, T. T. 1995. Is it deforestation or desertification when we do it to the Ocean? *Naga, ICLARM Quarterly*, 18(3):4-6.
- McAllister, M. K., Pikitch, E. K., Punt, A. E., and Hilborn, R. 1994. A Bayesian approach to stock assessment and harvest decisions using the sampling/importance resampling algorithm. *Canadian Journal of Fisheries and Aquatic Sciences*, 51(12):2673-2687.
- Mitchell, D., 1988. The J. Puddleduck site: a northern Strait of Georgia Locarno beach component and its predecessor. Contributions to human history. In: Royal British Columbia Museum, Victoria, 20 p.
- Odum, E. P. 1969. The strategy of ecosystem development. *Science*, 104:262-270.
- Odum, E. P., 1971. *Fundamentals of Ecology*. W.B. Saunders Co, Philadelphia. 574 pp.
- Pauly, D. 1995. Anecdotes and the shifting baseline syndrome of fisheries. *Trends in Ecology & Evolution*, 10(10):430.
- Pauly, D., Christensen, V., Dalsgaard, J., Froese, R., and Torres, F., Jr. 1998a. Fishing down marine food webs. *Science*, 279(5352):860-863.
- Pauly, D., Christensen, V., and Walters, C. 2000. Ecopath, Ecosim, and Ecospace as tools for evaluating ecosystem impact of fisheries. *ICES Journal of Marine Science*, 57(3):697-706.
- Pauly, D., Pitcher, T., and Preikshot, D. (eds.), 1998b. Back to the Future: Reconstructing the Strait of Georgia Ecosystem. Fisheries Centre Research Report 6(5). 103 pp.
- Pitcher, T. J., 1998. Back to the future: a novel methodology and policy goal in fisheries. pp 4-7. In: Back to the Future: Reconstructing the Strait of Georgia Ecosystem. Ed. by D. Pauly, T. J. Pitcher, and D. Preikshot. Fisheries Centre Research Report 6(5).
- Pitcher, T. J. 2001. Fisheries managed to rebuild ecosystems? Reconstructing the past to salvage the future. *Ecological Applications*, 11(2):601-617.
- Pitcher, T. J., and Pauly, D., 1998. Rebuilding ecosystems, not sustainability, as the proper goal of fishery management. In: Reinventing Fisheries Management. pp. 311-329, Ed. by Pitcher, P. J. B. Hart, and D. Pauly, Chapman and Hall, London,
- Pitcher, T. J., Vasconcellos, M., Heymans, S., Brignall, C., and Haggan, N. (eds.), 2002. Information supporting past and present ecosystem models of northern British Columbia and the Newfoundland Shelf. Fisheries Centre Research Report 10(1), 116 pp.
- Salas, S., Archibald, J. A., and Haggan, N., 1998. Aboriginal knowledge and ecosystem reconstruction. pp 22-28. In: Back to the Future: Reconstructing the Strait of Georgia Ecosystem. Ed. by D. Pauly, T. J. Pitcher, and D. Preikshot. Fisheries Centre Research Report 6(5).
- Smith, T. D., 1994. *Scaling fisheries: the science of measuring the effects of fishery 1855-1955*. Cambridge University Press, Cambridge, 392 pp.
- Wallace, S. S., 1998a. Changes in human exploitation of marine resources in British Columbia (pre-contact to present day). pp. 58-64. In: Back to the Future: Reconstructing the Strait of Georgia Ecosystem. Ed. by D. Pauly, T. J. Pitcher, and D. Preikshot. Fisheries Centre Research Report 6(5).
- Wallace, S. S., 1998b. Sources of information used to create past and present ecosystem models of the Strait of Georgia. pp. 19-21. In: Back to the Future: Reconstructing the Strait of Georgia Ecosystem. Ed. by D. Pauly, T. J. Pitcher, and D. Preikshot. Fisheries Centre Research Report 6(5).
- Walters, C., Christensen, V., and Pauly, D. 1997. Structuring dynamic models of exploited ecosystems from trophic mass-balance assessments. *Reviews in Fish Biology and Fisheries*, 7(2):139-172.
- Walters, C., Pauly, D., and Christensen, V. 1999. Ecospace: Prediction of mesoscale spatial patterns in trophic relationships of exploited ecosystems, with emphasis on the impacts of marine protected areas. *Ecosystems*, 2(6):539-554.
- Walters, C., Pauly, D., Christensen, V., and Kitchell, J. F. 2000. Representing density dependent consequences of life history strategies in aquatic ecosystems: EcoSim II. *Ecosystems*, 3(1):70-83.
- Williams, J., 1998. Reading Rocks: On the Possibilities of the Use of Northwest Coast Petroglyph and Pictograph Complexes as Source Material for Ecological Modelling of Prehistoric Sites. pp. 34-37. In: Back to the Future: Reconstructing the Strait of Georgia Ecosystem. Ed. by D. Pauly, T. J. Pitcher, and D. Preikshot. Fisheries Centre Research Report 6(5).



## REPRESENTING TROPHIC INTERACTIONS IN THE NORTH SEA IN THE 1880s, USING THE ECOPATH MASS-BALANCE APPROACH.

**Steven Mackinson**

*Centre for the Environment, Fisheries and Aquaculture Science  
Lowestoft, UK  
email: s.mackinson@cefias.co.uk*

### ABSTRACT

Prior to the development of steam fishing vessels in the early 1880s, more than 20,000 sailing fishing vessels, from bordering countries, ploughed the bountiful waters of the North Sea. In the UK alone, fishing and its associated activities provided a livelihood for upwards of 100,000 people. The North Sea was particularly rich in marine life, both in general and in individual populations. Outstripping all in economic and sociological significance, however, was one fish: the herring. Herring drifters and beam trawling sailing smacks dominated the seas with other small vessels engaging in hook and line fishing, and crab and lobsters in coastal waters. Most highly prized 'prime' species included turbot, brill, soles and John dorys. Combining present information on trophic linkages of North Sea species with historical scientific and local knowledge, an ecosystem model is re-constructed to describe the state of the North Sea ecosystem in the 1880s. The model is 're-constructed' with the aid of a previous model describing the state of the ecosystem in 1980s (V. Christensen, Dana 11: 1-28, 1995). This contribution documents the data, methods and assumptions used in model construction.

### INTRODUCTION

The state of the North Sea ecosystem in the 1880s is not known. We can only use the best available pieces of evidence to 'reconstruct' what might have been (Christensen, this volume). The purpose of this work is to construct a representation of what the structure of the North Sea ecosystem may have been just prior to the development of industrialized fisheries. A representation of the North Sea in the 1980s (Christensen, 1995) was used to aid construction of the model and for comparative purposes. The representations, or models, are constructed using the Ecopath approach and software (Christensen and Pauly, 1992). The 1880s model has a different structure compared to that of the 1980s. It

includes groups of species, such as whales, bluefin tuna and sturgeon that are not represented in the 1980s and demonstrates that whilst species assemblages were similar among the fish groups in both periods, the relative biomass and distribution of flows was likely to have been considerably different.

This technical report focuses on the data sources and methods used in the reconstruction of the 1880s North Sea model. The work shows that while historic fisheries statistics and narratives of the fisheries are rich in information, they are by no means complete. Often, assumptions are required to weave together the various sources of data and information. The assumptions are made explicit throughout and are the reason why the model is termed a 'representation' of the North Sea in the 1880s. The first part of this report presents the fishery of the 1880s and the methodology employed to build the model, while the second part gives the detailed information for each functional group.

### PART 1: METHODS

#### *North Sea fisheries in the 1880s*

The period captured for the reconstruction is that immediately prior to the large-scale industrialisation of fishing marked by the first steam trawlers *Zodiac* and *Aries* of 1881. The period marks the end of an era, the era of sailing fishers.

*"According to the most reliable statistics, there are 30,000 vessels fishing around the British Isles, of which, the greater number by far is composed of herring boats. These vessels exceed by 8000 the number of ships, which form our mercantile marine. The fishing boats are manned by some 105,000 men and boys, but besides these there are at least the same as many again who on shore are directly connected with the fisheries... The Scotch are now by far the greatest herring fishers in the world. They possess 14,500 herring boats worked by some 50,000 men and boys, and the season of 1880 was the heaviest they have ever known. The catch on the east and west coasts amounted to 970,000 crans or 767,500,000 fish or counting by the Great Yarmouth tale would be 58,144 lasts. The estimated wholesale value in round figures was around £1 million."*

de Caux (1881).

Three principal fisheries were executed in the North Sea towards the end of the 19<sup>th</sup> century. The herring drift net fishery, longline and trawl fisheries (Table 1.1). Of these fisheries, by far the largest, most economically and socially important fishery of the sailing era, was the herring fishery. Since as early as the 1400s, the wealth of nations built on the herring fisheries. For many years, little had changed in the method of herring fishing. In the 1400s, herring fishing vessels displaced <30 t, were single-masted, open decked, carried a crew of 4-10, were equipped with sails and oars and were put to sea for 1-2

nights fishing using an entangling ‘drift net’, as did their successors in late 19<sup>th</sup> century (Cushing, 1988; Figure 1.1). According to the report of the Fishery Commissioners for 1878 (Buckland *et al.*, 1878) the British, French, Dutch and Norwegian fishers, caught 2,400,000,000 herrings annually in the North Sea, a quantity that represents 181,818 ‘lasts’ (369,090 tonnes, de Caux, 1881), or

“In other words, two herring for every man, woman and child living in the world.”

Buckland *et al.* (1878).

**Table 1.1.** Dutch North Sea fisheries and species caught in late 1800s (after Hoek and Kyle, 1905)<sup>a</sup>.

Longline fishery	Trawl fishery
Cod ( <i>Gadus morrhua</i> )	Plaice ( <i>Pleuronectes platessus</i> )
Ling ( <i>Molva vulgaris</i> )	Haddock ( <i>Gadus aeglefinus</i> )
Haddock ( <i>Gadus aeglefinus</i> )	Sole ( <i>Solea vulgaris</i> )
Halibut ( <i>Hippoglossus vulgaris</i> )	Turbot ( <i>Rhombus maximus</i> )
Coalfish (saithe) ( <i>Gadus virens</i> )	Cod ( <i>Gadus morhua</i> )
Hake ( <i>Merluccius vulgaris</i> )	Dab ( <i>Pleuronectes limanda</i> )
Whiting ( <i>Gadus merlangus</i> )	Red gurnard ( <i>Trigla hirundo</i> )
Rays ( <i>Raja clavata</i> and other species)	Brill ( <i>Rhombus laevis</i> )
Skate ( <i>Raja batis</i> )	Whiting ( <i>Gadus merlangus</i> )
	Weever ( <i>Trachinus</i> )
	Grey gurnard ( <i>Trigla gurnardus</i> )
	Flounder ( <i>Pleuronectes flesus</i> )
	Smear-dab ( <i>Pleuronectes microcephalus</i> )
	Ling ( <i>Molva vulgaris</i> )
	Skate ( <i>Raja batis</i> )
	Halibut ( <i>Hippoglossus vulgaris</i> )
	Red mullets ( <i>Mullus surmuletus</i> )
	Coalfish ( <i>Gadus virens</i> )
	Sturgeon ( <i>Acipenser sturio</i> )
	Mackerel ( <i>Scomber scomber</i> )
	Horse mackerel ( <i>Caranx trachurus</i> )
	Salmon ( <i>Salmo salar</i> )
	Lobster ( <i>Homarus vulgaris</i> )

<sup>a</sup> The important herring (*Clupea harengus*) fishery should be added to this list.

Industrialisation of herring fisheries started in the mid 1800s when nets started being made by machine and cotton replaced hemp. Vessels increased in number and size, more nets were fished and catch per unit effort increased correspondingly (Figure 1.2). During the late

1880s, the largest herring fleets came from Scotland and England (Figure 1.3 and Table 1.2). The vessels in the East Anglian herring fishery were large, bluff bowed and three masted, with a large lug sail on each.

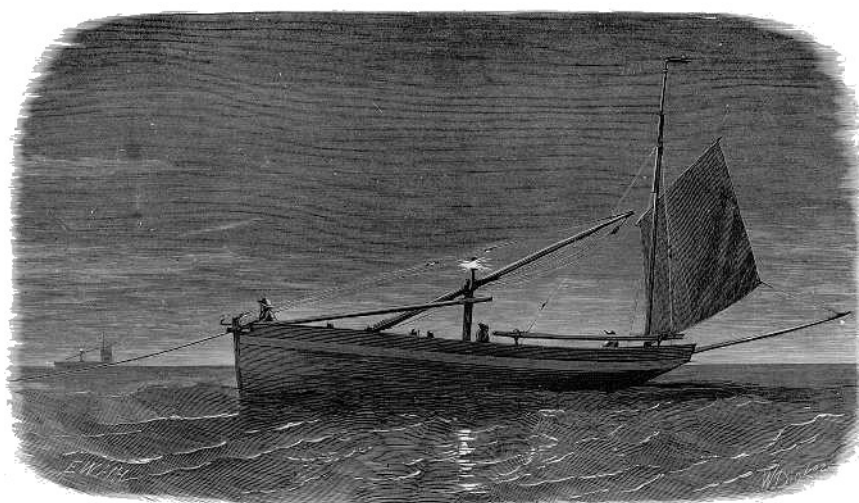

**Figure 1.1.** Yarmouth lugger drift net fishing for herring at night (Holdsworth, 1874) .

**Table 1.2.** Prosperity of British herring fishing fleet in the mid 1850s (from Nall, 1866).

Measure of Prosperity	Yarmouth	All British stations <sup>a</sup>
Tonnage of boats employed in herring cod and ling fisheries	21,012	126,520
Square yards of netting used in herring fishery	9,525,600	94,916,584
Yards of long lines, hand lines and bouy ropes used in the fisheries	2,306,274	36,313,706
Values of boats employed	£194,720	£630,282
Values of nets employed	£100,800	£465,931
Value of Lines	£21,105	£92,877
Total value of boats nets and lines	£31,625	£1,189,090
Number of boats, decked or undecked in herring cod and ling fisheries	859	14,962
Number of fishermen and boys by whom the said boats were manned	5,216	59,792
Number of Coopers employed	232	2,181
Number of person employed in gutting packing cleaning or drying fish	2,078	28,993
Number of labourers employed	859	7,360
Total number of person employed	8,385	98,326
Number of fish curers	316	1,619

<sup>a</sup> Data on all British Stations seems only to include major ports, so the values are likely underestimates.

In 1884, the steam capstan was invented by Elliot and Garrod of Beccles, near Lowestoft. The steam was fed into the capstan through its hollow spindle and so the warp was free. After the first steam drifters, 'Newark Castle' and 'Consolation' were launched on the Northeast coast in 1897 (Wilson, 1965 and Goodey, 1976 *in* Cushing, 1988), fishing was much less dependent on wind. The nets were now 50 m long, 13 m deep and up to 90-100 were shot, making a fleet of about 2.5 km. The big French drifters were shooting up to

280 at this time. These were the major steps in the industrialisation; machine made cotton nets, the steam capstan, and lastly the steam drifter itself. Sailing luggers were increasingly replaced in all participating countries thus steam drifters saw a very rapid increase to their heyday just prior to 1920 (Gray, 1978) when catch of herring reached nearly 700,000 t (Cushing, 1988). In Scotland the fleet of steam drifters grew from 41 in 1898 to 943 in 1908 (Sahrhage and Lundbeck, 1992).

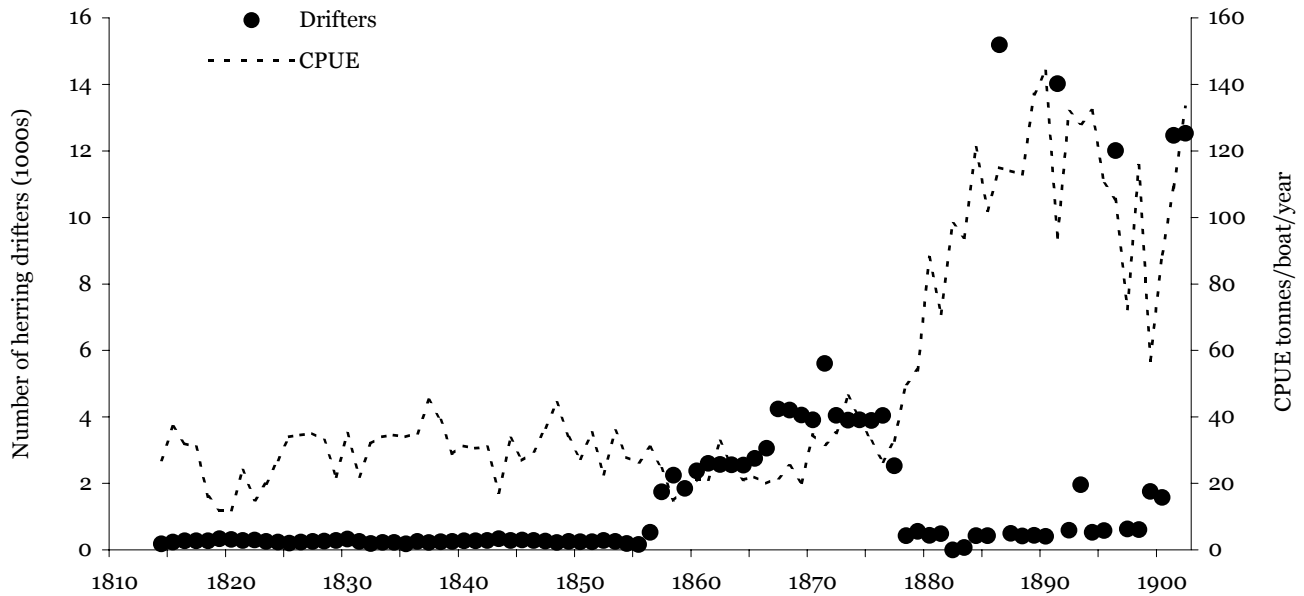

**Figure 1.2.** Number of sailing herring drifters and their CPUE in the North Sea. The apparent large fluctuation in the number of vessels in the period 1878-1900 is not real, but due to lack of statistics. It can be safely assumed that the number of vessels for this entire period was between 12-15,000.

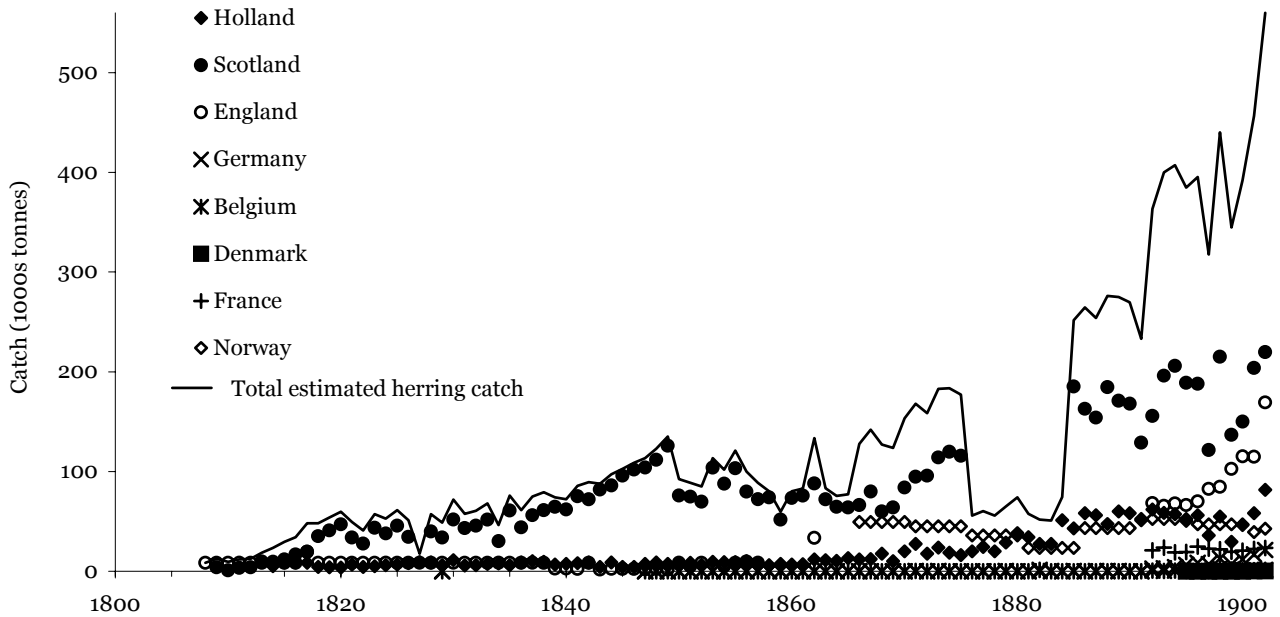

**Figure 1.3.** Catch of North Sea herring. The apparent sharp dip in catches from the late 1870s to mid-1880s is not real, but due to missing catch statistics for the Scottish fleet.

The North Sea was exploited by large long liners at least a century before trawlers appeared, Harwich being the headquarters of fishing (Figure 1.4a,b). Welled-smacks, for keeping the fish alive before transfer to floating chests at the dock, were first introduced there in the 18<sup>th</sup> Century. Cod, plaice and turbot were the primary targets of the longline fisheries. Steam vessels were first

introduced into the longliner fleet in about 1860 but the number was never very great. In 1893 there were only 56, in 1902, 67 (Hoek and Kyle, 1905). Trawls largely replaced the longline fisheries for they were better able to catch the 'prime' fish species found exclusively at the bottom.

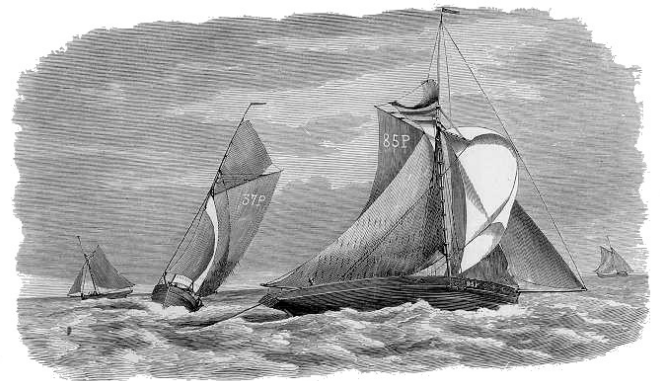

**Figure 1.4a.** Map of the North Sea with major island groups and ports.

Trawling most probably originated from Brixham, UK, where as far back as 1815, fish were caught with the beam trawl (Green, 1918). In 1823, each vessel was landing 1000-2000 large turbot (Anon., 1921) off Southeastern England, a stock density that cannot be imagined today. In search of markets (Green, 1918), or due to local depletion of stocks (Cushing, 1988), trawlers migrated north to Hull and then to Grimsby, where new railways had opened up markets in London and Yorkshire. The small open boat design progressed to the 'smack', a two masted sailing vessel running up to about 80 feet, which allowed the fishers to sail further out to the Dogger Bank and Silver Pit (Figure 1.4b). At this time, these banks "abounded with fish in such quantities that the fishers only troubled to save the more valuable varieties" (Green, 1918). Trawl fish were classified under the names 'prime' and 'offal'; the former including turbot, brill, soles, and John dories; the latter comprising of plaice, cod, haddock, gurnard, skate, and "other such kinds as are occasionally caught in the trawl" (Holdsworth, 1874; Figure 1.5).

'Fleeting', where a fleet of smacks was commanded by an admiral, began in 1828 and

continued through the late 1800s. These fleets stayed at sea for six to eight weeks (Alward, 1932). In 1864, the first steam carriers, based on the cutter design, sailed from Barking (Figure 1.4b). The steamers carried three times the cargo of the sailing cutters at three times the speed, and no longer at the mercy of the wind, they could make it more consistently to Billingsgate fish market. An important change occurred during the 1870s when paddle steamers started to be used regularly to tow sailing smacks to sea, thus enabling easier access to offshore grounds.



**Figure 1.5.** Towing the trawl (Holdsworth, 1874).

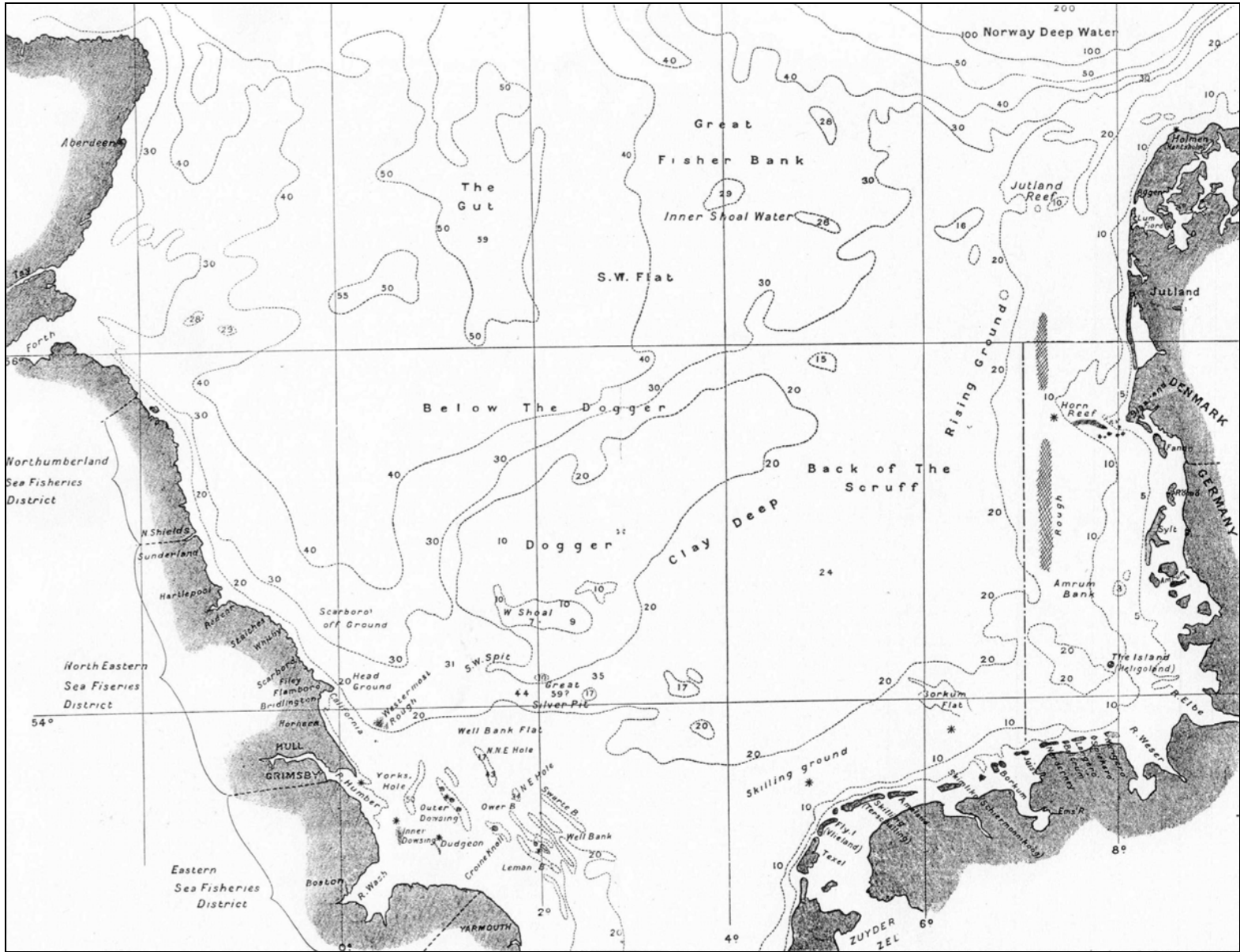

Figure 1.4b. Map of the North Sea showing bathymetry and major fishing areas (from Holt, 1895).

“When in 1872 the *Challenger* left Portsmouth on its epoch-making expedition, our fisheries, other than the herring, were quite unimportant and confined to the belts and estuaries of water adjacent to the east and south coast. The steam trawler was unknown.”

Green (1918).

Britain alone, each of which could do the work of 6 sailing trawlers (Green, 1918). Trawl catches at Grimsby increased markedly in volume and value during this period (Table 1.3).

**Table 1.3.** Trawl catches at Grimsby

Year	Catch (t)
1860	4,375
1870	26,324
1880	46,931
1890	71,382
1900	133,791
1910	179,792

The first effective steam trawlers, *Zodiac* and *Aries*, were built in 1881. They were 34 m long and steamed at 17 km·h<sup>-1</sup> and caught 4 times as much as a smack according to Dyson (1977). By 1900, the numbers of steamers was rising rapidly whilst sailing smacks were declining (Figure 1.6). There were at least 1,500 on the east coast of

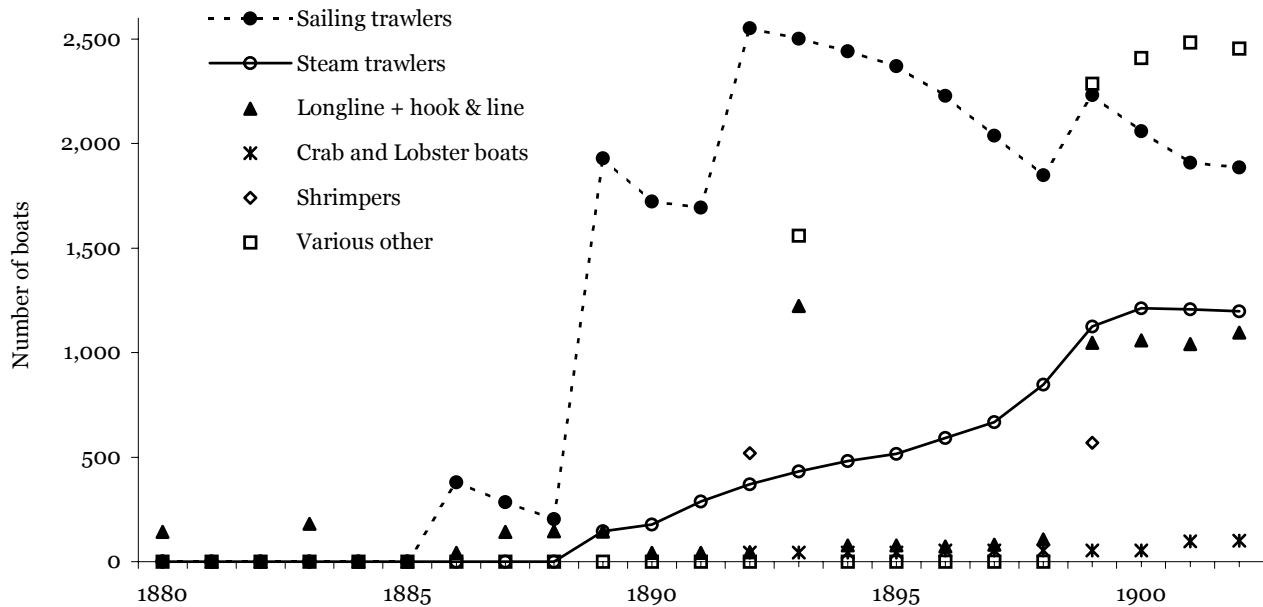

**Figure 1.6.** Changes in North Sea fleet structure 1880-1902.

**Data and information sources**

Statistics of the fisheries have been collected for many purposes. One of the earliest complete sets is that on the British white herring fishery from 1808 to 1875. Statistics on catches in weight by species from areas in the North Sea or adjacent ports were collected in most European countries by the last decades of the nineteenth century. Fulton (1908) described the system started by the Scottish Fishery Board, which, with minor modification, was adopted by d’Arcy Thompson (1909), for the International Council as an example for the collection of statistics. The period considered here covers that during the early development of fisheries statistics reporting

systems and for this reason the data come from a variety of sources and have had to undergo various adjustments and unit conversions to make them comparable and synthesise the pieces (see Box 1). Much of the specific statistics and good narratives come from the following: Mitchell, 1864; Nall, 1866; Holdsworth, 1874; Buckland *et al.*, 1878; de Caux, 1881; Holt, 1895; Garstang, 1903a,b; Green, 1918; Hoek and Kyle, 1905; Thompson, 1909; and Cushing, 1988. In relying on the reported statistics, it should be noted that of many of the estimates of fisheries catches are undoubtedly underestimates due simply to the lack of reporting at this time. More specific references, relevant to each species, are given in Part 2.

**Box 1****CATALOGUE OF CONVERSIONS**

Some conversions found in Kyle (1905), Hoek and Kyle (1905), and Buckland *et al.* (1878), and used here:

1 barrel = 865 salted herring on the average;  
 8 fresh herring = 1 kg;  
 1 barrel = 108 kg fresh herring;  
 1 cwt = 50.8 kg;  
 The usual measure is the 'cran' of about 1000 herring and weighing approximately 3.5 cwt or 178 kg. A 'barrel' of salted herring is taken to weigh 2 cwt or 102 kg and contains about 800 fish on average;  
 1 barrel = 800 fish on average (750 + 50 wasted during curing, Buckland *et al.*, 1878);  
 British bushel = 36.37 litres;  
 Tun = 100 kg;  
 British imperial ton = 1.016 tonnes;  
 Quintail (wet fish) = 98.39 kg;  
 Quintail (dry fish) = approx. 500lb (227 kg) of fish from the sea after heading, splitting and drying;  
 Cran = 37.5 imperial gallons, or 28 stones of herring, or 900-1000 herring;  
 Last (from Lowestoft) = 13,200 herring, or 2.03 tonnes (Nall, 1866);  
 Dutch Last = 1.5 tonnes with about 5000 herring to 1 tonne;  
 Package = 1 hundred weight;  
 6000 herring = approx. 1 tonne.

Commenting on the reliability of the early statistics, Hoek and Kyle (1905) wrote:

*"The period 1886-1890 is the one for which the statistics are most unreliable and should except for the herring and mackerel be omitted. The species recorded were few in number, and the brill, halibut and plaice were not given for the years. Consequently the species grouped under 'fish not separately distinguished' were somewhat numerous as well as mixed in character".*

Kyle (1905) and Hoek and Kyle (1905) detail data caveats for each country, for example, the inclusion of other species like ling, hake and pollock in reported cod catches. Where possible, Kyle (1905) attempted to correct the summarised data for such inconsistencies. These same inconsistencies are contained in the data used here and add to the uncertainty of the estimations. Where deemed of considerable importance, details of specific potential data

inconsistencies are included in the species accounts in Part 2; otherwise the reader is referred to the original references.

A major challenge in compiling the data for this work has been the access to relevant historical materials. Many of the early, detailed reports on fisheries statistics are buried deep within various institutions of particular fishing nations, rendering them restricted in availability. Whilst the author has had access to historical statistics from UK fisheries, synthesis reports and early official ICES statistics have been relied upon for other countries. It is unlikely, however, that raising to this challenge generated considerable bias, since during the 1880s, the fleet and catches from UK fisheries were by far larger than any other country fishing in the North Sea (Dambeck, 1876).

**The study area**

The continental coastal zone of the North Sea represents an area of about 60,000 km<sup>2</sup>, under strong influence of terrigenous inputs. The mean depth is about 15 m and the warm water column is well mixed. The remaining part of the North Sea extends over about 500,000 km<sup>2</sup>. Its mean depth is 90 m with a summer stratification of the water column resulting in an upper mixed layer of about 40 m (Billen *et al.*, 1990). For the present model the North Sea was treated as one stratum with a total area of 570,000 km<sup>2</sup> (Jones, 1982; Figure 1.4a).

The hydrography of the North Sea is described in detail by Otto *et al.* (1990). A brief summary follows:

Two large tongues of 'Atlantic water' (35 salinity) extend into the North Sea. The larger mass enters from the North between the Orkney Island and Norwegian trench in a southeast direction towards the Dogger Bank. The narrow tongue in the Southern Bight is considerably smaller, corresponding to the smaller opening of the English Channel into the North Sea. In coastal areas influenced by freshwater runoff, mean salinity is lower than 34. On the West and Southeast coasts of the North Sea this water is called 'Coastal water'. The water masses in the Central North Sea with salinities between 34 and 35 are called 'North Sea water' and originate from the mixing of Atlantic and coastal waters (Fransz *et al.*, 1991a). Fulton (1897) provided a synopsis of the surface currents of the North Sea, concluding that a large anti-clockwise gyre rotates around the North Sea affecting all areas.



A pronounced thermocline develops over most of the North Sea and the western channel in the early spring and remains present until October, except in the shallower Southern Bight. In the Central North Sea, phytoplankton production takes place in April-May, stopping when nutrients above the thermocline are depleted. A second peak production occurs in September-October, when the overturn of the thermocline brings fresh nutrients to the surface layers (Postma, 1978). The productivity of the North Sea, as measured by the amount of carbon fixed by the phytoplankton gives an average value of  $100 \text{ gC}\cdot\text{m}^{-2}\cdot\text{year}^{-1}$ . This is high when compared with oceanic sites of similar latitude; North Atlantic,  $21 \text{ gC}\cdot\text{m}^{-2}\cdot\text{year}^{-1}$ ; North Pacific,  $50\text{-}70 \text{ gC}\cdot\text{m}^{-2}\cdot\text{year}^{-1}$ . Coastal upwelling regions provide sites of very high productivity. For example, St. Margaret's Bay, Nova Scotia,  $190 \text{ gC}\cdot\text{m}^{-2}\cdot\text{year}^{-1}$ ; off the coast of Peru  $120 \text{ gC}\cdot\text{m}^{-2}\cdot\text{year}^{-1}$  and the Canary Islands,  $145 \text{ gC}\cdot\text{m}^{-2}\cdot\text{year}^{-1}$  (Sibthorp, 1975).

### Model parameterisation

Every effort has been made to derive historical information for parameterisation of the 1880s model. Where this has not been possible, it has been necessary to rely on more recent estimates used in the 1980s model constructed by Christensen (1995).

### Production and consumption

Unless otherwise stated under the species descriptions in Part 2, P/B (production/biomass) and Q/B (consumption/biomass) ratios for fish groups, were derived from original parameters estimates given by Christensen (1995) for the 1980s model. Where juveniles of species are explicitly recognised, original estimates of their production and consumption were assumed to be two times that of the adults. In light of balancing the model, the original value for consumption may have been too high. To account for a higher gross conversion efficiency of juveniles than adults and to reduce demands imposed by very high juvenile feeding rates, consumption by juveniles was reduced to 1.5 times that of adults.

### Estimating the biomass of fish

One of the most important aspects of constructing a representation of the North Sea ecosystem in the 1880s is estimating the biomass of species at that time. Whilst it is possible for Ecopath to estimate the biomass of species, given estimates of P/B, Q/B and EE (ecotrophic efficiency, i.e., the fraction of the production that is consumed

within the system), this method was not applied to most groups for two reasons. Firstly, because the same values for P/B, Q/B applied in the 1980s model were often used here in parameterisation of the 1880s model (based on the assumption that these rates are species specific and do not alter with time or changes in diet) and thus estimating biomass from them would simply lead to similar values as the 1980s model (dependant in this instance on any changes in the diet compositions). Secondly, where fisheries statistics were available, it was possible to use several methods to derive ranges of alternative estimates of biomass for each species. The methods used are detailed below:

*Estimating unexploited biomass ( $B_{inf}$ ) by fitting historical CPUE data using a Schaefer-type surplus production model*

$$B_{t+1} = B_t + rB_t \left(1 - \frac{B_t}{B_{inf}}\right) - B_t q_t f_t \quad \dots 1)$$

Where,  $B_t q_t f_t = C_t$  and,  $B_t$  is the population biomass at time  $t$ ,  $r$  is the intrinsic rate of growth,  $B_{inf}$  is the unexploited stock biomass,  $q_t$  is the catchability coefficient at time  $t$ , and  $f_t$ , the fishing effort at time  $t$  and  $C_t$  is the observed catch at time  $t$ .

Species specific values for the intrinsic rate of growth,  $r$ , reported in FishBase ([www.fishbase.org](http://www.fishbase.org)), and observed catch and catch per unit effort (CPUE) data ( $U_{tobs}$ ) were used to estimate the parameter  $B_{inf}$ , unexploited biomass by the following fitting procedure. An initial guess of  $B_{inf}$  together with the observed catch,  $C_t$ , is used in the Schaefer model to produce a predicted stock biomass for each year. With the predicted biomass values and the observed catch rates ( $U_{tobs}$ ), an estimator of the catchability coefficient,  $q$ , is calculated from:

$$\hat{q} = \frac{\sum_{t=1}^{t=n} U_{tobs} B_t}{\sum_{t=1}^{t=n} B_t^2} \quad \dots 2)$$

The estimated  $q$  is used to generate a predicted CPUE time series ( $U_{tpred}$ ),  $U_{tpred} = \hat{q} B_t$  which is used to fit the observed CPUE to predicted CPUE data by using the solver routine in Excel to minimise the sum of squared differences ( $(U_{tobs} - U_{tpred})^2$ ), by changing only the parameter  $B_{inf}$ . Where solver is capable of deriving a reasonable

solution fitting predicted CPUE to observed CPUE, the resulting value of  $B_{inf}$  is taken as an estimate of unexploited biomass. The estimate of biomass for each species was taken as being 80% of unexploited biomass, under the assumption that only 20% of the historical stock had been depleted by fishing by the late 19<sup>th</sup> century.

The above procedure was used to estimate the biomass of species for which observed CPUE data was available. These species were, plaice, sole, haddock, herring and ‘trawl offal’. In each case, catch data comprised the total North Sea landings from all countries, whilst CPUE was frequently limited to data from one specific country and or gear type. Where necessary, CPUE data were truncated to eliminate any changes in CPUE that may have resulted from significant changes in fishing power. This is particularly important during later years of the 1800s where CPUE data reflect catches from both sail and steam vessels. Predicted biomass estimates are given in Table 1.4.

**Table 1.4.** Biomass estimates made using surplus production model fitting.

Species	CPUE data period	CPUE by country	Estimated biomass (t)
Plaice	1892-1899	Dutch	487,826
Plaice	1892-1902	Dutch	1,438,237
Sole	1892-1902	Dutch	100,000 +Huge <sup>a</sup>
Haddock	1892-1902	Dutch	673,434
Trawl Offal	1867-1892	UK	118,8087
Herring	1814-1902	Dutch	500,000 +Huge <sup>a</sup>
Herring	1854-1877	Scottish	500,000 +Huge <sup>a</sup>
Herring	1814-1902	All	1,000,000 +Huge <sup>a</sup>

<sup>a</sup> Because observed CPUE showed steep increases, it was not possible to get a reasonable fit between predicted vs. observed CPUE. Small differences in the sums of squared differences produced biomass estimates ranging from 500,000 t to hundreds of millions of tons! "Huge".

*Using recent estimates of CPUE (U), stock size (B) and catchability (q), with assumptions of changes in fishing power to predict past biomass*

This approach was applied using two separate methods, both of which rely on the simple assumed relation  $U = qB$ . Given  $U$  in the 1880s and a recent estimate of  $q$ , past biomass can be estimated by assuming that:

$$\frac{U_{past}}{q_{past}} = B_{past} \quad \dots 3)$$

and

$$q_{past} = \frac{q_{recent}}{EF} \quad \dots 4)$$

where EF factor represents changes in fishing power associated with technological change. Likely changes in catchability resulting from other causes such as behaviour and changes to stock size/area can be considered implicit in the range of values of EF examined. In each of the methods, a range of EF values (10-30, in steps of 10) were applied, thus giving a range of estimates of possible biomass.

**Catch per boat method**

Vessel data - Information on the number and type of fishing vessels operating from each country of the European Union in 1997 was obtained from European Union web site (www.marsource.eu). For those countries bordering the North Sea (Belgium, Denmark, France, Netherlands, Germany, United Kingdom), the available information on fleet structure and target species was used to infer an approximate division of the number of vessels engaged in fishing a particular species (Table 1.5).

**Table 1.5.** Division of fishing capacity (number of boats) by country in 1997.

Gear	Belgium	Denmark	France	England	Netherlands	Germany	Total
Longliners	-	750	-	-	-	-	750
Beam trawlers	140	250	-	200	391	600	1,581
Otter trawlers	-	1,100	-	1,380	-	-	2,480
Others	16	2,500	2,000	7,500	-	1,800	13,816

Catch and Biomass data - Recent (1997) estimates of spawning stock biomass (SSB) and annual catch of each species in the North Sea were taken from the ICES annual report (Anon., 1999a). An estimate of catch per vessel for each species was derived using the catch statistics and the approximate number of vessels fishing for that species. An annual estimate of  $q$  for each species was obtained by dividing the catch per vessel by the SSB as shown in Table 1.6.

Catch per vessel of each species in the North Sea during 1880s, or thereabouts, was estimated from total catch and total number of vessel statistics (Figure 1.2 and 1.5) compiled for each country from a variety of sources (Kyle, 1905; Hoek and Kyle, 1905; Garstang, 1900a,b; Holdsworth, 1874; Buckland *et al.*, 1878; Mitchell, 1864; Nall, 1866; Beaujon, 1884; Tables 1.7 and 1.8). Figure 1.7 details the changes in catch per vessel of 4 Grimsby smacks, the results of which led Garstang (1903a) to comment,

*“An obvious feature of the table is the abundance and cheapness of the fish. Nothing like an average capture of 345 cwts of prime fish and 1450 cwts of offal is realised by trawling smacks at the present*

*time, inspite of the inducements offered by the far higher prices to be obtained to-day for fish of all kinds”...p. 26...“The returns of both series of the Grimsby trawling smacks seem, therefore, to provide unequivocal evidence of a great depletion of the North Sea trawling grounds.”... and that this is principally due to an enormous reduction in the abundance of flat-fish, both prime and plaice, the catches under each head about 1890 being less than one-fifth and one-third respectively of the quantities being taken from 25-30 years previously. The catch of haddock have also reduced but to a lesser extent”.*

**Table 1.7.** Total number of fishing vessels in the North Sea in 1880s.

Vessel type	Year	Number
Herring drifters	1886	15,597
Sailing trawl	1889	1,930
Line vessels	1880	142
Crab and Lobster	1892	519
Shrimp	1893	163
Various	1903	1,560

**Table 1.6.** Catch per vessel (U), Spawning Stock Biomass (SSB) and estimation of  $q$  for each species according to gear type (beam trawlers, longline and otter trawlers) in 1997.

Species	Catch (t)	SSB (t)	Approx. no. of vessels	U (t·year <sup>-1</sup> )	$q$ estimate per year
<i>Beam trawlers</i>					
Plaice	83,050	181,180	1,581	20.68	0.00029
Sole	14,980	31,830	1,581	3.73	0.000298
<i>Longline and otter trawlers</i>					
Haddock	141,900	197,080	3,230	29.49	0.000223
Cod	124,160	982,900	3,230	25.81	0.0000391
Whiting	59,100	169,000	3,230	12.28	0.000108
Saithe	112,740	169,770	3,230	23.43	0.000206
<i>Other vessels</i>					
Mackerel	79,161	240,000	13,816	5.73	0.0000239

Biomass estimation - A range of possible past biomass values were calculated for plaice, sole, haddock, cod, whiting and mackerel (Table 1.9) using the derived past catch per vessel and recent catchability as:

$$B_{past} = \frac{U_{past}}{(q_{recent} / EF)} \quad \dots 5)$$

where  $EF$  ranged from 10-30.

**Table 1.8.** Estimate of catch per vessel in 1880s for various fisheries.

Species	Year	Catch (t)	No. of vessels	Catch per vessel (t·year <sup>-1</sup> )
<i>Drifters</i>				
Herring	1875	177,264	15,597	11.365
<i>Trawlers and Liners</i>				
Plaice	1886	32,337	2,072	15.607
Sole	1886-90	3,014	2,072	1.455
Dab	1892-1895	4,181	2,072	2.018
Witch and lemon sole	1886-90	607	2,072	0.293
Brill	1886-90	597	2,072	0.288
Gurnards and weevers	1892-1895	698	2,072	0.337
Haddock	1886-90	113,187	2,072	54.627
Cod	1880	21,088	2,072	10.178
Turbot	1886-90	2,733	2072	1.319
Halibut	1886-90	5,787	2,072	2.793
Whiting	1886-90	3,395	2,072	1.638
Cod	1886-90	53,848	2,072	25.989
Ling	1886-90	7,496	2,072	3.618
Rays & skates	1886-90	1,964	2,072	0.948
Dog-fish and cat-fish	1892-1895	80	2,072	0.039
Tusk ( <i>Brosminus brosme</i> )	1886-90	450	2,072	0.217
Conger eel ( <i>Conger vulgaris</i> )	1886-90	124	2,072	0.060
<i>Others</i>				
Mackerel	1880	184	1,560	0.118
Salmon	1850-1865	496	1,560	0.318
Crabs	1886-1890	3,674	519	7.079
Lobsters	1886-1890	338	519	0.651
Sprat, herring & anchovies	1886-90	4,897	1,560	3.139
Saithe (coalfish) and pollack	1886-90	3,621	1,560	2.321
Hake	1892-1895	965	1,560	0.619
Shrimp			163	0.000
Various (sturgeon, salmon, shad, smelt)	1886-90	4,427	1,560	2.838

**Table 1.9.** Biomass estimates derived using the Catch per Boat Method for a range of Efficiency Factors (EF).

	CPUE 1880		Biomass (t)		
	Catch (t)	t·boat <sup>-1</sup> ·year <sup>-1</sup>	Efficiency factors (EF)		
			10	20	30
<i>Trawlers &amp; liners</i>					
Plaice	32,337	15.60	538,285	1,076,570	1,614,856
Sole	3,014	1.45	48,863	97,727	146,590
Haddock	113,187	54.63	2,450,588	4,901,176	7,351,765
Cod	21,088	10.18	2,602,410	5,204,821	7,807,231
Whiting	3,395	1.64	151,331	302,662	453,993
<i>Various others</i>					
Mackerel	184	0.117949	49,406	98,811	148,217

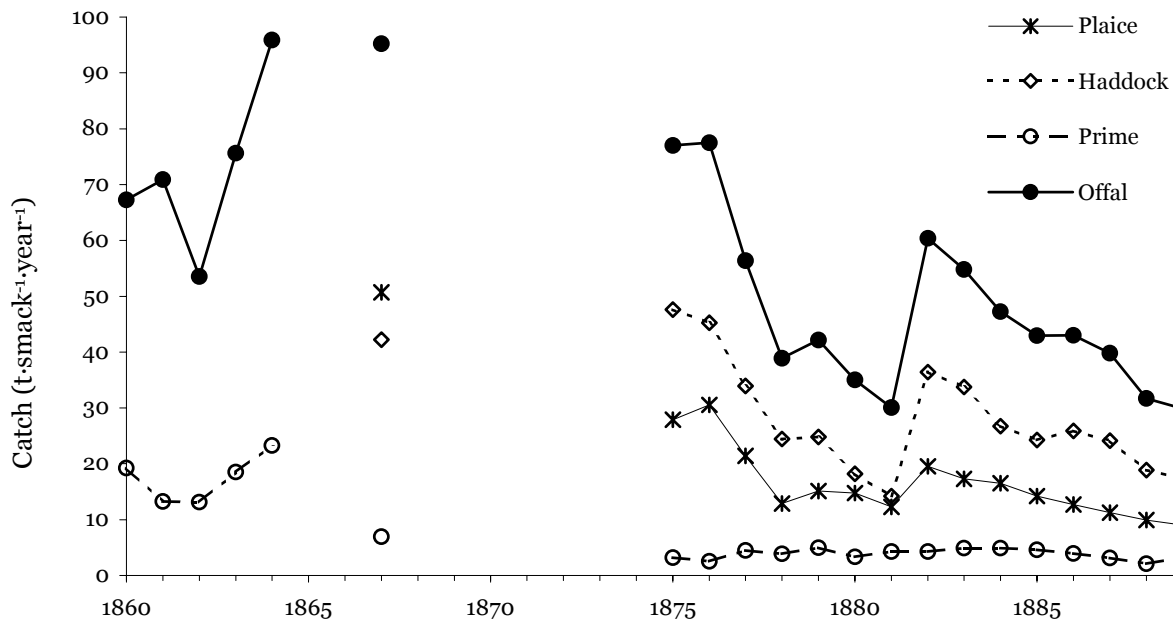

**Figure 1.7.** Changes in catch per vessels of four Grimsby sailing smacks (data from Holdsworth, 1874 and Garstang, 1905).

*Catch per hour (or Sparholt's q) method for selected species based on observed past CPUE data*

Using the same conceptual approach as detailed above, observed values of CPUE in the 1880s ( $U_{past}$ ) were used to estimate a range of possible past biomass values for herring, plaice, sole, haddock, cod, dab, brill and turbot. During

estimation, it was necessary to convert the observed CPUEs to a common unit, catch per hour (Table 1.10). The assumptions used in converting the data were that (a) herring boats fished for 6 months of the year (4,380 hours); (b) trawl voyages duration was a maximum 12 trawling hours; (c) trawling smacks fished for 10 months per year (7,320 hours).

**Table 1.10.** Conversion of CPUE data to standard units ( $t \cdot h^{-1}$ ). Units, values and sources of past CPUE data are listed from various fisheries.

Fishery	Year	CPUE units	CPUE value	Country Source and Reference	CPUE ( $t \cdot h^{-1}$ )
Herring	1880	$t \cdot drifter^{-1} \cdot year^{-1}$	88.0	Holland: Beaujon (1884), in Cushing (1988)	0.020091
Plaice	1892	$t \cdot voyage^{-1}$	0.0714	Holland: Hoek and Kyle (1905)	0.005950
Sole	1892	$t \cdot voyage^{-1}$	0.0086	Holland: Hoek and Kyle (1905)	0.000717
Haddock	1892	$t \cdot voyage^{-1}$	0.0065	Holland: Hoek and Kyle (1905)	0.000542
Dab	1892	$t \cdot voyage^{-1}$	0.0115	Holland: Hoek and Kyle (1905)	0.000958
Cod	1900	$t \cdot voyage^{-1}$	0.0015	Germany: Hoek and Kyle (1905)	0.000125
Brill	1900	$t \cdot voyage^{-1}$	0.0075	Germany: Hoek and Kyle (1905)	0.000625
Turbot	1900	$t \cdot voyage^{-1}$	0.01225	Germany: Hoek and Kyle (1905)	0.001021
Plaice	1875	$t \cdot smack^{-1} \cdot year^{-1}$	27.9	United Kingdom: Garstang (1905)	0.003811
Plaice	1880	$t \cdot smack^{-1} \cdot year^{-1}$	14.8	United Kingdom: Garstang (1905)	0.002022
Haddock	1875	$t \cdot smack^{-1} \cdot year^{-1}$	47.6	United Kingdom: Garstang (1905)	0.006503
Haddock	1880	$t \cdot smack^{-1} \cdot year^{-1}$	18.2	United Kingdom: Garstang (1905)	0.002486
Prime	1875	$t \cdot smack^{-1} \cdot year^{-1}$	3.2	United Kingdom: Garstang (1905)	0.000437
Prime	1880	$t \cdot smack^{-1} \cdot year^{-1}$	3.3	United Kingdom: Garstang (1905)	0.000451
Rough	1875	$t \cdot smack^{-1} \cdot year^{-1}$	77.0	United Kingdom: Garstang (1905)	0.010519
Rough	1880	$t \cdot smack^{-1} \cdot year^{-1}$	35.0	United Kingdom: Garstang (1905)	0.004781

Recent (mid 1980s) estimates of catchability ( $q_{recent}$ ) were obtained from Sparholt (1990) who provides values of 'availability' (catchability) of each fish species, estimated using catch per hour of standard half hour trawl tows together with MSVPA estimates of biomass. For those species whose biomass was not known from independent estimates, (and thus estimates of availability could not be calculated), the availability was simply assumed to be the average availability of similar species (Sparholt, 1990). Biomass estimates were derived for a range of efficiency factors (Table 1.11).

### **Estimation of abundance based on historical research trawl survey**

Data from research beam trawl surveys undertaken in the North Sea during 1902-03 (Garstang, 1905) were used to derive an estimate of biomass using the swept-area method. Net dimensions and average trawling speed were used to determine a swept area of  $0.0592 \text{ km}^2 \cdot \text{h}^{-1}$ . Based on a total of 174 trawling hours, total area towed during surveys was  $10.3 \text{ km}^2$ . Total numbers of fish captured per  $\text{km}^2$  (J. Ellis kindly supplied spreadsheet data) were converted to biomass using average weights of each species determined from biological samples (Table 1.12).

The selectivity of the beam trawl with respect to the type of species captured is taken into account when selecting the various biomass estimates used in model parameterisation (see section below titled 'Balancing the Model'). With regards to the overall efficiency of the trawl, the same assumptions used to derive estimates from commercial catch data were used; the base estimate was multiplied by three efficiency factors, (10, 20 and 30 times, representing trawl efficiencies of 10%, 5% and 3.3% respectively). Abundance estimates for the main commercial species are detailed in Table 1.13, a summary table compiling the range of biomass estimates for finfish in the 1880s using the 3 methods detailed above and a comparison with recent estimates from Sparholt (1990) and Christensen (1995).

Abundance estimates for all other species, based on 1902-03 research trawls, are detailed in Table 1.14. Again, recent estimates from Sparholt (1990) and Christensen (1995) are provided for comparison. Note that for those fish species where no information was available to infer abundance in the 1880s the biomass was taken as that estimated by Sparholt (1990) on the basis of standard trawl surveys (Table 1.14).

**Table 1.11.** Estimates of biomass (t) using Catch per Hour Method for a range of Efficiency Factors. Recent estimates of catchability ( $q_{recent}$ ) were obtained from Sparholt (1990) and applied to observed values of CPUE from the 1880's ( $U_{past}$ ).

Species	$U_{past} (\text{t} \cdot \text{h}^{-1})$	$q_{recent} (\text{mean} \cdot \text{h}^{-1})$	Biomass (t)		
			Efficiency factors (EF)		
			10	20	30
Herring	0.020091	$3.58 \times 10^{-8}$	5,612,102	11,224,203	16,836,305
Plaice (Dutch)	0.005950	$1.65 \times 10^{-8}$	3,606,061	7,212,121	10,818,182
Sole	0.000717	$4.6 \times 10^{-10}$	15,579,710	31,159,420	46,739,130
Haddock	0.000542	$2.13 \times 10^{-7}$	25,430	50,861	76,291
Dab	0.000958	$1.65 \times 10^{-8}$	580,808	1,161,616	1,742,424
Cod	0.000125	$1.29 \times 10^{-7}$	9,690	19,380	29,070
Brill	0.000625	$1.65 \times 10^{-8}$	378,788	757,576	1,136,364
Turbot	0.001021	$1.65 \times 10^{-8}$	618,687	1,237,374	1,856,061
Plaice (UK) 1875	0.003811	$1.65 \times 10^{-8}$	2,309,985	4,619,970	6,929,955
Plaice (UK) 1880	0.002022	$1.65 \times 10^{-8}$	1,225,368	2,450,737	3,676,105
Haddock (UK) 1875	0.006503	$2.13 \times 10^{-7}$	305,293	610,585	915,878
Haddock (UK) 1880	0.002486	$2.13 \times 10^{-7}$	116,730	233,459	350,189

**Table 1.12.** Summary of biological data from North Sea research trawls 1902-1903 (Garstang, 1905).

Common name	Species name	Average weight (kg)	No. measured	Number in each size group (cm)										
				0+	10+	20+	30+	40+	50+	60+	70+	80+	90+	100+
Angel shark	<i>Squatina squatina</i>	-	-	-	-	-	-	-	-	3	-	-	-	-
Angler	<i>Lophius piscatorius</i>	0.86	7	-	-	-	12	6	6	-	2	-	1	-
Blonde ray	<i>Raja brachyura</i>	-	-	-	2	22	4	1	1	-	1	-	-	-
Brill	<i>Scopthalmus rhombus</i>	1.33	30	-	-	26	68	41	20	1	-	-	-	-
Catfish (wolf-fish)	<i>Anarrhichas lupus</i>	2.00	1	-	-	-	1	-	1	1	-	-	-	4
Cod	<i>Gadus morhua</i>	3.14	1,346	-	46	290	548	623	467	262	139	93	63	32
Conger	<i>Conger conger</i>	-	-	-	-	-	-	-	-	-	2	-	2	1
Dab	<i>Limanda limanda</i>	0.07	11,337	134	15,076	5,660	437	6	-	-	-	-	-	-
John dory	<i>Zeus faber</i>	-	-	2	1	2	3	4	-	-	-	-	-	-
Flounder	<i>Platichthys flesus</i>	0.19	52	-	2	74	51	2	-	-	-	-	-	-
Four bearded rockling	<i>Rhinonemus cimbricus</i>	-	-	-	-	2	-	-	-	-	-	-	-	-
Great gurnard	<i>Eutrigula gurnardus</i>	0.12	1,647	2	1,504	2,362	210	2	-	-	-	-	-	-
Haddock	<i>Melanogrammus aeglefinus</i>	0.99	4,348	-	117	2,899	2,665	326	174	79	9	6	1	1
Hake	<i>Merluccius merluccius</i>	3.38	13	-	-	-	-	-	1	1	9	3	-	2
Halibut	<i>Hippoglossus hippoglossus</i>	2.00	1	-	-	-	-	-	1	2	-	-	-	-
Herring	<i>Clupea harengus</i>	-	-	-	6	2	-	-	-	-	-	-	-	-
Homelyn ray (spotted ray)	<i>Raja montagui</i>	-	-	-	12	27	10	8	-	-	-	-	-	-
Horse mackerel	<i>Trachurus trachurus</i>	-	-	-	-	24	15	-	-	-	-	-	-	-
Latchet (tub gurnard)	<i>Trigla lucerna</i>	0.68	326	-	2	146	212	111	32	2	-	-	-	-
Lemon sole	<i>Microstomus kitt</i>	0.42	100	-	50	252	210	22	-	-	-	-	-	-
Lesser spotted dogfish	<i>Scyliorhinus caniculus</i>	-	-	-	-	-	1	4	1	-	-	-	-	-
Ling	<i>Molva molva</i>	10.50	2	-	-	-	-	2	7	7	4	1	1	4
Long rough dab	<i>Hippoglossoides platessoides</i>	0.08	830	-	939	225	-	-	-	-	-	-	-	-
Mackerel	<i>Scomber scombrus</i>	-	-	-	-	1	-	1	-	-	-	-	-	-
Megrim	<i>Lepidorhombus whiffiagonis</i>	-	-	-	1	1	-	-	-	-	-	-	-	-
Parrot gurnard (streaked gurnard)	<i>Trigloporus lastoviza</i>	-	-	-	-	5	-	-	-	-	-	-	-	-
Plaice	<i>Pleuronectes platessus</i>	0.35	26,465	21	8,380	12,664	4,494	908	117	21	-	-	-	-
Porbeagle	<i>Lamna nasus</i>	-	-	-	-	-	-	1	-	-	-	-	-	-

**Table 1.12.** Summary of biological data from North Sea research trawls 1902-1903 (Garstang, 1905).

Common name	Species name	Average weight (kg)	No. measured	Number in each size group (cm)										
				0+	10+	20+	30+	40+	50+	60+	70+	80+	90+	100+
Pout (bib)	<i>Trisopterus luscus</i>	0.08	6	1	101	83	10	1	-	-	-	-	-	-
Ray		-	-	-	-	1	-	-	-	-	-	-	-	-
Rays mixed		-	-	-	-	-	6	9	3	-	-	-	-	-
Red gurnard	<i>Aspitrigla cuculus</i>	0.12	171	1	99	102	2	-	-	-	-	-	-	-
Red mullet	<i>Mullus surmuletus</i>	-	-	-	9	14	-	-	-	-	-	-	-	-
Saithe	<i>Pollachius virens</i>	3.00	1	-	-	-	-	-	2	3	-	-	1	-
Sand sole	<i>Solea lascaris</i>	0.25	4	-	-	4	-	-	-	-	-	-	-	-
Scaldfish	<i>Arnoglossus laterna</i>	-	-	4	50	1	-	-	-	-	-	-	-	-
Shad	<i>Alosa</i>	-	-	-	-	3	1	-	-	-	-	-	-	-
Skate	<i>Raja batis</i>	-	-	-	2	14	11	8	4	2	-	-	1	-
Smooth hound	<i>Mustelus mustelus</i>	-	-	-	-	-	-	2	-	-	-	-	1	-
Sole	<i>Solea solea</i>	0.68	476	-	50	899	437	76	2	-	-	-	-	-
Solenette	<i>Buglossidium luteum</i>	-	-	11	16	-	-	-	-	-	-	-	-	-
Sprat	<i>Sprattus sprattus</i>	-	-	4	15	-	-	-	-	-	-	-	-	-
Spur dog	<i>Squalus acanthias</i>	-	-	-	-	1	74	124	32	31	15	6	3	-
Starry ray	<i>Raja radiata</i>	0.32	59	2	34	30	6	-	-	-	-	-	-	-
Stingray	<i>Dasyastis pastinaca</i>	-	-	-	-	-	-	1	-	-	-	-	-	-
Thickbacks	<i>Microchirus variegatus</i>	0.05	22	-	19	5	-	-	-	-	-	-	-	-
Thornback ray	<i>Raja clavata</i>	1.56	95	7	116	149	152	100	99	31	4	2	-	-
Tope	<i>Galeorhinus galeus</i>	-	-	-	-	-	-	1	-	1	1	4	-	-
Turbot	<i>Scophthalmus maximus</i>	3.46	161	-	-	51	177	74	35	18	5	-	-	-
Weever	<i>Trachinus vipera</i>	-	-	-	-	102	17	-	-	-	-	-	-	-
White skate	<i>Raja alba</i>	-	-	-	-	-	-	1	-	-	-	-	-	-
Whiting	<i>Gadus merlangus</i>	0.19	9,020	5	1,182	11,970	1,549	67	9	3	-	-	-	2
Witch	<i>Glyptocephalus cynoglossus</i>	-	-	-	-	11	4	4	-	-	-	-	-	-



**Table 1.13.** Comparison of the range (min/max EF) of abundance estimates for commercial finfish species in the 1880s using the three methods detailed in text (Catch per Hour, Catch per Boat, and Schaefer) and a comparison with recent abundance estimates from Sparholt (1990) and Christensen (1995).

Species	Catch per Hour (Sparholt's q)		Catch per Boat		Schaefer	Garstang (1905)		Sparholt (1990)	Christensen (1995)
	Min (EF=10)	Max (EF=30)	Min (EF=10)	Max (EF=30)		Min (EF=10)	Max (EF=30)		
Herring	5,612,102	16,836,305	-	-	500,000 - 1,000,000	1,330	3,990	1,326,500	476,520
Plaice	1,225,368	10,818,182	538,285	1,614,856	487,826 -1,438,237	1,186,970	3,560,910	475,000	363,660
Sole	15,579,710	46,739,130	48,863	146,590	100,000+Huge	181,630	544,890	60,000	43,320
Haddock	116,730	915,878	2,450,588	7,351,765	673,434	417,310	1,251,930	553,000	474,240
Dab	580,808	1,742,424	-	-	-	717,770	2,153,310	1,598,000	-
Cod	9,690	29,070	2,602,410	7,807,231	-	809,110	2,427,330	236,500	324,330
Brill	378,788	1,136,364	-	-	-	28,710	86,130	4,000	-
Turbot	618,687	1,856,061	-	-	-	38,410	115,230	5,000	-
Whiting	-	-	302,662	453,993	-	570,340	1,711,020	418,500	374,490
Mackerel	-	-	49,406	148,217	-	390	1,170	438,000	264,480

**Table 1.16.** Range of North Sea biomass estimates used in the 1880s model.

Species	Biomass (t·km <sup>-2</sup> )			Estimation Method		Biomass (t)		
	Min	Middle	Max	Min est. ref.	Max est. ref.	Min	Middle	Max
Herring	9.846	19.692	29.537	Catch per hour (Sparholt's q)	Catch per hour (Sparholt's q)	5,612,102	11,224,203	16,836,305
Plaice	2.082	4.165	6.247	Garstang 10x	Garstang 30x	1,186,970	2,373,940	3,560,910
Sole	0.319	0.637	0.956	Garstang 10x	Garstang 30x	181,630	363,260	544,890
Haddock	0.205	0.906	1.607	Catch per hour (Sparholt's q)	Catch per hour (Sparholt's q)	116,730	516,304	915,878
Dab	1.019	2.038	3.057	Catch per hour (Sparholt's q)	Catch per hour (Sparholt's q)	580,808	1,161,616	1,742,424
Cod	1.419	2.839	4.258	Garstang 10x	Garstang 30x	809,110	1,618,220	2,427,330
Brill	0.665	1.329	1.994	Catch per hour (Sparholt's q)	Catch per hour (Sparholt's q)	378,788	757,576	1,136,364
Turbot	1.085	2.171	3.256	Catch per hour (Sparholt's q)	Catch per hour (Sparholt's q)	618,687	1,237,374	1,856,061
Whiting	0.265	0.531	0.796	Catch per boat	Catch per boat	151,331	302,662	453,993
Mackerel	0.087	0.173	0.260	Catch per boat	Catch per boat	49,406	98,811	148,217

**Table 1.14.** Comparison of abundance estimates derived from Swept-area Method based on 1902-03 research trawls (Garstang, 1905) and recent estimates from Sparholt (1990) and Christensen (1995).

Common name	Species name	Garstang (1905)			Sparholt (1990)	Christensen (1995)
		Efficiency Factors (EF)				
		10	20	30		
Angel shark	<i>Squatina squatina</i>	145,307	290,615	435,922	-	-
Anglerfish	<i>Lophius piscatorius</i>	11,411	22,821	34,232	15,500	-
Argentine	<i>Argentina sphyraena</i>	-	-	-	16,000	-
Bib (pout)	<i>Trisopterus luscus</i>	23,012	46,025	69,037	10,500	-
Blonde ray	<i>Raja brachyura</i>	81,031	162,061	243,092	1,500	-
Blue whiting	<i>Micromesistius poutassou</i>	-	-	-	67,000	-
Chimaera	<i>Chimaera monstrosa</i>	-	-	-	2,500	-
Conger	<i>Conger conger</i>	20,290	40,581	60,871	-	-
Cuckoo ray	<i>Raja naevus</i>	-	-	-	23,500	-
Dragonets	<i>Callionymidae</i>	-	-	-	10,000	-
Flounder	<i>Platichthys flesus</i>	3,520	7,040	10,560	19,000	-
Fourbeard rockling	<i>Rhinonemus cimbricus</i>	369	738	1,107	1,000	-
Greater argentine	<i>Argentina silus</i>	-	-	-	1,500	-
Great (grey) gurnard	<i>Eutrigula gurnardus</i>	100,506	201,012	301,517	97,000	-
Hake	<i>Merluccius merluccius</i>	-	-	-	6,500	-
Halibut	<i>Hippoglossus hippoglossus</i>	-	-	-	3,000	-
Hooknose	<i>Agonus cataphractus</i>	-	-	-	1,000	-
John dory	<i>Zeus faber</i>	10,927	21,855	32,782	-	-
Lemon sole	<i>Microstomus kitt</i>	73,424	146,848	220,272	194,000	-
Lesser spotted dogfish	<i>Scyliorhinus caniculus</i>	18,471	36,942	55,413	2,500	-
Ling	<i>Molva molva</i>	40,769	81,538	122,308	35,500	-
Long rough dab	<i>Hippoglossus platessoides</i>	35,778	71,556	107,334	224,000	-
Longspined bullhead	<i>Taurulus bubalis</i>	-	-	-	1,000	-
Lump sucker	<i>Cyclopterus lumpus</i>	-	-	-	1,500	-
Megrim	<i>Lepidorhombus whiffiagonis</i>	378	757	1,135	24,500	-
Norway haddock	<i>Sebastes viviparus</i>	-	-	-	27,000	-
Norway pout	<i>Trisopterus esmarkii</i>	46	92	139	1,197,000	-
Ocean perch	<i>Sebastes marinus</i>	-	-	-	500	-
Parrot gurnard (streaked grunard)	<i>Trigloporus lastoviza</i>	1,886	3,772	5,658	-	-
Pollack	<i>Pollachius pollachius</i>	-	-	-	31,000	-
Poor cod	<i>Trisopterus minutus</i>	-	-	-	35,000	-
Rays		-	-	-	-	300,960
Red gurnard	<i>Aspitrigla cuculus</i>	13,040	26,080	39,120	-	-
Red mullet	<i>Mullus surmuletus</i>	1,206	2,413	3,619	-	-
Saithe	<i>Pollachius virens</i>	1,664	3,328	4,992	496,500	372,210
Sandeel	<i>Ammodytes marinus</i> +other	-	-	-	1,818,500	1,468,890
Sand sole	<i>Solea lascaris</i>	555	1,109	1,664	-	-
Scad (horse mackerel)	<i>Trachurus trachurus</i>	8,875	17,750	26,625	795,500	-
Scaldfish	<i>Arnoglossus laterna</i>	3,350	6,699	10,049	-	-
Sea-snail	<i>Liparis liparis</i>	-	-	-	500	-
Shagreen ray	<i>Raja fullonica</i>	-	-	-	500	-

**Table 1.14.** Comparison of abundance estimates derived from Swept-area Method based on 1902-03 research trawls (Garstang, 1905) and recent estimates from Sparholt (1990) and Christensen (1995).

Common name	Species name	Garstang (1905)			Sparholt (1990)	Christensen (1995)
		Efficiency Factors (EF)				
		10	20	30		
Shorthorn sculpin	<i>Myoxocephalus scorpius</i>	-	-	-	2,500	-
Silvery cod	<i>Gadiculus argenteus</i>	-	-	-	2,000	-
Skate	<i>Raja batis</i>	159,749	319,498	479,246	24,000	-
Solenette	<i>Buglossidium luteum</i>	1,025	2,050	3,075	500	-
Smooth hound	<i>Mustelus mustelus</i>	61,592	123,184	184,776	-	-
Spotted ray (homelyn ray)	<i>Raja montagui</i>	28,577	57,155	85,732	11,500	-
Sprat	<i>Sprattus sprattus</i>	31	62	93	198,000	310,650
Spurdog	<i>Squalus acanthias</i>	285,468	570,936	856,403	29,500	-
Starry ray	<i>Raja radiata</i>	1,072	2,144	3,215	195,000	-
Stingray	<i>Dasyastis pastinaca</i>	3,661	7,322	10,983	-	-
Thickback sole	<i>Microchirus variegatus</i>	501	1,002	1,502	-	-
Thornback ray	<i>Raja clavata</i>	219,273	438,547	657,820	47,000	-
Three-beard rockling	<i>Gaidropsarus vulgaris</i>	-	-	-	500	-
Tope shark	<i>Galeorhinus galeus</i>	199,337	398,673	598,010	1,000	-
Tub gurnrd	<i>Trigla lucerna</i>	21,845	43,689	65,534	1,000	-
Tusk	<i>Brosme brosme</i>	-	-	-	2,000	-
Weever	<i>Trachinus vipera</i>	50	101	151	17,000	-
Witch	<i>Glyptocephalus cynoglossus</i>	1,990	3,979	5,969	19,500	-
Wolf-fish	<i>Anarhichas lupus</i>	1,109	2,219	3,328	10,500	-
White skate	<i>Raja alba</i>	23,269	46,538	69,807	-	-

***Inferring the abundance of bluefin tuna, sturgeon, salmonids, other finfish, crabs and lobsters known to be caught on a regular basis in the 1880s***

The presence of bluefin tuna in the North Sea was already recognised during the last decades of the nineteenth century. Bluefin tuna landings from the Central North Sea were recorded by French fishers as early as 1907, later by Swedish fishers and others (Thiel, 1938; Pauly, 1995). These reports, however, were usually from a side fishery in connection with herring or game fisheries. A systematic bluefin tuna fishery developed only after the second World War with purse seines off the Norwegian coast and with hook and line in Denmark, Sweden and the Federal Republic of Germany (Tiews, 1978).

In the absence of a more suitable parameter to estimate the population of bluefin tuna in the Northeast Atlantic waters, Tiews (1978, p. 304) used catch as an abundance index. Total population was estimated under the assumption of a fishing mortality of 10%, a certain

justification for which can be made on the basis of tagging data and returns by year and area. The total population size is expressed in the number of fish weighing on average, 200 kg each for the period 1951-1962, and 300 kg each for the period 1963-1972. It is estimated that only 40-50% of the tuna population migrated to the Central North Sea to feed for half the season only. Assuming a fishing mortality of 10%, the maximum population estimate for the Central North Sea is 710,000 in 1952 based on landings of 71,000 fish (Tiews, 1978). Assuming the same population size in 1880, with an average weight 250 kg per fish gives a biomass of 177,500 t.

Estimates of population biomass were inferred by assuming that historical catch was, at maximum, 10% of the total population (Table 1.15). Buckland *et al.* (1878) made the assumption that perhaps only 5% of the cod in the sea were actually caught, thus our assumption of a maximum catch of 10%, errs on the side of caution, and is more likely to provide underestimates of total population rather than overestimates.

**Table 1.15.** Estimates of North Sea population biomass based on assumed 10% exploitation rate.

Species	Year	Average catch (t)	Population biomass (t)
Salmon	1850-1865	496	4,965
Sturgeon	1885 & 1887	171	1,710
Crabs	1886 -1890	3,674	36,742
Lobster	1876 -1890	338	3,381
Halibut	1886 - 1890	5,787	57,870
Tusk	1886 - 1890	450	4,501
Conger eel	1886 - 1890	124	1,239
Sprat, herring & anchovies	1886 - 1890	4,897	48,973
Saithe (coalfish) and pollack	1886 - 1890	3,621	36,212
Hake	1892 - 1895	965	9,650

### ***Biomass values used for input in the 1880s model***

None of the biomass estimations made using the surplus production model fitting were used as input, as the method was considered unreliable, for two reasons. First, the data were confounded by the rapid changes in catchability occurring at that time, and secondly, when attempts were made to truncate the data to avoid large changes in CPUE resulting from changes in efficiency, the model was not capable of finding a suitable fit of observed to predicted CPUE because the data series were too short and did not show enough contrast.

For those species/groups where several estimates of biomass were derived from different methods (Catch per Boat, Catch per Hour and Garstang's trawl surveys), it was necessary to use a strategy for directing the selection of biomass values for input in the 1880s North Sea model. To avoid grossly overestimating past biomass of groups, a conservative strategy using 3 selection criteria was employed. The selection criteria were:

1. From each estimation method, unless other criteria were more relevant, the lowest value in each category, (minimum, middle and maximum) was chosen;
2. Where several estimates were given for a single group, selection of the estimate was guided by the method deemed most reliable, according to either the completeness of fisheries information (for CPUE based methods) or the degree of error likely to be due to sampling (e.g., beam trawls are not appropriate for sampling pelagic fish);
3. Comparison with recent (presumably more reliable) stock size estimates given by Sparholt (1990) and Christensen (1995) to ensure that selected estimates were 'grounded' and at least appropriate 'ball park' figures.

Table 1.16 summarises the biomass values, and estimation methods, selected for input to the model. A brief discussion of the rationale for the selection of biomass for each species follows:

*Cod:* Whilst the lowest estimates for cod were from Catch per hour method, these were considered too low in comparison with recent estimates, hence the next lowest, the Garstang trawl survey values were chosen.

*Mackerel:* The Garstang trawl survey estimates are likely to underestimate because its selectivity (only 1 mackerel was caught). The catch per boat method was applied even though the estimate is considerably below more recent estimates given by Sparholt (1990) and Christensen (1995).

*Turbot and brill:* Although the Garstang trawl survey estimates were lowest, they were based on very few fish caught, 39 brill and 20 turbot, hence the value from the catch per hour method was applied.

*Dab:* Highest in abundance of the species caught by Garstang trawl surveys. The catch per hour method predicted very similar numbers. These were used as a conservative estimate.

*Haddock:* Similar estimates were predicted for the catch per hour method and Garstang trawl surveys. The lower of the two values (catch per hour method) was used. The middle value of both estimates was close to the estimate given by Sparholt (1990).

*Herring:* The only estimate for herring biomass is from the catch per hour method.

*Plaice and sole:* Both plaice and sole are well represented in the Garstang beam trawl surveys, and thus the estimates used are considered

reasonable. Catch per hour methods implied biomasses considered way too high, whilst the minimum catch per boat method predicted values closer to recent estimates.

Biomass estimates of all other species are detailed in sections above.

### ***Biomass of juveniles***

The biomass of juveniles is estimated in Ecopath, based on assumption that  $EE=0.95$ , with the P/B and Q/B values of the juveniles two times and 1.5 times those of adults, respectively.

### ***Estimating the numbers of marine mammals***

From Buckland (1878, p. 169),

*“There still exists along the north-east British coasts, a considerable number of whales. These whales are not the Whalebone or Right whale (Balaena mysticetus) of the Arctic seas, but the Finner whale (Balaena boops or Physalus boops), called by the Icelanders the “Nord Caper”, the “Herring balein”. They are larger than the Whalebone whale. Specimens from 30-70 feet are not uncommon. Unlike the whalebone whale they do not feed on the Clio borealis and other minute creatures in the ocean, but are purely fish eaters, feeding especially on the herrings, of which, without doubt, they consume an enormous number...”* p. 170 *“The fishermen do not appear to regard these whales as inimical to their interests\*. The whales act as scouts and sentries and will inform the fleets of fishing boats when and where the armies of herrings are passing along their fishing grounds. The whales are also said to feed at the edge of the shoals thus keeping the fish together pretty closely. A blowing of whales in the offing is therefore a sign that is welcomed by local fishermen.”*

*\* “I have more than once called the attention of the public to the splendid sport that might be obtained by shooting or harpooning these herring whales on the East coast of Scotland during the autumn months”. [original footnote]*

There is very little recent quantitative evidence of the numbers of cetaceans present in North Sea, although a recent ICES study group has started working on stock assessment. Whilst porpoises and dolphins are likely common in most areas of the North Sea, it appears from whaling statistics

and recent ICES reports (Anon., 1999c) that the larger whales are generally restricted to the Northern North Sea and further north. Since we have very little evidence on recent stock size, and the amount of time that the larger whales spend in the North Sea, the minimum abundance of whales assumed to be present in the North Sea (for an undetermined proportion of the year) in the 1880s was based on the reported killings at Shetland whaling station 1904-1911 (Thompson, 1912; Table 24, p. 34 Appendix 1).

From 1904 to 1911, the rorqual or finner whale formed the bulk of the catch at Shetland. It was the most common whale seen. Blue whales were rare at Shetland but more abundant in Hebrides, where the fin whale was less common. The humpback whale was reckoned a very rare wanderer to our coasts in former times, the great Tay whale of 1883 being one of 3 or 4 known examples, but it was caught regularly in moderate numbers both at Shetland and the Hebrides. Sperm whales were rare at Shetland and it is curious to note that all whales caught were males of considerable size. Feeding on cuttlefish, the smaller Ca'ing (pilot) whale were not valuable but were of considerable importance to inhabitants of Faroe and Orkney Islands where they were (are) rounded up when they came ashore in the summer months. Beluga whales, a northern species, was said to be a fish eater – especially of salmon. The Dundee whalers brought ashore a considerable number of white whales, chiefly from the neighbourhood of Cumberland Gulf (Thompson, 1912).

*“The industry is prosperous, and the demands for its products appear to increase continually. It is certain that it cannot long continue without making an impression on the numbers of whales of the various species.”*

D'Arcy Thompson (1912, p. 394).

Some indication of the relative commonness or rarity of species can be gleaned from the reports of cetaceans stranded on the British coasts (Harmer, 1927) (Table 1.17 and Figure 1.8). Porpoises and dolphins were the most common of the whales and are likely to have been relatively abundant. Numbers are guessed (I believe conservatively) at being 3000. Killer whales also occur in the North Sea, albeit infrequently. Their abundance is guessed as having been 50 individuals. Biomass was determined based on average weights of individuals from Trites *et al.* (1999). Further details on whales are provided in Part 2.

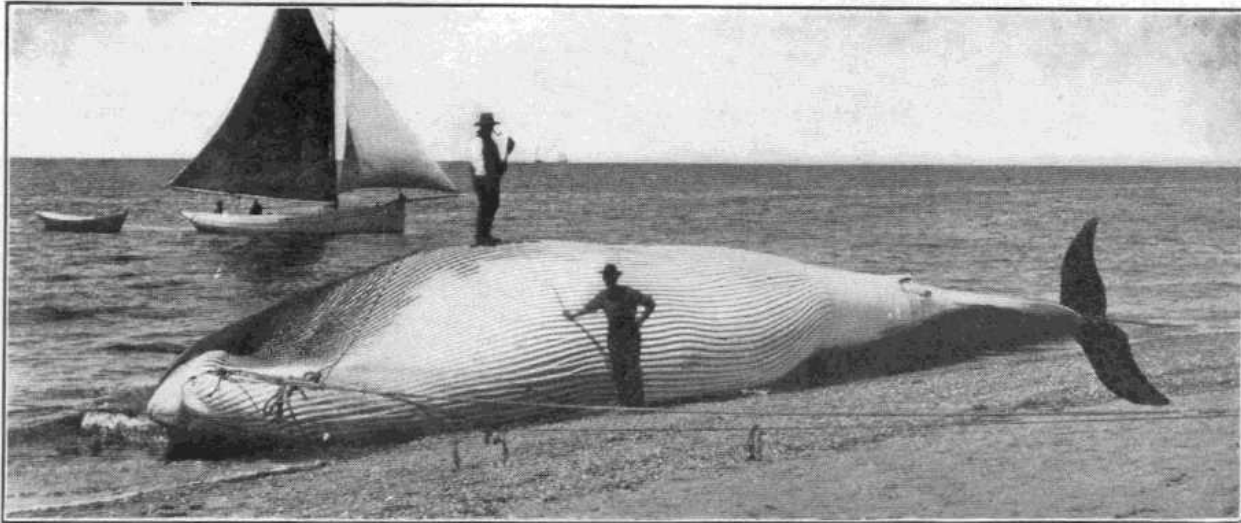

Figure 1.8. Stranded fin (rorqual) whale east coast of US. (True, 1904)

**Table 1.17.** Total number of cetaceans stranded on the British coasts 1913-1926 (Harmer, 1927).

Species	Total number stranded
Common porpoise	178
Common dolphin	42
White beaked dolphin	30
Lesser Rorqual	29
Bottlenose dolphin	25
Fin (Rorqual) whale	24
Bottlenose whale	20
Cuviers whale	11
Rissus dolphin	9
Pilot (Ca'ing) whale	8
White sided dolphin	8
Killer whale	7
Sowerbys whale	5
Blue (Sibbaldi's) whale	4
Sei whale	3
Sperm whale	3
True's beaked whale	1

In an early account of seals in British waters Southwell (1881) claimed that common seals occurred in "greatly reduced numbers" as a result of hunting but were nevertheless "still abundant" in Orkney, Shetland and the Hebrides and that many young ones were born in the Wash. He reported that the chief places of resort of grey seals were Orkney, Shetland, the Hebrides, and

the west coast of Ireland, although they were known to breed at the Farne Islands (Figure 1.4a) also. He gave little indication of the size of the population. Only Evans and Buckley (1899) when reporting that the common seal was much more numerous than the grey seal in Shetland, conceded that this may have been an erroneous impression resulting from the more inaccessible hunts of the grey seal. Best estimates of the historical numbers of seals are derived from Rae (1960) who compiled data various sources including those mentioned above (see Part 2).

#### ***Estimating parameters for lower trophic levels***

No specific information is available for these groups in the 1880s period. Values were derived from historical reports where possible and supplemented with more recent information in lieu of any better data (see Part 2 for details).

#### ***Parameters linking adult and juvenile groups (for use in Ecosim simulations)***

Ecosim requires additional parameters to link adults with their respective juvenile groups. During simulations account is kept of the numbers that recruit from the juvenile to the adult stages and the number at age/size in the adult group. A recruitment function dependent on adult numbers, biomass and food consumption is used to predict the number of juveniles at age zero (see Table 1.18).

**Table 1.18.** Parameters linking adult and juvenile groups in Ecosim.

Parameters	Sharks (dogfish)	Rays and skates <sup>a</sup>	Cod	Whiting	Saithe	Haddock
Min time as juvenile	5	7	3	1	3	2
Max time as juvenile	10	15	6	3	6	3
Age at transition to adult group	6.5 <sup>b</sup>	10 <sup>d</sup>	5 <sup>h</sup>	2 <sup>k</sup>	4.6 <sup>b</sup>	2.5 <sup>n</sup>
Length at transition (cm)	67 <sup>c</sup>	86 <sup>e</sup>	75 <sup>i</sup>	28 <sup>l</sup>	55.4 <sup>b</sup>	33 <sup>l</sup>
K of the VBGF (based on L <sub>inf</sub> below)	0.15 <sup>b</sup>	0.14 <sup>f</sup>	0.2 <sup>j</sup>	0.207 <sup>m</sup>	0.07 <sup>b</sup>	0.2 <sup>j</sup>
L <sub>inf</sub> (cm)	90 <sup>b</sup>	118 <sup>g</sup>	132 <sup>j</sup>	47.5 <sup>s</sup>	177 <sup>b</sup>	68.3 <sup>b</sup>
Average adult weight (kg) ( <i>from Garstang 1905</i> )	2	2	4.8	0.19	4	0.99
<i>Length-Weight relationships</i>	p	e	p	p	p	p
a	0.0058	0.00515	0.0175	0.0093	0.0238	0.0157
b	2.89	3.238	2.8571	2.9456	2.7374	2.8268
Weight at transition (kg)	1.098	9.456	3.984	0.170	1.410	0.308
Average adult weight/ weight at transition	1.82	0.21	1.20	1.11	2.83	3.21

<sup>a</sup>Based on thornback ray. Starry ray is most common but thornback is larger - thus accounting for the larger skates (average weight 13.6kg according to Garstang, 1905); <sup>b</sup>Jennings *et al.*, 1997; <sup>c</sup>Ketchen, 1975; <sup>d</sup>Anon., 1997; <sup>e</sup>Dorel, 1985; <sup>f</sup>Walker *et al.*, 2000; <sup>g</sup>FishBase; <sup>h</sup>Holt, 1893 in Daan, 1978; <sup>i</sup>Beverton and Holt, 1957, based on Graham, 1923; <sup>j</sup>Beverton and Holt, 1957; <sup>k</sup>Myers *et al.*, 1995; <sup>l</sup>Jones and Hislop, 1975; <sup>m</sup>Jones and Hislop, 1975, based on data for 1967; <sup>n</sup>Sahrhage and Wagner, 1978; <sup>p</sup>Coull *et al.*, 1989.

### **Fisheries catches**

Fisheries catch data was derived from various sources, detailed in Part 2 (under 'Harvest') for each species. Table 1.19 summarises the fisheries' catch by species and gear type. 'Various others' include seines, fixed 'set' nets and boats using a variety of fishing techniques/gears on a seasonal basis.

### **Diet composition data sources**

Given that changes in the relative abundance and assemblages of species that has occurred between 1880 and 1980, where possible, diet composition data was compiled from historical sources. For those species where historical information could not be obtained, data from the 1980s model and recent MSVPA estimates (V. Christensen, Fisheries Centre, UBC, pers. comm.) were used. For new or other groups, where quantitative information on diets was lacking, diet compositions were constructed from qualitative information and 'educated guesses' (Table 1.20, also see Part 2 for more details).

**Table 1.19.** Fisheries catch and gear type used in the 1880s North Sea model.

Group	Catch (t·km <sup>-2</sup> )	Gear type
Seals	0.0001	Seal hunting
Sharks	0.0001	Trawlers and Liners
Rays and skates	0.0034	Trawlers and Liners
Tuna	0.0006	Various others
Sturgeon	0.0003	Trawlers and Liners
Cod	0.0526	Trawlers and Liners
Whiting	0.0060	Trawlers and Liners
Saithe	0.0064	Various others
North Sea mackerel	0.0005	Various others
Western mackerel	0.0016	Various others
Haddock	0.1986	Trawlers and Liners
Herring	0.3110	Drifters
Sprat	0.0086	Various others
Plaice	0.0567	Trawlers and Liners
Sole	0.0053	Trawlers and Liners
Brill	0.0010	Trawlers and Liners
Halibut and turbot	0.0149	Trawlers and Liners
Salmon and seatrout	0.0009	Various others
Gurnards	0.0012	Trawlers and Liners
Other pred fish	0.0159	Trawlers and Liners
Other prey fish	0.1025	Trawlers and Liners
Lobsters and edible crabs	0.0070	Crab and lobster pots

**Table 1.20.** Summary of information sources for diet matrix in the 1880s North Sea model.

Species	Measure	Reference
Cetaceans	Qualitative	Anon. (1999c)
Seals	% stomach containing food; qualitative	Rae (1968); Millais (1906)
Birds	% stomach containing food	Rae (1969)
Sharks (dogfish)	% stomach containing food	Rae (1967b)
Rays and skates	% freq. occur (skate); proportion (rays); composite diet constructed	Smith (1890) (skate); MSVPA (rays)
Bluefin tuna	Constructed on qualitative account	Tiews (1978)
Sturgeon	Constructed on qualitative account	FishBase (ref 9988)
Cod (adults and juvenile)	% stomachs containing food; proportion (from MSVPA)	Rae (1967a); MSVPA; Christensen (1995)
Whiting	% weight	Jones (1954); MSVPA; Christensen (1995)
Saithe	% volume	MSVPA and Christensen (1995)
Mackerel	% volume	MSVPA and Christensen (1995)
Haddock	% frequency occurrence; % weight	Smith (1890); Jones (1954); MSVPA (for juveniles)
Norway pout	% frequency occurrence	Gokhale (1953)
Plaice	% frequency occurrence	Smith (1890)
Sole	% volume; % frequency occurrence	Rae (1956); Smith (1890)
Halibut	% volume	McIntyre (1952)
Horse mackerel	% volume	MSVPA diet
Gurnard	% frequency occurrence; MSVPA	Smith (1890); MSVPA
Other prey fish (based on dabs)	% frequency occurrence	Smith (1890) and Christensen (1995)
Other predators (based on angler fish and long rough dab)	% frequency occurrence	Smith (1890)
Cephalopod (based on squid)	% volume	Karpov and Cailliet (1978)

### BALANCING THE 1880S MODEL

Before proceeding with the balancing of model parameter estimates, it was necessary to adjust parameters for birds and juvenile sharks to satisfy demands required of the estimation routine. It was not possible for the routine to estimate the biomass of birds or juvenile sharks since neither group had any predators specified. Thus, a biomass of 0.01 t·km<sup>-2</sup> was given to birds and juvenile sharks were included in the diets of seal, sharks, halibut and turbot, and other predatory fish. The small proportions of diets assigned to juvenile sharks were taken from the main prey item of each of the predators.

Initial results of the Ecopath parameter estimation routine revealed several groups for which 'demand' was greater than 'supply', as indicated by ecotrophic efficiency greater than 1 (Table 1.21).

**Table 1.21.** List of unbalanced groups with Ecotrophic Efficiency (EE) > 1 (indicating demand was greater than supply) according to initial parameter estimation in Ecopath.

Species group	EE
Seals	14.901
Whiting	4.858
North Sea mackerel	74.577
Western mackerel	27.725
Sprat	10.055
Sandeel	1.644
Sole	1.109
Salmon and seatrout	15.647
Other predatory fish	4.259
Other prey fish	3.081
Euphausiids	14.259
Echinoderms	1.095
Polychaetes	2.593
Other macrobenthos (bivalves, gastropods)	1.490
Meiofauna (other invertebrates)	1.734
Benthic microflora	3.295
Phytoplankton (autotrophs)	1.828
Detritus (DOM and POM)	14.252



Having estimated a range of biomass values for each of the required species using the methods presented above, the Monte Carlo Ecoranger routine of Ecopath was used in an initial attempt to examine a range of 'possible' balanced models. For each of the Ecoranger runs, the middle value of the min-max range of biomass estimates was taken as starting biomass and consequently the runs were set to examine the possible values based on uniform distribution between the range.

The results from the Ecoranger runs were not encouraging. No balanced models were found in any of the realizations (over 10,000). Furthermore, on examination of the adjusted parameters in the 'best unbalanced model', it was found that the parameters estimates were not realistic at all. In most cases, the ecotrophic efficiency values that were already too high simply increased twofold. Based on these results, it was decided to balance the model 'by hand'. This meant that it was not possible, in the model presented here, to examine a range of biomass estimates. Rather, the middle value of biomass was chosen (Table 1.22) and the model was balanced on this basis.

Two strategies were used to try and balance the 1880s model. The first, called 'top down' strategy was used in an attempt to maximise the biomass in the system by adjusting the biomass of each groups such that they should meet the demands of the predator group. The justification for changing the biomass is due to the high uncertainty associated with the biomass estimates. Many of which are likely underestimates. For example, where biomass estimates are derived based on an assumption of 10% fishing mortality, the underestimates on catches result in underestimates of the population. Furthermore, in the case where catches were derived by CPUE methods, the efficiency factors used in raising the biomass are considered to be conservative. Whilst it was possible to account for biomass within the fish groups alone, this method resulted in an explosion of food requirements at the lower trophic levels. These requirements exceeded the initial parameter estimates by 1000 fold in some cases. Clearly, such a result is unrealistic and points to the need to make a conscious effort during model balancing such that not only should the accounts tally, but more importantly they must make sense in terms of ecology and biological rates. This aspect cannot be stressed enough and should serve as a warning to would-be users who may approach balancing as merely a necessary modelling procedure detached from ecology.

The second strategy used a holistic approach to balance the model from both 'top down' and 'bottom up' such that predator demands were met by realistic productivity of prey. When deemed necessary, predator biomass or consumption rates were reduced to alleviate demand on prey. A key part of the balancing procedure was determining which parameters were sensitive to change. Two 'anchor groups' were the key to the model balancing strategy. The first was herring. Being at mid-trophic level and with a very large estimated biomass, their importance in reconciling demands from top predators with primary production in the North Sea was critical. A particular effort was made to ensure the biomass of herring remained reasonable. For this reason, it was necessary during balancing to reduce the biomass of some top predators.

The second reference point, key to balancing the model, was phytoplankton production. It is believed that the estimate of primary productivity is a good estimate. Assuming by default that there was no change in average primary production between 1880 and recent times, the primary productivity served as foundation which all higher consumption should tally with.

Swinging between these two anchor points, the adaptive balancing strategy flipped from 'top down' to 'bottom up' during more than 40 iterations. An important part of the process of reconciling production and consumption at the lower trophic levels was the fine-tuning of the diet matrix for all groups from zooplankton down to benthic and planktonic micro flora. Since there is little specific information on the diets of these groups, best judgement was used in the construction of the diets. They were not simply manipulated to force a balanced model; rather they are believed to represent realistic diets. Given that the demand on primary production does not exceed the initial estimates, this provides some tentative confirmation that the diet estimates are in the right 'ball-park'. The final diet matrix from the balanced model is given in Table 2.21.

One of the biological cross checks that can be used during balancing is the gross food conversion efficiency, GE, the ratio between the total production and total food consumption. This ratio is for most vertebrate groups constrained physiologically to the range from 0.05 to 0.25, whereas it can be higher for some groups of small invertebrates and fish larvae, (e.g., for coral reefs, bacteria, nauplii, fish larvae and other small, fast-growing organisms). Results from the 1980 model showed that GE's were unrealistically high for

three of the four gadoid species (cod with 35%, whiting 24%, and haddock 36%). Efficiencies in the range of 5-15%, depending on species, size, food type etc., are much more realistic for fish groups (Paloheimo and Dickie, 1966; Jones, 1982). During balancing of the present 1880s model, P/B and Q/B rates were modified slightly to achieve more reasonable estimates of GE for these species.

P/B's were reduced based on the assumption of a population consisting of older larger individuals with lower productivity rates and also consumption rates.

*“When mortality rates increase for a population the population structure will typically change from being dominated by older individuals towards younger individuals. Younger, smaller individuals will have higher Q/B rates than older, and hence if the P/B increases so will the Q/B.”*

Christensen et al. (2000).

Justification for this is based on a comparison of the length frequency distribution of fish caught from trawl surveys in 1902-1903 (Garstang, 1905) with contemporary research surveys (conducted by CEFAS). P/B for juveniles were maintained at 2 times that of the adult, whilst Q/B ratios were reduced slightly to from 2 to 1.5 times that of adults. The result was juvenile GE (gross efficiency, P/Q) rates were raised above that of adults (as might be expected) and demand on lower trophic levels was reduced. Other noteworthy changes include:

1. Doubling the biomass of seals;
2. Ten fold increase in the biomass of mackerels. Now at 1.76 t·km<sup>-2</sup>. Value is 2 times Sparholt's estimate (0.768 t·km<sup>-2</sup>);
3. Doubling the biomass of crabs and lobsters;
4. Doubling salmon and seatrout;
5. Haddock increased biomass to 1.2 t·km<sup>-2</sup> (684,000 t). Sparholt estimate 0.97 t·km<sup>-2</sup>;
6. Sprat biomass increased from 0.0859 to 1.35 t·km<sup>-2</sup>. Sparholt Estimate (0.347), Christensen Estimate (0.545);
7. Zooplankton increased biomass. P/B and Q/B rates set to just above those of the 1980s model;
8. Euphausiids biomass increased;
9. Macrobenthos (echinoderms, polychaetes and other macrobenthos) each increased by about 3 times;
10. GE's for bottom end trophic levels increased. Note that this artificially takes demand off the plankton group.

A summary of changes made to parameters during model balancing and basic parameter estimates from the balanced Ecopath model are shown in Tables 1.22 and 1.23 respectively.

**Table 1.22.** Comparison of original basic input data with parameters used to derive a balanced model (values in brackets are those used in the balanced model). Type of feeding, Production/Biomass (P/B); Consumption/Biomass (Q/B); Ecotrophic Efficiency (EE); Production/Consumption (GE).

Group Name	Type <sup>a</sup>	Biomass (t·km <sup>-2</sup> )		P/B· (year <sup>-1</sup> )		Q/B· (year <sup>-1</sup> )		EE	GE
Cetaceans	0		0.293		0.020		13.550	-	-
Seals	0	0.001	(0.002)		0.060		28.500	-	-
Seabirds	0		0.010		0.400		107.000	-	-
Sharks	0		1.246		0.150		6.000	-	-
Sharks juveniles	0		-		0.300	12	(9)	0.950	-
Rays and skates	0		0.906		0.320		2.900	-	-
Rays juveniles	0		-		0.640	5.8	(4.35)	0.950	-
Tuna	0		0.311		0.340		4.000	-	-
Sturgeon	0		0.003		0.110		1.610	-	-
Cod	0	2.838	(2.1)	1.11	(0.05)		3.153	-	-
Cod juveniles	0		-	2.22	(1)	6.3	(4.73)	0.950	-
Whiting	0	0.791	(0.95)		0.840		3.558 (4)	-	-
Whiting juveniles	0		-		1.680	7.1	(5.382)	0.950	-
Saithe	0	0.064	(0.1)		0.580		3.286	-	-
Saithe juveniles	0		-	1.1	(1.5)	6.5	(4.93)	0.950	-
North Sea mackerel	0	0.043	(0.46)	0.29	(0.9)	5.79	(3.5)	-	-
Western mackerel	0	0.130	(1.312)	0.29	(0.9)	5.79	(3.5)	-	-
Haddock	0	0.906	(1.2)	1.37	(1)		3.786	-	-
Haddock juveniles	0		-	2.7	(1.75)	7.2	(5.679)	0.950	-
Herring	0	19.690	(9.8)	1.04	(1.2)		4.600	-	-
Sprat	0	0.086	(1.3)	1.21	(1.5)	8.6	(8.1)	-	-
Norway pout	0	1.941	(1.38)		2.480		9.610	-	-
Sandeel	0	2.577	(3.2)	2.02	(2.6)		10.250	-	-
Plaice	0	4.165	(2.35)		0.650		2.800	-	-
Sole	0	0.435	(0.75)		0.660		3.360	-	-
Brill	0	1.329	(1.15)		-		2.210	-	0.200
Halibut and turbot	0	2.272	(1.085)		0.270		2.780	-	-
Horse mackerel	0	1.396	(1.2)	0.29	(0.7)	5.79	(3)	-	-
Salmon and seatrout	0	0.009	(0.035)	0.4	(0.8)		7.140	-	-
Gurnards	0	0.237	(0.3)		1.400		5.200	-	-
Other predatory fish	0	0.223	(1.15)		-		5.790	-	0.200
Other prey fish	0	2.306	(6.8)		0.770		3.500	-	-
Cephalopods	0		-		3.000		15.000	0.950	-
Zooplankton	0	8.22	(12)	9.2	(19)	180	(70)	-	-
Euphausiids	0	1.8	(7)	2.43	(6)		-	-	0.15 (0.25)
Lobsters and edible crabs	0	0.074	(0.15)	2.5	(3)		-	-	0.150
Other crustaceans	0		-		3.000		-	0.950	0.15 (0.25)
Echinoderms	0	15.442	(50)	1.9	(2)		-	-	0.15 (0.25)
Polychaetes	0	38.05	(110)	1.9	(2)		-	-	0.15 (0.25)
Other macrobenthos	0	43.53	(150)	1.9	(2)		-	-	0.15 (0.25)
Meiofauna (other	0	34	(45)		19.000		-	-	0.15 (0.28)
Benthic microflora	0.5	0.048	(0.065)		15,625.000		-	-	0.3
Planktonic microflora	0.5		3.038		653.333		-	-	0.3
Phytoplankton	1		7.500		286.667		-	-	-
DOM	2		50.000		-		-	-	-
POM	2		50.000		-		-	-	-

<sup>a</sup> 0 = consumers; 0.5 = mix of consumers and primary producers; 1 = primary producers; 2 = detritus.

**Table 1.23.** Basic estimates of balanced Ecopath model of North Sea in the 1880s (values in brackets estimated in Ecopath). Production/Biomass (P/B); Consumption/Biomass (Q/B); Ecotrophic Efficiency (EE); Production/Consumption (GE).

Group name	Trophic Level	Biomass (t·km <sup>-2</sup> )	(P/B)·year <sup>-1</sup>	(Q/B)·year <sup>-1</sup>	GE	EE
Cetaceans	4.2	0.293	0.02	13.55	(0.001)	(0)
Seals	4.8	0.002	0.06	28.5	(0.002)	(0.952)
Seabirds	4.7	0.01	0.4	107	(0.004)	(0)
Sharks	4.3	1.246	0.15	6	(0.025)	(0.009)
Sharks juveniles	4.3	(1.653)	0.3	9	(0.033)	(0.950)
Rays and skates	4.0	0.906	0.32	2.9	(0.110)	(0.012)
Rays juveniles	4.0	(0.22)	0.64	4.35	(0.147)	0.950
Tuna	4.6	0.311	0.34	4	(0.085)	(0.006)
Sturgeon	4.0	0.003	0.11	1.61	(0.068)	(0.909)
Cod	4.3	2.1	0.5	3.153	(0.159)	(0.944)
Cod juveniles	3.9	(1.719)	1	4.729	(0.211)	0.950
Whiting	4.3	0.95	0.84	4	(0.210)	(0.986)
Whiting juveniles	4.0	(1.129)	1.68	5.382	(0.312)	0.950
Saithe	4.5	0.1	0.58	3.286	(0.177)	(0.949)
Saithe juveniles	4.2	(0.891)	1.5	4.929	(0.304)	0.950
North Sea mackerel	3.9	0.46	0.9	3.5	(0.257)	(0.976)
Western mackerel	3.9	1.312	0.9	3.5	(0.257)	(0.951)
Haddock	4.0	1.2	1	3.786	(0.264)	(0.992)
Haddock juveniles	3.8	(1.148)	1.75	5.679	(0.308)	0.950
Herring	3.4	9.8	1.2	4.6	(0.261)	(0.936)
Sprat	3.3	1.3	1.5	8.1	(0.185)	(0.936)
Norway pout	3.5	1.38	2.48	9.61	(0.258)	(0.996)
Sandeel	3.4	3.2	2.6	10.25	(0.254)	(0.994)
Plaice	3.7	2.35	0.65	2.8	(0.232)	(0.983)
Sole	3.6	0.75	0.66	3.36	(0.196)	(0.925)
Brill	3.7	1.15	(0.442)	2.21	(0.200)	(0.968)
Halibut and turbot	4.6	1.085	0.27	2.78	(0.097)	(0.745)
Horse mackerel	4.0	1.2	0.7	3	(0.233)	(0.910)
Salmon and seatrout	4.0	0.035	0.8	7.14	(0.112)	(0.959)
Gurnards	3.9	0.3	1.4	5.2	(0.269)	(0.916)
Other predatory fish	4.3	1.15	(1.158)	5.79	0.200	(0.954)
Other prey fish	3.8	6.8	0.77	3.5	(0.220)	(0.975)
Cephalopods	3.6	(1.429)	3	15	0.200	0.950
Zooplankton	2.1	12	19	70	(0.271)	(0.793)
Euphausiids	2.8	7	6	(24)	0.250	(0.968)
Lobsters and edible crabs	3.7	0.15	3	(20)	0.150	(0.980)
Other crustaceans	2.6	(41.406)	3	(12)	0.250	0.950
Echinoderms	3.4	50	2	(8)	0.250	(0.909)
Polychaetes	2.5	110	2	(8)	0.250	(0.936)
Other macrobenthos	2.9	150	2	(8)	0.250	(0.997)
Meiofauna (other	2.2	45	19	(67.86)	0.280	(0.982)
Benthic microflora	1.5	0.065	15625	(52,083.33)	0.300	(0.927)
Planktonic microflora	1.6	3.037	653.33	2177.77	0.300	(0.563)
Phytoplankton	1.0	7.5	286.67	-	-	(0.928)
DOM	1.0	50	-	-	-	-
POM	1.0	50	-	-	-	0.956

**PART 2: SPECIES ASSEMBLAGES DETAILS****Cetaceans**

*“There is a great deal of interest in whales. The seafarer rejoices to meet them in the monotony of his ocean voyage; the fisherman welcomes them in the narrow waters as harbingers of the herring-shoals; the merchant sees them as the object of a rich and still widening commerce; the naturalist considers their manifold variety in form and habitat, the marvellous adaptation of their bodies within and without to their strange existence, their orderly migrations, and the unsolved problems of their remote ancestral origin”...p. 392...“All the great whales that come ashore from time to time upon our coasts belong to the balaenopteridae (Rorquals or Finners, and Humpback whales). A curious study of their occurrences on the continental coasts of the North Sea might be made in the Seaport towns of Germany, Holland and Denmark, where it was for centuries the custom to record the stranding of a whales by a commemorative picture hung in the Rathhaus or Council Chamber. The porpoise is the commonest of all our native cetaceans and is frequently caught in fisherman’s nets. Although occasionally occurring in the North Sea, the common dolphin is particularly abundant in the Mediterranean. The White-beaked dolphins are also not very uncommon visitors to our coasts.”*

D’Arcy Thompson (1912, p. 383).

There is very little recent quantitative evidence of the numbers of cetaceans present in North Sea, although a recent ICES study group has started working on stock assessment. Whilst porpoises and dolphins are likely common in most areas of the North Sea, it appears from whaling statistics and recent ICES reports that the larger whales are more commonly restricted to the northern North Sea and further north (Anon., 1999c). Since we have very little evidence on recent population size, and the amount of time that the larger whales spend in the North Sea, the minimum abundance of whales assumed to be present in the North Sea (for an undetermined proportion of the year) in the 1880s was based on the reported killings at Shetland whaling station 1904-1911 (Thompson, 1912; Table 2.1)

**Table 2.1.** Return of the number of whales of different species landed at Scottish whaling stations 1904-1911 (Thompson, 1912). Summary table only includes those landed at Shetland, those at Hebrides not being considered to occupy the North Sea.

Species	Number killed	Average weight per animal (t) <sup>a</sup>	Biomass (t)
Fin whale	2,364	55.59	131,415
Sei (Rudolphi’s whales)	1,060	16.81	17,819
Blue whale	17	102.74	1,747
Humpback whale	39	30.40	1,186
Bottlenose whale	7	1 <sup>b</sup>	7
Sperm whale	7	21.60	151
Right whale	4	23.38	94

<sup>a</sup>Trites and Pauly, 1998; <sup>b</sup> based on pilot whale.

Dolphins and porpoises are likely to have been relatively abundant. Numbers are guessed (I believe conservatively) at being 3000. Killer whales also occur, albeit infrequently in the North Sea. Their abundance is guessed as being 50 individuals. Biomass determined based on average weights of individuals from Trites and Pauly (1998).

It is known from various reports that fishers looked favourably on the whales as the harbingers of good fishing and thus they were unlikely to have been hunted much in the 1880s. On this basis, kills were assumed to be zero.

*“Till recent years, the whales of this family were immune from prosecution, but it is very different nowadays. About 40 years ago a Norwegian sea captain, Svend Foyn began a fishery for these whales off the North Coast of Finmark. The short baleen is of little value but the whales yield an abundance of oil, their bones make excellent manure, and even the flesh is utilised, being dried, ground to powder, and used in part for manure and in part for mixing with cattle foods. Svend Foyn made a fortune, and laid the foundations of a great industry. Political reasons led towards the end of the nineteenth century to the closure of the Norwegian fishery, the local fishermen asserting that the slaughter of the whales diminished their catch of fish, but the Norwegian whalers carried their trade elsewhere to Faeroe, Iceland, Scotland, Newfoundland and to stations in the Southern Ocean. In Shetland, there are*

now 4 stations, another in Hebrides and 1-2 in Ireland. The method of fishing is with small steamers and powerful harpoons".  
D'Arcy Thompson (1912).

Maximum rate of population increase for whales is 4% (Reilly and Barlow, 1986) and the P/B ratio was estimated to be 2% (half of  $r_{max}$ ), based on Trites *et al.* (1999), who calculated consumption for a variety of species based on average body weight and daily ration. Weighting the Q/B of each species by its biomass derived an average Q/B of 13.55 year<sup>-1</sup> for cetaceans.

Diet information is derived from the ICES working group on marine mammal population dynamics and trophic interactions (Anon., 1999c). Diet information pertaining to the North Sea is primarily for dolphins and porpoises. Noted prey species include cephalopods, gadoids, sole, dab, salmon, sandeels, hake, mackerel, cod, haddock, pollock and sprat. Principle prey species of large baleen whales include euphausiids, copepods, herring, sandeels, haddock, hake, mackerel, and capelin. Thompson (1912) provides some qualitative evidence for diets of fin and sperm whales. Predominant food of fin whales is said to be *Calanus finmarchicus*, whilst sperm whale were known to prey on cuttlefish. Given the higher biomass of large baleen whales within the cetacean group, the constructed diet matrix was more heavily biased to representing the prey species of the larger whales.

"Whales, porpoises, seals, coalfish, dogfish and other predaceous fishes are constantly feeding on [herring]".  
Buckland *et al.* (1878).

"The 'appearance of fish' [herring] is given away by large collections of seabirds and the presence of whales and smaller cetaceans [porpoises]".  
Holdsworth (1874, p. 112).

"Although it has often been stated that the whale is extremely destructive of the herring, it is now known that the common whale or Greenland whale (*Balaena mysticetus*) has been found not to prey on the herring and that those varieties of the whale tribe which are known to feed on it frequent the Norwegian, Scottish and Irish coasts. As to the *Balaena mysticetus*, or common whale, we are informed by the talented Scoresby, in his valuable book 'On the Arctic regions' that "its food consists of various species of Actinice, Sepice, Medusae, Cancrini and Helices. And

this whale is rarely met within 200 leagues of the British coasts. But in contradistinction to the common whale is the *Balaena musculus* or *Balaenoptera rostralis* (Fin whale) which frequent the coasts of Scotland, Iceland, Norway, etc., and is known to feed principally on herrings, thus proving that one of the most destructive enemies of the herring is an inhabitant of those coasts where the latter most commonly resorts. The Norwegians say that is commonly seen where the herrings are generally fished and is a good indicator of the best locality. The *Balaena rostralis* or beaked whale, also frequents the Norwegian and adjacent seas, and is said to feed on herrings and other fish. We are told by a Dutch author, that out of the stomach of a whole whale styled by him "Noortkaper," or North Caper, more than a barrel of herrings was taken; this whale had been stranded or captured at Shetland".

Mitchell (1864, p. 34).

### Seals

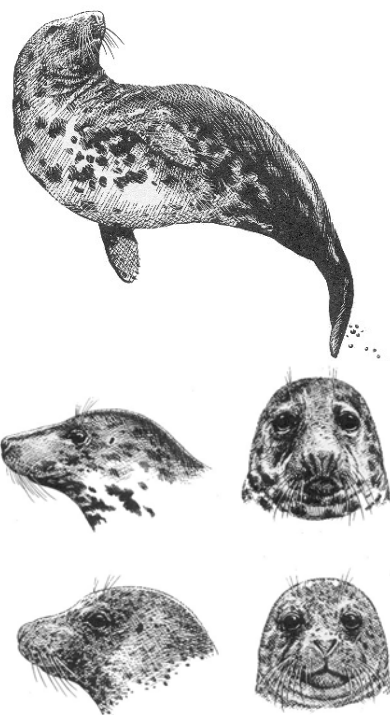

Grey (top) and common seals from Anderson (1990).

Six pinniped species have been recorded from the coastal waters of the North Sea; the grey seal (*Halichoerus grypus*); the common sea (*Phoca vitulina*); the ringed seal (*Phoca hispida*); the harp seal (*Pagophilus groenlandicus*); the hooded seal (*Cystophora cristata*) and the walrus (*Odobenus rosmarus*). Except in the north of

Norway, the ringed, hooded, harp seals and walrus occur only as rare visitors and their breeding range is confined almost entirely to the Arctic (Summers, 1978).

In an early account of seals in British waters Southwell (1881) claimed that common seals occurred in “greatly reduced numbers” as a result of hunting but were nevertheless “still abundant” in Orkney, Shetland and the Hebrides and that many young ones were born in the Wash. He reported that the “chief places of resort” of grey seals were Orkney, Shetland, the Hebrides, and the west coast of Ireland, although they were known to breed at the Farne Islands also. He gave little indication of the size of the population. Only Evans and Buckley (1899) when reported that the common seal was much more numerous than the grey seal in Shetland, conceded that this may have been an erroneous impression resulting from the more inaccessible haunts of the grey seal.

In 1927, Prof James Ritchie and Mr W.L. Calderwood as 4,000-5,000 estimated the grey seal population with 1000 pups born annually (Rae, 1960). After protection populations increased rapidly. In the Farne Island, grey seals quadrupled between 1928-1957.

In more recent times (1970s), principal concentrations of grey seals (that may influence the North Sea) occur at North Rona, Orkney, and the Farne Islands (Figure 1.4b), with the total North Sea population estimated at 29,000-32,000. Principal concentrations of common seals in the North Sea are at Orkney, Shetland,

the east coast of Scotland, the Wash and the German Bight; the population is estimated at 15,000-18,350. In the absence of other significant predators in recent times, seal numbers have been controlled mainly by human hunters (Summers, 1978). During the 1980s, populations were increasing at a rate of about 7% annually. By 1988, estimated numbers in the UK alone were around 100,000 (Anderson, 1990).

Best estimates of the historical numbers of seals come from Rae (1960). Based on his accounts, the total population of seals was estimated as being 7,340 individuals, by inferring from Evans and Buckley (1899), common seals were two times more abundant than grey seals. Although the population of seals was likely lower than in more recent times, the estimated population size is likely to be a considerable underestimate. Using an average weight of an individual harbour seal 63 kg (Trites *et al.*, 1999), biomass per area was determined as being 0.001 t·km<sup>-2</sup> (Table 2.2).

Whilst no quantitative evidence on the hunting of seal's prior the 1900s was discovered, it is apparent from several accounts that seals were heavily hunted. Southwell (1881) quoted a suggestion that the seals of Haskier in the out Hebrides were in danger of being hunted to extinction. Catch of seals in the model was guessed as being 1000 individuals per year.

The maximum rate of population growth rate for pinnipeds is believed to be about 12% year<sup>-1</sup> (Small and DeMaster, 1995). The P/B ratio was therefore set at 6%, half of the maximum.

**Table 2.2.** Abundance of seals on UK coasts adjacent to the North Sea (Rae, 1960).

Species	Location	Number	Source
Common	Wash and Norfolk	1000-1500 maintained over previous years in spite of persecution	Sergeant (1951)
Common and Grey	Firth of Tay	Est. 2000 in 1959	Mr. J. H. Maxwell, Tayport, pers. comm
Common	Moray firth	Est. 2000 1958. Killed 1100 from 1955-1959	Moray Firth Salmon Fisheries Co.
Common	-	abundant	Sergeant (1951)
Grey	Firth of forth	30-40 in 1958	Eggeling (1957)
Grey	Rusk Holm, Orkney and Shetland	Not uncommon to see 500-600 but much scarcer than common	Evans and Buckley (1899)

The amount of food eaten by seals in the wild is not precisely known. Keyes (1968) found that for a variety of species in captivity, the amount of food given per day was between 6-10% of the seal body weight. This would correspond to about 5-8.5 kg·day<sup>-1</sup> from common seals and 7.5-12.5 kg·day<sup>-1</sup> for grey seals. Havinga (1933) calculated that common seals required 5 kg of food per day and Stevens (1934) estimated that grey seals in Cornwall ate at least 6.8 kg of fish per day. Grey seals at least do not feed during the breeding season so 300 days of feeding per year was used. Using the above values, Q/B for seals was determined based on an assumed daily ration of 6 kg·d<sup>-1</sup> for a common seal weighing 63 kg (Trites *et al.*, 1999), giving a Q/B of 28.5 year<sup>-1</sup> (based on 300 feeding days).

Rae (1968) reported detailed quantitative diet for both grey seal and common seal based on the number of stomachs containing each prey item. These were used to represent the proportion of each item in the stomach of seals by constructing a composite 'seal' diet from an average of both species. Millais (1906) also includes halibut in the diet of grey seal and pollock in the diet of common seal, so these were included in the diet also.

*“Of the seal tribes there are various kinds which unquestionably prey upon herring”.*  
Mitchell (1864).

*“It would appear that the common seal preys less frequently on salmon and cod but more frequently on whiting, saithe, herring and flatfishes (mainly plaice) than the grey seal. The diet of the common seal would also seem to include more estuarine species such as the blenny. In general too, the fish eaten by the common seal are smaller than those eaten by the grey, which is the larger of the 2 species. The differences in diet seem to be related to their differences in size and habitat (estuarine habit of common seal) and to the difference in the distribution of the two*

*species in relation to the distribution of their prey. There is evidence that grey or common seals lead a prolonged pelagic existence outside coastal water, which for the present time may be regarded as extending 10-12 miles offshore”.*  
Rae (1968).

**Seabirds**

The main species of piscivorous birds in the North Sea are shags (*Phalacrocorax aristotelis*), cormorants (*Phalacrocorax carbo*), fulmars (*Fulmarus glacialis*), gulls (*Larus spp.*) and terns (*Sterna spp.*). No information was found on the population estimates in 1880s or more recent times, thus their biomass was left to be estimated by Ecopath. An EE of 0.05 was assumed, since nothing was considered to eat birds.

The P/B ratio was taken from Trites *et al.* (1999) and assumed to be equal to total mortality (Z) which was based on survival estimates of adult black-legged kittiwakes reported by Hatch *et al.* (1993). Adult mortality rates are approximately 0.4 year<sup>-1</sup> and total population mortality rates are most likely higher. P/B was set at 0.4 year<sup>-1</sup>. Estimates for annual consumption for northern fulmars and cormorants are provided in Kelson *et al.* (1996) and Wada (1996), based on estimates of daily ration as a percentage of body weight. Average Q/B (assuming 300 feeding days per year) works out as 107 year<sup>-1</sup> (Table 2.3).

Rae (1969) reported detailed quantitative diet for both shags and cormorants based on the number of stomachs containing each prey item. These were used to represent the proportion of each item in the stomach of birds by constructing a composite 'bird' diet from an average of both species.

*“The shoals of herring are always accompanied by flocks of gulls and other sea-birds which are continuously preying on them”.*  
Buckland *et al.* (1878).

**Table 2.3.** Estimation of Consumption/Biomass (Q/B) for birds

Species		Body weight (kg)	Consumption per day as proportion of body weight	Q/B·(year <sup>-1</sup> ) (300 days)	Reference
Northern fulmar	<i>Fulmarus glacialis</i>	0.78	0.275	82.5	Kelson <i>et al.</i> , 1996
Cormorant	<i>Phalacrocorax carbo</i>	1.8	0.44	132	Wada, 1996
Average		-	-	107	-



### Sharks and dogfish (adult and juvenile)



Spur-dog (*Squalus acanthias*, Yarrell, 1836)

Several shark and dogfish species are known to occur in the North Sea, though not all are resident all year round. Probably by far the most abundant elasmobranch in the North Sea is the spur-dog (*Squalus acanthias*). Other important small sharks include lesser spotted dogfish (*Scyliorhinus canicula*), greater spotted dogfish (*Scyliorhinus stellaris*), angel shark (*Squatina squatina*), smooth hound (*Mustelus mustelus*) and tope (*Galeorhinus galeus*). Of the large sharks, the porbeagle (*Lamna nasus*) is the most common, but generally restricted in its distribution to the northern North Sea. Other large sharks that inhabit the North Sea occasionally include blue shark (*Prionace glauca*), thresher (*Alopias vulpinus*), mako shark (*Isurus oxyrinchus*) and the planktivorous basking shark (*Cetorhinus maximus*).

Information on sharks in the North Sea is sparse. A recent ICES study group on elasmobranchs (Anon., 1999b) reviews information on the spur-dog and proposes recommendations for future work. No assessment of elasmobranch stock is provided. A minimum estimate of the abundance of sharks is derived from beam trawl surveys made throughout the North Sea in 1902-03 (Garstang, 1905). It is assumed that the beam trawl was only 10% efficient and the catch per unit area is increased 10 fold accordingly; giving a total biomass of 710,163 t (Table 1.14). The combined abundance of spur-dog, angel shark, tope, lesser spotted dogfish and smooth hound are taken to represent 'sharks'. Abundance of juvenile sharks is estimated by Ecopath, assuming an EE of 0.95

Hoek and Kyle (1905) provide estimates of the landing of dogfish and 'cat fish'(wolf-fish) by Germany from 1892-1903. The average estimate given for the three years 1892-1895 is 80 t·year<sup>-1</sup>, and is used in the model as the catch of 'sharks'. From 1896 to 1903, reported annual catch is over 200 t. As no other countries reported catches of 'sharks', it is assumed that this was taken by longline fishers. Dogfish were also caught in herring drift nets during the night, the time at which they are known to feed. Holdsworth (1874, p. 80) recounts,

"The first to separate themselves from the quivering mass on deck are the fishermen's' great and ever present enemies, the dog fish – "dogs"... They wriggle about on the deck until sooner or later they are quieted with a blow on the head and once more consigned to the deep".

The account is also indicative that the dogfish were discarded. However, given that dogfish are exceptionally hardy animals, this observation is not taken as grounds for considering there to be dead discards of dogfish.

An estimate of natural mortality for the porbeagle is 0.18 year<sup>-1</sup> (Aasen, 1963), and for blue sharks 0.18-0.24 year<sup>-1</sup> (Nakano and Watanabe, 1992), which suggests an estimate of P/B ratio of about 0.2 year<sup>-1</sup> for both species. Wood *et al.* (1979) estimated the natural mortality of spur-dog as 0.1 year<sup>-1</sup>. Assuming that total mortality (Z) of spur-dog consists mainly of natural mortality, the P/B (=Z under steady state assumption) is taken as being 0.1 year<sup>-1</sup>. The average of the estimates (0.15) is applied in the model as the P/B ratio for the shark group. Juvenile sharks are assumed to have a production rate twice that of the adults (0.3·year<sup>-1</sup>).

Stillwell and Kohler (1982) provide an estimate of food consumption for shortfin mako shark (*Isurus oxyrinchus*) in the northwest Atlantic of 3% body weight per day or about 10 times the body weight per year. Spur-dog appear to eat twice as much food in summer as in winter, with annual average consumption of 5 times body weight for small animals and 2.5 for large animals (Jones and Green, 1977). Assuming that, like the spur-dog, small 'large' sharks eat twice as much relative to body weight as do adult large sharks, and taking a middle value for between large and small sharks, the annual Q/B values used in the model are 12 for juveniles and 6 for adults, which agrees with Pauly's (1989) estimate of Q/B for spur-dog of 4.77 year<sup>-1</sup>.

Rae (1967b) reported that the appearance of dogfish on fishing grounds frequently resulted in fishers changing grounds to avoid these nuisance fish because of the disruption they were believed to cause to shoals of more desirable fish and because of the harmful effect they produced, while in the cod-end on the appearance of good quality fish. From 1921-1939, several thousand were examined for diet information. Recognisable food was recorded in 943 stomachs. The food was found to be predominantly pelagic in character and there was little evidence from the Scottish

data of any significant seasonal variations in feeding. The herring was the outstanding single species and, along with sand eels and mackerel, and semi-pelagic types such as whiting and Norway pout, formed the bulk of the food. Crustaceans and molluscs were eaten fairly commonly, while tunicates, annelids, coelenterates and ctenophores were taken less frequently and somewhat sporadically. Quantities of unrecognisable material were also found in stomachs, possibly indicating a somewhat greater predation on planktonic types than the identifiable material would suggest (Rae, 1967b). This group's diet was based solely on dogfish which was assumed to eat equal proportions of adults and juveniles of other species. The diet of juveniles was assumed to be of similar composition with the exception that adults of some species were missing.

### **Rays and skates (adult and juvenile)**

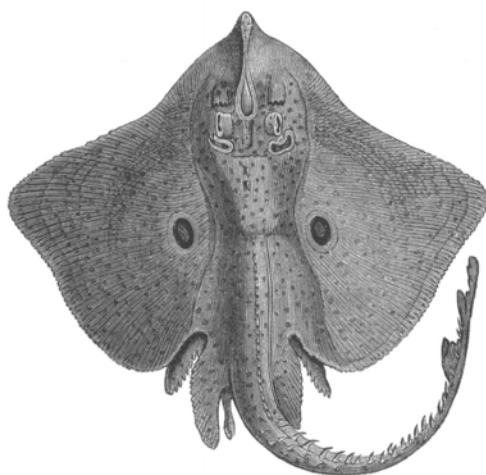

Homelyn (spotted) ray (*Raja montagui*, from Yarrell, 1836)

As for sharks, there is little information on the abundance of rays and skates. A minimum biomass estimate is derived from beam trawl surveys made throughout the North Sea in 1902-03 (Garstang, 1905). It is assumed that the beam trawl was only 10% efficient and the catch per unit area is increased 10 fold accordingly. The combined abundance of thornback ray (*Raja clavata*), spotted (Homelyn) ray (*Raja montagui*), starry ray (*Raja radiata*), blonde ray (*Raja brachyura*), shagreen ray (*Raja fullonica*), white skate (*Raja alba*), blue skate (*Raja batis*) and stingray (*Dasyatis pastinacea*) are taken to represent the 'Rays and skates'. Total biomass for the North Sea was 516,648 t. Abundance of juveniles is estimated by Ecopath, assuming and EE of 0.95

Rays and skates occurred in the catch of longline fisheries. An estimate of an annual landing of 1964 t is taken from the average Scottish catch reported from 1886 to 1890 (Hoek and Kyle, 1905). No other countries reported catches in this period. In 1892-1895, Germany and Holland reported a combined annual average catch of approx. 660 t, whilst Scotland still retained the largest catch of 1,947 t. It is likely that this is an underestimate of the catch since, perhaps even more so than sharks, rays and skates were probably frequently taken as bycatch in trawl fisheries. Being classified as offal, rays constituted up to 6% of the trawl catch for sailing trawlers (Sahrhage and Lundbeck, 1992). Whether or not they were discarded is not known. If so, it is presumed from their hardy nature that they survived. Rays (or 'rokers') weighed on average 2 kg and were sold in baskets of 25 kg or boxes of 30 kg. Typical average weight for skates was 13.6 kg (Hoek and Kyle, 1905).

An approximation for the production to biomass ratio of rays and skates is based on half the maximum of intrinsic rate of increase ( $r$ ). Using the average  $r$  for three species, provides an estimate of P/B of 0.32. Juveniles are assumed to have P/B ratio 2 times that of adults (Table 2.4). The consumption to biomass ratio of 2.9 year<sup>-1</sup> used for rays in the 1980s model (Christensen, 1995; based on studies by M. Vinter, reported in Anon., 1989) is applied to the rays and skates group. Juveniles are assumed to have Q/B ratio 2 times that of adults.

**Table 2.4.** Estimation of intrinsic rate of increase for rays and skates.

Species	$r_{max}^a$
Blonde ray <i>Raja brachyura</i>	0.7
Skate <i>Raja batis</i>	0.32
Thornback ray <i>Raja clavata</i>	0.88

<sup>a</sup> based on 'Keyfacts' Table in FishBase ([www.fishbase.org](http://www.fishbase.org)).

Typically diets of rays and skates include crustaceans and a variety of benthic macrofauna. A composite group diet was constructed based on diets given for skate (Smith, 1890) and rays MSVPA data (V. Christensen, pers. comm.). The diet of juveniles was assumed to be of similar composition with the exception of eating adults of some species that adult rays and skates eat.

## **Bluefin tuna (*Thunnus thynnus*)**

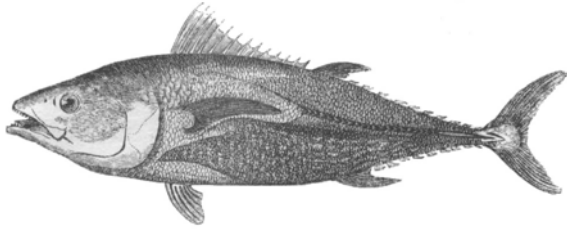

(from Yarrell, 1836).

*“The Tunny (*Orcynnus thynnus*) is indeed the most famous example of a migratory fish; from Aristotle onwards classical literature makes frequent mention of the ways and character of this magnificent fish. The watchman on the hill overlooking the sea, mentioned in the Bible, is possibly another reference to it, and the methods adopted at the present day, the outlook (Figure 2.1) and even the fishing nets, are the same as those used at least 2000 years ago”.*

Kyle (1926, p. 47).

*“It is not only found in the Mediterranean. It is also taken on the Western side of the*

*Atlantic. On the other hand it has been found much further north, in British water, North Sea, Scandinavia coasts, and the skulls have even been taken in Icelandic waters; within recent years, quite a number have been captured in the North Sea....These are not spawners; they are the larger fish which, after spawning in the summer on the Spanish or Portuguese coasts, follow the sardine and mackerel shoals northwards, and later feed on the Autumn herring of the North Sea. When the trawl with its load of herring is hauled up, the tunny follows and snaps at the protruding heads and tails. Possibly it was just as common in earlier years; there is a record by Schönevelde that it was fairly common near Eckernförde in the Western Baltic as far back as the beginning of the seventeenth century, also in connection with the presence of mackerel. The porpoise may often have been blamed for its depredations, but until the trawl was used for the capture of herrings in large quantities, its occurrence was regarded as a rarity.”*

Kyle (1926, p. 48).

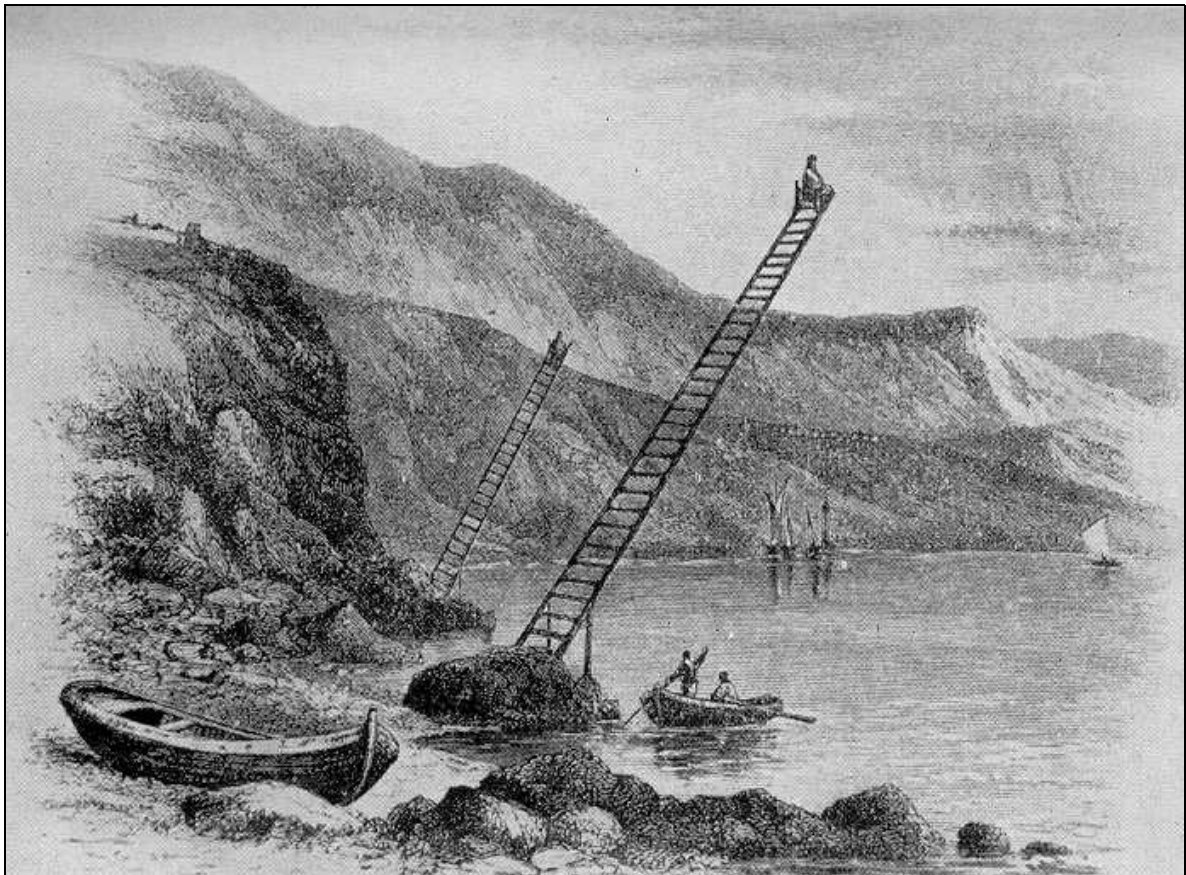

**Figure 2.1.** Lookouts for bluefin tuna, presumably on the Mediterranean coast (Kyle, 1926).

In the absence of any more suitable parameter to estimate the population of bluefin tuna in the northeast Atlantic waters, Tiews (1978, p. 304) used catch as an abundance index. Total population was estimated under the assumption of a fishing mortality of 10%, a certain justification which can be made on the basis of tagging data and returns by year and area. The total population size is expressed in the number of fish weighing on average, 200 kg each for the period 1951-1962, and 300 kg each for the period 1963-1972. It is estimated that only 40-50% of the tuna population migrated to the Central North Sea and fed there for about half the season only. Assuming a fishing mortality of 10%, the maximum population estimate for Central North Sea is 710,000 in 1952 based on landings of 71,000 fish (average 250 kg, Tiews, 1978). Assuming same population size in 1880, with average size 250 kg per fish gives a biomass of 177,500 t.

The maximum population biomass in the 1880s is assumed to be equal to that in 1952. However, since there was no recorded, directed fishery for tuna (which were caught incidentally in other fisheries), the fisheries catch is conservatively estimated as 1/50<sup>th</sup> of the catch in 1952 (71,000) fish. Total catch being 1420 fish. Using an average body weight of 250 kg, catch in tonnes = 355 t.

In the Central North Sea, the German hook and line fishers found that mackerel was the favourite bait, followed by herring, but other fishes such as whiting and haddock were also used for chumming. Harmer (1927) reported that, in his opinion, tuna seemed to feed on the available food species in the area concerned. In area IIa he

found that 90% of food consisted of Atlanto-scandian herring. Occasionally squid and gadoids were found in the stomachs, but no mackerel, while in areas south of Bergen, mackerel formed an important part of the diet. The share of mackerel in the prey-fish consumption may have been largest in the Central North Sea. Most of the food taken during their stay in the northeast Atlantic during their time of great abundance up to 1962 probably consisted of herring, perhaps exceeding 75%. It is also likely that about 25% or less of their food consumption consisted of mackerel, since only some part (40-50%) of the tuna population migrated in to the Central North Sea and fed their for about half the season only (Tiews, 1978). Diet was constructed based on the above account.

Tiews (1978) found only one example of quantitative information on the feeding volume of skipjacks by Waldron (1963) who cites Hotta and Ogawa (1955) – the highest value was 81.5 g per kg body weight (approx 8% of body weight). Stomach contents examined by fishers suggest a maximum food intake of about 4% per day of body weight. Other similar estimates of Q/B for tuna are detailed in Table 2.5. Although bluefin tuna only occur for part of the season in the North Sea, it is this the time when consumption is likely to be highest. A Q/B of 4 year<sup>-1</sup> was applied in the model.

An approximation for the production to biomass ratio of tuna is based on half the maximum intrinsic rate of increase (r). Using the average r for two species (Table 2.5), provides an estimate of P/B of 0.34 year<sup>-1</sup>.

**Table 2.5.** Estimates of intrinsic rate of increase and food consumption for tuna.

Species		$r_{max}^a$	Q/B·(year <sup>-1</sup> )	Reference for Q/B
Blufin tuna	<i>Thunnus Thynnus</i>	0.3	3.93	Palomares (1991)
Little tunny	<i>Euthynnus alletteratus</i>	1.04	7.52	Predicted using equation from Palomares and Pauly (1998)

<sup>a</sup> from 'Keyfacts' Table in FishBase ([www.fishbase.org](http://www.fishbase.org)).

**Sturgeon (Acipenser sturio)**

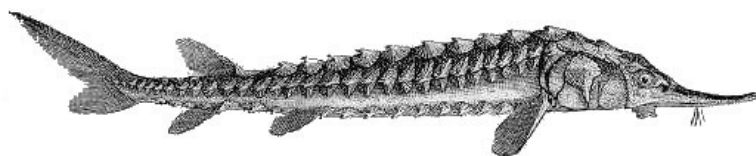

(from Yarrell, 1836).

Sturgeon were previously distributed widely along all European coasts and throughout the eastern Atlantic. The biomass of sturgeon is estimated under the assumption that annual catch was 10% of population, giving a value of 1,710 t. This is likely to be an overestimate of the catch and thus underestimate the likely abundance.

Hoek and Kyle (1905) report catches of sturgeon in a German coastal fishery mostly taken on the lower Elbe for several years between 1885 and 1902. They note that 400-1000 each year (mean 700) was taken by steamers in the North Sea from between 1890-1896 (Figure 2.3). Only the catches for 1885 and 1887 are used here to infer possible catches in the 1880s. Combined catch for these years was 17,100 individuals. With an average weight of 20 kg, this gives an average catch of 171 t-year<sup>-1</sup>. Sturgeon were caught mainly in trawls and likely perhaps also as bycatch in line fisheries although no reference to this was found. Smidth (1876) makes further reference to the German fishery commenting that fishers operating from the mouth of the Elbe up to the boundary of Jutland, catch for the most part, bream, herring, and sturgeon:

*“The sturgeon fishing has been particularly good for the last few years. In 1871, however, it was not so good for the river Eider”.*

In Hoek and Kyle (1905), sturgeons also appear in the reported catches of Holland and Scotland under the heading of ‘various others’ which included sturgeon, salmon, smelt and shad. No information is given on the proportions of each in the catch and hence this information is not used here.

Sturgeon are long lived and slow growing. P/B was set to half of its value of  $r_{\max}$  in FishBase, giving a value of 0.11 year<sup>-1</sup>. Applying an average water temperature of 10°C, Q/B was calculated using the empirical equation of Palomares and Pauly (1998), giving a value, 1.61 year<sup>-1</sup>.

Sturgeon feed on crustaceans, molluscs, polychate worms and small fishes. Diet was constructed based on this information.

### **Cod (*Gadus morhua*) - adults and juveniles**

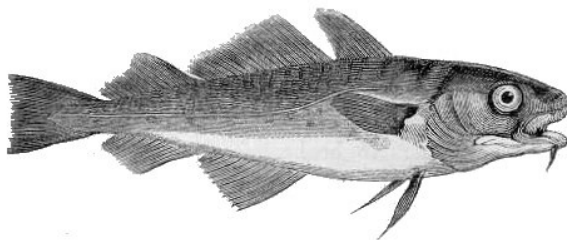

(from Yarrell, 1836).

A middle biomass estimate of 1,618,220 t was applied in the model (Table 1.16) based on possible minimum and maximum estimates

determined from research trawls conducted in 1902-1903 (Garstang, 1905; Table 1.14). The estimate is 5 times greater than that used in the 1980s model. Whilst there is considerable uncertainty surrounding the estimates, there is substantial evidence to support that the biomass of cod was considerably higher in the 1880s. Juvenile abundance is estimated in Ecopath, based on the assumption of EE equal to 0.95.

The only cod catch data in 1880 come from Belgium and Norway, who jointly took over 21,000 t of North Sea cod. More complete statistics are available from 1892 to 1903, where annually an average of approximately 60,000 t were taken by trawlers and liners from Germany, Holland, Belgium, France, England, Scotland and Norway (Kyle, 1905; Hoek and Kyle, 1905; Thompson, 1909; Figure 2.2). Assuming that other countries were also catching cod in 1880s, an annual catch of 30,000 t is used in the model. This figure perhaps also better represents the catch of true North Sea cod, since it is known that many of the catches of cod and haddock reported for the North Sea may have come from other areas such as Iceland, Faroes and Norway. Kyle (1905) suggests the quantity may be as much as half the total catch.

*“The cod landed by Dutch liners is in the salted condition in barrels. The total weight of the barrel is about 190 kg and deducting the weight of the salt etc. it is estimated that a barrel is equivalent to about 150 kg fresh cod. The cod is also landed in the living and iced condition. For the largest of these, the average weight is taken to be about 5.5 kg”.*

Kyle (1905, Part I, p. 73).

The same values of P/B and Q/B used in the 1980s model were applied in the 1880s model. Juveniles P/B and Q/B ratio were assumed to double that of the adults.

Rae (1967a) details the diet of cod for two size classes 21-50 cm and 51-116 cm, expressed in terms of the percentage of stomachs containing particular food items. Data were taken for cod in the Central North Sea. Most of the trawling was carried out at 6-120 fathoms. The stock included a much higher proportion of large cod than anywhere else in the North Sea. The food of the smallest codling, <21 cm, consists mainly of small crustaceans. Fish of 21-50 cm continue to feed predominantly on crustaceans (mainly decapods) although with growth they increasingly eat more fish. Cod over 51 cm are in general mainly fish

eaters, although in certain regions they may continue to prey heavily on decapod crustaceans such as *Nephrops*. The food of cod also includes various types of molluscs, polychaetes, ophiuroids and on rare occasions other types such as gephyreans, nemerteans, anthozoans and ctenophores. The diets given by Rae (1967a) were

used in together with information on the diet of adult and juvenile cod from MSVPA (V. Christensen, Fisheries Centre, UBC, pers. comm.) and 1980s model to complete the diet of prey items which comprise the 'other food' component specified in the MSVPA.

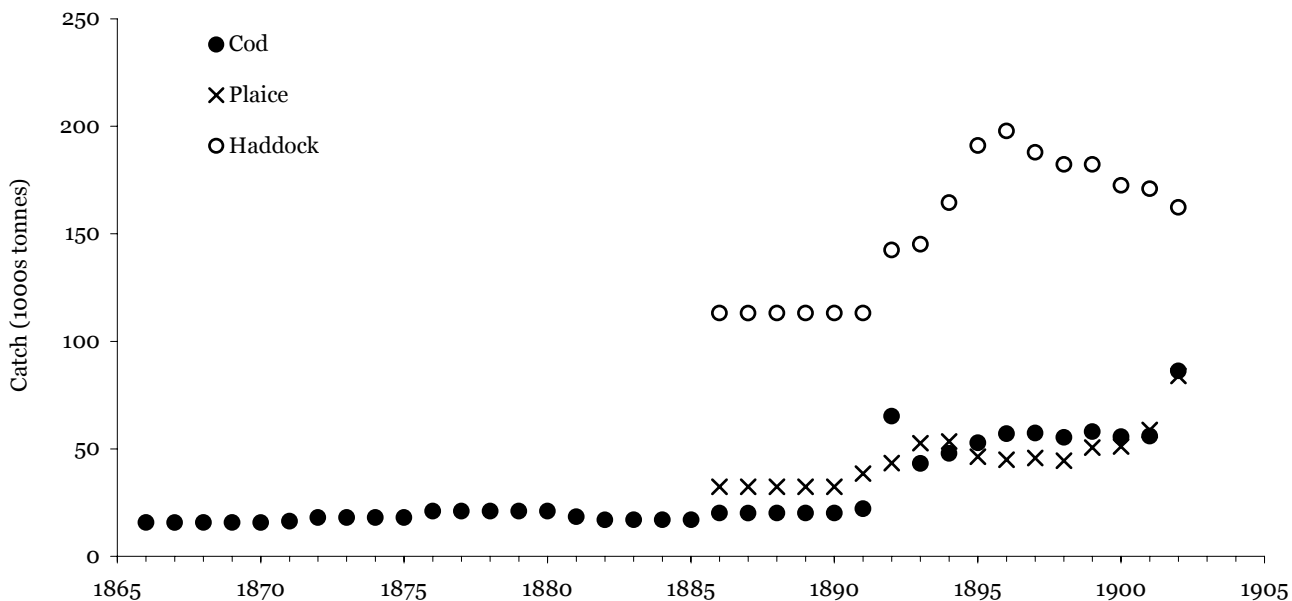
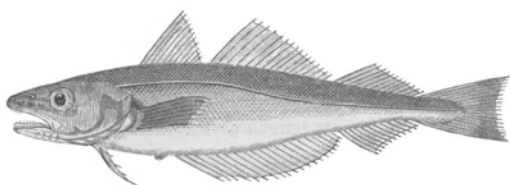

Figure 2.2. North Sea catches of cod, haddock and plaice from 1865 to 1902.

**Whiting (*Gadus merlangus*) – adults and juveniles**



(from Yarrell, 1836).

The biomass of whiting used in the model was 302,662 t (Table 1.16), the middle value from minimum and maximum estimates derived from catch per boat method. Juvenile abundance is estimated in Ecopath, based on the assumption of EE=0.95.

Average annual reported catch of whiting in 1880s is given only for Scotland 1886-1890; 3,395 t (Hoek and Kyle, 1905). This value is used in the model, but is likely to be a considerable underestimate since other countries were probably catching whiting. In 1892-1895, Germany reported annual catches of around 91 t and Holland 132 t in 1902. Whiting were also

likely to have comprised a notable proportion of the English trawlers catch in the category 'Fish not separately distinguished' (Garstang, 1903a), whose catches averaged 53,661 t in the period 1886-1890 (Hoek and Kyle, 1905). Holdsworth (1874, p. 81) provides comments in support of this:

*“Whiting form a considerable item at certain seasons in the catch of the Devonshire trawlers, as haddock do in the trawls made in the North Sea”...p. 90: “On the south and west coasts, haddocks are met with in such small numbers, that the Brixham and Plymouth trawlers do not especially look for them. Whiting take their place”.*

The same values of P/B and Q/B used in the 1980s model were applied in the 1880s model. Juveniles P/B and Q/B ratios were assumed to be double that of the adults.

Raitt and Adams (1965) comment that Norway pout is the most important food species of the whiting over 21 cm (Jones, 1954). Jones (1954) gives diets of whiting from the Central North Sea

and Moray Firth (Scotland) in % weight. The information is not particularly detailed, noting mostly the predominance of crustaceans and fish. This information was combined with whiting diets taken from MSVPA (V. Christensen, Fisheries Centre, UBC, pers. comm) and 1980s model to complete the diet of prey items which comprise the 'other food' component specified in the MSVPA.

**Saithe (coalfish - *Pollachius virens*) adults and juveniles**

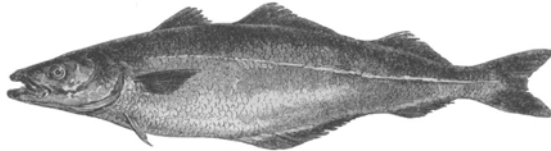

(from Yarrell, 1836).

The only information on reported catches of saithe in the 1880s comes from Scottish fisheries, that totalled an average of 3,621 t·year<sup>-1</sup> between 1886-1890. From 1892, statistics are available for other countries including Germany (saithe catches include pollock) and Holland, which together only totalled just over 200 t·year<sup>-1</sup> in comparison to the Scots' 3,327 t in the same period. Assuming a 10% fishing mortality, the abundance of saithe in the 1880s was inferred from reported catches as being 36,210 t (Table 1.15). This value is 10 times less than that used in the 1980s model. No information is available for juveniles, so these are left to be estimated in Ecopath, based on an assumed EE of 0.95.

Based on Scottish catches reported for 1886-1890; 3,621 t (Hoek and Kyle, 1905). According to Kyle (1905), average size of saithe was 4 kg. The same values of P/B and Q/B used in the 1980s model were applied in the 1880s model. Juveniles P/B and Q/B ratios were assumed to double that of the adults.

Adult diet is based on MSVPA diet data (V. Christensen, Fisheries Centre, UBC, pers. comm.) and 1980s model to complete the diet of prey items which comprise the 'other food' component specified in the MSVPA. Juvenile diet was constructed using the adult diet as a guide, but with juveniles preying more heavily on other juvenile fish, euphausiids and zooplankton. Holdsworth (1874) and Buckland *et al.* (1878) both make reference to the predation of saithe (coalfish) on herring:

*"When the herrings are on the coast and are accompanied by a host of cod, coalfish, etc., then in many places the fishermen are careful to open these predacious fishes for the sake of the herrings they may have swallowed, and which afterwards may be usefully employed as bait."*

Holdsworth (1874, p. 4).

*"Whales, porpoises, seals, coalfish, dogfish and other predaceous fishes are constantly feeding on them [herring] also"*.

Buckland *et al.* (1878).

**Mackerel (*Scomber scomber*)**

According to the 1999 ICES ACFM report (Anon., 1999d), for the years (1972-1998) where SSB assessment is available for both the western stock and North Sea component, North Sea mackerel comprised on average 12% of the total spawning stock biomass of western mackerel and North Sea mackerel. It will be noted from Table 2.6, that in former years, the North Sea stock comprised over 25% of the combined total. On this basis, the estimated biomass of mackerel, of 98,811 t derived using the catch per boat method was divided 25% to N. Sea spawning component and 75% to the western spawning component.

**Table 2.6.** Recent stock sizes (in thousands of tonnes) of the North Sea and Western mackerel (Anon., 1999d).

Year	Spawning Stock Biomass (1000 t)			North Sea as % of total
	North Sea	Western	Total	
1972	1,249	3,085	4,334	28.8
1973	1,097	3,186	4,283	25.6
1974	1,036	3,211	4,247	24.4
1975	826	2,959	3,785	21.8
1976	700	2,604	3,304	21.2
1977	583	2,587	3,170	18.4
1978	436	2,768	3,204	13.6
1979	336	2,436	2,772	12.1
1980	258	2,073	2,331	11.1
1981	189	2,161	2,350	8.0
1982	162	2,052	2,214	7.3
1983	168	2,298	2,466	6.8
1984	133	2,296	2,429	5.5
1986	45	2,295	2,340	1.9
1988	37	2,472	2,509	1.5
1990	78	2,336	2,414	3.2
1996	110	2,352	2,462	4.5
1998	68	2,505	2,573	2.6
Average	417	2,538	2,955	12.1

Mackerel (from Yarrell, 1836).

From 1880 to 1886 the only reported catch of mackerel comes from Norway. Based on the proportion mackerel taken from the North Sea, in the Norwegian catch (Hoek and Kyle, 1905), the annual catch is estimated at 184 t in 1880 to 1886. For 1886-1890 catches of mackerel are also reported for England and Scotland. The Scottish catch is negligible and the Norwegian remains under 200 t. The largest mackerel fishery was prosecuted by English fishers, whose average catch amounted to 1,392 t (Figure 2.3). From a short account in Nall (1866, p. 340), it seems there was a brief summer mackerel fishery in the UK. In July 1862, Lowestoft boats took 336 hundred weight. It appears that the fishery was prosecuted with drift nets.

*“Drift-nets for mackerel are worked on entirely the same principle (as herring drift nets); but as these fish generally keep near the top of the water, the nets are well corked. A fleet of mackerel nets as used by the Yarmouth boats is, however, a very great length, and is made up of eleven or twelve score of nets extending to as much as 2.5 miles, or double that of a herring fleet.”*

Holdsworth (1874, p. 107).

De Caux (1881, p. 108) comments how the use of ice contributed to the ‘marvellous’ development of the trawl and mackerel fisheries. Making the assumption that the English mackerel fishery was alive in the early 1880s, with an annual catch of approximately 1,000 t, the total North Sea mackerel fishery is estimated as landing 1,184 t annually. Applying the same assumption regarding the distribution of biomass, the total reported catch was divided between the North Sea spawning component and the western stock.

The same values of P/B and Q/B used in the 1980s model were applied in the 1880s model for both stocks. Diet was constructed based on MSVPA data and 1980s model to complete the diet of prey items which comprise the ‘other food’ component specified in the MSVPA.

**Figure 2.3.** Catches of soles, brill, salmon, sturgeon, mackerel and turbot in the North Sea, 1850-1902.

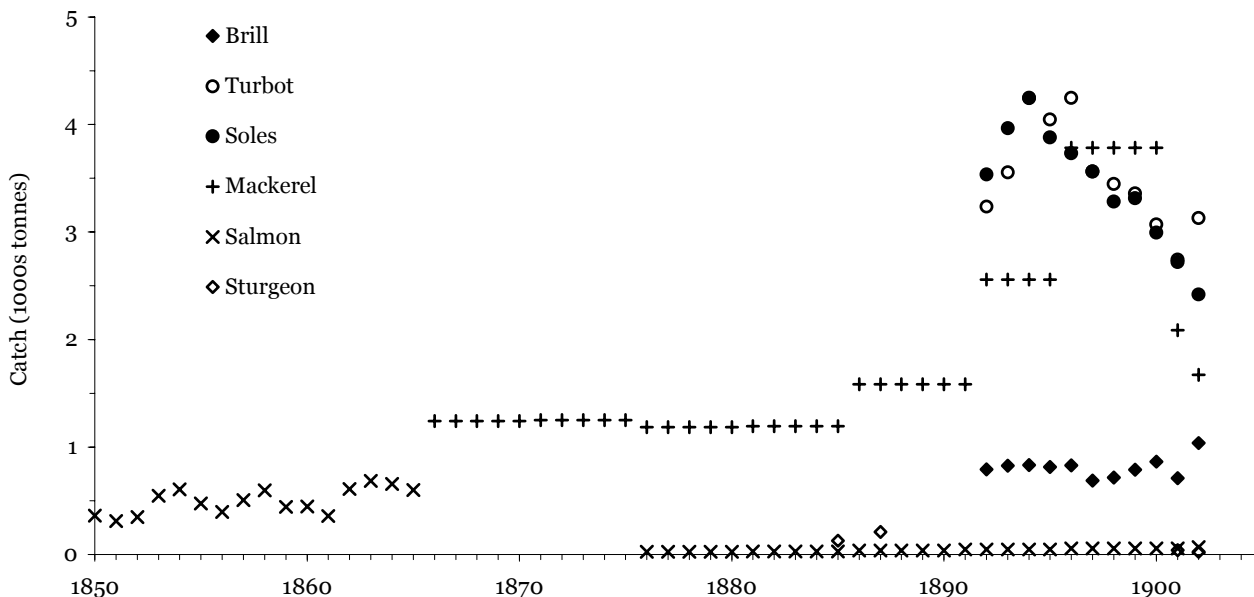

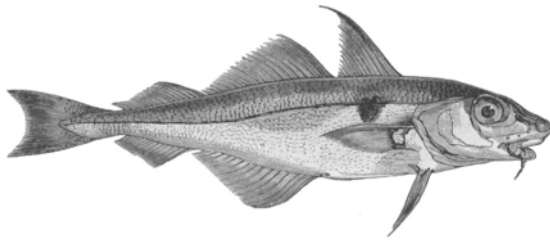

**Haddock (*Gadus aeglefinus*) adult and juvenile**

(from Yarrell, 1836).

*“On the basis of back-calculated standardised CPUE data for German fisheries, Lundbeck (1963) showed that as early as 1870, at least in the Southern North Sea, a strong decline on the abundance of haddock could be observed. There was some increase again during the 1880’s but from 1890 onwards there followed a further very steep decrease to a minimum around 1910. Small temporary increases around 1895 and 1905 were due to the influence of rich year classes, particularly that of 1900. Around 1910 the CPUE of the German vessels was only about 5% of the level of 1870. Lundbeck drew the conclusion that the continuing long term decline in the haddock stocks since 1870 was to a great extent due to natural causes. The justification came from the fact that the strong decrease in the very early years took place while the fishing intensity was still very low and hardly had much influence on mortality. A further argument is that after the minimum around 1910, the increase in abundance was already observed before the cessation of fishing. The decrease in the early years coincides with a retreat of the haddock from the Southern North Sea. It was as early as 1900 that the previously productive haddock long-line fishery of German vessels ceased after the catches had continuously declined since about 1885. It seems that there has been a contraction and shift to the northwest of the whole migratory system of the haddock. Lundbeck (1963) assumed that the changes in distribution of haddock were due to environmental changes with the haddock avoiding higher water temperatures in the southern shallow areas during summer”.*

Sahrhage and Wagner (1978).

Using the Catch per Hour Method, the estimated biomass of 516,304 t (Table 1.16) is comparable

with more recent estimate of Sparholt (1990) and Christensen (1995). Biomass of juveniles was estimated in Ecopath under the by assuming an  $EE=0.05$ .

Haddock were principally taken from the Dogger Bank by trawlers but also by liners (Holdsworth, 1874). Based on the reported catch of England and Scotland alone, the combined estimated annual total catch between 1886-1890 was 113,187 t. This figure is used in the model. Catches from the English fleet were 2 times that of the Scottish fleet. Average annual catch for the period 1892-1895 were 155,558 t and include catches from Germany and Holland, in addition to England and Scotland. Caution must be noted for the reported catches since some of the catch is undoubtedly from areas outside the North Sea. In the later years, it appears that at least 20% of the haddock landed in Germany in 1902 and 1903 came from Iceland and the Faroes.

*“If similar proportions are brought from those places by the English and Scottish liners and trawlers, nearly one fifth of the total quantities stated for later years have not been taken in the North Sea. The amount of uncertainty in the catches is large, but it seems as if the catches were at a maximum in 1895-96, the years which saw the introduction of the otter trawl, and that they have since then steadily declined. If the quantities taken from Iceland since that time have increased, as the German statistics indicate, then there seems every possibility that the quantities taken from the North Sea have declined”.*

Kyle (1905, p. 38).

Haddock weights: large = 1.5 kg, small=0.5 kg (Hoek and Kyle, 1905). The same values of P/B and Q/B used in the 1980s model were applied in the 1880s model. Juveniles P/B and Q/B ratios were assumed to double that of the adults.

Ritchie (1937 and 1938), and others have shown that haddock is mainly a mixed feeder on benthic types, so that competition with cod is relatively slight. Nevertheless both fishes feed heavily on sandeels, though not at the same time and place. Furthermore, in contrast to the whiting, the haddock was shown feeding mainly on echinoderms, annelids, molluscs, crustacean and sandeels in certain areas during August-December (Rae, 1967a). Jones (1954) gives diet for three size categories of haddock. Those above 30 cm were considered to constitute adults, those below juveniles. The principal fish consumed by haddock of less than 26 cm was sandeel. In the

larger haddock, sandeel and also Norway pout were present in some 4-8% of the stomachs and the remaining percentages were due to the presence of herring and herring spawn. Also consumed were *Sebastes*, *Trigla*, *Gobius* and long rough dab, but in insignificant proportions. Smith (1890) also provides details on diet of adult haddock. Diets of adults and juveniles applied in the model were modified according to the fish prey items given in MSVPA (V. Christensen, Fisheries Centre, UBC, pers. comm.) and that given by Christensen (1995) in the 1980s model of the North Sea.

### **Herring (*Clupea harengus*)**

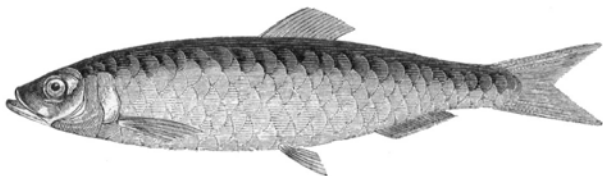

(from Yarrell, 1836).

Using the Catch per Hour Method, the biomass of herring is used in the 1880s model of the North Sea is just less than 11.25 million tonnes. Note that this estimate was revised downwards during model balancing.

Available data on herring fisheries were compiled as far back as 1808, including statistics from the major herring fisheries; Dutch, English and Scottish. However, the continuity of the data is interrupted at several times. Little data is available neither for England 1858 to 1891 nor for Scotland 1876-1884. The Dutch series is the longest continuous data set.

In 1808 the Board of the British white herring fishery was established. Its statistics from 1808 to 1875 were very complete for Scottish ports and for some ports in the north of England and the Isle of Man. Unfortunately, the returns from other English ports gave figures for white herring only (the salted herring); the fresh and the red-herring were excluded. The Scottish fishery was predominantly for white herring. By 1849, English statistics were dropped completely and none can be traced as a continuous series until 1886. Palmer (1854 in Cushing, 1988) says 19,680 t were taken by 193 Yarmouth vessels in 1817 and that up to 1854, an average of about 3,500 lasts (8,610 t) was a reasonable estimate. Nall (1866, p. 339) provides some data for Lowestoft herring fishery up to 1862. Based on a comment on the Yarmouth catch in 1862 (p. 347), the combined Yarmouth and Lowestoft catch for that year is estimated as 33,528 t. By far the largest fishery

and supreme fishers in the 1880s were the Scottish herring fishers. Towards the end of the 19<sup>th</sup> Century until early 1920s, the English herring fisheries expanded rapidly and became the largest (Figure 1.3). The catch in 1875 is used in the model to represent catches in the 1880s due to the lack of data from Scottish fisheries around 1880. Statistics only for Dutch, Norwegian and Scottish herring fisheries are available at this time; a total of 177,264 t. The catch by English fisheries is thought to be considerably less than those of the Scottish, and due to the absence of data, and likewise for German and French fisheries, it is not included. Thus this constitutes an underestimate of the likely catch. Based on Figure 1.3, it is likely that the annual herring catch around 1880 was close to 200,000 t.

The same values of P/B and Q/B used in the 1980s model were applied in the 1880s model.

Herring are pelagic planktivores preying predominantly on copepods and euphausiids. It is likely that they also take pelagic larvae of other fishes and some phytoplankton. The diet was based on the 1980 model with small modifications to the proportions of euphausiids, copepods and fish in the diet.

### **Sprat (*Sprattus sprattus*)**

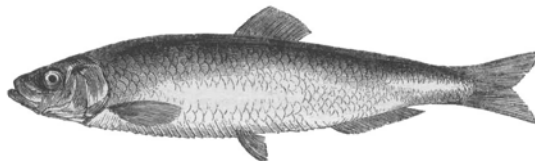

(from Yarrell, 1836).

*“During the winter of 1829-30, the sprat fisheries were so successful that loads from 1000-1500 bushels – costing 12 to 16 cents a bushel- were brought from to Maidstone to be used as manure for the hop-fields”.*

Dambeck (1876).

Other than this brief mention of early sprat fisheries on the south coast of the UK, there are few references to sprat fisheries. For a considerable period of time, it remained in question whether or not sprats were just immature herring.

There is little information on which to derive a biomass estimate for sprat stocks. The reported annual average of English and Scottish catch of sprat between 1886-1890 is 4,897 t. It is likely

that the Dutch were also catching sprats at that time although statistics are not available until 1892. Reported UK sprat catches also include an undetermined proportion of herring and anchovies. Assuming an exploitation rate of 10%, the biomass of herring is estimated at 48,973 t. The abundance is 6 times less than the value used in the 1980s model.

The English and Scottish combined annual average catch 1886-1890 of 4,897 t, was used in the model.

The same values of P/B and Q/B used in the 1980s model were applied in the 1880s model.

Like herring, sprat pelagic planktivores preying predominantly on copepods, small crustaceans and euphausiids. A simple diet was constructed using this information.

### **Norway pout (*Trisopterus esmarkii*)**

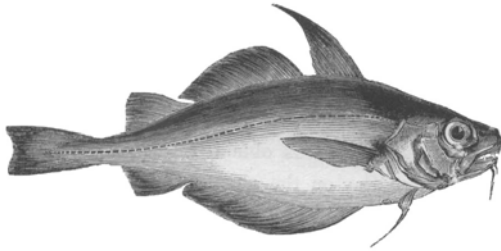

(from Yarrell, 1836).

Norway pout are distributed widely across the North Sea and generally most abundant in water 100-200 m deep. It is very common of the west and north Scottish coasts and the northern North Sea (Raitt, 1964).

No information was found on the abundance or landing of Norway pout. Catches are likely to have been included in the categories classed as 'trawl offal' in earlier reports or 'fish not separately distinguished' in later ones. The same biomass used in the 1980s model was applied in the 1880s model.

The P/B value used in the 1980s model was applied to Norway pout in the 1880s model. Consumption to biomass ratio was calculated as 9.61 year<sup>-1</sup> using the empirical equation of Palomares and Pauly (1998), assuming a water temperature of 10 °C.

Scott (1902 and 1903) recorded mainly crustaceans in the diet of Norway pout, with schizopods, amphipods (*Parathemisto*, *Hyperiidae*) and pelagic copepods more frequent

than other members of that group. More recent work by Gokhale (1953) verified the importance of pelagic crustaceans. Gokhale (1953) also observed that older fish take more fish larvae. Planktonic crustaceans form the bulk of the diet, copepods and euphausiids being prime importance. There was evidence to show that the juvenile fish tended to have more copepods in the stomachs than the adults. Diet was based on percentage frequency of occurrence data given by Gokhale (1953). Based on this diet, Norway pout feed predominantly on copepods and other crustaceans.

### **Sandeel (*Ammodytes marinus*)**

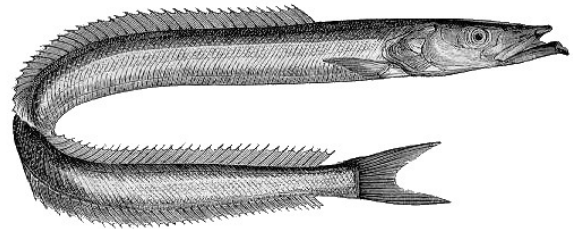

(from Yarrell, 1836).

Sandeels constitute an important prey item in the diet of many North Sea predators including whales, seabirds, cod, haddock, whiting and halibut among others.

No information was found on the abundance or landing of sandeels. The same biomass used in the 1980s model was applied in the 1880s model.

Production values used in the 1980s model were applied to sandeels. Q/B was calculated as 10.25 year<sup>-1</sup> using the empirical equation of Palomares and Pauly (1998), assuming a water temperature of 10 °C.

Sandeels are pelagic during daylight hours, preying on a variety of zooplankton in the water column. At night time they bury in to sandy sediments in shallow water regions such as the Dogger Bank. The same diet given in the 1980s model was used for the 1880s.

### **Plaice (*Pleuronectes platessus*)**

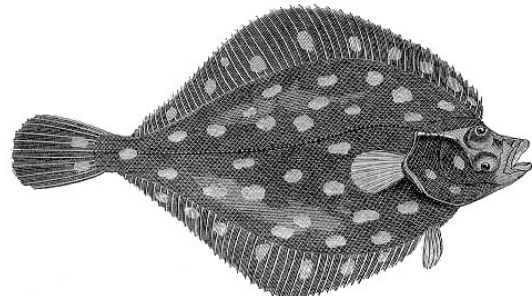

(from Yarrell, 1836).

*“Plaice are another fish caught in countless numbers by the trawlers, are also generally distributed around the coast. Formerly ‘live-plaicing’ was common and they fetched a high price – they were caught in welled-smacks, such as are used for the North Sea cod fishery. Now it is not in such demand”.*

Holdsworth (1874).

A middle biomass estimate of 2,373,940 t (Table 1.16) was applied in the 1880s model based on possible minimum and maximum estimates determined from research trawls conducted in 1902-1903 (Garstang, 1905; Table 1.14) The estimate is 6 times greater than the biomass used in the 1980s model.

English beam trawlers accounted for approximately 90% of the reported catch of plaice in the late 1880s. The only other statistics found for the 1880s were from Scottish fisheries (Kyle, 1905). The total catch of English and Scottish vessels in 1886 is estimated as 32,337 t. However, clearly plaice were being sought by other countries prior to this time. Dambeck (1876) notes that in Germany in 1873 so many plaice were caught that whole wagon loads were sold for a trifle. In 1895, statistics were also available for Germany, Holland and Denmark; the total catch in that year being 46,380 t, of which the English component comprised 73%. Supporting the contentions of Fulton (1892), Holt (1895) recorded that 83% of the North Sea catch of plaice was immature or below the biological size limit. For reference, Lamont (1964) provides a table of landings by British vessels in Scotland for period 1904-1961.

The same values of P/B and Q/B used in the 1980s model were applied in the 1880s model.

Diet is based on the percentage frequency occurrence of prey items from Smith (1890). Dominant food items include polychaetes and macrobenthos.

### **Sole (Solea solea)**

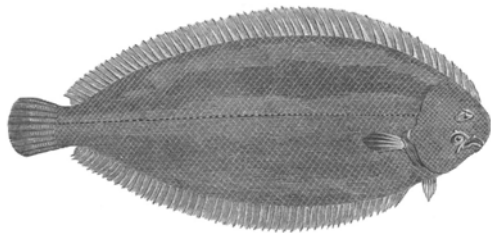

(from Yarrell, 1836).

*“Soles are generally distributed wherever there is clean sandy ground; but they are not found so much in very deep water, except during cold weather. The London market is generally supplied with this fish from the banks off the Norfolk coast and from the Channel. Its is rarely that any number of soles is landed at Hull, and the Grimsby shops are often supplied from London. The great Silver pit was first worked over in a very severe winter (1843). Soles were caught in incredible numbers, nets bristling with fish trying to escape through the meshes. Discovery soon got wind and a migration of trawlers from Ramsgate and Brixham took place; but although with the end of the cold weather attention breaking up from the Silver pit, more attention was henceforth directed to the North Sea; and the Silver pit was found productive in very severe winters ‘Pit seasons’ as the trawlers called it.”*

Holdsworth (1874).

The middle value of biomass estimated from 1902-1903 research trawl surveys was used in the 1880s model. The biomass of 363,260 t is approximately 8 times the value used in the 1980s model and 6 times the total biomass of soles estimated for the North Sea by Sparholt (1990; Table 1.14).

Soles were the most valuable species in the North Sea and sold separately, thus the statistics therefore have greater accuracy than plaice and because the quantities captured outside the North Sea area are small and negligible in comparison to the numbers taken within it.

*“Catches from Belgium, which lies close to the richest area, are not forthcoming, but to judge from the numbers of the fishing fleet it is probable that catches have increased over the period considered. [Figure 2.3] shows catches have decreased. Apart from the actual decline in the stock there seems to be only one cause which may account for this. The switch from beam trawl to otter trawl (less efficient for soles) and the decline in the sailing trawlers that used the beam trawl. Also the size has declined so the decreased capture might reflect the fact the smaller fish are not so readily caught as the larger ones”.*

Kyle (1905).

As for the plaice, English beam trawlers appear to have been responsible for the bulk of the sole catch, averaging 3,014 t annually between 1886-1890 (Figure 2.3). This value is used in the model. Statistics for Germany and Holland became available in 1892 and for Denmark (although a very small amount) in 1895 (Kyle, 1905). Between 1892-1895 the English catch, still the largest, constitutes 77% of the catch. On an average 100 soles are comprised of 17 big (0.5 kg), 23 middle (0.28 kg) and 60 small (0.1 kg, Hoek and Kyle, 1905).

The P/B ratio used in the 1980s model was applied to sole. Assuming a water temperature of 10°C, consumption to biomass ratio was calculated as 3.36 year<sup>-1</sup> using the empirical equation of Palomares and Pauly (1998).

The diet of sole was constructed as a composite from diets from lemon sole (Rae, 1956, % volume; Smith, 1890, % frequency of occurrence) and witch sole (Smith, 1890, % freq. occur.). Rae (1956) presents work on diets consisting of 5,000 stomach samples. The samples confirm the predominance of polychaetes in the diet of the lemon sole. He concludes that certain types, for example crustaceans and echinoderms, are probably less important than the frequency of their occurrence indicates. The food of the witch is predominantly polychaete worms. Small crustaceans, chiefly amphipods and cumaceans, are also commonly eaten, though volumetrically not of much significance. Anthozoans, gephyreans and fish are apparently of greater value to the larger witches in certain areas (Rae, 1969).

### **Brill (*Scophthalmus rhombus*)**

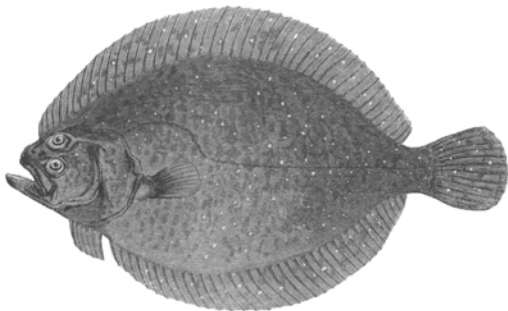

(from Yarrell, 1836).

*“Trawl fish were classified under the names ‘prime’ and ‘offal’; the former including turbot, brill, soles, and John dorys; the latter comprising plaice, cod, haddocks, gurnards, skate and other such*

*kinds as are occasionally caught in the trawl”.*

Holdsworth (1874).

The biomass of brill was estimated by the Catch per Hour Method. The middle value between the maximum and minimum estimates was applied in the model; a value of 757,576 t.

Catch statistics from 1886-1890 are only available for the English fleet. The annual average catch of 597 t was used as the catch in the 1880s. From 1892 onwards, German statistics also become available although their proportion of the total catch (6.5%) is very small in comparison to England (Kyle, 1905).

The production of Brill is not known and is left to be estimated in Ecopath. Consumption to biomass ratio of 2.21 year<sup>-1</sup> was predicted using the empirical equation of Palomares and Pauly (1998), assuming a water temperature of 10°C.

No specific information on the diet of brill was found. It is assumed that brill have similar feeding habits to other flatfish, and on this basis a diet consisting of polychaetes, macrobenthos, echinoderms, crustaceans and other invertebrates was constructed.

### **Halibut (*Hippoglossus hippoglossus*) and turbot (*Scophthalmus maximus*)**

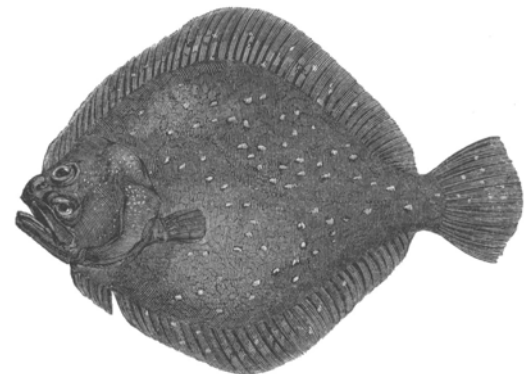
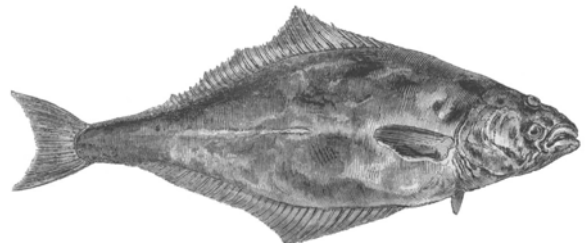

Halibut and turbot (from Yarrell, 1836).

“Turbot are more or less found on all parts of the coast; the North Sea has long been famous for these fish, especially along the Dutch shore, where, during warm weather, they are caught in very shallow water.”

Holdsworth (1874).

Although common, halibut were less abundant in comparison to turbot. Turbot especially was a highly prized, prime species, the focus for many of the English trawling smacks. The abundance of halibut is estimated from the English and Scottish longline and trawlers reported catch in 1886-1890 based on an assumed 10% exploitation rate. Total biomass of halibut is estimated as 57,870 t. Biomass of turbot was estimated by the catch per hour method. The middle value between the maximum and minimum estimates was applied in the model; a value of 1,237,374 t.

Average annual catches of halibut from English and Scottish longlines and trawlers in 1886-1890 was 5,787 t. Statistics for Germany and Holland become available from 1892-1895, although their combined catch is just less than 100 t of the 6,110 t taken in 1892. English and Scottish fishers once again having the highest catch (Hoek and Kyle, 1905). In Sweden, the implement called the ‘storbackan’ was used to catch halibut. It consisted of a line with hooks which was laid out on the fishing banks to the depth of 100 fathoms and was baited with mussels or pieces of fresh fish (Dambeck, 1876).

Like the sole, the turbot was sold separately and the quantities are readily estimated. It is probable however that a considerable proportion of catches came from grounds outside the North Sea (Kyle, 1905). With the expansion of Scottish trawler fleet from the 1880s to the beginning of the first world war, landings of turbot at first increased, reaching a maximum of about 9000 cwt in 1903, but from that year until the outbreak of WWI catch declined (Figure 2.3), possibly as a result of trawlers temporary abandoning local grounds for more profitable areas in the North Sea where other species were abundant but turbot was not (Rae and Delvin, 1972), and also because of their lower efficiency with respect to these species than the sailing beam trawlers (Garstang, 1903a). In 1886-1890, annual average catch by English and Scottish vessels was 2,733 t. In 1892-1895, their proportion of the total catch was 88%, Germany and Holland accounting for the remainder.

Total combined landing of halibut and turbot used in the model is 8,520 t. Average weights: turbot 5 kg and halibut 9 kg (Hoek and Kyle,

1905). Growth of halibut is continuous throughout their lives and shows little decrease at older ages (Venier, 1996). Both halibut and turbot grow relatively fast and are relatively long lived. P/B was set to half the  $r_{max}$  in FishBase, giving a value of 0.27 year<sup>-1</sup>. An average Q/B ratio of 2.78 year<sup>-1</sup> was used in the model based on individual turbot and halibut Q/B’s predicted using empirical equation of Palomares and Pauly (1998) assuming a water temperature of 10°C (Table 2.7).

**Table 2.7.** Estimates of intrinsic rate of increase and food consumption per year for turbot and halibut

Species	$r_{max}$ (year <sup>-1</sup> )	Q/B (year <sup>-1</sup> )
Turbot <i>Psetta maxima</i>	0.76	2.42
Halibut <i>Hippoglossus hippoglossoides</i>	0.32	3.14

Halibut are rarely preyed upon by other fish and cannibalism (in Pacific halibut) is low (<7%) (Venier, 1996). Seals were perhaps the most important predators of halibut and turbot. Diet is based on diet of halibut given by McIntyre (1952) who gives diet composition in percentage volume.

#### **Horse mackerel, scad (Trachurus trachurus)**

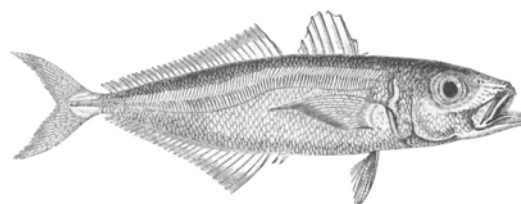

(from Yarrell, 1836).

Given that no information on the abundance or catch of horse mackerel is available in or around the 1880s, the biomass value of 795,500 t used in the model is taken from Sparholt (1990). Garstang (1905) reported catches of 32 scads in a beam trawl survey. No attempt was made to derive a biomass estimate from this, due to the unsuitability of the beam trawl for sampling pelagic fish.

No information is available other than noting that they were often caught by herring drifters (Butcher, 1975).

Production rate value from mackerel was used as a surrogate for the horse mackerel. The Q/B for horse mackerel was taken from the 1980s model ‘other predators’ whose value was based on horse mackerel (Christensen, 1995).

The horse mackerel is similar in foraging habits to the mackerel. Diet composition was constructed based on MSVPA diet for horse mackerel. Modifications were made to account for the group 'other food' accounting for over 50% of the diet. This was divided among, euphausiids, copepods and other crustaceans.

### **Salmon (*Salmo salar*) and seatrout (*Salmo trutta*)**

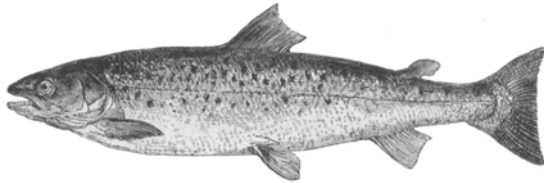

Salmon (from Yarrell, 1836).

The abundance of salmon and seatrout is estimated from catches in 1850-1865 by Norway, Holland and Scotland on an assumed 10% exploitation rate, giving a total biomass of 4,965 t.

Bertram (1865, p. 222) provides the best statistics for salmon fisheries around the UK and North Sea based on the number of boxes (each weighing 112 lbs) sent to London. Based on the statistics presented for Scotland, Ireland, Wales, Norway and Holland between 1850-1865, it was assumed that North Sea catches were comprised of all of Dutch catch and 50% of both Norwegian and Scottish catches, giving a total annual average catch for the period of 496 t. In Hoek and Kyle (1905) and Kyle (1905), statistics for North Sea salmon catches in the 1880s are only forthcoming from Norway.

The P/B was set to half of  $r_{\max}$ , which is approximately 0.8 for both salmon and seatrout (Palomares, 1991), giving a value of 0.4 year<sup>-1</sup> (Table 2.8). The Q/B ratio of 7.14 year<sup>-1</sup> was used in the model based that given for salmon by Palomares (1991).

**Table 2.8.** Estimates of intrinsic rate of increase and food consumption per year for salmon and seatrout

Species		$r_{\max}$ (year <sup>-1</sup> )	Q/B (year <sup>-1</sup> )
Salmon	<i>Salmo salar</i>	0.86	7.14
Sea trout	<i>Salmo trutta</i>	0.8	-

Diet was constructed by assuming that salmon and seatrout prey predominantly on euphausiids (from which they get their pink flesh colour), shrimps and a variety of small pelagic fish and juveniles of larger fish.

### **Gurnards**

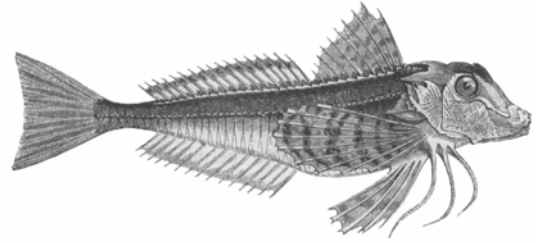

Great gurnard (*Eutrigla gurnardus*) (from Yarrell, 1836).

A minimum biomass estimate is derived from beam trawl surveys made throughout the North Sea in 1902-1903 (Garstang, 1905; Table 1.14). It is assumed that the beam trawl was only 10% efficient and the catch per unit area is increased 10 fold accordingly. The combined abundance of grey gurnard (*Eutrigula gurnardus*), red gurnard (*Aspitrigla cuclus*), parrot or streaked gurnard (*Trigloporus lastoviza*) and tub gurnard (*Trigla lucerna*), are taken to represent the 'Gurnards'. Total biomass for the North Sea being 516,648 t of which the grey gurnards account for 74%. The total biomass is 1.4 times that estimated by Sparholt (1990).

German and Dutch reported catch statistics for gurnards include weevers and mackerel respectively, and are therefore likely to result in an overestimation of actual gurnard catch from these countries. In contrast, there are no statistics for catches of gurnards by England and Scotland, with gurnards likely being a component of the English catch of 'fish not separately distinguished' (53,661 t), and the Scottish catch of 'other kinds' (4,427 t). Therefore, the total reported catch of gurnard is likely to represent a considerable underestimation of the actual removals. In the model, the total annual average catch of Germany and Holland in the period 1892-1895 is used; 698 t (Hoek and Kyle, 1905). Gurnards weigh on average 0.15 kg (Hoek and Kyle, 1905).

P/B was set to half the  $r_{\max}$  in FishBase, giving a value of 1.4 year<sup>-1</sup>. Using a water temperature of 10°C the empirical equation of Palomares and Pauly (1998) was used to predict a Q/B for grey gurnard of 5.2 year<sup>-1</sup>.

The diet composition was constructed based on Smith (1890) and MSVPA diet for gurnard. Modifications were made to account for the group 'other food' accounting for over 50% of the diet. This was divided among, euphausiids, copepods and other crustaceans.

**Other predatory fish**

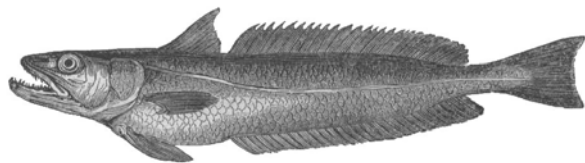

Hake (*Merluccius merluccius*) (from Yarrell, 1836).

The species combined in the group ‘other predatory fish’ are listed in Table 2.9. Total biomass was estimated based on 1902, 1903 research trawls (Garstang, 1905) for most species. For hake and tusk, biomass was determined from reported catches (Hoek and Kyle, 1905), on the assumption of a 10% mortality. Total biomass used in the model was 126,859 t. This value is 3 times less than the biomass estimated for these species in 1980 by Sparholt (1990, 326,500 t).

**Table 2.9.** ‘Other predatory fish’ in the North Sea, 1880s.

Anglerfish	<i>Lophius piscatorius</i>
Conger	<i>Conger conger</i>
Hake	<i>Merluccius merluccius</i>
Ling	<i>Molva molva</i>
Longspined bullhead	<i>Taurulus bubalis</i>
Ocean perch	<i>Sebastes marinus</i>
Pollack	<i>Pollachius pollachius</i>
Scaldfish	<i>Arnoglossus laterna</i>
Tusk	<i>Brosme brosme</i>
Wolf-fish	<i>Anarhichas lupus</i>
Long rough dab	<i>Hippoglossus platessoides</i>

Total landing for the other predatory fish is based on the combined annual average landing reported for ling, tusk, conger eel and hake in the 1886-1890 from various countries. Total landing was 9,034 t.

The P/B ratio of other predatory fish used in the 1980s model was applied in the 1880s model. The Q/B is unknown for this group and was left to be estimated in Ecopath, using the assumption that EE=0.95.

Smith (1890) details diets for long rough dab and anglerfish. Rae (1963) says Norway pout is the most common identifiable fish in the stomachs of megrim from the North sea and that in this area is the principal food of the larger megrim (Graham, 1923). Saemundsson (1949) states that around Iceland, Norway pout is also of great importance as food of many fishes, particularly cod and ling. A composite diet for ‘other predatory fish’ was constructed using this

information. ‘Other predators’ were assumed to consume small proportions of all fish groups, and differing proportions of invertebrates.

**Other prey fish**

The ‘other prey fish’ group is focused on dab, *Limanda limanda*. The biomass for this group, derived using the catch per hour method is 1,161,616 t, approximately 25% less than the biomass estimated for dab in 1980 by Sparholt (1990). The other prey fish group was extended to include all other ‘prey’ species caught during 1902, 1903 trawl surveys (Garstang, 1905). The species are listed in Table 2.10. The total biomass of the various species was combined with that of dab to get a total overall biomass for other prey fish of 1,278,574 t. Based on Garstang’s trawls, dab comprise 82% of the catch, and lemon sole 9%, the rest being divided among the remaining species. Sparholt’s (1990) total biomass estimate for the same group of species was more than double, 2,275,000 t.

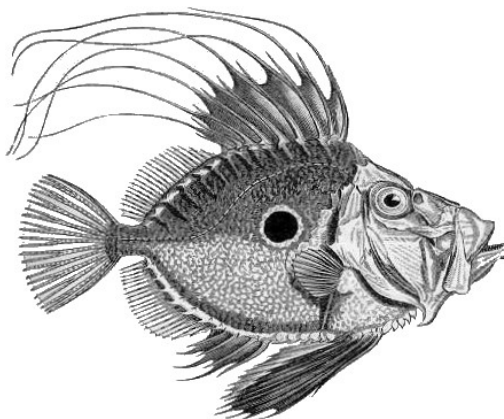
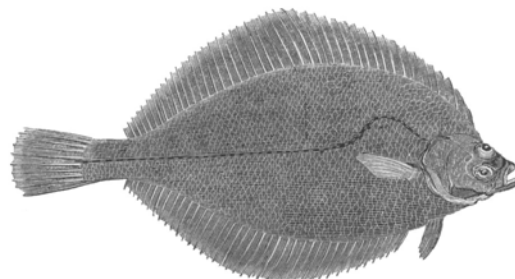

Dab (*Limanda limanda*) and John dory (*Zeus faber*) (from Yarrell 1836).

Catch data for other prey fish are derived from Hoek and Kyle (1905). German and Dutch catches of dab in 1892-1895 amounted to 4,181 t; Scottish catches of lemon sole and witch in 1886-1890 to



607 t and 'fish not separately distinguished' from English trawls; 53,661 t. Total catch of other prey fish used in the model is 58,449 t.

Consumption rates from the 1980s model (derived from information given by Creutzberg and Duineveld (1986) for dab in the Southern North Sea) were applied in the model. The production rate for 'other prey fish' was set to half of  $r_{max}$  for dab (FishBase), giving a value of  $0.77 \text{ year}^{-1}$ .

Smith (1890) give diet of dab, Creutzberg and Duineveld (1986) give average annual diet compositions for dab on mud and sand bottom. Baden (1986) reports various food studies of dab indicating that echinoderms and other benthos predominate in the diet, while Knust (1990) reports that the main part of the food of dab in the German Bight was brittle star, *Ophiura albida*, in spring, and crustaceans, chiefly amphipods, in summer. The actual diet composition is assumed based on these sources.

**Table 2.10.** Other prey species in the North Sea, 1880s.

Argentine	<i>Argentina sphyraena</i>
Bib (pout)	<i>Trisopterus luscus</i>
Blue whiting	<i>Micromesistius poutassou</i>
Chimaera	<i>Chimaera monstrosa</i>
Dragonets	<i>Callionymidae</i>
Flounder	<i>Platichthys flesus</i>
Fourbeard rockling	<i>Rhinonemus cimbricus</i>
Greater argentine	<i>Argentina silus</i>
Hooknose	<i>Agonus cataphractus</i>
John dory	<i>Zeus faber</i>
Lemon sole	<i>Microstomus kitt</i>
Lump sucker	<i>Cyclopterus lumpus</i>
Megrim	<i>Lepidorhombus whiffiagonis</i>
Norway haddock	<i>Sebastes viviparus</i>
Poor cod	<i>Trisopterus minutus</i>
Red mullet	<i>Mullus surmuletus</i>
Sand sole	<i>Solea lascaris</i>
Sea-snail	<i>Liparis liparis</i>
Shorthorn sculpin	<i>Myoxocephalus scorpius</i>
Silvery cod	<i>Gadiculus argenteus</i>
Solenette	<i>Buglossidium luteum</i>
Thickback sole	<i>Microchirus variegatus</i>
Three-beard rockling	<i>Gaidropsarus vulgaris</i>
Weever	<i>Trachinus vipera</i>
Witch	<i>Glyptocephalus cynoglossus</i>

## Cephalopods (octopus, squid and cuttlefish)

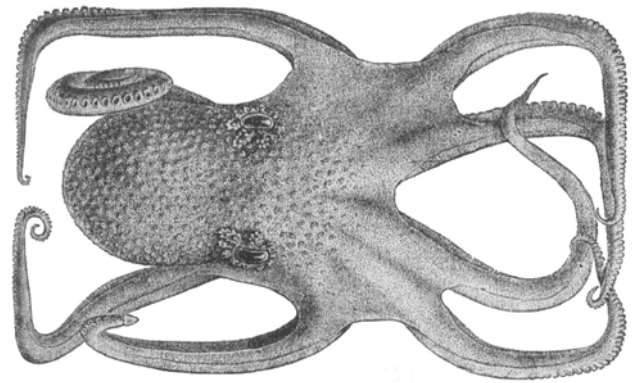

(from Fowler, 1912).

No information on the abundance of cephalopods was available, nor was any mention made of any catches. Small squid occur frequently in pelagic trawls and probably have a relatively high biomass. Biomass of squid was estimated in the model accordingly, and is largely dependent on the demands of their predators. Squid are important prey items for many fish. The P/B and Q/B values used for squid were taken from an Alaska Gyre model (Christensen, 1996); these were  $3.0 \text{ year}^{-1}$  and  $15.0 \text{ year}^{-1}$  respectively. Diet composition information is adapted from indices of relative importance in prey composition of *Loligo opalescens* in Karpov and Cailliet (1978). Predominant food items are euphausiids, copepods and fish larvae.

## Zooplankton

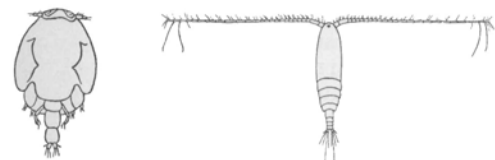

*Caligus* and *Calanus* copepod zooplankton (from Fowler, 1912).

Fransz *et al.* (1991b) summarises the available knowledge on the herbivorous and omnivorous zooplankton of the North Sea. During March/April in the Fladen ground, Williams and Lindley (1980a) recorded large stocks of euphausiids representing more than 90% of the entire zooplankton biomass at that time. With the onset of thermal stratification and the phytoplankton spring bloom, the biomass of copepods increased, reaching as much as 80-90% of zooplankton biomass by May (Fransz *et al.*, 1991b).

The energy transferred through herbivorous zooplankton is not necessarily derived entirely through the direct consumption of autotrophs

(phytoplankton). There is now considerable evidence (Williams, 1981; Joiris *et al.*, 1982; Sherr *et al.*, 1986) that an alternative route exists whereby particulate material originating through heterotrophic processes can enter the conventional meso-zooplankton food chain. The packaging of particulate egesta into faecal pellets by many zooplankton is thought to be a highly important process in the rapid transport of food material to the sea bed. However, the proportion of particulate flux to the benthos between the processed faecal material and ungrazed particulate matter is still a matter of conjecture (Fasham, 1984).

The pivotal position of herbivorous zooplankton between the primary producers and the tertiary consumers can be considered in three ways. The effects of variability in primary production on the herbivores, the effects of the herbivores on the primary producers and the effects of the tertiary consumers. Steele (1974) proposed that most primary production in the open sea was consumed by zooplankton but it is evident that this is not always the case. Estimates of the percentage consumption of total primary production by grazing zooplankton in different areas of the North Sea, vary from 35-100% (average 65%).

In lieu of any estimates for copepod production, consumption and biomass in the 1880s, more recent values were used. Copepods often form 60-90% of total zooplankton biomass. They have a high growth rate. Fransz *et al.* (1991b) published average daily production rates for May-September and P/B ratio for zooplankton (Table 2.11). Production was converted from gC to wet weight based on 10 gC=1 g wet wt (the same as Christensen, 1995; Mathews and Heimdal, 1980; Mackinson, 1995). Calculating annual production, the average across species gave a production of

approximately 20 g wet wt·m<sup>-2</sup> for May-September and P/B ratio of 9.2. Based on this, the estimated biomass of these species is 2.15 g wet wt·m<sup>-2</sup> (May-September). The estimate does not include information from *Calanus finmarchicus*, the most abundant and productive copepod.

Fransz *et al.* (1991b) also provides other production estimates of abundant calanoid copepods species by Evans (1977), Martens (1980) and Roff *et al.* (1988):

- Evans (1977) multiplied the mean standing stock by the number of generations per year = 3.5 gC·m<sup>-2</sup>·year<sup>-1</sup> (7.74 g·m<sup>-2</sup>·year<sup>-1</sup>, 35 g wet wt·m<sup>-2</sup>·year<sup>-1</sup>);
- Martens (1980) summed peak maxima over the year for the Wadden Sea 0.4 gC·m<sup>-2</sup>·year<sup>-1</sup> (4 g wet wt·m<sup>-2</sup>·year<sup>-1</sup>, estimate is considered too low by Fransz *et al.* (1984));
- Roff *et al.* (1988) estimated by multiplying mean biomass of copepods by instantaneous copepodite growth and by the number of generation per year – mean 16.5 gC·m<sup>-2</sup>·year<sup>-1</sup> (165 g wet wt·m<sup>-2</sup>·year<sup>-1</sup>, this is considered by Fransz *et al.* (1984) as to high).

Krause and Trahms (1983) also present data sets of zooplankton material from the Fladen ground experiment (FLEX 76) March-June 1976 in the form of depth integrated time series (0-150 m). *Calanus finmarchicus* was the most important herbivorous copepod during FLEX. Its standing stock had the largest biomass in the last phase of the experiment, up to 70% of the total zooplankton biomass (Williams and Lindley, 1980a). Data from Krause and Trahms (1983) and Broekhuizen *et al.* (1995) were used to calculate a standing biomass of 135 g·m<sup>-2</sup> (Table 2.12 and 2.13).

**Table 2.11.** Zooplankton production per day, per year (year = 183 days from May to September); Production/Biomass (P/B); g wet wt·m<sup>-2</sup> is the same as t·km<sup>-2</sup> (Franz *et al.* 1991b).

Species	Production per day (g C·m <sup>-2</sup> ·d <sup>-1</sup> )	Production per year (g C·m <sup>-2</sup> ·yr <sup>-1</sup> )	Production (g wet wt·m <sup>-2</sup> )	P/B (year <sup>-1</sup> )
<i>Temora longicornis</i>	0.011933	2.1838	21.838	8.667
<i>Acartia clausi</i>	0.006033	1.1041	11.041	7.667
<i>Pseudocalanus elongatus</i>	0.014267	2.6108	26.108	11.167
Mean across species	-	-	19.662	9.167

**Table 2.12.** Estimation of zooplankton biomass based on density per unit area and mean weights (g wet wt·m<sup>-2</sup> is the same as t·km<sup>-2</sup>).

Species	Average no. of individuals·m <sup>-2</sup> (0-150 m) <sup>a</sup>	Body weight (µg C) <sup>b</sup>	Biomass		
			(µg C·m <sup>-2</sup> )	(g C·m <sup>-2</sup> )	(g wet wt·m <sup>-2</sup> )
<i>Microcalanus pusillus</i>	83,000	5.84	484720	0.48472	4.85
<i>Oithona similis</i>	222,000	5.84	1296480	1.29648	12.96
<i>Paracalanus paracalanus</i>	17,000	5.84	99280	0.09928	0.99
<i>Calanus finmarchicus</i>	167,000	67.2	11222400	11.2224	112.22
<i>Pseudocalanus elongatus</i>	42,000	5.84	245280	0.24528	2.45
<i>Microsetella norvegica</i>	11,000	5.84	64240	0.06424	0.64
<i>Metridia lucens</i>	11,000	5.84	64240	0.06424	0.64
<i>Acartia claus</i>	17,000	5.84	99280	0.09928	0.99
Total	570,000	-	-	13.5759	135.76

<sup>a</sup> Based on Krause and Trahms (1983); <sup>b</sup> based on Broekhuizen *et al.* (1995; Table 31).

**Table 2.13.** Individual weights used for converting numbers to biomass (Broekhuizen *et al.* 1995).

Species	Weight (µg C)
Small copepods	5.84
<i>Calanus</i>	67.20
<i>Pareuchaeta</i>	18
<i>Evadne</i> spp.	1.01
<i>Limacina retroversa</i>	4.09
Euphausiids	1.58
<i>Tomopteris</i> spp.	200
<i>Hyperiid</i> spp.	123
Chaetognaths	24

Fransz and Gieskes (1984) provide a value of production of 5-10 gC·m<sup>-2</sup>·year<sup>-1</sup> (50 to 100 g wet wt·m<sup>-2</sup>·year<sup>-1</sup>) in the central part of the Southern bight.

The near coastal mixed areas have somewhat higher production, and the species composition may vary to some extent, *Acartia tonsa* being more significant in the western coastal areas and *Oithona similis* in the northern stratified areas, but small size neritic species dominate and produce 5-20 gC·m<sup>-2</sup>·year<sup>-1</sup>. In the northern North Sea, *Calanus finmarchicus* dominates the production and was studied during FLEX. Williams and Lindley (1980b) arrived at production of 14.5-27.8 g·m<sup>-2</sup> in May (0.5-0.9 gC·m<sup>-2</sup>·d<sup>-1</sup>). Fransz and van Arkel (1980) and Fransz (1980) estimated a daily production of 0.02-0.050 gC·m<sup>-2</sup>·d<sup>-1</sup> (0.2-0.5 g wet wt·m<sup>-2</sup>·d<sup>-1</sup>) during the peak of the phytoplankton biomass (end of April), when the population biomass was about 0.4 gC·m<sup>-2</sup>. In May the food level decreased but the *Calanus* biomass increased to 4 gC·m<sup>-2</sup> at

the end of the month (equivalent to 40 g wet wt·m<sup>-2</sup>).

Note: Kiørboe and Johansen (1986, p. 42) used the specific rate of egg production as a measure for the daily P/B determined.

Based on the above accounts and estimates, the following production and biomass values were applied in the model. Annual production of 75 g wet wt·m<sup>-2</sup>·year<sup>-1</sup> (35-100 g wet wt·m<sup>-2</sup>·year<sup>-1</sup>, from Evans (1977) and Fransz and Geiskes (1984). P/B ratio of 9.2 (Fransz *et al.*, 1991b; Table 2.11). Annual average biomass (standing stock) 8.22 g wet wt·m<sup>-2</sup> calculated from P and P/B. Summer maximum standing stock ranges from 40 (Fransz, 1980) to 135 g wet wt·m<sup>-2</sup> (calculations based on Krause and Trahms, 1983; and Broekhuizen *et al.*, 1995).

*Calanus* has a high metabolic rate and daily food intake may be as much as 390% body weight according to Cushing and Vucetic (1963). This is a huge consumption rate (e.g., 262.08 µg C, for a biomass of 67.2 µg C). Assuming that *Calanus* realises an actual food intake of only half this and feeds for 3 months in the year, results in an annual Q/B of 180. This estimate is 3 times that used in the 1980s model based on data from Crisp (1975).

Copepods are the most important phytoplankton consumers but are also important in processing detritus as can be noted from the significance of detritus in the diets of several species. *Calanus finmarchicus* stands for filter feeder, which feeds mainly of phytoplankton (Marshall and Orr, 1966) but others believe it is capable of taking other (dead) material as well. It is armed with siliceous teeth which presumably allow it to break

diatomaceous shells. The majority of its food is phytoplankton. *Microcalanus* is less dependent of phytoplankton food than other species. It mainly consumes detritus and is not dependent on living phytoplankton. *Pseudocalanus elongatus* is able to feed on living as well as non-living particles (Poulet, 1973, 1974, 1976). The amount of non-living carbon constituted the major part of the food ingested irrespective of the season. Cowey and Corner (1963) showed that detritus has an amino acid composition very similar to that of zooplankton, so it might be a suitable food. Checkley (1980) stated that phytoplankton and particulate matter are used by *Paracalanus paracalanus*, but phytoplankton food is used for the production of eggs. Marshall and Orr (1966) found that *Oithona similis* could eat only fairly large phytoplankton and very little of them. The small copepod feeds predominantly carnivorously. Pepita *et al.* (1970) characterised it as a mixed food consumer. Several authors noticed *Acartia clausi* feeding on phytoplankton (Anraku, 1964; Marshall and Orr, 1966). Adult stages of the copepods are mixed food consumers (Pepita *et al.*, 1970; Gaudy, 1974). *Centropages typicus* fed almost equally well on animal and vegetable diets. *Temora stylifera* displayed a remarkable ability for predation.

### **Euphausiids**

During March/April in the Fladen ground, Williams and Lindley (1980a) recorded large stocks of euphausiids representing more than 90% of the entire zooplankton biomass at that time. With the onset of thermal stratification and the phytoplankton spring bloom, the biomass of copepods increased, reaching as much as 80-90% of zooplankton biomass by May (Fransz *et al.*, 1991b).

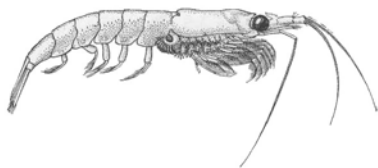

*Nictiphanes*, Schizopoda, Euphausiacea (from Fowler, 1912).

Lindley (1980) gave estimates of production and biomass of two (out of three) dominant species of Euphausiacea, *Thysanoessa inermis* and *T. raschi*, in the NE North Sea and NW Skagerrak in 1966 and 1967. Assuming a carbon/wet weight conversion factor of 10, a mean depth of the Northern North Sea of 100 m, that euphausiids occur in half of the North Sea, and that the third dominant species, *Meganctiphanes norvegica*,

adds 50% to the biomass, a biomass of  $1.8 \text{ g}\cdot\text{m}^{-2}$  could be estimated (Christensen, 1995).

Lindley (1980, 1982) estimated annual production can be up to  $10 \text{ mgC}\cdot\text{m}^{-3}$ . Based on this information a production/biomass ratio of  $2.43 \text{ year}^{-1}$  can be estimated (Christensen, 1995). Q/B is estimated in Ecopath, assuming that  $\text{EE}=0.95$ .

A slightly modified version of the diet of euphausiids used in the 1980s model was used.

### **Lobsters and edible crabs**

Lobsters are found mainly in the coastal fringe on or near rocky bottom beyond the low water mark. Crabs are found outside the coastal fringe on sand or shingle with occasional patches of rock. They are caught in creels of varying types by fishers working in boats ranging from rowing boats to vessels of 55 feet and from working from beaches, piers and harbours depending on local conditions. Main markets were Billingsgate and a number of English midland towns (Thomas, 1958).

Compiling the catch statistics for the various countries between 1886-1890 provides an average annual catch of crabs and lobsters of 4,012 t. Based on an assumed exploitation rate of 10%, the total biomass of crabs and lobsters is estimated as 40,123 t.

Catch data for crabs and lobsters is derived from a variety of sources. Garstang (1901) details catches from England and Wales (whose catch is not from the North Sea). Most of lobsters are caught on the south coast, also not the North Sea. 17% of all crabs were caught on South coast. 65% of all English and Welsh lobsters were caught on South coast. Catches for the South coast are omitted in the model, but it was not possible to remove that from Wales. Although this represents a source for overestimating the catch, it is likely balanced by the unaccounted shore-based personal consumption harvest by locals. For conversion to weight, average weights for crab and lobster were assumed to be 1 kg and 1.5 kg respectively.

Gartsang (1901, p. 268) details the English and Welsh boats (of various classes – class 3 being smallest coastal boats) engaged in crab and lobster fishing (Table 2.14).

**Table 2.14.** Boat class data for the crab and lobster fishery (after Garstang, 1901).

	1st class	2nd class	3rd class
1892	14	206	299
1899	10	209	349

Thomas (1958) provides the annual catch of lobsters in Scotland for the years 1892-1924 quoted from the report on lobsters of the Interdepartmental committee on lobsters and crabs (Anon., 1926). Some similar data in respect to crabs are published in the report on crabs made by the same committee (Anon., 1930). Hoek and Kyle (1905) provide data on Norwegian lobsters fisheries from 1876 and German and Danish lobster fisheries from around 1890.

Compiling the catch statistics for the various countries between 1886-1890 (Figure 2.4)

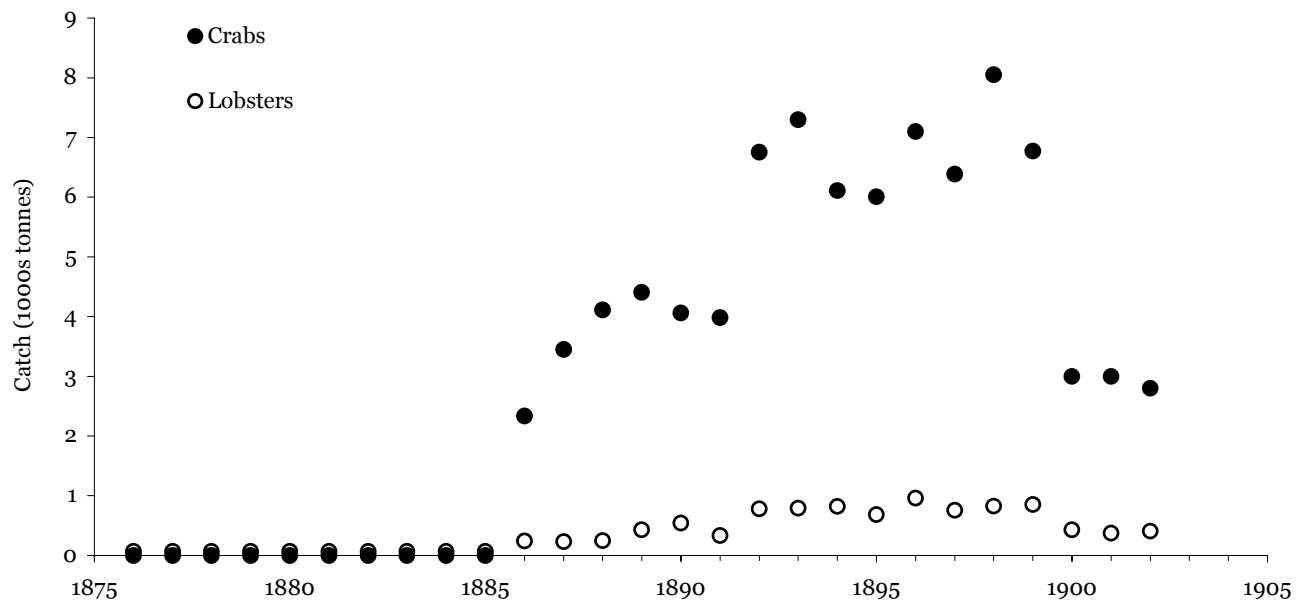
**Figure 2.4.** Catches of crabs and lobsters in the North Sea 1875-1902.

#### **Other crustaceans (shrimps and swarming crustaceans, etc)**

Very limited information was available for these groups. For both, a production/biomass ratio of 3 year<sup>-1</sup>, a gross food conversion efficiency of 15%, and ecotrophic efficiency of 0.95 were assumed. The diet compositions are taken from the 1980s model.

provides and average annual catch of crabs and lobsters of 4,012 t. This value was applied in the model.

No information was found on the production or consumption of lobsters and crabs in the North Sea. In lieu of this, information on the Dungeness crab (*Cancer magister*) given by Guénette (1996) was used to derive parameters for the model. Mortality rates for Dungeness crabs are reported as 2.5 year<sup>-1</sup> (Smith and Jamieson, 1991 in Guénette, 1996), this value was used as a surrogate for the P/B of crabs and lobsters. A gross efficiency (P/Q) 0.15 was assumed based on Christensen (1995) and ecotrophic efficiency was assumed to be 0.95.

5% cannibalism was assumed for crabs and lobsters. The remainder of the diet consists of macrobenthic organisms.

#### **Macrobenthos (echinoderms, polychaetes, other macrobenthos)**



Brittle star (from Fowler, 1912).

This category includes the bulk of the weight of the standing stock of infauna. It consists in the North Sea mainly of polychaetes, bivalve molluscs, echinoderms, and small crustaceans. These organisms clearly make up an important part of than diet of main demersal fish (McIntyre, 1978).

Summaries of estimates for production and biomass of North Sea macrobenthos are derived from McIntyre (1978) and Duineveld *et al.* (1991). Duineveld *et al.* (1991) give estimates of biomass and production by regions. Applying a conversion for wet weight to ash free dry weight 15:1 (Christensen, 1995, p. 26), the total North Sea biomass is calculated according to each data source (Table 2.15.).

Coull (1972) notes that in general, figures in the open sea of continental shelves for benthos biomass are generally in the region 50-100 g·m<sup>-2</sup>, but much higher estimates can occur locally. For example, the overall community biomass (comprising, lamellibranches, gastropods, polychaetes and crustaceans) in 4 community zones of the German Wadden Sea was 1,570 g wet wt·m<sup>-2</sup> (Duineveld *et al.*, 1991).

McIntyre (1978) provides more detail with respect to the various groups. The information presented in Table 2.16 summarises regional and depth stratified data, for various ecoregions. A conversion of 1 g dry weight=5 g wet wt was applied to the data.

**Table 2.15.** Key parameter estimates for all macrobenthos (from Duineveld *et al.*, 1991).

Biomass (g wet weight·m <sup>-2</sup> )	Production (g wet weight·m <sup>-2</sup> )	P/B (year <sup>-1</sup> )	Data source
48	90.0	1.9	Rachor (1982)
79.5	151.5	1.91	ICES North Sea benthos survey May 1986.
79.5	151.5	1.9	Wilde <i>et al.</i> (1986)
101.175	-	-	McIntyre (1978)

**Table 2.16.** Distribution of macrobenthos biomass between ecoregions (after McIntyre, 1978).

Group	Average Biomass (g wt wt·m <sup>-2</sup> )				
	Coastal	Subtidal	Intertidal	Open sea	Total
Echinoderms	8.77	6.33		0.35	15.44
Polychaetes	7.1	7	5.3	18.7	38.05
Crustaceans	3.97	14.48	1.2	1.4	21.05
Molluscs	4.12	10.19	0.4	5.2	19.86
Foraminiferans	-	-	-	4.15	4.15
Other	-	-	0.3	2.3	2.63

Total biomass of ‘Other macrobenthos’ comprising of crustacea, molluscs, and others is 43.53 g wet wt·m<sup>-2</sup>. These estimates of biomass are applied in the model.

Specific data from 20 inshore stations in Aberdeen (McIntyre, 1958; Table 2.17) yields similar estimates as the subtidal zone. McIntyre (1958) noted that at these stations that molluscs dominated the bottom fauna on the east coast of Scotland. Twenty eight species were found, the average number of individuals being 130 per 0.2 m<sup>2</sup>, with a corresponding dry weight of 0.674 g. Just over half of this dry weight was composed of *Tellina fabula* (33%) and *Nucula turgida* (17%). These two species, although present at every station, had marked numerical differences in their distribution.

**Table 2.17.** Mean biomass of macrobenthos at inshore stations off Aberdeen (after McIntyre, 1958).

Group	Biomass (g wet wt·m <sup>-2</sup> )
Mollusca	16.7
Polychaeta	8.3
Echinodermata	7.5
Other groups	3.4
Total	35.8

Estimates from other areas were also comparable. St. Andrews: 4.69 g dry wt·m<sup>-2</sup> (23.45 g wet wt·m<sup>-2</sup>); Smith Bank: 3.37 g dry wt·m<sup>-2</sup> (16.85 g wet wt·m<sup>-2</sup>). As Q/B is unknown, a gross conversion efficiency of 15% is assumed, leaving Q/B to be estimated in the model.

## Meiobenthos

Meiobenthos comprises the smaller metazoans, with some larger protozoa often included (foraminifera and ciliata) Meiobenthic organisms are present often in densities of millions of organisms per m<sup>2</sup>, but may contribute only a few tenths of a gram dry weight. Table 2.18 provides a summary of the number in each type of sediment, together with an estimate of biomass.

*“Nematodes and copepods are overwhelming the dominant animals, with turbellaria and Gastrotricha usually well represented. The turnover per unit weight of meiobenthos may be an order of magnitude higher than that of some macrobenthos, so that in energetic terms the meiofauna may be more important than its dry weight would suggest. In the context of the food web however, although younger fish feed for a time on benthic copepods and Crangon take in and apparently digest nematodes, it has yet to be demonstrated the direct importance of*

*meiofauna as fish food is anything but minimal”.*

McIntyre (1978).

An alternative estimate of meiofaunal biomass can be determined from other data presented by McIntyre, (1978; Table 2.19). Assuming the average weight of meiofaunal organism to be that of a small copepod (1.01 µgC Broekhuizen *et al.*, 1995) and applying a conversion of 1 gC =10 g wet wt, the number per unit area were worked up to per square meter, averaged over regions and summed giving a total meiofaunal biomass of 42.42 g wet wt·m<sup>-2</sup>.

In the model a biomass value of 34 g wet wt·m<sup>-2</sup> (in between the two estimates was applied). Based on the comment of McIntyre (1978) that turnover per unit weight may be an order of magnitude higher than that of some macrobenthos, P/B ratio was set to 19 year<sup>-1</sup>, ten times that of the macrobenthos. Gross efficiency was assumed to be 15% and Q/B and was estimated in Ecopath.

**Table 2.18.** Numbers and estimated dry weight of total meiofauna from typical habitats (after McIntyre, 1978). Applying a dry weight to wet weight conversion factor of 1g dry weight = 5 g wet weight.

Habitat		Numbers per m <sup>2</sup>	Dry weight (g·m <sup>-2</sup> )	Wet weight (g·m <sup>-2</sup> )
Intertidal	sand	2-58 ·10 <sup>5</sup>	up to 1.7 g	8.5
Intertidal	mud	4-118·10 <sup>5</sup>	up to 11.2 g	56
Subtidal	sand	1-26·10 <sup>5</sup>	up to 7.1 g	35.5
Shelf	mud	1-20·10 <sup>5</sup>	up to 1.1 g	5.5
Average	-	-	-	26.35

**Table 2.19.** Numbers of meiofauna per 10 cm<sup>2</sup> at intertidal sandy locations, with data on English Channel for comparison (after McIntyre, 1978).

	Firth of Forth Seaton Sands	Firth of Forth Seafield Sands	Yorkshire Filey Bay	Thames Estuary	English Channel
Nematodes	3,242	4,335	819	2,926	198
Copepods	60	2	20	152	170
Turbellarians	860	77	42	-	8
Gastrotrichs	332	7,450	18	-	10
Others	23	0	52	197	7

## Microflora – benthic and planktonic (bacteria, fungi, protozoans etc)

Dealing with the role of heterotrophic bacteria in the ecological functioning of the North Sea involves understanding how the primary produced organic matter is partitioned between three concurrent pathways (i) direct grazing by zooplankters, (ii) uptake of dissolved organic matter by planktonic bacteria and incorporation

into the microbial loop, involving both direct mineralization and bacterial biomass production; (iii) sedimentation of particulate matter and its incorporation into the benthic food chains (Fransz *et al.*, 1991a). By keeping ‘detritus’ as two distinct groups, dissolved organic matter and particulate organic matter, the latter two pathways are represented in the model by allowing planktonic and benthic microflora to consume the dissolved and particulate organic

matter. In turn, the planktonic microflora (together with phytoplankton) are preyed upon by zooplankton, whilst the benthic microflora are grazed predominantly by meiofauna and macrofauna.

### ***Microflora production and biomass***

The value of carbon content per unit bacterial biovolume has been the subject of much controversy. Most authors have used values  $0.9\text{--}1.65 \cdot 10^{-7} \mu\text{gC}\cdot\mu\text{m}^{-3}$  (see Billen *et al.*, 1990). But Lee and Fuhrman (1987) reported values as high as  $5.6 \cdot 10^{-7} \mu\text{gC}\cdot\mu\text{m}^{-3}$ . The average biomass of phytoplankton bacteria in the continental coastal zone is about  $20 \mu\text{gC}\cdot\text{l}^{-1}$ , which is equivalent to about  $0.3 \text{ gC}\cdot\text{m}^{-2}$ . Planktonic bacterial production can be evaluated to about  $20 \text{ gC}\cdot\text{m}^{-2}\cdot\text{year}^{-1}$ . (p. 286). The estimated flux of  $110 \text{ gC}\cdot\text{m}^{-2}\cdot\text{year}^{-1}$  flowing through the bacterioplankton compartment in the continental coastal zone is in good agreement with the above estimation of  $20 \text{ gC}\cdot\text{m}^{-2}\cdot\text{year}^{-1}$  for bacterial production in the areas, as it implies a mean growth yield of 0.18, quite a reasonable figure when compared with experimental data.

Although still crude at the present stage, these estimations indicate that a significant part of net primary production (about 57%) channels through the bacterioplankton compartment. Of this, a proportion is made again available for zooplankton grazing in the form of microflagellate biomass. If considering a mean growth efficiency of 0.3 (=gross efficiency) for nanozooplankton (Fenchel, 1982), this part should however, only represent  $6 \text{ gC}\cdot\text{m}^{-2}\cdot\text{year}^{-1}$  of the total flux of organic matter flowing through bacteria. The remaining part should be mineralised either by bacteria or by heterotrophic flagellates.

In the Central North Sea, phytoplankton growth amounts to  $45 \text{ gC}\cdot\text{m}^{-2}$  (March-June) and excretion of low molecular weight components to  $6 \text{ gC}\cdot\text{m}^{-2}$ . Annual figures are probably at least twice higher in view of the fact that the autumn bloom occurs also. The Celtic Sea is the only comparable area to the North Sea where bacterial biomass information are available (Joint and Pomroy, 1987). The data indicate a mean biomass of  $2.5 \mu\text{g}\cdot\text{l}^{-1}$  and bacterial production of  $2.2 \text{ gC}\cdot\text{m}^{-2}\cdot\text{year}^{-1}$ . Assuming the same growth yield as in the coastal zone, the flux through the bacterial compartment would amount to  $12 \text{ gC}\cdot\text{m}^{-2}\cdot\text{year}^{-1}$ . This would imply that phytoplankton excretion (about  $10 \text{ gC}\cdot\text{m}^{-2}\cdot\text{year}^{-1}$ ) supplies most of the organic matter used by plankton bacteria. The data on organic matter sedimentation indicate a

much lower flux than the continental zone, apparently about  $10 \text{ gC}\cdot\text{m}^{-2}\cdot\text{year}^{-1}$ .

Much less reliable data are available for bacterial activity in the benthos. The data on organic sedimentation indicate a flux of about  $20\text{--}100 \text{ gC}\cdot\text{m}^{-2}\cdot\text{year}^{-1}$  with large geographical variation. The overall carbon metabolism in the benthos can be estimated at about  $50\text{--}100 \text{ gC}\cdot\text{m}^{-2}\cdot\text{year}^{-1}$  (Billen *et al.*, 1990). In shallow water benthic microalgae may contribute a significant part of the primary production, as for example on the tidal flats of the Wadden Sea where microflora annual production of more than  $100 \text{ gC}\cdot\text{m}^{-2}$  has been measured (Cadée and Hegeman, 1974). Also, some protozoa such as ciliata may be numerous as scavengers and predators. Bacteria, which are well known to play a critical part in the recycling of nutrients, have been studied in the German Bight where the maximum wet weight biomass in the upper 2 mm of the sediment was calculated as  $48 \text{ mg}\cdot\text{m}^{-2}$  (Hickel and Gunkel, 1968).

*“The microbenthos form an essential link in the food chain. They are ingested and to some extent utilized by those larger organisms that take in sediment and detritus while some microbenthic individuals such as algae and larger protozoa are selectively preyed upon. However, the microbenthos can hardly be said to constitute an important direct food for fish in general”.*

McIntyre (1978).

The data reveal the prominent importance of planktonic bacterial activity in the continental zone, where it consumes nearly 60% of the net primary production (Billen *et al.* 1990). Although at present no actual figures can be given for the Central North Sea, planktonic bacteria probably use a much lower percentage of primary production there. Data are lacking for distinguishing benthic bacterial activity from that of the meio-fauna. Together, however, the activities of both groups of benthic organisms consume a flux of organic material representing about 25-50% of net primary production in the continental coastal zone. Again, the corresponding figure for the Central North Sea, although uncertain, must be much lower. Bacterial activity therefore appears to play the dominant role in organic matter cycling of the continental coastal zone, while its relative importance is somewhat lower in the Central North Sea, where a larger part of primary production is probably consumed by zooplankton grazing. Based on this, the parameters in Table 2.20 were calculated and are applied in the model.



**Table 2.20.** Estimates of microflora biomass and production (all with GE = 0.3).

	<b>Production (g·m<sup>-2</sup> · year<sup>-1</sup>)</b>	<b>Biomass (g·m<sup>-2</sup>)</b>	<b>P/B (year<sup>-1</sup>)</b>	<b>Location</b>	<b>Reference</b>
Benthic bacteria/ microflora	750	0.048	15625	German bight	McIntyre (1978) and Billen <i>et al.</i> (1990)
Coastal bacterioplankton	200	3	67	Coastal N. Sea	Billen <i>et al.</i> (1990)
Central North Sea bacterioplankton	22	0.0375	587	Celtic Sea	Billen <i>et al.</i> (1990)
Average bacterioplankton (planktonic microflora)	222	3.04	653	-	-

### ***Phytoplankton (diatoms and other autotrophs)***

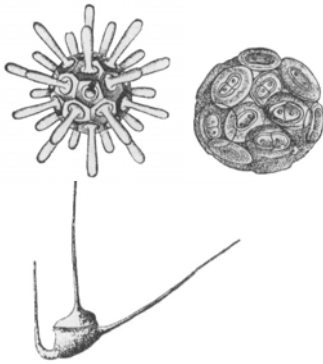

(from Fowler, 1912).

Based on a critical examination of the primary production figures published in the literature and their discussion in the light of the physiological model of phytoplankton growth in Lancelot *et al.* (1988), Reid *et al.* (1990) evaluated the annual net particulate primary production (i.e., phytoplankton growth) to 170 gC·m<sup>-2</sup>·year<sup>-1</sup> in the continental coastal zone. Extra cellular release of low molecular weight organic compounds by phytoplankton amounts to 20 gC·m<sup>-2</sup>·year<sup>-1</sup>. In the Central North Sea, phytoplankton growth amounts to 45 gC·m<sup>-2</sup> (March-June) and excretion of low molecular weight components to 6 gC·m<sup>-2</sup>. Total production (av. March-June) from the coastal zone and Central North Sea amounts to 2,150 g wet wt·m<sup>-2</sup>·year<sup>-1</sup>. This value was used in the model.

Krause and Trahms (1983) report a maximum phytoplankton biomass during the Fladen ground experiment (FLEX) March-June 1976, of over 4000 mgC·m<sup>-2</sup>, with average phytoplankton standing stock March-June being approx 750 mgC·m<sup>-2</sup>, or 7.5 g wet wt·m<sup>-2</sup>. This value was used in the model.

### ***Detritus (DOM and POM)***

'Detritus' was partitioned in to two separate boxes to account for the use of dissolved organic matter and particulate organic matter by microflora via planktonic and benthic pathways. Flows to the groups consists of excreted and unassimilated food, dead organisms, etc. Flows out of the DOM and POM boxes is limited to detritus uptake by consumers and export. The same biomass used in the 1980s model was applied in the POM and DOM boxes in the 1880 model; the amount of dead organic material, i.e. detritus 'biomass,' of 4.3 gC·m<sup>-2</sup> (50 g wet wt·m<sup>-2</sup>) reported by Hannon and Joires (1989) for the Southern North Sea.





**Table 2.21 cont.** Diet matrix used in the balanced 1880s North Sea model.

<b>Prey \ Predator</b>	<b>31</b>	<b>32</b>	<b>33</b>	<b>34</b>	<b>35</b>	<b>36</b>	<b>37</b>	<b>38</b>	<b>39</b>	<b>40</b>	<b>41</b>	<b>42</b>	<b>43</b>
1 Cetaceans													
2 Seals													
3 Seabirds													
4 Sharks													
5 Juv. sharks	0.010												
6 Rays and skates													
7 Juv. rays and skates	0.020												
8 Bluefin tuna													
9 Sturgeon													
10 Cod	0.010												
11 Juv. cod	0.040		0.010										
12 Whiting													
13 Juv. whiting	0.020		0.010										
14 Saithe	0.002												
15 Juv. saithe	0.019		0.010										
16 N.Sea mackerel													
17 W. mackerel													
18 Haddock	0.010												
19 Juv. haddock	0.020		0.010										
20 Herring	0.020		0.010										
21 Sprat	0.020		0.010										
22 Norway pout	0.020		0.010										
23 Sandeel	0.020		0.010										
24 Plaice	0.060		0.010										
25 Sole	0.020		0.010										
26 Brill	0.035		0.010										
27 Halibut and turbot	0.030												
28 Horse mackerel	0.024		0.010										
29 Salmon and seatrout													
30 Gurnards	0.020												
31 Other predatory fish													
32 Other prey fish	0.050		0.010			0.100							
33 Cephalopods	0.020												
34 Zooplankton			0.400		0.550		0.050						
35 Euphausiids			0.400										
36 Edible crabs and lobsters						0.050							
37 Other crustaceans	0.140	0.417	0.060		0.050	0.150	0.100						
38 Echinoderms	0.100	0.205				0.200		0.050		0.050			
39 Polychaetes	0.100	0.157	0.010			0.100	0.020	0.150		0.100	0.001		
40 Other macrobenthos	0.170	0.221				0.200		0.400		0.100	0.001		
41 Meiofauna					0.050	0.050	0.200	0.200	0.400	0.250			
42 Benthic microflora						0.050	0.080	0.050		0.100	0.250		
43 Planktonic microflora				0.200	0.100		0.050			0.100	0.150		0.050
44 Phytoplankton				0.750	0.100		0.050						0.200
45 DOM				0.010	0.050		0.050				0.200	0.400	0.750
46 POM				0.040	0.100	0.100	0.400	0.150	0.600	0.300	0.400	0.600	

## REFERENCES

- Aasen, O. 1963. Length and growth of the porbeagle (*Lamna nasus*) in the north west Atlantic, Fis. Dir. Skr. (Ser. Havunders), 13 (6): 20-37.
- Alward, G. L. 1932. The Sea Fisheries of Great Britain and Ireland. Albert Gait, Grimsby.
- Anderson, S. 1990. Seals. Whittet books Ltd, London. 126 pp.
- Anon. 1921. The history of trawling. Fish Trades Gazette (London), March 19th: 21-71.
- Anon. 1926. Report on Lobsters. Interdepartmental Committee on Crabs and Lobsters. London. H. M. S. O. 34 pp.
- Anon. 1930. Report on Crabs. Interdepartmental Committee on Crabs and Lobsters. London. H. M. S. O. 94 pp.
- Anon. 1989. Report of the multispecies assessment working group. ICES CM 1989/Assess: 7. 246 pp.
- Anon. 1997. Report of the working group on elasmobranchs. ICES Demersal Fish Committee. CM 1997/G: 2. 123 pp.
- Anon. 1999a. ICES activities in 1998/1999. ICES CM 1999/Gen: 2. 6 pp.
- Anon. 1999b. Study group on elasmobranch fishes (SGEF). ICES CM 1999/G: 11. 18 pp.
- Anon. 1999c. Working group on marine mammal population dynamics and trophic interactions (WGMMPD). ICES CM 1999/G: 3. 26 pp.
- Anon. 1999d. Working group on the assessment of mackerel, horse mackerel, sardine and anchovy (WGMHSA). ICES CM 1999/ACFM: 6. 468 pp.
- Anraku, M. 1964. Influence of the Cape Cod Canal on the hydrography and on the copepods in Buzzards Bay and Cape Cod Bay, Mass II. Resp Feed. Limnological Oceanography, 9: 195-206.
- Baden, S. P. 1986. Recent changes in the Kattegat and Skagerrak ecosystem and their possible interdependence. - Nat. Swedish Envir. Prot. Bd. Rep. 3157. 91 pp.
- Beaujon, A. 1884. The history of Dutch sea fisheries; their progress and revival especially in connection with the legislation on fisheries in earlier and later times. International Fisheries Exhibition, Prize Essays, II.
- Bertram, 1865. Harvest of the Sea. John Murray, London. 519 pp.
- Beverton, R. J. H., and Holt, S. J. 1957. On the dynamics of exploited fish populations. Fishery Investigations. Ministry of Agriculture Fisheries and Food. London. Series 2 (19). 533 pp.
- Billen, G., Joiris, C., Meyer-Reil, L., and Lindeboom, H. 1990. Role of bacteria in the North Sea ecosystem. Netherland Journal of Sea Research, 26 (2-4): 265-293.
- Broekhuizen, N., Heath, M. R., Hay, S. J., and Gurney, W. S. C. 1995. Modelling the dynamics of the North Sea's Mesozooplankton. Netherland Journal of Sea Research, 33 (3/4): 381-406.
- Buckland, F. 1878. Appendix no. II: Notes on the natural history of the herring. pp 163-188. In Buckland, F., Walpole, S., and Young, A. 1878. Report in the Herring Fisheries of Scotland. Great Britain Sessional Papers.
- Buckland, F., Walpole, S., and Young, A. 1878. Reports on the Herring Fisheries of Scotland. H. M. S. O., London., pp. i-xxxvi, 8-154.
- Butcher, D. 1975. The Driftermen. Tops'l books, Reading, England. 152 pp.
- Cadée, G. S., and Hegeman, J. 1974. Primary production of the benthic microflora living on tidal flats in the Dutch Waddensea. Netherlands Journal of Sea Research, 8 (2-3): 260-291.
- Checkley, D. M. Jr. 1980. The egg production of marine plankton copepod in relation to its food: Laboratory studies. Limnological Oceanography, 25: 430-446.
- Christensen, V., Walters, C., and Pauly, D. 2000. Ecopath with Ecosim: a users guide. October 2000 edition. Fisheries Centre, University of British Columbia, Vancouver, Canada and ICLARM, Penang, Malaysia. 130 pp.
- Christensen, V. 1995. A model of trophic interactions in the North Sea in 1981, the year of the Stomach. Dana, 11 (1): 1-28.
- Christensen, V. 1996. Balancing the Alaska Gyre model. pp. 32-36. In: Mass balance models of North-eastern Pacific ecosystems. Ed. by D. Pauly and V. Christensen. Fisheries Centre Research Report 4(1).
- Christensen, V., and D. Pauly. 1992. ECOPATH II - a software for balancing steady-state models and calculating network characteristics. Ecological Modelling, 61: 169-185.
- Coull, J. R. 1972. The Fisheries of Europe. An Economic Geography. G.Bell and Sons Ltd., London. 240 pp.
- Coull, K. A., Jermyn, A. S., Newton, A. W., Henderson, G. I., and Hall, W. B. 1989. Length/weight relationships for 88 species of fish encountered in the North Atlantic. Scottish Fisheries Research Reports, 43: 80 pp.
- Cowey, C. B. and Corner, E. D. S. 1961. On the nutrition and metabolism of zooplankton. II. The relationship between the marine copepod *Calanus helgolandicus* and particulate materials in Plymouth seawater in terms of amino acids composition. Journal of the Marine Biological Association UK, 43: 495-511.
- Creutzberg, F., and Duineveld, G. C. A. 1986. The role of the lesser weaver *Trachinus vipera* and the dab *Limanda limanda* in the benthic system of the Southern North Sea. ICES CM 1986/L: 4. 10 pp.
- Crisp, D. J. 1975. Secondary productivity in the sea. - Productivity of world ecosystems, pp. 71-89. National Academy of Sciences, Washington, DC.
- Cushing, D. H. and Vucetic, T. 1963. Studies on a *Calanus* patch. III. The quantity of food eaten by *Calanus finmarchicus*. Journal of the Marine Biological Association UK, 43: 349-371.
- Cushing, D. H. 1988. The Provident Sea. Cambridge University Press, Cambridge. 329 pp.
- Daan, N. 1978. Changes in cod stocks and cod fisheries in the North Sea. Rapports et Procès-Verbaux des Réunions du Conseil International pour l'Exploration de la Mer, 172: 39-57.
- Dambeck, C. 1876. Statistics of the most important fisheries of the North Atlantic. In Historical observations on the conditions of the fisheries among the ancient greeks and Romans and on their mode of salting and pickling fish, pp. 22-24. Ed. by J. K. Smidth. Rep. Comm. US Comm. Fish and Fisheries for 1873-4 and 1874-6, Part III, Appendix 3, pp. 3-20.
- de Caux, J. W. 1881. The Herring and the Herring Fishery. Hamilton, Adams and Co., London. 159 pp.
- Dorel, D., 1985. Poissons de l'Atlantique Nord-est : Relations Taille-Poids. Institut Français de Recherche pour l'Exploitation de la Mer.
- Duineveld, G. C. A., Kunitzer, A., Niermann, U., de Wilde, P. A. W. J., and Gray, J. S. 1991. The macrobenthos of the North Sea. Netherlands Journal of Sea Research, 28 (1/2): 53-65.
- Dyson, J. 1977. Business in Great Waters. Angus and Robertson, London and Sydney. Eggeling, W. J. 1957. The mammals of the Isle of May. Scottish Naturalist, 69: 71-4.
- Evans, F. 1977. Season density and production estimates of the commoner planktonic copepods of Northumberland coastal waters. Estuarine and Coastal Marine Science 5: 233-241.
- Evans, H. D., and Buckley, T. E. 1899. A Vertebrate Fauna of the Shetland Isles. Edinburgh, 248 pp.
- Fasham, M. J. R. 1984. Flows of energy and materials in marine ecosystems. Theory and practice. (NATO conference series IV). Marine Sciences, Vol. 13. Plenum, New York: 1-733.
- Fenchel, T. 1982. Ecology of heterotrophic microflagellates, 2. Bioenergetics and growth. Marine Ecology Progress Series. 8: 228-231.
- Fowler, H. 1912. Science of the Sea. John Murray, London. 453 pp.
- Franz, H. G. 1980. Computation of secondary production of *Calanus finmarchicus* using multiple regression method.

- Proc. Final ICES/JONIS workshop on JONSDAP '76. ICES CM 1980/C: 3: 99-108.
- Fransz, H. G., and van Arkel, W. G. 1980. Zooplankton activity during and after the phytoplankton spring bloom at the central station in the FLEX box, northern North Sea, with special reference to the calanoid copepod *Calanus finmarchicus* (Gunn). 'Meteor' Forsch. Ergebnisse A 22: 113-121.
- Fransz, H. G., and Gieskes, W. W. C. 1984. The unbalance of phytoplankton and copepods in the North Sea. Rapports et Procès-Verbaux des Réunions du Conseil International pour l'Exploration de la Mer, 183: 218-225.
- Fransz, H. G., Miquel, J. C., and Gonzalez, S. R. 1984. Mesozooplankton composition, biomass and vertical distribution, and copepod production in the stratified Central North Sea. Netherlands Journal of Sea Research, 18: 218-225.
- Fransz, H. G., Mommaerts, J. P., and Radach, G. 1991a. Ecological modelling of the North Sea. Netherlands Journal of Sea Research, 28 (1/2): 67-140.
- Fransz, H. G., Colebrook, J. M., Gamble, J. C., and Krause, M. 1991b. The zooplankton of the North Sea. Netherlands Journal of Sea Research, 28 (1/2): 1-52.
- Fulton, T. W. 1892. On overfishing and the culture of sea fish. 10th Annual Report of the Fishery Board Scotland, pp. 171-193.
- Fulton, T. W. 1897. The currents of the North Sea and their relation to the fisheries. Reports Fishery Board Scotland, 1896 (3): 334-395.
- Fulton, T. W. 1908. A review of the fishery statistics for Scotland. 27th Annual Report Fishery Board Scotland, pp. 129-191.
- Garstang, W. 1901. The plague of *Octopus* on the south coast, and its effect on crab and lobster fisheries. Journal of the Marine Biology Association UK, 6 (2): 260-273.
- Garstang, W. 1903a. The impoverishment of the Sea. Journal of Marine Biological Association UK, 6: 1-69.
- Garstang, W. 1903b. Report on the trawling and other investigations carried out in the bays on the south-east coast of Devon during 1901-1902. Journal of the Marine Biological Association UK, 6: 435-527.
- Garstang, W. 1905. Report on the trawling investigations, 1902-3, with especial reference to the distribution of plaice. First Report on fishery and hydrographic investigations in the North Sea and adjacent waters (southern area), International Fisheries Investigations, Marine Biological Association UK, 67-198.
- Gaudy, R. 1974. Feeding in four species of pelagic copepods under experimental conditions. Marine Biology, 25: 125-141.
- Gokhale, S. V. 1953. Bionomics of the Norway pout *Gadus esmarkii*. Nilsson (Holt and Calderwood, 1895) in the Irish sea. University of Liverpool, Ph. D. Thesis.
- Goodey, C. 1976. The First Hundred Years: The Story of Richards' Shipbuilders. Boydell, Ipswich.
- Graham, M. 1923. The annual cycle in the life of a mature cod in the North Sea. Fishery Investigations, London Series 2, 6 (6): 1-77.
- Gray, M. 1978. The Fishing Industries of Scotland, 1790-1914. A Study in Regional Adaptation. Oxford University Press. Oxford.
- Green, N. 1918. Fisheries of the North Sea. Methuen & Co. Ltd., London. 178 pp.
- Guénette, S. 1996. Macro-benthos. pp. 65-67. In: Mass balance models of North-eastern Pacific ecosystems. Ed. by D. Pauly and V. Christensen. Fisheries Centre Research Report 4(1).
- Hannon, B., and Joires, C. 1989. A seasonal analysis of the Southern North Sea ecosystem. Ecology, 70: 1916-1934.
- Harmer, S. F. 1927. Report on the cetacea stranded on the British coasts from 1913 to 1926. British Museum of Natural History. no. 10.
- Hatch, S. A., Byrd, G. V., Irons, D. B., and Hunt, G. L. Jr. 1993. Status and ecology of kittiwakes (*Rissa tridactyla* and *R. brevirostris*) in the North Pacific. In The Status, Ecology, and Conservation of Marine Birds of the North Pacific, pp. 140-153. Ed. by K. Vermeer, K. T. Briggs, K. H. Morgan, and D. Siegel-Causey. Canadian Wildlife Service Special Publication, Ottawa.
- Havinga, B. 1933. Der Seehund (*Phoca vitulina*) in den Holländischen Gewässern. Tijdschr. Ned. Dierk. Ver. (Leiden), 3: 79-111.
- Hickel, W., and Gunkel, W. 1968. Untersuchungen über die Häufigkeit der Bakterien in der obersten Sedimentschicht der Deutschen Bucht in Beziehung zu den Substrateigenschaften. Helgoländer wissenschaftliche Meeresuntersuchungen, 18: 213-231.
- Hoek, P. P. C., and Kyle, H. M. 1905. Statistics of the North Sea fisheries, Part I. The fisheries of the various countries. Rapp P.-v. Réun. Cons. Int. Explor. Mer, 3: Appendix J.
- Holdsworth, E. W. H. 1874. Deep sea fishing and fishing boats: An account of the practical working of the various fisheries around the British Isles. Edward Stanford, Charing Cross, S. W., London. 429 pp.
- Holt, E. W. L. 1895. An examination of the present state of the Grimsby trawl fishery, with special reference to the destruction of immature fish. Journal of the Marine Biological Association UK. N.W., 3: 339-448.
- Jennings, S., Reynolds, J. D., and Mills, S. C. 1997. Life history correlates of responses to fisheries exploitation. Proceedings of the Royal Society of London Series B, 265: 333-339.
- Joint, I. R., and Pomroy, A. J. 1987. Activity of heterotrophic bacteria in the euphotic zone of the Celtic Sea. Marine Ecology Progress Series, 41: 155-165.
- Joiris, C., Billen, G., Lancelot, C., Daro, M. H., Mommaerts, J. P., Bertels, A., Bossicart, M., Nijs, J., and Heco, J. H. 1982. A budget of carbon cycling in the Belgian coastal zone: Relative roles of zooplankton and benthos in the utilisation of primary production. Netherlands Journal of Sea Research, 16: 260-275.
- Jones, B. C., and Green, G. H. 1977. Food and feeding of the spiny dogfish (*Squalus acanthias*) in British Columbia waters. Journal of the Fisheries Research Board. Fish (Canada), 34: 2067-2078.
- Jones, R. 1954. The food of the whiting and a comparison with that of the haddock. Marine Research, Edinburgh, H. M. S., 2: 21.
- Jones, R. 1982. Species interactions in the North Sea. In Multispecies Approaches to Fisheries Management Advice, pp. 48-63. Ed. by M. C. Mercer. Canadian Special Publication of Fisheries and Aquatic Science no. 59. 169 pp.
- Jones, R., and Hislop, J. R. G. 1975. Changes in the North Sea haddock and whiting. ICES Symposium on the Changes in the North Sea Fish stocks and their Causes, 25: 32.
- Karpov, K. A., and Cailliet, G. M. 1978. Feeding dynamics of *Loligo opalescens*. In Biological, Oceanographic, and Acoustic aspects of the market squid, *Loligo opalescens*, pp. 45-66. Ed. by C. W. Reckseik and H. W. Frey. California Department of Fish and Game, Fish Bulletin no. 169.
- Kelson, J., Wada, Y., and Speckmann, S. 1996. Seabirds in the Alaskan Gyre. pp. 31-32. In: Mass balance models of North-eastern Pacific ecosystems. Ed. by D. Pauly and V. Christensen. Fisheries Centre Research Report 4(1).
- Ketchen, K. S., 1975. Age and growth of dogfish *Squalus acanthias* in British Columbia waters. Journal of the Fisheries Research Board of Canada, 32: 43-59.
- Keys, M. C. 1968. The nutrition of pinnipeds. In The Behaviour and Physiology of Pinnipeds, pp. 359-395. Ed. by J. Harrison *et al.* Appleton - Century-Crofts, New York.
- Kjørboe, T. and Johansen, K. 1986. Studies of a larval herring (*Clupea harengus*) patch in the Buchan area IV. Zooplankton distribution and productivity in relation to hydrographic features. Dana, 6: 37-51.

- Knust, R. 1990. Food and condition of dab, *Limanda limanda* (L.) from the Dogger Bank and the German Bight. ICES CM 1990/G: 62. 7 pp.
- Krause, M. and Trahms, J. 1983. Zooplankton dynamics during FLEX' 76. In North Sea Dynamics, pp. 632-661. Ed. by J. W. Lenz. Springer-Verlag, Berlin.
- Kyle, H. M. 1905. Statistics of the North Sea Fisheries, Part II. Summary of the available statistics and their value for the solution of the problems of overfishing. Rapports et Procès-Verbaux des Réunions du Conseil International pour l'Exploration de la Mer, 3: Appendix K.
- Kyle, H. M. 1926. The Biology of Fishes. Sidgwick & Jackson Ltd., London. Lamont, J. M. 1964. Plaice investigations in Scottish Waters. Part 1. Size composition of the stocks, 1910-1952. DAFS. Marine Research Edinburgh H. M. S. O., no. 1. 35 pp.
- Lancelot, C., Billen, G. and Mathot, S. 1988. Ecophysiology of the phyto- and bacterioplankton growth in the Prydz Bay area during austral summer 1987. Part I. Modelling phytoplankton growth. In Proceedings of the Belgian National Colloquiums on Antarctic research, October 20, 1987, pp. 116-132. Ed. by Prime Ministers Service - Science Policy Office, Brussels.
- Lee, S. and Fuhrman, J. A. 1987. Relationships between biovolume and biomass of naturally derived bacterioplankton. Applied Environmental Microbiology, 53: 1298-1303.
- Lindley, J. A. 1980. Population dynamics and production of euphausiids. Part II. *Thyanoessa inermis* and *T. raschi* in the North Sea and American coastal waters. Marine Biology, 59: 225-234.
- Lindley, J. A. 1982. Continuous plankton records: Geographical variations in numerical abundance, biomass and production of euphausiids in the North Atlantic Ocean and the North Sea. Marine Biology, 71: 7-10.
- Lundbeck, J. 1963. Biologisch-statistische Untersuchungen über die deutsche Hochseefischerei. IV. 7. (Schluß). Ertrags- u. Bestandveränderungen bei den Nutzfischen. Ber. Dt. Wiss. Kommn. Meeresforsch., 17 (2): 45-118.
- Mackinson, S. 1995. System definition and primary production in the Georgia Strait. pp. 63-64. In: Mass balance models of North-eastern Pacific ecosystems. Ed. by D. Pauly and V. Christensen. Fisheries Centre Research Report 4(1).
- Marshall, S. M., and Orr, A. P. 1966. Respiration and feeding in some small copepods. Journal of the Marine Biological Association UK, 46: 513-530.
- Martens, P. 1980. Contributors to the Mesozooplankton of the northern Wadden Sea of Sylt, German Bight, North Sea. Helgoländer Meeresunters, 34: 41-45.
- Matthews, J. B. L., and Heimdal, B. R. 1980. Pelagic productivity and food chains in fjord systems. NATO Conference series, Series 4. Marine Science, Vol. 4. pp. 377-398.
- McIntyre, A. D. 1952. The food of the halibut from North Atlantic fishing grounds. Scottish Home Department. Marine Research, Edinburgh, H. M. S. O., no. 3. 19 pp.
- McIntyre, A. D. 1958. The ecology of Scottish inshore fishing grounds. Part 1. The bottom fauna of the east coast of Scotland. Scottish Home Department. Marine Research, Edinburgh, H. M. S. O., no. 1, 16 pp.
- McIntyre, A. D. 1978. The Benthos of the western North Sea. Rapports et Procès-Verbaux des Réunions du Conseil International pour l'Exploration de la Mer, 172: 405-417.
- Millais, J. G. 1906. The Mammals of Great Britain and Ireland. London.
- Mitchell, J. M. 1864. The Herring, its Natural History and National Importance. Edmonston and Douglas, Edinburgh.
- Myers, R. A., Bridson, J., and Barrowman, N. J. 1995. Summary of worldwide stock and recruitment data. Canadian Technical Report of Fisheries and Aquatic Sciences, no. 2024. 274 pp.
- Nakano, H., and Wantanabe, Y. 1992. Effect of high seas driftnet fisheries on blue shark stocks in the North Pacific. Compendium of documents submitted to the Scientific Review of North Pacific Highseas Driftnet Fisheries, Sidney, B.C., Canada, Vol. 1. 15 pp.
- Nall, J. G. 1866. Great Yarmouth and Lowestoft, a Handbook for Visitors and Residents; with chapters on the archaeology, natural history etc. of the district; a history with statistics of the east coast herring fishery and an etymological and comparative glossary of the dialect of East Anglia. Longman Green, London.
- Otto, L. J., Zimmerman, T. F., Furnes, G. K., Mork, M., Saetre, R., and Becker, G. 1990. Review of the physical oceanography of the North Sea. Netherlands Journal of Sea Research, 26: 161-238.
- Paloheimo, J. E., and Dickie, L. M. 1966. Food and growth of fishes. Part III. Relations among food, body size, and growth efficiency. Journal of the Fisheries Research Board of Canada, 23 (8): 1209-1248.
- Palomares, M. L. D. 1991. La consommation de nourriture chez les poissons: étude comparative, mise au point d'un modèle prédictif et application à l'étude des réseaux trophiques. Thèse de Doctorat, Institut National Polytechnique de Toulouse. 211 pp.
- Palomares, M.L.D., and Pauly, D. 1998. Predicting food consumption of fish populations as function of mortality, food type, morphometrics, temperature and salinity. Marine Freshwater Research, 49: 447-53.
- Pauly, D. (1995) Anecdotes and the shifting baseline syndrome of fisheries. *Trends in Ecology & Evolution* 10, 430.
- Pauly, D. 1989. Food consumption by tropical and temperate marine fishes: Some generalizations. Journal of Fish Biology, Suppl. A: 11-20.
- Pepita, T. S., Pavlova, E. V., and Mironov, G. N. 1970. The food web structure, utilization and transport of energy by trophic levels in the planktonic communities. In Marine Food Chains, pp. 142-167. Ed. by J. H. Steele. Oliver and Boyd, Edinburgh.
- Postma, H. 1978. The nutrient contents of the North Sea water: Changes in recent years, particularly in the southern bight. Rapports et Procès-Verbaux des Réunions du Conseil International pour l'Exploration de la Mer, 172: 350-357.
- Poulet, S. A. 1973. Grazing of *Pseudocalanus minutus* on naturally occurring particulate matter. Limnological Oceanography, 18: 564-573.
- Poulet, S. A. 1974. Seasonal grazing of *Pseudocalanus minutus* on particles. Marine Biology, 25: 109-123.
- Poulet, S. A. 1976. Feeding of *Pseudocalanus minutus* on living and non living particles. Marine Biology, 34: 117-125.
- Rachor, E. 1982. Biomass distribution and production estimates of macro-endofauna in the North Sea. ICES CM 1982/L, 2: 1-10.
- Rae, B. B. 1956. The food and feeding habits of the lemon sole. Marine Research, Edinburgh, H. M. S. O., no. 1. 26 pp.
- Rae, B. B. 1960. Seals and Scottish fisheries. DAFS. Marine Research, Edinburgh, H. M. S. O., no. 2. 39 pp.
- Rae, B. B. 1963. The food of the megrim. Marine Research 1963 (3): 23.
- Rae, B. B. 1967a. The food of the cod in the North Sea and on West of Scotland ground. DAFS. Marine Research, Edinburgh, H. M. S. O., no. 1. 64 pp.
- Rae, B. B. 1967b. The food of the dogfish (*Squalus acanthias*). DAFS. Marine Research, Edinburgh, H. M. S. O., no. 4. 17 pp.
- Rae, B. B. 1968. The food of seals in Scottish waters. DAFS. Marine Research, Edinburgh, H. M. S., no. 2. 23 pp.
- Rae, B. B. 1969. The food of the witch. DAFS. Marine Research, Edinburgh, H. M. S., no. 2. 20 pp.
- Rae, B. B., and Delvin, S. D. E. 1972. The turbot, its fishery and biology in the Scottish area. Department of Fisheries and Agriculture for Scotland. Marine Research, no. 1. 27 pp.
- Raitt, D. F. S. 1964. The stocks of *Trisopterus esmarkii* (Nilsson) off North-west Scotland and the North Sea.

- DAFS. Marine Research, Edinburgh, H. M. S. O., no. 1. 12 pp.
- Raith, D. F. S., and Adams, J. A. 1965. The food and feeding of *Trisopterus esmarkii* (Norway pout) in the Northern North Sea. Marine Research, Edinburgh, H. M. S. O., no. 3. 28 pp.
- Reid, P. C., Lancelot, C., Gieskes, W. W. C., Hagmeier, E., and Weichart, G. 1990. Phytoplankton of the North Sea and its dynamics, a review. Netherlands Journal of Sea Research 3. 28 pp.
- Reilly, S. B., and Barlow, J. 1986. Rates of increase in dolphin population size. Fishery Bulletin, 84: 527-533.
- Roff, C. J., Middlebrook, K., and Evans, F. 1988. Long term variability in the North Sea zooplankton off the Northumberland coast: Productivity of small copepods and analysis of trophic interactions. Journal of the Marine Biological Association UK, 68: 143-164.
- Ritchie, A. 1937. The food and feeding habits of the haddock in Scottish waters. Scientific Investigations of the Fisheries Board of Scotland 2. 94 pp.
- Ritchie, A. 1938. Preliminary observations on the food of the plaice, *Pleuronectes platessus*, in Scottish waters. Rapports et Procès-Verbaux des Réunions du Conseil International pour l'Exploration de la Mer, 107: 49-56.
- Saemundsson, B. 1949. Marine pisces. Zoology Iceland, 4 (72). 150 pp.
- Sahrhage, D. and Wagner, G. 1978. On the fluctuations in the haddock population in the North Sea. Rapports et Procès-Verbaux des Réunions du Conseil International pour l'Exploration de la Mer, 172: 72-85.
- Sahrhage, D., and Lundbeck, J. 1992. A History of Fishing. Springer-Verlag, Berlin.
- Scott, T. 1902. Observations of the food of fishes. Reports of the Fishery Board Scotland 1901, 20 (3): 486-538.
- Scott, T. 1903. Some further observations on the food of fishes, with a note on the food observed in the stomach of the common porpoise. Report of the Fisheries Board Scotland 1902, 21 (3): 218-227.
- Sergeant, D. E. 1951. The status of the common seal on the east Anglian coast. Journal of Marine Biology Association UK, 29: 707-717.
- Sherr, E. B., Sherr, B. F., and Paffenhöfer, G. A. 1986. Phagotrophic protozoa as food for metazoans: A missing trophic link in marine pelagic food webs? Marine Microbiology Food Webs, 1: 61-80.
- Sibthorp, M. M. 1975. The North Sea. Challenge and Opportunity. Report of a study group of the David Davies Memorial Institute of International Studies. Europa Publications, London. 324 pp.
- Small, R. J. and DeMaster, D. 1995. Alaska marine mammal population assessments. US Department of Commerce, NOAA Technical Memorandum NMFS-AFSC-57. 93 pp.
- Smidth, J. K. 1876. Historical observations on the conditions of the fisheries among the ancient Greeks and Romans and on their mode of salting and pickling fish. Rep. Comm. US Comm. Fish and Fisheries for 1873-4 and 1874-6, Part III, Appendix 3, pp. 3-20.
- Smith, W. R. 1889. On the food of fishes. Report of the Fishery Board Scotland 1888, 7 (3): 222-258.
- Smith, W. R. 1890. On the food of fishes. Report of the Fishery Board Scotland 1890, 8 (3): 230-256.
- Southwell, T. 1881. Seals and Whales of the British Seas. London.
- Sparholt, H. 1990. An estimate of the total biomass of fish in the North Sea. Journal du Conseil International pour l'Exploration de la Mer, 46: 200-210.
- Stevens, G. A. 1934. A short investigation towards the habits, abundance and species of seals on the North Cornish coast. Journal of Marine Biology Association UK, 19: 489-501.
- Steele, J. H. 1974. The structure of marine ecosystems. Blackwell scientific publications, Oxford. 127 pp.
- Stillwell, C. E., and Kohler, N. E. 1982. Food, feeding habits and estimates of daily ration of the shortfin mako (*Isurus oxyrinchus*) in the northwest Atlantic. Canadian Journal of Fisheries and Aquatic Science, 39: 407-414.
- Summers, C. F. 1978. Changes in the seal populations of the North Sea. Rapports et Procès-Verbaux des Réunions du Conseil International pour l'Exploration de la Mer, 172: 278-285.
- Thiel, H. 1938. Thunfisch und Thunfischfang. Der Fischmarkt, Neue Folge, 6: 4-9.
- Thomas, H. J. 1958. Lobster and Crab Fisheries in Scotland. Scottish Home Department. Marine Research, Edinburgh, H. M. S. O., no. 8. 93 pp.
- Thompson D'Arcy, W. 1909. On the statistics of the Aberdeen trawl fishery, 1901-1906, with special reference to the cod and haddock. Rapports et Procès-Verbaux des Réunions du Conseil International pour l'Exploration de la Mer, 10: B2.
- Thompson D'Arcy, W. 1912. Whales, seals and sea-serpents. In Science of the Sea. Ed. by H. Fowler. John Murray, London. 453 pp.
- Tiews, K. 1978. On the disappearance of Bluefin Tuna in the North Sea and its ecological implications for herring and mackerel. Rapports et Procès-Verbaux des Réunions du Conseil International pour l'Exploration de la Mer, 172: 301-309.
- Trites, A., and Pauly, D. 1998. Estimating mean body masses of marine mammals from maximum body lengths. Canadian Journal of Zoology, 76: 886-896.
- Trites, A. W., Livingston, P., Vasconcellos, M. C., Mackinson, S., Springer, A. M., and Pauly, D. 1999. Ecosystem change and the decline of marine mammals in the Eastern Bering Sea: Testing the ecosystem shift and commercial whaling hypotheses. Fisheries Centre Research Report 7(1).
- True, E. W. 1904. The whalebone whales of the Western North Atlantic. Smithsonian contribution to knowledge (Smithsonian Institute), Vol. XXXIII. 332 pp.
- Venier, J. 1996. Pacific Halibut. pp. 43-45. In: Mass balance models of North-eastern Pacific ecosystems. Ed. by D. Pauly and V. Christensen. Fisheries Centre Research Report 4(1).
- Wada, Y. 1996. Marine mammals and birds. pp. 69-73. In: Mass balance models of North-eastern Pacific ecosystems. Ed. by D. Pauly and V. Christensen. Fisheries Centre Research Report 4(1).
- Waldron, K. D. 1963. Synopsis of biological data on Skipjack *Katsuwonus pelamis* (Linnaeus) 1758 (Pacific Ocean). FAO Fisheries Report, 6 (2): 695-748.
- Walker, P. A., Witte, J. I. J., and van Steenberg, H. 2000. Growth and maturation of ray species in the North Sea: A comparative study. (in prep.)
- Wilde, P. A. W. J., Berghuis, E. M., and Kok, A. 1986. Biomass and activity of benthic fauna on the Fladen ground (northern North Sea). Netherlands Journal of Sea Research, 20: 313-323.
- Williams, P. J. le B. 1981. Incorporation of microheterotrophic processes into the classical paradigm of the planktonic food web. Kieler Meeresforsch. Sonderheft (Occ. Publ.), 5: 1-28.
- Williams, R., and Lindley, J. A. 1980a. Plankton of the Fladen ground during FLEX '76. Part I. Spring development of the plankton community. Marine Biology 57: 73-78.
- Williams, R., and Lindley, J. A. 1980b. Plankton of the Fladen ground during FLEX '76. Part III. Vertical distribution, population dynamics and production of *Calanus finmarchicus* (Crustacea: Copepoda). Marine Biology 60: 47-56.
- Wilson, G. 1965. Scottish Fishing Craft. Fishing News Books, London.
- Wood, C. C., Ketchen, K. S., and Beamish, R. J. 1979. Population dynamics of spiny dogfish (*Squalus acanthias*) in British Columbia waters. Journal of the Fisheries Research Board Canada Fish, 36: 647-656.
- Yarrell, W. 1836. A history of British Fishes, Vol. II. J. Van Horst, London. 472 pp.



## **PART II: NORTHWEST ATLANTIC**

---

### **A PRELIMINARY MODEL FOR THE LANCASTER SOUND REGION IN THE 1980s**

**Elizabeth Mohammed**

*Fisheries Centre, University of British Columbia  
2204 Main Mall, Vancouver, BC, Canada, V6T 1Z4  
e-mail: e.mohammed@fisheries.ubc.ca*

#### **ABSTRACT**

A preliminary model structure is presented for the Lancaster Sound region, northeastern Canada. The model is composed of 31 groups including 9 groups of mammals. Model inputs were derived mainly from data in Welch *et al.* (1992; Arctic 45: 343-357) and other Ecopath models constructed for other regions of similar latitude. The model balancing procedure is described and major data limitations are identified. Results are preliminary and remain to be verified and refined by scientists working on the ecology and biology of Arctic Sea species. Possible applications of the model are also identified.

#### **INTRODUCTION**

A preliminary Ecopath model was constructed for the Lancaster Sound Region (LSR), located between 80-100°W and 72-76°N, a total area of 97,698 km<sup>2</sup> (Figure 1). A brief description of the area, including depth ranges, circulation patterns and seasonal changes in ice cover is given in Welch *et al.* (1992). The region is important as a habitat and feeding area for populations of marine mammals and seabirds. It also supports four Inuit communities totaling about 2000 individuals and is the site of major industrial activity associated with mining. Further, it represents an important transportation route for aircrafts and ships across the Northwest Passage and there is a high potential for extraction of hydrocarbons. Given the concerns over exploitation of marine mammals (including polar bears) and the accumulation of pollutants in arctic carnivores, quantifying the energy flows throughout this ecosystem will be useful in ascertaining the degree of trophic interaction and dependence among various functional groups. Further, with refinement of the model and application of Ecosim, the path of marine pollutants in the ecosystem can be traced. This

exercise focuses on the first step, i. e., quantifying energy flows among functional groups.

#### **METHODOLOGY AND DATA INPUTS**

The model assumes mass balance in that production of any given prey is equal to the biomass consumed by predators plus the biomass caught, (e. g., in fisheries) plus any exports from the system:

$$B_i * (P/B)_i * EE_i = Y_i + \sum B_j * (Q/B)_j * DC_{ij} + E_{xi} \quad \dots 1)$$

where  $B_i$  and  $B_j$  are biomass for the prey and its consumers respectively,  $(P/B)_i$  is the production/biomass ratio,  $EE_i$  is the ecotrophic efficiency or fraction of production available for consumption within the system,  $Y_i$  is the harvest,  $(Q/B)_j$  is the food consumption per unit biomass of the predator 'j', and  $DC_{ij}$  is the proportion of prey 'i' in the diet of predator 'j'. All weights are given in tonnes, area in km<sup>2</sup> and the time unit is a year. The model requires that the diet composition of all groups is known and at least two of the following three parameters:  $EE$ ,  $P/B$  or  $Q/B$  are known for each functional group and calculates the missing value by balancing a series of linear equations of the form above for each functional group in the system.  $P/B$ ,  $Q/B$ , fishing mortality ( $F$ ) and natural mortality ( $M$ ) are expressed per year.

Initially, apart from primary producers (phytoplankton, algae and kelp), 33 functional groups were identified, based on diet and relative abundance (for lower trophic levels). However, for reasons discussed in the balancing procedure these were reduced to the following 28: polar bear, killer whale, narwhal, beluga whale, bowhead, harp seal, bearded seal, ringed seal, walrus, glaucous gull, murre, black guillemot, northern fulmar, kittiwake, Arctic cod, Greenland halibut, finfish, copepods, other herbivorous zooplankton, ice amphipods, chaetognaths, *Parathemisto* sp., other omnivorous zooplankton, *Mertensia ovum*, other carnivorous zooplankton, *Mya truncata*, other bivalves and other benthos. Input data were acquired from Welch *et al.* (1992) and other sources. These pertained mainly to the late 1980s and given on an annual basis rather than seasonal, (i. e., summer or winter period). When appropriate estimates could not be found, various assumptions were made based on previous studies in other regions of similar latitude.

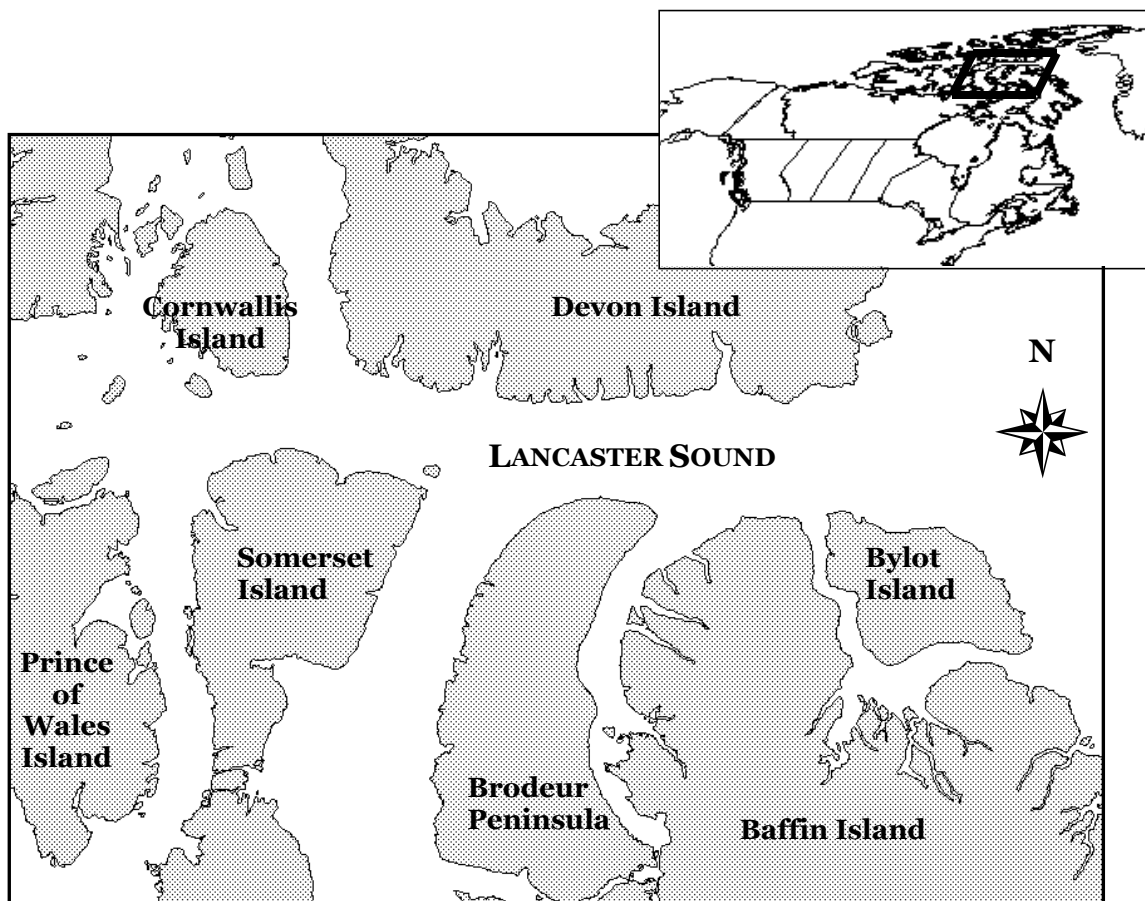

**Primary production**

Biomass estimates of 560 t·km<sup>-2</sup>, 50 t·km<sup>-2</sup> and 11 t·km<sup>-2</sup> were calculated from data in Welch *et al.* (1992) for phytoplankton, algae and kelp respectively. P/B ratios for phytoplankton (150 year<sup>-1</sup>) and algae (50 year<sup>-1</sup>) were obtained from a model of Prince William Sound, Alaska (Okey and Pauly 1998). A P/B of 50 year<sup>-1</sup> was assumed for kelp.

**Mammals**

*Polar bear*

Estimates of biomass (0.00364 t·km<sup>-2</sup>) and Q/B (3.325 year<sup>-1</sup>) were derived using data on abundance, mean body weight and distribution area found in Welch *et al.* (1992) and computed as biomass = (mean body weight \* abundance)/distribution area. A P/B of 0.02 was assumed. Harvest was estimated at 0.00008 t·km<sup>-2</sup> year<sup>-1</sup>, given a quota of 38 bears at a mean size of 200 kg and distribution area equivalent to the entire LSR. Polar bear diet was assumed to consist of 95% ringed seal, 1.5% bearded seal, 1.5% harp seal and 1.5% walrus based on Welch *et al.* (1992).

*Marine mammals*

Marine mammals were divided into eight groups: killer whales, narwhals, beluga whales, bowheads, harp seals, bearded seals, ringed seals and walrus.

Biomass estimates for all groups except bowheads and bearded seals were calculated using estimates of abundance, mean body size and distribution area provided in Welch *et al.* (1992) (Table 1). Killer whale distribution was assumed to be the same as for narwhals, their main prey. Abundance estimates for bowheads and bearded seals were obtained from the Vancouver Aquarium Lancaster Sound 1998 exhibit, while mean size of bowheads was taken from Trites and Pauly (1998). Mean size of bearded seals was estimated using yield in numbers and corresponding weight in Welch *et al.* (1992) (mean size = yield/number caught). The corresponding distribution area was assumed to be the entire LSR. Distribution of bowheads was assumed to be the same as for killer whales.

**Table 1.** Biomass estimates for marine mammals

Species	Abundance	Mean weight (t)	Area (km <sup>2</sup> )	Biomass (t·km <sup>-2</sup> )
Killer whale	20 <sup>a</sup>	2.3	85,778	0.0005
Narwhal	20 000	0.854	85,778	0.199
Beluga	12 000	0.880	79,968	0.132
Bowhead	200	31.075	85,778	0.072
Harp seal	25 000 <sup>a</sup>	0.106	88,525	0.030
Bearded seal	200	0.250	97,697	0.0005
Ringed seal	161 200	0.50	97,697	0.825
Walrus	1 000 <sup>a</sup>	0.512	30,000 <sup>a</sup>	0.017

<sup>a</sup> Crude estimates after Welch *et al.*, 1992

**Table 2.** Consumption biomass ratios for marine mammals.

Species	Ingestion (t·km <sup>-2</sup> ·year <sup>-1</sup> )	Biomass (t·km <sup>-2</sup> )	Q/B (year <sup>-1</sup> )
Killer whale	-	0.0004	2.4 <sup>c</sup>
Narwhal	0.372	0.199	1.87
Beluga	0.294	0.132	2.23
Bowhead	-	0.072	2.23 <sup>b</sup>
Harp seal	0.094 <sup>a</sup>	0.030	3.13
Bearded seal	-	0.0005	15.67 <sup>b</sup>
Ringed seal	1.285	0.082	15.67
Walrus	0.381 <sup>a</sup>	0.017	22.41

<sup>a</sup> Crude estimates according to Welch *et al.* (1992)

<sup>b</sup> Assumed

<sup>c</sup> 3% body weight (2.3 t) eaten per day (Trites and Heise, 1996) equivalent to 5.13t over 75 days residence time (Welch *et al.*, 1992) gives Q/B of 2.4 year<sup>-1</sup>

P/B ratios were taken from Trites and Heise (1996). P/B values of 0.06 year<sup>-1</sup> were assigned to pinnipeds and 0.02 year<sup>-1</sup> to whales. Q/B ratios (Table 2) were estimated as for polar bears using data from Welch *et al.* (1992). Diet composition was estimated based on data from the same source (Table 3). Harvest rates were estimated from data on yield (t·year<sup>-1</sup>) and distribution area in Welch *et al.* (1992). Killer whales were not harvested and it was assumed that bowheads were also not caught. Estimates are given in Table 4.

### Marine birds

Marine birds were organized in five different groups: glaucous gulls, guillemot (adults and juveniles), fulmar (adults and juveniles), murre (adults, juveniles and chicks) and kittiwake (adults and juveniles). Biomass of birds (Table 5) was estimated using the same method as for polar bears and data from Welch *et al.* (1992). P/B ratios were assumed the same as that for similar species in the Prince William Sound region (Okey and Pauly, 1998) (Table 5). Juveniles and chicks were assumed to have P/B of 1.5 times that of adults because of their faster growth rate. Q/Bs were estimated using the same method as for polar bears using data from Welch *et al.* (1992) (Table 5). Diet composition (Table 6) data were taken from Welch *et al.* (1992) and were slightly modified based on further details given for northern fulmars and black-legged kittiwakes. In addition to Arctic cod, these species also consume copepods and amphipods, which were assumed to be of similar proportions in the diet.

**Table 3.** Diet composition of marine mammals.

Species	NA	BE	BS	RS	AC	GH	OB	PA	MA	OBV
Killer whale	0.512	0.092	0.092	0.092	0.12					
Narwhal					0.75	0.25				
Beluga					1.0					
Bowhead					0.8		0.2			
Harp seal					0.95		0.05			
Bearded seal					0.95 <sup>a</sup>		0.05 <sup>a</sup>			
Ringed seal					0.6		0.15	0.25		
Walrus									0.85	0.15

NA - Narwhals, BE - Beluga, BS - Bearded Seal, RS - Ringed Seal, AC - Arctic Cod, GH - Greenland Halibut, OB - Other Benthos, PA - *Parathemisto sp.*, MA - *Mya truncata*, OBV - Other Bivalves.

<sup>a</sup>Diet composition assumed same as for harp seal.

**Table 4.** Harvest estimates of marine mammals.

Species	Yield (t·year <sup>-1</sup> )	Distribution area (km <sup>2</sup> )	Harvest (t·km <sup>-2</sup> ·year <sup>-1</sup> )
Narwhal	306	85,778	0.004
Beluga	37	79,968	0.00046
Harp seal	35	88,525	0.00039
Bearded seal	45	97,697	0.00046
Ringed seal	375	97,697	0.0038
Walrus	10	30,000	0.00034

## Fishes

The main species of importance in the region are Arctic cod, Greenland halibut and other finfish, mainly capelin. The latter is a major food source of the Greenland halibut. Arctic cod biomass was estimated at 0.062 t·km<sup>-2</sup> (Welch *et al.* 1992). Biomass estimates for Greenland halibut and finfish were not available and therefore these were left for estimation by Ecopath using ecotrophic efficiencies (EE) of 0.98 and 0.94 respectively. This implies almost full utilization by predators in the system.

P/B estimates for Pacific cod (1.2 year<sup>-1</sup>) and Pacific halibut (0.32 year<sup>-1</sup>) were taken from Okey and Pauly (1998), assuming the parameters are similar for the Arctic cod and Greenland halibut respectively. In the case of Pacific halibut however, P/B was equal to total mortality estimated in the Prince William Sound region. The applicability of the same estimate for Greenland halibut in the Arctic is highly questionable. Further, differences in growth rate of the two species should also be considered in relation to their respective habitats. This is also applicable to capelin, for which a P/B of 3.5 year<sup>-1</sup> was also taken from Okey and Pauly (1998).

Again, Q/B estimates were taken from Okey and Pauly (1998) with the same assumptions as for P/B. The estimate used for Arctic cod was 4 year<sup>-1</sup>. For Greenland halibut (with an asymptotic total length of 138 cm, after Bowering and Lilly, 1992) the Q/B for Pacific halibut over 80 cm TL (1.095 year<sup>-1</sup>) was used. A Q/B value of 18 year<sup>-1</sup> for capelin was taken from the same source.

**Table 5.** Biomass, P/B and Q/B estimates for marine birds.

Group number, Species	Abundance	Mean body weight (kg)	Area (km <sup>2</sup> )	Biomass (t·km <sup>-2</sup> )	P/B (year <sup>-1</sup> )	Ingestion (t·km <sup>-2</sup> ·year <sup>-1</sup> )	Q/B (year <sup>-1</sup> )
10, Glaucous Gulls	-	-	-	-	15	NA	130
11, Murre (adults)	452,000	0.9	43,643	0.009	11	0.2749	30.54
11, Murre (juv.)	218,000	0.9	43,643	0.004	16.5 <sup>a</sup>	0.0573	14.34
11, Murre (chicks)	169,500	0.2	43,643	0.00078	16.5 <sup>a</sup>	0.0043	5.51
	-	-	-	<b>0.01378<sup>c</sup></b>	-	-	<b>16.79<sup>d</sup></b>
12, Black guillemot (adults)	34,000	0.4	97,697	0.00014	11 <sup>a</sup>	0.0039	27.86
12, Black guillemot (juv.)	17,000	0.4	97,697	0.00007	16.5 <sup>a</sup>	0.0011	15.71
	-	-	-	<b>0.00021<sup>c</sup></b>	-	-	<b>21.79<sup>d</sup></b>
13, Northern fulmar (adults)	320,000	0.65	78,925	0.003	6	0.1022	34.07
13, Northern fulmar (juv.)	160,000	0.65	78,925	0.001	9 <sup>a</sup>	0.0204 <sup>b</sup>	20.4
	-	-	-	<b>0.004<sup>c</sup></b>	-	-	<b>27.26<sup>d</sup></b>
14, Kittiwake (adults)	200,000	0.365	43,643	0.0017	7 <sup>a</sup>	0.0618	36.35
14, Kittiwake (juv.)	100,000	0.365	43,643	0.0008	10.5 <sup>a</sup>	0.0124 <sup>a</sup>	15.5
	-	-	-	<b>0.0025<sup>c</sup></b>	-	-	<b>25.93<sup>d</sup></b>

<sup>a</sup>Assumed value (see text);

<sup>b</sup>Assuming ratio of adult to juvenile ingestion rate is 5, i. e., the average observed for other species. Source: Okey and Pauly (1998);

<sup>c</sup>Sum;

<sup>d</sup>Mean.

**Table 6.** Estimates of diet composition for marine birds.

Species	AC	PA	SA	CO	MJ	MC	FF
Gulls	0.29 <sup>a</sup>				0.15 <sup>a</sup>	0.15 <sup>a</sup>	0.41 <sup>a</sup>
Murre (adults)	0.85	0.10	0.05				
Murre (juv.)	0.85	0.10	0.05				
Murre (chicks)	1.0						
Black guillemot (adults)	0.80	0.20					
Black guillemot (juv.)	0.80	0.20					
Northern fulmar (adults)	0.7	0.10 <sup>a</sup>	0.10 <sup>a</sup>	0.10 <sup>a</sup>			
Northern fulmar (juv.)	1.0						
Kittiwake (adults)	0.7	0.10 <sup>a</sup>	0.10 <sup>a</sup>	0.10 <sup>a</sup>			
Kittiwake (juv.)	1.0						

AC- Arctic cod; PA - *Parathemisto* sp; SA- sympagic amphipods; CO – copepods; MJ – Murres juveniles; MC - Murres chicks; FF – Finfish (mainly capelins).

<sup>a</sup> Assumed value (see text).

Information on diet composition (Table 7) from FishBase (1998) was modified according to groups present in the system. The diet of Arctic cod was 83% zooplankton and 17% zoobenthos (Craig *et al.*, 1982). The proportion of the diet attributed to zooplankton was divided equally among all such groups and the proportion attributed to zoobenthos divided equally between *M. truncata*, other bivalves and other benthos. The diet of Greenland Halibut comprised 96.9% nekton, 3% zoobenthos and 0.1% zooplankton

(Bowering and Lilly, 1992). The nekton was assumed to comprise of finfish solely while the zooplankton proportion was divided equally among all associated groups. The zoobenthos component was attributed to the ‘other benthos’ group. Planktonic invertebrates are the main food source of capelins. As a result diet was attributed equally to all planktonic groups in the system and 0.5% of the diet divided equally among algae and kelp assuming that these are digested incidentally.

**Table 7.** Diet composition of fishes.

Species	CO	OHZ	CA	PA	OZ	MO	OB+	CG	KE+	FF
Arctic cod	0.1185	0.1185	0.1185	0.1185	0.1185	0.1185	0.170	0.1185		
Greenland halibut	0.0003				0.0003		0.030	0.0003		0.969
Finfish (capelin)	0.142	0.142	0.142	0.142	0.142	0.142		0.142	0.005	

CO – copepods, OHZ – other herbivorous zooplankton; CA – chaetognaths; PA – *Parathemisto* sp.; OZ – other omnivorous zooplankton; MO – *Mertensia ovum*; OB+ – includes *Mya truncata*, other bivalves and other benthos; CG – other carnivorous zooplankton; KE+ – kelp and algae; FF – finfish (mainly capelin).

## Zooplankton

Zooplankton were divided into three groups: herbivorous, omnivorous and carnivorous zooplankton.

Copepods were the only herbivorous zooplankton, amphipods, chaetognaths and *Parathemisto* sp. were the only omnivorous zooplankton, and *Mertensia ovum* was the only carnivorous jelly zooplankton for which detailed information were available. Biomass estimates were taken from Welch *et al.* (1992, Table 4), and converted to the appropriate units using conversion parameters in Table 8. Initially, P/B and Q/B were estimated from data in Welch *et al.* (1992) as growth/biomass and ingestion/biomass respectively; however, the results obtained were several orders of magnitude greater than what has been reported for the respective species. As a result, inputs were taken from other sources (Table 9). The categories 'other herbivorous zooplankton', 'other omnivorous zooplankton' and 'other carnivorous zooplankton' were included to incorporate species not represented in the data, but which may contribute significantly to the diet of other groups.

Several assumptions were made given the general lack of data for lower trophic levels (as was acknowledged by Welch *et al.*, 1992), and they remain to be verified. Biomass of 'other herbivorous zooplankton' was assumed to be equal to that of copepods, 'other omnivorous zooplankton' equal to *Parathemisto* sp., and 'other carnivorous gelatinous zooplankton' equal to *M. ovum*.

**Table 8.** Conversion parameters used to derive input estimates.

1g C	dw = 10 g ww
Phytoplankton	dw = 0.1 ww
Zooplankton	dw = 0.1 ww
Amphipods	dw : ww = 26:74
Copepods	dw = 10.86% ww
<i>Parathemisto</i> sp.	dw = 0.25 ww
Chaetognaths	dw : ww = 0.083
<i>Mertensia ovum</i>	dw = 0.25 ww
<i>Mya truncata</i>	dw = 0.25 ww

'dw' is dry weight and 'ww' is wet weight.

Diet of copepods and other herbivorous zooplankton was assumed to comprise 50% phytoplankton and 50% algae. For chaetognaths, the diet was assumed to be comprised mainly of copepods and other herbivorous zooplankton (66.7% divided equally between each group), 16.7% algae and 16.7% phytoplankton. This was based on the observation that diet consisted mainly of small herbivorous zooplankton in Arai (1996). For *Parathemisto* sp., and other omnivorous zooplankton, a diet composition of 16.7% copepods, 16.7% other herbivorous zooplankton, 33.3% phytoplankton and 33.3% zooplankton was assumed. Similarly, for ice amphipods a diet composition of 16.7% copepods, 16.7% other herbivorous zooplankton, 16.7% kelp, 16.6% phytoplankton and 33.3% algae was assumed. *Mertensia ovum* diet was assumed to comprise 67% herbivorous zooplankton, 23% omnivorous zooplankton and 10% phytoplankton. The diet of other carnivorous gelatinous zooplankton was assumed to be comprised of 20% for each of the copepod, other herbivorous zooplankton, *M. ovum* and other carnivorous gelatinous zooplankton groups, and 10% for each of *Parathemisto* spp. and other omnivorous zooplankton groups.

**Table 9.** Biomass, P/B and Q/B input parameters for zooplankton, benthic invertebrates and other benthos.

Group	Biomass (t·km <sup>-2</sup> )	P/B (year <sup>-1</sup> )	Q/B (year <sup>-1</sup> )
Copepods	13.26	21 <sup>a</sup> (mean)	70 <sup>d</sup> (mean)
Other herbivorous zoo.	13.26 <sup>d</sup>	21 <sup>a</sup> (mean)	70 <sup>a</sup> (mean)
Ice amphipods	0.019	2.4 <sup>b</sup>	12 <sup>d</sup>
Chaetognaths	12.000	3 <sup>c</sup>	10 <sup>d</sup>
<i>Parathemisto</i> sp.	2.72	6.45 <sup>d</sup>	21.5 <sup>d</sup>
Other omnivorous zoo.	2.72 <sup>d</sup>	6.45 <sup>a</sup> (mean)	21.5 <sup>a</sup> (mean)
<i>Mertensia ovum</i>	2.29	8.82 <sup>a</sup>	29.4 <sup>a</sup>
<i>Mya truncata</i>	580	0.034	28.6
Other bivalves	-	0.034 <sup>d</sup>	23 <sup>a</sup>
Other benthos	-	0.885 <sup>a</sup>	23 <sup>a</sup>
Other carnivorous zoopl.	2.29 <sup>d</sup>	8.82 <sup>a</sup>	29.4 <sup>a</sup>

<sup>a</sup> Okey and Pauly (1998). Mean estimates are calculated from Tables 9 and 10 of the reference paper; <sup>b</sup> Jarre-Teichman and Guénette (1996) for southern B.C. Model; <sup>c</sup> Arai (1996) Alaska Gyre Model; <sup>d</sup> Assumed value. Unmarked inputs are taken from Welch *et al.*, (1992).

## Benthic invertebrates

Benthic invertebrates were divided into two broad groups: bivalves and other benthos. As with zooplankton, data were unavailable for this trophic level group. The biomass estimate of *Mya truncata* (bivalve), 580 t·km<sup>-2</sup>, was derived using data from Welch *et al.* (1992). No estimates were available for other bivalves such as *Hiatella arctica*, *Serripes groenlandicus* and *Macoma calcarea*, hence these were grouped under 'other bivalves' and their biomass estimated by Ecopath assuming an ecotrophic efficiency of 0.81 (after Jarre–Teichmann and Gu nette, 1996) and a P/B similar to that of *Mya truncata*. A P/B value for the latter species of 0.34 year<sup>-1</sup> was estimated from data in Welch *et al.* (1992), while Q/B was set at 28.6 year<sup>-1</sup> (Okey and Pauly, 1998 for benthos) assumed. It must be cautioned that the method for deriving Q/B (i. e., ingestion/biomass) using data in Table 4 of Welch *et al.* (1992) yielded unrealistic estimates (see above). A diet composition of 100% detritus was applied to all filter-feeding bivalves (*M. truncata* and other bivalves).

'Other benthos' includes sea cucumbers, sea urchins, brittle stars, anemones, terebellid polychaetes, pycnogonids, small crustaceans and molluscs. Welch *et al.* (1992) gave estimates of density for some species in Barrow Strait. These could be converted to biomass, given mean weight of the respective species. However, because of lack of data and associated additional assumptions regarding P/B and Q/B, these taxa were aggregated into the general category 'other benthos'. P/B and Q/B for the group were taken from Okey and Pauly (1998) (Table 9). An ecotrophic efficiency of 0.81 was assumed (the mean estimated for major benthic groups in Jarre–Teichmann and Gu nette, 1996) and biomass estimated by Ecopath. Diet composition was estimated to be 70% detritus, 29% other bivalves and 1% zooplankton (divided equally between other herbivorous and other omnivorous zooplankton), based on data for major benthic groups in Jarre–Teichmann and Gu nette (1996).

## BALANCING THE MODEL AND ASSOCIATED RESULTS

The model was balanced using a systematic approach, first adjusting the parameters of respective groups for which there was the least confidence in accuracy. The resulting parameters, diet matrix, and output summary statistics are shown in Table 10-12. Trophic interactions are represented in Figure 2. The area of each box is proportional to the logarithm of the biomass of

the respective group and all flows are in t·km<sup>-2</sup>·year<sup>-1</sup>·ww.

## Primary producers

Initially, an EE value >1 was obtained for algae. This indicates either low P/B or low biomass compared to the quantities consumed. Given the greater confidence in biomass estimate, the P/B was increased to 70 year<sup>-1</sup> until EE was no longer larger than 1. This solution also resulted in a positive estimate for the respiration.

## Marine mammals

Ecotrophic efficiencies (EE) >1 were obtained for bearded and ringed seals. This implies one of four things: low biomass, low P/B, inaccurate diet composition of associated predators or some combination of the other three. Adjusting diet composition is the most difficult 'fix', given the possible consequences for other animals in the ecosystem. Hence, balancing the model focused on altering the biomasses which were often poorly known (Welch *et al.*, 1992). In the case of ringed seals, EE was set at 0.95 since their utilization by predators was considered close to maximum possible yield (Welch *et al.*, 1992) and the biomass increased to 0.22 t·km<sup>-2</sup>. The resulting P/B estimated by Ecopath was 0.08 year<sup>-1</sup>. The biomass for bearded and harp seals was gradually increased to 0.05 t·km<sup>-2</sup> when their EE became smaller than 1. Also, to achieve mass-balance for this group, the original narwhal biomass was increased to 0.3 t·km<sup>-2</sup>.

## Marine birds

EE >1 was derived for juveniles of all groups and murre chicks. Also, P/B ratios were greater than (Q/B)/2 for these groups. Since diet composition of adult and juvenile marine seabirds was the same in most instances, all life stages of each species were grouped into one category, the biomass summed and average Q/B used. P/B was assumed to be that for adults. Further, the diet composition of the predatory glaucous gulls was altered to include 30% murre, 29% arctic cod and 41% finfish (mainly capelin). Also, the diet composition of northern fulmars and kittiwakes was adjusted to include copepods, which comprised 10% of juvenile diet for both groups. It is to be noted, however, that most predation and cannibalism among marine birds is not represented in the model (hence the EE of zero for each group except murre). The model further

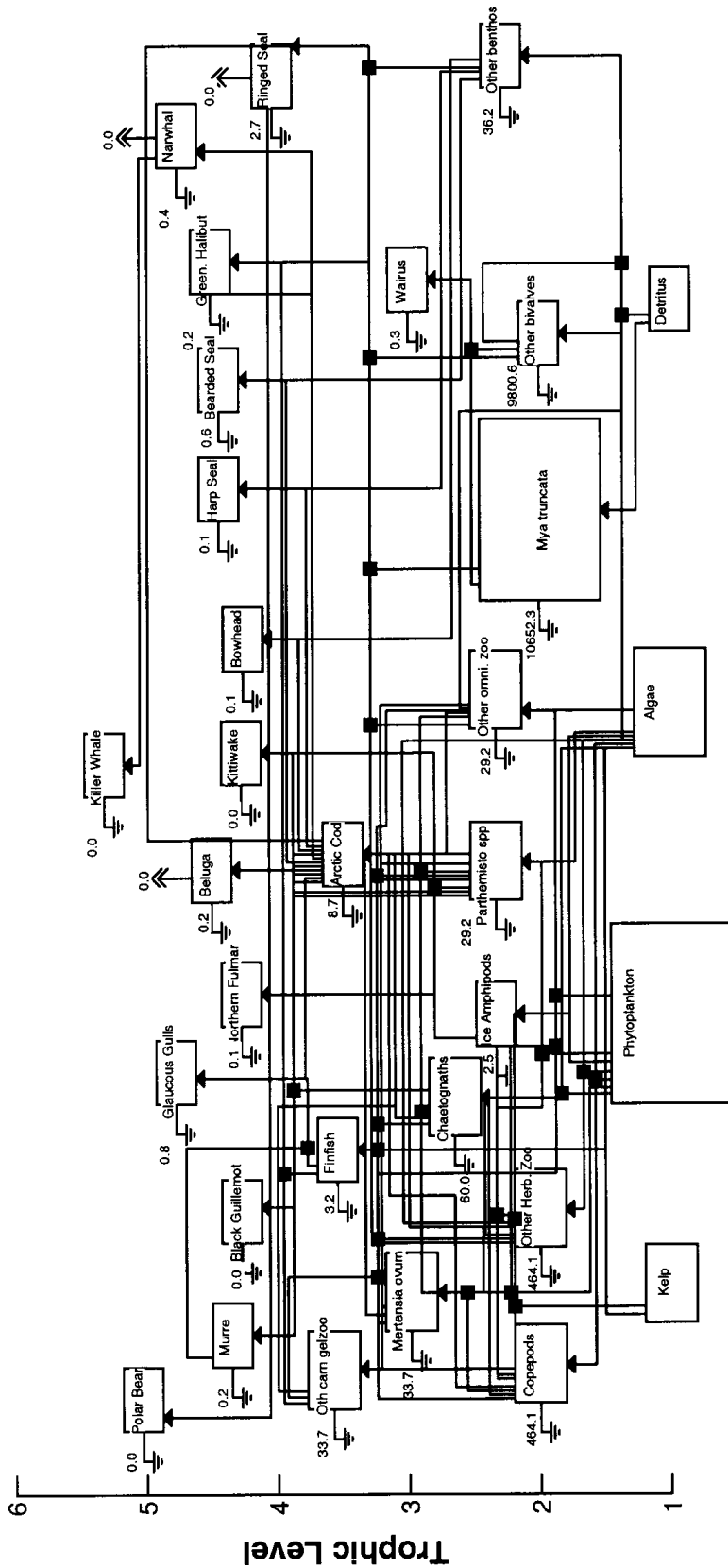

Figure 2. Flow chart of trophic interaction in the Lancaster Sound Region (preliminary model).



indicated  $P/B > (Q/B)/2$  for murre and black guillemots indicative of growth in excess of what can be accommodated with the input  $Q/B$ . Thus their  $Q/B$  was increased, from 16.79 year<sup>-1</sup> to 23 year<sup>-1</sup> for murre and from 21.79 year<sup>-1</sup> to 23 year<sup>-1</sup> for black guillemot. A negative respiration was noted for murre and the  $P/B$  was increased gradually from 11 year<sup>-1</sup> until the respiration estimate became positive. This occurred at  $P/B = 27$  year<sup>-1</sup>. The  $Q/B$  was increased accordingly to 54 year<sup>-1</sup> to avoid  $P/B > (Q/B)/2$ , which is so extremely unlikely as to be impossible.

## Fishes

Ecopath assigned a negative respiration to arctic cod indicative of either low biomass or low  $P/B$

ratio. Since Welch *et al.* (1992) indicated that cod biomass may have been underestimated as acoustic surveys failed to detect schools in deep waters, this parameter was left for estimation by Ecopath. Further, since predation on the species is high, an EE of 0.95 was assumed. Ecopath estimated a biomass of 4.347 t·km<sup>-2</sup>. Hop *et al.* (1997), working on the bio-energetics of cod at low temperatures, suggested that biomass must have been about five times the value found in Welch *et al.* (1992). This would give a biomass estimate of 0.31 t·km<sup>-2</sup>, considerably lower than the estimate obtained here. Further refinement of the model should verify which of the two estimates is more accurate.

**Table 10.** Parameters of the balanced Lancaster Sound model. All biomass are expressed in wet weight. Parameters estimated by Ecopath are in bold italics.

Group number and name	Trophic level	Biomass in habitat area (t·km <sup>-2</sup> )	Biomass (t·km <sup>-2</sup> )	P/B (year <sup>-1</sup> )	Q/B (year <sup>-1</sup> )	EE	P/Q
1 Polar bear	4.9	0.004	0.004	0.02	3.325	<b>0</b>	<b>0.006</b>
2 Killer whale	5.1	0.001	0.001	0.02	2.4	<b>0</b>	<b>0.008</b>
3 Narwhal	4.5	0.3	0.3	0.02	1.87	<b>0.871</b>	<b>0.011</b>
4 Beluga	4.3	0.132	0.132	0.02	2.23	<b>0.462</b>	<b>0.009</b>
5 Bowhead	4.1	0.072	0.072	0.02	2.23	<b>0</b>	<b>0.009</b>
6 Harp seal	4.3	0.05	0.05	0.06	3.13	<b>0.197</b>	<b>0.019</b>
7 Bearded seal	4.3	0.05	0.05	0.06	15.67	<b>0.293</b>	<b>0.004</b>
8 Ringed seal	3.9	0.22	0.22	0.08	15.67	<b>0.95</b>	<b>0.005</b>
9 Walrus	3.0	0.017	0.017	0.06	22.41	<b>0.745</b>	<b>0.003</b>
10 Glaucous gulls	4.5	0.009	0.009	15	130	<b>0</b>	<b>0.115</b>
11 Murre	4.2	0.014	0.014	27	54	<b>0.929</b>	<b>0.5</b>
12 Black guillemot	4.1	0.001	0.001	11	23	<b>0</b>	<b>0.478</b>
13 Northern fulmar	4.1	0.004	0.004	6	27.26	<b>0</b>	<b>0.22</b>
14 Kittiwake	4.1	0.003	0.003	7	25.93	<b>0</b>	<b>0.27</b>
15 Arctic cod	3.3	<b>4.347</b>	<b>4.347</b>	1.2	4	0.95	<b>0.3</b>
16 Greenland halibut	4.2	<b>0.447</b>	<b>0.447</b>	0.32	1.095	0.98	<b>0.292</b>
17 Copepods	2.0	13.26	13.26	21	70	<b>0.358</b>	<b>0.3</b>
18 Other herbivorous zooplankton	2.0	13.26	13.26	21	70	<b>0.359</b>	<b>0.3</b>
19 Ice amphipods	2.3	0.019	0.019	220	440	<b>0.939</b>	<b>0.5</b>
20 Chaetognaths	2.3	12	12	3	10	<b>0.187</b>	<b>0.3</b>
21 <i>Parthemisto</i> sp.	2.3	2.72	2.72	6.45	21.5	<b>0.821</b>	<b>0.3</b>
22 Other omnivorous zooplankton	2.3	2.72	2.72	6.45	21.5	<b>0.781</b>	<b>0.3</b>
23 <i>Mertensia ovum</i>	3.0	2.29	2.29	8.82	29.41	<b>0.806</b>	<b>0.3</b>
24 <i>Mya truncata</i>	2.0	580	580	0.034	23	<b>0.066</b>	<b>0.001</b>
25 Other bivalves	2.0	<b>576.801</b>	<b>533.62</b>	0.034	23	0.81	<b>0.001</b>
26 Other benthos	2.0	<b>2.225</b>	<b>2.225</b>	0.885	23	0.81	<b>0.038</b>
27 Kelp	1.0	11.05	11.05	50	-	<b>0.003</b>	-
28 Other carnivorous jelly zooplankton	2.3	2.29	2.29	8.82	29.41	<b>0.806</b>	<b>0.3</b>
29 Phytoplankton	1.0	560	560	150	-	0.012	-
30 Algae	1.0	50	50	70	-	<b>0.283</b>	-
31 Finfish	3.2	<b>0.29</b>	<b>0.29</b>	3.5	18	0.94	<b>0.194</b>
32 Detritus	1.0	-	-	-	-	<b>0.289</b>	-



**Table 12.** Summary statistics of the preliminary ecosystem model for the Lancaster Sound Region

Parameter	Value
Sum of all consumption <sup>a</sup>	28925
Sum of all exports <sup>a</sup>	65633
Sum of all respiratory flows <sup>a</sup>	22419
Sum of all flows into detritus <sup>a</sup>	92276
Total system throughput <sup>a</sup>	209253
Sum of all production <sup>a</sup>	88773
Mean trophic level of the catch	4.350
Calculated total net primary production <sup>a</sup>	88053
Total primary production/total respiration	3.928
Net system production <sup>a</sup>	65633
Total primary production/total biomass	48
Total biomass/total throughput	0.009
Total biomass (excluding detritus) <sup>b</sup>	795
Total catches <sup>a</sup>	0.010
Connectance index	0.143
System Omnivory Index	0.142

<sup>a</sup> Unit: Wet weight (t·km<sup>-2</sup>·year<sup>-1</sup>); <sup>b</sup> Unit: Wet weight (t·km<sup>-2</sup>)

## DISCUSSION

The exercise can be considered at best a first pass at the application of ecosystem modeling using Ecopath for the Lancaster Sound Region. However, as recognized by Welch *et al.* (1992), upon which this exercise is based, major data gaps for intermediate trophic levels, most benthic species and most zooplankton species exist. Also, data on feeding habitats, ranges and populations are incomplete, resulting in difficulties in estimating total kill and prey consumption in whales and birds. This is a direct result of migration out of the region (Welch *et al.*, 1992).

Although assumptions regarding P/B and Q/B for individual species are possible based on studies conducted elsewhere, the same cannot be done for biomass. In some instances, therefore, assumptions regarding the ecotrophic efficiency were made, allowing for estimation of biomass by Ecopath once the other three input parameters were known. Even so, these assumptions can severely affect interpretations derived from output parameters if environmental or habitat conditions for other studies are markedly different from the LSR. Differences in P/B and Q/B associated with the temperature changes implied with increasing latitude should be accounted for. It must be cautioned that a balanced model does not imply accurate depiction of the existing situation. The predictions are only as reliable as the input

parameters used. The lack of data forced assumptions to be made, which may or may not reflect the existing situation in the LSR.

Further, clarification remains to be sought regarding the estimation of growth and ingestion parameters for zooplankton, benthic invertebrates and arctic cod in Welch *et al.* (1992). Once this is done, accurate parameters representative of these functional groups in the LSR can be substituted into the model. It would also be useful if data inputs for the summer and winter period were treated separately, as this would allow differences in bio-energetics associated with each period to be incorporated in the model. Welch *et al.* (1992) also gives estimates of respiration and gross growth efficiencies for some species, which can be compared with model outputs (or used in the 'alternative input' routine of Ecopath).

Further refinement of the Ecopath model for the LSR should be a collaborative effort among scientists with research interests on species in the area to strengthen the reliability of the input parameters to the model and facilitate a greater understanding of the trophic dynamics of the system. The usefulness of such an exercise is the ability to trace accumulation of pollutants up the food web using the routine now implemented in Ecosim and/or to examine implications of possible policy options regarding harvesting of marine mammals (including polar bears) and fish species.

## REFERENCES

- Arai, M. S. 1996. Carnivorous zooplankton, jellies and *Veleva*. p. 18. In: Mass-Balance Models of North-Eastern Pacific Ecosystems. Ed. by D. Pauly and V. Christensen. Fisheries Centre Research Report 4(1).
- Bowering, W. R. and Lilly, G. R. 1992. Greenland halibut, *Reinhardtius hippoglossoides*, off southern Labrador and north-eastern Newfoundland (NW Atlantic) feeding primarily on capelin, *Mallotus villosus*. Netherlands Journal of Sea Research, 29: 211-222.
- Craig, P. C., Griffith, W. B., Haldorson, L. and McElderry, H. 1982. Ecological studies of Arctic cod, *Boreogadus saida*, in Beaufort Sea coastal waters, Alaska. Canadian Journal of Fisheries and Aquatic Sciences, 39: 395-406.
- Froese, R. and Pauly, D. Editors. 1998. FishBase. World Wide Web electronic publication. [www.fishbase.org](http://www.fishbase.org), 1998.
- Haakon, H., Tonn, W. M. and Welch, H. E. 1997. Bioenergetics of Arctic cod (*Boreogadus saida*) at low temperatures. Canadian Journal of Fisheries and Aquatic Sciences, 54: 1772-1784.
- Jarre-Teichman, A. and Gu enette, S. 1996. Invertebrate benthos. pp. 38-39. In: Mass-Balance Models of North-Eastern Pacific Ecosystems. Ed. by D. Pauly and V. Christensen. Fisheries Centre Research Report 4(1).
- Okey, T. and Pauly, D. (eds.), 1998. A Trophic Mass-Balance Model of Alaska's Prince William Sound Ecosystem, for the Post-Spill Period, 1994-1996. Fisheries Centre Research Report 6(4).
- Trites, A. W. and Pauly, D. 1998. Estimating mean body masses of marine mammals from maximum body lengths. Canadian Journal of Zoology, 76: 886-896.
- Trites, A. W. and Heise, K. 1996. Marine mammals. pp. 25-30. In: Mass-Balance Models of North-Eastern Pacific Ecosystems. Ed. by D. Pauly and V. Christensen. Fisheries Centre Research Report 4(1).
- Welch, H. E., Bergmann, M.A., Siferd, T.D., Martin, K.A., Curtis, M.F., Crawford, R.E., Conover, R.J. and Hop, H. 1992. Energy flow through the marine ecosystem of the Lancaster Sound Region, Arctic Canada. Arctic, 45: 343-357

# A MASS BALANCE MODEL FOR THE WEST GREENLAND MARINE ECOSYSTEM

S. A. Pedersen<sup>1</sup> and D. Zeller<sup>2</sup>

<sup>1</sup>Greenland Institute of Natural Resources  
Department of Marine Ecology and Aquaculture  
Danish Institute for Fisheries Research  
Kavalergården 6, DK-2920 Charlottenlund  
Denmark  
email: sap@dfu.min.dk

<sup>2</sup>Fisheries Centre, University of British Columbia  
2204 Main Mall, Vancouver, BC, V6T 1Z4, Canada

## ABSTRACT

The paper reviews the available information on fisheries, community structure and trophic relationships in the West Greenland marine ecosystem. In an attempt to evaluate the relationships between the dominant species and fisheries, a mass balance model using the Ecopath approach was constructed for the West Greenland shelf (0-1,500m) for 1997. The present report outlines the input data used to obtain a balanced Ecopath model, forming the foundation for future simulations.

## INTRODUCTION

The increasing demand that management of marine resources is to be based on multispecies and ecosystem considerations has led to increased interest in improving our understanding of the more dynamic aspects and inter-relationships in marine ecosystems (Livingston and Tjelmeland, 2000; Reid *et al.*, 2000; Pauly *et al.*, 2001). This applies especially to Arctic marine systems, to which such approaches have rarely been applied.

This paper gives an overview of the exploited West Greenland marine ecosystem using Ecopath with Ecosim, a widely used software for mass-balance modeling (Christensen and Pauly, 1993; Christensen, 1995; Pauly and Christensen, 1996; Christensen and Walters, 2000). To give the reader some background knowledge of the system, we start with a short review of the exploitation of marine resources and the possible causes of species fluctuations in the system.

## Exploitation of marine resources

During the twentieth century, Greenland has gradually changed from a nation of hunters to a nation of highly educated and trained people conducting a modern fishing industry. One reason for this development has been a rich cod fishery starting in the 1920s after a general warming of the Arctic (Jensen, 1939). Historically, the cod has been the most important commercial fish species in Greenland waters, with annual catches peaking at levels between 400,000 and 500,000 tonnes in the 1960s (Buch *et al.*, 1994; Horsted, 2001). During the late 1960s, the annual catches of cod and other commercially important fish species - mainly taken as by-catch in the cod fishery, e.g., redfish (*Sebastes marinus*), Atlantic halibut (*Hippoglossus hippoglossus*) and wolffish (Atlantic wolffish, *Anarhichas lupus*, and spotted wolffish, *A. minor*) declined drastically. After 1970 the catches of cod and redfish showed fluctuations at much lower levels compared to the 1960s (Figure 1). Except for a temporary improvement of the cod fishery during 1988-1990, the catches of cod, redfish, Atlantic halibut and wolffish showed decreasing trends from about 1980 to 1998 (Anon., 1999, 2000). Over the same period, however, catches (inshore and offshore combined) of two other important species, the Greenland halibut (*Reinhardtius hippoglossoides*) and the northern shrimp (*Pandalus borealis*) showed increasing trends (Figure 1). Whereas the cod catches have been taken mainly in offshore areas (outside the 3-mile limit) by an international bottom trawl fishery, the catches of Greenland halibut have been taken predominantly in the inshore areas (inside the 3-mile limit) by national fleets using longlines and gillnets, with the former being the traditional gear (Smidt, 1969; Riget and Boje, 1989). The offshore fisheries for Greenland halibut were below 1,600 tonnes during the period 1982-1990. In 1991 catches increased to 2,376 tonnes and were around 5,500 tonnes in the period 1992-1995, but decreased to around 4,500 in the period 1996-1998 (Jørgensen, 2000a). The peak in the catch statistic for Greenland halibut in 1975 are due to 20,000 tonnes reported by the former USSR from an offshore bottom trawl fishery.

The fishery for northern shrimp, *Pandalus borealis*, in West Greenland waters began in 1935 as a local fishery in a fjord south of the Sisimiut (Holsteinsborg) settlement, but was interrupted during World War II. After 1946, several grounds with exploitable shrimp resources were found in inshore areas along the west coast of Greenland. From 1950 the inshore fishery expanded rapidly, Disko Bay being the most important area (Figure 2). Total catches from the inshore fishery ranged

from 7,000 to 8,000 tonnes in the years from 1975 to 1987, but have increased in recent years to more than 21,000 tonnes in 1992. Inshore catches decreased to 9,515 tonnes in 1998 and increased again to 17,000 tonnes in 1999. During the 1990s inshore catches have accounted for about 25% of the total catch in NAFO Subarea 1. An offshore shrimp fishery in the Davis Strait began about 1970. The nominal catch of shrimp from Subarea 1 and the adjacent part of Subarea 0 (Div. 0A) increased from less than 1,000 tonnes before 1972 to almost 43,000 tonnes in 1976.

Catches fluctuated thereafter and stabilized around a level of 54,000 tonnes during 1985-88, then increased to about 66,000 tonnes in 1992 and decreased thereafter to about 56,000 tonnes in 1998. Total catch in the offshore areas for 1999 increased again to 59,500 tonnes (Siegstad, 2000). Traditionally, a number of nations have been participating in this fishery, including Canada, Denmark, France, Faroe Islands, Greenland, Japan, Norway, Spain, West Germany and USSR. However, since 1993 only Greenland vessels are fishing shrimps in West Greenland waters.

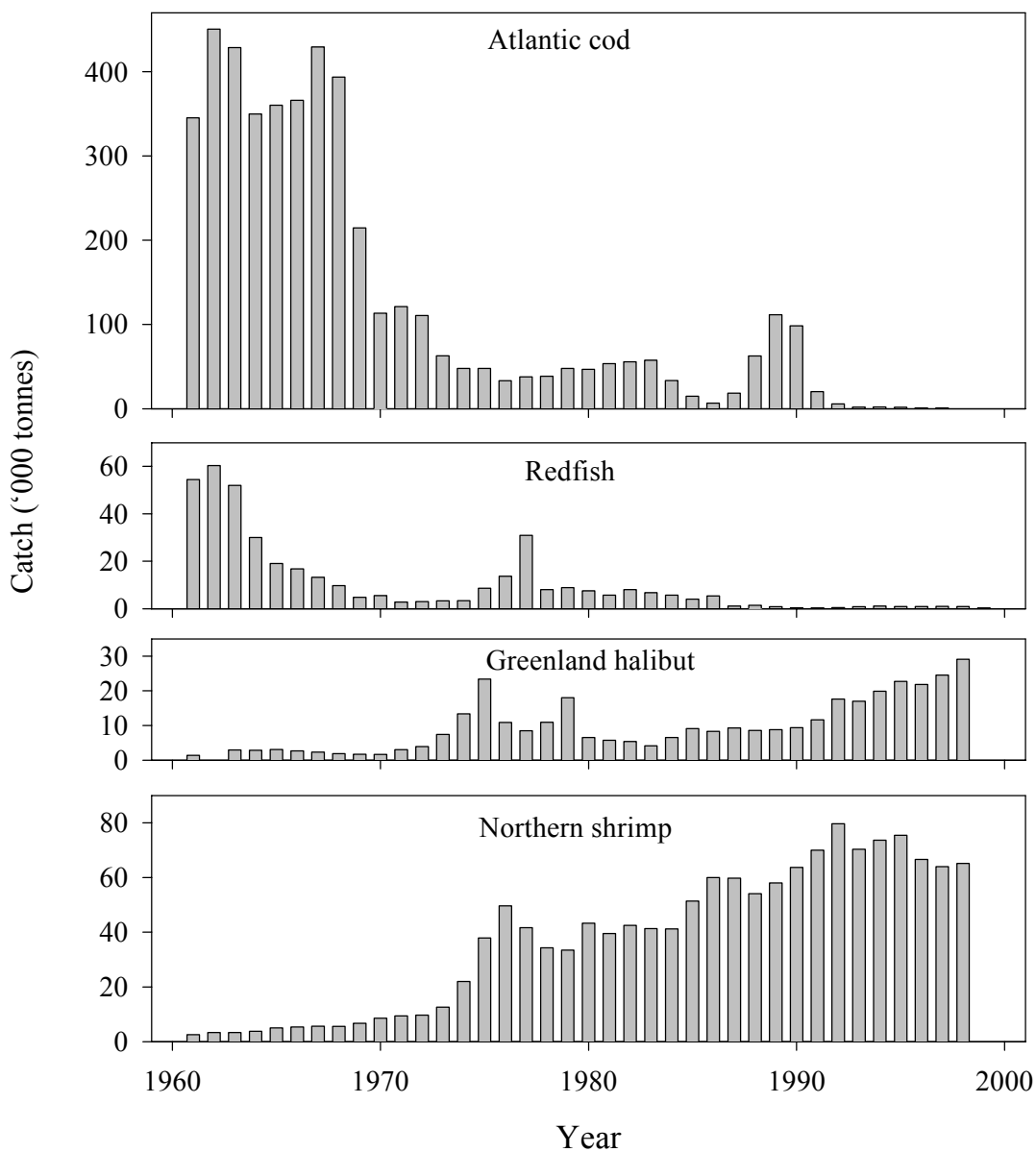

**Figure 1.** Catches of the four major fisheries species (Atlantic cod, Redfish, Greenland halibut and Northern shrimp) in West Greenland waters (NAFO Subarea 1 - inshore and offshore areas combined) for the period 1960-1999. Data from NAFO Statistical Bulletin and Anon. (2000), Jørgensen (2000a), Siegstad (2000), Siegstad *et al.* (2000) and Simonsen and Boje (2000). NB: 'tonnes' refers to 'metric tonnes', i.e., 1000 kg.

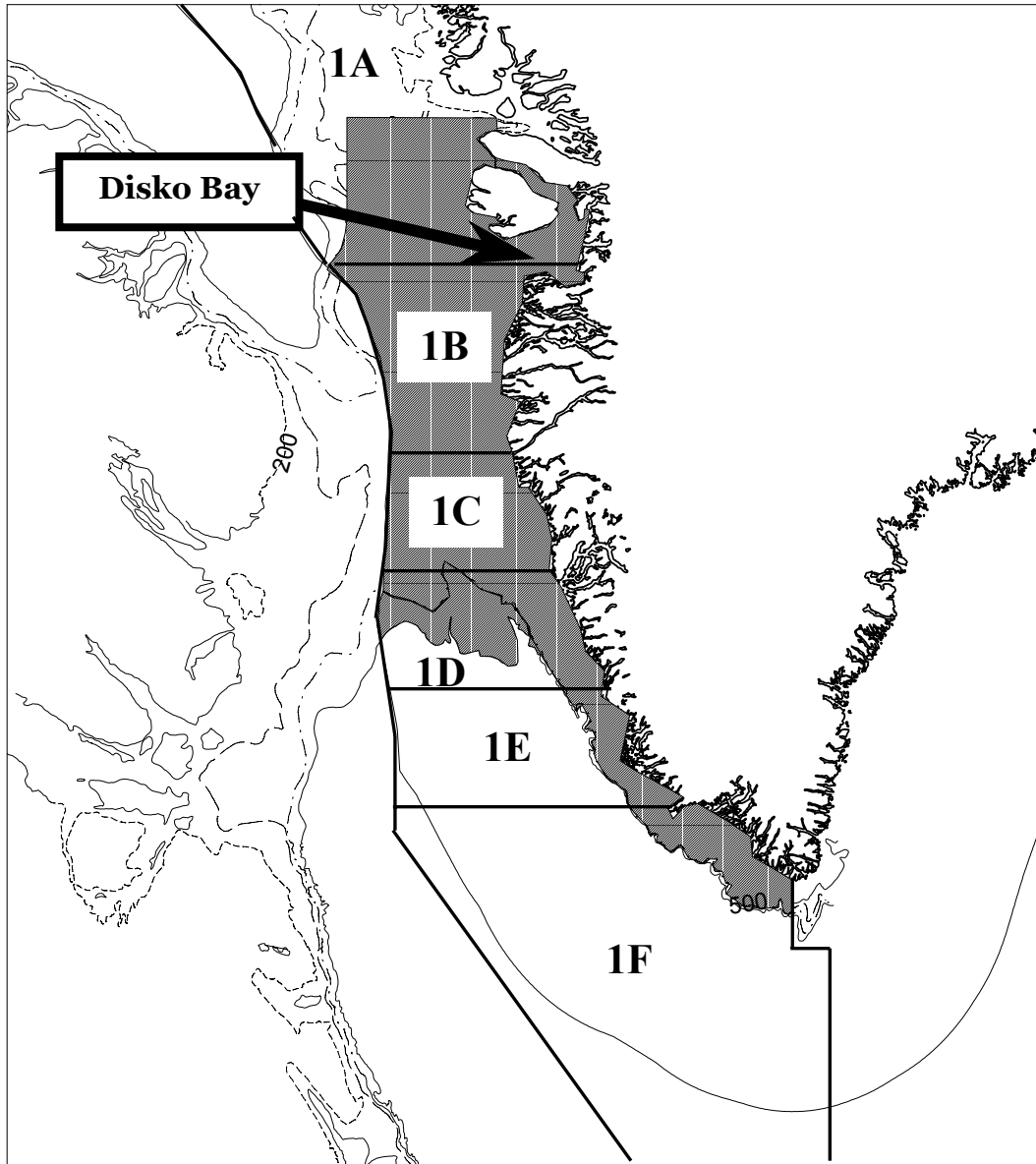

**Figure 2.** Map of West Greenland marine environment. The area represented by the Ecopath model is shaded gray, with depths from 0-1,500m, and a surface area of approximately 240,000 km<sup>2</sup>. NAFO statistical areas mentioned in the text (1A-1F) are indicated.

It is important to keep in mind that the above descriptions of the fish and shrimp catches only represent the reported landings. In addition one would have to add an unknown amount of unreported fish and shrimp catches discarded at sea. The West Greenland sea has often been observed as "red" due to large amounts of dead redfish floating on the sea surface, especially in the 1950s and 1960s (S.A. Horsted, former Director of the Greenland Fisheries Research Institute, pers. comm.). Several of the fishing fleets did not utilize redfish and large amounts of redfish were discarded or died due to contact with the fishing gear. In the West Greenland shrimp fishery discarding of shrimp of 2 grams and above has been prohibited since 1985. However, in practice there is large scale discarding of small, low value shrimp (Siegstad, 1993).

In addition to the fisheries yields from the West Greenland marine ecosystem, one has to add the hunting (and consumption) of more than 40,000 seals, several hundred whales and several hundred-thousand seabirds per year on average. The seal hunt targets primarily ringed seals (*Phoca hispida*) and harp seals (*Phoca groenlandica*), but also takes other species including the walrus (*Odobenus rosmarus*) (Kapel, 1993, 1994; Born *et al.*, 1994). The whale hunt is mainly on fin whales (*Balaenoptera physalus*), minke whales (*B. acutorostrata*), white whales (*Delphinapterus leucas*), narwhals (*Monodon monocerus*) and occasionally others (Kapel, 1979; Heide-Jørgensen, 1994). The seabird hunt is primarily on thick-billed murre (*Uria lomvia*), king eider (*Somateria spectabilis*) and common eider (*S. mollissima*) (Evans, 1984; Falk and Durinck, 1992; Frimer, 1993; Mosbech *et al.*, 1998).

### Possible causes of species fluctuations

The decline in recent years in catches and abundance indices of cod and other, mainly boreal fish species on the one hand, and the increasing annual catches of northern shrimp and Greenland halibut on the other, raises several questions. For example, to what extent are these changes due to environmental variation, or fishing, or both? How does fishing activities affect the ecosystem? Who eats who in the marine ecosystem and what is the role of species interactions in the observed changes in catches and biomass?

Historically, the occurrence of cod in Greenland waters shows very large fluctuations in abundance as well as in geographical distribution (Horsted, 1989; Buch *et al.*, 1994). Changes in the temperature conditions in West Greenland in the 20<sup>th</sup> century generally coincide with changes in the

cod fishery, indicating the existence of a relatively strong climatic effect on the cod stock. A general warming of the northern hemisphere around 1920 evidently lead to the establishment of a self sustaining and very abundant West Greenland cod population, which from about 1930 to the late 1960s produced good year classes at relatively short intervals. No good year classes were produced by the West Greenland population after the late 1960s due to generally lower and more fluctuating water temperatures in the West Greenland area. All important cod year classes in West Greenland from 1970 to the present time seem to have been of Icelandic origin. The latest of these, the 1984 and 1985 years classes sustained relatively high catches during 1988-1990 but evidently left West Greenland thereafter (Buch *et al.*, 1994; Rätz, 1999; Anon., 2000). At present cod is very sparse in both offshore and inshore areas of West Greenland, and the ICES Advisory Committee on Fisheries Management recommend no fishing until a substantial increase in recruitment and biomass is evident (Anon., 1998, 2000). In addition it is recommended to reduce the by-catch and discard of cod in the shrimp fishery since simulations using a recruitment model indicated a significant adverse effect of even low fishing mortality of pre-recruits on the potential stock recovery (Anon., 2000).

Data from an annual groundfish survey for cod on the southwest Greenland shelf (0-400 m depth) performed by Germany from 1982-1998, showed a dramatic decline in overall biomass and abundance indices of the mainly boreal fish species (cod, long rough dab (*Hippoglossoides platessoides*), redfish (*Sebastes marinus*), Atlantic wolffish and spotted wolffish) in coherence with an increased abundance of starry ray (*Raja radiata*) (Rätz, 1992, 1999). According to Rätz (1992), both of these changes could be associated with changes in water temperature and fishing effort, and they were interpreted as symptoms of ecosystem stress.

The distribution area of northern shrimp coincides with important nursery areas for several fish species. A large number of fish, mainly redfish, Greenland halibut, and polar cod (*Boreogadus saida*), but also starry ray, long rough dab and others are caught and discarded in the West Greenland shrimp fishery (Pedersen and Kannevorff, 1995; Kingsley *et al.*, 1999; Engelstoft and Jørgensen, 2000). The juveniles of these fish species are spawned on spawning grounds up-current from the shrimp grounds and drift by sea currents to the nursery areas (Smidt, 1969; Riget and Boje, 1989; Pedersen, 1990; Buch *et al.*, 1994). There are large annual fluctuations in the year-class strength and biomass indices of a number of fish species on the offshore West Greenland shrimp



grounds (Pedersen and Kanneworff, 1995; Engelstoft and Jørgensen, 2000). Although little quantitative information on the by-catch and discards of fishes in the West Greenland shrimp fishery is available, the considerable fishing effort of the Canadian and Greenland shrimp fisheries in the Davis Strait of 250,000 hours of trawling in 1992 declining to 177,000 hours in 1999 (Siegstad, 2000) seems to affect the demersal fish community by diminishing the recruiting year-classes (Pedersen and Kanneworff, 1995).

Investigations of selective shrimp trawls which reduce the by-catch and discard of small shrimp and fish were started in Greenland waters in 1990 (Valdemarsen *et al.*, 1993) raising the question of whether increased survival rates of fish might reduce the yield from the shrimp fishery on account of increased predation. In Greenland waters several fish species, e.g., Atlantic halibut, cod, Greenland halibut, redfish, long rough dab and starry ray have been identified as important predators on shrimp (Jensen, 1925; Horsted and Smidt, 1965; Smidt, 1969; Tiedtke, 1988; Köster and Schober, 1990; Pedersen and Riget, 1991, 1993; Grünwald, 1992, 1998; Pedersen, 1994, 1995). The northern shrimp stock off West Greenland is regarded as more stable than that of cod, because the northern shrimp are distributed in deeper water with less temperature fluctuations compared to cod, and because northern shrimp has been a common species in Greenland over a longer time period than cod (Horsted, 1989). According to Horsted (1989), it is appropriate to ask whether the present abundance of shrimp in West Greenland waters is the result of a lower stock size of one of its main predators, namely cod. The question is, however, not readily answered because another predator, Greenland halibut seems to be more plentiful when the cod stock is at a low level (Horsted, 1989).

In inshore areas off West Greenland, harp seals have been found to consume a considerable amount of fish and shrimp (Angantyr and Kapel, 1990). Thick-billed murres have been found to feed on fish, mainly capelin (*Mallotus villosus*), and crustaceans in the same area (Falk and Durinck, 1993).

## Objectives

The main objective of this report was to develop a mass-balance ecosystem model (Ecopath with Ecosim, Christensen and Walters, 2000) for the West-Greenland area down to 1,500 m depth. It is anticipated that this model will be used for simulations to address issues of interest to the Greenland Institute of Natural Resources. For example, this model can be used (1) to evaluate the

levels of predation and fishing mortalities and (2) to evaluate the magnitude of fishing impacts relative to climate change, and thereby possibly get new insights of how to fish the system in a sustainable, yet economically viable fashion.

## MATERIALS AND METHODS

A mass balance model using the Ecopath with Ecosim approach (Christensen *et al.*, 2000) was constructed for the West Greenland shelf for 1997. The model area is 240,000 km<sup>2</sup> and ranges from 0-1,500 m depth (Figure 2). The biota in the study area were grouped in 22 key system components defined from the available information of biomass and commercial importance (Tables 1-3). All estimates of biomass were expressed on an area basis (tonnes·km<sup>-2</sup>) and mortality rates on a yearly basis (year<sup>-1</sup>) to facilitate comparisons with other systems and models.

Information on the fish community structure and biomass in the study area were obtained primarily from annual shrimp and groundfish surveys performed by the Greenland Institute of Natural Resources, and by the Institute for Sea Fisheries, Hamburg, Germany (Carlsson and Kanneworff, 2000; Engelstoft and Jørgensen, 2000; Rätz, 1999). The shrimp surveys were performed in July-August during daytime only, using the 722 GRT trawler *Paamiut*, with a 3000/20-mesh *Skjervoy* shrimp trawl (wing spread, opening and headline height: about 23 m, 280 m<sup>2</sup> and 16 m, respectively) with bobbin gear, a double-bag with 20 mm (stretched) mesh size in the codend and a towing speed of about 2.5 knots. The German groundfish surveys were performed during autumn because of favorable weather and ice conditions, and the lack of spawning concentrations. Those surveys were carried out by the research vessel (R/V) *Walther Herwig II* throughout most of the time period. In 1984 R/V *Anton Dohrn* was used, and she was replaced by the new R/V *Walther Herwig III* in 1994. The fishing gear used was a standardized 140-foot bottom trawl, its net frame rigged with heavy ground gear because of the rough nature of the fishing grounds. A small mesh liner (10 mm) was used inside the codend.

Bottom trawl performance, availability and catchability of shrimp and fish are highly variable (Engås and Godø, 1986, 1989a, b; Godø and Engås, 1989; Dickson, 1993). Capture efficiency of trawl gear with bobbin ground-rope can range from 0.1 to 0.5 and the efficiencies are low for small shrimp, juvenile fish, bottom fishes (e.g. starry ray), and pelagic fishes (Nilssen *et al.*, 1986; Sparholt and Vinther, 1991; Larsen *et al.*, 1993; Bech, 1994; Boje and Lehmann, 1994).

Many system groups in West Greenland waters are known to exhibit temporal trends in biomass change, and the model structure permitted us to incorporate estimates of the levels of biomass change (Table 1).

Much of the diet composition data for the present model originates from stomach contents analysis of fish stomachs sampled from the key fish species during 1990, 1991 and 1992 on the continental shelf between 61° 52' N and 69° 30' N in the Davis Strait outside the 3 nm limit off the Greenland coast in depths of 150-600 m (Pedersen and Riget, 1991, 1993; Grünwald, 1992, 1998; Grünwald and Köster, 1994; Pedersen, 1994, 1995).

**Table 1.** Basic parameters used to describe the 1997 West Greenland Ecopath model, with 21 functional groups. P/B and Q/B are the production/biomass and consumption/biomass ratios, respectively. Trophic level and values in brackets were estimated by the model.

Group	Habitat fraction	Biomass in habitat (t·km <sup>-2</sup> )	P/B (year <sup>-1</sup> )	Q/B (year <sup>-1</sup> )	Ecotrophic efficiency	Biomass accumulation (t·km <sup>-2</sup> year <sup>-1</sup> )	Trophic level
Baleen whales	1	0.458	0.030	4.00	(0.519)	0.000	3.8
Toothed mammals	1	0.049	0.060	10.00	0.900	0.000	4.4
Seals	1	0.509	0.070	15.00	0.900	0.000	4.3
Seabirds	1	0.008	1.000	99.00	(0.211)	0.000	3.9
Cod 4+	1	0.047	0.300	2.80	(0.263)	0.000	4.0
Cod juv	1	0.010	0.600	3.50	(0.657)	0.002	3.9
Grl. halibut 5+	0.218	2.141	0.700	1.80	(0.843)	0.200	4.1
Grl. halibut juv	0.52	(1.617)	0.900	3.40	0.950	0.115	4.0
Redfish > 14cm	0.52	0.070	(1.099)	2.50	0.950	0.000	3.7
Redfish juv	0.52	0.331	(1.955)	5.00	0.950	0.018	3.6
Polar cod	1	(2.513)	1.000	5.00	0.950	0.119	3.4
Thorny ray	1	0.034	0.400	1.30	(0.190)	0.000	3.0
Long rough dab	0.52	(0.105)	0.600	2.00	0.950	-0.012	3.0
Other pelagic fish	1	3.636	1.100	2.50	(0.943)	0.000	3.5
Other bottom fish	1	(1.776)	0.600	2.00	0.950	0.000	3.3
Northern shrimp	0.52	3.307	0.900	6.00	(0.916)	0.000	2.7
Benthos	1	85.000	1.500	9.75	(0.498)	0.000	2.2
Squid	1	(0.376)	2.440	6.00	0.950	0.000	3.6
Large Zooplankton	1	25.000	4.000	15.00	(0.713)	0.000	2.6
Small Zooplankton	1	15.000	20.000	50.00	(0.904)	0.000	2.0
Phytoplankton	1	20.000	50.000	-	(0.790)	0.000	1.0
Detritus	1	-	-	-	(0.904)	-	-

**Table 2.** Diet matrix for the West Greenland ecosystem model

Group		Predator																			
Prey	1	2	3	4	5	6	7	8	9	10	11	12	13	14	15	16	17	18	19	20	
<b>1</b>	Baleen whales																				
<b>2</b>	Toothed mammals																				
<b>3</b>	Seals		0.010																		
<b>4</b>	Seabirds																				
<b>5</b>	Cod 4+																				
<b>6</b>	Cod juv					0.010	0.010														
<b>7</b>	Grl. halibut 5+		0.040																		
<b>8</b>	Grl. halibut juv		0.050	0.050				0.005	0.050	0.010	0.030										
<b>9</b>	Redfish > 14cm		0.020	0.002		0.010		0.005													
<b>10</b>	Redfish juv		0.010	0.005		0.050	0.050	0.020	0.050	0.030	0.030		0.050		0.010						
<b>11</b>	Polar cod		0.050	0.246	0.053	0.010		0.155	0.050						0.010						
<b>12</b>	Thorny ray																				
<b>13</b>	Long rough dab					0.010		0.005							0.010						
<b>14</b>	Other pelagic fish	0.200	0.295	0.200	0.316	0.240	0.200	0.200	0.200	0.080				0.050	0.010			0.090			
<b>15</b>	Other bottom fish	0.038	0.060	0.047		0.150	0.185	0.210	0.050						0.050						
<b>16</b>	Northern shrimp		0.020	0.020		0.200	0.100	0.150	0.200	0.200	0.030		0.100	0.100	0.050						
<b>17</b>	Benthos		0.050		0.053	0.119	0.205	0.150	0.100	0.050			0.500	0.650	0.060	0.650	0.200	0.070			
<b>18</b>	Squid		0.120	0.030	0.053	0.040		0.100	0.050	0.010	0.080			0.020	0.010			0.010			
<b>19</b>	Large Zooplankton	0.464	0.045	0.100	0.526	0.140	0.200		0.250	0.520	0.610	0.600	0.050	0.600	0.100	0.100	0.040	0.750	0.050		
<b>20</b>	Small Zooplankton	0.069				0.020	0.050			0.100	0.220	0.400		0.270		0.250	0.070	0.150	0.500	0.020	
<b>21</b>	Phytoplankton															0.050	0.020		0.400	0.830	
<b>22</b>	Detritus												0.300	0.250		0.100	0.400	0.800		0.050	0.150
	Import	0.229	0.230	0.300																	

**Table 3.** Catches and discards (t·km<sup>-2</sup>) used in the Ecopath model of West Greenland waters (NAFO area 1) for 1997. Catches are separated by the three main fisheries, with other gear types combined.

Group	Catch (t·km <sup>-2</sup> )				Total	Discards (t·km <sup>-2</sup> )		
	Shrimp trawl	Deep water	Coastal gear	Other gear		Shrimp trawl	Deep water	Total
Baleen whales				0.0071	<b>0.0071</b>			
Toothed mammals				0.003	<b>0.003</b>			
Seals				0.0426	<b>0.0426</b>			
Seabirds				0.0017	<b>0.0017</b>			
Cod 4+				0.0037	<b>0.0037</b>			
Cod juv								
Grl. halibut 5+		0.0199	0.0358		<b>0.0558</b>			
Grl. halibut juv						0.0239		<b>0.0239</b>
Redfish > 14cm		0.0045			<b>0.0045</b>	0.0027		<b>0.0027</b>
Redfish juv						0.0240		<b>0.0240</b>
Polar cod						0.0142		<b>0.0142</b>
Thorny ray						0.0026		<b>0.0026</b>
Long rough dab						0.0018		<b>0.0018</b>
Other pelagic fish		0.00067			<b>0.00067</b>	0.0035		<b>0.0035</b>
Other bottom fish		0.01847			<b>0.01847</b>	0.0113	0.0009	<b>0.0123</b>
Northern shrimp	0.2666				<b>0.2666</b>	0.0236		<b>0.0236</b>
Benthos				0.0134	<b>0.0134</b>			
Squid						0.0009		<b>0.0009</b>
Total	<b>0.2666</b>	<b>0.0436</b>	<b>0.0358</b>	<b>0.0716</b>	<b>0.4176</b>	<b>0.1085</b>	<b>0.0009</b>	<b>0.1094</b>

## Input data by Ecopath group (Tables 1-3)

### Group 1. Baleen whales

The species composition of the three marine mammal groups occurring in West Greenland waters are listed in Table 4, based on Mosbech *et al.* (1998).

**Table 4.** List of species of marine mammals included in the model of the West Greenland marine ecosystem model, separated into their Ecopath groups.

---

#### Baleen Whales

Blue whale (*Balaenoptera musculus*)  
 Bowhead whale (*Balaena mysticetus*)  
 Fin whale (*Balaenoptera physalus*)  
 Humpback whale (*Megaptera novaeangliae*)  
 Minke whale (*Balaenoptera acutorostrata*)  
 Sei whale (*Balaenoptera borealis*)

#### Toothed Whales

Atlantic white-sided dolphin  
 (*Lagenorhynchus obliquidens*)  
 Bottlenose whale (*Hyperoodon ampullatus*)  
 Harbour porpoise (*Phocoena phocoena*)  
 Killer whale (*Orcinus orca*)  
 Narwhal (*Monodon monoceros*)  
 Pilot whale (*Globicephala melaena*)  
 Sperm whale (*Physeter macrocephalus*)  
 White-beaked dolphin (*Lagenorhynchus albirostris*)  
 White whale (*Delphinapterus leucas*)

#### Seals

Bearded seal (*Erignathus barbatus*)  
 Harbour seal (*Phoca vitulina*)  
 Harp seal (*Phoca groenlandica*)  
 Hooded seal (*Cystophora cristata*)  
 Ringed seal (*Phoca hispida*)  
 Walrus (*Odobenus rosmarus*)

---

The catch of 1,710 tonnes was obtained from Mosbech *et al.* (1998) as the average annual catch for the years 1994-1996. The biomass was calculated based on summer abundance and average weights by species from Table 5.124 in Born (1999). The natural mortality estimate was based on Bundy *et al.* (2000), while the Q/B estimate was based on the Norwegian Ecopath model (Dommasnes *et al.*, this volume).

The dietary information was derived from Mosbech *et al.* (1998) and Vikingsson and Kapel (2000). As whale biomass was based on summer abundance, lower concentrations of animals were assumed for

winter. Therefore, the food taken by migrant whales during winter is treated in the model as an import, and here it is assumed that approximately 20% of the diet is import.

### Group 2. Toothed whales

Catches of 727 tonnes were averaged data for the years 1994-1996 based on Mosbech *et al.* (1998). The biomass was calculated based on summer abundance and average weights by species. Exceptions are narwhal and white whale, for which  $\frac{1}{3}$  of the estimated winter abundance was used from Table 5.124 in Born (1999). P/B and Q/B were based on the Norwegian Ecopath model (Dommasnes *et al.*, this volume).

The dietary information was derived from Mosbech *et al.* (1998) and Born (1999). As most whale biomass was based on summer abundance, lower concentrations of most animals were assumed for winter. Therefore, the food taken by migrant whales during winter is treated in the model as an import, and here it is assumed that approximately 20% of the diet is import.

### Group 3. Seals

The reported seal catches of 10,221 tonnes represent an average for the years 1994-1996 (Mosbech *et al.*, 1998). Biomass was calculated based on summer abundance and average weights by species from Table 5.124 in Born (1999).

P/B was based on an assumed total mortality of 7% based on data from the Global Marine Mammal database of the *Sea Around Us* project (see Pauly *et al.*, 1998; Trites and Pauly, 1998). Q/B was based on the Norwegian Ecopath model (Dommasnes *et al.*, this volume). The diet composition for seals was based on Mosbech *et al.* (1998) and Kapel (2000).

### Group 4. Seabirds

The main species of seabirds occurring in West Greenland are listed in Table 5 (Mosbech *et al.*, 1998). The catch of seabirds of 405 tonnes was derived from Mosbech *et al.* (1998). Biomass estimate was calculated from population size estimates (pairs) and average weight by species (and sex) described in Mosbech *et al.* (1998).

P/B was derived from the total mortality estimate based on information in Sakshaug (1995). Q/B was based on the Norwegian Ecopath model (Dommasnes *et al.*, this volume). The diet composition for seals was based on Mosbech *et al.* (1998).

**Table 5.** Main species of seabirds found around West Greenland.**Birds**

Arctic tern (*Sterna paradisaea*)  
 Black guillemot (*Cepphus grylle*)  
 Black-legged kittiwake (*Rissa tridactyla*)  
 Common eider (*Somateria mollissima*)  
 Glaucous gull (*Larus hyperboreus*)  
 Great black-backed gull (*Larus marinus*)  
 Great cormorant (*Phalacrocorax carbo*)  
 Great shearwater (*Puffinus gravis*)  
 Harlequin duck (*Histrionicus histrionicus*)  
 Iceland gull (*Larus glaucooides*)  
 Ivory gull (*Pagophila eburnea*)  
 King eider (*Somateria spectabilis*)  
 Long-tailed duck (*Clangula hyemalis*)  
 Mallard (*Anas platyrhynchos*)  
 Northern fulmar (*Fulmarus glacialis*)  
 Puffin (*Fratercula arctica*)  
 Purple sandpiper (*Calidris maritima*)  
 Razorbill (*Alca torda*)  
 Red-breasted merganser (*Mergus serrator*)  
 Thick-billed murre (*Uria lomvia*)  
 White-tailed eagle (*Haliaeetus albicilla*)

**Group 5. Atlantic Cod 4+ (Gadus morhua)**

This group consists of adult Atlantic cod of 4 years and older, considered to be > 35 cm (Bundy *et al.*, 2000). The 1997 catch of 891 tonnes of adult cod was based on the ICES working group report (Anon., 2000). Biomass was derived from Anon. (2000), based on the annual groundfish survey, and predicted inshore biomass from pound net catches.

The total mortality estimate was based on Sakshaug (1995), and was considered lower than in comparable areas (Bundy *et al.*, 2000; Dommasnes *et al.*, this volume) as no targeted fisheries exists for cod, and catches are essentially incidental by-catches in other gears and the shrimp fishery. Thus, the P/B was estimated at 0.4 year<sup>-1</sup>.

For cod from West Greenland (mean length: 45 cm) feeding mainly on northern shrimp, Köster and Schober (1990) found a gastric evacuation rate of 0.22 g/h at a mean temperature of 3.5°C. From this information an estimate of annual Q/B can be calculated to 2.8 (Christensen *et al.*, 2000).

The diet composition used as input for cod was obtained from stomach content analysis and the literature (Tiedtke, 1988; Köster and Schober, 1990; Schnack *et al.*, 1993; Grundwald and Köster, 1994; E. Grünwald, pers. comm.).

**Group 6. Cod (juvenile)**

Following Bundy *et al.* (2000), juvenile Atlantic cod were defined as of age 0, 1, 2 and 3, and being < 35 cm. There is no known catch of juvenile cod (Anon., 2000). Biomass estimates are from Anon. (2000) based on groundfish survey. The estimates are clearly underestimates, due to the survey sampling gear used, and due to additional inshore juvenile cod biomass of uncertain amount. Therefore, we decided to increase the initial estimate (0.001 t/km<sup>2</sup>) to account for the uncertainties.

Total mortality estimate was based on Bundy *et al.* (2000), and Q/B was based on the Norwegian Ecopath model (Dommasnes *et al.*, this volume). The diet composition data was based on Bundy *et al.* (2000).

**Group 7. Greenland halibut 5+ (Reinhardtius hippoglossoides)**

Adult Greenland halibut consisted of 5 years and older fish. The 1997 deep-water and inshore catches of adult Greenland halibut of 14,000 tonnes were obtained from Jørgensen (2000a) and Simonsen and Boje (2000).

The biomass estimate was based on Jørgensen (2000b). The Jørgensen estimate is most likely an underestimate as it is based on 'trawlable biomass' in NAFO areas 1C & 1D. The estimate was doubled to account for additional, un-surveyed inshore component (e.g. Disko Bay and fjords), which forms part of major coastal fisheries (Simonsen and Boje, 2000).

The P/B ratio was based on data from Simonsen and Boje (2000). For Greenland halibut Q/B was assumed to be 1.8 year<sup>-1</sup> (FishBase 1999). This seems to be a reasonable level although in the lower end of the estimates presented by Yang and Livingston (1988). They estimated daily rations between 0.66 and 1.17% body weight per day. The diet components for Greenland halibut were based on stomach content analysis (Orr and Bowering, 1997).

**Offshore fishery**

Subarea 1: Div. 1B-1F. The offshore fishery in Div. 1B-1F increased from about 900 tonnes in 1987 to about 1,500 tonnes in 1988 and catches remained at that level until 1992 when they increased to 5,550 tonnes. Catches remained at that level until 1995, but decreased to 4,800 tonnes in 1997. Offshore, 3,703 tonnes were taken by mainly Norwegian and Greenlandic trawlers while 1,090 tonnes were taken by Norwegian and Greenlandic longliners. Inshore

catches amounted to 7 tonnes. Almost all the fishery takes place in Div. 1D in the second half of the year.

Subarea 1: Div. 1A. There has been practically no offshore fishing for Greenland halibut in Div. 1A. In 1993, 34 tonnes were taken by a Japanese trawler; in 1994, 18 tonnes by a Greenlandic longliner; in 1995, 13 tonnes by a Japanese trawler. No fishing was carried out in the area in 1996-97.

#### *Inshore fishery*

The main fishing grounds for Greenland halibut in Div. 1A are located inshore. The inshore catches in Div. 1A were around 7,000 tonnes in the late-1980s have increased steadily since, and were almost 20,000 tonnes in 1997. Catches were rather evenly distributed over the year but with a tendency toward higher catches in July and August.

For recruitment, the inshore stock depends on immigration from the offshore nursery grounds and the spawning stock in Davis Strait. Only sporadic spawning seems to occur in the fjords, hence the stock is not considered self-sustainable. This connection between the offshore and inshore stocks implies that reproductive failure in the offshore spawning stock for any reason will have severe implications for the recruitment to the inshore stocks.

Subarea 1: Div. 1A This fishery is mainly a traditional fishery, typically in the inner parts of the ice fjords at depths between 500 to 800 m. Longlines are set from small boats below 20 GRT, or in winter through the ice. In the middle of the 1980s gillnets were introduced to the inshore fishery, and were used more commonly in the following years. In 1989 gillnets and longlines accounted equally for the catches, but since then the annual proportion of catches from each gear has varied considerably. The minimum mesh size allowed was 110 mm (half meshes). Authorities have in recent years tried to discourage the use of gillnets, which has led to an increased proportion of longline catches. Gillnets are banned since the year 2000. There are no regulations on longline fisheries. Longline catches comprised 74% of the total in 1996 and 76% in 1997. There are no quota regulations on the fishery, but from 1998 a license is required to land commercial catches.

Commercial processors pay more for 'large fish' (over 3.3 kg), so 'small fish' are sometimes discarded. Size composition data from the landed catch are therefore biased with respect to the fishable stock.

### **Group 8. Greenland halibut juveniles**

This group comprises juvenile Greenland halibut of ages 0-4 years. In 1997 5,726 tonnes of juvenile Greenland halibut was caught as by-catch by the shrimp fishery, and was discarded. This estimate was based on shrimp survey by-catch data (Kingsley *et al.*, 1999; Engelstoft and Jørgensen, 2000).

A reliable estimate of juvenile biomass was not available, and it was estimated by the model, while P/B and Q/B were based on Bundy *et al.* (2000). The diet components for Greenland halibut were based on stomach content analysis (Bowering *et al.*, 1984; Pedersen and Riget, 1993; Pedersen, 1994; Jørgensen, 1997).

### **Group 9. Redfish larger than 14 cm (Sebastes spp.)**

Two species of redfish are found commonly in West Greenland waters and are pooled here: *Sebastes marinus* and *S. mentella*. The catch by the deep water fisheries of slightly more than 1,000 tonnes in 1997 was based on Siegstad *et al.* (2000). The biomass estimate was based on deep water groundfish survey data (Rätz and Stransky, 2000) for a survey area of 59,205 km<sup>2</sup>, with both *S. mentella* and *S. marinus* pooled. This estimate is assumed to be representative for scaling up to the larger model area (240,000 km<sup>2</sup>).

Total mortality is unknown, and P/B was estimated by the model, while Q/B was derived from an estimate in FishBase (1999). The diet compositions used as input for adult and juvenile redfish was obtained from stomach content analysis and the literature (Pedersen and Riget, 1993; Pedersen, 1994).

### **Group 10. Redfish juvenile**

Juvenile redfish are caught as incidental by-catch (approximately 5,700 tonnes) by the shrimp fishery, and was estimated from shrimp survey by-catch information (Kingsley *et al.*, 1999). The basic biomass estimate was based on shrimp survey data (Kingsley *et al.*, 1999; Engelstoft and Jørgensen, 2000), and was doubled to account for gear selectivity.

No information was available for P/B, and the parameter was allowed to be estimated by the model. By applying the Winberg equation to mean weights of the Barents Sea deep-water redfish, Dolgov and Drevetnyak (1990, 1992) calculated the annual rations (% of body weight) to vary from 470-599% in juvenile redfish to 125-142% at age 19. Therefore, 5.0 year<sup>-1</sup> seems to be a reasonable level

of Q/B for the small redfish in this study. See adult redfish for diet sources.

### **Group 11. Polar cod (*Boreogadus saida*)**

There is no targeted fishery for polar cod, but approximately 3,400 tonnes are taken as by-catch by the shrimp fishery (Kingsley *et al.*, 1999). No reliable estimate of biomass for the model area was available, and the parameter was estimated by the model.

P/B was based on the Norwegian Ecopath model (Dommasnes *et al.*, this volume). Results from evacuation experiments with polar cod indicate that a reasonable level of Q/B for the fish sizes in the present study is about 5.0 year<sup>-1</sup> (J.S. Christiansen, University of Tromsø, Norway, pers. comm.). The diet compositions used as model input for polar cod were based on information from Jensen (1992).

### **Group 12. Thorny ray (*Raja radiata*)**

There is no targeted fishery for thorny ray, but approximately 620 tonnes are taken as by-catch by the shrimp fishery (Kingsley *et al.*, 1999; Siegstad and Rätz, 2000). The basic biomass estimates of Kingsley *et al.* (1999), Engelstoft and Jørgensen (2000) and Rätz and Lloret (1999) were doubled to account for sampling uncertainty.

P/B was approximated from  $F = 0.2 \text{ year}^{-1}$  (Kingsley *et al.*, 1999; Engelstoft and Jørgensen, 2000; Rätz and Lloret, 1999) and  $M = 0.2 \text{ year}^{-1}$  (FishBase, 1999). The consumption/biomass ratio was based on information from Bundy *et al.* (2000). The diet composition information was based on data by Pedersen (1995).

### **Group 13. Long rough Dab (*Hippoglossoides platessoides*)**

There is no targeted fishery for this species, but there is a small by-catch in the shrimp fishery (Kingsley *et al.*, 1999; Siegstad and Rätz, 2000). No reliable estimates of biomass were available and this parameter was estimated by the model. The P/B estimate was based on Rätz and Lloret (1999), and the Q/B value was taken from FishBase (1999). The diet of this species consist mainly of benthic organisms, northern shrimp and detritus (Grünwald, 1992).

### **Group 14. Other pelagic fish**

This groups represents several species, including *Ammodytes dubius*, *A. marinus*, *Mallotus villosus*, *Stomias boa*, *Benthoosema glaciale*, *Alepocephalus* sp., *Arctogadus glacialis*, *Paralepsis coregonoides*, *Chauliodus sloani*, *Serrivormer beani*, as well as other myctophids and paralipids.

A small by-catch is taken as part of the shrimp and deep water fishery (Pedersen and Kannevorff, 1995; Kingsley *et al.*, 1999; O.A. Jørgensen, Greenland Institute of Natural Resources, pers. comm.). The biomass estimate was based on information from P. Kannerwolff (Greenland Institute of Natural resources, pers. comm.) and S.A. Horsted (Former Director of Greenland Fisheries Research Institute, pers. comm.).

P/B and Q/B: The values used were estimated by V. Christensen (University of British Columbia, pers. comm.) based on other Ecopath models from the North Atlantic area. The diet composition for these species was assumed to comprise mainly plankton, other pelagic species, squid and some benthos.

### **Group 15. Other bottom fish**

This group includes numerous species, including *Anarhichas denticulatus*, *A. lupus*, *A. minor*, *Artediellus* sp., *Aspidophoroides monopterygius*, *Bathylagus* sp., *Brosme brosme*, *Careproctus reinhardti*, *Centroscyllium fabricii*, *Cottunculus microps*, *Cottunculus* sp., *Cyclopterus lumpus*, *Eumicrotremus derjugini*, *Eumicrotremus spinosus*, *Gadus ogac*, *Icelus* sp., *Leptagonus decagonus*, *Leptoclinus maculatus*, *Liparis* sp., *Liparis tunicata*, *Lycodes esmarki*, *Lycodes* sp., *Macrourus berglax*, *Melanogrammus aeglefinus*, *Myoxocephalus scorpius*, *Myxine glutinosa*, *Onogadus argentatus*, *O. ensis*, *Paraliparis* sp., *Raja* sp., *R. fyllae*, *R. lintea*, *Somniosus microcephalus*, *Synaphobranchus kaupi*, *Triglops* sp., *T. murray*, *T. nybelini*, *T. pingeli*, stichaeids and lumpenids (Pedersen and Kannevorff, 1995; Rätz, 1999).

The 1997 catch of 4,435 tonnes was obtained from Siegstad and Rätz (2000) and roughly estimated discards from the shrimp fishery (Kingsley *et al.*, 1999). No reliable biomass estimate could be obtained for this group, and the parameter was estimated by the model. P/B and Q/B values were estimated by V. Christensen (pers. comm.). The data on diet for this group were estimated from Pedersen and Riget (1991), Rodriguez-Marin *et al.* (1994) and Torres *et al.* (2000).



### **Group 16. Northern shrimp (*Pandalus borealis*)**

The fishery for northern shrimp is presently the largest fishery in West Greenland waters, with a 1997 catch of 64,000 tonnes (Siegstad, 2000), and a discard of approximately 5,600 tonnes (Kingsley *et al.*, 1999). The biomass estimate from Carlsson and Kannevorff (2000) based on survey data was doubled to account for an unknown fraction of shrimp present in the water-column.

The P/B estimate of 0.9 year<sup>-1</sup> was based on Rønnow (1992), and a personal communication from D.G. Parsons (Science Branch, Dept. of Fisheries and Oceans, St. John's, Newfoundland, Canada), who considers this level of total mortality to be reasonable for the West Greenland shrimp populations. A Q/B value of 6 year<sup>-1</sup> was assumed for the consumption/biomass ratio. The diet of northern shrimps consists mainly of detritus, zooplankton and some benthos (Shumway *et al.* 1985; Hopkins *et al.*, 1989; Ivanova, 2000).

The shrimp stock off West Greenland is distributed in NAFO Div. 0A and Subarea 1 ([www.nafo.ca/imap/map.htm](http://www.nafo.ca/imap/map.htm)) and the entire shrimp stock is assessed as a single population. The Greenland fishery exploits the stock in Subarea 1 (Div. 1A to 1F) in offshore and inshore areas (primarily Disko Bay). The Canadian fishery has been restricted to Div. 0A since 1981.

Two Greenlandic fleet components exploit the stock in Subarea 1: an offshore fleet, which at present consists of 13 large factory trawlers (1,500-3,000 GRT) and a small vessel fleet composed of about 100 vessels below 80 GRT. The offshore fleet component is restricted to offshore areas and by quotas. Internal Transferable Quotas (ITQ) were introduced as a management tool in 1991. With a few exceptions vessels below 80 GRT were unrestricted by areas and quotas until 1997 when catch regulations were introduced also for this fleet component. Since 1986 logbooks have been mandatory for vessels above 50 GRT. Since 1997 logbooks are available for all vessels.

The Canadian fleet exploits the stock component in Div. 0A. Seventeen companies are currently licensed to fish in the area, but in recent years only 6-7 vessels (2,000-4,000 GRT) have participated. Catches are restricted by quotas. Vessel logs are available since 1979.

Overall catches increased until 1992, then decreased from 1993 to 1997. The nominal catch of shrimp in the offshore areas of Subarea 1 and the adjacent part of Subarea 0 (Div. 0A) increased from

less than 1,000 tonnes before 1972 to almost 43,000 tonnes in 1976. Catches fluctuated thereafter and stabilized around a level of 54,000 tonnes during 1985-88, then increased to 66,000 tonnes in 1992 and decreased thereafter to 51,000 tonnes in 1997. The Canadian fishery in Div. 0A amounted to about 2,500 tonnes in 1995 and 1996, declined to 500 tonnes in 1997 and 875 tonnes has been reported up to October 1998. Historically, the fishing grounds in Div. 1B have been the most important. Since 1989, a gradual southward shift in the offshore fishery has taken place, and since 1990 catches in Div. 1C and 1D have exceeded those from Div. 1B. At the end of the 1980s, exploitation began in Div. 1E and 1F, and catches from these areas now account for about 20% of the total catch. The distribution of the fishery has not changed since 1996. The West Greenland inshore shrimp fishery was relatively stable from 1972 to 1987 with estimated catches of 7,000-8,000 tonnes annually (except for 10,000 tonnes in 1974). Inshore catches in recent years have increased to over 20,500 tonnes in 1992, but decreased to 13,500 tonnes in 1997. During the 1990s inshore catches have accounted for about 25% of the total catch in Subarea 1.

### **Group 17. Benthos**

This group contains all benthic invertebrates, including echinoderms, polychaetes, molluscs and miscellaneous crustaceans, nematodes and other meiofauna (Bundy *et al.*, 2000).

The catch of approximately 3,200 tonnes was obtained from the NAFO catch time series ([www.nafo.ca](http://www.nafo.ca)), and comprises mainly snow crab (*Chionoecetes opilio*) and Iceland scallop (*Chlamys islandica*). The biomass estimate was based on information from macrobenthos investigations carried out by the Institut für Meereskunde, University of Kiel, Germany, by Schnack *et al.* (1993) and E. Grünwald (pers. comm.), and assumed to be representative for the whole model area.

P/B and Q/B were based on the Norwegian Ecopath model (Dommasnes *et al.*, this volume). The benthic group was assumed to feed primarily on detritus and plankton, and to a smaller extend on other benthos (Bundy *et al.*, 2000).

### **Group 18. Squids**

The main species of cephalopods included in this group is *Gonatus fabricii*. There is no targeted fishery for squid in the waters off West Greenland, and only small quantities are taken as by-catch by the shrimp fishery (Kingsley *et al.*, 1999). No

reliable estimate of biomass was available, and this parameter was estimated by the model.

P/B and Q/B were based on the Norwegian Ecopath model (Dommasnes *et al.*, this volume). It was assumed that the diet of squid consists to 90% of zooplankton, with the rest being other pelagic fish and cephalopods (Kristensen, 1984).

### **Group 19 and 20. Large and Small Zooplankton**

Large zooplankton consists mainly of animals of or larger than 1 mm, while small zooplankton are components smaller than 1 mm (Pedersen and Smidt, 2000). The biomass of zooplankton were assumed to be similar to the levels as estimated in northern Norway (Hopkins *et al.*, 1989; Bax and Elliassen, 1990). Other parameters were estimated based on information from Dommasnes *et al.* (this volume) and V. Christensen (pers. comm.).

### **Group 21. Phytoplankton**

In Disko Bay (Figure 2), Andersen and Born (1999) measured about 90 C g m<sup>-2</sup> year<sup>-1</sup> – which is approximately 1000 g m<sup>-2</sup> year<sup>-1</sup> wet weight. No other information on phytoplankton biomass or production exists for this area, and the assumed values are based on estimates made for northern Norwegian waters (Hopkins *et al.*, 1989; Bax and Elliassen, 1990).

### **Model balancing**

An ecosystem model of the West Greenland waters ≤ 1,500 m depth as constructed and balanced based on data for the year 1997. Balancing required only moderate changes to initial input data, primarily the percentage distributions within the diet matrix. This model, based on the input parameters summarized in the present report, should be considered a preliminary version, and may be altered should other data become available.

### **CONCLUSIONS**

The primary purpose of this report was to document the input data assembled for an ecosystem model of the West Greenland marine waters. In the future, the model will be used to examine specific questions of interest to the Greenland Institute of Natural Resources. Clearly, the presently used input data should be amended as more precise estimates become available.

No signs of overfishing have been detected for the offshore West Greenland shrimp stock, despite the steady catch increase over the last three decades (Siegstad, 2000). For the year 2001 the NAFO Scientific Council noted that all available indices of size and age composition were favorable, and considered that the stock can sustain an increased catch compared to previous years ([www.nafo.ca](http://www.nafo.ca)). The increase in the West Greenland shrimp catches may well have been possible because of the generally lower abundance of the offshore West Greenland cod population after the 1970s and its virtually disappearance in 1992. In the same period other shrimp predators also showed decreasing trends e.g., redbfish, Atlantic halibut, wolffishes (Rätz, 1999). As marine resources are of major importance to the Greenland economy, the present model can assist in evaluating the effects of various management scenarios on marine resources. Future simulations could also address potential ecosystem level effects and changes due to large scale climatic change.

### **ACKNOWLEDGMENTS**

We would like to acknowledge the Pew Charitable Trusts, Philadelphia, USA, for the funding of the *Sea Around Us* project at the University of British Columbia, Canada. Thanks to Dr. J. S. Christiansen, NCFS, University of Tromsø, Norway, for information on consumption and evacuation in Polar cod and to E. Grünwald, Institut für Meereskunde, Kiel University, Germany, for information on stomach content in cod and mean wet weight of macrobenthos off West Greenland.

## REFERENCES

- Andersen, O.N. and Born, E.W. 1999. De lavere trofiske niveauer. In: Grønlands Økologi – en grundbog. (The Ecology of Greenland – basics). Ed. by Born and Böcher. Grønlands Miljø- og Naturforvaltning, Atuakkiorkfik Undervisning, Nuuk 1999. 431 p. (Danish, available in English in 2001).
- Angantyr, L. A. and Kapel, F.O. 1990. Harp seal feeding habits in Greenland, - our present knowledge, April 1990. Greenland Fisheries Research Institute Technical Report. 45pp + appendices.
- Anon. 1998. Report of the North-western working group. ICES CM/ACFM:19. Part 1 and 2. 350 pp.
- Anon. 1999. NAFO Scientific Council Meeting Reports 1998. 257 pp.
- Anon. 2000. Report of the North-western working group. ICES CM 2000/ACFM:15. Part 1 and 2. 328 pp.
- Bax, N. and Eliassen, J. E. 1990. Multispecies analysis in Balsfjord, Northern Norway: solution and sensitivity analysis of a simple ecosystem model. Journal du Conseil International pour l'Exploration de la Mer, 47: 175-204.
- Boje, J. and Lehmann, K. M. 1994. Selectivity in shrimp trawl codend from an alternate haul experiment. ICES C.M. 1994/B: 12, 8 pp.
- Born, E. W, Heide-Jørgensen, M. P. and Davis, R.A. 1994. The Atlantic walrus (*Odobenus rosmarus*) in West Greenland. Meddr. Grønland, Biosci, 40: 1-33.
- Born, E. W. 1999. Havpattedyr In Grønlands Økologi – en grundbog (The Ecology of Greenland – basics). Ed. by Born and Böcher. Grønlands Miljø- og Naturforvaltning, Atuakkiorkfik Undervisning, Nuuk 1999. 431 p. (In Danish, available in English in 2001).
- Bowering, W. R., D. G. Parsons and G. R. Lilly. 1984. Predation on shrimp (*Pandalus borealis*) by Greenland halibut (*Reinhardtius hippoglossoides*) and Atlantic cod (*Gadus morhua*) off Labrador. ICES C.M. 1984/G:54, 30 pp.
- Buch, E., Horsted, S. A. and Hovgård, H. 1994. Fluctuations in the occurrence of cod in Greenland waters and their possible causes. ICES Marine Science Symposia, 198: 158-174.
- Carlsson, D.M. and P. Kannerworf. 2000. Stratified-random trawl survey for Northern shrimp (*Pandalus borealis*) in NAFO Subarea 0 & 1 in 2000. NAFO Scientific Council Report No. 78, serial No. N4335, 28 pp.
- Christensen, V., and Walters, C. J. 2000. Ecosim with Ecosim: methods, capabilities and limitations. p. 79-105 In: Methods for evaluating the impacts of fisheries on the North Atlantic ecosystems. Ed. by Pauly, D., and Pitcher, T. Fisheries Centre Research Reports 8(2).
- Christensen, V., Walters, C. J. and Pauly, D. 2000. Ecosim and Ecosim: A user's guide, October 2000 Edition. Fisheries Centre, University of British Columbia Vancouver, Canada and ICLARM, Penang, Malaysia. 130 pp. (available from: [www.ecosim.org](http://www.ecosim.org))
- Dickson, W. 1993. Estimation of the capture efficiency of trawl gear. II: Testing a theoretical model. Fisheries Research, 16: 255-272.
- Dolgov, A.V. and Drevetnyak, K.V. 1990. Estimation of rations and food consumption of deep-water redfish (*Sebastes mentella*) from the Norwegian-Barents Sea stock. ICES CM 1990/G:11, 15 pp.
- Dolgov, A.V. and Drevetnyak, K.V. 1992. Food requirements of the Barents Sea *Sebastes mentella*. In: Interrelations between fish populations in the Barents Sea. S. Proceedings of the fifth PINRO-IMR Symposium Murmansk, 12-16 Ed. by Bogstad, B. and Tjelmeland, August 1991: 193-204.
- Engelstoft, J. J. and Jørgensen, O. 2000. Biomass and Abundance of Demersal Fish Stocks off West Greenland Estimated from the Greenland Shrimp Survey, 1988-1999. NAFO Scientific Council Report No. 22, serial No. N4251, 20 pp.
- Engås, A. and Godø, O.R. 1986. Influence of trawl geometry and vertical distribution of fish on sampling with bottom trawl. Journal of Northwestern Atlantic Fisheries Science 7: 35-42.
- Engås, A. and Godø, O.R. 1989a. The effect of different sweep lengths on the length composition of bottom-sampling trawl catches. Journal du Conseil International pour l'Exploration de la Mer, 45: 263-268.
- Engås, A. and Godø, O.R. 1989b. Escape of fish under the fishing line of a Norwegian sampling trawl and its influence on survey results. Journal du Conseil International pour l'Exploration de la Mer, 45: 269-276.
- Evans, P.G.H. 1984. The seabirds of Greenland: Their status and conservation. In: Status and conservation of the World's seabirds, pp 49-84. Ed. by Croxall, J.P., Evans, P.G.H. and Schreiber, R.W. International Council for Bird Preservation Technical Publication No. 2, Cambridge.
- Falk, K. and Durinck, J. 1992. Thick-billed murre hunting in West Greenland, 1988-89. Arctic, 45: 167-178.
- Falk, K. and Kampp, K. 1992. Havfugle ved Vestgrønland - en opdateret oversigt/Sea birds at West Greenland - an updated review. Report, Ornis Consult/Zoologisk Museum, Copenhagen: 24 pp. + maps. (in Danish).
- Falk, K. and Durinck, J. 1993. The winter diet of thick-billed murre, *Uria lomvia*, in western Greenland, 1988-1989. Canadian Journal of Zoology, 71: 264-272.
- FishBase 1999. A global information system on fishes. [www.fishbase.org](http://www.fishbase.org)
- Frimer, O. 1993. Occurrence and distribution of king eider (*Somateria spectabilis*) and common eider (*S. mollissima*), West Greenland. Polar Research, 12: 111-116.
- Godø, O. R. and Engås, A. 1989. Swept area variation with depth and its influence on abundance indices of groundfish from trawl surveys. Journal of Northwestern Atlantic Fisheries Science, 9: 133-139.
- Godø, O. R. and Westpestad, V. G. 1993. Monitoring changes in abundance of gadoids with varying availability to trawl and acoustic surveys. ICES Journal of Marine Science, 50: 39-51.
- Grünwald, E. 1992. Nahrungsökologie der Doggerscharbe (*Hippoglossoides platessoides* Fabr.) im Seegebiet vor West-Grönland. Diplomarbeit, Institut für Meereskunde, University of Kiel. 99 pp. (In German).
- Grünwald, E. 1998. Nahrungsökologische Untersuchungen an Fischbeständen im Seegebiet vor Westgrönland. Doctoral thesis, Christian-Albrechts-Universität, Kiel. 208 pp. (In German).
- Grünwald, E. and Köster, F. 1994. Feeding habits of Atlantic cod in West Greenland waters. ICES CM 1994/P:5, 19 pp.
- Heide-Jørgensen, M. P., Lassen, H., Teilmann, J. and Davis, R.A. 1993. An index of relative abundance of wintering Belugas, *Delphinapterus leucas*, and Narwhals, *Monodon monoceros*, off West Greenland. Canadian Journal of Fisheries Science, 50(11): 2323-2335.
- Heide-Jørgensen, M. P. 1994. Distribution, exploitation and population status of white whales (*Delphinapterus leucas*) and narwhals (*Monodon monoceros*). Meddr. Grønland, Bioscience, 39:133-148.
- Hopkins, C. C. E., Grotnes, P. E. and Eliassen, J.-E. 1989. Organization of a fjord community at 70° north: The pelagic food web in Balsfjord, Northern Norway. Rapports et Procès-Verbaux des Réunions du Conseil International pour l'Exploration de la Mer. 188: 146-153.
- Horsted, S. A. 1989. Some features of oceanographic and biological conditions in Greenland waters. In: Proceedings of the sixth conference of the comité arctique international 13-15 May 1985, 456-476. Ed. by Louis Rey and Vera Alexander. E. J. Brill. Leiden, New York, København, Köln.
- Horsted, S. A. 2001. A Review of the Cod Fisheries at Greenland, 1910-1995. Journal of Northwest Atlantic Fisheries Science 28: 1-109.

- Horsted, S. A. and Smidt, E. 1965. Remarks on effects of food animals on cod behavior. ICNAF Special Publication No. 6: 435-437.
- Ivanova, I. V. 2000. About *Pandalus borealis* (Krøyer, 1848) nutrition on Flemish Cap. NAFO Scientific Council Report No. 65, serial No. N4307. 8 pp.
- Isaksen, B., Valdemarsen, J.W. and Larsen, R.B. 1990. Reduction of fish bycatch in shrimp trawl using a solid separator grid in the aft belly. ICES C.M. 1990/B:47, 13 pp.
- Jensen, Ad. S. 1925. On the fishery of the greenlanders. Meddelelser fra Kommissionen for Havundersøgelser. Serie: Fiskeri, Bind VII, Nr. 7. København. C.A. Reitzel, Boghandel. 39 pp.
- Jensen, Ad. S. 1939. Concerning a change of climate during recent decades in the Arctic and subarctic regions, from Greenland in west to Eurasia in the east, and contemporary biological and geophysical changes. Det Kgl. Danske Videnskaberne Selskab. Biologiske Meddelelser XIV,8. København. Munksgaard. 75 pp. with 2 charts.
- Jensen, D. 1992. Polar cod from the Davis Strait and Arctic Canada. Master thesis, University of Copenhagen 1992. 114 pp. (in Danish).
- Jørgensen, O. A. 1997. Pelagic occurrence of Greenland halibut, *Reinhardtius hippoglossoides* (Walbaum), in West Greenland waters. Journal Northwestern Atlantic Fisheries Science, 21: 39-50.
- Jørgensen, O. A. 2000a. Assessment of the Greenland Halibut Stock Component in NAFO Subarea 0 + Div. 1A Offshore + Divisions 1B-1F. NAFO Scientific Council Report No. 38, serial No. N4267. 20 pp.
- Jørgensen, O. A. 2000b. Survey for Greenland Halibut in NAFO Divisions 1C-1D, 1999. NAFO Scientific Council Report No. 10, serial No. N4232. 26 pp.
- Kapel, F. 1979. Exploitation of large whales in West Greenland in the Twentieth Century. Report of the International Whaling Commission No. 29. (SC/30/Doc 23): 197-214.
- Kapel, F. 1993. A note on the variations in the catch of seals and purchase of seal skins in Greenland, 1971-1992. In Document presented at joint ICES/NAFO Working Group on Harp and Hooded Seals, 1993. 7 pp.
- Kapel, F.O. 2000. Feeding habits of harp and hooded seals in Greenland waters. NAMMCO Science Publication 2: 50-64.
- Kingsley, M.C.S., Kannevorff, P. and Carlsson, D.M. 1999. Bycatches of Fish in the West Greenland Shrimp Survey: an Initial Analysis. NAFO SCR Document no. 111, serial No. N4191, 7 pp.
- Kristensen, T.K. 1984. Biology of the squid *Gonatus fabricii* (Lichtenstein, 1818) from West Greenland waters. Meddelelser om Grønland, Bioscience, 13:1-17.
- Köster, F.W. and Schober, W. 1990. Cod stomach sampling in West Greenland waters 1989 - Some preliminary results. NAFO Scientific Council Report no. 33, serial No. N1750. 13 pp.
- Larsen, R.B., Kristjánsson, J. and Marteinsson, J.E. 1993. Vertical size distribution of shrimps (*Pandalus borealis*) in the water column 0 to 8 m off the seabed. ICES Marine Science Symposium, 196: 207-210.
- Livingston, P. A., and Tjelmeland, S. 2000. Fisheries in boreal ecosystems. ICES Journal of Marine Science, 57: 619-627.
- Mosbech, A., Boertmann, D., Nymand, J., Riget, F., and Acquarone, M. 1998. The marine environment in Southwest Greenland. National Environmental Research Institute, Denmark. NERI Technical Report no. 236, 205 pp.
- Nilssen, E. M., Larsen, R.B., and Hopkins, C.C.E. 1986. Catch and size-selection of *Pandalus borealis* in a bottom trawl and implications for population dynamics analyses. ICES CM 1986/K:4, 12 pp.
- Orr, D. C. and Bowering, W. R. 1997. A multivariate analysis of food and feeding trends among Greenland halibut (*Reinhardtius hippoglossoides*) samples in Davis Strait, during 1986. ICES Journal of Marine Science, 54: 819-829.
- Pauly, D., Trites, A. W., Capuli, E., and Christensen, V. 1998. Diet composition and trophic levels of marine mammals. ICES Journal of Marine Science, 55: 467-481.
- Pauly, D., Palomares, L., Froese, R., Sa-a, P., Vakily, M., Preikshot, D., and Wallace, S. 2001. Fishing down Canadian aquatic food webs. Canadian Journal of Fisheries and Aquatic Sciences, 58 (1) :51-62
- Pedersen, S. A., 1990. Redfish (*Sebastes* spp.) in Greenland waters/"Rødfisk (*Sebastes* spp.) ved Grønland". Rapport til Grønlands Hjemmestyre fra Grønlands Fiskeriundersøgelser. 103 pp (in Danish).
- Pedersen, S. A. 1994. Shrimp trawl catches and stomach contents of redfish, Greenland halibut and starry ray from West Greenland during a 24-hour cycle. Polar Research, 13: 183-196.
- Pedersen, S. A. 1995. Feeding habits of starry ray (*Raja radiata*) in West Greenland waters. ICES Journal of Marine Science, 52: 43-54.
- Pedersen, S. A. and Riget, F. 1991. Preliminary studies on feeding habits of demersal fish species in West Greenland waters with special emphasis on predation on shrimp. NAFO Scientific Council Report No. 47, serial No. N1930.
- Pedersen, S.A. and Riget, F. 1993. Feeding habits of redfish (*Sebastes* spp.) and Greenland halibut (*Reinhardtius hippoglossoides*) in West Greenland waters. ICES Journal of Marine Science, 50: 445-459.
- Pedersen, S.A. and Kannevorff, P. 1995. Fishes on the West Greenland shrimp grounds, 1988-1992. ICES Journal of Marine Science, 52: 165-182.
- Pedersen, S.A. and Smidt, E.L.B. 2000. Zooplankton distribution and abundance in West Greenland waters, 1950-1984. Journal of Northwestern Atlantic Fisheries Science, 26, 45-102.
- Reid, P. C., Battle, E. J. V., Batten, S. D., and Brander, K. M. 2000. Impacts of fisheries on plankton community structure. ICES Journal of Marine Science, 57: 495-502.
- Rätz, H.J. 1992. Decrease in the fish biomass of West Greenland (Subdivisions 1B-1F), continued. NAFO Scientific Council Report No. 40, serial No. N2088.
- Rätz, H. J., 1999. Structures and changes of the demersal fish assemblage off Greenland, 1982-96. NAFO Science Council Studies, No. 32: 1-15.
- Rätz, H.J., and Stransky, C. 1999. Assessment of Redfish (*Sebastes marinus*, *S. mentella*) in NAFO Subarea 1 and ICES Div. XIVb Based on Survey Indices, 1982-98. NAFO Scientific Council Report No. 20, serial No. N4070. 22 pp.
- Riget, F. and J. Boje 1989. Fishery and some biological aspects of Greenland halibut (*Reinhardtius hippoglossoides*) in West Greenland waters. NAFO Scientific Council Studies No. 13: 41-52.
- Rodriguez-Marin, E., Punzón, A., Paz, J. and Olosa, I. 1994. Feeding of most abundant fish species in Flemish Cap in summer 1993. NAFO Scientific Council Report No. 35, serial No. N2403, 33 pp.
- Rønnow, B. 1992. Analysis of the catch curves for *Pandalus borealis* in Disko Bay, West Greenland. NAFO Scientific Council Report No. 54, serial No. N2107.
- Sakshaug, E. 1995. A synopsis of the biomass distribution and energetics of the pelagic ecosystem of the Barents Sea. ICES C.M. CM 1995/Mini:3. 11 pp.
- Schnack, D., Köster, F. W., Rätz, H. -J., Wieland, K., Fürderer, H., Grünwald, E., Zarkeschwari, N. 1993. Wissenschaftliche Grundlagen für Ökosystem-orientiertes Fischereimanagement in Gewässern vor Grönland. Berichte aus dem Institut für Meereskunde an der Christian-Albrechts-Universität, Kiel, No. 234. 134 pp.
- Shumway, S. E., Perkins, H. C., Shick, D.F. and Stickney, A.P. 1985. Synopsis of biological data on the pink shrimp,

- Pandalus borealis* Krøyer, 1838. NOAA Technical Report NMFS 30 (FAO Fisheries Synopsis No. 144). 57 pp.
- Siegstad, H. 1993. An estimate of shrimp discard from factory trawlers in Davis Strait 1992. NAFO Scientific Council Report No. 79, serial No. N2264, 8 pp.
- Siegstad, H. 2000. Preliminary Assessment of Shrimp (*Pandalus borealis*) in Davis Strait, 2000 (Subareas 0+1). NAFO Scientific Council Report No. 84, serial No. N4341. 22 pp.
- Siegstad; H. and Rätz, H. J. 2000. Stock Status Update of Other Finfish in NAFO Subarea 1 NAFO Scientific Council Report No. 27, serial No. N4256. 5 pp.
- Siegstad; H., Rätz, H. J. and Stransky, C. 2000. Stock Status Update of Redfish in NAFO Subarea 1. NAFO Scientific Council Report No. 28, serial No. N4257. 7 pp.
- Simonsen and Boje 2000. An Assessment of the Greenland Halibut Stock Component in NAFO Division 1A Inshore. NAFO Scientific Council Report No. 47, serial No. N4278. 36 pp.
- Smidt, E. L. B. 1969. The Greenland Halibut *Reinhardtius hippoglossoides* (Walb.). Biology and exploitation in Greenland waters. Meddelelser fra Danmarks Fiskeri og Havundersøgelser N.S., (København). 6(4): 79-148.
- Sparholt, H. and Vinther, M. 1991. The biomass of starry ray (*Raja radiata*) in the North Sea. ICES Journal of Marine Science, 47: 295-302.
- Tiedtke, J. E. 1988. Qualitative und quantitative Untersuchungen des Mageninhaltess vom Kabeljau (*Gadus morhua* L.) aus westgrönlandischen Gewässern. Mitteilungen aus dem Institut für Seefischerei der Bundesforschungsanstalt für Fischerei, Hamburg. No. 43. 106 pp. (in German).
- Torres, P., Rodriguez-Marin, E. and Loureiro, I. 2000. Preliminary Results From Feeding Analysis for the Most Abundant Demersal Fishes in Flemish Cap During Summer (1993-2000). NAFO SCR. Document No. 60, serial No. N4302. 9 pp.
- Trites, A. W., and Pauly, D. 1998. Estimating mean body masses of marine mammals from maximum body lengths. Canadian Journal of Zoology, 76: 886-896.
- Valdemarsen, J.W., Lehman, K., Riget, F. and Boje, J. 1993. Grid devices to select shrimp size in trawls. ICES C.M. 1993/B: 35.
- Vikingsson, G. A. and Kapel, F. O. 2000. Introduction. In Minke whales, harp and hooded seals: Major predators in the North Atlantic Ecosystem, pp 5-8. Ed. by G. A. Vikingsson and F. O. Kapel. NAMMCO Science Publications, No. 2.
- Yang, M. S. and Livingston, P. A. 1988. Food habits and daily ration of Greenland halibut, *Reinhardtius hippoglossoides*, in the eastern Bering Sea. Fishery Bulletin, 86(4):675-690.

## THE GULF OF MAINE, 1977-1986

**Johanna J. Heymans**

Fisheries Centre, University of British Columbia,  
2204 Main Mall, Vancouver BC, Canada, V6T 1Z4  
e-mail: s.heymans@fisheries.ubc.ca

### ABSTRACT

An Ecopath model of the Gulf of Maine and Georges Banks area was constructed mainly using information for the time period 1977-1986, which is well covered, notably by a monograph by R.H. Backus and D.W. Bourne, published in 1987. The present model consists of 29 functional groups consisting of seabirds, two groups of mammal, 17 of fish, 5 of invertebrates, one primary producer and one detritus compartment. The paper documents the construction of the model, which will form the basis for dynamic (Ecosim) modeling of the Gulf of Maine and Georges Banks in the near future.

### INTRODUCTION

This report describes the Ecopath model constructed for the United States section of the Gulf of Maine (GOM, Figure 1) including the Georges Banks area for the period 1977 to 1986. The GOM is a semi-enclosed area of 103,000 km<sup>2</sup> (1.03 x 10<sup>11</sup> m<sup>2</sup>, Townsend 1998) and has an average depth of 150 meters (O'Brien, 1999). However, the US section of the GOM has been reported to be 90,700 km<sup>2</sup> (Stevenson and Braash, 1994) and that is the area that will be used in this model. The Georges Banks (GB) area is approximately 53,000 km<sup>2</sup> and has an average depth of over 50 m (Sissenwine *et al.*, 1984). The model is broken down into 29 distinct functional groups.

Unless otherwise specified, catches were obtained from the NMFS database (Ryan *et al.*, 2001) and averaged for the period 1977 to 1986. Bycatch were estimated at about 22% of annual fisheries landings (Garthe *et al.*, 1996), although some estimates are 10-20 times higher than commercial landings (Raloff, 1996).

The production (P/B) and consumption (Q/B) per biomass, as well as mortalities (M, F, Z) are expressed per year throughout the paper. Similarly, we used annual catches and by-catch unless otherwise noted.

## MODEL PARAMETERIZATION

### Seabirds (Group 1)

Powers and Brown (1987) recorded the biomass of various species of birds, including the three loons, two albatrosses, the northern fulmar (*Fulmarus glacialis*), five shearwaters, three storm petrels, the northern gannet (*Sula bassanus*), red phalarope (*Phalaropus fulicaria*), three jaegers, two skuas and eight gull species. Dietary information was only available for the species that occur on the Georges Bank, including Cory's shearwater (*Calonectris diomedea*), greater shearwater (*Puffinus gravis*), sooty shearwater (*P. griseus*), Wilson's storm-petrel (*Oceanites oceanicus*), Leach's storm-petrel (*Oceanodroma leucorhoa*), great black-backed gull (*Larus marinus*), herring gull (*L. argentatus*), and black-legged kittiwake (*Rissa tridactyla*, Powers and Backus, 1987).

Biomass estimates for Georges Banks and GOM were estimated from Powers and Brown (1987) and weighted by area (Table 1). A P/B value of 0.5 year<sup>-1</sup> was assumed, based on data from the other areas (V. Christensen, Fisheries Centre UBC, pers. comm.).

**Table 1.** Seasonal biomass of seabirds in the Gulf of Maine and Georges Banks areas in kg·km<sup>-2</sup> (Powers and Brown 1987).

Season	Gulf of Maine	Georges Banks	Total
Winter	16.7	16.1	32.8
Spring	11.8	12.5	24.3
Summer	13.4	37.3	50.7
Fall	43.0	15.0	58.0
Average	21.2	20.2	41.4
Area	90,700	53,000	143,700
Biomass (kg·km <sup>-2</sup> )	13.397	13.397	20.856
Biomass (t·km <sup>-2</sup> )	0.013	0.007	0.021

Annual consumption of common seabirds on the Georges Banks were estimated at 2.145 kcal·m<sup>-2</sup> by Powers and Backus (1987, Table 35.3) Given a conversion factor of 5 kcal = 1 g dry weight (Nishiyama, 1977, as cited in Powers and Backus, 1987) and a wet weight to dry weight conversion factor of 1 g wet weight = 0.27 g dry weight (Wiens and Scott, 1975) the resulting Q/B is 76.2 year<sup>-1</sup>. Powers and Backus (1987) corrected daily energy requirements for assimilation by assuming that 0.75 of each calorie ingested was assimilated (Kendeigh, *et al.*, 1977).

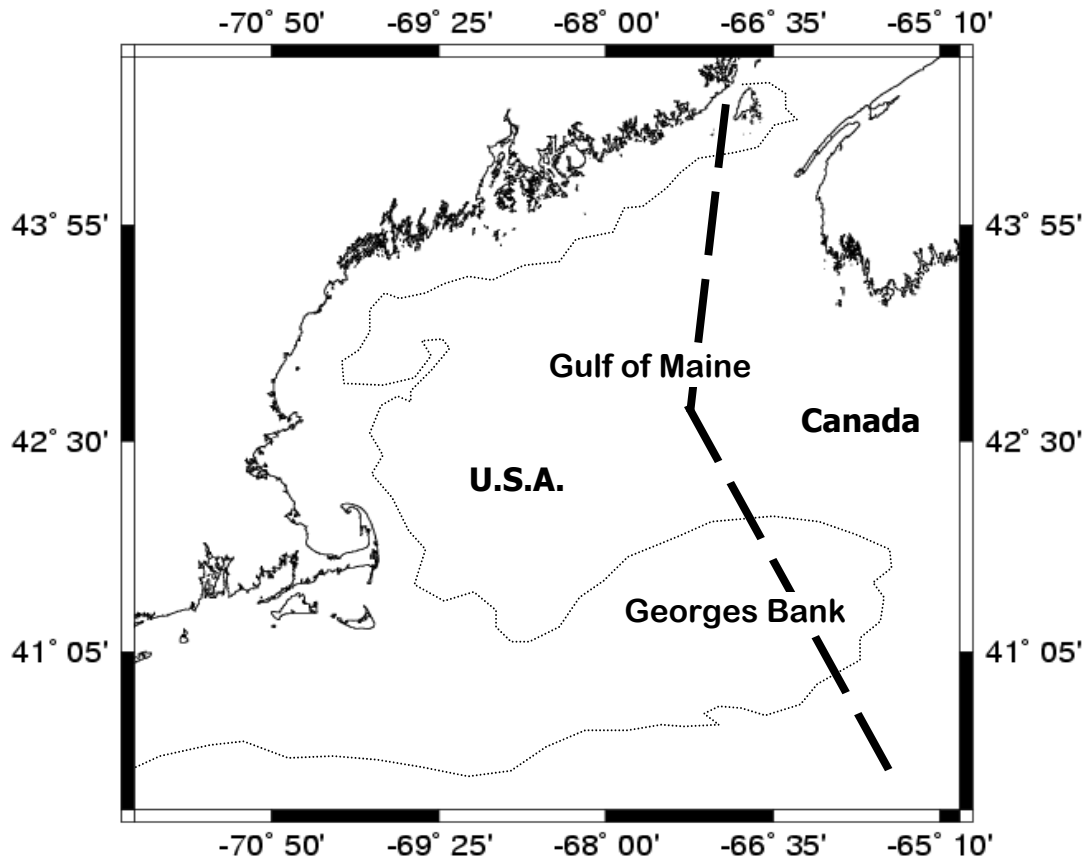

**Figure 1.** Map of the Gulf of Maine, including the Georges Bank, and showing the Canada-U.S.A. border. The study site includes only the U.S. sections of the Gulf of Maine and Georges Bank.

Powers and Backus (1987, Table 35.3) described the major food groups and breakdown of annual consumption of seabirds on the Georges Banks. The resulting quantitative diet composition is shown in Table 2.

**Table 2.** Diet of major seabirds on Georges Banks (adapted from Powers and Backus, 1987).

Group	% of diet
Small demersal feeders (sand lance)	0.122
Small pelagic feeders (saury & <i>Peprilus triacanthus</i> )	0.244
Other (small pelagics)	0.023
Large demersal feeders ( <i>Merluccius bilinearis</i> )	0.122
Squids	0.263
Macrozooplankton (Euphausiids)	0.205
Benthos (amphipods & isopods)	0.014
Shrimps	0.005
Microzooplankton (copepods)	0.002

### **Cetaceans (Group 2)**

Georges Bank serves as a regular or occasional habitat for more than 18 species of whales, dolphins and porpoises, with the most common large whales being fin (*Balaenoptera physalus*) and the most common small whale being the white-sided dolphin (*Lagenorhynchus acutus*) (Winn *et al.* 1987). Estimates of abundance and food requirements were made by Winn *et al.* (1987) of these whales, as well as for sei whales (*B. borealis*), minke whales (*B. acutorostrata*), humpback whales (*Megaptera novaengliae*), right whales (*Eubalaena glacialis*), sperm whales (*Physeter catodon*) and other unidentified and uncommon large whales, which may include killer whales (*Orcinus orca*) and the northern bottlenose whales (*Hyperoodon ampullatus*). Biomass estimates of the smaller whales include the pilot whale (*Globicephala melaena*), white-sided dolphins, harbor porpoise (*Phocoena*

*phocoena*), saddleback dolphin (*Delphinus delphis*), bottlenose dolphin (*Tursiops truncatus*), while other unidentified and uncommon small whales included the grampus (*Grampus griseus*), striped dolphin (*Stenella coeruleoalba*), beaked whales (*Mesoplodon* spp.), spotted dolphins (*Stenella* spp.), and white-beaked dolphins (*Lagenorhynchus albirostris*) (Winn *et al.* 1987).

Kenney *et al.* (1997) calculated the biomass of all whales, dolphins and porpoises for the period 1979-82 by using the average areas of 72,054 km<sup>2</sup> for the Gulf of Maine and 69,004 km<sup>2</sup> for Georges Banks (Table 3). The consumption by cetaceans on Georges Banks and in the Gulf of Maine was calculated by Kenney *et al.* (1997) for the four seasons, corrected for dive times and metabolic rate, for a total annual consumption of approximately 8.5 tonnes wet weight·km<sup>-2</sup> (Table 4), which yielded a Q/B ratio of 9.231 year<sup>-1</sup>. Cohen and Grosslein (1987) gave a transfer efficiency (GE or P/Q ratio) of 16% for cetaceans.

**Table 3.** Biomass (kg·km<sup>-2</sup>) estimates of the cetaceans in the Gulf of Maine/Georges Banks area for 1979-1982 (Kenney *et al.* 1997)

	Gulf of Maine	Georges Banks	Average
Winter	14	463	238.5
Spring	1239	1756	1497.5
Summer	2055	720	1387.5
Autumn	741	362	551.5
Average	1,012.25	825.25	918.75
Biomass (t·km <sup>-2</sup> )	1.01225	0.82525	0.91875

**Table 4.** Diet of cetaceans in the Gulf of Maine and Georges Banks.

Diet	Gulf of Maine	Georges Banks	Total	percentage
Fish	546,825	331,577	878,402	73.42
Squid	9,620	100,074	109,694	9.17
Zooplankton	81,344	126,893	208,237	17.41
Total (t)	637,789	558,544	1,196,333	100
Consumption (t·km <sup>-2</sup> )	-	-	8.481143	-
Q/B	-	-	9.231176	-

**Table 5.** Diet (in percentage) of cetaceans in Newfoundland (from Bundy *et al.* 2000).

Diet	Humpback	Fin	Minke	Sei	Sperm	Pilot	Mean
Cod < 35 cm	0	0	5	0	0	13	3
Demersal feeders large	0	0	0	0	20	0	3
Demersal feeders small	0	0	0	0	20	0	3
Sandlance (small demersals)	8	8	0	8	0	0	4
Capelin (small pelagics)	75	75	75	8	0	12	41
Small piscivorous pelagics	8	0	5	0	55	75	24
Small planktivorous pelagics	0	8	10	0	55	0	4
Macrozooplankton	8	8	5	8	0	0	5
Microzooplankton	0	0	0	75	0	0	13

Bundy *et al.* (2000) derived the diet composition of various cetaceans for the Newfoundland-Labrador Shelf for the period 1985-1987 based on various reports. The species found in Newfoundland also occurring in the Gulf of Maine and on Georges Banks are the humpback, fin, minke, sei, sperm and pilot whales, and their diets are given in Table 5. Kenney *et al.* (1997) gave the breakdown of the diets of cetaceans in the Gulf of Maine and Georges Banks (Table 5), which corresponds to that shown in Bundy *et al.* (2000) – at least the zooplankton does. Thus the diet of cetaceans used by Bundy *et al.* (2000) was used for this group, except that squids were separated from the small pelagic feeders (see Table 6).

**Table 6.** Diet of cetaceans in the Gulf of Maine and Georges Banks (based on Bundy *et al.* 2000, and Kenney *et al.* 1997).

Diet	Mean (%)
Cod < 35	2.9
Large demersal feeders	3.3
Small demersal feeders	7.5
Small pelagic feeders	59.6
Macrozooplankton	5.0
Microzooplankton	12.5
Squid	9.2



**Harbor seals (Group 3)**

Payne and Selzer (1989) gave abundance values for harbor seals (*Phoca vitulina concolor*) off New Hampshire and Massachusetts (including south of Cape Cod) for 1983-1987 and this estimate is used to include the Maine population instead of the Southern New England population. The average abundance was 3,555 seals, which translated in a biomass of 0.0016 tonnes wet weight·km<sup>-2</sup> when using the average body mass of 58.4 kg for females and 68.8 kg for males (average = 63.6 kg) (Trites and Pauly 1998), and the average area of 143,700 km<sup>2</sup> (Stevenson and Braash, 1994; Sissenwine *et al.*, 1984).

Banse and Mosher (1980) gave a P/B value of 1.11 x Mkcal<sup>-0.33</sup> for mammals, where Mkcal is the average weight in kilocalories, which is 1.5 times the weight in kg (63.6 kg from Trites and Pauly, 1998), thus P/B is 0.247 year<sup>-1</sup>.

Hammill and Stenson (2000) give the total population abundance of harbor seals in Atlantic Canada in 1996 as 31,900. Using the average weight of 63.6 kg (Trites and Pauly, 1998) the biomass obtained was 2,029 tonnes. The authors also estimated total consumption for 1996 at 6,207 tonnes, thus Q/B is 3.1 year<sup>-1</sup>. Harbour seal diet was obtained from Hammill and Stenson (2000) (Table 7).

**Table 7.** Harbor seal diet composition (% wet weight) from Hammill and Stenson (2000, Appendix Table 8) divided into compartments.

Functional group		Published Diet		Diet in model (%)
		Item	(%)	
8	Cod	-	-	5.7
9	Haddock	-	-	0.1
10	Redfish	-	-	0.4
11	Pollock	-	-	12.7
15	Other Flounders	Winter flounder	1.3	-
		Four-spot flounder	0.1	-
		-	-	1.4
		White hake	2.9	-
		Ocean pout	0.8	-
16	Large demersal feeders	Silver hake	0.7	-
		-	-	4.4
		Sculpin	0.2	-
		Other fish (small demersals)	19.1	-
17	Small demersals	-	-	19.3
18	Mackerel	-	-	1.4
19	Atlantic herring	-	-	24.4
		Capelin	5.5	-
		Alewife	1.7	-
		Blueback herring	0.1	-
		Butterfish	1.1	-
20	Small pelagic feeders	-	-	8.4
21	Cunner	-	-	0.3
22	Squid	-	-	14.8
24	Crab	-	-	0.4
		Other inverts (benthos)	-	-

**Blue-fin Tuna (group 4)**

Average biomass of bluefin tuna (*Thunnus thynnus*) for the Western Atlantic during the period 1977-1986 was estimated at 23,919 tonnes (ICCAT, 2000). Blue-fin tuna are in the Gulf of Maine/Georges Bank area for only about 4 months, thus the biomass was assumed to be one third of the total population, or 0.056 tonnes wet weight·km<sup>-2</sup>.

A P/B of 0.4 year<sup>-1</sup> was taken from the large pelagic functional group of the Newfoundland model (Bundy *et al.*, 2000). Casey *et al.* (1987, Table 32.4) gave a total tuna biomass and consumption value as 362.4 tonnes and 1,667.7 tonnes respectively, or a Q/B of 4.6 year<sup>-1</sup>.

Eggleston and Bochenek (1989) described the diet of blue-fin tuna by volume for the Middle Atlantic Bight, which included approximately 50% of the diet as unidentified teleosts. Pinkas *et al.* (1971) suggested that the diet for tuna in California, features more engraulids, myctophids and scombrids, so we used herring, mackerel and small pelagics in 15:15:20 ratio for the unidentified 50% and the rest of the diet from Eggleston and Bochenek (1989) (Table 8).

Recreational catches of bluefin tuna were obtained via NMFS from the *Sea Around Us*

database (Ryan *et al.*, 2001) for the years 1981-1986. Bluefin tuna was only caught recreationally in 1986 (113 tonnes), an average of 18.83 tonnes for that time period, and 0.0001 tonnes·km<sup>-2</sup> for the total area. Commercial catches of bluefin tuna were made with grappling and wounding equipment, hook and line, bottom trawls, surrounding nets, and traps (Table 9). All landings for bluefin tuna in Massachusetts were assumed to be from the Georges Banks area (Nathaniel Newlands, Fisheries Centre, UBC, pers. comm.).

**Table 8.** Diet of bluefin tuna (by volume) in the Mid-Atlantic Bight adapted for the Gulf of Maine.

Functional group #	Species	Diet (%)	Total (%)
21	Filefish (large pelagics)	0.07	0.07
	Unidentified teleosts	49.44	-
19	Herring	15	15
18	Mackerel	15	15
	Small pelagics	19.44	-
	Butterfish (small pelagics)	2.51	-
	Seahorse (small pelagics)	0.07	-
20	Total small pelagics	-	22.02
17	Sand lance (small demersal)	30.75	30.75
22	Squid	16.78	16.78
26	Salps (macrozooplankton)	0.37	0.37
25	Isopods (benthos)	0.01	0.01

**Table 9.** Commercial landings for bluefin tuna in Maine, New Hampshire and Massachusetts from 1977-1986.

Gear	Maine & New Hampshire (t)	Massachusetts (t)	Average (t·year <sup>-1</sup> )	Catch (t·km <sup>-2</sup> ·year <sup>-1</sup> )
Grappling and wounding	366	803	116.9	0.000814
Hook and line	99	3,961	406.0	0.002825
Bottom trawl	0	3	0.3	0.000002
Surrounding net	0	3,571	357.1	0.002485
Traps	0	2	0.2	0.000001
Total	465	8,340	880.5	0.006127

**Skates (Group 5)**

Five species of *Raja* occur in the Gulf of Maine/Georges Banks area: little skates (*Raja erinacea*), winter skates (*R. ocellata*), barndoor skate (*R. laevis*), thorny skates (*R. radiata*) and smooth skates (*R. senta*). Little and winter skates occur on Georges Banks and in Southern New England, while thorny, barndoor and smooth skates are found in the Gulf of Maine (Sosebee, 2000a).

The total biomass of skates in the Gulf of Maine - Middle Atlantic area for the time period 1977-1986 was around 100 000 tonnes (Sosebee, 2000a – as given in the November 2000 version of this paper, but not in the January 2001 version). The percentages of the skate populations present in the Gulf of Maine (Table 10), were estimated from the Groundfish Atlas Maps ([www-orca.nos.noaa.gov/projects/ecnasap/ecnasap\\_table1.html](http://www-orca.nos.noaa.gov/projects/ecnasap/ecnasap_table1.html)). The stock biomass indices for the various skate species were

obtained from Sosebee (2000a). The biomass of skates in the Gulf of Maine – Georges Bank area was calculated by multiplying the total biomass of skates in the Gulf of Maine – Middle Atlantic (100,000 tonnes) with the percentage of the stock biomass index and the percentage of the population present in the Gulf of Maine (Table 10). The total biomass of skates in the Gulf of Maine was approximately 42,000 tonnes.

The natural mortality (M) of each of the species was taken from FishBase, and used to calculate a weighted average M of 0.37 year<sup>-1</sup> by using the Stock Biomass Index. The present rate of annual fishing mortality is 0.1 for winter skate and 0.4 for the little skate (Sosebee, 2000a). Because F was much lower in the period from 1977-1986, we used a value of 0.1. Thus the average P/B = M + F = 0.37 + 0.1 = 0.47 year<sup>-1</sup>. The Q/B was taken from FishBase for each species and the weighted average Q/B was calculated using the Stock

Biomass Index (Table 10). The percentage of food composition by weight of skates was obtained from data given by Vinogradov (1984) for little skates, thorny skates and winter skates (Table 11).

The 2000 Stock Assessment and Fishery Evaluation Report for the Northeast Skate Complex (Anon. 2001, Table 32, p. 123) gives the percentage of total landings caught in each area. According to these reports, 25% of the landings from Massachusetts were taken from the Gulf of Maine. Catches for Maine and New Hampshire were considered to originate from the Gulf of Maine. In the database, elasmobranchs are separated into three groups: skates, sharks and unidentified elasmobranchs. We apportioned the catch of unidentified elasmobranchs to skates and sharks according to the ratio of their respective catch (37:63) (Table 12). The resulting shark catches were added to the 'Large pelagic feeders' (see Table 38).

**Table 10.** Calculation of biomass, natural mortality and consumption rate (Q/B) of skates in the Gulf of Maine and Georges Bank.

Species	Stock biomass index	% of stock biomass index	% in Gulf of Maine	Biomass in Gulf of Maine (t)	Natural mortality (year <sup>-1</sup> )	Q/B (year <sup>-1</sup> )
Winter	2.83	0.251	60	15,013	0.050	0.500
Little	6.72	0.594	30	17,825	0.279	2.140
Barndoor	0.08	0.007	50	354	0.001	0.012
Thorny	0.77	0.068	100	6,808	0.014	0.204
Smooth	0.15	0.013	100	1,326	0.004	0.077
Clearnose	0.72	0.064	10	637	0.021	0.242
Total	-	-	-	41,963	-	-
Area (km <sup>2</sup> )	-	-	-	143,700	-	-
Biomass (t·km <sup>-2</sup> )	-	-	-	0.292	-	-

**Table 11.** Percentage diet composition of skates in the Gulf of Maine

Diet	Little	Thorny	Winter	Mean
Macrozooplankton	7	0	0	2.33
Large crustaceans	60	5	79	48.00
Benthos	22	3	19	14.67
Detritus	0	87	0	29.00
Small demersal feeders	11	5	2	6.00

**Table 12.** Catches of elasmobranchs in the Gulf of Maine and Georges Banks for 1977-1986 (t·km<sup>-2</sup> year<sup>-1</sup>). The disaggregated sharks catches were added to the 'Large pelagic feeders' functional group.

Gear	Original catches		Disaggregated catches	
	Skates	Unidentified elasmobranchs	Skates	Sharks
Bottom trawls	0.002160	0.000048	0.002178	0.000030
Dredges	0.000004	-	0.000004	-
Gillnets	0.000097	0.000166	0.000159	0.000104
Hooks and lines	0.000088	0.000048	0.000106	0.000030
Mobile seine	0.000023	-	0.000023	-
Recreational fishery	-	-	0.000016	0.000184
Total	0.002371	0.000447	0.002485	0.000349

### Bluefish (Group 6)

Bluefish (*Pomatomus saltatrix*) occurs from Florida to Maine and are managed as a single stock. The total biomass for the US Atlantic coast was approximately 80,000 tonnes for the 1977-1986 time period (Shepherd, 2000a). Bluefish migrate from the Florida Keys in February, up to Nova Scotia by August, and return to the keys by late January, leaving the northern latitudes when the water gets colder than 7°C. In spring they head north as the waters warm up to around 12°C ([combat-fishing.com/fishencyclo1/bluefishes/bluefish.htm](http://combat-fishing.com/fishencyclo1/bluefishes/bluefish.htm)). They probably spend about 3 months in the Gulf of Maine/Georges Banks area, which resulted in an ‘annualized’ biomass of 0.139 tonnes·km<sup>-2</sup>.

The Status of the Stock report for bluefish (Shepherd, 2000a) reports a value of M = 0.25 and a long-term target F of 0.36. As the stock was not depleted at this time, we assumed a P/B value of 0.25+0.36 = 0.61 year<sup>-1</sup>. A Q/B value of 4.6 year<sup>-1</sup> was obtained from FishBase. The diet composition was based on the average stomach content of adult bluefish for years 1994 and 1995 on the Georges Banks (Buckel *et al.*, 1999) (Table 13).

**Table 13.** Diet of bluefish for 1994-1995 (from Buckel *et al.* 1999).

Functional group #	Species	Mean diet (%)
8	Cod	3.35
9	Haddock	1.00
14	American plaice	0.40
15	Flounders	5.40
16	Large demersal feeders	2.05
17	Small demersal feeders	11.55
19	Herring	14.45
20	Small pelagic feeders	34.60
22	Squid	25.10
23	Shrimp	1.00
24	Crab	1.10

Half the catch of bluefish in Massachusetts and all of New Hampshire and Maine catches were assumed to come from the GOM. Bluefish are caught by bottom trawlers, gillnets, hook and line, midwater trawlers, surrounding nets as well as trap and lift nets. None of the recreational catches were taken from this area (Shepherd, 2000a) (Table 14).

**Table 14.** Catches of bluefish in the Gulf of Maine / Georges Banks area.

Gear	Total catch (t·year <sup>-1</sup> )	Catch (t·km <sup>-2</sup> ·year <sup>-1</sup> )
Bottom trawls	10.1	0.000070
Gillnets and entangling nets	100.9	0.000702
Hooks and lines	95.0	0.000661
Mid-water trawls	4.4	0.000031
Surrounding nets	12.6	0.000088
Traps and lift nets	16.1	0.000112
<b>Total</b>	<b>239.0</b>	<b>0.001663</b>

### Cod – Adult (Group 7)

Atlantic cod (*Gadus morhua*) is a demersal gadoid species that occurs from Greenland to North Carolina (Mayo and O’Brien, 2000). Cod was separated into 2 groups: adults and juveniles (< 35 cm).

From the stock assessment report (Mayo and O’Brien, 2000), the average biomass during the 1977-1986 time period, in the Gulf of Maine, was approximately 26,000 tonnes, while the average biomass of the Georges Bank-Mid-Atlantic stock was about 109,444 tonnes of which approximately 75% were found on Georges Bank ([www-orca.nos.noaa.gov/projects/ecnasap/maps/atlcod.gif](http://www-orca.nos.noaa.gov/projects/ecnasap/maps/atlcod.gif)). Thus, the resulting biomass is 0.752 tonnes·km<sup>-2</sup>.

**Table 15.** Calculation of cod biomass and fishing mortality in the Gulf of Maine and Georges Banks area

Year	Gulf of Maine			Georges Banks		
	Biomass (t)	Catch (t·year <sup>-1</sup> )	F (year <sup>-1</sup> )	Biomass (t)	Catch (t·year <sup>-1</sup> )	F (year <sup>-1</sup> )
1978	-	-	-	115,000	30,000	0.26
1979	-	-	-	135,000	35,000	0.26
1980	-	-	-	125,000	50,000	0.40
1981	-	-	-	135,000	40,000	0.30
1982	35,000	14,000	0.40	125,000	55,000	0.44
1983	27,000	15,000	0.56	95,000	50,000	0.53
1984	24,000	11,000	0.46	95,000	40,000	0.42
1985	22,000	11,000	0.50	75,000	40,000	0.53
1986	22,000	10,000	0.45	85,000	30,000	0.35
Average	26,000	12,200	0.47	109,444	4,1111	0.39

The fishing mortality (F) for the Gulf of Maine and Georges Banks areas was obtained by using the average F for each region (Mayo and O'Brien, 2000) weighted by their respective biomass (Table 15), thus  $F = 0.404$  and the  $P/B = Z = M + F = 0.2 + 0.404 = 0.604 \text{ year}^{-1}$ . This value is lower than the  $0.651 \text{ year}^{-1}$  used for the Newfoundland model (Bundy *et al.*, 2000) but similar to the  $0.6 \text{ year}^{-1}$  reported for the Gulf of Maine by Sissenwine (1987) for the 1963-1972 time period for all age groups (thus including the juveniles).

We used an average Q/B of  $2.58 \text{ year}^{-1}$  taken from FishBase, which is lower than the 3.3 reported by Sissenwine (1987) for all ages, before the collapse (1963-1972). The diets of adults and juvenile cod were given by Vinogradov (1984) and Steimle (1987), respectively (Table 16).

**Table 16.** Diet of adult and juvenile Atlantic cod.

Functional group #	Diet	Adults (%)	Juveniles (%)
26	Macrozooplankton	8	-
24	Crustaceans	38	11
25	Benthos	12	83
22	Squid	15	-
29	Detritus	1	6
19	Herring	3	-
18	Mackerel	3	-
	Red hake	7	-
	Silver hake	10	-
16	Total large demersals	17	-
14	American plaice	1	-

**Table 17.** Annual catches of Atlantic cod in the Gulf of Maine and Georges Banks area.

Gear	Overall catch (t)	Catch by area (t·km <sup>-2</sup> )
Bottom trawls	25,572.6	0.177958
Dredges	22.1	0.000154
Gillnets and entangling nets	5,131.0	0.035706
Hooks and lines	1,474.5	0.010261
Mid-water trawls	12.1	0.000084
Mobile seine	94.2	0.000655
Grappling and wounding	0.07	0.000001
Other gear	0.45	0.000003
Surrounding nets	0.97	0.000007
Traps and lift nets	0.53	0.000004
Total commercial catches	32,308.5	0.224833
Recreational fishery	2,638.3	0.018360

Catches for 1977 to 1986 were averaged. According to the Groundfish Atlas Map for Atlantic cod ([www-orca.nos.noaa.gov/projects/ecnasap/maps/atlcod.gif](http://www-orca.nos.noaa.gov/projects/ecnasap/maps/atlcod.gif)), only 75% of the biomass of cod in Massachusetts was found in the Gulf of Maine/Georges Banks area. Therefore only 75% of the catch was assumed to come from the GOM (Table 17).

### **Cod < 35 cm (Group 8)**

The biomass of juvenile cod was estimated by Ecopath by using an ecotropic efficiency (EE) of 0.99 and the P/B and Q/B ratios below (Table 18). The average P/B and Q/B age specific ratios for juvenile cod were taken from Sissenwine (1987) (Table 18).

**Table 18.** Annual P/B and Q/B ratios of juvenile Atlantic cod (from Sissenwine, 1987).

Age	P/B	Q/B
1	1.14	5
2	0.8	3.9
3	0.64	3.3
Average	0.86	4.07

### **Haddock (Group 9)**

Haddock, *Melanogrammus aeglefinus*, is a demersal gadoid that occurs from Greenland to Cape Hatteras (Brown 2000). The adults were placed in this compartment and the juveniles in the small demersal fish group (17).

There are two stocks of haddock, one on the Georges Bank and the other in the Southwestern Gulf of Maine. However, the Gulf of Maine stock is managed by using a biomass index which cannot be used directly as an estimate of biomass. We used the 1992 relative abundance indices, 0.1 kg/tow in the GOM and 0.9 kg/tow in the Georges Bank (Brown, 2000) to estimate the Gulf of Maine biomass. The average Spawner Stock Biomass in the Georges Bank area has been estimated at 40,000 tonnes for the 1977-1986 period and, using the 0.1/0.9 index ratio, the biomass for the Gulf of Maine was estimated at around 4,400 tonnes, with an average biomass for the total area of 0.305 tonnes·km<sup>-2</sup>.

Sissenwine (1987) reported an annual P/B for 1963-1972 of 0.41 for all age classes, but as only the adults were included in the biomass the P/B ratio for ages 4-12 was used as 0.284 (Sissenwine,

1987). A P/B of 0.38 year<sup>-1</sup> is more representative of the younger age classes, which would have a higher growth rate than the adults. Sissenwine (1987) reported an annual Q/B for 1963-1972 of 3.2 for all age classes, which is similar to the 3.0 reported by FishBase. However, the 4-12 year age classes had a Q/B of 2.75 year<sup>-1</sup> (Sissenwine, 1987).

The percentage of prey in the diet of haddock was obtained from Vinogradov (1984) and the 'non-specified fish' were allocated to yellowtail flounder (Table 19). From the Groundfish Atlas it seems that about 90% of the catches were made in the Georges Banks area of Massachusetts, thus 90% of the catch was taken to be from the Georges Bank ecosystem (Table 20).

**Table 19.** Diet of haddock on Georges Banks from 1968-1974 (from Vinogradov, 1984).

Functional groups #	Diet	% of diet
22	Squid	9
24	Crustaceans	12
25	Benthos	70
26	Macrozooplankton	1
29	Detritus	6
-	Not specified <sup>a</sup>	2
-	Total	100

<sup>a</sup>Unspecified fish, probably yellowtail or other flounder.

**Table 20.** Annual catches of haddock in the Gulf of Maine/Georges Banks area for the 1977-1986 time-period.

Gear	Total catch (t)	Catch by area (t·km <sup>-2</sup> )
Bottom trawls	13,149	0.091501
Dredges	8	0.000054
Gillnets and entangling nets	843	0.005869
Hooks and lines	112	0.000776
Midwater trawls	0.54	0.000004
Mobile seine	23	0.000159
Other gear	0.72	0.000005
Total commercial catch	14,136	0.098368
Recreational fishery	11	0.000074

### Redfish (Group 10)

Redfish, or ocean perch, *Sebastes* spp., are distributed throughout the North Atlantic and off New England and are most common in deep waters of the Gulf of Maine. They are slow growing, long-lived animals with an extremely low natural mortality (Mayo, 2000a).

The biomass of redfish was obtained from the status of the fishery report (Mayo, 2000a), where the VPA estimates of exploitable biomass were given as 136,000 tonnes in 1969 and 32,000 tonnes in 1985. These values correspond to approximately 23 kg/tow and 5 kg/tow respectively, thus 6,000 tonnes being approximately equal to 1 kg/tow. The average stratified mean biomass index for 1977-1986 was approximately 11 kg/tow, which translate to approximately 66,000 tonnes or 0.455 tonnes·km<sup>-2</sup>. We used a biomass of 0.47 tonnes·km<sup>-2</sup> for balancing.

Sissenwine (1987) assumed a P/B ratio of 0.25 year<sup>-1</sup>, which is very low, so we recalculated the P/B of redfish by assuming an ecotrophic efficiency of 0.95. Sissenwine (1987) assumed a Q/B ratio of 3.0 year<sup>-1</sup>. Konchina (1986) gives the diet of redfish as 67.7% macrozooplankton (Euphausiids, planktonic crustaceans and other invertebrates), 32% microzooplankton (copepods) and 0.3% benthos.

From the Groundfish Atlas ([www-orca.nos.noaa.gov/projects/ecnasap/maps/redall.gif](http://www-orca.nos.noaa.gov/projects/ecnasap/maps/redall.gif)), it appears that most (90%) of the redfish in the Massachusetts area occur on the Georges Banks; thus the catches for Massachusetts were divided into 90% for this model and 10% for the Mid-Atlantic. The resulting estimates are given in Table 21.

**Table 21.** Total annual catch (t) and catch per area of redfish in the Gulf of Maine and Georges Banks.

Gear	Total catch (t·year <sup>-1</sup> )	Catch per area (t·km <sup>-2</sup> ·year <sup>-1</sup> )
Bottom trawls	8,976.84	0.062469
Gillnets and entangling nets	37.01	0.000258
Hooks and lines	0.81	0.000006
Mid-water trawl	3.20	0.000022
Mobile seine	2.02	0.000014
Recreational fishery	1.67	0.000012
Total	9,021.55	0.062780

### Pollock (Group 11)

Mayo (2000b) found that that the spawning stock biomass of pollock (*Pollachius virens*) increased from 90,000 tonnes in 1974 to over 200,000 tonnes in 1985. With no other indication of the biomass of pollock during that time, we use an average biomass of 145,000 tonnes or approximately 1 tonne·km<sup>-2</sup>.

Sissenwine (1987) gives an annual P/B ratio for pollock for 1973-1975 of 0.42 and 4.0 year<sup>-1</sup> for Q/B. FishBase gives a Q/B ratio of 4.76 year<sup>-1</sup>, but we used the 4.0 year<sup>-1</sup> estimate.

Vinogradov (1984) gives the diet of pollock on the Georges Banks as 70% macrozooplankton and 30% silver hake, which we placed in the small demersal group. Diets reported for the Northwest Atlantic (Langton and Bowman, 1980) include Clupeidae and unidentified fishes. In the North Sea, they are reported to feed on herring and small cod (Robb and Hislop, 1980); thus, we divided the 30% of unidentified fish into 10% small demersals, 10% herring and 10% small cod.

Otter (bottom) trawls are mainly used for commercial landings of pollock, and according to Mayo (2000a), 17,300 tonnes per year (0.12 tonnes·km<sup>-2</sup>·year<sup>-1</sup>) of pollock was taken on average from 1977-1986. Recreational landings have varied between 0 and 1,300 tonnes (Mayo, 2000b), so an average recreational catch of 650 tonnes (0.005 tonnes·km<sup>-2</sup>·year<sup>-1</sup>) is used. From the Groundfish Atlas ([www-orca.nos.noaa.gov/projects/ecnasap/maps/poll-ok.gif](http://www-orca.nos.noaa.gov/projects/ecnasap/maps/poll-ok.gif)) it appears that most (95%) of the pollock in Massachusetts occur in the Gulf of Maine and on Georges Banks, so the catches for Massachusetts were divided into 95% for this model and 5% for the Mid-Atlantic. The resulting estimates are given in Table 22.

**Table 22.** Annual catches of pollock on the Georges Banks and in the Gulf of Maine.

Gear	Total catch (t)	Catch by area (t·km <sup>-2</sup> )
Bottom trawls	10,432.55	0.072600
Dredges	1.71	0.000012
Gillnets and entangling nets	6,080.96	0.042317
Hooks and lines	252.59	0.001758
Midwater trawls	0.30	0.000002
Mobile seine	6.13	0.000043
Traps and lift nets	0.48	0.000003
Recreational fishery	159.83	0.001112
Total	16,934.54	0.117846

### Summer flounder (Group 12)

The summer flounder (*Paralichthys dentatus*) occurs from the southern Gulf of Maine to South Carolina and are concentrated in bays and estuaries (Terceiro, 2000). The total stock biomass for the Georges Banks and Mid-Atlantic was estimated at 48,500 tonnes in 1983 and fell

to 16,000 in 1989 (Terceiro, 2000). However, most of the decline was only after 1986, so we use an average biomass of approximately 40,000 tonnes per year. Also, the Groundfish Atlas ([www-orca.nos.noaa.gov/projects/ecnasap/maps/sumfld.gif](http://www-orca.nos.noaa.gov/projects/ecnasap/maps/sumfld.gif)) shows that only about 30% of this stock occurs on the Georges Banks, so a biomass of 0.084 tonnes·km<sup>-2</sup> is used.

Sissenwine (1987) gives a P/B value of 0.46·year<sup>-1</sup> for flounder, which is the same as the value calculated assuming that M = 0.2 and F = 0.26 (Terceiro, 2000). FishBase gives the Q/B for summer flounder as 2.6·year<sup>-1</sup>.

Langton and Bowman (1981) gives the diet of summer flounder as 51% squid, 1.2% shrimps and 47.8% finfish of which most is Gadidae. Thus, the 47.8% is divided into 27.8% small demersal fish, 5% small cod, 5% haddock and 10% pollock as the biomass of pollock is larger than that of cod and haddock.

The population of summer flounder in the Gulf of Maine and Georges Banks area occurs mostly on the Banks, and most of the catches are made there. Of the summer flounder landed in Massachusetts 30% were assumed to be from the Banks (Table 23).

**Table 23.** Annual catches of summer flounder on Georges Banks and in the Gulf of Maine.

Gear	Total catch (t)	Catch by area (t·km <sup>-2</sup> )
Bottom trawls	203.95	0.001419
Dredges	1.95	0.000014
Gillnets	0.10	0.000001
Hooks and lines	7.50	0.000052
Mid-water trawls	0.39	0.000003
Other gear	0.03	0.000000
Surrounding nets	3.24	0.000023
Traps and lift nets	2.31	0.000016
Recreational fishery	93.83	0.000653
Total	219.47	0.002180

### Yellowtail Flounder (Group 13)

Yellowtail flounder (*Limanda ferruginea*) is a right-handed, small-mouthed flounder that occurs from Labrador to Chesapeake Bay at depths of 40 to 70 m mostly on Georges Banks, off Cape Cod, Mid-Atlantic and off Southern New England (Cadrin, 2000a).

The Georges Bank yellowtail flounder Spawner Stock Biomass was taken from the 'summary stats' figure in Cadrin (2000a) as approximately 12,000 tonnes, while that of the Cape Cod stock was estimated as mostly above the 2,300 tonnes in 1985 and 1986. It was assumed that the biomass was at least double that, as the Massachusetts Spring Survey Index for the years 1977-1986 was on average double that of 1985-1986. Thus, a biomass of 5,000 tonnes was assumed for the Cape Cod stock. Total spawner stock biomass is therefore 0.117 tonnes·km<sup>-2</sup> and we doubled this to include juveniles, leading to an overall biomass of about 0.24 tonnes·km<sup>-2</sup>.

Annual P/B and Q/B values of 0.63 and 4.6 respectively were taken from Sissenwine (1987) estimated for all age classes of yellowtail flounder during 1963-1972. We used an average of the values at age of the adult segment of the age structure which resulted in a Q/B value of 3.27·year<sup>-1</sup>

Vinogradov (1984) gives the diet composition of yellowtail flounder in the Georges Banks area as 58% crustaceans, 27% polychaetes, 1% echinoderms (thus: 28% benthos), and 11% detritus and unidentified remains.

It was assumed that all of the catch from Massachusetts was of the Cape Cod and Georges Banks stocks. There are no recreational catches of yellowtail flounder (Table 24).

**Table 24.** Annual catches of yellowtail flounder on the Georges Banks and Cape Cod stocks.

Gear	Total catch (t)	Catch by area (t·km <sup>-2</sup> ·year <sup>-1</sup> )
Bottom trawls	11,583.6	0.080610
Dredges	168.3	0.001171
Gillnets and entangling nets	18.4	0.000128
Hooks and lines	1.8	0.000013
Mid-water trawls	0.1	0.000001
Mobile seine	131.9	0.000918
Traps and lift nets	0.1	0.000001
Total	11,904.2	0.082841

**American Plaice (Group 14)**

The American plaice, *Hippoglossoides platessoides*, is a large-mouthed, right-handed flounder, distributed along the Northwest Atlantic continental shelf from southern Labrador to Rhode Island in relatively deep waters (O'Brien, 2000a).

O'Brien (2000a) gives the Spawning Stock Biomass of American plaice as between 49,200 tonnes in 1980 and 13,000 tonnes in 1987, and readings from the graph gave an average biomass of approximately 30,000 tonnes, or 0.208 tonnes·km<sup>-2</sup>. We doubled this to 0.42 tonnes·km<sup>-2</sup> to include the juveniles.

F was calculated as 0.4 year<sup>-1</sup> using catch and biomass ratio for 1980-1986 (O'Brien 2000a) and added to M (0.2) resulting in a P/B of 0.6 year<sup>-1</sup>. FishBase gives the Q/B of American plaice as 4.2 year<sup>-1</sup> (assuming omnivory), which is similar to the 4.1 year<sup>-1</sup> estimated for flounders by Sissenwine (1987).

Vinogradov (1984) gives the diet of American plaice as: 6% crustaceans, 38% benthos (22% echinoderms, 10% mollusks and 6% polychaetes), 40% small demersals (sandlance) and 16% detritus.

It was assumed that 90% of the catch from Massachusetts was made on Georges Banks. There are no recreational catches of American plaice. Catch statistics were taken from the NMFS database (Table 25). O'Brien (2000a) reports that discarding of American plaice is highest on fish ages 2 to 3 in the northern shrimp fishery, but does not say what the discard rates are. In the large mesh otter trawl fishery, discarding was highest on age 3 and 4 fish early in the time series (around the time of this model), and has shifted to age 4 and 5 fish since 1992. Since 1989, discarded fish have accounted for 40-60% of the total catch in numbers and 15-40% of the total catch in weight (O'Brien, 2000a), an average of 30% or 0.02 tonnes·km<sup>-2</sup> was used for discards of American plaice by otter trawl.

**Table 25.** Annual catches of American plaice in the Georges Banks and Gulf of Maine area.

Gear	Total catch	Catch by area (t·km <sup>-2</sup> ·year <sup>-1</sup> )
Bottom trawls	9,877.56	0.068737
Dredges	3.72	0.000026
Gillnets and entangling nets	55.94	0.000389
Grappling and wounding	0.09	0.000001
Hooks and lines	6.37	0.000044
Mid-water trawls	0.18	0.000001
Mobile seine	92.28	0.000642
Other gear	0.10	0.000001
Traps	0.30	0.000002
Total	10,036.54	0.069843



### Other flounders (Group 15)

All flounders not discussed previously were placed into this group including the winter flounder (*Pseudopleuronectes americanus*), witch flounder (*Glyptocephalus cynoglossus*) and the windowpane flounder (*Scophthalmus aquosus*). The winter flounder has two populations in this study area: one in the Gulf of Maine and one on Georges Banks (Nitschke, *et al.* 2000). The witch flounder (Wigley, 2000a) and windowpane flounder (Hendrickson, 2000a) populations in the Gulf of Maine-Georges Banks area are distinct from other populations, both to the north and south. Other flounder species also included are the four-spot flounder (*Paralichthys oblongus*), Gulfstream flounder (*Citharichthys arctifrons*) and Atlantic halibut (*Hippoglossus hippoglossus*) (Groundfish Atlas - [www-orca.nos.noaa.gov/projects/ecnasap/ecnasap\\_table1.html](http://www-orca.nos.noaa.gov/projects/ecnasap/ecnasap_table1.html)).

The mean biomass of witch flounder was estimated at around 20,000 tonnes (Wigley, 2000a), but that of winter and windowpane flounder was not available, so Ecopath was left to estimate this biomass using an EE of 0.99. Sissenwine (1987) gave P/B and Q/B ratios of 0.46 and 4.1 year<sup>-1</sup> respectively for flounders.

The diet composition of four-spot and winter flounders were obtained from Vinogradov (1984), while that of witch and Gulfstream flounder was obtained from Langton and Bowman (1981; in FishBase), and windowpane flounder from Hacunda (1981) (Table 26).

The catch of halibut, windowpane, witch, winter, four-spot and Gulfstream flounders are given in Table 27. It was assumed that 75% of all the catches made in Massachusetts came from the Gulf of Maine/Georges Banks area and the other 25% for the Mid-Atlantic.

**Table 27:** Annual catches of flounders in the Gulf of Maine and Georges Banks.

Gear	Total catch (t)	Catch by area (t·km <sup>-2</sup> )
Bottom trawls	11,707	0.081468
Dredges	54	0.000373
Gillnets and entangling nets	118	0.000821
Hooks and lines	37	0.000259
Mid-water trawls	0.8	0.000006
Mobile seine	147	0.001021
Surrounding nets	0.7	0.000005
Traps and lift nets	1.1	0.000007
Recreational fishery	337	0.002344
Total	12,402	0.086305

**Table 26.** Percentage diet composition of flounders in the Gulf of Maine.

Functional group #	Diet	Four-spot	Winter	Witch	Window-pane	Gulf-stream	Mean
17	Small demersals	3	-	0.6	-	2.7	1.26
24	Crustaceans	74	55	-	0.2	-	25.84
25	Benthos		45	87.6	0.4	97.30	46.06
29	Detritus	23	-	6.9	-	-	5.98
26	Macrozooplankton	-	-	1.7	79.1	-	16.16
22	Squid	-	-	3.2	-	-	0.64
19	Herring		-		20.3	-	4.06

### Large Demersal Feeders (Group 16)

Large demersal feeders in the Gulf of Maine include ocean pout (*Macrozoarces americanus*; Wigley, 2000b), Atlantic sturgeon (*Acipenser oxyrinchus*) and shortnose sturgeons (*Acipenser brevirostrum*; Friedland, 2000), goosefish or monk, or angler (*Lophius americanus*; Richards, 2000), cusk (*Brosme brosme*; O'Brien 2000b), wolffish (*Anarhichas lupus*, Idoine, 2000a), tilefish (*Lopholatilus chamaeleonticeps*; Nitschke, 2000), striped bass (*Morone saxatilis*; Shepherd, 2000b), rocklings, grenadiers, eelpouts, lumpfish, hagfish (*Myxine*

*glutinosa*) and adult white hake (*Urophycis tenuis*), adult red hake (*Urophycis chuss*; Sosebee, 2000c) and adult silver hake (*Merluccius bilinearis*).

White hake spawner biomass peaked at 13,100 tonnes, so an average of 10,000 tonnes was retained (Sosebee, 2000b). The biomass of hagfish was available from Martini *et al.* (1997) but only for 1987-1992. The biomass estimates of all other species were not available and therefore it was left to be estimated by Ecopath using an EE of 0.99.



### Small Demersal Feeders (Group 17)

The small demersal feeders group included the juveniles of hake, haddock, wolffish and flounder. Other species included in this group are sand lance (*Ammodytes americanus*), sculpin (Cottidae), black sea bass (*Centropristis striata*), Atlantic croaker, Northern sea robins (*Priondius carolinus*) and tomcod. The scup or porgies were presumed to occur in the Mid-Atlantic.

The biomass of this group was estimated by Ecopath by using a EE value of 0.99. P/B and Q/B were estimated at 0.764 and 5.02 year<sup>-1</sup> respectively for 1-3 year old silver hake, yellowtail flounder and haddock is used (Sissenwine, 1987).

The diet of small demersal fish (Table 30) was based on the diets of sculpin (Vinogradov, 1984), small wolffish (Templeman, 1985) and juvenile hake, haddock, rockling, pollock and flounders (Bowman, 1981).

**Table 30.** Diet of small demersal fish taken from Vinogradov (1984), Templeman (1985) and Bowman (1981).

Prey species	Sculpin	Wolf-fish	Haddock	Silver hake	Pollock	Red hake	White hake	Spotted hake	Four-beard rockling	American plaice	Yellow-tail flounder	Mean
Macrozooplankton	3.0	0.8	43.0	54.5	57.3	30.2	15.4	77.1	33.3	21.1	82.4	38.01
Microzooplankton	-	-	0.6	0.1	0.2	1.3	-	7.0	-	-	-	0.84
Large crustaceans	84.0	8.5	6.7	4.8	9.2	17.2	21.3	1.8	-	-	7.3	14.62
Benthos	13.0	90.7	15.6	0.3	1.9	2.7	2.9	-	-	72.1	4.0	18.47
Shrimps	-	-	11.5	30.4	0.3	41.6	58.2	-	-	-	3.7	13.25
Small demersals	-	-	5.0	8.5	-	1.9	-	-	-	-	-	1.40
Detritus	-	-	17.6	1.4	31.1	5.1	2.2	14.1	66.7	6.8	2.6	13.42

### Atlantic Mackerels (Group 18)

The Atlantic mackerel group included only the Atlantic mackerel (*Scomber scombrus*), as chub mackerel (*Scomber japonicus*) was included in the small pelagic feeders and Spanish mackerel (*Scomberomorus maculatus*) was included in the large pelagic feeders. There are two stocks of Atlantic mackerel that spawn in the Mid-Atlantic and Gulf of St. Lawrence, and they are managed as a unit stock due to their extensive northerly and southerly migrations (Overholtz, 2000a).

Overholtz *et al.* (2000b, Figure 11) gave an average biomass of approximately 1 million tonnes for the total stock of mackerel that range throughout the Gulf of Maine, Georges Banks and Mid-Atlantic. Half that total was taken (500,000 tonnes, or 3.479 tonnes·km<sup>-2</sup>). It was assumed that 75% of the catch of mackerel in

In Massachusetts 50% of commercial catches of sand lance, porgies, Atlantic croaker, sculpin, and black sea bass were added to catches of these fish in Maine and New Hampshire. Recreational catches were taken integrally (Table 31).

**Table 31.** Annual catches of small demersal fish in the Gulf of Maine/Georges Banks.

Gear	Total catch (t)	Catch by area (t·km <sup>-2</sup> )
Bottom trawls	1,514	0.001054
Hooks and lines	386	0.000269
Mid-water trawls	531	0.000370
Mobile seine	100	0.000070
Traps and lift nets	1,290	0.000897
Gillnets	3	0.000002
Recreational fishery	109	0.000756
Total	3,932	0.003417

Massachusetts was from the Gulf of Maine (Table 32).

**Table 32.** Catch of mackerel in the Gulf of Maine.

Gear	Total catch (t)	Catch by area (t·km <sup>-2</sup> )
Bottom trawls	101.63	0.000707
Gillnets and entangling nets	114.48	0.000797
Hooks and lines	12.05	0.000084
Mid-water trawls	2.10	0.000015
Mobile seine	18.40	0.000128
Surrounding nets	180.35	0.001255
Traps and lift nets	234.68	0.001633
Recreational fishery	507.17	0.003529
Total	1,170.84	0.008148

Sissenwine (1987) estimated an average annual P/B of 0.34 for the time period 1963-1972. FishBase estimates an annual Q/B of 4.4, which is similar to the 4.3·year<sup>-1</sup> given by Sissenwine (1987) and used in this model.

The diet of Atlantic mackerel was described by Vinogradov (1984) as 84% planktonic crustaceans and 14% other plankton and 2% benthic crustaceans, while Fortier and Villeneuve (1996) gave the diet as 94% copepods and 6% other plankton, so we assume a diet of 80% microzooplankton (copepods), 18% macrozooplankton and 2% benthos.

### **Herring (Group 19)**

The Atlantic herring, *Clupea harengus*, is widely distributed in Northwest Atlantic continental shelf waters from Labrador to Cape Hatteras (Overholtz, 2000b). Gulf of Maine herring migrate from summer feeding grounds along the Maine coast to southern New England and Mid-Atlantic areas during winter, and there is also evidence of intermixing of Gulf of Maine-Scotian Shelf herring during different phases of the annual migration (Overholtz, 2000b).

Herring from the Gulf of Maine and Georges Bank have been combined for assessment purposes into a single coastal stock complex (Overholtz, 2000b). The stock collapsed in 1976 and after the collapse, the stock biomass was estimated at less than 100,000 tonnes. The stock started rebuilding around the mid-1980s (Overholtz, 2000b), and a biomass of around 100,000 tonnes (0.696 tonnes·km<sup>-2</sup>) was assumed for the time period 1977-1986 (Overholtz, 2000b). However, this estimate included only the spawning stock, so the biomass was assumed to be 1.4 tonnes·km<sup>2</sup> including juveniles.

Sissenwine (1987) estimated an average annual P/B ratio of 0.29, but did not consider the higher P/B of 1 year olds. This estimate was also for a time period when herring catches were lower, so the P/B was estimated using an ecotrophic efficiency of 0.95. FishBase estimates an annual Q/B similar to a Q/B of 4.6 year<sup>-1</sup> reported in Sissenwine (1987).

Vinogradov (1984) gives the diet of Atlantic herring as 89% crustacean plankton and 11% other plankton, while FishBase gives a diet of between 30% (Last, 1987) and 83% (Hinrichs, 1985) copepods (microzooplankton). We assumed a diet of 50% microzooplankton and 50% macrozooplankton.

As most of the fishery was focused on near shore waters of the Gulf of Maine during 1978-1989 (Overholtz, 2000b), it was assumed that all the catch in Massachusetts came from the Gulf of Maine and Georges Banks (Table 33).

**Table 33.** Annual catches of herring in the Gulf of Maine and Georges Banks.

<b>Gear</b>	<b>Total catch (t)</b>	<b>Catch by area (t·km<sup>-2</sup>)</b>
Bottom trawls	4,38.4	0.003051
Gillnets and entangling nets	1.4	0.000010
Midwater trawls	41,97.1	0.029207
Surrounding nets	23,375.8	0.162671
Traps and lift nets	3,847.9	0.026777
Mobile seine	13,515.0	0.094050
Recreational fishery	0.2	0.000001
<b>Total</b>	<b>45,375.7</b>	<b>0.315767</b>

### **Small Pelagic feeders (Group 20)**

The small pelagic feeders consist of anchovies (*Anchovia mitchilli*), alewife (*Pomolobus pseudoharengus*), blueback herring (*Pomolobus aestivalis*), menhaden (*Brevoortia tyrannus*), round herring (*Etrumeus teres*), capelin (*Mallotus villosus*), Atlantic argentine (*Argentina silus*), smelts (*Osmerus mordax*), butterfish (*Peprilus triacanthus*), silversides (Atherinidae), needlefish (*Strongylura marina*), chub mackerel (*Scomber japonicus*), Atlantic saury (*Scomberesox saurus saurus*) cunners (*Tautogolabrus adspersus*), lump sucker (*Cyclopterus lumpus*), and myctophids.

The biomass was estimated by using an EE of 0.99. Sissenwine (1987, Table 31.5) gave an average annual P/B for small pelagics (herring, mackerel and squid) of 0.52, which is halfway between the 0.25 used by Bundy *et al.* (2000) for piscivorous and planktivorous pelagics, and the 1.1 used for capelin in the same reference. We used a value of 1.0 year<sup>-1</sup> which is similar to the capelin, and more representative of the small pelagics in this system. Stone and Jessop (1994) gave a daily ration for alewife of 1.2-1.9%, which translated to an annual Q/B of 5.5. This is similar to the 4.96 year<sup>-1</sup> estimated from Sissenwine (1987), so an average of 5.0 year<sup>-1</sup> is used.

Stone and Jessop (1994) found that alewife feed on microzooplankton (1.3%), macrozooplankton (97.6%) and benthos (1.1%). Davis and Foltz (1991) found that the ratio of copepods (microzooplankton) in the diet of blueback herring varied from 15-40% so we assume a diet

of 22% microzooplankton and 78% macrozooplankton (Vinogradov, 1984). Atlantic argentines are reported (FishBase) to feed on planktonic invertebrates including euphausiids, amphipods, chaetognaths, squids and ctenophores, also small fishes, and therefore their diets were presumed to be 100% macrozooplankton.

According to FishBase ([www.fishbase.org](http://www.fishbase.org)), butterfish feed mainly on jellyfish, but also benthos and finfish. Vinogradov (1984) described the diet of butterfish as 1% benthic crustaceans, 46% planktonic crustaceans, and 53% other plankton (jellyfish?), so we assumed a diet of 1% benthos and 99% macrozooplankton.

Round herring feed on copepods and euphausiids (Whitehead, 1985), and Vinogradov (1984) described the diet as 6% benthic crustaceans, 85% planktonic crustaceans, and 9% other plankton. We assumed a diet of 6% benthos, 60% macrozooplankton and 34% microzooplankton (South Atlantic round herring, *Etrumeus whiteheadi*, feed more on large zooplankton according to FishBase). Chub mackerel feed on macrozooplankton, herring and phytoplankton. Menhaden feed on detritus (46%), phytoplankton

(36%) and microzooplankton (18%) (Lewis and Peters, 1994). FishBase has smelts feeding on invertebrates such as amphipods, ostracods, aquatic insect larvae, and aquatic worms and anchovy feeding on mysids and copepods, but quantitative diet compositions are not provided. The diet in Table 34 results from the modification of the small pelagic diet to remove herring from their diet.

Catches of small pelagic fish were less in Massachusetts than in Maine and New Hampshire, so we assumed that all catches in Massachusetts were made in the Gulf of Maine and Georges Banks (Table 35).

**Table 35.** Annual catches of small pelagic fish in the Gulf of Maine and Georges Banks.

Gear	Total catch (t)	Catch by area (t·km <sup>-2</sup> )
Bottom trawls	19.2	0.000134
Dredges	79.0	0.000550
Hooks and lines	9.9	0.000069
Surrounding nets	17,305.1	0.120425
Traps and lift nets	16.4	0.000114
Recreational	10.0	0.000070
Total	17,439.6	0.121361

**Table 34.** Percentage diet composition of small pelagic feeders.

Species	Alewife	Blueback herring	Butterfish	Argentine	Round herring	Chub mackerel	Menhaden	Average	Balanced diet
Macrozooplankton	97.60	78	-	100	60	59.5	-	56.44	57.2
Microzooplankton	1.30	22	99	-	34	-	18	24.90	25.3
Benthos	1.10	-	1	-	6	-	-	1.16	1.2
Detritus	-	-	-	-	-	-	46	6.57	6.7
Phytoplankton	-	-	-	-	-	30.2	36	9.46	9.6
Herring	-	-	-	-	-	10.3	-	1.47	0.0

### **Large pelagic feeders (Group 21)**

Large pelagic feeders in the Gulf of Maine include American shad (*Alosa sapidissima*), Atlantic salmon (*Salmo salar*), Atlantic bonito (*Sarda sarda*), porbeagle (*Lamna nasus*), Spanish mackerel (*Scomberomorus maculatus*), swordfish (*Xiphius gladius*), thintail thresher (*Alopias vulpinus*) and various sharks, tunas and other billfishes (Istiophoridae). The tuna's include albacore (*Thunnus alalunga*), bigeye (*Thunnus obesus*), skipjack (*Katsuwonus pelamis*), yellowfin (*Thunnus albacares*) and little tunny (*Euthynnus alletteratus*), while the sharks consist of the blue shark (*Prionace glauca*), shortfin mako (*Isurus oxyrinchus*), piked shark (*Squalus acanthias*) and other dogfish.

Biomass estimates (Table 36) for sharks, swordfish, marlin and tuna were obtained from Casey *et al.* (1987). Sosobee (2000d) suggested that the biomass of spiny dogfish on the east coast increased steadily from 150,000 tonnes in 1968 to 600,000 tonnes in 1990. Minimum biomass estimates of spiny dogfish in the Gulf of Maine-Middle Atlantic for 1977 – 1986 (Rago *et al.*, 1998) were averaged and divided by two assuming that only half the population was present in the Gulf of Maine. This gave an average biomass of approximately 200,000 tonnes for large pelagic fish in the Gulf of Maine or 1.4 tonnes·km<sup>-2</sup>.

**Table 36.** Biomass and consumption of sharks, swordfish, marlin and tuna (Casey *et al.* 1987).

Species	Biomass (t)	Consumption (t·year <sup>-1</sup> )
Swordfish	1091	6,789
Marlin	33	219
Blue shark	3,802	5,548
Mako shark	214	2336
Dusky shark	82	511
Sandbar shark	38	256
Hammerhead shark	69	438
Black-tip shark	12	73
Tiger shark	107	657
Thresher shark	44	256
Silky shark	7	37
Misc. sharks	60	365
Total sharks	5,558	17,484
Tuna	362	3,979
Spiny dogfish	190,300	
Total large pelagics	196,220	

Bundy *et al.* (2000) used an annual P/B of 0.4, which is lower than the 0.52 used by Sissenwine (1987) for smaller pelagics, and similar to the 0.41 of haddock (Sissenwine 1987), so we use 0.4 year<sup>-1</sup> with low certainty. Daily consumption and biomass estimates of sharks, swordfish, marlin and tuna (Table 36) were obtained from Casey *et al.* (1987) and were used to calculate an average Q/B of 3.6. Stillwell and Kohler (1985) found Q/B values ranging between 1.1 for the nurse sharks to 11.6 for the mako, with an average of 3.4-5.8 for swordfish, so we used 4.0 year<sup>-1</sup>.

Diets of large pelagic feeders are not readily available. The diet of spiny dogfish was available from Vinogradov (1984), that of swordfish from Stillwell and Kohler (1985), and that of Spanish

mackerel and mako were taken from FishBase as representative of the group (Table 37). The diet was subsequently changed to balance the herring and bluefish. Herring is preferred by Spanish mackerel, and bluefish by mako but neither are eaten much by the other groups. Thus, the respective percentages of these preys were reduced to 1% each, and the rest was apportioned to the other groups (Table 37).

The total catches for large pelagics were obtained from the NMFS statistics for Maine, New Hampshire and 75% from Massachusetts (Table 38). The catch of sharks from the elasmobranch group was added from Table 12. According to Rago *et al.* (1998) discards of spiny dogfish may have been of the same magnitude as the reported landings. Discards from the sink-gillnets in the Gulf of Maine cod fishery were estimated to be 1.038 times the total catch of cod and 0.11 times the dogfish landings. Thus, it was assumed that 0.11 times the annual catch of all large pelagics is discarded, and the total discard of large pelagics from sink-gillnets is approximately 0.04 tonnes·km<sup>-2</sup>, of which 75% (0.03 tonnes·km<sup>-2</sup>) is discard mortality (Rago *et al.*, 1998). From otter trawls the estimates of discards were 43.4% of the dogfish catch (or 0.001 tonnes·km<sup>-2</sup>), 92.4% of the cod catch for the Gulf of Maine and 37.7% of the cod catch on the Georges Banks (Rago *et al.*, 1998). The discards from bottom trawls from the cod fishery was averaged as 65.1% of the cod catch or 0.116 tonnes·km<sup>-2</sup>, so the total discard of large pelagic fish by bottom trawlers is 0.117 tonnes·km<sup>-2</sup>. Of these discarded fish, only 50% (0.06 tonnes·km<sup>-2</sup>) are believed to die (Rago *et al.*, 1998).

**Table 37.** Percentage diet composition of large pelagic feeders.

Prey species	Spanish mackerel	Spiny dogfish	Swordfish	Shortfin mako	Average	Balanced diet
Macrozooplankton	0	4	0	0	1.0	1.8
Benthos	0.3	0	0	0	0.1	0.2
Squid	0	18	67.3	1.9	21.8	42.7
Small pelagic feeders	0	12	4.1	13.2	7.3	14.3
Herring	85.4	28	0.3	0	28.4	1.0
Mackerel	0	0	5.4	4	2.4	4.7
Small demersal feeders	14.3	1	4.4	1.6	5.3	10.4
Large demersal feeders	0	12	9.4	0	5.1	10.0
Redfish	0	1	2.4	1	1.1	1.0
Large cod	0	0	2.6	0.3	0.7	1.3
Cod < 35 cm	0	20	0	0	5.0	9.8
Skates	0	4	0	0	1.0	1.8
Bluefish	0	0	4	78	20.5	1.0

**Table 38.** Annual catches of large pelagic feeders for the Gulf of Maine and Georges Banks

Gear	Total catch (t)	Catch by area (t·km <sup>-2</sup> )
Bottom trawls	326.7	0.002304
Dredges	0.1	0.000001
Gillnets and entangling nets	578.2	0.004127
Grappling and wounding	172.4	0.001200
Hooks and lines	1,034.1	0.007227
Surrounding nets	271.8	0.001891
Traps and lift nets	943.9	0.006569
Mid-water trawls	2.1	0.000015
Mobile seine	17.1	0.000119
Recreational fishery	51.8	0.000545
Total	3,398.3	0.023998

**Squid (Group 22)**

Longfin inshore squid (*Loligo paeleii*) occurs from Newfoundland to the Gulf of Venezuela and is managed as one stock from Georges Banks to Cape Hatteras (Cadriin, 2000b). The Northern shortfin squid (*Illex illecebrosus*) is a highly migratory species distributed from Labrador to Florida. It is considered a unit stock from Cape Hatteras to Newfoundland (Hendrickson, 2000b).

The biomass of the longfin inshore squid stock was approximately 42,000 tonnes in 1999 and was estimated to be similar to the average for 1977-1986; however, the biomass of northern shortfin squid could not be established, so it was estimated by Ecopath by assuming an EE of 0.99. Sissenwine (1987) estimated P/B and Q/B values of 1.5 and 7 year<sup>-1</sup> respectively, for both *Illex* and *Loligo*.

Bundy *et al.* (2000; Appendix 2 Table 16) described the diet of short-finned squid as 1% large zooplankton, 43% small cod, 12% small pelagic feeders, 19% capelin (i.e., small pelagics in our system) and 25% small demersals. However, we used a diet of 5% small demersal feeders, 5% small pelagic feeders, 5% shrimp and 85% of macrozooplankton, which is more similar to squids diet in general (V. Christensen, Fisheries Centre, UBC, pers. comm.).

Catches of squids by US fisheries represented 44% of the total catch of squid (Cadriin, 2000b; Hendrickson, 2000b), and the catch of squid in Massachusetts were split into 75% Gulf of Maine 25% Mid-Atlantic region (Table 39).

**Table 39.** Annual catch of squid in the Gulf of Maine and Georges Banks.

Gear	US catch (t)	US catch by area (t·km <sup>-2</sup> )	Total catch by area (t·km <sup>-2</sup> )
Bottom trawls	982.8	0.006839	0.015543
Dredges	1.0	0.000007	0.000015
Gillnets and entangling nets	0.5	0.000003	0.000008
Hooks and lines	0.2	0.000002	0.000004
Mid-water trawls	0.3	0.000002	0.000005
Mobile seine	13.3	0.000092	0.000210
Traps and lift nets	214.7	0.001494	0.003396
Total	1,212.7	0.008439	0.019180

**Shrimp (Group 23)**

The northern (pink) shrimp, *Pandalus borealis*, inhabit soft mud bottoms at depths of approximately 1-300 meters, most commonly in cold waters. The Gulf of Maine is the southern limit of the species' distribution in the North Atlantic (Cadriin, 2000c).

The biomass was estimated by using an EE of 0.99. We used the values of P/B (1.45 year<sup>-1</sup>) and Q/B (9.667 year<sup>-1</sup>) estimated for the same species in Newfoundland (Bundy *et al.*, 2000). Based on the assumption that 30% of the feeding occurred in the benthic environment and 70% in the pelagic environment (Bundy *et al.*, 2000) the diet was assumed to be composed of 52% detritus, 9% phytoplankton, 24% microzooplankton, 12% macrozooplankton and 3% benthos.

As the northern shrimp is at the southern tip of its range the total catch from Massachusetts were taken to be from the Gulf of Maine (Table 40).

**Table 40.** Annual catch of shrimp in the Gulf of Maine.

Gear	Total catch (t)	Catch by area (t·km <sup>-2</sup> )
Bottom trawls	1,714	0.011928
Dredges	0.6	0.000004
Gillnets and entangling nets	0.2	0.000001
Mobile seine	0.2	0.000001
Other gear	0.1	0.000001
Traps and lift nets	2,369.9	0.016492
Total	4,085	0.028427

**Large Crustaceans (Group 24)**

Large crustaceans include the American Lobster, *Homarus americanus* (Idoine, 2000b) and other large crabs such as the Atlantic rock crab (*Cancer irroratus*), green crab (*Carcinus maenas*), horseshoe crab (*Limulus polyphemus*), Jonah crab (*Cancer borealis*) and red crab (*Geryon quinque-dens*). American lobsters are distributed from Labrador to Cape Hatteras and are abundant in the coastal regions of the Gulf of Maine. The Gulf of Maine and Georges Banks stocks are assessed separately (Idoine, 2000b).

The biomass of large crustaceans was estimated to be the same as that of Arthropoda (5.5 g wet weight·m<sup>-2</sup>) in Steimle (1987). Steimle (1987) gives the average P/B for Arthropoda as 3.5 year<sup>-1</sup>. Bundy *et al.* (2000) estimated an annual Q/B of 5.85 for large crustaceans off Newfoundland. We used the diet composition proposed by Bundy *et al.* (2000, Appendix 2 Table 18, p. 148) which they adapted from Ennis (1973) (Table 41).

**Table 41.** Diet of large crustaceans adapted from Bundy *et al.* (2000).

Diet	Percentage
Shrimp	2
Benthos	85
Macrozooplankton	2
Microzooplankton	1
Detritus	10

Lobster are taken as bycatch in the otter (bottom) trawls, but are mostly fished with traps. Recreational fishing occurs in coastal waters, but estimates of the catch are not available (Idoine, 2000b). Total landings averaged 17,600 tonnes for 1977-1986 for the area from Labrador to Cape Hatteras (Idoine, 2000b). The total catch of large crustaceans included the catch of all the above mentioned crabs, not just American lobster (Table 42) and 75% of the catches in Massachusetts were taken to be from the Gulf of Maine and Georges Banks area.

**Table 42.** Annual catch of large crustaceans in the Gulf of Maine.

Gear	Total catch (t)	Catch by area (t·km <sup>-2</sup> )
Bottom trawls	241	0.001678
Dredges	3	0.000021
Hooks and lines	0.07	0.000001
Other gear	102	0.000707
Traps and lift nets	14,346	0.099832
Total	14,692	0.102239

**Benthos (Group 25)**

The benthos group in this model includes Echinoderms, Molluscs, Polychaetes and other benthic invertebrates. Bivalves such as the American cupped oyster (*Crassostrea virginica*), American sea scallop (*Placopecten magellanicus*), Atlantic razor clam (*Ensis directus*), Atlantic bay scallop (*Argopecten irradians*), Atlantic surf clam (*Spisula solidissima*), blue mussel (*Mytilus edulis*), European flat oyster (*Ostrea edulis*), Iceland scallop (*Chlamys islandica*), northern quahog (*Mercenaria mercenaria*), Ocean quahog (*Arctica islandica*), sand gaper (*Mya arenaria*) and Stimpston's surf clam (*Spisula polynyma*) are included.

Steimle (1987) estimates the biomass of benthic macrofauna of Georges Banks for 1977 (Table 43), with the wet weight of Mollusca being 50% shell. Theroux and Grosslein (1987) found that the biomass of the areas on the Georges Banks between the depths of 150 m and the continental shelf (200 m) was approximately 91 g/m<sup>2</sup>, which was used as an estimate of the biomass in the (deeper) Gulf of Maine. Thus, when estimating biomass by area, the total biomass of benthic macrofauna in the Gulf of Maine and Georges Banks was approximately 120 tonnes·km<sup>-2</sup>.

**Table 43.** Biomass estimates and P/B ratios of benthic macrofauna on Georges Banks and the Gulf of Maine (from Steimle, 1987 and Theroux and Grosslein, 1987).

Groups	Area	Wet weight (g·m <sup>-2</sup> )	P/B (year <sup>-1</sup> )
Annelida	-	14.1	1.8
Mollusca	-	195.5	1.0
Echinodermata	-	8.4	1.0
Miscellaneous	-	3.1	0.3
Total Georges Banks	53,000	166.6	-
Gulf of Maine	90,700	91.0	-
Total	143,700	118.9	1.025

Steimle (1987, Table 29.6) gave the annual P/B ratios for the benthic macrofauna resulting in an average P/B of 1.025 year<sup>-1</sup> (Table 43). The conversion efficiency (P/Q) of benthos is approximately 60% (Jørgensen *et al.*, 2000 Table 1-406). Benthic macrofauna were assumed to be detritivores, consuming 100% detritus (Bundy *et al.*, 2000).

Catches of sea scallops (*Placopecten magellanicus*) were very high on Georges Banks compared to that of the Mid-Atlantic (Lai and



Rago, 2000) during the 1977-1986 period, while ocean quahog (*Arctica islandica*) and Atlantic surfclams (*Spisula solidissima*) were caught mainly in the Mid-Atlantic/Southern New England area (Weinberg, 2000a and b). Thus, an average of 50% of the catch off Massachusetts were taken to be from the Georges Banks area (Table 44).

**Table 44.** Annual catch of benthos from the Gulf of Maine and Georges Banks.

Gear	Total catch (t)	Catch by area (t·km <sup>-2</sup> )
Bottom trawls	63	0.000442
Dredges	4,775	0.033225
Gillnets and entangling nets	8.6	0.000059
Other gear	5,195	0.036153
Surrounding nets	0.9	0.000006
Traps and lift nets	109	0.000761
Total	10,152	0.070646

### Macrozooplankton (Group 26)

Of the 96 species of zooplankton that occur in the area; 26 are endemic to Georges Bank (Davis, 1987). However, it is the widespread copepod *Calanus finmarchicus*, which dominates the biomass of macrozooplankton followed by the chaetognath *Sagitta elegans* (Davis, 1987).

Mean zooplankton biomass derived from 1977-1981 MARMAP data for Georges Bank was 4.7 g dry weight·m<sup>-2</sup> while the value for the Gulf of Maine was 7.9 g dry weight·m<sup>-2</sup> (Sherman *et al.*, 1987). The dry weight : wet weight conversion of 13% (Jørgensen, *et al.* 2000 Table 1-813) was used to get a biomass of 36 g wet weight·m<sup>-2</sup> and 61 g wet weight·m<sup>-2</sup> respectively for Georges Bank and the Gulf of Maine, which translated to a biomass of 52 tonnes·km<sup>-2</sup>.

Sissenwine *et al.* (1984) and Sherman *et al.* (1987) used an annual P/B of 7. Sherman *et al.* (1987) used a transfer efficiency of 32% as did Steele (1974). An unassimilated consumption ratio of 30% was applied (Sissenwine *et al.*, 1984). Macrozooplankton feed on microzooplankton and phytoplankton in a ratio 28:72 (Sissenwine *et al.*, 1984).

### Microzooplankton (Group 27)

Microzooplankton are the zooplankton that are smaller than 200 microns and include rotifers,

copepod nauplii, tintinnids, and peritrichs ([www.anserc.org/virtour/scope/micro.html](http://www.anserc.org/virtour/scope/micro.html)). According to Beers and Stewart (1969) and Sherman *et al.*, (1987) the biomass of microzooplankton is 43% of macrozooplankton biomass. The annual P/B of microzooplankton has been estimated at 25 (Banse and Mosher, 1980 and Sherman *et al.*, 1987), but a P/B of 40 was considered more representative (V. Christensen, UBC, pers. comm.). We used a transfer efficiency value of 32% following Sherman *et al.* (1987) and Steele (1974). Sissenwine *et al.* (1984) uses an unassimilated consumption ratio of 30%. Microzooplankton feed on phytoplankton.

### Phytoplankton (Group 28)

There is a distinct seasonality in the cycle of phytoplankton cell abundance and species dominance: on Georges Bank the spring bloom is of *Chaetoceros* spp., while the bloom in the Gulf of Maine is dominated by *Thalassiosira* (Cura, 1987).

The average chlorophyll-*a* concentration integrated over depth on the Georges Bank was approximately 75 mg chlorophyll-*a* /m<sup>2</sup> (Figure 21.3, O'Reilly *et al.*, 1987) and the chlorophyll-*a*: Carbon conversion of the two main species *Chaetoceros* and *Thalassiosira* is approximately 50 (Jørgensen *et al.*, 2000, Table 1-24), which translated to 3750 mgC·m<sup>-2</sup>. A carbon: dry weight conversion of 31% (Jørgensen *et al.*, 2000, Table 1-22) gives a dry weight of 12.1 g·m<sup>-2</sup> and a dry weight : wet weight conversion of 10 resulted in a biomass of 120.97 tonnes·km<sup>-2</sup> for Georges Bank. The chlorophyll-*a* concentration in the Gulf of Maine is approximately 82% that of Georges Bank (O'Reilly *et al.*, 1987, Table 21.2), thus the biomass in the Gulf of Maine is 99 tonnes·km<sup>-2</sup> and the total biomass is 107 tonnes·km<sup>-2</sup>.

O'Reilly *et al.* (1987) calculated the weighted average annual total primary production as: 333 gC·m<sup>-2</sup> for the Georges Bank, and 270 gC·m<sup>-2</sup> for the Gulf of Maine. Carbon content being 31% of dry weight and the wet weight : dry weight ratio of 10:1 (Jørgensen *et al.*, 2000), total production was estimated at 9,459 tonnes·km<sup>-2</sup>·year<sup>-1</sup> (wet weight) calculates an annual P/B of 88 (O'Reilly *et al.*, 1987).

1.5% of the phytoplankton is exported from the Gulf of Maine (Christensen *et al.*, 1996) which implies that only 98.5% is reduced to detritus.

## Detritus (Group 29)

Townsend (1997) suggests that the re-suspension of benthic material are in the order of 28-50 mgC·m<sup>-2</sup>·day<sup>-1</sup> (average of 39 mgC·m<sup>-2</sup>·day<sup>-1</sup>), which is approximately 142 tonnes wet weight·km<sup>-2</sup>·year<sup>-1</sup> when converted using 1 g C = 10 grams wet weight (Christensen and Pauly, 1992). This quantity of detritus is considered to be imported into the system.

The average annual primary production (PP) of the Gulf of Maine (270 gC·m<sup>-2</sup>·year<sup>-1</sup>) and Georges Bank (333 gC·m<sup>-2</sup>·year<sup>-1</sup>) was used in conjunction with the depth average euphotic zone (E, ranging between 17 and 42 meters, O'Reilly *et al.*, 1987) of 28 meters to calculate the detritus pool from Pauly *et al.*'s (1993) equation:

$\log_{10}D = -2.41 + 0.954 \log_{10}(PP) + 0.863 \log_{10}(E)$   
 The detritus pool was calculated to be approximately 155.7 tonnes wet weight·km<sup>-2</sup> when using the conversion 1 gC = 10 g wet weight (Christensen and Pauly, 1992).

## CONCLUSIONS

This Ecopath model of the Gulf of Maine was built to supplement the *Sea Around Us* database of the North Atlantic models: It should be expanded to include time series information, to verify the model structure and improve the sensitivity analysis. Additional economic information would make the model more complete and in that regard the evaluation of economic losses and biological impacts done by Ruttan *et al.* (2000) on the Gulf of Maine and George's Bank would be a logical complement. The Gulf of Maine is one of the most productive systems of the North American continent, and is has been extensively studied. It is a very information-rich system, and the information that could be added to the model would improve its general predictive capacity.

## ACKNOWLEDGEMENTS

The author wishes to thank the Pew Charitable trust for financial assistance of this project, as well as Andrew Cooper (Audubon Society of Long Island) and Villy Christensen (U.B.C. Fisheries Centre) for assistance with data collection and model construction. Editorial assistance was provided by Sylvie Guénette, Daniel Pauly, Villy Christensen and Gunna Weingartner of the Fisheries Centre, UBC.

## REFERENCES

- Anonymous. 2001. 2000 Stock Assessment and Fishery Evaluation (SAFE) Report for the Northeast Skate Complex. NMFS Report New England Fishery Management Council, NMFS. pp. 168.
- Backus R.H. and D. W. Bourne. 1987. Georges Bank. MIT Press, Cambridge Mass. pp. 593.
- Banase, K. and Mosher, S. 1980. Adult body mass and annual production/biomass relationships of field populations. *Ecological Monographs*, 50(3): 355-379.
- Bowman, R. E. 1981. Food of 10 species of Northwest Atlantic juvenile groundfish. *U.S. Fishery Bulletin* 79: 200-206.
- Brown, R. 2000. Haddock. In Status of the fishery resources of Northeast United States. NOAA Technical Memorandum NMFS-NE-115. [www.nefsc.nmfs.gov/sos/](http://www.nefsc.nmfs.gov/sos/)
- Buckel, J. A., Fogarty, M. J. and Conover, D. O. 1999. Foraging habits of bluefish, *Pomatomus saltatrix*, on the U.S. east coast continental shelf. *Fishery Bulletin*, 97: 758-775.
- Bundy, A., Lilly, G. R., Shelton, P. A. 2000. A mass balance model of the Newfoundland-Labrador shelf. Canadian Technical Report of Fisheries and Aquatic Sciences No. 2310, 157 pp.
- Cadrin, S. X. 2000a. Yellowtail Flounder. In Status of the Fishery off the Northeast United States. NOAA Technical Memorandum NMFS-NE-115. [www.nefsc.nmfs.gov/sos/](http://www.nefsc.nmfs.gov/sos/)
- Cadrin, S. X. 2000b. Longfin Inshore Squid. In Status of the Fishery off the Northeast United States. NOAA Technical Memorandum NMFS-NE-115. [www.nefsc.nmfs.gov/sos/](http://www.nefsc.nmfs.gov/sos/)
- Cadrin, S. X. 2000c. Northern Shrimp. In Status of the Fishery off the Northeast United States. NOAA Technical Memorandum NMFS-NE-115. [www.nefsc.nmfs.gov/sos/](http://www.nefsc.nmfs.gov/sos/)
- Casey, J.G., Hoey, J.J. and Grosslein, M.D. 1987. Large Pelagic Predators. In Georges Bank, pp. 351-355. Ed. by Backus, R.H. and Bourne, D.W. MIT Press, Cambridge, Mass.
- Christensen, J.P., Townsend, D.W., Montoya, J.P. 1996. Water column nutrients and sedimentary denitrification in the Gulf of Maine. *Continental Shelf Research*, 16(4): 489-515.
- Christensen, V., and D. Pauly. 1992. ECOPATH II - a software for balancing steady-state ecosystem models and calculating network characteristics. *Ecological Modelling*, 61:169-185.
- Cohen, E.B. and Grosslein, M.D. 1987. 37. Production on Georges Bank compared to other shelf ecosystems. In Georges Bank, pp. 383-391. Ed. by Backus, R.H. and Bourne, D.W. MIT Press, Cambridge, Mass.
- Collie, J.S. 1987. Food selection by yellowtail flounder (*Limanda ferruginea*) on Georges Bank. *Canadian Journal of Fishery and Aquatic Science*, 44: 357-367.
- Cura, J. J. J. 1987. 20 Phytoplankton. In Georges Bank, pp. 213-218. Ed. by Backus, R.H. and Bourne, D.W. MIT Press, Cambridge, Mass.
- Davis, C. S. 1987. Zooplankton life cycles. In Georges Bank, pp. 256-267. Ed. by Backus, R.H. and Bourne, D.W. MIT Press, Cambridge, Mass.
- Davis, B.M. and J.W. Foltz, 1991. Food of blueback herring and threadfin shad in Jocassee Reservoir, South Carolina. *Transactions of the American Fisheries Society*, 120(5): 05-613.
- Eggleston, D.B. and Bochenek, E.A. 1989. Stomach content and parasite infestation of school bluefin tuna *Thunnus thynnus* collected from the Middle Atlantic Bight, Virginia. *Fishery Bulletin (U.S.)*, 88: 389-395.

- Ennis, G.P. 1973. Food, feeding and condition of lobsters *Homarus americanus*, throughout the seasonal cycle in Bonavista Bay, Newfoundland. *Journal of the Fisheries Research Board of Canada* 30(12): 1905-1909.
- Fortier, L. and Villeneuve, A. 1996. Cannibalism and predation on fish larvae by larvae of Atlantic mackerel, *Scomber scombrus*: trophodynamics and potential impact on recruitment. *Fishery Bulletin*, 94: 268-281.
- Friedland, K. 2000. Atlantic and shortnose Sturgeons. In Status of the fishery off Northeast United States. NOAA Technical Memorandum NMFS-NE-115. [www.nefsc.nmfs.gov/sos/](http://www.nefsc.nmfs.gov/sos/)
- Garthe, S., Camphuysen, K.C.J. and Furness, R.W. 1996. Amounts of discards by commercial fisheries and their significance as food for seabirds in the North Sea. *Marine Ecology Progress Series*, 136: 1-11.
- Hammill, M.O. and Stenson, G.B. 2000. Estimated prey consumption by harp seals (*Phoca gronelandica*), Hooded seals (*Cystophora cristata*), Grey seals (*Halicoerus grypus*) and Harbour seals (*Phoca vitulina*) in Atlantic Canada. *Journal of Northwestern Atlantic Fisheries Science*, 26: 1-23.
- Hacunda, J.S., 1981. Trophic relationships among demersal fishes in a coastal area of the Gulf of Maine. *Fishery Bulletin*, 79(4): 775-788.
- Hendrickson, L. 2000a. Windowpane Flounder. In Status of the Fishery off the Northeast United States. NOAA Technical Memorandum NMFS-NE-115. [www.nefsc.nmfs.gov/sos/](http://www.nefsc.nmfs.gov/sos/)
- Hendrickson, L. 2000b. Northern Shortfin Squid. In Status of the fishery off the Northeast United States. NOAA Technical Memorandum NMFS-NE-115. [www.nefsc.nmfs.gov/sos/](http://www.nefsc.nmfs.gov/sos/)
- Hinrichs, R., 1985. Menge und Zusammensetzung der Nahrung beim Hering und Sprotte der Ostsee in den Jahren 1980-1982. *Fischereiforschung, Wiss. Schriftenreihe*, 23(1): 70-81.
- ICCAT. 2000. Detailed report of the ICCAT SCRS West Atlantic Bluefin Tuna stock assessment session. Madrid, Spain, September 18 to 22, 2000. 63 pp.
- Idoine, J. 2000a. Wolffish. In Status of the fishery off Northeast United States. NOAA Technical Memorandum NMFS-NE-115. [www.nefsc.nmfs.gov/sos/](http://www.nefsc.nmfs.gov/sos/)
- Idoine, J. 2000b. American Lobster. In Status of the fishery off Northeast United States. NOAA Technical Memorandum NMFS-NE-115. [www.nefsc.nmfs.gov/sos/](http://www.nefsc.nmfs.gov/sos/)
- Jørgensen, L.A., Jørgensen, S.E. and Nielsen, S.E. 2000. Ecotox; ecological modeling and toxicology. CD-ROM, Elsevier Science.
- Kendeigh, S.C., Dolnik, V.R. and Gavrillov, 1977. Avian energetics. In *Granivorous Birds in Ecosystems*, pp. 127-204. Ed. by J. Pinkowski and S.C. Kendeigh, Cambridge University Press.
- Kenney, R. D., Scott, G.P., Thompson, T.J., Winn, H.E. 1997. Estimates of prey consumption and trophic impacts of cetaceans in the USA Northeast continental shelf ecosystem. *Journal of Northwestern Atlantic Fisheries Science*, 22: 155-171.
- Konchina, V.Y. 1986. Fundamental trophic relationships of the rockfishes *Sebastes mentella* and *Sebastes fasciatus* (Scorpaenidae) of the northwestern Atlantic. *Journal of Ichthyology*, 26(1): 53-65.
- Lai, H., and P. J. Rago. 2000. Sea Scallops. In Status of the fishery off Northeast United States. NOAA Technical Memorandum NMFS-NE-115. [www.nefsc.nmfs.gov/sos/](http://www.nefsc.nmfs.gov/sos/)
- Langton, R.W. and R.E. Bowman, 1980. Food of fifteen northwest Atlantic Gadiform fishes. NOAA Technical Report NMFS SSRF-740, U.S. Department of Commerce in FishBase.
- Langton, R.W. and R.E. Bowman, 1981. Food of eight Northwest Atlantic Pleuronectiform Fishes. NOAA Technical Report NMFS SSRF-749, U.S. Department of Commerce [as cited in FishBase].
- Last, J. M., 1987. The food of immature sprat (*Sprattus sprattus* (L.)) and herring (*Clupea harengus*) in coastal waters of the North Sea. *Journal du Conseil International pour l'Exploration de la Mer*, 44: 73-79.
- Lewis, V. P. and D. S. Peters, 1994. Diet of juvenile and adult Atlantic menhaden in estuarine and coastal habitats. *Transactions of the American Fisheries Society*, 123(5): 803-810.
- Martini, F., Lesser, M. and Heiser, J. B. 1997. Ecology of the hagfish, *Myxine glutinosa* L., in the Gulf of Maine: II Potential impact on benthic communities and commercial fisheries. *Journal of Experimental Marine Biology and Ecology*, 214: 97-106.
- Mayo, R. K. 2000a. Redfish. In Status of the Fishery Resources off the Northeast United States. NOAA Technical Memorandum NMFS-NE-115. [www.nefsc.nmfs.gov/sos/](http://www.nefsc.nmfs.gov/sos/)
- Mayo, R. K. 2000b. Pollock. In Status of the fishery off the Northeast United States. NOAA Technical Memorandum NMFS-NE-115. [www.nefsc.nmfs.gov/sos/](http://www.nefsc.nmfs.gov/sos/)
- Mayo, R. K. 2000c. Silver hake. In Status of the fishery off Northeast United States. NOAA Technical Memorandum NMFS-NE-115. [www.nefsc.nmfs.gov/sos/](http://www.nefsc.nmfs.gov/sos/)
- Mayo, R. K., and L. O'Brien. 2000. Atlantic Cod. In Status of the Fishery Resources off the Northeastern United States. NOAA Technical Memorandum NMFS NE 115. [www.nefsc.nmfs.gov/sos/](http://www.nefsc.nmfs.gov/sos/)
- Nishiyama, T. 1977. Food-energy requirements of Bristol Bay sock-eye salmon *Oncorhynchus nerka* (Walbaum) during the last marine stage: In: Special Volume, The Research Institute of North Pacific Fisheries, pp. 289-320. Hokkaido University Faculty of Fisheries.
- Nitschke, P. 2000. Tilefish. In Status of the fishery off Northeast United States. NOAA Technical Memorandum NMFS-NE-115. [www.nefsc.nmfs.gov/sos/](http://www.nefsc.nmfs.gov/sos/)
- Nitschke, P., R. Brown, and L. Hendrickson. 2000. Winter Flounder. In Status of the Fisheries off the Northeast United States. NOAA Technical Memorandum NMFS-NE-115. [www.nefsc.nmfs.gov/sos/](http://www.nefsc.nmfs.gov/sos/)
- O'Brien, L. 1999. Factors influencing the rate of sexual maturity and the effect on spawning stock for the Georges Bank and Gulf of Maine Atlantic cod *Gadus morhua* stocks. *Journal of Northwestern Atlantic Fisheries Science*, 25: 179-203.
- O'Brien, L. 2000a. American Plaice. In Status of the Fishery off the Northeast United States. NOAA Technical Memorandum NMFS-NE-115. [www.nefsc.nmfs.gov/sos/](http://www.nefsc.nmfs.gov/sos/)
- O'Brien, L. 2000b. Cusk. In Status of the fishery off Northeast United States. NOAA Technical Memorandum NMFS-NE-115.
- O'Reilly, J.E.; Evans-Zetlin, C. and Busch, D.A. 1987. Primary Production. In *Georges Bank*, pp. 220-233. Ed. by Backus, R.H. and Bourne, D.W., MIT Press, Cambridge, Mass.
- Overholtz, W. J. 2000a. Atlantic Mackerel. In Status of the Fishery off the Northeast United States. NOAA Technical Memorandum NMFS-NE-115. [www.nefsc.nmfs.gov/sos/](http://www.nefsc.nmfs.gov/sos/)
- Overholtz, W. J. 2000b. Atlantic herring. In Status of the fishery off Northeast United States. NOAA Technical Memorandum NMFS-NE-115. [www.nefsc.nmfs.gov/sos/](http://www.nefsc.nmfs.gov/sos/)
- Pauly, D., Soriano-Bartz, M.L. and M. L. C. Palomares. 1993. Improved construction, parameterisation and interpretation of steady-state ecosystem models. In

- Trophic models of aquatic ecosystems, pp. 1-13. Ed. by Christensen, V. and Pauly, D. ICLARM Conference Proceedings.
- Payne, P.M. and Selzer, L.A. 1989. The distribution, abundance and selected prey of the harbor seal, *Phoca vitulina concolor*, in Southern New England. *Marine Mammal Science*, 5(2): 173-192.
- Pinkas, L., Oliphant, M. S. and Iverson, I. L. K. 1971. Food habits of Albacore, Bluefin tuna and Bonito in California Waters. Dept. Fish and Game. *Fish Bulletin* 152:1-105.
- Powers, K. D. and Brown, R. G. B. 1987. Seabirds. In Georges Bank, pp. 359-371. Ed. by Backus, R.H. and Bourne, D.W., MIT Press, Cambridge Mass.
- Powers, K. D. and Backus, E.H. 1987. Energy transfer to seabirds. In Georges Bank, pp. 372-374. Ed. by Backus, R.H. and Bourne, D.W., MIT Press, Cambridge Mass.
- Rago, P. J., K. A. Sosebee, J. K. T. Brodziak, S. A. Murawski, and E. D. Anderson. 1998. Implications of recent increases in catches on the dynamics of Northwest Atlantic spiny dogfish (*Squalus acanthias*). *Fisheries Research*, 39:165-181.
- Raloff, J. 1996. Fishing for answers. *Science News*, 150: 268-271.
- Richards, A. 2000. Goosefish. In Status of the fishery off Northeast United States. NOAA Technical Memorandum NMFS-NE-115. [www.nefsc.nmfs.gov/sos/](http://www.nefsc.nmfs.gov/sos/)
- Robb, A. P. and J. R. G. Hislop, 1980. The food of five gadoid species during the pelagic 0-group phase in the northern North Sea. *Journal of Fish Biology*, 16:199-217.
- Ruttan, L.M., Gayanilo, F.C. Jr., Sumaila, U.R. and Pauly, D. 2000. Small versus large-scale fisheries: a multi-species, multi-fleet model for evaluating their interactions and potential benefits. pp. 64-78. In: Methods for evaluating the impacts of Fisheries on North Atlantic Ecosystems. Ed. by D. Pauly and T.J. Pitcher. Fisheries Centre Research Report 8(2).
- Ryan, T., Watson R. and Pauly D. 2001. Key features of commercial and recreational fisheries statistics from the US Atlantic coast. pp. 225-227. In: Fisheries Impacts on North Atlantic Ecosystems: Catch, Effort and National/Regional Data Sets. Ed. by D. Zeller, R. Watson, and D. Pauly. Fisheries Centre Research Report 9(3).
- Shepherd, G. 2000a. Bluefish. In Status of the fishery resources of Northeast United States. NOAA Technical Memorandum NMFS-NE 115. [www.nefsc.nmfs.gov/sos/](http://www.nefsc.nmfs.gov/sos/)
- Shepherd, G. 2000b. Striped bass. In Status of the fishery off the Northeast United States. NOAA Technical Memorandum NMFS-NE-115. [www.nefsc.nmfs.gov/sos/](http://www.nefsc.nmfs.gov/sos/)
- Sherman, K., Smith, W. G., Green, J. R., Cohen, E. B., Berman, M.S., Marti, K. A. and Goulet, J. R. 1987. 25. Zooplankton production and the fisheries of the Northeastern Shelf. In Georges Bank, pp. 268-282. Ed. by Backus, R.H. and Bourne, D.W., MIT Press, Cambridge Mass.
- Sissenwine, M. P. 1987. 31. Fish and Squid production. In Georges Bank, pp. 347-350. Ed. by Backus, R.H. and Bourne, D.W., MIT Press, Cambridge Mass.
- Sissenwine, M. P., Cohen, E. B., Grosslein, M.D. 1984. Structure of the Georges Bank ecosystem. *Rapports et Procès-Verbaux des Réunions du Conseil International pour l'Exploration de la Mer*, 183: 243-254.
- Sosebee, K. A. 2000a. Skates. In Status of the Fishery Resources off the Northeastern United States. NOAA Technical Memorandum NMFS NE 115. [www.nefsc.nmfs.gov/sos/](http://www.nefsc.nmfs.gov/sos/)
- Sosebee, K. A. 2000b. White hake. [Same as Sosebee 2000a].
- Sosebee, K. A. 2000c. Red hake. [Same as Sosebee 2000a]
- Sosebee, K. A. 2000d. Spiny dogfish. [Same as Sosebee 2000a]
- Steele, J.H. 1974. The structures of Marine Ecosystems. Harvard University Press, Cambridge, Massachusetts. 1287 pp.
- Steimle, F.W. 1987. 29. Production by the benthic fauna. In Georges Bank, pp. 310-314. Ed. by Backus, R.H. and Bourne, D.W., MIT Press, Cambridge Mass.
- Stevenson, D. K. and Braasch, E. F. 1994. Gulf of Maine Habitat: Workshop Proceedings: Sea Grant Report #UNHMP-T/DR-SG-94-18. West Boothbay Harbour, Maine, Regional Association for Research on the Gulf of Maine: 1-143 ([www.nml.dartmouth.edu/rargom/habitat.html](http://www.nml.dartmouth.edu/rargom/habitat.html)).
- Stillwell, C. E., and N. E. Kohler. 1985. Food and feeding ecology of the swordfish *Xiphias gladius* in the western North Atlantic Ocean with estimates of daily ration. *Marine Ecology Progress Series*, 22:239-247.
- Stone, H. H. and Jessop, B. M. 1994. Feeding habits of anadromous alewives, *Alosa pseudoharengus*, off the Atlantic Coast of Nova Scotia. *Fishery Bulletin*, 92(1): 157-170.
- Templeman, W. 1985. Stomach contents of Atlantic Wolffish (*Anarhichas lupus*) from the Northwest Atlantic. *NAFO Science Council Studies*, 8: 49-51.
- Terceiro, M. 2000. Summer Flounder. In: Status of the fishery off the Northeast United States. NOAA Technical Memorandum NMFS-NE-115, NOAA, [www.nefsc.nmfs.gov/sos/](http://www.nefsc.nmfs.gov/sos/)
- Theroux, R. B., and M. D. Grosslein. 1987. Benthic fauna. In Georges Bank, pp. 283-295. Ed. by Backus, R.H. and Bourne, D.W., MIT Press, Cambridge Mass.
- Townsend, D. W. 1997. Cycling of carbon and nitrogen in the Gulf of Maine. In Proceedings of the Gulf of Maine Ecosystem Dynamics Scientific Symposium and Workshop. RARGOM Report, pp. 117-134. Ed. by Wallace, G.T. and Braasch, E.F., Hanover NH.
- Townsend, D. W. 1998. Sources and cycling of nitrogen in the Gulf of Maine. *Journal of Marine Systems*, 16: 283-295.
- Trites, A. W. and Pauly, D. 1998. Estimating mean body masses of marine mammals from maximum body lengths. *Canadian Journal of Zoology*, 76: 886-896.
- Vinogradov, V. I., 1984. Food of silver hake, red hake and other fishes of Georges Bank and Adjacent Waters, 1968-74. *NAFO Science Council Studies*, 7: 87-94.
- Weinberg, J. 2000a. Ocean Quahog. In Status of the fishery off Northeast United States. NOAA Technical Memorandum NMFS-NE-115. [www.nefsc.nmfs.gov/sos/](http://www.nefsc.nmfs.gov/sos/)
- Weinberg, J. 2000b. Atlantic surfclam. In Status of the fishery off Northeast United States. NOAA Technical Memorandum NMFS-NE-115. [www.nefsc.nmfs.gov/sos/](http://www.nefsc.nmfs.gov/sos/)
- Whitehead, P. J. P., 1985. FAO species catalogue. Vol. 7. Clupeoid fishes of the world. An annotated and illustrated catalogue of the herrings, sardines, pilchards, sprats, shads, anchovies and wolf-herrings. Part 1 - Chirocentridae, Clupeidae and Pristigasteridae. *FAO Fisheries Synopsis*, 125 7(1). 303 pp.
- Wiens, J. A. and Scott, J. M. 1975. Model estimation of energy flow in Oregon coastal seabird populations. *Condor*, 77: 439-452.
- Wigley, S. E. 2000a. Witch Flounder. In Status of the Fisheries off Northeast United States. NOAA Technical Memorandum NMFS-NE-115. [www.nefsc.nmfs.gov/sos/](http://www.nefsc.nmfs.gov/sos/)
- Wigley, S. E. 2000b. Ocean pout. In Status of the fishery off Northeast United States. NOAA Technical Memorandum NMFS-NE-115. [www.nefsc.nmfs.gov/sos/](http://www.nefsc.nmfs.gov/sos/)
- Winn, H.E., Hain, J.H.W., Hyman, M.A.M. and Scott, G.P. 1987. 36. Whales, dolphins and porpoises. In Georges Bank. pp. 375-387, Ed. by Backus, R.H. and Bourne, D.W., MIT Press, Cambridge Mass.

## A 'STRAW-MAN' ECOPATH MODEL OF THE MIDDLE ATLANTIC BIGHT CONTINENTAL SHELF, UNITED STATES

**Thomas A. Okey**

*Fisheries Centre, University of British Columbia  
2204 Main Mall, Vancouver, BC, Canada, V6T 1Z4  
email: t.okey@fisheries.ubc.ca*

### ABSTRACT

A considerable amount of information exists about the biological communities of the 'Middle Atlantic Bight' continental shelf (United States), and a number of scientific efforts have summarized and integrated various components of this system. A constant challenge for scientists, managers, and policy makers is that natural complexities and uncertainties can render the usefulness of food web models difficult to gauge, though research groups from the region are working to meet this challenge. No approach can enable complete understanding of an ecosystem, but new advances in modeling tools can help describe the interactions within marine food webs (and ecosystems). These cohesive descriptions of the changing states and dynamics of food webs are transparent and relatively accessible to all interested parties. A preliminary model of the Middle Atlantic Bight continental shelf food web was constructed using Ecopath with Ecosim, as a way to complement current ecological characterizations. The current model is considered a preliminary 'straw-man,' and was built as a focal point for future refinements. The defined area covered by this model extends from the SE tip of Cape Cod, Massachusetts in the north to Cape Hatteras, North Carolina in the south, and from the intertidal (and the entrance of estuarine systems) to the shelf break at the 200 m isobath. This preliminary model was designed to characterize the four years from 1995 to 1998.

### INTRODUCTION

The continental shelf ecosystems adjacent to the east coast of the United States are among the best studied marine ecosystems in the world. Given the importance of this region for supporting fisheries, combined with availability of broad ecological information, it is not surprising that food web models have been constructed and employed to characterize particular areas in the region.

A number of ecosystem models (or multi-species models) have been constructed for systems within the marine areas off the Northeastern United States (Brown *et al.*, 1976; Cohen *et al.*, 1982; Murawski, 1984; Sissenwine *et al.*, 1984; Overholtz and Tyler, 1986; Fogarty *et al.*, 1991; Overholtz *et al.*, 1991; Link, 1999). This body of work, along with overarching scientific programs such as the food web dynamics program of the Northeast Fisheries Science Center at Woods Hole, Massachusetts (see Link and Almeida, 2000) and previous programs such as the Marine Resource Monitoring and Assessment Program (MARMAP), represent a good framework for organizing a broad array of information on fisheries, diet compositions, biomasses, and other biological characteristics collected during the last few decades in the region.

The Southeast Area Monitoring and Assessment Program (SEAMAP) and the South Atlantic Bight Recruitment Experiment program (SABRE) are other sources of good biological information with some relation to the Middle Atlantic Bight. Numerous up-to-date assessments of fishery and marine mammal stocks in the marine areas off the Northeastern United States are also rich sources of information for piecing together a cohesive picture of the system as a whole (see Table 1 for these citations). Some other sources are also available for putting stock changes into historical context (e.g., Reeves *et al.*, 1999).

The area of focus for the present modeling effort is the Middle Atlantic Bight continental shelf, here defined as extending roughly from Cape Cod Massachusetts (excluding George's Bank) to Cape Hatteras, North Carolina.

The previous modeling efforts in this region have been a crucial aspect of efforts to synthesize the vast information collected in these programs, as well as information that has accumulated during the last century. For example, whole-system approaches to fishery management dilemmas have been recently undertaken (Fogarty and Murawski, 1998; Overholtz *et al.*, 1999, 2000). Unlike some past approaches, this new generation of whole-system analyses has the potential to be transparent and accessible to researchers and non-researchers alike.

Newly emerging approaches to whole-ecosystem trophic modeling, such as Ecopath with Ecosim, now enable scientists to simultaneously simulate the potential direct and indirect effects of human activities on these naturally dynamic systems (Pauly *et al.*, 2000). In this approach, a preliminary model must be constructed and

subjected to refinement and criticism through several iterations, and on several levels, before dynamic Ecosim analyses can be conducted in a useful enough manner to support fisheries and conservation policy decision-making.

The goal of the work documented in the present contribution was to construct a 'straw-man' Ecopath model using some of the best information available, and which can be evaluated in the context of past models and newly emerging information. This exercise was conducted to provide an operational framework for collaborative refinement of this 'straw-man' model in the near future. It is not the purpose of this paper to explain the Ecopath with Ecosim approach in detail, or to discuss particular simulations or analyses that will be possible once the model has been constructed and refined (but see other contributions in this volume).

## METHODS

Ecopath models are static descriptions of biotic flows in food webs. They include all biotic components of an ecosystem, and the most typical currency used is biomass (in wet weight). Polovina (1984) originally developed the Ecopath approach for application to the coral reefs of the French Frigate Shoals.

Since then, a variety of dynamic capabilities have been added to Ecopath with Ecosim (e.g., Christensen and Pauly, 1992; Walters *et al.*, 1997; Walters *et al.*, 1999; Christensen *et al.*, 2000; Pauly *et al.*, 2000). These dynamic simulation capabilities allow explorations of the potential effects of human activities (e.g., fisheries and other disturbances or stressors) on the biological components in a system (Pauly *et al.*, 2000), and are thus a key reason for constructing Ecopath models. However, these dynamic approaches were not discussed here. Scores of applications of Ecopath with Ecosim can be found at [www.ecopath.org](http://www.ecopath.org).

### **The Ecopath foundation**

The Ecopath 'master equation' (Equation 1) states that the net production of a functional group equals the total mass (or energy) of that group that is removed by predators and fisheries plus the net biomass accumulation in the group plus the net migration of the group's biomass plus the mass flowing to detritus. This master equation also indicates the basic parameters needed to construct an Ecopath model.

$$B_i \cdot (P/B)_i \cdot EE_i = Y_i + \sum B_j \cdot (Q/B)_j \cdot DC_{ji} + BA_i + NM_i \quad \dots 1)$$

$B_i$  and  $B_j$  are biomasses of prey ( $i$ ) and predators ( $j$ ) respectively;

$P/B_i$  is the production/biomass ratio, equivalent to total mortality ( $Z$ ) in most circumstances (Allen, 1971);

$EE_i$  is the ecotrophic efficiency; the fraction of the total production of a group that is utilized in the system;

$Y_i$  is the fisheries catch per unit area and time (i.e.,  $Y = F \cdot B$ );

$Q/B_j$  is the food consumption per unit biomass of  $j$ ; and

$DC_{ji}$  is the contribution of  $i$  to the diet of  $j$ ;

$BA_i$  is the biomass accumulation of  $i$  (positive or negative);

$NM_i$  is the net migration of  $i$  (emigration less immigration).

This equation describes the law of conservation of mass or energy, or the inescapable 'truth' of thermodynamic *continuity* in a system of energy or biomass flows. This law must apply to dynamic systems as well as 'steady-states,' and it must also apply to each component of such systems (i.e., functional groups). Representative estimates of the parameters are derived for each functional group using sums or appropriately weighted estimates of functionally aggregated species (also see Okey and Pugliese, and other contributions in this volume for further explanation of Ecopath basics).

### **Defining the system**

The Middle Atlantic Bight (MAB) is generally considered to extend from Cape Cod Massachusetts in the north, to Cape Hatteras, North Carolina, in the south; and the seaward boundary is the shelf slope break (Pearce, 2000). These geographic boundaries are conventionally used because they also delineate oceanographic, ecological, and other physical boundaries. For the purposes of the present Ecopath model, the northern boundary of the area is a line extending from the Chatham lighthouse on the elbow of Cape Cod extending southeast along the Great South Channel to a point on the shelf break south of George's bank (69° W Longitude, 40.25° N Latitude). The southern boundary is the latitude of Cape Hatteras. The shallow edge of the area is the upper intertidal and the entrance of estuarine systems; and the deeper edge is the 200 m isobath, which delineates the shelf break. The area covers approximately 111,200 km<sup>2</sup>. The preliminary MAB model is designed to

characterize four years during in the late 1990s (1995-1998).

### ***Assembling the list of species***

Four major sources were used to assemble the list of over 400 species included in the Ecopath model of the Middle Atlantic Bight continental shelf system: (1) the National Marine Fisheries service (NMFS) recreational fish landings for the eight states; (2) NMFS commercial fish landings for the eight states; (3) a list previously developed for the South Atlantic States continental shelf (Okey and Pugliese, this volume); and (4) The NMFS marine mammal stock assessments (NMFS, 2000). In addition, two sea turtle web resources were consulted for information on turtles: [www.nmfs.noaa.gov/prot\\_res/PR3/Turtles/turtles.html](http://www.nmfs.noaa.gov/prot_res/PR3/Turtles/turtles.html) and [www.ccturtle.org/species.htm](http://www.ccturtle.org/species.htm).

### ***Aggregation of functional groups***

The same approach was taken to aggregate all species in this continental shelf ecosystem list into 55 functional groups (as also used by Okey and Pugliese, this volume). These preliminary groups were chosen based on several criteria, the food web of 75 groups presented by Link (1999) was used as a general guide. Some of the original 75 groups were aggregated while some others were added. Groups managed under a federal fishery management plan and fish groups for which commercial or recreational landings exceeded 200 tonnes in any of the states within each area were included as explicit groups in the model. After identification and addition of these explicit groups, species lists representing the remaining components of the system were aggregated into functional groups based on knowledge of natural history and diet. The functional group aggregation in this 'straw-man' model is intended as preliminary. It was considered that refining the structure (aggregation) of the system would provide ample room for debate, and that a framework for broad collaboration might be the best approach for refining the model in the future. Some preliminary suggestions for restructuring the current 'straw-man' model are presented in the Discussion.

### ***Sources of the basic input parameters***

The 'basic input parameters' of the Ecopath model are biomass (B), the ratio of production to biomass (P/B), the ratio of consumption to biomass (Q/B), and diet composition. A variety of sources were conducted to derive estimations for

these basic input parameters, and these sources are shown in Table 1. Other basic parameters include biomass accumulation, migration, the ratio of unassimilated to consumed food, and the ratio of production to consumption (P/Q).

### ***Biomass estimations***

The biomass of 26 out of the 55 groups in the straw-man MAB model were estimated as inputs of the model; biomasses for the rest of the groups in the model were estimated by the Ecopath routine. Most of the 26 biomass input estimations were based on a suite of up-to-date population assessments in the region (Table 1). Most of these biomasses applied to stocks with ranges larger than the Middle Atlantic Bight, and were thus adjusted by assumed conversion factors representing an estimated proportion of the assessed stock within the MAB model area. These conversion factors are probably a large source of error. Future iterations of this model should include rigorous approaches for estimating relative proportion of assessed stocks occurring within the modeled area during a given year. Estimations of stock size in marine mammal assessments were converted to biomasses using average body mass estimations from Trites and Pauly (1998), and other sources.

### ***P/B estimations***

A variety of sources were consulted during the derivations of P/B values for the 55 functional groups (Table 1), and different approaches were used for these derivations. Some studies directly measured production rates of the organisms in question. Values estimated from within ecologically similar systems were preferred when available. Another common approach was to use an estimate of total mortality as a proxy for P/B. This method is based on Allen (1971): the production rate (P/B) equals the total mortality of a population, and the total mortality equals the sum of natural mortality and fishing mortality ( $P/B = Z = M + F$ ). This relationship should be reliable when a species, or functional group, spends its whole life cycle within the system of interest, and accurate mortality estimates are available. In such an open and dynamic system as the Middle Atlantic Bight, these assumptions do not apply to all functional groups. In cases of aggregated functional groupings, P/B values for individual species were weighted based on the relative biomass of the species in the functional group, or a P/B estimate from representative species were used.

**Table 1.** Sources of basic parameter estimates. The values used as inputs in the 'straw-man' Middle Atlantic Bight shelf model were derived from these sources based on their application to the defined system, rather than being simply extracted.

<b>Group name</b>	<b>Biomass (t·km<sup>-2</sup>)</b>	<b>P/B (year<sup>-1</sup>)</b>	<b>Q/B (year<sup>-1</sup>)</b>	<b>Diet composition</b>
Billfishes	-	Mackinson (2000)	Mackinson (2000)	Mackinson (2000)
Bluefish	Shepherd (2000a)	Shepherd (2000a)	Palomares & Pauly (1989, 1999); Froese & Pauly (2001)	NMFS (unpublished data)
Tunas	Heymans (this volume)	Heymans (this volume)	Heymans (this volume)	Mackinson (2000)
Dolphins & porpoise	NMFS (2000)	Matkin and Hobbs (1999b)	Kastelein <i>et al.</i> (1997); Matkin & Hobbs (1999b)	
Seals	Payne and Selzer (1989); NMFS (2000)	Banse & Mosher (1980); Trites & Pauly (1998); Heymans (this volume)	Hammill & Stenson (2000); Sissenwine (1987) in Heymans (this volume)	from Heymans (this volume)
Goosefish	-	Froese & Binohlan (2000); Froese & Pauly (2001)	Palomares & Pauly (1989, 1999); Froese & Pauly (2001)	NMFS (unpublished data)
Coastal sharks	SEAMAP-SA / SCMRD (2000)	Sissenwine (1987); Heymans (this volume)	Acosta <i>et al.</i> (1998)	Mackinson (2000)
Marine birds	-	Acosta <i>et al.</i> (1998)	Powers & Backus (1987) in Heymans (this volume)	Powers & Backus (1987) in Heymans (this volume)
Striped bass	Shepherd (2000b)	Froese & Binohlan (2000); Froese & Pauly (2001); NMFS (2000)	Palomares & Pauly (1989, 1999); Froese & Pauly (2001)	Stevens (1966)
Weakfish	-	Froese & Binohlan (2000); Froese & Pauly (2001)	Palomares & Pauly (1989, 1999); Froese & Pauly (2001)	NMFS (unpublished data)
Snapper / grouper	Mackinson (2000)	Mackinson (2000)	Mackinson (2000)	Mackinson (2000)
Baleen whales	Dolphin (1987); NMFS (2000)	Matkin and Hobbs (1999a)	Dolphin (1987)	From Matkin and Hobbs (1999a)
Jacks	-	Mackinson (2000)	Mackinson (2000)	Mackinson (2000)
Spiny dogfish	Sosebee (2000a)	Sosebee (2000a); Froese & Pauly (2001)	Palomares & Pauly (1989, 1999); Froese & Pauly (2001)	NMFS (unpublished data)
Benthic piscivores	Heymans (this volume)	Mackinson (2000)	Palomares & Pauly (1989, 1999); Froese & Pauly (2001)	NMFS (unpublished data)
Black seabass	-	Froese & Binohlan (in press.); Froese & Pauly (2001)	Palomares & Pauly (1989, 1999); Froese & Pauly (2001)	NMFS (unpublished data)
Demersal piscivores	-	Sissenwine (1987) and Heymans (this volume)	Sissenwine (1987); Martini <i>et al.</i> (1997) in Heymans (this volume)	Mackinson (2000)
Octopods	-	Buchan and Smale (1981)	Guerra (1979) in Pauly <i>et al.</i> (1993)	Okey (2000)
Cods and hakes	Mayo and O'Brien (2000), Brown (2000), Brodziak (2000a,b), Sosebee (2000b, 2000c)	Cohen <i>et al.</i> (1982); Heymans (this volume)	Cohen <i>et al.</i> (1982); Froese & Pauly (2001); Heymans (this volume); but see Durbin <i>et al.</i> (1983)	NMFS (unpublished data)
Redfish	Heymans (this volume)	Cohen <i>et al.</i> (1982); Sissenwine (1987)	Cohen <i>et al.</i> (1982); Sissenwine (1987)	Konchina (1986); Vinogradov (1984)
Lg. pel. planktivores	-	Sissenwine (1987)	Mackinson (2000)	NMFS (unpublished data)
Mackerel	Overholtz (2000a)	Cohen <i>et al.</i> (1982); Sissenwine (1987)	Cohen <i>et al.</i> (1982); Sissenwine (1987)	NMFS (unpublished data)
Drum / croaker	SEAMAP-SA / SCMRD (2000)	Mackinson (2000)	Mackinson (2000)	Mackinson (2000)
Benth. invert. eaters	-	Mackinson (2000)	Mackinson (2000)	NMFS (unpublished data for sea raven and longhorn sculpin)
Butterfishes	SEAMAP-SA / SCMRD (2000)	Froese & Binohlan (2000); Froese & Pauly (2001)	Palomares & Pauly (1989, 1999); Froese & Pauly (2001)	NMFS (unpublished data)
Squid	-	Cohen <i>et al.</i> (1982); Sissenwine (1987)	Cohen <i>et al.</i> (1982); Sissenwine (1987)	NMFS (unpublished data)
Atlantic salmon	-	Froese & Binohlan (2000); Froese & Pauly (2001)	Palomares & Pauly (1989, 1999); Froese & Pauly (2001)	Values inspired by Keeley and Grant (1997)



**Table 1** continued

<b>Group name</b>	<b>Biomass (t·km<sup>-2</sup>)</b>	<b>P/B (year<sup>-1</sup>)</b>	<b>Q/B (year<sup>-1</sup>)</b>	<b>Diet composition</b>
Atlantic menhaden	-	Sissenwine (1987); Heymans (this volume)	Sissenwine (1987); Froese & Pauly (2001)	Vinogradov (1984)
Forage fish	Overholtz (2000b)	Sissenwine (1987); Heymans (this volume)	Cohen <i>et al.</i> (1982); Sissenwine (1987); Stone & Jessop (1994)	NMFS (unpublished data)
Dem. planktivores	-	Mackinson (2000)	Mackinson (2000)	Mackinson (2000)
Tilefish	Nitschke (2000)	Froese & Binohlan (2000), Froese & Pauly (2001), Nitschke (2000)	Palomares & Pauly (1989, 1999); Froese & Pauly (2001)	Sierra <i>et al.</i> (1994)
Flounders	Hendrickson (2000a,b), Terceiro (2001), Cadrin (2000), Wigley (2000), Nitschke <i>et al.</i> (2000)	Cohen <i>et al.</i> (1982); Heymans (this volume); Sissenwine (1987)	Cohen <i>et al.</i> (1982); Sissenwine (1987); but see Huebner & Langton (1981)	NMFS (unpublished data)
Euphausiids	-	Tanasichuk (1998)	-	T.A. Okey (estimation)
Scup	-	Froese & Binohlan (2000); Froese & Pauly (2001)	Palomares & Pauly (1989, 1999); Froese & Pauly (2001)	NMFS (unpublished data)
Lobsters	-	Arreguín-Sánchez <i>et al.</i> (1993)	Arreguín-Sánchez <i>et al.</i> (1993)	adapted from Martínez (2000)
Ocean pout	-	Froese & Binohlan (2000); Froese & Pauly (2001)	Palomares & Pauly (1989, 1999); Froese & Pauly (2001)	NMFS (unpublished data)
Stomatopods	-	Meyer & Caldwell (2000)	Meyer & Caldwell (2000)	Meyer & Caldwell (2000)
Dem. invert. eaters	-	Sissenwine (1987) and Heymans (this volume)	Sissenwine (1987)	Mackinson (2000)
Rays and skates	-	Sosebee (2000d), Froese & Binohlan (2000), Froese & Pauly (2001)	Heymans (this volume)	NMFS (unpublished data)
Jellies	-	Okey <i>et al.</i> (1999)	Graham (2000)	Okey <i>et al.</i> (1999)
Mysids	-	Azeiteiro <i>et al.</i> (1999)	-	T.A. Okey (estimation)
Macrozooplankton	Heymans (this volume)	Cohen <i>et al.</i> (1982); Sissenwine <i>et al.</i> (1984); Sherman <i>et al.</i> (1987)	-	Sissenwine <i>et al.</i> (1984)
Crabs	-	Ehrhardt and Restrepo (1989)	Arreguín-Sánchez <i>et al.</i> (1993)	Bundy (2000)
Spot	-	Froese & Binohlan (2000); Froese & Pauly (2001)	Palomares & Pauly (1989, 1999); Froese & Pauly (2001)	Adams (1976)
Shrimp	-	Parrack (1981); Arreguín-Sánchez <i>et al.</i> (1993); Okey & Nance (2000)	Arreguín-Sánchez <i>et al.</i> (1993)	Bundy (2000)
Echonoderms	Steimle (1987) and Theroux and Grosslein (1987)	Opitz (1993)	Pauly <i>et al.</i> (1993) in Heymans (this volume)	Okey (2000 a)
Sessile epibenthos	-	Odum and Odum (1955) and Sorokin (1987) in Opitz (1993)	Wilkinson (1987); Sorokin (1987) in Opitz (1993)	Okey (2000 b)
Polychaetes	-	Pagliosa Alves and Lana (1998)	-	T.A. Okey (estimation)
Small crustaceans	-	Sanders (1956), Arreguín-Sánchez <i>et al.</i> (1993)	Arreguín-Sánchez <i>et al.</i> (1993)	T.A. Okey (estimation)
Bivalves	Lai and Rago (2000)	Arnold <i>et al.</i> (2000)	Guénette (1996)	Arnold <i>et al.</i> (2000)
Microzooplankton	Heymans (this volume)	Banse and Mosher 1980	-	Sissenwine <i>et al.</i> (1984)
Phytoplankton	Cura (1987), O'Reilly <i>et al.</i> (1987)	O'Reilly <i>et al.</i> (1987); Cahoon and Cooke (1992)	n/a	n/a
Macrophytes	-	Luning (1990)	n/a	n/a
Microphytobenthos	-	Cahoon and Cooke (1992)	n/a	n/a
Detritus	Heymans (this volume)	n/a	n/a	n/a

### *Q/B estimations*

Sources of Q/B estimates are listed in Table 1. The ratio of annual consumption to biomass (Q/B) for a functional group is the annual food ration for that group relative to its average annual standing biomass. The most common approach used for estimating Q/B for a given functional group in the Middle Atlantic Bight Ecopath model is based on an empirically based equation originally derived, and later refined, by Palomares and Pauly (1989, 1999). This approach is used to estimate Q/B based on a species' maximum or asymptotic weight ( $W_{int}$ ), the mean ambient water temperature, the food type, and the tail aspect ratio, which indicates a species' metabolic characteristics. This approach applies only to fishes, and a 'Q/B calculator' in FishBase, the global database on fishes (Froese and Pauly, 2001), can be used to make these estimations for individual fish species. Representative averages of these estimations for the species in a functional group were obtained by weighting the species-specific estimates by relative consumption or biomass of each species. Other approaches for estimating Q/B include direct measurement in the context of empirical studies, and these were usually the sources of invertebrate Q/B estimations. I incorporated Q/B estimations from the empirically based relationship described above, from empirical studies, and sometimes from identical or similar functional groups from similar Ecopath models.

### ***Sources of diet composition information***

The Middle Atlantic Bight Ecopath model features the extensive diet composition information gathered during the last 28 years during the food web dynamics program of the Northeast Fisheries Science Center, at Woods Hole, Massachusetts (NMFS, unpublished data; Link, 1999; Link and Almeida, 2000). This information consists of species-specific diet compositions collected from myriad stomachs analyzed in this program (diet compositions generated for most species were based on a minimum of 250 stomachs). These data were adapted to the functional groupings chosen for this model using an Excel spreadsheet. Other sources of diets used in this preliminary model are shown in Table 1.

### ***Source of fisheries information***

The commercial fisheries catch data from the NMFS database ([www.st.nmfs.gov/st1/](http://www.st.nmfs.gov/st1/)) were used to estimate the average annual commercial and recreational fisheries landings in Rhode Island, Connecticut, New York, New Jersey, Delaware, Maryland, and Virginia during the late

1990s (1995-1998). Twenty five percent of the Massachusetts landings for each species were also included. This is an arbitrary proportion used for convenience during this 'straw-man' phase of model development. In the future, a rigorous method should be developed to assign a more correct proportion of the Massachusetts fishing effort to the defined Middle Atlantic Bight system. Discards were taken to be 20% of the landings across-the-board, and these 'place-holder' discard values were entered in the discard interface of EwE.

### ***Balancing the model***

The initial input parameters of the Middle Atlantic Bight Ecopath model comprised a model that was remarkably close to being thermodynamically balanced at the outset. When the model was first run to calculate basic parameters, thermodynamic discontinuities ('unbalanced' groups) are indicated when ecotrophic efficiency values exceed 1.0 for a particular group. This means the energy produced by that group is exceeded by the predatory demand on that group (including fishing mortality). Such a group is brought back into energy continuity ('balance') by either decreasing predatory consumption on that group through adjustment of consumption rates (Q/Bs) or proportions (diet compositions), or by upwards adjustments of the biomass of the group or its production rate (P/B). Alternately, rates of production to consumption (P/Q), or growth efficiency, of predators can be adjusted. Such adjustment options pre-suppose uncertainty in the parameters. Thus, the best way to 'balance' an Ecopath model is to develop a systematic approach to prioritizing estimates based on data quality. Such an approach is best implemented by a collaboration of experts who 'negotiate' with each other (with a mediator/coordinator) to determine which parameters to adjust first or most (Okey and Pauly, 1999).

The designers of the Ecopath approach advise users to minimize cannibalism within functional groups to ensure useful estimations of system dynamics. The best approach to minimizing cannibalism is to ensure that groups are disaggregated in a functional sense, such that cannibalism is naturally minimized.

The second step in Ecopath model balancing is to examine the consumption rates upon each unbalanced group, beginning with the most unbalanced group. In cases where the higher rates of consumption were not supported by robust diet composition information, the diets of predators are appropriately adjusted to decrease

these consumption values. However, in the case of the Middle Atlantic Bight model, the diet compositions were considered to be somewhat of a cornerstone of the model. Thus, the second step for balancing the MAB model was to carefully re-examine the assumptions behind the biomass estimates, which were considered less reliable than the diet compositions. Adjustment of biomass estimates was used liberally during this initial balancing procedure because many of the initial biomass estimates were considered to be placeholders.

Sixteen of the groups were out of thermodynamic balance the first time the 'basic parameters' were estimated, as in the model of the South Atlantic States continental shelf (SAS). The MAB model, however, currently has 55 functional groups, whereas the SAS model has only 42 groups. Thus, the present model had 29% of the groups initially unbalanced, compared with 38% of the groups in the SAS model. The ecotrophic efficiency of the unbalanced groups in the MAB model ranged from 1.06 to 215, and the mean of the EE values for these unbalanced groups was  $22.9 \pm 13.7$  (standard error). This indicates more of an overall imbalance than in the SAS model (range: 1.09 to 27.07; mean:  $5.89 \pm 1.54$  SE). Crabs (EE = 215) and Shrimps (EE = 65.25) (followed by benthic invertebrate eating fishes; EE = 47.42) were the main reason the imbalance in the initial MAB model exceeded that of the initial SAS model, and these three components (and predation on them) were modified considerably during model balancing.

## RESULTS AND DISCUSSION

An initial attempt was made to construct a well-articulated model of the Middle Atlantic Bight food web, and the current model contains 55 functional groups. Table 2 shows the basic parameters of the Middle Atlantic Bight continental shelf model. Summary statistics for the system are presented in Table 3, and the sources of the basic parameters are shown in Table 1. The diet composition matrix is presented in Table 4.

This preliminary model of the Middle Atlantic Bight continental shelf was constructed to provide a new quantitative framework for the refinement of the model's input parameters so that an up-to-date, cohesive view of both the structure and the dynamics of the whole marine ecosystem can emerge. Notwithstanding the natural limitations of broad-system modeling approaches, this 'straw-man' model has the potential to enable a

better understanding of this important ecosystem for students, scientists, and other stakeholders. This approach is intended to complement, rather than replace, other assessment and management tools currently in use. It is a tool that can help operationalize the new era of ecosystem-based management.

The model is presented as a focal point for scrutiny and criticism of input parameters so that an improved understanding of the system can emerge. Experts in the various biotic components of the system can be identified and assembled into a coordinated and collaborative refinement strategy. Refinement of the 'straw-man' MAB model by a working group of experts ought to be coordinated such that a central copy of the model is maintained. This process should include several iterations of review and refinement, but a practical sunset for the process should be identified so that the model can be applied to questions of interest using the dynamic simulation routines of Ecopath with Ecosim (Walters *et al.*, 1997; Walters *et al.*, 1999; Pauly *et al.*, 2000).

Improvements to the model should begin with the broadest issues, such as the overarching issues of system definition and aggregation of functional groupings (the overall model structure). Species should be aggregated based on functional rather than taxonomic similarity, but the structure of the model can be adjusted according to the interest of the investigators. Thus, a particular sub-system of the model can be 'broken out' if the questions of interest relate to the articulation of that sub-system. For example, the current model contains a variety of aggregated groups for which an adept researcher might suggest disaggregating. These groups include skates and rays, cods and hakes, flounder, drum and croaker, snapper and grouper, forage fishes, benthic invertebrate eaters (e.g., sculpins and sea robins), dogfishes, squid, jellies, shrimps, crabs, sessile epibenthos, benthic infauna, bivalves, gastropods.

Functional groupings need not be taxonomically consistent; biomass and taxonomic lumping vs. splitting can vary widely among functional groups. The only strong recommendation for aggregation is that the species (or life stages) in a given functional group be reasonably similar in functional terms. System definition and functional group aggregation issues are centrally important for model construction and behavior. Given the complexity of real world ecosystems, considerable effort should be invested in these two important issues.

**Table 2.** Basic parameters of the ‘straw-man’ Ecopath model of the Middle Atlantic Bight continental shelf. Values in bold have been calculated with the Ecopath software; other values are empirically based inputs, or values that were adjusted from empirically based values during balancing. The omnivory index, OI, represents the uncertainty in the trophic level estimate.

Group name	Trophic level	OI	Biomass (t·km <sup>-2</sup> )	P/B (year <sup>-1</sup> )	Q/B (year <sup>-1</sup> )	EE
Billfishes	<b>4.5</b>	<b>0.248</b>	<b>0.014</b>	0.44	5.29	0.900
Bluefish	<b>4.5</b>	<b>0.104</b>	0.083	0.61	4.60	<b>0.996</b>
Tunas	<b>4.5</b>	<b>0.229</b>	0.060	0.40	4.60	<b>0.996</b>
Dolphins & porpoise	<b>4.4</b>	<b>0.061</b>	0.079	0.10	27.00	<b>0.000</b>
Seals	<b>4.4</b>	<b>0.194</b>	0.002	0.25	3.10	<b>0.000</b>
Goosefish	<b>4.4</b>	<b>0.141</b>	<b>0.504</b>	0.35	3.10	0.850
Coastal sharks	<b>4.3</b>	<b>0.351</b>	0.104	0.43	4.18	<b>0.878</b>
Marine birds	<b>4.3</b>	<b>0.173</b>	0.028	0.10	76.18	<b>0.000</b>
Striped bass	<b>4.3</b>	<b>0.235</b>	0.222	0.13	1.40	<b>0.964</b>
Weakfish	<b>4.3</b>	<b>0.143</b>	<b>0.044</b>	0.98	3.50	0.950
Snapper / grouper	<b>4.2</b>	<b>0.198</b>	0.339	0.70	6.76	<b>0.921</b>
Baleen whales	<b>4.2</b>	<b>0.130</b>	0.195	0.05	10.90	<b>0.000</b>
Jacks	<b>4.2</b>	<b>0.108</b>	<b>0.051</b>	0.56	9.20	0.950
Spiny dogfish	<b>4.2</b>	<b>0.262</b>	<b>0.586</b>	0.18	4.77	0.950
Benthic piscivores	<b>4.2</b>	<b>0.741</b>	0.073	0.40	9.85	<b>0.972</b>
Black seabass	<b>4.0</b>	<b>0.367</b>	<b>0.055</b>	0.74	3.60	0.850
Demersal piscivores	<b>4.0</b>	<b>0.321</b>	<b>1.479</b>	0.55	4.00	0.990
Octopods	<b>3.9</b>	<b>0.222</b>	<b>0.084</b>	3.10	7.30	0.950
Cods and hakes	<b>3.9</b>	<b>0.351</b>	0.550	0.65	2.58	<b>0.987</b>
Redfish	<b>3.8</b>	<b>0.269</b>	0.235	0.26	3.00	<b>0.989</b>
Lg. pel. planktivores	<b>3.7</b>	<b>0.060</b>	0.591	0.88	11.52	<b>0.700</b>
Mackerel	<b>3.7</b>	<b>0.247</b>	6.000	0.43	4.30	<b>0.749</b>
Drum / croaker	<b>3.6</b>	<b>0.343</b>	0.361	0.47	7.34	<b>0.906</b>
Benth. invert. eaters	<b>3.5</b>	<b>0.292</b>	<b>0.784</b>	1.73	13.57	0.980
Butterfishes	<b>3.5</b>	<b>0.190</b>	0.080	2.20	5.50	<b>0.608</b>
Squid	<b>3.5</b>	<b>0.208</b>	<b>2.533</b>	1.70	7.00	0.990
Atlantic salmon	<b>3.4</b>	<b>0.166</b>	<b>0.004</b>	0.74	7.14	0.900
Atlantic menhaden	<b>3.4</b>	<b>0.130</b>	<b>2.871</b>	1.55	31.40	0.990
Forage fish	<b>3.4</b>	<b>0.507</b>	8.000	1.50	5.00	<b>0.966</b>
Dem. planktivores	<b>3.3</b>	<b>0.111</b>	<b>0.068</b>	2.60	10.00	0.990
Tilefish	<b>3.3</b>	<b>0.151</b>	0.035	0.42	4.10	<b>0.923</b>
Flounders	<b>3.3</b>	<b>0.308</b>	1.000	0.60	4.10	<b>0.861</b>
Euphausiids	<b>3.3</b>	<b>0.295</b>	<b>0.807</b>	17.00	<b>134.92</b>	0.950
Scup	<b>3.3</b>	<b>0.162</b>	<b>0.013</b>	1.32	5.50	0.950
Lobsters	<b>3.2</b>	<b>0.359</b>	<b>1.257</b>	1.20	8.20	0.950
Ocean pout	<b>3.2</b>	<b>0.173</b>	<b>4.176</b>	0.50	1.80	0.950
Stomatopods	<b>3.1</b>	<b>0.811</b>	<b>0.151</b>	1.34	7.43	0.950
Dem. invert. eaters	<b>3.1</b>	<b>0.530</b>	<b>6.515</b>	0.76	5.02	0.990
Rays and skates	<b>3.1</b>	<b>0.749</b>	<b>1.182</b>	0.47	3.17	0.900
Jellies	<b>3.1</b>	<b>0.215</b>	<b>0.068</b>	18.25	80.00	0.900
Mysids	<b>2.8</b>	<b>0.336</b>	<b>5.429</b>	2.57	<b>17.13</b>	0.950
Macrozooplankton	<b>2.7</b>	<b>0.202</b>	51.690	7.00	<b>21.87</b>	<b>0.452</b>
Crabs	<b>2.6</b>	<b>0.402</b>	<b>3.125</b>	1.38	8.50	0.950
Spot	<b>2.5</b>	<b>0.388</b>	<b>0.043</b>	1.82	19.30	0.950
Shrimp	<b>2.4</b>	<b>0.399</b>	<b>0.912</b>	4.00	15.00	0.990
Echonoderms	<b>2.3</b>	<b>0.234</b>	8.400	1.20	3.70	<b>0.657</b>
Sessile epibenthos	<b>2.2</b>	<b>0.192</b>	<b>9.728</b>	0.80	9.00	0.950
Polychaetes	<b>2.1</b>	<b>0.126</b>	<b>9.354</b>	4.08	<b>27.20</b>	0.950
Small crustaceans	<b>2.1</b>	<b>0.109</b>	14.100	5.08	21.52	<b>0.744</b>
Bivalves	<b>2.0</b>	<b>0.012</b>	19.664	1.22	23.00	<b>0.814</b>
Microzooplankton	<b>2.0</b>	<b>0.000</b>	25.000	40.00	<b>125.00</b>	<b>0.985</b>
Phytoplankton	<b>1.0</b>	<b>0.000</b>	107.311	88.00	-	<b>0.387</b>
Macrophytes	<b>1.0</b>	<b>0.000</b>	<b>7.389</b>	5.00	-	0.700
Microphytobenthos	<b>1.0</b>	<b>0.000</b>	68.000	55.57	-	<b>0.078</b>
Detritus	<b>1.0</b>	<b>0.000</b>	155.700	-	-	<b>0.053</b>

**Table 3.** Basic summary statistics for the 'straw-man' Ecopath model of the Middle Atlantic Bight continental shelf. Values are expressed in wet weight.

Parameter	Value	Units
Sum of all consumption	5,912	t·km <sup>-2</sup> ·year <sup>-1</sup>
Sum of all respiratory flows	2,555	t·km <sup>-2</sup> ·year <sup>-1</sup>
Sum of all flows into detritus	11,353	t·km <sup>-2</sup> ·year <sup>-1</sup>
Total system throughput	30,581	t·km <sup>-2</sup> ·year <sup>-1</sup>
Sum of all production	14,847	t·km <sup>-2</sup> ·year <sup>-1</sup>
Calculated total net primary production	13,259	t·km <sup>-2</sup> ·year <sup>-1</sup>
Net system production	10,703	t·km <sup>-2</sup> ·year <sup>-1</sup>
Total biomass (excluding detritus)	371	t·km <sup>-2</sup>
Total catches	4.2	t·km <sup>-2</sup> ·year <sup>-1</sup>
Mean trophic level of the catch	3.3	--
Gross fishery efficiency (catch/net p.p.)	0.00032	--
System omnivory index	0.254	TL units
Total primary production/total respiration	5.2	--
Total primary production/total biomass	35.7	year <sup>-1</sup>
Total biomass/total throughput	0.012	year <sup>-1</sup>
Connectance index	0.205	--

A powerful aspect of the current approach, is that the 'straw-man' Ecopath model of the Middle Atlantic Bight can be modified easily according to suggested changes of basic input parameters. Re-aggregation of an existing model can be more challenging because the entire diet matrix must be re-visited and adjusted accordingly. Nevertheless, functional group disaggregation can be straightforward. Disaggregation of subwebs of interest should coincide with aggregation of other subwebs in the system if it is desired to limit the number of groups to a reasonable number (e.g., <50). A collaborative group of experts could thus aggregate groups of 'low interest' while disaggregating groups of 'high interest' in order to address a particular set of questions. Nevertheless, Ecopath with Ecosim can now be used to construct highly articulated models. For example, a food web with 81 groups (e.g., Link 2002) or more can be characterized using this approach.

Real world food webs are profoundly complex (Polis, 1991). Attempting to construct models of food webs for which considerable information exists is thus a deeply challenging task if the goal is to produce a useful representation of that system. Several researchers have argued or implied that the extent to which a food web is articulated in a model appears to strongly influence the types of behavior that a dynamic

model exhibits (Polis, 1994; also see Paine, 1988 and Cohen *et al.*, 1993). The challenge of constructing well-articulated models of relatively well-known systems underscores the potential of simpler models to mislead (i.e., simpler models or less well-known systems). This issue can be mitigated, however, by framing the subsystems, or the aggregation regime, with particular and explicit hypotheses.

Once aggregation issues are resolved, suggested improvements should then proceed to the scrutiny, refinement, and tuning of specific parameter estimates by assigning specialists to focus on particular groups with which they have expertise. Issues of these types underscore the need for the development of a coordinated and collaborative refinement strategy that would account for suggestions and 'refinement negotiations' in a transparent and efficient manner. Biomass estimations are the particular weak point of the present straw-man model. Fully 29 out of 55 biomass estimates in this model were estimated using the Ecopath software. These output values represent the 'system need' for minimal biomasses estimates for those particular groups, based on consumption demand on those groups relative to biomass and production rates. This calculation by the Ecopath software can be reasonably accurate when the biomasses of only a few groups are left blank, but useful 'realism' can









disappear when biomass parameters for whole blocks of interacting species are unknown. Nevertheless, the uncertainties highlighted by the present model belie the ultimate strength of this exercise. Reconciled trophic models (e.g., balanced Ecopath models) are road maps of what is *not* known about an ecosystem.

In addition to this surprising paucity of biomass estimates in general, two specific examples of highlighted uncertainty are crabs and shrimps. These groups stood out as considerably unbalanced in the initial run of three recently constructed models of east coast U.S. ecosystems: the West Florida Shelf model (Mackinson *et al.*, 2000), the South Atlantic States shelf model (Okey and Pugliese, this volume), and the Middle Atlantic Bight shelf model (the present straw-man model). This indicates that the biomass of shrimps, and particularly crabs might be underestimated by group-specific assessments in these regions, or that these groups are overestimated in the specified diet compositions of fishes and other predators. Both of these alternatives are equally reasonable because only adult (and 'fishery sized') forms are normally assessed, whereas most of the biomass of crabs and shrimps might occur in juvenile or smaller forms, and because crustaceans are expected to linger in stomach contents of fishes and other predators while soft-bodied organisms are digested (and disappear) more quickly.

An alternative explanation is that the estimates of biomass or consumption rates of the predators of these crustaceans are overestimated. This shrimp and crab dilemma is discussed further in Okey and Nance (in Mackinson *et al.* 2000) and Mackinson and Okey (in Mackinson *et al.* 2000). Whatever the reasons for these discontinuities, the exercise of constructing Ecopath models can serve as an impetus for focusing detective work on weak (poorly known) junctures in a system.

The purpose of this 'straw-man' model of the Middle Atlantic Bight continental shelf was to provide a quantitative framework and a vehicle for the refinement of the model's input parameters so that a cohesive and useful view of the whole ecosystem can emerge. It would be prudent at this stage to focus on refinement and tuning rather than on shortcomings of the model's structure, especially since particular characteristics are taken from previous assessments and syntheses (Table 1). In its present form, and prior to simulation exercises, this model tells us little about the system that was not already known by experts. However, it provides an accessible view of the system and

enables new explorations of system mechanisms and dynamics. It also allows development of sustainable strategies human interactions with this ecosystem.

The purpose of this iteration is for criticism that will lead to improvement. I recommend that experts in the various biotic components of the system be identified and assembled. Each of these experts could then scrutinize the component for which they have expertise (paying particular attention to biomass estimates) and they could develop new estimates based on updated information.

#### ACKNOWLEDGEMENTS

Numerous individuals at the National Marine Fisheries Service, particularly at the Northeast Fisheries Science Centre, shared many years of information about the Middle Atlantic Bight system, especially some of the existing unpublished diet composition data. These data were provided in the spirit of sharing, and because they represent public information, but they were provided without official endorsement of my uses for them, or my interpretations. I am particularly thankful for the help of Jason Link, who provided excellent comments and advice, and carefully scrutinized an early draft. I am disappointed that the time constraints placed upon the delivery of this preliminary work prevented all of his concerns from being addressed. Thanks also go to Johanna Heymans, whose sharing of information enabled this 'straw-man' model to be constructed within the allotted time frame. Also, Sylvie Gu nette should be congratulated for tolerating delays. The Pew Charitable Trusts of Philadelphia, USA initiated and supported the *Sea Around Us* project at the UBC Fisheries Centre, which funded the present work.

## REFERENCES

- Acosta, A., Dunmire, T., and Venier, J. 1998. A preliminary trophic model of the fish communities of Florida Bay. Proceedings of 1998 Florida Bay Science Conference. University of Miami, Miami, FL USA.
- Adams, S. M. 1976. Feeding ecology of eelgrass fish communities. Transactions of the American Fisheries Society, 4: 514-519.
- Allen, R. R. 1971. Relation between production and biomass. Journal of the Fisheries Research Board of Canada, 28: 1573-1581.
- Arnold, W. S., Marelli, D., and Okey, T. A. 2000. Bivalves. In An Ecosystem Model of the West Florida Shelf for use in Fisheries Management and Ecological Research. Ed. By S. Mackinson, T.A. Okey, M. Vasconcellos, L. Vidal-Hernandez, B. Mahmoudi, Submitted to the Florida Fish and Wildlife Conservation Commission, Florida Marine Research Institute, St. Petersburg [to be published as a technical report].
- Arreguín-Sánchez, F., Seijo, J. C., and Valero-Pacheco, E. 1993. An application of ECOPATH II to the north continental shelf ecosystem of Yucatan, Mexico. In Trophic Models of Aquatic Ecosystems, pp. 269-278. Ed. by V. Christensen and D. Pauly. ICLARM Conference Proceedings, 26.
- Azeiteiro, U. M., Jesus, L. and Marques, J. C. 1999. Distribution, population dynamics, and production of the suprabenthic mysid *Mesopodopsis slabberi* Van Beneden in the Mondego estuary (Western Coast of Portugal). Journal of Crustacean Biology, 19: 498-509.
- Banse, K. and Mosher, S. 1980. Adult body mass and annual production/biomass relationships of field populations. Ecological Monographs, 50: 355-379.
- Brodziak, J. 2001a. Silver hake. In Status of Fishery Resources off the Northeastern United States. NOAA; [www.nefsc.nmfs.gov/sos/](http://www.nefsc.nmfs.gov/sos/)
- Brodziak, J. 2001b. Red hake. In Status of Fishery Resources off the Northeastern United States. NOAA; [www.nefsc.nmfs.gov/sos/](http://www.nefsc.nmfs.gov/sos/)
- Brown, B. E., Brennan, J. A., Heyerdahl, E. G., Grosslein, M. D., and Hennemouh, R. C. 1976. The effect of fishing on the marine finfish biomass of the Northwest Atlantic from the Gulf of Maine to Cape Hatteras. International Commission for Northwest Atlantic Fisheries Research Bulletin, 12: 49-68.
- Brown, R. 2000. Haddock. In Status of Fishery Resources off the Northeastern United States. NOAA; [www.nefsc.nmfs.gov/sos/](http://www.nefsc.nmfs.gov/sos/)
- Buchan, P. R., and Smale, M. J. 1981. Estimates of Biomass, Consumption and Production of *Octopus vulgaris* Cuvier off the East Coast of South Africa. Oceanographic Research Institute, Investigational Report, 50. 9 pp.
- Cadrin, S. 2000. Yellowtail flounder. In Status of Fishery Resources off the Northeastern United States. NOAA; [www.nefsc.nmfs.gov/sos/](http://www.nefsc.nmfs.gov/sos/)
- Cahoon, L. B. and Cooke, J. E. 1992. Benthic microalgal production in Onslow Bay, North Carolina, USA. Marine Ecology Progress Series, 84: 185-196.
- Christensen, V. and Pauly, D. 1992. ECOPATH II - A system for balancing steady-state ecosystem models and calculating network characteristics. Ecological Modeling, 61: 169-185.
- Christensen, V., Walters, C. J., and Pauly, D. 2000. Ecopath with Ecosim - A User's Guide. University of British Columbia, Fisheries Centre, Vancouver, Canada and ICLARM, Penang, Malaysia. 131 pp.
- Cohen, E. B., Grosslein, M. D., Sissenwine, M. P., Steimle, F., and Wright, W. R. 1982. Energy budget of Georges Bank. In Multispecies Approaches to Fisheries Management Advice, pp. 95-107. Ed. by M. C. Mercer. Canadian Special Publication of Fisheries and Aquatic Sciences, 59: 169 pp.
- Cohen, J.E. Beaver R.A., Cousins S.H., de Angelis D.L., Goldwasser L., Heong K.L., Holt R.D., Kohn A.J., Lawton J.H., Martinez N., O'Malley R., Page L.M., Patten B.C., Pimm S.L., Polis G.A., Rejmanek M., Schoener T.W., Schoenly K., Sprules W.G., Teal J.M., Ulanowicz R.E., Warren P.H., Wilbur H.M., and Yodzis P. 1993. Improving food webs. Ecology, 74: 252-258.
- Cura, J. J. 1987. Phytoplankton. In Georges Bank, pp. 213-218. Ed. by R. H. Backus and D. W. Bourne. MIT Press, Cambridge Mass.
- Dolphin, W. F. 1987. Prey densities and foraging of humpback whales, *Megaptera novaeangliae*. Experientia, 43: 468-471.
- Durbin, E. G., Durbin, A. C., Langton, R. W., and Bowman, R. E. 1983. Stomach contents of silver hake, *Merluccius bilinearis*, and Atlantic cod, *Gadus morhua*, and estimation of their daily rations. Fishery Bulletin, 81: 437-450.
- Ehrhardt, N. M., and Restrepo, V. R. 1989. The Florida stone crab fishery: a reusable resource? In Marine Invertebrate Fisheries: Their Assessment and Management, pp. 225-240. Ed. by J. F. Caddy. John Wiley and Sons, New York. 752 pp.
- Fogarty, M. J., Cohen, E. B., Michaels, W. L., and Morse, W. W. 1991. Predation and the regulation of sand lance populations: an exploratory analysis. ICES Symposium of Marine Science, 193: 120-124.
- Fogarty, M. J. and Murawski, S. A. 1998. Large-scale disturbance and the structure of marine systems: fishery impacts in Georges Bank. Ecological Applications, 8: S6-S22.
- Froese, R. and Binohlan, C. B. 2000. Empirical relationships to estimate asymptotic length, length at first maturity, and length at maximum yield in fishes. Journal of Fish Biology, 56: 758-773.
- Froese, R. and Pauly, D. Editors. 2001. FishBase. World Wide Web Electronic publication. [www.fishbase.org](http://www.fishbase.org), 01 April 2001.
- Graham, W. 2000. Carnivorous jellyfish. In An Ecosystem Model of the West Florida Shelf for use in Fisheries Management and Ecological Research. Ed. By S. Mackinson, T.A. Okey, M. Vasconcellos, L. Vidal-Hernandez, B. Mahmoudi, Submitted to the Florida Fish and Wildlife Conservation Commission, Florida Marine Research Institute, St. Petersburg [to be published as a technical report].
- Guénette, S. 1996. Macrobenthos. pp. 65-67. In: Mass-Balance Models of North-Eastern Pacific Ecosystems. Ed. by D. Pauly and V. Christensen. Fisheries Centre Research Report 4(1).
- Hamill, M. O. and Stenson, G. B. 2000. Estimated prey consumption by harp seals (*Phoca groenlandica*), hooded seals (*Cystophora cristata*), grey seals (*Halichoerus grypus*) and harbour seals (*Phoca vitulina*) in Atlantic Canada. Journal of Northwest Atlantic Fisheries Science, 26: 1-23.
- Hendrickson, L. 2000. Windowpane flounder. In Status of Fishery Resources off the Northeastern United States. NOAA; [www.nefsc.nmfs.gov/sos/](http://www.nefsc.nmfs.gov/sos/)
- Huebner, J. D., and Langton, R. W. 1982. Rate of gastric evacuation for winter flounder, *Pseudopleuronectes americanus*. Canadian Journal of Fisheries and Aquatic Sciences, 39: 356-360.
- Kastelein, R. A., Hardeman, J., and Boer, H. 1997. Food consumption and body weight of harbor porpoises (*Phocoena phocoena*). In The Biology of the Harbor Porpoise, pp. 217-233. Ed. by A. J. Read, P. R. Weipkema and P. E. Nachtigall. De Spil Publishers, The Netherlands.
- Keeley, E. R. and Grant, J. W. A. 1997. Allometry of diet selectivity in juvenile Atlantic salmon (*Salmo salar*). Canadian Journal of Fisheries and Aquatic Sciences, 54: 1894-1902.

- Konchina, V. Y., 1986. Fundamental trophic relationships of the rockfishes *Sebastes mentella* and *Sebastes fasciatus* (Scorpaenidae) of the northwestern Atlantic. *Journal of Ichthyology*, 26: 53-65.
- Lai, H., and Rago, P. J. 2000. Sea scallops. In Status of Fishery Resources off the Northeastern United States. NOAA; [www.nefsc.nmfs.gov/sos/](http://www.nefsc.nmfs.gov/sos/)
- Last, J. M., 1987. The food of immature sprat [*Sprattus sprattus* (L.)] and herring (*Clupea harengus*) in coastal waters of the North Sea. *Journal du Conseil International pour l'Exploration de la Mer*, 44: 73-79.
- Link, J. S. 1999. (Re)constructing food webs and managing fisheries. In *Ecosystem Approaches for Fisheries Management*, pp. 571-588. University of Alaska Sea Grant, AK-SG-99-01, Fairbanks. 738 pp.
- Link, J. S. 2002. Does food web theory work for marine ecosystems? *Marine Ecology Progress Series* 230: 1-9.
- Link, J. S. and Almeida, F. P. 2000. An Overview and History of the Food Web Dynamics Program of the Northeast Fisheries Science Center, Woods Hole, Massachusetts. NOAA Technical Memorandum NMFS-NE-159. 60 pp.
- Luning, K. 1990. *Seaweeds: Their Environment, Biogeography, and Ecophysiology*. John Wiley and Sons, Inc., New York. 527 pp.
- Mackinson, S. 2000. Fishes. In *An Ecosystem Model of the West Florida Shelf for use in Fisheries Management and Ecological Research*. Ed. By S. Mackinson, T.A. Okey, M. Vasconcellos, L. Vidal-Hernandez, B. Mahmoudi, Submitted to the Florida Fish and Wildlife Conservation Commission, Florida Marine Research Institute, St. Petersburg [to be published as a technical report].
- Mackinson, S., Okey, T.A., Vasconcellos, M., Vidal-Hernandez, L., and Mahmoudi, B. (Eds.), 2000. *An Ecosystem Model of the West Florida Shelf for use in Fisheries Management and Ecological Research*, Submitted to the Florida Fish and Wildlife Conservation Commission, Florida Marine Research Institute, St. Petersburg [to be published as a technical report].
- Martínez, C. E. 2000. Trophic ecology of *Panulirus gracilis*, *P. penicillatus* and *Scyllarides astori* in the lobster fisheries of the Galapagos. Master's Thesis. University of Azuay, Ecuador. 102 pp.
- Matkin, C. and Hobbs, R. 1999a. Baleen whales. p. 56. In: *A Trophic Mass-Balance Model of Alaska's Prince William Sound Ecosystem, for the Post-Spill Period 1994-1996*, 2<sup>nd</sup> ed. Ed. by T. A. Okey and D. Pauly. Fisheries Centre Research Report 7(4).
- Matkin, C. and Hobbs, R. 1999b. Small cetaceans. pp. 61-62. In: *A Trophic Mass-Balance Model of Alaska's Prince William Sound Ecosystem, for the Post-Spill Period 1994-1996*, 2<sup>nd</sup> ed. Ed. by T. A. Okey and D. Pauly. Fisheries Centre Research Report 7(4).
- Mayo, R. K., and O'Brien, L. 2000. Atlantic cod. In Status of Fishery Resources off the Northeastern United States. NOAA; [www.nefsc.nmfs.gov/sos/](http://www.nefsc.nmfs.gov/sos/)
- Meyer, C. A. and Caldwell, R. L. 2000. Stomatopods. In *An Ecosystem Model of the West Florida Shelf for use in Fisheries Management and Ecological Research*. Ed. By S. Mackinson, T.A. Okey, M. Vasconcellos, L. Vidal-Hernandez, B. Mahmoudi, Submitted to the Florida Fish and Wildlife Conservation Commission, Florida Marine Research Institute, St. Petersburg [to be published as a technical report].
- Murawski, S. A. 1984. Mixed species yield per recruitment analyses accounting for technological interactions. *Canadian Journal of Fisheries and Aquatic Sciences*, 41: 897-916.
- Nitschke, P. 2000. Tilefish. In: Status of Fishery Resources off the Northeastern United States. NOAA; [www.nefsc.nmfs.gov/sos/](http://www.nefsc.nmfs.gov/sos/)
- Nitschke, P., Brown, R., and Hendrickson, L. 2000. Winter flounder. In Status of Fishery Resources off the Northeastern United States. NOAA; [www.nefsc.nmfs.gov/sos/](http://www.nefsc.nmfs.gov/sos/)
- NMFS. 2000. U.S. Atlantic and Gulf of Mexico Marine Mammal Stock Assessments - 2000. NOAA Technical Memorandum NMFS-NE-162. National Marine Fisheries Service, Northeast Fisheries Science Center, Woods Hole, Massachusetts. 300 pp.
- Odum, H. T., and Odum, E. P. 1955. Trophic structure and productivity of a windward coral reef community on Eniwetok Atoll. *Ecological Monographs*, 25: 291-320.
- Okey, T. A. 2000 a. Echinoderms and gastropods. In *An Ecosystem Model of the West Florida Shelf for use in Fisheries Management and Ecological Research*. Ed. By S. Mackinson, T.A. Okey, M. Vasconcellos, L. Vidal-Hernandez, B. Mahmoudi, Submitted to the Florida Fish and Wildlife Conservation Commission, Florida Marine Research Institute, St. Petersburg [to be published as a technical report].
- Okey, T. A. 2000 b. Sessile epibenthos. In *An Ecosystem Model of the West Florida Shelf for use in Fisheries Management and Ecological Research*. Ed. By S. Mackinson, T.A. Okey, M. Vasconcellos, L. Vidal-Hernandez, B. Mahmoudi, Submitted to the Florida Fish and Wildlife Conservation Commission, Florida Marine Research Institute, St. Petersburg [to be published as a technical report].
- Okey, T. A., Foy, R. J., and Purcell, J. 1999. Carnivorous Jellies. p. 19. In: *A Trophic Mass-Balance Model of Alaska's Prince William Sound Ecosystem, for the Post-Spill Period 1994-1996*, 2<sup>nd</sup> ed. Ed. by T. A. Okey and D. Pauly. Fisheries Centre Research Report 7(4).
- Okey, T. A. and Nance, J. 2000. Adult Shrimp. In *An Ecosystem Model of the West Florida Shelf for use in Fisheries Management and Ecological Research*. Ed. By S. Mackinson, T.A. Okey, M. Vasconcellos, L. Vidal-Hernandez, B. Mahmoudi, Submitted to the Florida Fish and Wildlife Conservation Commission, Florida Marine Research Institute, St. Petersburg [to be published as a technical report].
- Okey, T. A. and Pauly, D. 1999. A mass-balanced model of trophic flows in Prince William Sound: de-compartmentalizing ecosystem knowledge. In *Ecosystem Approaches for Fisheries Management*. pp. 621-635. University of Alaska Sea Grant, AK-SG-99-01, Fairbanks, 756 pp.
- Opitz, S. 1993. A quantitative model of the trophic interactions in a Caribbean coral reef ecosystem. In *Trophic Models of Aquatic Ecosystems*, pp. 259-267. Ed. by V. Christensen and D. Pauly. ICLARM Conference Proceedings, 26. 390 pp.
- O'Reilly, J. E., Evans-Zetlin, C., and Busch, D. A. 1987. Primary Production. In *Georges Bank*, pp 220-233. Ed. by R. H. Backus and D. W. Bourne. MIT Press, Cambridge, Mass. 592 pp.
- Overholtz, W. J. 2000a. Atlantic mackerel. In Status of Fishery Resources off the Northeastern United States. NOAA; [www.nefsc.nmfs.gov/sos/](http://www.nefsc.nmfs.gov/sos/)
- Overholtz, W. J. 2000b. Atlantic herring. In Status of Fishery Resources off the Northeastern United States. NOAA; [www.nefsc.nmfs.gov/sos/](http://www.nefsc.nmfs.gov/sos/)
- Overholtz, W. J., Link, J. S., and Suslowicz, L. E. 1999. Consumption and harvest of pelagic fishes and squids in the Gulf of Maine—Georges Bank ecosystem. In *Ecosystem Approaches for Fisheries Management*, pp. 163-186. University of Alaska Sea Grant, AK-SG-99-01, Fairbanks. 738 pp.
- Overholtz, W. J., Link, J. S., and Suslowicz, L. E. 2000. Consumption of important pelagic fish and squid by predatory fish in northeastern USA shelf ecosystem with some fishery comparisons. *ICES Journal of Marine Science*, 57: 1147-1159.
- Overholtz, W. J., Murawski, S. A., and Michaels, W. L. 1991. Impact of predatory fish, marine mammals, and seabirds on the pelagic fish ecosystem of the

- northeastern USA. ICES Marine Science Symposium, 193: 198-208.
- Overholtz, W. J. and Tyler, A. V. 1986. An exploratory simulation model of competition and predation in a demersal fish assemblage on Georges Bank. Transactions of the American Fisheries Society, 115: 805-817.
- Pagliosa Alves, P. R. and Lana, P. C. 1998. Population dynamics and secondary production of *Nereis oligohalina* (Nereididae; Polychaeta) from a subtropical marsh in SE Brazil. 6th International Polychaete Conference, Brazil. August 1998.
- Paine, R. T. 1988. Food webs: road maps of interactions or grist for theoretical development? Ecology, 69: 1648-1654.
- Palomares, M. L. and Pauly, D. 1989. A multiple regression model for predicting the food consumption of marine fish populations. Australian Journal of Marine and Freshwater Research, 40: 259-273.
- Palomares, M. L. D. and Pauly, D. 1999. Predicting the food consumption of fish populations as functions of mortality, food type, morphometrics, temperature and salinity. Marine and Freshwater Research, 49: 447-453.
- Parrack, M. L. 1981. Some aspects of brown shrimp exploitation in the northern Gulf of Mexico. Workshop on the Scientific Basis for the Management of Penaeid Shrimp. Key West, Florida.
- Pauly, D., Christensen, V., and Walters, C. 2000. Ecopath, Ecosim, and Ecospace as tools for evaluating ecosystem impacts of fisheries. ICES Journal of Marine Science, 57: 697-706.
- Pauly, D., Sambily, V. Jr., and Opitz, S. 1993. Estimates of relative food consumption by fish and invertebrate populations, required for modeling the Bolinao Reef ecosystem, Philippines. In Trophic Models of Aquatic Ecosystems, pp. 236-251. Ed. by V. Christensen and D. Pauly. ICLARM Conference Proceedings, 26.
- Payne, P. M., and Selzer, L. A. 1989. The distribution, abundance and selected prey of the harbor seal, *Phoca vitulina concolor*, in Southern New England. Marine Mammal Science, 5: 173-192.
- Pearce, J. B. 2000. The New York bight. Marine Pollution Bulletin, 41: 44-55.
- Polis, G. A. 1991. Complex trophic interactions in deserts: An empirical critique of food web theory. American Naturalist, 138: 123-155.
- Polis, G. A. 1994. Food webs, trophic cascades, and community structure. Australian Journal of Ecology, 19: 121-136.
- Polovina, J. J. 1984. Model of a coral reef ecosystem I. The ECOPATH model and its applications to French Frigate Shoals. Coral Reefs, 3: 1-11.
- Reeves, R. R., Breiwick, J. M., and Mitchell, E. D. 1999. History of whaling and estimated kill of right whales, *Balaena glacialis*, in the northeastern United States, 1620-1924. Marine Fisheries Review, 61: 1-36.
- Sanders, H. 1956. The biology of marine bottom communities. Bulletin of the Bingham Oceanographic Collection (Yale University), 15: 344-414.
- SEAMAP-SA / SCMRD. 2000. SEAMAP-South Atlantic 10-year trawl report: Results of trawling efforts in the coastal habitat of the south Atlantic Bight, FY 1990-1999. Prepared for the Atlantic States Marine Fisheries Commission by the SEAMAP-SA / South Carolina Department of Natural Resources, Marine Resources Research Institute, Charleston, South Carolina. 143 pp.
- Shepherd, G. 2000a. Bluefish. In Status of Fishery Resources off the Northeastern United States. NOAA; [www.nefsc.nmfs.gov/sos/](http://www.nefsc.nmfs.gov/sos/)
- Shepherd, G. 2000b. Striped bass. In Status of Fishery Resources off the Northeastern United States. NOAA; [www.nefsc.nmfs.gov/sos/](http://www.nefsc.nmfs.gov/sos/)
- Sherman, K., Smith, W. G., Green, J. R., Cohen, E. B., Berman, M. S., Marti, K. A., and Goulet, J. R. 1987. Zooplankton production and the fisheries of the Northeastern Shelf. In Georges Bank, pp. 268-282. Ed. by R. H. Backus and D. W. Bourne. MIT Press, Cambridge Mass.
- Sierra, L. M., Claro, R., and Popova, O. A. 1994. Alimentacion y relaciones tróficas. In Ecología de los Peces Marinos de Cuba, pp. 263-284. Ed. by R. Claro. Instituto de Oceanología Academia de Ciencias de Cuba and Centro de Investigaciones de Quintana Roo, Mexico.
- Sissenwine, M. P. 1987. Fish and squid production. In Georges Bank, pp. 347-350. Ed. by R. H. Backus and D. W. Bourne. MIT Press, Cambridge Mass.
- Sissenwine, M. P., Cohen, E. B., and Grosslein, M. D. 1984. Structure of the Georges Bank ecosystem. Rapport et Procès-verbaux des Réunions du Conseil International pour l'Exploration de la Mer, 183: 243-254.
- Sosebee, K. A. 2000a. Spiny dogfish. In Status of Fishery Resources off the Northeastern United States. NOAA; [www.nefsc.nmfs.gov/sos/](http://www.nefsc.nmfs.gov/sos/)
- Sosebee, K. A. 2000b. White hake. In Status of Fishery Resources off the Northeastern United States. NOAA; [www.nefsc.nmfs.gov/sos/](http://www.nefsc.nmfs.gov/sos/)
- Sosebee, K. A. 2000c. Red hake. In Status of Fishery Resources off the Northeastern United States. NOAA; [www.nefsc.nmfs.gov/sos/](http://www.nefsc.nmfs.gov/sos/)
- Sosebee, K. A. 2000d. Skates. In Status of Fishery Resources off the Northeastern United States. NOAA; [www.nefsc.nmfs.gov/sos/](http://www.nefsc.nmfs.gov/sos/)
- Steimle, F.W. 1987. Production by the benthic fauna. In Georges Bank, pp. 310-314. Ed. by R. H. Backus and D. W. Bourne. MIT Press, Cambridge Mass. 592 pp.
- Stevens, D. E. 1966. Food habits of striped bass, *Roccus saxatilis* in the Sacramento-San Joaquin Delta. In Ecological Studies of the Sacramento-San Joaquin Delta. Part II Fishes of the Delta, pp. 68-96. Ed. by J. L. Turner and D. W. Kelly. Fishery Bulletin, 136.
- Stone, H. H. and Jessop, B. M. 1994. Feeding habits of anadromous alewives, *Alosa pseudoharengus*, off the Atlantic Coast of Nova Scotia. Fishery Bulletin, 92: 157-170.
- Tanasichuk, R. W. 1998. Interannual variations in the population biology and productivity of *Euphausia pacifica* in Barkley Sound, Canada, with special reference to the 1992 and 1993 warm ocean years. Marine Ecology Progress Series, 173: 163-180.
- Terceiro, M. 2001. Summer flounder. In Status of Fishery Resources off the Northeastern United States. NOAA; [www.nefsc.nmfs.gov/sos/](http://www.nefsc.nmfs.gov/sos/)
- Theroux, R. B., and Grosslein, M. D. 1987. Benthic fauna. In Georges Bank, pp. 283-295. Ed. by R. H. Backus and D. W. Bourne. MIT Press, Cambridge Mass.
- Trites, A. W. and Pauly, D. 1998. Estimating mean body masses of marine mammals from maximum body lengths. Canadian Journal of Zoology, 76: 886-896.
- Vinogradov, V. I. 1984. Food of silver hake, red hake and other fishes of Georges Bank and Adjacent Waters, 1968-74. NAFO Science Council Studies, 7: 87-94.
- Walters, C. J., Christensen, V., and Pauly, D. 1997. Structuring dynamic models of exploited ecosystems from trophic mass balance assessments. Reviews in Fish Biology and Fisheries, 7: 139-172.
- Walters, C. J., Pauly, D., and Christensen, V. 1999. Ecospace: prediction of mesoscale spatial patterns in trophic relationships of exploited ecosystems, with emphasis on the impacts of marine protected areas. Ecosystems, 2: 539-564.
- Wigley, S. E. 2000. Witch flounder. In Status of Fishery Resources off the Northeastern United States. NOAA; [www.nefsc.nmfs.gov/sos/](http://www.nefsc.nmfs.gov/sos/)
- Wilkinson, C. R. 1987. Interocean differences in size and nutrition of coral reef sponge populations. Science, 236: 1654-1657.

# A PRELIMINARY ECOPATH MODEL OF THE ATLANTIC CONTINENTAL SHELF ADJACENT TO THE SOUTHEASTERN UNITED STATES

Thomas A. Okey<sup>1</sup> and Roger Pugliese<sup>2</sup>

<sup>1</sup>Fisheries Centre, University of British Columbia, 2204 Main Mall, V6T 1Z4, Vancouver BC Canada  
email: t.okey@fisheries.ubc.ca

<sup>2</sup>South Atlantic Fishery Management Council, One Southpark Circle, Suite 306, Charleston SC 29407 USA

## ABSTRACT

The biological communities of the Atlantic continental shelf adjacent to the southeastern United States are well known, but this knowledge is not integrated into a cohesive description of that region. We constructed a preliminary food web model of this area using Ecopath with Ecosim, as a way to initiate a long-term process of integrating this knowledge, learning more about the structure and resiliency of the system, and helping to guide research priorities in the future. The current model is considered to be a first iteration that can be used as a vehicle to stimulate a more rigorous refinement effort in the near future. The ecologically defined area covered by this model extends from Cape Hatteras, North Carolina to the easternmost extent of the Florida Keys, and from the intertidal zone (or the entrance of estuarine systems) to the 500 m isobath. The time period characterized by this preliminary model is the four years from 1995 to 1998.

## INTRODUCTION

Extensive estuaries, salt marshes, and barrier islands that protect sounds and waterways characterize the Atlantic coastline of the Southeastern United States. The gently sloping topography of this coastline gives away the subtidal bathymetry, which continues sloping smoothly to the east. The continental shelf is mostly covered with calcareous sands, but large ancient coral reef structures are exposed to varying degrees. These form hard-bottom reef areas that are locally referred to as “live bottoms” because of the diverse communities of algae, invertebrates, and fishes they support. The Gulf Stream flows from south to north along the coast transporting animals and plants and defining ecological interfaces. Meanders and intrusions of

the Gulf Stream advect the underlying nutrient rich slope waters onto the shelf (Mallin *et al.* 2000). This region as a whole supports a diverse assemblage of marine organisms, as it is somewhat of an ecological interface, or gradient, between warm-water and cold-water species assemblages. We refer the reader to Mallin *et al.* (2000) for a general description of the ecological setting, processes, and related research. A brief overview of special habitats is presented below.

Human activities along the east coast of the southeastern United States have influenced the adjacent continental shelf ecosystem for thousands of years, as native Americans conducted some limited artisanal fisheries and modified fire regimes and the vegetation in upland watersheds (e.g., Cronon, 1983). Modifications to the ecology of the continental shelf ecosystem accelerated soon after the arrival of Europeans, who began fishing coastal waters (e.g., Mowat, 1984; Reeves *et al.*, 1999) in addition to introducing domesticated livestock, weed plants, disease, and new kinds of agriculture (e.g., Crosby, 1986).

Other profound anthropogenic modifications to this continental shelf occurred during the 20<sup>th</sup> century with the widespread use of powered fishing and whaling vessels, and coastal urbanization and industrialization. One particularly destructive type of fishing is bottom trawling, which destroys biogenic seafloor habitat in addition to simply removing fishes (Watling and Norse, 1998; Turner *et al.*, 1999).

Trawling activity is intense in this area, and little doubt remains that these activities have considerably modified the continental shelf. The continental shelves of the southeastern United States as a whole are also very important for recreational fishing. Fisheries landings peaked around 1980 in this region, and have declined substantially since that time. According to Mallin *et al.* (2000), “overfishing has led to serious declines in many wild fish stocks” in this area. The human population of this region is still growing rapidly, and pollution of various types (and associated algal blooms, etc.) also stands out as a serious and growing problem.

## ***The U.S. ‘South Atlantic Bight’ continental shelf***

The area of scrutiny for the preliminary Ecopath model we develop here extends from Cape Hatteras in North Carolina to the easternmost extent of the Florida Keys, and from the intertidal and the entrance of estuarine systems to the 500

m isobath. This coastal region and continental shelf constitutes a large bight, which is locally referred to as the “South Atlantic Bight,” though it defines a portion of the western limit of the North Atlantic Ocean. The time period characterized by this preliminary model is four years during in the late 1990s (1995-1998). The area covered was estimated to be 174,300 km<sup>2</sup>. The slope of the sea floor steepens seaward of the 200 m isobath (and sometimes shallower); for example, the area delineated by the 200 m isobath is estimated to be 133,300 km<sup>2</sup>, which is only 24% less than the area delineated by the 500 m isobath.

### ***‘Essential fish habitat’ in the South Atlantic Bight***

The following summaries represent a snapshot of the important habitat types in the region that serve as ‘Essential Fish Habitat’ for federally managed species. The description and distribution of essential fish habitat includes estuarine inshore habitats, mainly focusing on North Carolina, South Carolina, Georgia, and the Florida east coast as well as adjacent offshore marine habitats (e.g., coral, coral reefs, and live/hard bottom habitat, artificial reefs, *Sargassum* habitat and the water column). The vast array of species using these habitats at different times and in different locations implies that these habitats are essential for the functioning of a healthy ecosystem in this region.

This is a brief review of the descriptions in the South Atlantic Fishery Management Council Habitat Plan (SAFMC, 1998a) and the Comprehensive Habitat Amendment (SAFMC, 1998b) developed for the purpose of designation and regulatory protection of Essential Fish Habitat. The emphasis here is on interrelationships between habitat and managed species and their prey, as well as endangered and threatened species. Such habitat considerations will ultimately prove crucial for the construction of refined Ecopath model iterations and for spatially explicit simulations after refinement.

#### *Estuarine/Inshore Fish Habitat*

Estuarine inshore habitats include estuarine emergent vegetation (salt marsh and brackish marsh), estuarine shrub/scrub (mangroves), seagrass, oyster reefs and shell banks, intertidal flats, palustrine emergent and forested (freshwater wetlands), and the estuarine water column.

Estuarine marshes form a complex ecosystem that is vital to wildlife including endangered and

threatened species, furbearers and other mammals, waterfowl, wading birds, shore and other birds, reptiles and amphibians, shellfish, and invertebrates. In contrast to freshwater marshes, salt marshes have low species diversity of the higher vertebrates, but high species diversity of invertebrates, including shellfish, and fishes. Optimal estuarine habitat conditions for managed species’ spawning, survival, and growth depends on the structural integrity and the environmental quality of these habitats. These marsh systems are very important nursery areas in North Carolina, South Carolina, Georgia, and Florida.

Mangrove habitat can be classified into six major types based on geological and hydrological process: riverine, overwash, fringe, basin, dwarf, and hammock, while mangrove-related fish communities can be organized along various environmental gradients including salinity, mangrove detritus dependence, and substrate.

Seagrass beds in North Carolina and Florida are preferred habitat areas for many managed species including white, brown, and pink shrimp, red drum, and estuarine dependent snapper and grouper species in the larval, juvenile and adult phases of their life cycle. Seagrass meadows provide substrates and environmental conditions that are essential for feeding, spawning, and growth of a number of managed species. Seagrass meadows are complex ecosystems that provide primary production, structural complexity, energy regime modification, shoreline stabilization, and nutrient cycling.

Oyster and shell habitat in the South Atlantic can be defined as the natural structures composed of oyster shell, live oysters, and associated organisms, aside from scattered oysters in marshes and mudflats and wave-formed shell windrows. Both intertidal and subtidal populations are found in the tidal creeks and estuaries of the South Atlantic. The ecological conditions encountered are diverse and the oyster community is not uniform throughout this range. Where the tidal range is large the oyster builds massive, discrete reefs in the intertidal zone. In wind-driven lagoonal systems, like Pamlico Sound in North Carolina, oyster assemblages consist mainly of subtidal beds. Oysters are found at varying distances up major drainage basins depending upon topography, salinity, substrate, and other variables. A whole suite of organisms is associated with oyster beds at various times of the year.

Tidal flats are critical structural components of coastal systems that serve as feeding grounds and

refuges for a variety of animals. This dynamic habitat takes the form of (1) nursery grounds for early developmental stages of benthic oriented estuarine species; (2) refuges and feeding grounds for forage species of fishes; and (3) feeding grounds for specialized predators. Tidal flat habitat is extremely variable along the coast. North Carolina and Florida are largely micro-tidal (0-2m tidal range) with extensive barrier islands and relatively few inlets to extensive sound systems. In these areas wind energy has a strong affect on intertidal flats. The coasts of South Carolina and Georgia are meso-tidal (2-4m) with short barrier islands and numerous tidal inlets so that tidal currents are the primary force.

Palustrine emergent systems include tidal and non-tidal marshes. A large amount of the energy present in the palustrine emergent vegetation may be exported out of the system. Tidal currents, river currents, and wind energy all act to transport organic carbon downstream to the estuary, which is the nursery area for many managed species. Currents can also transport this material offshore. Migrating consumers, such as larval and juvenile fish and crustaceans, may feed within this dynamic palustrine habitat and then move on to the estuary or ocean. Thus, this organic carbon is also transported by trophic means.

Submersed rooted vascular vegetation in tidal fresh- or saltwater portions of estuaries and their tributaries performs the same functions as those described for seagrasses. Specifically, aquatic bed meadows possess the same four attributes: 1) primary productivity; 2) structural complexity; 3) modification of energy regimes and sediment stabilization; and 4) nutrient cycling.

The estuarine water column habitat is composed of horizontal and vertical components. Horizontally, salinity gradients (decreasing landward) strongly influence the distribution of biota, both directly (physiologically) and indirectly (e.g., emergent vegetation distribution). Horizontal gradients of nutrients, decreasing seaward, affect primarily the distribution of phytoplankton and, secondarily, organisms utilizing this primary productivity. Vertically, the water column may be stratified by salinity (fresh water runoff overlaying heavier salt water), oxygen content (lower values at the bottom associated with high biological oxygen demand due to inadequate vertical mixing), and nutrients, pesticides, industrial wastes, and pathogens (can build up near the bottom).

#### *Marine/Offshore Fish Habitat*

Marine offshore habitats include live/hard bottom, coral and coral reefs, artificial/manmade reefs, pelagic *Sargassum*, soft bottoms, and water column habitat.

Major fisheries habitats on the continental shelf along the southeastern United States from Cape Hatteras to Cape Canaveral can be organized into five general categories: coastal, open shelf, live/hard bottom, shelf edge, and lower shelf based on type of bottom and water temperature. Each of these habitats harbors a distinct association of demersal fishes and invertebrates. The description of this essential fish habitat in this entire region can be separated into two sections: (a) Cape Hatteras to Cape Canaveral; and (b) Cape Canaveral to the easternmost extent of the Florida Keys. These regions represent temperate, wide-shelf systems and tropical, narrow-shelf systems, respectively. The zoogeographic break between these regions typically occurs between Cape Canaveral and Jupiter Inlet.

'Live bottom' areas are important habitat for warm-temperate and tropical species of snappers, groupers, and associated fishes including 113 species of reef fish representing 43 families of predominately tropical and subtropical fishes off the coasts of North Carolina and South Carolina. These carbonate 'live bottom' outcroppings occur amidst a vast plain of sand and mud, often less than one meter thick. Live/hard bottom usually occurs in the zone between 15 and 35 fathoms, and at the shelf break. Steep cliffs and ledges characterize the shelf break, which occurs between approximately 35 to 100 fathoms.

Coral communities exist throughout the region from nearshore environments to continental slopes and canyons, including the intermediate shelf zones. Habitats supporting corals and coral-associated species can be categorized based on their physical and ecological characteristics. Corals might dominate a habitat, be a significant component, or be individuals within a community characterized by other fauna, depending on ecological conditions and history. The coral reefs of shallow warm waters support a wide array of hermatypic and ahermatypic corals, finfish, invertebrates, plants, and microorganisms. Hard bottoms and hard banks, found on a wider bathymetric and geographic scale, often possess high species diversity but may lack hermatypic corals, the supporting coralline structure, or some of the associated biota. In deeper waters, large elongate mounds called deepwater banks, hundreds of meters in length, often support a rich fauna compared to adjacent areas. Finally,

solitary corals can be dispersed throughout other communities (e.g., sandy bottoms).

Artificial reefs occur where structures or materials have been placed intentionally to create, restore or improve long-term habitat for the eventual exploitation, conservation, or preservation of marine ecosystems. Artificial reef hard bottom habitats are formed when a primary hard substrate is available for the attachment and development of epibenthic assemblages. This substrate is colonized when marine algae and larvae of epibenthic animals successfully settle and thrive, and demersal reef-dwelling finfish recruit to the new hard bottom habitat. Juvenile and adult life stages of a variety of interacting species of fish use this habitat for protection from predators, orientation in the water column, as a feeding arena, or as a spawning site.

The pelagic brown algae *Sargassum natans* and *S. fluitans* float on the surface of the ocean and form a dynamic structural habitat within warm waters of the western North Atlantic. Most pelagic *Sargassum* circulates between 20° and 40° N latitude and 30° W longitude and the western edge of the Florida Current/Gulf Stream. The greatest concentrations are found within the North Atlantic Central Gyre in the Sargasso Sea, but large quantities frequently occur on the continental shelf off the southeastern United States. This material sometimes remains over the shelf for extended periods, entrained into the Gulf Stream, or cast ashore. During calm conditions, *Sargassum* forms large irregular mats or floats in small clumps. Langmuir circulation, internal waves, and convergence zones along fronts aggregate the algae along with other flotsam into long meandering rows termed 'windrows'. This habitat supports a diverse assemblage of marine organisms including fungi, micro-and macro-epiphytes, at least 145 species of invertebrates, over 100 species of fishes, four species of sea turtles, and numerous marine birds. The fishes associated with pelagic *Sargassum* in the western North Atlantic include juveniles and adults of a wide variety of species.

Specific water column habitats are defined in terms of gradients and discontinuities in temperature, salinity, density, nutrients, light, and other variables. These 'structural' components of the water column environment are not static, but change in both time and space. Characterization of any marine system should incorporate consideration of such water column habitat characteristics.

Many of the parameters of the model described in this paper are 'place holders' that were re-

calculated using information recently gathered during an extensive literature survey for the construction of the West Florida Shelf model. A re-calculation of these parameters was conducted during the present effort based on the conditions and functional group aggregations that apply to the southeastern United States (Atlantic) continental shelf. A general goal of constructing an Ecopath model of this system is to provide a new whole-system analytical tool that would compliment existing tools in evaluating the effects of fishing on particular biological components, and the broader system. However, the analytical framework resulting from this effort is expected to have application to a host of issues relating to the effects of human activities on ecosystems, in addition to fishing.

The development of a preliminary Ecopath model for the South Atlantic Bight builds on the ecosystem approach taken by the South Atlantic Fishery Management Council to identify, describe and protect Essential Fish Habitat. This effort, when refined through a comprehensive workshop process, will provide further insight into the data limitations, interrelationships between and among species and their significant prey, and challenges that will be faced when developing a Fishery Ecosystem Plan for the region, which is being proposed for future amendments to the Magnuson-Stevens Fishery Conservation and Management Act in the United States.

## METHODS

Polovina (1984) originally developed the Ecopath approach for application to the coral reefs of the French Frigate Shoals. Ecopath models are food web models that describe the state of biotic flows in an ecosystem. The most typical currency used is biomass wet-weight, and they include all biotic components of an ecosystem.

Ecopath models are static descriptions of flow, but the information in these static models can be used in the dynamic simulation routines Ecosim and Ecospace. Since its origin, a variety of dynamic capabilities have been added to 'Ecopath with Ecosim' (e.g., Christensen and Pauly, 1992; Walters *et al.*, 1997; Walters *et al.*, 1999; Christensen *et al.*, 2000; Pauly *et al.*, 2000). These dynamic simulation capabilities allow explorations of the potential effects of human activities (e.g. fisheries and other disturbances or stressors) on the biological components in a system (Pauly *et al.*, 2000) and are thus a main reason for constructing Ecopath models. The



immediate goal is to document the construction of an Ecopath model of the identified area.

Scores of applications of Ecopath with Ecosim can be found at: [www.ecopath.org](http://www.ecopath.org), along with the freely distributed software and documentation. Although the formulations and basic concepts of the Ecopath with Ecosim approach are presented in many accessible venues (including those cited above), the general approach is summarized below to provide a basic understanding of the model, the present simulation, and the results.

### ***The Ecopath foundation***

The parameters needed to construct an Ecopath model are represented in the Ecopath algorithm, which expresses the law of conservation of mass or energy (Equation 1). It says that the net production of a functional group equals (1) the total mass (or energy) of that group that is removed by predators and fisheries plus (2) the net biomass accumulation in the group plus (3) the net migration of the group's biomass plus (4) the mass flow to detritus. This equation balances a group's net production (terms to the left of the equal sign) with all sources of mortality or change for that group (terms to the right of the equal sign):

$$B_i \cdot (P/B)_i \cdot EE_i = Y_i + \sum B_j \cdot (Q/B)_j \cdot DC_{ji} + BA_i + NM_i \quad \dots 1$$

$B_i$  and  $B_j$  are biomasses of prey ( $i$ ) and predators ( $j$ ) respectively;

$P/B_i$  is the production/biomass ratio, equivalent to total mortality ( $Z$ ) in most circumstances (Allen, 1971);

$EE_i$  is the ecotrophic efficiency—the fraction of the total production of a group that is utilized in the system;

$Y_i$  is the fisheries catch per unit area and time (i.e.,  $Y = F \cdot B$ );

$Q/B_j$  is the food consumption per unit biomass of  $j$ ; and

$DC_{ji}$  is the contribution of  $i$  to the diet of  $j$ ;

$BA_i$  is the biomass accumulation of  $i$  (positive or negative);

$NM_i$  is the net migration of  $i$  (emigration less immigration).

This equation describes energy or biomass flows in food webs, and its implied thermodynamic constraints underscore the power of Ecopath models as a focal point for refinement of ecosystem information. The need to reconcile energy production and demand among food web components narrows the possible ranges of parameter estimates for particular groups,

especially when good information exists for some, or many, groups in the system. Inclusion of a biomass accumulation factor and migration factor in the master equation of Ecopath distinguishes this modeling approach as an 'energy continuity' rather than a 'steady state' approach. Conservation of energy, or *continuity*, is assumed for every identified component of the ecosystem, and the system as a whole. This enables representation of changes in populations (i.e., functional groups), whether through migration or biomass accumulation (+/-).

The biological components of the ecosystem are represented using average values, or other meaningful measures of central tendency in populations. For example, biomasses, production rates, consumption rates, and diet compositions vary among seasons for many, if not most, species in aquatic and marine systems. Furthermore, these parameters change with size (~age), or ontogenetic stage, of the organisms in a system. The parameters used to characterize each group are averages that take into account both annual changes and ontogenetic changes. Experience with a variety of Ecopath models has shown that explicit inclusion of seasonal information does not change the basic answer provided by simulations, but rather makes the answer hard to interpret (C. Walters, UBC Fisheries Centre, pers. comm.). However, distinct ontogenetic changes within particular groups of interest can be represented by splitting a group into separate, but linked, ontogenetic pools, where one stage recruits into the other. Detailed age class structuring can now be incorporated in Ecopath models.

### ***Assembling the list of species***

Four main sources were used to assemble the list of over 600 species for the area covered here: summary data from the Southeast Area Monitoring and Assessment Program (SEAMAP) including a species list reviewed by SEAMAP personnel (P. Webster), the National Marine Fisheries Service (NMFS) commercial and recreational fish landings for North Carolina, South Carolina, Georgia, and the east coast of Florida ([www.st.nmfs.gov/st1/](http://www.st.nmfs.gov/st1/)); a species list recently developed for the West Florida Shelf system (Mackinson *et al.*, 2000); the NMFS marine mammal stock assessments; and two sea turtle the web sites; [www.nmfs.noaa.gov/prot\\_res/PR3/Turtles/turtles.html](http://www.nmfs.noaa.gov/prot_res/PR3/Turtles/turtles.html) and [www.ccturtle.org/species.htm](http://www.ccturtle.org/species.htm).

### **Aggregation of functional groups**

A semi-systematic approach was taken to aggregate all species in the two continental shelf ecosystems into 42 functional groups. This was accomplished by organizing the list of species into groupings that were based on the functional roles of the species. Usually, this was operationally defined by diet compositions, but also by natural history characteristics. Special groups in the model included groups managed under a federal fishery management plan and fish groups for which commercial or recreational landings exceeded 200 tonnes in any of the states within each area. Specialists were consulted to identify groups of special concern (e.g., baleen whales). The lists of species and aggregations of functional groupings were refined using the FishBase database ([www.fishbase.org](http://www.fishbase.org)) and via a detailed review by SEAMAP personnel (P. Webster).

### **Sources of the basic input parameters**

The 'basic input parameters' of the Ecopath model are biomass (B), the ratio of production to biomass (P/B), and the ratio of consumption to biomass (Q/B). Numerous sources were consulted during the assembly of basic parameter estimates, and these are listed in Appendix A. Other basic parameters include biomass accumulation, migration, the ratio of unassimilated to consumed food, and the ratio of production to consumption (P/Q).

The SEAMAP database is highlighted because these data represent the potential for estimating system-specific biomass estimates. These data consist of species-specific biomass measurements from trawl surveys that covered 129.57 km<sup>2</sup> trawled during the SEAMAP - SA program. For the purposes of this preliminary model, we assumed that the survey areas are representative of the South Atlantic States continental shelf as defined here. This is an problematic assumption, however, since SEAMAP resource surveys are restricted to shallow zones ([www.asmfc.org/Programs/Research/RESSVYS.HTM](http://www.asmfc.org/Programs/Research/RESSVYS.HTM)). Extrapolation from these data should be made on a species-specific basis, and a reasonable approach to this end should be developed for future iterations of the model. We simply estimated the total biomass of each species captured during the SEAMAP monitoring program, divided by the total swept area, and summed the results according to the functional groupings determined in the model. Biomass estimates were calculated only for those groups that we thought would be reasonably represented by the SEAMAP sampling format. However, sampling efficiency of the gear was not accounted

for when we estimated initial biomasses, and this undoubtedly lead to underestimations of biomasses in the sampled areas. The implications of these underestimations are discussed in the section on 'balancing the model.'

Most of the P/B and Q/B values in this preliminary model were derived through a process of re-aggregation of the data compiled for the West Florida Shelf model (Mackinson *et al.*, 2000) into the functional groups chosen for this model. These parameters were re-calculated based on this re-aggregation. This method will potentially bias the SAS model because these parameters were originally weighted based on relative abundances and relative consumption rates of the biological community of the West Florida Shelf. However, the literature search underlying the West Florida Shelf model was so extensive that confidence in the P/B and Q/B values in this neighboring model should be considered reasonably high, as long as differences in the relative abundances of species are taken into account (see Mackinson *et al.*, 2000). Since these two parameters (P/B and Q/B) tend to be biological properties that would be similar between physically similar systems, they are expected to be reasonable for application to the present model. Eventually, a more system-specific parameter estimation process can be undertaken.

### **Sources of diet composition information**

The sources of diet composition information include an extensive literature review of fish diets by Mackinson *et al.* (2000) and a review of FishBase (Froese and Pauly, 2001). Randall's (1967) work was a primary source of fish diet information. Sources of diet information for all of the groups are listed in Appendix A. Representative diet compositions of functional groupings were estimated by consumption-weighted averages among species for which diet composition information could be identified. These estimates were made according to the functional group aggregation of the South Atlantic States continental shelf model. An electronic file of the diet composition matrix for this preliminary model is available from the first author.

### **Source of fisheries information**

The commercial fisheries catch data from the NMFS database ([www.st.nmfs.gov/st1/commercial/index.html](http://www.st.nmfs.gov/st1/commercial/index.html)) were re-compiled at the Fisheries Centre of the University of British Columbia in order to characterize the average annual commercial fisheries landings in North

Carolina, South Carolina, Georgia, and the east coast of Florida during the late 1990s (1995-1998). Recreational catches are probably significant in this system, but they were left out of this preliminary model. These data are available on the web at [www.st.nmfs.gov/st1/recreational/index.html](http://www.st.nmfs.gov/st1/recreational/index.html) and they should be included in future iterations. Discards were then taken to be 20% of the catch rates across-the-board, and these 'place-holder' discard values were then entered in the software's discard interface. Estimates of discards should be made for every fishery in operation in this region, and these should be entered into the next iteration of the model regardless of the reliability of these estimates. Assessment of discards can follow the example of FAO (1995) and STOA (1998).

### ***Balancing the model***

The South Atlantic States shelf model has undergone two preliminary iterations. The first involved shaping the structure of the model (e.g., the functional groupings) and assembling input parameters from the general literature and from models of nearby and related systems. The second iteration incorporated site-specific biomass estimations from the SEAMAP-SA program (SEAMAP-SA / SCMRD, 2000). Sixteen out of 42 groups were thermodynamically unbalanced the first time the 'basic parameters' were estimated. The ecotrophic efficiency of these unbalanced groups ranged from 1.09 to 27.07. The mean was  $5.89 \pm 1.54$  SE. These unbalanced groups were all fish groups, except for squid, marine birds, and turtles. After SEAMAP biomass estimates were incorporated, 11 of the 42 groups were thermodynamically unbalanced, and the ecotrophic efficiency of these newly unbalanced groups ranged from 2.5 to 1,438.1, and the mean was  $165.9 \pm 127.8$  SE. The new unbalanced groups included flounders, snappers, groupers, demersal invertebrate eaters, demersal piscivores, demersal omnivores, benthic piscivores, benthic invertebrate eaters, shrimps, crabs, stomatopods, and octopods. This considerably higher imbalance with the introduction of site-specific information might partially reflect low sampling efficiency of the SEAMAP trawls for some species, or an overestimation of some of the predator biomasses, consumption rates, or diets. A combination of these two general classes of error is the most probable explanation.

The first step during the initial balancing process was to minimize cannibalism within groups, as recommended by the Ecopath architects. In essence, minimizing cannibalism minimizes energy (mass) trapping, making available more energy for other components of the food web. The

second step was to increase the entered ecotrophic efficiency (EE) values to provide more energy (mass) for consumers in the system. Most values were changed from 0.95 to 0.98, meaning that 98% of the net production of the corresponding group is consumed in the system.

The third step was to examine the consumption rates upon each unbalanced group, beginning with the most unbalanced group (in this case 'forage fish'). In cases where the higher rates of consumption were not supported by reliable diet compositions, the diets of predators were appropriately adjusted to decrease these consumption values. This meant that consumption on one group was shifted to another group where this made ecological sense. For example, it was observed that the EE value for tuna was low, and this presented the opportunity of shifting consumption from similar prey to tuna (which had been unrealistically under-exploited in our model). This is an ecologically reasonable adjustment since the full suite of ontogenetic stages of tuna is not explicitly represented in the model. It would be reasonable to assume that predators would switch from jacks, mackerel, and billfishes to tuna if the latter were more available. A related approach is to reduce the consumption rate of predators having a proportionally high impact on unbalanced groups. The Q/B value was accordingly reduced approximately 10% for the following groups: mackerel, snapper, grouper, demersal piscivores, toothed cetaceans, tuna, and pelagic piscivores.

Adjustment of biomass estimates was used liberally during the initial balancing procedure because the initial biomass estimates were considered to be placeholders, as many of them were modified from a recently constructed model of the West Florida Shelf (Mackinson *et al.*, 2000). This resulted in a balanced model with all the components (functional groups) of the South Atlantic States, but with limited connection to data from the South Atlantic States continental shelf. The next step was to incorporate biomass estimates from SEAMAP trawl data.

Table 1 shows the degree of adjustment to the SEAMAP biomass estimates made by the Ecopath software in order to obtain thermodynamic consistency with the other input parameters in the present model. Ecopath increased the biomass estimates in all but two cases. If confidence in the input data throughout the model were high, the inverse of the adjustment factor could be considered an estimate of the sampling efficiency of the SEAMAP trawls for each of the species presented.

**Table 1.** Degree of adjustment to rudimentary biomass estimations based on SEAMAP-SA / SCMRD (2000) using the preliminary Ecopath model of the South Atlantic States shelf. The inverse of these adjustments can be considered trawl sampling efficiency estimates, or a roadmap for future refinement of this preliminary model.

Functional group	SEAMAP estimate (t·km <sup>-2</sup> )	Ecopath estimate (t·km <sup>-2</sup> )	Adjustment factor
Sharks (and alligators)	0.104	0.104	1
Flounder	0.018	0.346	19
Drum and croaker	0.722	0.722	1
Snappers	0.001	0.125	125
Groupers	0.001	0.125	125
Benthic rays/skates	0.465	0.465	1
Demersal invertebrate-eaters	0.126	2.416	19
Demersal piscivores	0.028	0.203	7
Demersal omnivores	0.111	0.890	8
Benthic piscivores	0.038	0.140	4
Benthic invertebrate-eaters	0.014	0.602	43
Shrimps	0.030	7.639	255
Crabs	0.022	9.261	421
Stomatopods	0.002	2.845	1423

However, in the case of this model iteration, the biomass estimates calculated by Ecopath might be considered by some to be unreasonably large. This provocative result should be considered as a roadmap for future refinement of model inputs (better input data tends to lead to a higher degree of internal consistency). Nevertheless, it is also reasonable that the biomass of shrimps, crabs, and stomatopods are typically underestimated in assessments, as indicated by other east coast Ecopath models (e.g., Mackinson *et al.*, 2000). Indeed, assessments focus on adult forms and fishery sizes, but the bulk of the biomass of a species or functional group can occur at smaller sizes or life stages. Alternatively, these groups might be relatively overemphasized in the gut contents of their predators because their chitinous integuments persist longer, relative to soft-bodied prey.

## RESULTS

The number of trophic connections in this marine ecosystem renders food web diagrams somewhat incomprehensible. Table 2 shows some of the basic parameters of the South Atlantic States continental shelf model. Summary statistics for the system are presented in Table 3. The diet composition matrix is not presented, but is available from the first author.

**Table 3.** Basic summary statistics for the preliminary Ecopath model of the South Atlantic States continental shelf. Values are expressed in wet weight.

Parameter	Value	Units
Sum of all consumption	6089.381	t·km <sup>-2</sup> ·year <sup>-1</sup>
Sum of all exports	1807.018	t·km <sup>-2</sup> ·year <sup>-1</sup>
Sum of all respiratory flows	2529.107	t·km <sup>-2</sup> ·year <sup>-1</sup>
Sum of all flows into detritus	4092.102	t·km <sup>-2</sup> ·year <sup>-1</sup>
Total system throughput	14518.000	t·km <sup>-2</sup> ·year <sup>-1</sup>
Sum of all production	5420.000	t·km <sup>-2</sup> ·year <sup>-1</sup>
Calculated total net primary production	4335.955	t·km <sup>-2</sup> ·year <sup>-1</sup>
Net system production	1806.848	t·km <sup>-2</sup> ·year <sup>-1</sup>
Total biomass (excluding detritus)	469.737	t·km <sup>-2</sup>
Total catches	0.787	t·km <sup>-2</sup> ·year <sup>-1</sup>
Mean trophic level of the catch	3.01	-
Gross efficiency (catch/net p.p.)	0.000181	-
Total primary production/total respiration	1.714	-
Total primary production/total biomass	9.231	-
Total biomass/total throughput	0.032	-
Connectance Index	0.281	-
System omnivory Index	0.217	-

**Table 2.** Basic parameters of the preliminary Ecopath model of the South Atlantic States continental shelf. Values in bold have been calculated with the Ecopath software; other values are empirically based inputs. Omnivory index (= variance of prey trophic levels) is denoted by 'OI'.

Group	Trophic level	OI	Biomass (t·km <sup>-2</sup> )	P/B (year <sup>-1</sup> )	Q/B (year <sup>-1</sup> )	EE
Billfishes	<b>4.3</b>	<b>0.371</b>	0.005	0.44	5.29	<b>0.962</b>
Sharks (& alligators)	<b>4.3</b>	<b>0.302</b>	0.104	0.43	4.18	<b>0.628</b>
Tuna	<b>4.2</b>	<b>0.316</b>	0.024	0.85	12.00	<b>0.801</b>
Toothed cetaceans	<b>4.1</b>	<b>0.174</b>	0.058	0.10	27.00	<b>0.000</b>
Mackerel	<b>4.0</b>	<b>0.069</b>	0.207	0.38	8.00	<b>0.941</b>
Groupers	<b>4.0</b>	<b>0.202</b>	<b>0.125</b>	0.70	5.00	0.950
Jacks	<b>3.9</b>	<b>0.111</b>	0.068	0.56	9.20	<b>0.854</b>
Snappers	<b>3.9</b>	<b>0.225</b>	<b>0.125</b>	0.57	5.40	0.950
Pelagic piscivores	<b>3.9</b>	<b>0.270</b>	0.232	0.86	13.50	<b>0.837</b>
Octopods	<b>3.9</b>	<b>0.193</b>	<b>0.072</b>	3.10	7.30	0.980
Demersal piscivores	<b>3.8</b>	<b>0.193</b>	<b>0.203</b>	0.84	8.10	0.950
Marine birds	<b>3.8</b>	<b>0.716</b>	0.001	0.10	80.00	<b>0.800</b>
Benthic piscivores	<b>3.8</b>	<b>0.340</b>	<b>0.140</b>	0.39	8.73	0.950
Drum and croaker	<b>3.4</b>	<b>0.254</b>	0.722	0.47	7.34	<b>0.915</b>
Benthic invert-eaters	<b>3.4</b>	<b>0.164</b>	<b>0.602</b>	1.73	13.57	0.950
Squid	<b>3.4</b>	<b>0.205</b>	1.900	2.43	33.00	<b>0.966</b>
Flounder	<b>3.3</b>	<b>0.148</b>	<b>0.346</b>	0.30	9.46	0.950
Benthic rays/skates	<b>3.3</b>	<b>0.452</b>	0.465	0.40	8.96	<b>0.769</b>
Lobsters	<b>3.2</b>	<b>0.325</b>	<b>0.364</b>	0.90	8.20	0.950
Baleen whales	<b>3.2</b>	<b>0.213</b>	0.144	0.05	10.90	<b>0.000</b>
Demers. planktivores	<b>3.1</b>	<b>0.060</b>	<b>0.114</b>	2.60	10.00	0.980
Sea turtles	<b>3.1</b>	<b>0.412</b>	0.007	0.19	3.50	<b>0.471</b>
Dem. invert-eaters	<b>3.1</b>	<b>0.472</b>	<b>2.416</b>	0.77	8.71	0.950
Stomatopods	<b>3.0</b>	<b>0.653</b>	<b>2.845</b>	1.34	7.43	0.980
Pelagic planktivores	<b>3.0</b>	<b>0.304</b>	<b>9.416</b>	0.89	8.54	0.980
Other fishes	<b>3.0</b>	<b>0.086</b>	<b>22.240</b>	0.70	7.04	0.980
Forage fishes	<b>2.9</b>	<b>0.202</b>	<b>25.065</b>	0.93	13.88	0.990
Jellies	<b>2.8</b>	<b>0.160</b>	<b>0.270</b>	40.00	80.00	0.950
Crabs	<b>2.7</b>	<b>0.316</b>	<b>9.261</b>	1.38	8.50	0.980
Shrimp	<b>2.7</b>	<b>0.268</b>	<b>7.639</b>	3.16	19.20	0.980
Demers. omnivores	<b>2.6</b>	<b>0.382</b>	<b>0.890</b>	1.47	21.87	0.950
Echinoderms	<b>2.3</b>	<b>0.225</b>	25.000	1.20	3.70	<b>0.709</b>
Sessile epibenthos	<b>2.2</b>	<b>0.144</b>	<b>78.605</b>	0.80	9.00	0.850
Benthic macro & meio	<b>2.0</b>	<b>0.040</b>	<b>67.314</b>	5.08	21.52	0.990
Bivalves	<b>2.0</b>	<b>0.011</b>	55.000	1.22	23.00	<b>0.813</b>
Manatees	<b>2.0</b>	<b>0.000</b>	0.001	0.10	36.50	<b>0.000</b>
Zooplankton	<b>2.0</b>	<b>0.000</b>	36.500	13.00	43.30	<b>0.910</b>
Macroalgae	<b>1.0</b>	<b>0.000</b>	<b>52.096</b>	4.00	-	0.800
Microphytobenthos	<b>1.0</b>	<b>0.000</b>	37.000	55.57	-	<b>0.328</b>
Phytoplankton	<b>1.0</b>	<b>0.000</b>	<b>5.645</b>	332.67	-	0.990
Sea grasses	<b>1.0</b>	<b>0.000</b>	<b>26.507</b>	7.30	-	0.500
Detritus	<b>1.0</b>	<b>0.362</b>	518.000	-	-	<b>0.559</b>

## DISCUSSION

This preliminary model of the South Atlantic States continental shelf was constructed to provide a quantitative framework for the refinement of the model's input parameters so that a cohesive view of the whole marine ecosystem can emerge, and so that system-wide questions about the workings of the system can be explored. We suggest this model can be a focal point for scrutiny and criticism of input parameters, and thus act as a vehicle for a new view of the system to emerge. We recommend that experts in the various biotic components of the system be identified and involved into a coordinated and collaborative refinement strategy that would address suggestions and 'refinement negotiations' in a transparent and efficient manner.

Notwithstanding the natural limitations of broad-system modeling approaches, this model has tremendous potential to provide an accessible and useful view of the whole ecosystem for scientists, students, and the general public. This approach can become a critical complement to other available assessment and management tools currently in use or being developed, and can help bring us into the new era of ecosystem-based management. The dynamic simulation approaches that accompany the Ecopath with Ecosim approach are not addressed in the current paper, but descriptions of these are provided by Christensen and Pauly (1992), Walters *et al.* (1997), Walters *et al.* (1999), Christensen *et al.* (2000), Pauly *et al.* (2000), and Walters *et al.* (2000).

A process of refining the model by a working group of experts needs to be coordinated such that a central copy is maintained. Also this process should include several iterations of review and refinement. However, a practical sunset for the process should be clearly identified in order to apply the model to questions of interest in the system with a standard iteration of the model that is considered adequately useful.

Improvements to the model should begin with the broadest issues, such as issues of system definition and aggregation of functional groupings (overall model structure). Species should be aggregated based on functional rather than taxonomic similarity, but the structure of the model can be adjusted according to the interest of the investigators. That is to say, a particular sub-system of the model can be 'broken out' if the questions of interest relate to the articulation of that sub system. Suggested improvements should

then proceed to the refinement and tuning of specific parameter estimates based on the research and scrutiny of experts.

## ACKNOWLEDGEMENTS

We are grateful to the numerous people who helped develop the West Florida Shelf Ecopath model, upon which the present preliminary model of the Southeastern U.S. continental shelf was based. These people include W. Arnold, S. Burghart, R. Caldwell, W. Graham, P. Houhoulis, A. Jackson, S. Mackinson, B. Mahmoudi, D. Marelli, R. Matheson, C. Meyer, M. Murphy, R. Muller, J. Nance, S. Nesbitt, T. Sutton, M. Vasconcellos, and L. Vidal-Hernandez. We are also grateful to the Florida Fish and Wildlife Conservation Commission for supporting that intensive effort. D. Pauly and B. Muller provided helpful comments on the manuscript. P. Webster of the Southeastern Atlantic Marine Assessment Program invested time and careful attention to the review and refinement of the species list upon which the Southeastern U.S. continental shelf model was based. Habitat descriptions were prepared through a cooperative effort of State, Federal and regional habitat partners on the South Atlantic Fishery Management Council's Habitat and Coral Advisory Panels, additional technical experts identified during Council EFH workshops, and Council staff. Special thanks to S. Guénette and G. Weingartner for their patience and editorial work. The *Sea Around Us* project—an ocean health assessment initiative supported by the Pew Charitable Trusts of Philadelphia, USA—supported the development of this preliminary model of the southeastern U.S. continental shelf.

**Appendix A.** Sources of basic parameter estimates. The values used as inputs in the preliminary South Atlantic States continental shelf model were derived from these sources based on their application to the defined system, rather than being simply extracted.

<b>Group</b>	<b>Biomass (t·km<sup>-2</sup>)</b>	<b>P/B (year<sup>-1</sup>)</b>	<b>Q/B (year<sup>-1</sup>)</b>	<b>Diet composition</b>
Billfishes	Mackinson (2000)	Mackinson (2000)	Mackinson (2000)	Mackinson (2000)
Sharks (& gators)	SEAMAP-SA / SCMRD (2000)	Mackinson (2000)	Mackinson (2000)	Mackinson (2000)
Tuna	Mackinson (2000)	Mackinson (2000)	Mackinson (2000)	Mackinson (2000)
Toothed cetaceans	NMFS (2000), Trites & Pauly (1998)	Matkin & Hobbs (1999b)	Kastelein <i>et al.</i> (1997) in Matkin & Hobbs (1999)	Vasconcellos (2000a)
Mackerel	Mackinson (2000)	Mackinson (2000)	Mackinson (2000)	Mackinson (2000)
Groupers	SEAMAP-SA / SCMRD (2000)	Mackinson (2000)	Mackinson (2000)	Mackinson (2000)
Jacks	Mackinson (2000)	Mackinson (2000)	Mackinson (2000)	Randall (1967)
Snappers	SEAMAP-SA / SCMRD (2000)	Mackinson (2000)	Mackinson (2000)	Mackinson (2000)
Pelagic piscivores	Mackinson (2000)	Mackinson (2000)	Mackinson (2000)	Mackinson (2000)
Octopods	SEAMAP-SA / SCMRD (2000)	Buchan & Smale (1981) in Opitz (1993)	Guerra (1979)	Whitaker <i>et al.</i> (1991) in Grubert <i>et al.</i> (1999)
Demersal piscivores	SEAMAP-SA / SCMRD (2000)	Mackinson (2000)	Mackinson (2000)	Mackinson (2000)
Marine birds	Vidal-Hernandez & Nesbitt (2000)	Acosta <i>et al.</i> (1998)	Vidal-Hernandez & Nesbitt (2000); Nilsson & Nilsson (1976)	Vidal-Hernandez & Nesbitt (2000)
Benthic piscivores	SEAMAP-SA / SCMRD (2000)	Mackinson (2000)	Mackinson (2000)	Mackinson (2000)
Drum & croaker	SEAMAP-SA / SCMRD (2000)	Mackinson (2000)	Mackinson (2000)	Mackinson (2000)
Benth invert-eaters	SEAMAP-SA / SCMRD (2000)	Mackinson (2000)	Mackinson (2000)	Mackinson (2000)
Squid	Mendoza (1993)	Mendoza (1993) & Pauly <i>et al.</i> (1993)	Mendoza (1993)	Amaratunga (1983) in Mendoza (1993); Karpov & Cailliet (1978)
Flounder	SEAMAP-SA / SCMRD (2000)	Mackinson (2000)	Mackinson (2000)	Topp & Hoff (1972)
Benthic rays/skates	SEAMAP-SA / SCMRD (2000)	Mackinson (2000)	Mackinson (2000)	Mackinson (2000)
Lobsters	O'hop <i>et al.</i> , (unpublished data <sup>a</sup> )	Arreguín-Sánchez <i>et al.</i> (1993)	Arreguín-Sánchez <i>et al.</i> (1993)	Martinez (2000)
Baleen whales	Dolphin (1987), NMFS (2000)	Matkin & Hobbs (1999a)	Dolphin (1987)	Okey (estimation)
Demers. planktivores		Mackinson (2000)	Mackinson (2000)	Mackinson (2000)
Sea turtles	Vasconcellos (2000 b)	Vasconcellos (2000b)	Polovina (1984)	Vasconcellos (2000b)
Dem. invert-eaters	SEAMAP-SA / SCMRD (2000)	Mackinson (2000)	Mackinson (2000)	Mackinson (2000)
Stomatopods	SEAMAP-SA / SCMRD (2000)	Meyer & Caldwell (2000)	Meyer & Caldwell (2000)	Meyer & Caldwell (2000)
Pelagic planktivores	-	Mackinson (2000)	Mackinson (2000)	Mackinson (2000)
Other fishes	-	-	-	Mackinson (2000)
Forage fishes	-	Mackinson (2000)	-	Mackinson (2000)

## Appendix A. cont.

Group	Biomass (t·km <sup>-2</sup> )	P/B (year <sup>-1</sup> )	Q/B (year <sup>-1</sup> )	Diet composition
Jellies		Okey <i>et al.</i> (1999), Graham (2000)	Purcell (1983), Graham (2000)	Graham & Kroutil (submitted); Okey <i>et al.</i> (1999)
Crabs	SEAMAP-SA / SCMRD (2000)	Ehrhardt & Restrepo (1989) in Okey & Meyer (2000)	Arreguín-Sánchez <i>et al.</i> (1993)	Okey & Meyer (2000)
Shrimp	SEAMAP-SA / SCMRD (2000)	Parrack (1981); Arreguín-Sánchez <i>et al.</i> (1993); Okey & Nance (2000)	Arreguín-Sánchez <i>et al.</i> (1993)	Huff & Cobb (1979 in Okey & Nance, 2000)
Demers. omnivores	SEAMAP-SA / SCMRD (2000)	Mackinson (2000)	Mackinson (2000)	Mackinson (2000)
Echinoderms	Okey (2000b)	Lewis (1981); Schwinghamer <i>et al.</i> (1986) in Opitz (1993)	Pauly <i>et al.</i> (1993)	Okey (2000a)
Sessile epibenthos	-	Odum & Odum (1955) & Sorokin (1987) in Opitz (1993)	Based on Wilkinson (1987) & Sorokin (1987) in Opitz (1993)	Okey (2000d)
Benth. macro & meio	-	Arreguín-Sánchez <i>et al.</i> (1993)	Arreguín-Sánchez <i>et al.</i> (1993)	Okey (2000c,e)
Bivalves	Arnold <i>et al.</i> (2000)	Arnold <i>et al.</i> (2000)	Guénette (1996)	Arnold <i>et al.</i> (2000)
Manatees	Vasconcellos (2000c), Rathbun <i>et al.</i> (1995), USFWS (1993)	B. Ackerman, pers. comm. (in Vasconcellos, 2000c)	B. Ackerman, pers. comm. (in Vasconcellos, 2000c)	Bengtson (1981) & O'Shea (1986) from USFWS (1993)
Zooplankton	Sutton & Burghart (2000)	Sutton & Burghart (2000)	Sutton & Burghart (2000)	T.A. Okey (estimation)
Macroalgae	-	Luning (1990)	n/a	n/a
Microphytobenthos	Cahoon <i>et al.</i> (1990), Cahoon & Cooke (1992)	Cahoon & Cooke (1992)	n/a	n/a
Phytoplankton	-	Cahoon & Cooke (1992)	n/a	n/a
Sea grasses	-	P. Carlson, pers. comm. <sup>b</sup>	n/a	n/a
Detritus	Okey (2000b)	n/a	n/a	n/a

<sup>a</sup>Based on J. O'hop, M. Tupper, and S. Brown, Florida Marine Research Institute (unpublished data).

<sup>b</sup>P. Carlson, Florida Marine Resources Institute, personal communication, 3 March 2000.



## REFERENCES

- Acosta, A., Dunmire, T., and Venier, J. 1998. A Preliminary Trophic Model of the Fish Communities of Florida Bay. Proceedings of 1998 Florida Bay Science Conference. University of Miami, Miami, FL USA. 58 pp.
- Allen, R. R. 1971. Relation between production and biomass. *Journal of the Fisheries Research Board of Canada*, 28: 1573-1581.
- Amaratunga, T. 1983. The role of cephalopods in the marine ecosystem. In *Advances in Assessment of World Cephalopod Resources*, pp. 379-412. Ed. By J. F. Caddy. FAO Fisheries Technical Paper, 231.
- Arnold, W. S., Marelli, D., and Okey, T. A. 2000. Bivalves. In *An Ecosystem Model of the West Florida Shelf for use in Fisheries Management and Ecological Research*. Ed. By S. Mackinson, T.A. Okey, M. Vasconcellos, L. Vidal-Hernandez, B. Mahmoudi, Submitted to the Florida Fish and Wildlife Conservation Commission, Florida Marine Research Institute, St. Petersburg [to be published as a technical report].
- Arreguín-Sánchez, F., Seijo, J. C., and Valero-Pacheco, E. 1993. An application of ECOPATH II to the north continental shelf ecosystem of Yucatan, Mexico. In *Trophic Models of Aquatic Ecosystems*, pp. 269-278. Ed. by V. Christensen and D. Pauly. ICLARM Conference Proceedings, 26. 390 pp.
- Buchan, P. R., and Smale, M. J. 1981. Estimates of biomass, consumption and production of *Octopus vulgaris* Cuvier off the east coast of South Africa. *Oceanographic Research Institute, Investigational Report*, 50. 9 pp.
- Cahoon, L. B. and Cooke, J. E. 1992. Benthic microalgal production in Onslow Bay, North Carolina, USA. *Marine Ecology Progress Series*, 84: 185-196.
- Cahoon, L. B., Redman, R. S., Tronzo, C. R. 1990. Benthic Macroalgal biomass in sediments of Onslow Bay, North Carolina. *Estuarine, Coastal and Shelf Science*, 31: 805-816.
- Christensen, V. and Pauly, D. 1992. *ECOPATH II - A system for balancing steady-state ecosystem models and calculating network characteristics*. *Ecological Modeling*, 61: 169-185.
- Christensen, V., Walters, C. J., and Pauly, D. 2000. *Ecopath with Ecosim - A User's Guide*. University of British Columbia, Fisheries Centre, Vancouver, Canada and ICLARM, Penang, Malaysia. 131 pp.
- Cronon, W. 1983. *Changes in the Land : Indians, Colonists, and the Ecology of New England*. Hill and Wang, New York. 241 pp.
- Crosby, A. W. 1986. *Ecological Imperialism: the Biological Expansion of Europe, 900-1900*. Cambridge University Press, New York. 368 pp.
- Dolphin, W. F. 1987. Prey densities and foraging of humpback whales, *Megaptera novaeangliae*. *Experientia*, 43: 468-471.
- Ehrhardt, N. M., and Restrepo, V. R. 1989. The Florida stone crab fishery: a reusable resource? In *Marine Invertebrate Fisheries: Their Assessment and Management*, pp. 225-240. Ed. by J. F. Caddy. John Wiley and Sons, New York. 752 pp.
- FAO. 1995. *Global Assessment of Fisheries Bycatch and Discards*, 2<sup>nd</sup> Edition. Fisheries Technical Paper, 339. 256 ppp.
- Froese, R. and Pauly, D. Editors. 2001. FishBase. World Wide Web Electronic publication. [www.fishbase.org](http://www.fishbase.org), 01 April 2001
- Graham, W. 2000. Carnivorous jellyfish. In *An Ecosystem Model of the West Florida Shelf for use in Fisheries Management and Ecological Research*. Ed. By S. Mackinson, T.A. Okey, M. Vasconcellos, L. Vidal-Hernandez, B. Mahmoudi, Submitted to the Florida Fish and Wildlife Conservation Commission, Florida Marine Research Institute, St. Petersburg [to be published as a technical report].
- Graham, W. M. and Kroutil, R. M. (submitted). Sex-based prey selectivity and dietary shifts in the jellyfish, *Aurelia aurita*. *Journal of Plankton Research*.
- Grubert, M. A., Wadley, V. A., and White, R. W. G. 1999. Diet and feeding strategy of *Octopus maorum* in Southeast Tasmania. *Bulletin of Marine Science*, 65: 441-451.
- Guénette, S. 1996. Macrobenthos. pp. 65-67. In: *Mass-Balance Models of North-Eastern Pacific Ecosystems*, Ed. by D. Pauly and V. Christensen. Fisheries Centre Research Report 4(1).
- Guerra, A. 1979. Edad y crecimiento de *Octopus vulgaris* del Atlantico centro-oriental (26°10'N-23°30'N). Committee for the Eastern Central Atlantic Fisheries Series, 78: 113-126.
- Huff, J. A., and Cobb, S. P. 1979. Penaeoid and Surgestoid Shrimps (Crustacea: Decapoda). *Memoirs of the Hourglass Cruises*. Marine Research Laboratory, Florida Department of Natural Resources, St. Petersburg, Florida. 102 pp.
- Karpov, K. A. and Cailliet, G. M. 1978. Feeding dynamics of *Loligo opalescens*. In *Biological, Oceanographic, and Acoustic aspects of the Market Squid, Loligo opalescens* Berry, pp. 45-66. Ed. by C. W. Reckseik and H. W. Frey. California Department of Fish and Game, Fish Bulletin, 169.
- Kastelein, R. A., Hardeman, J., and Boer, H. 1997. Food consumption and body weight of harbor porpoises (*Phocoena phocoena*). In *The Biology of the Harbor Porpoise*, pp. 217-233. Ed. by A. J. Read, P. R. Weipkema and P. E. Nachtigall. De Spil Publishers, The Netherlands.
- Lewis, V. P. and Peters, D. S. 1994. Diet of juvenile and adult Atlantic menhaden in estuarine and coastal habitats. *Transactions of the American Fisheries Society*, 123: 803-810.
- Luning, K. 1990. *Seaweeds: Their Environment, Biogeography, and Ecophysiology*. John Wiley and Sons, Inc., New York. 527 pp.
- Mackinson, S., Okey, T.A., Vasconcellos, M., Vidal-Hernandez, L., Mahmoudi, B. (Eds.), 2000. *An Ecosystem Model of the West Florida Shelf for use in Fisheries Management and Ecological Research*, Submitted to the Florida Fish and Wildlife Conservation Commission, Florida Marine Research Institute, St. Petersburg [to be published as a technical report].
- Mackinson, S. 2000. Fishes. In *An Ecosystem Model of the West Florida Shelf for use in Fisheries Management and Ecological Research*. Ed. By S. Mackinson, T.A. Okey, M. Vasconcellos, L. Vidal-Hernandez, B. Mahmoudi, Submitted to the Florida Fish and Wildlife Conservation Commission, Florida Marine Research Institute, St. Petersburg [to be published as a technical report].
- Mallin, M. A., Burkholder, J. M., Cahoon, L. B., and Posey, M. H. 2000. North and South Calolina coasts. *Marine Pollution Bulletin* 41(1-6):56-75.
- Martínez, C. E. 2000. Trophic ecology of *Panulirus gracilis*, *P. penicillatus* and *Scyllarides astori* in the lobster fisheries of the Galapagos. Master's Thesis. University of Azuay, Ecuador. 102 pp.
- Matkin, C. and Hobbs, R. 1999a. Baleen whales. p. 56. In: *A Trophic Mass-Balance Model of Alaska's Prince William Sound Ecosystem, for the Post-Spill Period 1994-1996*, 2<sup>nd</sup> ed. Ed. by T. A. Okey and D. Pauly. Fisheries Centre Research Report 7(4).
- Matkin, C. and Hobbs, R. 1999b. Small cetaceans. pp. 61-62. In: *A Trophic Mass-Balance Model of Alaska's Prince William Sound Ecosystem, for the Post-Spill Period 1994-1996*, 2<sup>nd</sup> ed. Ed. by T. A. Okey and D. Pauly. Fisheries Centre Research Report 7(4).
- Mendoza, J. J. 1993. A preliminary biomass budget for the northeastern Venezuela shelf ecosystem. In *Trophic Models of Aquatic Ecosystems*, pp. 285-297. Ed. by V. Christensen and D. Pauly. ICLARM Conference Proceedings, 26. 390 pp.

- Meyer, C. A. and Caldwell, R. L. 2000. Stomatopods. In An Ecosystem Model of the West Florida Shelf for use in Fisheries Management and Ecological Research. Ed. By S. Mackinson, T.A. Okey, M. Vasconcellos, L. Vidal-Hernandez, B. Mahmoudi, Submitted to the Florida Fish and Wildlife Conservation Commission, Florida Marine Research Institute, St. Petersburg [to be published as a technical report].
- Mowat, F. 1984. Sea of Slaughter. Atlantic Monthly Press, Boston. 438 pp.
- Nilsson, S. G. and Nilsson, I. N. 1976. Number, food and consumption, and fish predation by birds in Lake Mockeln, Southern Sweden. *Ornis Scandinavica*, 7: 61-71.
- NMFS. 2000. U.S. Atlantic and Gulf of Mexico Marine Mammal Stock Assessments - 2000. NOAA Technical Memorandum NMFS-NE-162. National Marine Fisheries Service, Northeast Fisheries Science Center, Woods Hole, Massachusetts. 300 pp.
- Odum, H. T., and Odum, E. P. 1955. Trophic structure and productivity of a windward coral reef community on Eniwetok Atoll. *Ecological Monographs*, 25: 291-320.
- Okey, T. A. 2000a. Echinoderms and gastropods. In An Ecosystem Model of the West Florida Shelf for use in Fisheries Management and Ecological Research. Ed. By S. Mackinson, T.A. Okey, M. Vasconcellos, L. Vidal-Hernandez, B. Mahmoudi, Submitted to the Florida Fish and Wildlife Conservation Commission, Florida Marine Research Institute, St. Petersburg [to be published as a technical report].
- Okey, T. A. 2000b. Detritus. In An Ecosystem Model of the West Florida Shelf for use in Fisheries Management and Ecological Research. Ed. By S. Mackinson, T.A. Okey, M. Vasconcellos, L. Vidal-Hernandez, B. Mahmoudi, Submitted to the Florida Fish and Wildlife Conservation Commission, Florida Marine Research Institute, St. Petersburg [to be published as a technical report].
- Okey, T. A. 2000c. Small infauna. In An Ecosystem Model of the West Florida Shelf for use in Fisheries Management and Ecological Research. Ed. By S. Mackinson, T.A. Okey, M. Vasconcellos, L. Vidal-Hernandez, B. Mahmoudi, Submitted to the Florida Fish and Wildlife Conservation Commission, Florida Marine Research Institute, St. Petersburg [to be published as a technical report].
- Okey, T. A. 2000d. Sessile epibenthos. In An Ecosystem Model of the West Florida Shelf for use in Fisheries Management and Ecological Research. Ed. By S. Mackinson, T.A. Okey, M. Vasconcellos, L. Vidal-Hernandez, B. Mahmoudi, Submitted to the Florida Fish and Wildlife Conservation Commission, Florida Marine Research Institute, St. Petersburg [to be published as a technical report].
- Okey, T. A. 2000e. Small mobile epifauna. In An Ecosystem Model of the West Florida Shelf for use in Fisheries Management and Ecological Research. Ed. By S. Mackinson, T.A. Okey, M. Vasconcellos, L. Vidal-Hernandez, B. Mahmoudi, Submitted to the Florida Fish and Wildlife Conservation Commission, Florida Marine Research Institute, St. Petersburg [to be published as a technical report].
- Okey, T. A. and Meyer, C. A. 2000. Large crabs. In An Ecosystem Model of the West Florida Shelf for use in Fisheries Management and Ecological Research. Ed. By S. Mackinson, T.A. Okey, M. Vasconcellos, L. Vidal-Hernandez, B. Mahmoudi, Submitted to the Florida Fish and Wildlife Conservation Commission, Florida Marine Research Institute, St. Petersburg [to be published as a technical report].
- Okey, T. A. and Nance, J. 2000. Adult Shrimp. In An Ecosystem Model of the West Florida Shelf for use in Fisheries Management and Ecological Research. Ed. By S. Mackinson, T.A. Okey, M. Vasconcellos, L. Vidal-Hernandez, B. Mahmoudi, Submitted to the Florida Fish and Wildlife Conservation Commission, Florida Marine Research Institute, St. Petersburg [to be published as a technical report].
- Okey, T. A., Foy, R. J., and Purcell, J. 1999. Carnivorous Jellies. p. 19. In: A Trophic Mass-Balance Model of Alaska's Prince William Sound Ecosystem, for the Post-Spill Period 1994-1996, 2<sup>nd</sup> ed. Ed. by T. A. Okey and D. Pauly. Fisheries Centre Research Report 7(4).
- Opitz, S. 1993. A quantitative model of the trophic interactions in a Caribbean coral reef ecosystem. In *Trophic Models of Aquatic Ecosystems*, pp. 259-267. Ed. by V. Christensen and D. Pauly. ICLARM Conference Proceedings, 26.
- Parrack, M. L. 1981. Some aspects of brown shrimp exploitation in the northern Gulf of Mexico. Workshop on the Scientific Basis for the Management of Penaeid Shrimp. Key West, Florida.
- Pauly, D., Christensen, V., and Walters, C. 2000. Ecopath, Ecosim, and Ecospace as tools for evaluating ecosystem impacts of fisheries. *ICES Journal of Marine Science*, 57: 697-706.
- Pauly, D., Sambily, V. Jr., and Opitz, S. 1993. Estimates of relative food consumption by fish and invertebrate populations, required for modeling the Bolinao Reef ecosystem, Philippines. In *Trophic Models of Aquatic Ecosystems*, pp. 236-251. Ed. by V. Christensen and D. Pauly. ICLARM Conference Proceedings, 26.
- Polovina, J. J. 1984. Model of a coral reef ecosystem I. The ECOPATH model and its applications to French Frigate Shoals. *Coral Reefs*, 3: 1-11.
- Purcell, J. E. 1983. Digestion rates and assimilation efficiencies of siphonophores fed zooplankton prey. *Marine Biology*, 73: 257-261.
- Randall, J. E. 1967. Food habits of reef fishes in the West Indies. *Studies in Tropical Oceanography (Miami)*, 5: 665-847.
- Rathbun, G. B., Reid, J. P., Bonde, R. K., and Powell, J. A. 1995. Reproduction in free-ranging Florida manatees. In *Population Biology of the Florida Manatee (Trichechus manatus latirostris)*, pp. 135-156. Ed. by T. J. O'Shea, B. B. Ackerman and H. F. Percival. National Biological Service, Information and Technology Report, 1.
- Reeves, R. R., Breiwick, J. M., and Mitchell, E. D. 1999. History of whaling and estimated kill of right whales, *Balaena glacialis*, in the northeastern United States, 1620-1924. *Marine Fisheries Review*, 61: 1-36.
- SAFMC. 1998a. Habitat Plan for the South Atlantic Region: Essential Fish Habitat Requirements for Fishery Management Plans of the South Atlantic Fishery Management Council. May 1998. 639 pp.
- SAFMC. 1998b. Comprehensive Amendment Addressing Essential Fish Habitat in Fishery Management Plans of the South Atlantic Region. Including a Draft Environmental Impact Statement /Supplemental Environmental Impact Statement, Initial Regulatory Flexibility Analysis, Regulatory Impact Review, and Social Impact Assessment/Fishery Impact Statement. South Atlantic Fishery Management Council. 136 pp.
- SEAMAP-SA / SCMRD. 2000. SEAMAP-South Atlantic 10-year trawl report: Results of trawling efforts in the coastal habitat of the south Atlantic Bight, FY 1990-1999. Prepared for the Atlantic States Marine Fisheries Commission by the SEAMAP-SA / South Carolina Department of Natural Resources, Marine Resources Research Institute, Charleston, South Carolina. 143 pp.
- STOA. 1998. The Problem of Discards in Fisheries. Scientific and Technical Options Assessment. STOA Publications, no. EP/IV/STOA/98/17/01; [www.europarl.eu.int/stoa/publi/98-17-01/default\\_en.htm](http://www.europarl.eu.int/stoa/publi/98-17-01/default_en.htm)
- Sutton, T. T. and Burghart, S. E. 2000. Zooplankton. In An Ecosystem Model of the West Florida Shelf for use in Fisheries Management and Ecological Research. Ed. By S. Mackinson, T.A. Okey, M. Vasconcellos, L. Vidal-

- Hernandez, B. Mahmoudi, Submitted to the Florida Fish and Wildlife Conservation Commission, Florida Marine Research Institute, St. Petersburg [to be published as a technical report].
- Topp, R. W. and Hoff, F. H. 1972. Memoirs of the hourglass cruises. Flatfishes (Pleuronectiformes). Marine Research Laboratory, Florida Department of Natural Resources, St. Petersburg Florida, 4: 1-135.
- Trites, A. W. and Pauly, D. 1998. Estimating mean body masses of marine mammals from maximum body lengths. *Canadian Journal of Zoology*, 76: 886-896.
- Turner, S. J., Thrush, S. F., Hewitt, J. E., Cummings, V. J. and Funnell, G. 1999. Fishing impacts and the degradation or loss of habitat structure. *Fisheries Management and Ecology*, 6: 401-420.
- USFWS. 1993. Draft Florida Manatee Recovery Plan, second revision, prepared by the Florida Manatee Recovery Team. U.S. Fish and Wildlife Service, Atlanta, GA. 176 pp.
- Vasconcellos, M. 2000a. Dolphins. In *An Ecosystem Model of the West Florida Shelf for use in Fisheries Management and Ecological Research*. Ed. By S. Mackinson, T.A. Okey, M. Vasconcellos, L. Vidal-Hernandez, B. Mahmoudi, Submitted to the Florida Fish and Wildlife Conservation Commission, Florida Marine Research Institute, St. Petersburg [to be published as a technical report].
- Vasconcellos, M. 2000b. Sea Turtles. In *An Ecosystem Model of the West Florida Shelf for use in Fisheries Management and Ecological Research*. Ed. By S. Mackinson, T.A. Okey, M. Vasconcellos, L. Vidal-Hernandez, B. Mahmoudi, Submitted to the Florida Fish and Wildlife Conservation Commission, Florida Marine Research Institute, St. Petersburg [to be published as a technical report].
- Vasconcellos, M. 2000c. Manatees (*Trichechus manatus latirostris*). In *An Ecosystem Model of the West Florida Shelf for use in Fisheries Management and Ecological Research*. Ed. By S. Mackinson, T.A. Okey, M. Vasconcellos, L. Vidal-Hernandez, B. Mahmoudi, Submitted to the Florida Fish and Wildlife Conservation Commission, Florida Marine Research Institute, St. Petersburg [to be published as a technical report].
- Vidal-Hernandez, L. and S. Nesbitt. 2000. Seabirds of the West Florida Shelf. In *An Ecosystem Model of the West Florida Shelf for use in Fisheries Management and Ecological Research*. Ed. By S. Mackinson, T.A. Okey, M. Vasconcellos, L. Vidal-Hernandez, B. Mahmoudi, Submitted to the Florida Fish and Wildlife Conservation Commission, Florida Marine Research Institute, St. Petersburg [to be published as a technical report].
- Walters, C. J., Christensen, V., and Pauly, D. 1997. Structuring dynamic models of exploited ecosystems from trophic mass balance assessments. *Reviews in Fish Biology and Fisheries*, 7: 139-172.
- Walters, C. J., Kitchell, J. F., Christensen, V., and Pauly, D. 2000. Representing density dependent consequences of life history strategies in an ecosystem model. *Ecosystems*, 3: 70-83.
- Walters, C. J., Pauly, D., and Christensen, V. 1999. Ecospace: prediction of mesoscale spatial patterns in trophic relationships of exploited ecosystems, with emphasis on the impacts of marine protected areas. *Ecosystems*, 2: 539-564.
- Watling, L. and Norse, E. A. 1998. Disturbance of the seabed by mobile fishing gear: A comparison to forest clearcutting. *Conservation Biology*, 12: 1180-1197.
- Whittaker, J. D., Delancey, L. B., and Jenkins, J. E. 1991. Aspects of the biology and fisheries potential for *Octopus vulgaris* off the coast of South Carolina. *Bulletin of Marine Science*, 49: 482-49.

### **PART III: NORTHEAST ATLANTIC**

#### **CONSTRUCTING AN ICELANDIC MARINE ECOSYSTEM MODEL FOR 1997 USING A MASS-BALANCE MODELLING APPROACH**

**Asberr Natoumbi Mendy<sup>1</sup> and Eny  
Angraini Buchary<sup>2</sup>**

<sup>1</sup> Fisheries Department, Department of State for  
Presidential Affairs,  
Fisheries and Natural Resources, 6 Marina Parade,  
Banjul, The Gambia

<sup>2</sup> Fisheries Centre, University of British Columbia,  
2204 Main Mall, Vancouver, B.C., V6T 1Z4, Canada  
email: e.buchary@fisheries.ubc.ca

#### **ABSTRACT**

This paper, as part of the *Sea Around Us* project (SAUP), documents the construction of an ecosystem model for the Icelandic marine ecosystem comprising twenty-four functional groups and including fourteen fleets.

#### **INTRODUCTION**

Iceland (Figure 1) covers an area of 103,000 km<sup>2</sup> ([www.fao.org/fi/fcp/Icele.asp](http://www.fao.org/fi/fcp/Icele.asp)). The surrounding continental shelf (0-200 m depth) has a total area of 111,000 km<sup>2</sup>, while the 200 nm EEZ covers 750,000 km<sup>2</sup> ([www.fao.org/fi/fcp/Icele.asp](http://www.fao.org/fi/fcp/Icele.asp); Figure 2). ICES area Va and the EEZ overlap to a large extent, although 373,000 km<sup>2</sup> of the EEZ is outside of ICES area Va (Figure 3). The present model covers ICES fishing area Va (Figure 2, 3), an area of 376,766 km<sup>2</sup> (R. Watson, pers. comm.).

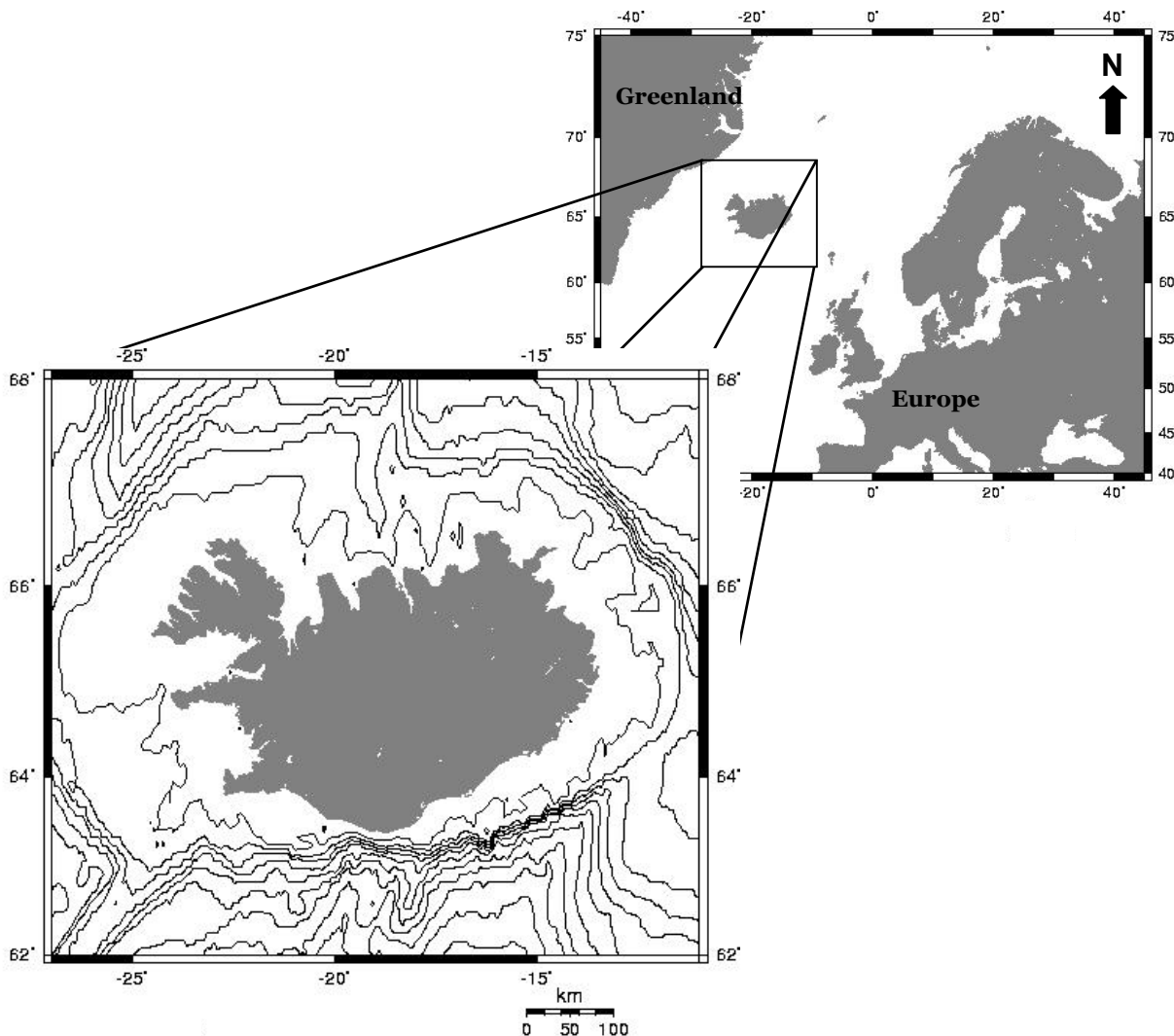

**Figure 1:** Location of Iceland and bathymetry in the surrounding waters.

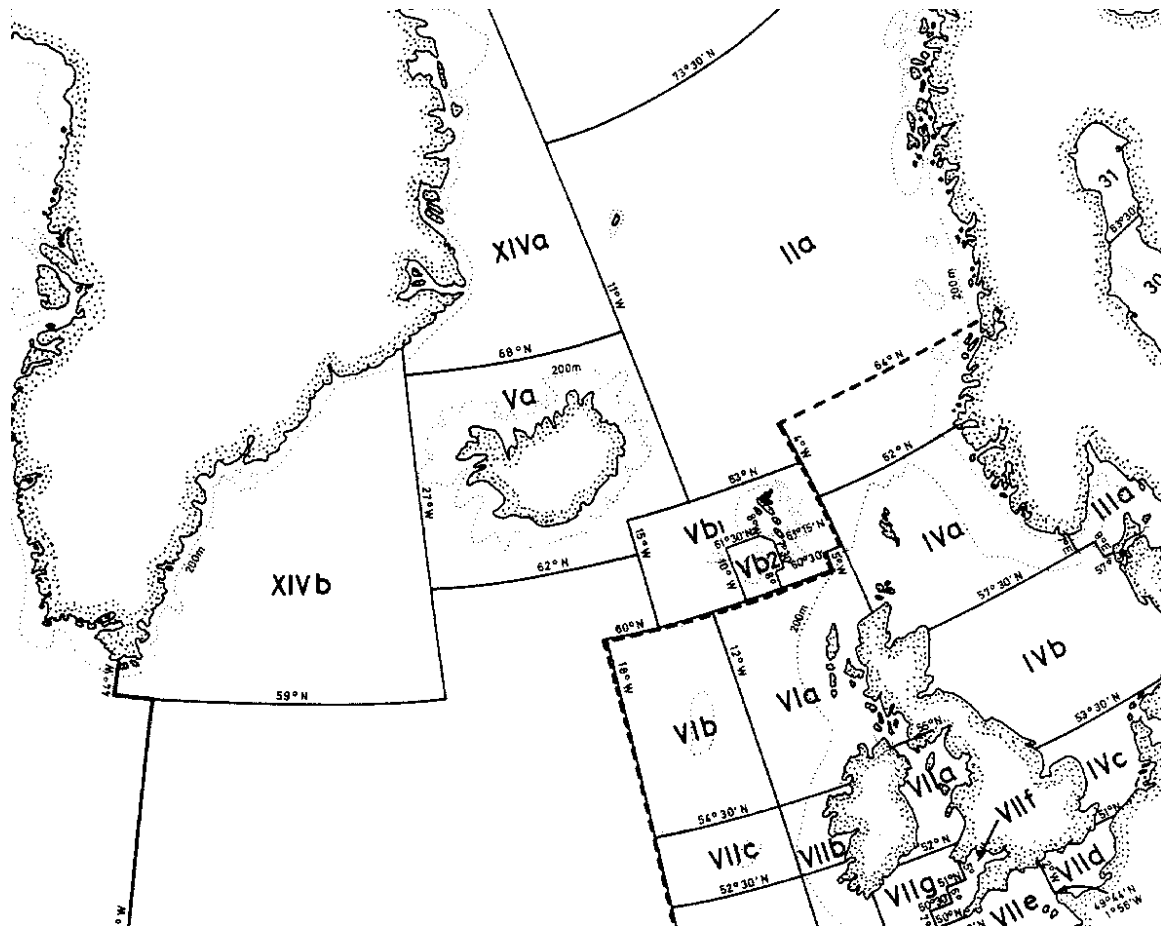

**Figure 2:** ICES Fisheries Statistical Areas, illustrating ICES area Va ( $11^{\circ}$  -  $27^{\circ}$  W and  $62^{\circ}$  -  $68^{\circ}$  N), used here as the model area ( $376,766 \text{ km}^2$ ).

The present model of Icelandic marine ecosystem covers the year 1997. Marine mammals are divided into three ecologically distinct groups, i.e., 'toothed whales', 'baleen whales' and 'pinnipeds'. 'Split groups' (Walters *et al.*, 1997) were used only for cod, by splitting juvenile and adult biomass pools. The fisheries are represented by fourteen fleets: (1) foreign pelagic, (2) foreign demersal, (3) line and gillnet, (4) danish seines, (5) bottom trawls, (6) midwater trawls, (7) lobster trawls, (8) herring seines, (9) capelin seines, (10) capelin midwater trawls, (11) shrimp trawls, (12) dredge and traps, (13) seal guns, and (14) harpoons.

Harpoons were used in the 1950s to hunt toothed whales and baleen whales, but their use had stopped by 1997 (Valtýsson, 2001). In order to make comparison feasible between the past (1950; see Buchary, this volume) and the present-day (1997) models of Icelandic waters, 'harpoons' were included as a 'fleet' in the 1997 model. The 1997 catch proportion of harpoons was taken from the 1950 model, but the actual catches were  $1/100,000^{\text{th}}$  of those in the 1950s – thus the 1997 catches were essentially zero.

Biomass data of most fished groups were taken from the single species stock assessment analyses undertaken by the Marine Research Institute using virtual population analysis (VPA) (Marine Research Institute, 2000). The production/biomass (P/B) ratios of these fished groups were estimated using the same single species VPA data. The consumption/biomass (Q/B) ratios were calculated using the empirical formula of Pauly *et al.* (1990), based on fish growth study information provided in FishBase (Froese and Pauly, 2001; [www.fishbase.org](http://www.fishbase.org)). Unless the fish growth study cited in FishBase provided information on temperature, a median temperature of  $4^{\circ}\text{C}$  was assumed. Diet composition data for marine mammals were taken from Pauly *et al.* (1998). Biomass, P/B and Q/B data for the three marine mammal groups were derived from the Marine Mammals Database of the *Sea Around Us* project (Kaschner, 2001). In the case of certain functional groups, such as the seabirds, or groups that are not commercially fished, data from neighboring ecosystems were used. These include the Newfoundland-Labrador

Shelf model (Bundy *et al.*, 2000) and the North Sea model (Christensen, 1995).

Catch data were obtained from the official ICES fisheries statistics database (ICES STATLANT version 1999, [www.ices.dk/fish/statlant.htm](http://www.ices.dk/fish/statlant.htm)), except for catches of capelin and marine mammals, which were taken from the national fisheries statistics database of Iceland assembled by Valtýsson (2001). As ICES STATLANT database only provides total catches by species, country and area, the distribution of catches by gear type was derived from a cross-tabulation between the national fisheries statistics of Iceland (Valtýsson, 2001) and the ICES STATLANT database. In general, the 1997 statistics of Icelandic fisheries in the ICES STATLANT database were very similar to those in the national fisheries statistics of Iceland. Discard information

was taken from a 1992 study on discarding practices by the Icelandic groundfish trawlers reported by Agnarsson (2000), and collated by Valtýsson (2001). In this model, the resulting estimates of discards were applied to trawlers that actually caught the species in question in 1997.

In 1997 three countries were fishing in area Va, Faroe Islands, Norway and Portugal. Since the level of foreign fishing was relatively low, foreign fleets were only divided into two fleets, foreign pelagic and foreign demersal.

All parameters were pedigreed (see Christensen *et al.*, 2000) and the resulting model (Tables 1-4) has 25 functional groups, comprising of two primary producer groups, six invertebrate groups, twelve fish groups, one seabirds group, three marine mammals groups and one detritus group.

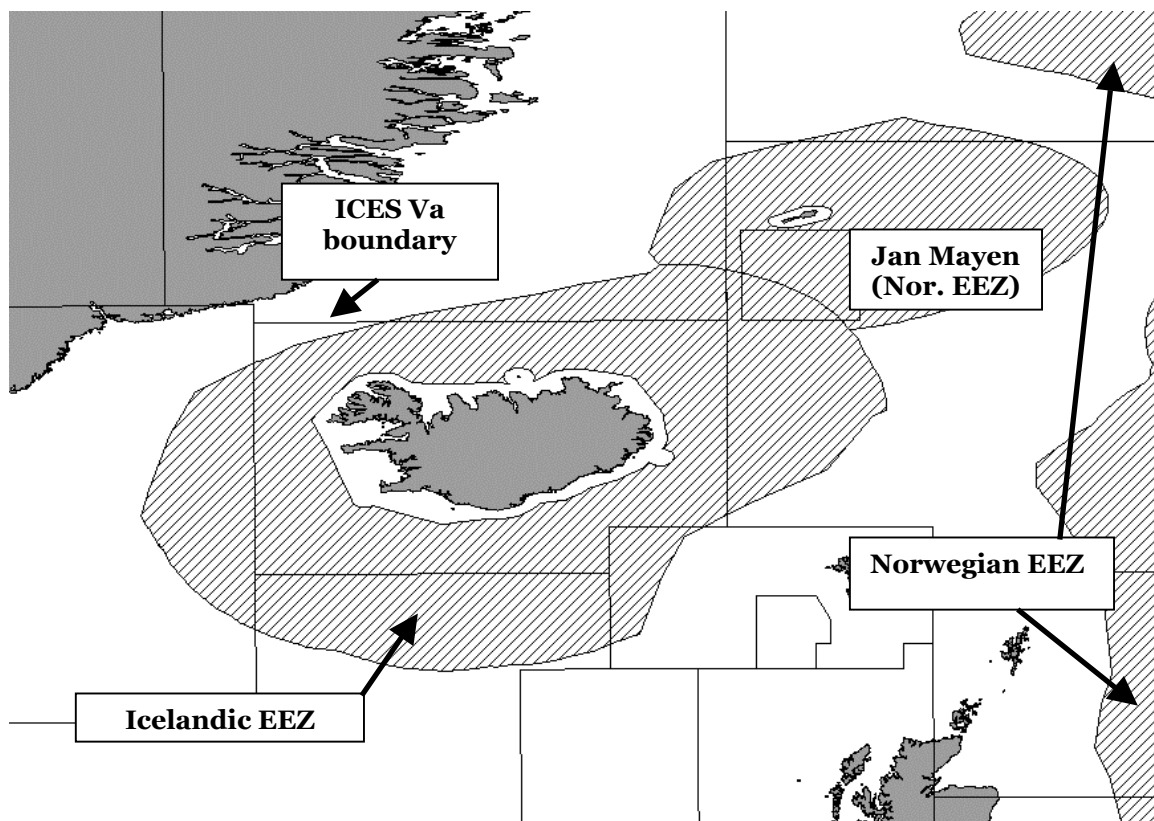

**Figure 3:** Overlap between ICES area Va and Icelandic 200 nm EEZ (hatched area). Parts of the Norwegian EEZ, including around Jan Mayen Island are also shown.

**Table 1:** Input (and output) parameters of the Ecopath model of Icelandic marine ecosystem in 1997. Values in brackets were estimated by the program.

No.	Group name	Trophic level	Biomass (t·km <sup>-2</sup> )	P/B (year <sup>-1</sup> )	Q/B (year <sup>-1</sup> )	EE	P/Q
1	Toothed whales	(4.3)	0.024	0.003	2.471	(0.755)	(0.001)
2	Baleen whales	(4.0)	0.068	0.009	4.275	(0.897)	(0.002)
3	Pinnipeds	(4.1)	0.057	0.023	11.184	(0.824)	(0.002)
4	Seabirds	(3.8)	0.012	0.250	54.750	(0.674)	(0.005)
5	Adult cod	(3.9)	2.643	0.475	2.454	(0.503)	(0.194)
6	Juvenile cod	(3.4)	0.213	(1.827)	6.090	(0.423)	0.300
7	Haddock	(3.5)	0.277	0.642	2.947	(0.964)	(0.218)
8	Saithe	(4.0)	0.428	0.496	2.327	(0.774)	(0.213)
9	Redfish	(3.9)	2.000	(0.400)	2.000	(0.743)	0.200
10	Greenland halibut	(4.3)	(0.347)	(0.488)	2.440	0.950	0.200
11	Other flatfish	(3.6)	(0.604)	(0.530)	2.649	0.950	0.200
12	Other dem. fish	(3.4)	(1.243)	(0.347)	2.312	0.950	0.150
13	Herring	(3.0)	1.555	(0.708)	4.723	(0.324)	0.150
14	Capelin	(2.9)	6.776	(1.327)	6.633	(0.792)	0.200
15	Other pelagics	(3.1)	(9.468)	0.290	(1.933)	0.950	0.150
16	<i>Nephrops</i>	(2.8)	0.037	0.310	(1.548)	(0.961)	0.200
17	Northern shrimp	(2.9)	(0.875)	1.830	(9.150)	0.950	0.200
18	Molluscs	(3.0)	(0.358)	(0.950)	6.330	0.750	0.150
19	Benthos	(2.0)	(39.152)	0.600	(6.667)	0.500	0.090
20	Other fish	(3.5)	(4.397)	(0.700)	3.500	0.950	0.200
21	Krill	(3.0)	(4.497)	3.000	15.000	0.950	0.200
22	Zooplankton	(2.0)	(24.949)	5.915	20.085	0.950	(0.294)
23	Benthic producers	(1.0)	3,685	4.430	-	(0.005)	-
24	Phytoplankton	(1.0)	(6.336)	200	-	0.400	-
25	Detritus	(1.0)	200	-	-	(0.011)	-

## MODEL PARAMETERIZATION

### Marine mammals: toothed whales, baleen whales and pinnipeds

The Marine Mammal Database of the SAUP (Kaschner, 2001) provides comprehensive ecosystem related data on marine mammals that have been collated from various sources (e.g., Trites *et al.*, 1997; Trites and Pauly, 1998; Pauly *et al.*, 1998). The information is arranged around three spatial classification systems: FAO areas, biogeochemical provinces (Longhurst, 1995; 1998) and ocean basins. For the purpose of the present model, Longhurst provinces were used to derive the relevant marine mammal data. The study area (ICES area Va) is located in the biogeochemical provinces ARCT (Atlantic Arctic,  $2.1 \times 10^6$  km<sup>2</sup>) and SARC (Atlantic Subarctic,  $2.33 \times 10^6$  km<sup>2</sup>). Therefore, biomass, production, consumption and diet information for marine mammals were derived from these two areas.

According to the database, there are fourteen species of toothed whales in ARCT and SARC: Atlantic white-sided dolphin (*Lagenorhynchus acutus*), bottlenose dolphin (*Tursiops truncatus*), common dolphin (*Delphinus delphis*), killer whale (*Orcinus orca*), long-finned pilot whale (*Globicephala melas*), white-beaked dolphin (*Lagenorhynchus albirostris*), beluga or white whale (*Delphinapterus leucas*), narwhal (*Monodon monoceros*), sperm whale (*Physeter catodon*), Blainville's beaked whale (*Mesoplodon densirostris*), Cuvier's beaked whale (*Ziphius cavirostris*), northern bottlenose whale (*Hyperoodon ampullatus*), harbor porpoise (*Phocoena phocoena*), and Sowerby's beaked whale (*Mesoplodon bidens*).

Estimation of toothed whale populations in ARCT and SARC areas from the database (Kaschner, 2001) resulted in a biomass of 0.024 t·km<sup>-2</sup>. P/B was indirectly estimated using the maximum population rate of increase ( $r_{\max}$ ) for toothed whales, i.e., 4% (Reilly and Barlow, 1986), while production was estimated to be half of  $r_{\max}$ ,

**Table 2:** Catch data (t·km<sup>-2</sup>·year<sup>-1</sup>) for the model of Icelandic marine ecosystem in 1997 and the estimated mean trophic level (TL) of the catch for each fishing sector. Catches with very low values are represented by '0' in the matrix.

Group	Catch (t·km <sup>-2</sup> ·year <sup>-1</sup> )															Total
	Foreign Pelagic	Foreign Demersal	Line & Gillnet	Danish Seine	Bottom Trawl	MW Trawl	Lobster Trawl	Herring Seine	Capelin Seine	Capelin MWT	Shrimp trawl	Dredge & Traps	Seal guns	Harpoons		
Toothed whales														0	0	
Baleen whales														0	0	
Pinnipeds													0.0004		0	
Adult cod		0.00108	0.27513	0.03936	0.2201		0.00339		0		0.00014				0.54	
Haddock		0.0009	0.02653	0.01423	0.0731		0.00091		0		0.00002				0.12	
Saithe		0.0019	0.02646	0.00451	0.0658		0.00028								0.1	
Redfish		0.00064				0.19634									0.2	
Greenland halibut		0.00007	0.00445		0.04						0				0.04	
Other flatfish		0.0003	0.00349	0.05699	0.0098		0.00268				0				0.07	
Other dem. fish		0.00303	0.05683	0.0072	0.0297	0.00001	0.0018				0				0.1	
Herring			0		0			0.06488	0.0522	0.07157					0.19	
Capelin	0.2557							0.03408	3.3683	0.08426					3.74	
Other pelagics	0.0002		0.00001	0	0.00001					0.02767					0.03	
<i>Nephrops</i>					0		0.00322								0	
Northern shrimp											0.19126				0.19	
Molluscs					0.00001							0.04234			0.04	
Benthos		0										0.00005			0	
Benthic producers												0.5177			0.52	
<b>Total catch</b>	<b>0.256</b>	<b>0.00792</b>	<b>0.39291</b>	<b>0.12229</b>	<b>0.4386</b>	<b>0.19636</b>	<b>0.01228</b>	<b>0.09896</b>	<b>3.4204</b>	<b>0.1835</b>	<b>0.19143</b>	<b>0.56009</b>	<b>0.0004</b>	<b>0</b>	<b>5.88</b>	
<b>TL</b>	<b>2.9</b>	<b>3.68</b>	<b>3.83</b>	<b>3.70</b>	<b>3.86</b>	<b>3.87</b>	<b>3.45</b>	<b>2.97</b>	<b>2.90</b>	<b>2.96</b>	<b>2.85</b>	<b>1.15</b>	<b>4.13</b>	<b>4.04</b>	<b>2.92</b>	

Note: MW = mid-water; MWT = mid-water trawls



resulting in a generic P/B of 2% for toothed whales (Trites and Heise, 1996). When this generic P/B was weighted-averaged by the estimated total population biomass of toothed whales, P/B was then estimated to be 0.003 year<sup>-1</sup> for toothed whales population in both ARCT and SARC. The consumption/biomass (Q/B) ratio was derived using the mean body mass data (Trites and Pauly, 1998) for each identified toothed whales species and weighted-averaged by the estimated total population biomass of each identified toothed whale species in both ARCT and SARC areas, using the method described by Trites and Heise (1996). Q/B was estimated as 2.471 year<sup>-1</sup>. Diet composition information for toothed whales (Table 3) was also extracted from the database (Kaschner, 2001; based on Pauly *et al.*, 1998) and reapportioned into appropriate functional groups.

Seven species of baleen whales were recorded in the ARCT and SARC areas: bowhead whale (*Balaena mysticetus*), northern right whale (*Eubalaena glacialis*), blue whale (*Balaenoptera musculus*), fin whale (*Balaenoptera physalus*), humpback whale (*Megaptera novaeangliae*), minke whale (*Balaenoptera acutorostrata*), and sei whale (*Balaenoptera borealis*).

The biomass estimated for the baleen whales population in ARCT and SARC areas is 0.068 t·km<sup>-2</sup>. Reilly and Barlow (1986) also estimated a maximum population rate of increase ( $r_{max}$ ) of 4% for baleen whales, and production was estimated to be half of  $r_{max}$ , resulting in a generic P/B of 2% for baleen whales (Trites and Heise, 1996). When weighted-averaged by the estimated total population biomass, the P/B ratio for baleen whales population in ARCT and SARC became 0.009 year<sup>-1</sup>. The Q/B ratio for the baleen whales population was estimated using the same approach as for the toothed whales, resulting in an estimate of 4.275 year<sup>-1</sup>. Diet composition data for baleen whales (Table 3) were also extracted from the database (Kaschner, 2001; based on Pauly *et al.*, 1998) and reapportioned into appropriate functional groups.

The SAUP Marine Mammal Database (Kaschner, 2001) recorded seven species of pinnipeds in ARCT and SARC areas: walrus (*Odobenus rosmarus*), bearded seal (*Erignathus barbatus*), grey seal (*Halichoerus grypus*), harbor/common seal (*Phoca vitulina*), harp seal (*Phoca groenlandica*), hooded seal (*Cystophora cristata*), ringed seal (*Phoca hispida*).

Using the same biomass estimation approach applied to toothed and baleen whales, the

estimated biomass for the total population of pinnipeds in ARCT and SARC is 0.057 t·km<sup>-2</sup>. Assuming a maximum population rate of increase ( $r_{max}$ ) of 12% for northern fur seals and other pinnipeds (Small and DeMaster, 1995), the production was estimated to be half of  $r_{max}$ , resulting in a generic P/B of 6% for pinnipeds (Trites and Heise, 1996). When weighted-averaged by their total population biomass in ARCT and SARC, the estimated P/B for pinnipeds became 0.023 year<sup>-1</sup>. Following the same Q/B estimation method described above, the weighted-averaged biomass Q/B for pinnipeds in ARCT and SARC areas was 11.184 year<sup>-1</sup>. Diet composition information for pinnipeds were also extracted from the Marine Mammal Database (Kaschner, 2001; based on Pauly *et al.*, 1998) and reapportioned into appropriate functional groups (Table 3).

In terms of marine mammal catches, the Marine Research Institute (2000) indicated that there were 1,973 seals caught in 1997, consisting of 674 common seal pups, 356 grey seal pups, 16 adult common seals, 918 adult grey seals, and 9 other seals. These catches equal to 148 tonnes (Valtýsson, 2001), resulting in Ecopath catches of 0.000393 t·km<sup>-2</sup>·year<sup>-1</sup> for pinnipeds (Table 2). Toothed whales and baleen whales were not caught in 1997, however, as explained in the Introduction section, very low catches by harpoons were assigned for these two groups. There were no known discards for pinnipeds in 1997.

## Seabirds

Various studies indicate that seabirds migrate seasonally throughout the northern Atlantic ocean, but timing and routes are not well understood. The six most numerous seabird species found in Iceland are included here, and their diet composition was based on Lilliendahl and Solmundsson (1997; see Table 3). These six seabird species are common murres or common guillemots (*Uria aalge*), thick-billed murre or Bruennich's guillemots (*Uria lomvia*), razorbills (*Alca torda*), puffins (*Fratercula arctica*), kittiwakes (*Rissa tridactyla*), and northern fulmars (*Fulmarus glacialis*).

The other input parameters were adapted from the same species from the Newfoundland-Labrador Shelf model of Bundy *et al.* (2000). Thus, biomass, P/B and Q/B were set at 0.012 t·km<sup>-2</sup>, 0.25 year<sup>-1</sup> and 54.75 year<sup>-1</sup>, respectively. Diet composition data (Table 3) were taken from Lilliendahl and Solmundsson (1997). No landings nor discards were assigned to this group.



**Table 3:** Continued.

Group no.	Prey	Predator group											
		11	12	13	14	15	16	17	18	19	20	21	22
1	Toothed whales												
2	Baleen whales												
3	Pinnipeds												
4	Seabirds												
5	Adult cod		0.0052										
6	Juvenile cod	0.0114	0.0102										
7	Haddock												
8	Saithe												
9	Redfish	0.0682	0.0209										
10	Greenland halibut												
11	Other flatfish												
12	Other dem. fish		0.0021										
13	Herring					0.001					0.0015		
14	Capelin	0.042	0.0387								0.001		
15	Other pelagics					0.0252					0.1014		
16	Nephrops		0.0005						0.001				
17	Northern shrimp	0.0375	0.0345										
18	Molluscs		0.0314										
19	Benthos	0.5685	0.4796			0.1893	0.3	0.3	0.2351		0.0345		
20	Other fish	0.2274	0.2094			0.0151			0.1763				
21	Krill	0.0450	0.042	0.1							0.3998		
22	Zooplankton			0.8	0.9	0.7693	0.5	0.55	0.3526		0.4618	1.0	
23	Benthic producers									0.3			
24	Phytoplankton			0.1	0.1		0.05	0.05					1.0
25	Detritus		0.1255				0.15	0.1	0.2351	0.7			

**Table 4:** Primary production required to sustain the fisheries (PPR, *sensu* Christensen and Pauly, 1993), calculated based on all food path ways in the modeled system.

Group Name	No. of paths	TL	PPR <sup>a</sup>	Catch <sup>b</sup>	PPR/catch	PPR/Tot PP (%)	PPR/unit of catch <sup>c</sup>
Toothed whales	22,634	4.25	0.01	0	757,460.40	0	21.89 <sup>d</sup>
Baleen whales	5,640	4.04	0.01	0	20,482.02	0	0.59 <sup>d</sup>
Pinnipeds	1,1317	4.13	33.76	0	85,909.55	0.1	2.48
Adult cod	1,326	3.93	142.36	0.54	264.02	0.41	0.01
Haddock	202	3.47	13.07	0.12	112.99	0.04	0
Saithe	442	4.04	17.94	0.1	181.37	0.05	0.01
Redfish	64	3.87	23.51	0.2	119.33	0.07	0
Greenland halibut	2,214	4.34	29.23	0.04	655.75	0.08	0.02
Other flatfish	113	3.60	17.43	0.07	237.80	0.05	0.01
Other dem. fish	1,183	3.40	29.12	0.1	295.39	0.08	0.01
Herring	3	3.00	6.09	0.19	32.27	0.02	0
Capelin	2	2.90	62.06	3.74	16.58	0.18	0
Other pelagics	15	3.05	1.46	0.03	52.41	0	0
Nephrops	5	2.80	0.14	0	43.27	0	0
Northern shrimp	5	2.85	8.40	0.19	43.91	0.02	0
Molluscs	24	3.03	5.87	0.04	138.67	0.02	0
Benthos	2	2.00	0	0	11.11	0	0
Benthic producers	0	1.00	0	0.52	0	0	0
<b>Total</b>	<b>45,191</b>	<b>2.92</b>	<b>299.86</b>	<b>5.88</b>	<b>50.99</b>	<b>1.7</b>	<b>-</b>

<sup>a</sup>PPR, in t PP·km<sup>-2</sup>·year<sup>-1</sup>.

<sup>b</sup>Catch, in t·km<sup>-2</sup>·year<sup>-1</sup>.

<sup>c</sup>This is for a catch of 1 t·km<sup>-2</sup>·year<sup>-1</sup>.

<sup>d</sup>This is an artifact of the very low dummy catches of harpoons assigned in the model; see 'Introduction'.

## Adult cod

This group consists only of adult stage *Gadus morhua*. We defined 'adult' here as post-recruit stage of  $\geq 3$  years. The biomass for this group was estimated using the 1997 single species VPA analysis of cod ages 3 - 14 in Iceland (Tables 3.1.2., and 3.1.6. in Marine Research Institute, 2000), and corresponds to 2.643 t·km<sup>-2</sup>.

Assuming a natural mortality of 0.2 year<sup>-1</sup> for cod (Table 3.1.9. in Marine Research Institute, 2000) and using fishing mortality of cod ages 3-14 from the VPA analysis (Table 3.1.7. in Marine Research Institute, 2000), P/B was estimated to be 0.475 year<sup>-1</sup>. The Q/B ratio (2.454 year<sup>-1</sup>) was estimated using an empirical formula in Christensen and Pauly (1992) and information from growth studies of cod in Iceland (Saemundsson, 1923; Jónsson, 1957, 1965; Schopka and Hempel, 1973; all as compiled in FishBase, Froese and Pauly, 2001). Diet composition for cod (Table 3) was modified from Pálsson (1983) and Gunnarson *et al.* (1998).

The Ecopath catch value for cod (Table 2) in 1997 equals to 0.539 t·km<sup>-2</sup>·year<sup>-1</sup> (ICES STATLANT version 1999) which can be broken down (Valtýsson, 2001) to 202,745 t for the Icelandic fleets (103,658 t by line & gillnet, 14,829 t by Danish seines, 82,927 t by bottom trawls, 1,278 t by lobster trawls, 2 t by capelin seines, and 52 t by shrimp trawls) and 408 t for Faroese fleets (which were assumed to be 'foreign demersal' fleets).

The reported cod discard rate of 0.4% (Agnarsson, 2000, cited in Valtýsson, 2001) was used in this model, and resulted in discards of 0.0009 t·km<sup>-2</sup>·year<sup>-1</sup> for bottom trawls, 0.000014 t·km<sup>-2</sup>·year<sup>-1</sup> for lobster trawls, and 0.000001 t·km<sup>-2</sup>·year<sup>-1</sup> for shrimp trawls. Consequently, by subtracting the discards from the catches, total cod landing became 0.538 t·km<sup>-2</sup>·year<sup>-1</sup> in 1997.

## Juvenile cod

We defined 'juvenile cod' as pre-recruit *Gadus morhua*, and these include cod ages 0-2. This assumption is similar to the one used in the Newfoundland-Labrador Shelf model of Bundy *et al.* (2000).

Assuming that the natural mortality rate of juvenile cod is  $0.6 \text{ year}^{-1}$  (Bundy *et al.*, 2000) and that catch of juvenile cod is negligible, the biomass of this group was calculated using the back estimation of the single species VPA abundance of cod age 3 in 2000, 1999 and 1998 in Iceland (Table 3.1.6 in Marine Research Institute, 2000) to obtain the 1997 cod biomass of ages 0, 1 and 2, respectively. Average body weight used are  $0.0023 \text{ kg}$  for age 0 (Thorisson, 1991),  $0.0233 \text{ kg}$  for age 1 and  $0.231 \text{ kg}$  for age 2 (Anon., 1997). The estimate gives average biomass of  $80,234 \text{ t}$  of age 0-2 cod in the study area, or  $0.213 \text{ t}\cdot\text{km}^{-2}$ .

Instead of calculating P/B ratio, the P/Q (gross food conversion efficiency ratio) was set to 0.3 following suggestions by Christensen *et al.* (2000) for juvenile groups. The Q/B ( $= 6.09 \text{ year}^{-1}$ ) was taken from the Q/B of cod  $\leq 35 \text{ cm}$  in the Newfoundland-Labrador Shelf model (Bundy *et al.* 2000). Diet composition for juvenile cod (Table 3) was taken from Pálsson (1983) and Gunnarson *et al.* (1998). No landings or discards were assigned to this group.

### Haddock

The biomass of haddock (*Melanogrammus aeglefinus*) was estimated from the single species VPA of haddock ages 2-9 in Iceland (Tables 3.2.6 and 3.2.3 in Marine Research Institute, 2000), which equaled to  $0.277 \text{ t}\cdot\text{km}^{-2}$ .

Assuming a natural mortality rate of  $0.2 \text{ year}^{-1}$  (Table 3.2.8 in Marine Research Institute, 2000) and using the VPA data (Marine Research Institute, 2000), the P/B ratio for haddock was estimated to be  $0.642 \text{ year}^{-1}$ . Q/B ( $= 2.947 \text{ year}^{-1}$ ) was derived using an empirical formula in Christensen and Pauly (1992) and information from a growth study of haddock in Iceland (Blacker, 1971; compiled in FishBase, Froese and Pauly, 2001). Diet composition for haddock (Table 3) was taken from Pálsson (1983) and Gunnarson *et al.* (1998).

The 1997 catches of haddock in Icelandic waters (ICES STATLANT 1999 version; Valtýsson, 2001) were comprised of  $43,245 \text{ t}$  caught by the Icelandic fleets ( $9,997 \text{ t}$  by line & gill,  $5,362 \text{ t}$  by Danish seines,  $27,535 \text{ t}$  by bottom trawls,  $0.01 \text{ t}$  by midwater trawls,  $342 \text{ t}$  by lobster trawls,  $1 \text{ t}$  by capelin seines, and  $8 \text{ t}$  by shrimp trawls) and  $340 \text{ t}$  by the Faroe Islands (demersal) fleets. Thus, the haddock's Ecopath catch value equals to  $0.115682 \text{ t}\cdot\text{km}^{-2}\cdot\text{year}^{-1}$  (Table 2).

In this model, a discard rate of 2.2% (Agnarsson, 2000, cited in Valtýsson, 2001) was used for haddock and was applied to bottom trawls ( $0.001608 \text{ t}\cdot\text{km}^{-2}\cdot\text{year}^{-1}$ ) and lobster trawls ( $0.00002 \text{ t}\cdot\text{km}^{-2}\cdot\text{year}^{-1}$ ), resulting in a total landing of  $0.114053 \text{ t}\cdot\text{km}^{-2}\cdot\text{year}^{-1}$  for haddock in 1997.

### Saithe

A biomass of  $0.428 \text{ t}\cdot\text{km}^{-2}$  was estimated for saithe (*Pollachius virens*) based on a VPA for saithe ages 3-14 (Tables 3.3.5 and 3.3.2 in Marine Research Institute, 2000).

The P/B ratio ( $= 0.496 \text{ year}^{-1}$ ) was estimated using the same VPA (Tables 3.3.5 and 3.3.2 in Marine Research Institute, 2000) and by assuming a natural mortality rate of  $0.2 \text{ year}^{-1}$  (Tables 3.3.7 in Marine Research Institute, 2000).

The consumption/biomass (Q/B) ratio was estimated at  $2.327 \text{ year}^{-1}$  using an empirical formula (Christensen and Pauly, 1992) and a growth study of saithe in Iceland (Jones and Jónsson, 1971; compiled in FishBase, Froese and Pauly, 2001). Diet composition for saithe (Table 3) was taken from Pálsson (1983) and Gunnarson *et al.* (1998).

The total catches of saithe for 1997 (ICES STATLANT 1999 version; Valtýsson, 2001) comprised  $36,548 \text{ t}$  that were caught by the Icelandic fleets ( $9,971 \text{ t}$  by line & gill,  $1,700 \text{ t}$  by Danish seines,  $24,774 \text{ t}$  by bottom trawls,  $0.006 \text{ t}$  by midwater trawls,  $103 \text{ t}$  by lobster trawls and  $0.1 \text{ t}$  by shrimp trawls) and  $716 \text{ t}$  by the Faroe Islands (demersal) fleets. In total, this was  $0.098905 \text{ t}\cdot\text{km}^{-2}\cdot\text{year}^{-1}$  (Table 2).

Agnarsson (2000, cited in Valtýsson, 2001) reported that saithe has the lowest discard rate (0.2%) of all commercially fished finfish species caught by trawlers. Using this rate, discards for saithe were estimated as  $0.000132 \text{ t}\cdot\text{km}^{-2}\cdot\text{year}^{-1}$  for bottom trawls and  $0.000001 \text{ t}\cdot\text{km}^{-2}\cdot\text{year}^{-1}$  for lobster trawls. Therefore, by subtracting the discards from the catches, total saithe landing was  $0.098773 \text{ t}\cdot\text{km}^{-2}\cdot\text{year}^{-1}$  in 1997.

### Redfish

In this model, we only included two species/stocks of redfish, the golden redfish (*Sebastes marinus*) and the deep-sea redfish (*S. mentella*). Given biomasses observed elsewhere, the biomass of redfish was set at  $2.0 \text{ t}\cdot\text{km}^{-2}$ .

The Q/B ratio ( $= 2.00 \text{ year}^{-1}$ ) was taken from the Newfoundland-Labrador Shelf model (Bundy *et al.*, 2000), while the P/Q was assumed to be 0.2 as suggested by Christensen *et al.* (2000) for many fishes. Diet composition for redfish (Table 3) was taken from Pálsson (1983) and Gunnarson *et al.* (1998).

The total catches of redfish in 1997 (ICES STATLANT 1999 version; Valtýsson, 2001) was 73,976 t from Icelandic fleets and 242 t from Faroe Islands fleets (assumed to be 'foreign demersal' fleets), which equaled to  $0.196987 \text{ t}\cdot\text{km}^{-2}\cdot\text{year}^{-1}$  (Table 2). The Icelandic catches of redfish were taken only by midwater trawls. According to Agnarsson (2000, cited in Valtýsson, 2001), the highest discard rate was for redfish at 12.9% and it was primarily small redfish that were targeted for discards. Using this discard rate, redfish discards in the model was  $0.025328 \text{ t}\cdot\text{km}^{-2}\cdot\text{year}^{-1}$  for midwater trawls, resulting in a total redfish landing of  $0.171658 \text{ t}\cdot\text{km}^{-2}\cdot\text{year}^{-1}$ .

### Greenland halibut

As there has been no VPA for Greenland halibut (*Reinhardtius hippoglossoides*) in Iceland (Marine Research Institute, 2000), the biomass and P/B for this group were not estimated. In the absence of a biomass input, Ecotrophic Efficiency (EE) was set at 0.95 and P/Q was fixed at 0.2 (Christensen *et al.*, 2000). Diet composition for Greenland halibut (Table 3) was modified from Gunnarson *et al.* (1998).

The Q/B ratio was derived as an average of the Q/B of Greenland halibut  $> 40 \text{ cm}$  ( $1.478 \text{ year}^{-1}$ ) and Greenland halibut  $\leq 40 \text{ cm}$  ( $3.401 \text{ year}^{-1}$ ) in the Newfoundland-Labrador Shelf model (Bundy *et al.*, 2000), resulting in a Q/B of  $2.440 \text{ year}^{-1}$ .

The total catches of Greenland halibut in 1997 was 16,766 t from Icelandic fleets (1,678 t by line & gill, 15,087 t by bottom trawls, 0.003 t by lobster trawls and 1 t by shrimp trawls) and 26 t from Faroe Islands (demersal) fleets, which added up to a catch of  $0.044568 \text{ t}\cdot\text{km}^{-2}\cdot\text{year}^{-1}$  (Table 2). Greenland halibut discard rate by the Icelandic groundfish trawlers was estimated to be 2.2% (Agnarsson, 2000, cited in Valtýsson, 2001). Therefore, discards were applied at  $0.000881 \text{ t}\cdot\text{km}^{-2}\cdot\text{year}^{-1}$  for bottom trawls and  $0.000001 \text{ t}\cdot\text{km}^{-2}\cdot\text{year}^{-1}$  for shrimp trawls, resulting in a total landing of  $0.043688 \text{ t}\cdot\text{km}^{-2}\cdot\text{year}^{-1}$ .

### Other flatfish

Based on species composition of catches in the ICES STATLANT database, the remaining flatfish species were pooled into this category. These include: witch flounder (*Glyptocephalus cynoglossus*), American plaice or long rough dab (*Hippoglossoides platessoides*), Atlantic halibut (*Hippoglossus hippoglossus*), megrim (*Lepidorhombus whiffiagonis*), common dab (*Limanda limanda*), lemon sole (*Microstomus kitt*), and European plaice (*Pleuronectes platessus*).

In the absence of stock assessments for any of these species in Icelandic waters, EE was assumed to be 0.95 and P/Q was set at 0.2 (Christensen *et al.*, 2000), and the biomass and P/B value left for Ecopath to estimate.

Valtýsson (2001) indicated that American plaice is probably the most abundant flatfish in Iceland, with European plaice also being very common. The 1997 landings of 'Other Flatfish' in ICES STATLANT was also dominated ( $=10,557 \text{ t}$ ) by the landing of European plaice (*Pleuronectes platessa*). Therefore, the Q/B ratio ( $=2.649 \text{ year}^{-1}$ ) for this group is represented by a Q/B value averaged from the Q/B values for American plaice (*Hippoglossoides platessoides*,  $> 35 \text{ cm}$  ( $1.262 \text{ year}^{-1}$ ) and  $\leq 35 \text{ cm}$  ( $3.736 \text{ year}^{-1}$ ) in the Newfoundland-Labrador Shelf model, Bundy *et al.*, 2000) and European plaice (*Pleuronectes platessa* ( $2.8 \text{ year}^{-1}$ ) in the North Sea model, Christensen, 1995). Diet composition for this group (Table 3) was modified from Pálsson (1983) and Gunnarson *et al.* (1998).

The 1997 catches of this group (ICES STATLANT version 1999) was estimated as 27,505 t from the Icelandic fleets and 113 t from Faroe Islands (demersal) fleets. The Icelandic catch of this group was distributed (Valtýsson, 2001) into line & gill (1,317 t), Danish seines (21,470 t), bottom trawls (3,708 t), lobster trawls (1,010 t), shrimp trawls (0.3 t) and dredge & traps (0.2 t). This equals to a total Ecopath catch value of  $0.073303 \text{ t}\cdot\text{km}^{-2}\cdot\text{year}^{-1}$  (Table 2).

The discard rate for this group was assumed to be similar to that of plaice, estimated at 2.4% (Agnarsson, 2000; cited in Valtýsson, 2001). Consequently, discards were applied at  $0.000236 \text{ t}\cdot\text{km}^{-2}\cdot\text{year}^{-1}$  for bottom trawls and  $0.000064 \text{ t}\cdot\text{km}^{-2}\cdot\text{year}^{-1}$  for lobster trawls. Thus, the resulted total landing for this group became  $0.073002 \text{ t}\cdot\text{km}^{-2}\cdot\text{year}^{-1}$ .

## Other demersal fish

This functional group consists of several demersal fish species: Atlantic wolffish/catfish (*Anarhichas lupus*), spotted catfish (*Anarhichas minor*), argentines/silver smelts (*Argentina spp.*), tusk/cusk (*Brosme brosme*), roundnose grenadier (*Coryphaenoides rupestris*), lumpfish/lumpsucker (*Cyclopterus lumpus*), orange roughy (*Hoplostethus atlanticus*), angler/monk (*Lophius piscatorius*), roughhead grenadier (*Macrourus berglax*), whiting (*Merlangius merlangus*), blue ling (*Molva dypterygia*), ling (*Molva molva*), blue skate (*Raja batis*), shagreen ray (*Raja fullonica*), other skates (*Raja spp.*), Greenland shark (*Somniosus microcephalus*), and picked/spiny dogfish (*Squalus acanthias*).

In the absence of stock assessment analyses for these species in Iceland, biomass and P/B were not estimated. Therefore, EE was assumed to be 0.95 and P/Q was set at 0.15.

The consumption/biomass ratio was estimated as an average of the Q/B of skates (= 2.878 year<sup>-1</sup>) and large demersal feeders (= 1.747 year<sup>-1</sup>) in the Newfoundland-Labrador Shelf model (Bundy *et al.*, 2000), which resulted in a Q/B of 2.312 year<sup>-1</sup>. Diet composition (Table 3) was modified from Pálsson (1983) and Gunnarson *et al.* (1998).

ICES STATLANT database (1999 release) and Valtýsson (2001) indicated that the 1997 catches for this group were estimated to be 36,000 t from the Icelandic fleets (21,411 t by line & gill, 2,712 t by Danish seines, 11, 194 t by bottom trawls, 4 t by midwater trawls, 677 t by lobster trawls, and 2 t by shrimp trawls), 931 t by Faroe Islands (demersal) fleets and 209 t by the Portuguese (demersal) fleets. In total, these catches amounted to 0.098576 t·km<sup>-2</sup>·year<sup>-1</sup> (Table 2). No discards were assigned to this group.

## Herring

The herring (*Clupea harengus*) modelled in this group is the Icelandic Summer Spawning stock, as described in Valtýsson (2001). The biomass of this group (1.555 t·km<sup>-2</sup>) was estimated using the VPA of herring ages 2-15 (Tables 3.18.5 and 3.18.2 in Marine Research Institute, 2000). P/B was not estimated; instead, P/Q was set at 0.15.

The Q/B ratio (= 4.723 year<sup>-1</sup>) was estimated from the empirical relationship in Christensen and Pauly (1992) and the growth parameters of herrings in the Norwegian Sea (Beverton and Holt, 1959; compiled in FishBase, Froese and

Pauly, 2001). The diet composition for herring (Table 3) was taken from Jakobsson *et al.* (1993).

In 1997, herring was caught only by the Icelandic fleets, totaling 71,076 t (ICES STATLANT). These catches were distributed (Valtýsson, 2001) into line & gill (0.32 t), Danish seines (0.02 t), bottom trawls (0.43 t), herring seines (24,446 t), capelin seines (19,663 t), and capelin midwater trawls (26,966 t). These equal to 0.18865 t·km<sup>-2</sup>·year<sup>-1</sup> of catches (Table 2). No discards were allocated to herring.

## Capelin

The biomass of capelin (*Mallotus villosus*) was estimated from the single species VPA of immature and mature capelin (Tables 3.19.5 in Marine Research Institute, 2000), resulting in a biomass of 6.776 t·km<sup>-2</sup>.

Capelin's Q/B (= 6.633 year<sup>-1</sup>) was estimated using an empirical formula (Christensen and Pauly, 1992) and the growth study of capelin in the Labrador Sea (Templeman, 1948; in FishBase, Froese and Pauly, 2001).

As P/B was not estimated, but the gross food efficiency ratio or P/Q was set at 0.2 (Christensen *et al.*, 2000). The diet composition for capelin (Table 3) was taken from Villhjálmsson (1994).

Examination of catches of capelin revealed an error in the ICES STATLANT database (1999 release). This provided an erroneous catch for capelin for 1997, reporting 11,620,280 t of capelin being caught by the Icelandic fleets alone. In contrast, the FAO catch data in 1997 recorded 1,319,191 t of capelin for Iceland. The Icelandic national fisheries statistic database recorded 1,313,624 t of capelin catch in 1997 by the Icelandic fleets, which is very similar to the FAO data. Therefore, for this group we decided to use the catch data from the Icelandic fisheries statistic database. ICES was informed of the erroneous data entry.

The 1997 total catch of capelin from the study area was 1,409,977 t. These catches were caught by the Icelandic fleets (1,313,624 t), Faroe Islands pelagic fleets (35,308 t) and Norwegian pelagic fleets (61,045 t). The catches that were caught by the Icelandic fleets were distributed (Valtýsson, 2001) into herring seines (12,839 t), capelin seines (1,269,041 t) and capelin midwater trawls (31,744 t). Overall, this resulted in a total Ecopath input catch of 3.7423 t·km<sup>-2</sup>·year<sup>-1</sup> (Table 2). No discards were allocated to capelin.

## Other pelagics

Similar to 'other demersal fish', this group was also comprised of several species, such as black scabbardfish (*Aphanopus carbo*), porbeagle (*Lamna nasus*), blue whiting/poutassou (*Micromesistius poutassou*), Atlantic mackerel (*Scomber scombrus*), sandeel (*Ammodytes* sp.) and northern bluefin tuna (*Thunnus thynnus*).

The biomass and the Q/B ratio were not estimated, but rather, EE was set at 0.95 and a value of 0.15 was entered for P/Q (Christensen *et al.*, 2000). P/B (= 0.29 year<sup>-1</sup>) and diet composition for this group (Table 3) were adopted from the North Sea model (Christensen, 1995).

The ICES STATLANT database (1999 release) recorded a catch of 10,512 t for this group in 1997, which was distributed into 10,431 t caught by the Icelandic fleets (3 t by line & gill, 0.45 t by Danish seines, 2 t by bottom trawls, and 10,426 t by capelin midwater trawls) and 81 t caught by Faroe Islands pelagic fleets. These equal to 0.0279 t·km<sup>-2</sup>·year<sup>-1</sup> (Table 2). No discards were allocated to this group.

## Norway lobster (*Nephrops norvegicus*)

The biomass of Norway lobsters (*Nephrops norvegicus*) was estimated from the VPA of *Nephrops* ages 3-16 (Tables 3.22.4 and 3.22.6 in Marine Research Institute, 2000), resulting in a biomass of 0.037 t·km<sup>-2</sup>.

The P/B ratio was calculated using the VPA data (Tables 3.22.5 and 3.22.6 in Marine Research Institute 2000). Assuming a natural mortality of 0.2 year<sup>-1</sup>, P/B was estimated to be 0.31 year<sup>-1</sup>.

The Q/B ratio was not estimated. Therefore, P/Q was assumed to be 0.2 (Christensen *et al.*, 2000). The diet composition for this group (Table 3) originates from Unnur Skuladottir (pers. comm., 1998).

In 1997, there were 1,215 t of *Nephrops* caught from the study area by the Icelandic fleets (ICES STATLANT, 1999 release). The distribution of catches (Valtýsson, 2001) was 1,1215 t by lobster trawls and 0.31 t by bottom trawls, resulting in an Ecopath catches of 0.003225 t·km<sup>-2</sup>·year<sup>-1</sup> (Table 2). Foreign catches and discards were non existent in 1997 for Norway lobsters (ICES STATLANT, version 1999; Valtýsson, 2001).

## Northern shrimps

In the absence of biomass and Q/B data for northern shrimps (*Pandalus borealis*) in the study area, EE was assumed to be 0.95 and P/Q was set at 0.2 (Christensen *et al.*, 2000).

The production/biomass ratio was taken from the total mortality estimate for northern shrimp in northern Norway (1.83 year<sup>-1</sup>, Hopkins and Nilssen, 1990). The diet composition for northern shrimps (Table 3) originates from Unnur Skuladottir (pers. comm., 1998).

In 1997, northern shrimps were only caught by the Icelandic shrimp trawls, with catches of 72,060 t (ICES STATLANT, version 1999) or 0.191259 t·km<sup>-2</sup>·year<sup>-1</sup> (Table 2). Discards of northern shrimps were not recorded.

## Molluscs

This group is comprised of whelks (*Buccinum undatum*), Icelandic scallops (*Chlamys islandica*), European flying squid (*Todarodes sagittatus*), and other molluscs.

In the absence of biomass and P/B data, EE was assumed to be 0.75 and P/Q was set at 0.15. The Q/B ratio was adopted from the Q/B of molluscs (= 6.33 year<sup>-1</sup>) in the Newfoundland-Labrador Shelf model (Bundy *et al.* 2000). The diet composition for this group (Table 3) was modified from Gunnarson *et al.* (1998) and Unnur Skuladottir (pers. comm., 1998).

The total catch of molluscs in 1997 (ICES STATLANT, version 1999) from the study area was 15,958 t or 0.04236 t·km<sup>-2</sup>·year<sup>-1</sup> (Table 2). These were mainly caught by dredge and traps (15,953 t), and about 5 t were caught by bottom trawls and 0.03 t by Danish seines (Valtýsson, 2001). No discards were recorded.

## Benthos

This group is mainly comprised of sea urchins (Echinoidea) and marine crustaceans. The biomass and Q/B were not estimated, but rather, EE was assumed to be 0.5 since this group is not heavily fished (Christensen *et al.*, 2000). The P/Q ratio was assumed to be 0.09, based on the gross food conversion efficiency of sea urchins (Brey, 1995).

The P/B ratio (= 0.6 year<sup>-1</sup>) was adopted from the P/B of echinoderms in the Newfoundland-Labrador Shelf model (Bundy *et al.*, 2000), while the diet information (Table 3) was modified from



Gunnarson *et al.* (1998) and Unnur Skuladottir (pers. comm., 1998).

The 1997 catches of benthos from the study area were recorded as 20 t by the Icelandic fleets (dredge and traps) and 1 t by the Portuguese demersal fleet (ICES STATLANT, version 1999; Valtýsson, 2001), totaling to 0.000056 t·km<sup>-2</sup>·year<sup>-1</sup> (Table 2). No discards were recorded.

### Other fish

We defined this group as fish that are not commercially important and are generally of small size. This includes both pelagic and demersal species (H. Valtýsson, pers. comm.).

The biomass and P/B were not estimated, the EE was assumed to be 0.95 and the P/Q was set to 0.2 (Christensen *et al.*, 2000). A Q/B ratio (= 3.5 year<sup>-1</sup>) was assumed corresponding to the Q/B of other prey fish in the North Sea model (Christensen, 1995). The diet composition was constructed based on the general ecology of small fishes. No landings or discards were recorded for this group.

### Krill

Parameter estimates for Krill at Iceland were not available, instead generic values were used (V. Christensen, pers. comm.).

### Zooplankton

The biomass was not estimated and EE was set at 0.95. The P/B ratio (= 5.915 year<sup>-1</sup>) as well as the Q/B ratio (= 20.085 year<sup>-1</sup>) for this group was estimated from the averages of the respective ratios of large zooplankton (P/B = 3.43 year<sup>-1</sup>, Q/B = 19.5 year<sup>-1</sup>) and small zooplankton (P/B = 8.4 year<sup>-1</sup>, Q/B = 20.67 year<sup>-1</sup>) in the Newfoundland-Labrador Shelf model (Bundy *et al.*, 2000). Following suggestion by Christensen *et al.* (2000), the unassimilated food/consumption ratio was readjusted to 0.4. The diet composition (Table 3) was based on general knowledge about the biology of zooplankton.

### Benthic producers

This group is mainly comprised of brown seaweeds (kelp, Phaeophyceae). The biomass (= 3,685 t·km<sup>-2</sup>) and P/B ratio (= 4.43 year<sup>-1</sup>) was adopted from data on *Laminaria* spp. in the northwest Atlantic (Brady-Campbell *et al.*, 1984). Harvests (or landings) of this group in 1997 were

recorded as 195,050 t (0.517695 t·km<sup>-2</sup>·year<sup>-1</sup>) by the dredges and traps of the Icelandic fleets (ICES STATLANT, version 1999; Valtýsson, 2001). No discards were recorded.

### Phytoplankton

Phytoplankton biomass data was not available. The P/B ratio was adopted from the P/B of phytoplankton (= 200 year<sup>-1</sup>) in the Strait of Georgia, north-east Pacific (Mackinson, 1996). The EE was assumed to be 0.4, reflecting the assumption that the bulk of the primary production is not utilized directly in the system, but cycled to the detritus (Christensen *et al.*, 2000).

### Detritus

Detritus, which comprised of both dissolved and particulate organic matters, was guesstimated to have a biomass of 200 t·km<sup>-2</sup>.

## RESULTS AND DISCUSSION

The Icelandic marine ecosystem in 1997 spans over approximately four trophic levels, with the toothed whales and the Greenland halibut as top predators, i.e., occupying the highest trophic level (Table 1).

The updated, balanced Ecopath model shows that, in 1997, the fisheries targeted intermediate trophic levels; the mean trophic level of the catch was 2.85 (Table 2).

All parameters entered have been pedigreed, resulting in a pedigree index of 0.2952 and a measure of fit (t\*) of 1.42. However, these values cannot yet be compared with those of other models, as their computation is a novel feature of Ecopath/Ecosim.

The present Ecopath model of the Icelandic marine ecosystem represents a summary of our current knowledge of the biomass, consumption, production, food web structure and trophic flows in the ecosystem exploited by fourteen fishing fleets in ICES area Va.

The main uncertainties in our model lie in the diet composition information, potentially resulting in inappropriate trophic level estimates. Moreover, the annual averages used in Ecopath ignore competitive interactions in feeding and the fact that the prevalence of diet items may change on a seasonal basis. More information on

the invertebrate groups and the seabirds are also needed for future refinement of the model. Enhancement of the present model could include application of environmental and ecological variations, non-trophic relations, and spatial consideration.

One issue that needs to be addressed in the future revision of the model is the sandeel (*Ammodytes* sp.). At this moment, sandeels are included in the 'other pelagics' group. Although sandeels have not been harvested in significant amount, they play a vital ecological role in the ecosystem (H. Valtýsson, pers. comm.). Therefore, sandeels merit their own functional group.

Of great concern are the recently detected uncertainties in stock assessment results for cod, one of the major commercial species (H. Valtýsson, pers. comm.). If these uncertainties in assessment are borne out, then many, if not all, biomass estimates used here for commercial species will be overestimates.

#### ACKNOWLEDGEMENTS

A.Mendy wishes to thank Drs. Gunnar Stefansson, Tumi Tomásson, Villy Christensen, Alida Bundy, and these staff members of the Marine Research Institute of Iceland who assisted the first author in data collation and the construction of a first version of the Ecopath model presented here. Special thanks are also due to the Government of Gambia and Dr. Heimo Mikkola for making his sojourn in Iceland possible, through the United Nations University Fisheries Training Program, during which the original Icelandic model was compiled. E. Buchary wishes to thank Hreidar Valtýsson, Dr. Dirk Zeller and Dr. Reg Watson for invaluable assistance, and the Pew Charitable Trust for their funding of the *Sea Around Us* project.

#### REFERENCES

- Agnarsson, S. 2000. Stjórnun fiskveiða á Íslandi (Fisheries management in Iceland). In: Auðlindanefnd - Álitserð (The Natural Resource committee - Report). Ed. by Jóhannes Nordal. A report for the Icelandic parliament. In Icelandic. Reykjavík, Iceland.
- Anon. 1997. Icelandic groundfish survey 1996, Survey Report. Fjölrit Hafrannsóknastofnunar 52: 46p.
- Beverton, R.J.H. and S.J. Holt, 1959. A review of the lifespans and mortality rates of fish in nature and their relation to growth and other physiological characteristics. p. 142-180. In: G.E.W. Wolstenholme and M. O'Connor (eds.) CIBA Foundation colloquia on ageing: the lifespan of animals. volume 5. J & A Churchill Ltd, London.
- Blacker, R. 1971. Synopsis of biological data in haddock *Melanogrammus aeglefinus* (Linnaeus) 1758. FAO Spec. Synop. (84).
- Brady-Campbell, M.M., D.B. Campbell and M.M. Harlin. 1984. Productivity of kelp (*Laminaria* spp.) near the southern limit in the northwestern Atlantic Ocean. Mar. Ecol. Prog. Ser. 18: 79-88.
- Brey, T. 1995. Empirische Untersuchungen zur Populationdynamik makrobenthischer Evertebraten. Habilitationsschrift, Universität Bremen, 170 p.
- Buchary, E.A. 2001. Preliminary reconstruction of the Icelandic marine ecosystem in 1950. pp 198-205. In: Fisheries Impacts on North Atlantic Ecosystems: Models and Analyses. Ed. by S. Guénette, V. Christensen, and D. Pauly. Fisheries Centre Research Report 9(4).
- Bundy, A., G.R. Lilly, P. Shelton. 2000. A mass balance model of the Newfoundland-Labrador Shelf. Canadian Technical Report of Fisheries and Aquatic Sciences No. 2310.
- Christensen, V. 1995. A model of trophic interactions in the North Sea in 1981, the Year of the Stomach. Dana 11(1): 1-28.
- Christensen, V. and D. Pauly. 1992. A guide to the Ecopath II software system (version 2.1). ICLARM Software 6, 72 p.
- Christensen, V. and D. Pauly. 1993. Flow characteristics of aquatic ecosystems, p. 338-352. In: V. Christensen and D. Pauly (eds.). Trophic models of aquatic ecosystems. ICLARM Conf. Proc. 26, 390 p.
- Christensen, V., C.J. Walters, and D. Pauly. 2000. Ecopath with Ecosim: A User's Guide. Univ. of British Columbia, Fisheries Centre, Vancouver, Canada and ICLARM, Penang, Malaysia. 125 p.
- Froese, R. and D. Pauly (eds). 2001. FishBase. World Wide Web electronic publication. [www.fishbase.org](http://www.fishbase.org), 18 June 2001.
- Gunnarsson, K., Jónsson, G. and Pálsson, Ó.K. 1998. Sjávarnytjar við Ísland (Marine resources of Iceland). Mál og menning, Reykjavík, Iceland. (In Icelandic)
- Hopkins, C.C.E, and E.M., Nilssen. 1990. Population biology of the deep-water prawn (*Pandalus borealis*) in Balsfjord, northern Norway: I. abundance, mortality and growth, 1979-1983. J. Cons. int. Explor. Mer. 47:148-166.
- Jakobsson, J., Guðmundsdóttir, A. and Stenfánsson 1993. Stock related changes in biological parameters of the Icelandic summer spawning herring. C.M. 1993/H:47.
- Jones, B.W., and J. Jónsson. 1971. Coalfish tagging experiments at Iceland. Rit. Fiskideildar 5(1): 27 p.
- Jónsson, J. 1957. Icelandic cod investigation in Southwest and Southeast Greenland waters 1957. Cons. Int. Explor. Mer. Ann. Biol. 14: 115-118.
- Jónsson, J. 1965. Temperature and growth of cod in Icelandic waters. ICNAF Spec. Publ. 6: 537-539.

- Kaschner, K., Watson, R., Christensen, V., Trites, A. W., and Pauly, D., 2001. Modeling and Mapping Trophic Overlap between Marine Mammals and Commercial Fisheries in the North Atlantic. pp 35-45. In: Fisheries Impacts on North Atlantic Ecosystems: Catch, Effort, and National/Regional Data Sets. Ed. by D. Zeller, R. Watson, and D. Pauly, Fisheries Centre Research Report 9(3).
- Lilliendahl, K. and J. Solmundsson. 1997. An estimate of summer food consumption of six seabird species in Iceland. ICES J. Mar. Sci. 54 (4): 624-630.
- Longhurst, A.R. 1995. Seasonal cycle of pelagic production and consumption. Progress in Oceanography 36, 77-167.
- Longhurst, A.R. 1998. Ecological Geography of the Sea. Academic Press, San Diego. 398 pp.
- Mackinson, S. 1996. Strait of Georgia Model: system definition and primary production. pp 63-64. In: Mass-balance models of north-eastern Pacific ecosystems. Ed. by D. Pauly and V. Christensen. Fisheries Centre Research Report 4 (1).
- Marine Research Institute (MRI). 2000. Nytjastofnar sjávar 1999/2000. Aflahorfur fiskveiðiárid 2000/2001 (State of Marine Stocks in Icelandic Waters 1999/2000. Prospects for the Quota Year 2000/2001). Fjölrit Hafrannsóknastofnun No. 75. Icelandic with English summary, available at [www.hafro.is/hafro/Radgjof/2000/summary.html](http://www.hafro.is/hafro/Radgjof/2000/summary.html).
- Mendy, A. N. (unpublished data). Trophic modeling as a tool to evaluate and manage Iceland's multispecies fisheries. 26 p. Unpublished report.
- Pauly, D., A.W. Trites, E. Capuli, V. Christensen. 1998. Diet composition and trophic levels of marine mammals. ICES J. Mar. Sci. 55: 467-481.
- Reilly, S.B. and J. Barlow. 1986. Rates of increase in Dolphin population size. Fishery Bulletin 84(3): 527-533.
- Saemundsson, B. 1923. On the age and growth of the cod (*Gadus callarias* L.) in Iceland waters. Medd. Fisk. Havundersog., Ser. Fisk. 7(3): 1-35.
- Schopka, S.A. and G. Hempel. 1973. The spawning potential of populations of herring *Clupea harengus* L. and cod *Gadus morhua* L. in relation to the rate of exploitation. Rapp. P.-v. Réun. Counc. Int. Explor. Mer 164: 178-175.
- Small, R.J. and D. DeMaster. 1995. Alaska marine mammal stock assessments 1995. US Dept. Commer., NOAA Tech. Memo. NMFS-AFSC-57. 93 p.
- Templeman, W., 1948. The life history of the capelin (*Mallotus villosus* Müller) in Newfoundland waters. Bull. Nfdl. Gov. Lab. (17):1-151.
- Thorisson, K. 1991. The food and growth of larval and juvenile cod (*Gadus morhua*) in coastal waters west of Iceland. Cand. scient. thesis in fisheries biology. University of Bergen, Norway. 63p.
- Trites, A. and K. Heise. 1996. Marine Mammals. pp 25-30. In: Mass-balance models of north-eastern Pacific ecosystems. Ed. by D. Pauly and V. Christensen. Fisheries Centre Research Reports 4(1).
- Trites, A. and D. Pauly. 1998. Estimates of mean body weights for marine mammals from measurements of maximum body lengths. Can. J. Zool. 76(5): 886-896.
- Trites, A., V. Christensen and D. Pauly. 1997. Competition between fisheries and marine mammals for prey and primary production in the Pacific Oceans. J. Northw. Atl. Fish. Sci. 22: 173-187.
- Valtýsson, H. T. 2001. The sea around Icelanders: catch history and discards in Icelandic waters. pp 52-87. In: Fisheries Impacts on North Atlantic Ecosystems: Catch, Effort, and National/Regional Data Sets. Ed. by D. Zeller, R. Watson, and D. Pauly. Fisheries Centre Research Reports 9(3).
- Vilhjalmsson, H. 1994. The Icelandic Capelin Stock. Journal of the Marine Research Institute, Vol. XIII, No. 1.
- Walters, C.J., V. Christensen and D. Pauly. 1997. Structuring dynamic models of exploited ecosystems from trophic mass-balance assessments. Rev. Fish Biol. Fish. 7: 139-172.

## PRELIMINARY RECONSTRUCTION OF THE ICELANDIC MARINE ECOSYSTEM IN 1950 AND SOME PREDICTIONS WITH TIME SERIES DATA

***Eny Anggraini Buchary***

*Fisheries Centre, University of British Columbia,  
2204 Main Mall, Vancouver, B.C., V6T 1Z4, Canada  
email: e.buchary@fisheries.ubc.ca*

### ABSTRACT

This contribution documents a first attempt to construct an ecosystem model for the marine ecosystem of Iceland in 1950 based on a present-day (i.e., 1997) model of the same area, and adopting the same structure and species composition. The catch data were adapted from the *Sea Around Us* project catch database, with discarding and unreported catch explicitly accounted for. Comparison of model prediction with reference time series data for two important species in the fisheries was also carried out, and indicated good correspondence between model predictions and times series data.

### INTRODUCTION

The *Sea Around Us* project (SAUP) seeks to describe state(s) of North Atlantic marine ecosystems - with their embedded fisheries - prior to the expansion of large-scale commercial fisheries (Pauly and Pitcher, 2000). This is done through construction of models of past ecosystems from a time series of scientific data using the EwE software and approach (Christensen and Walters, 2000). Along with the present-day ecosystem models, which are also constructed using the same approach, these past ecosystem models will provide reference points and will help characterize the status of the North Atlantic ecosystems in order to quantify the large-scale impacts of fisheries through time and space.

For the ecosystem-based modelling purposes, 1950 was selected as a representation of the time period before major impacts of industrialized fisheries started in the North Atlantic. This is also the starting year of the fishery catch database series of the SAUP (Watson *et al.*, 2000). Along with the construction and reconstruction of other marine ecosystems models in the North Atlantic, as geographically defined by Pauly *et al.* (2000), a reconstruction of the past ecosystem model for

Icelandic marine ecosystem was therefore carried out.

The reconstruction of past marine ecosystem models often requires combination of information from scientific studies, local knowledge, historical archives, the oral history of fishing communities, assessment of social and cultural values, and published and unpublished literature (Pitcher, 2001a). However, careful historical analysis of old documents for the Icelandic case study was not possible within the first two years of the SAUP.

Therefore, as a first step, a preliminary effort to reconstruct the 1950 model for the Icelandic marine ecosystem was attempted based on the 1997 model of the same area (Mendy and Buchary, this volume). Using 'reference' time series data of fishing mortality from R.A. Myers' stock recruitment database as forcing function (<http://fish.dal.ca/~myers/data.html>, see Christensen *et al.*, 2000), model prediction for two important group of species were also compared with the trend of observed biomass data of the same group of species estimated by single species stock assessment using virtual population analysis (VPA), as collated in R.A. Myers' stock recruitment database.

### Defining the system and the model

The 1950 model structure, designed following the 1997 model (see Mendy and Buchary, this volume), includes 24 functional groups, comprised of two primary producer groups, five invertebrate groups, twelve fish groups (including one juvenile group for cod), one seabirds group, three marine mammals groups and one detritus group. Species composition of these groups are also identical to those in the 1997 model. The ICES fishing area Va was selected as the model area (Figure 1), covering 376,766 km<sup>2</sup> (R. Watson, pers. comm.) and overlapping with the Longhurst areas ARCT (Atlantic Arctic) and SARC (Atlantic Subarctic) as defined by Longhurst (1995, 1998).

Valtýsson (2001) provided a detailed account of the history of fisheries development, and reconstruction of catch and effort in Icelandic fisheries. His account covers data and information primarily from 1950 onward, with some patchy information as far back as to 1883. These data have been incorporated into the *Sea Around Us* project catch database (Watson *et al.*, 2000), which also accounts for much discarding and unreported catches, and from which all catch data used for this 1950 model were obtained.

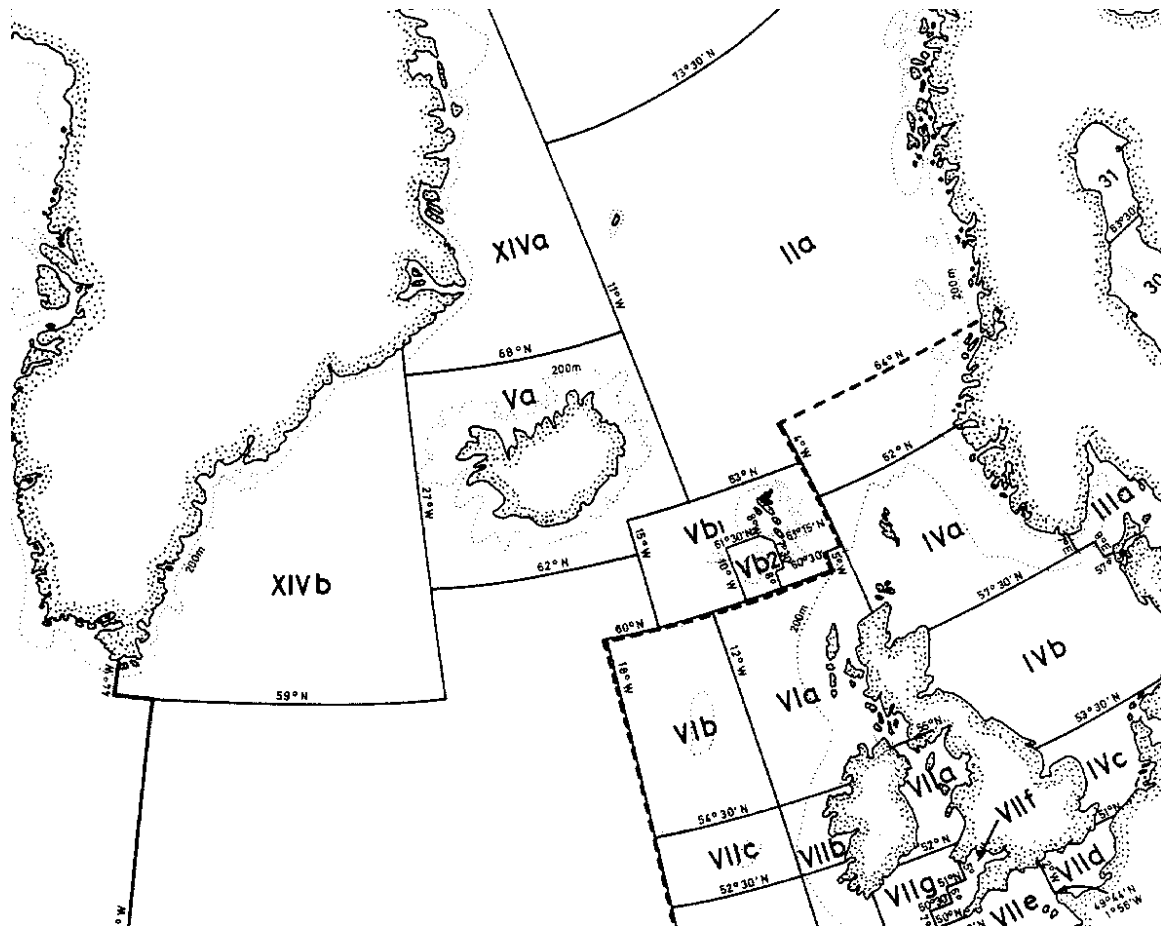

**Figure 1:** ICES Fisheries Statistical Areas, illustrating ICES area Va ( $11^{\circ}$  -  $27^{\circ}$  W and  $62^{\circ}$  -  $68^{\circ}$  N), which was used as the model area ( $376,766 \text{ km}^2$ ).

Based on Valtýsson (2001), eight fishing fleet categories (including foreign fishing) existed in 1950. Furthermore, there were more foreign fleets fishing in Icelandic waters than in the present, including Belgium, Denmark, Finland, Sweden, France, the Federal Republic of Germany, Netherlands, Norway, and the United Kingdom. To enable comparison with the 1997 model, foreign fleets were aggregated as in the 1997 model, i.e., foreign pelagic and foreign demersal. The fishing fleet categories actually used in 1950 were: foreign pelagic; foreign demersal; line and gillnet; bottom trawls; herring seines; dredge and traps; seal guns and harpoons.

Six fishing fleet categories used in 1997 (but not in 1950) were included as dummy fleets in the 1950 model. This will make direct comparison with the 1997 model possible, and permit evaluation of alternative ecosystem-based management regimes (Pauly and Pitcher, 2000). These six dummy fishing fleet categories were: Danish seine; midwater trawl; lobster trawl;

capelin seine; capelin midwater trawl and shrimp trawl.

Technically, Ecopath does not allow any fleet with no catch. Therefore, the catches of these six dummy fleets in 1950 were assumed to be  $1/100,000^{\text{th}}$  of 1997 catches, which make their catch insignificant to the overall balance of the model.

Stock assessments (e.g., virtual population analysis) were not available as source of input parameters (Table 1). Biomasses for the groups were estimated by Ecopath, except for the biomass of benthic producers and detritus which were taken from the 1997 model. The production/biomass (P/B) ratios of most commercial fish groups were not entered, allowing Ecopath to estimate them. However, P/B for marine mammals, aggregated fish groups (e.g., 'other pelagics') and invertebrates were entered based on the 1997 model. The consumption/biomass (Q/B) ratios for marine mammals, commercial fish groups and a few

invertebrate groups were taken from the 1997 model, assuming that magnitude of consumption for these species did not change over a period of four decades. Likewise, diet compositions were assumed to have been the same as in the 1997 model. To enable biomass estimation by Ecopath, the ecotrophic efficiency (EE) for all groups were

fixed at 0.95, while production/consumption (P/Q) ratios were fixed at appropriate values (Christensen *et al.*, 2000). Following suggestion by Christensen *et al.* (2000), the unassimilated food/consumption ratio for zooplankton was readjusted to 0.4. All parameters entered were also pedigreed (see Christensen *et al.*, 2000).

**Table 1:** Input parameters (and their assumptions as outlined in the note below the table) and basic estimates of the Ecopath model of Icelandic marine ecosystem in 1950. Values in brackets were estimated by the program.

No.	Group name	Trophic level	Biomass (t·km <sup>-2</sup> )	P/B (year <sup>-1</sup> )	Q/B <sup>e</sup> (year <sup>-1</sup> )	EE <sup>f</sup>	P/Q <sup>g</sup>
1	Toothed whales	(4.1)	(0.276)	0.006 <sup>b</sup>	1.902	0.950	(0.003)
2	Baleen whales	(3.2)	(2.694)	0.018 <sup>b</sup>	4.275	0.950	(0.004)
3	Pinnipeds	(3.9)	(0.174)	0.040 <sup>b</sup>	11.396	0.950	(0.004)
4	Seabirds	(3.4)	(0.037)	0.250 <sup>c</sup>	54.750	0.950	(0.005)
5	Adult cod	(3.6)	(2.514)	(0.491)	2.454	0.950	0.200
6	Juvenile cod	(3.1)	(0.221)	(1.827)	6.090	0.950	0.300
7	Haddock	(3.1)	(0.668)	(0.589)	2.947	0.950	0.200
8	Saithe	(3.6)	(0.877)	(0.465)	2.327	0.950	0.200
9	Redfish	(3.1)	(3.079)	(0.400)	2.000	0.950	0.200
10	Greenland halibut	(4.1)	(0.677)	(0.488)	2.440	0.950	0.200
11	Other flatfish	(3.4)	(0.869)	(0.530)	2.649	0.950	0.200
12	Other dem. fish	(3.2)	(2.065)	(0.347)	2.313	0.950	0.150
13	Herring	(2.9)	(1.130)	(0.945)	4.723	0.950	0.200
14	Capelin	(2.9)	(4.117)	(1.327)	6.633	0.950	0.200
15	Other pelagics	(3.0)	(15.808)	0.290 <sup>c</sup>	(1.933)	0.950	0.150
16	<i>Nephrops</i>	(2.8)	(0.435)	0.200 <sup>d</sup>	(1.000)	0.950	0.200
17	Northern shrimp	(2.9)	(1.003)	1.830 <sup>c</sup>	(9.150)	0.950	0.200
18	Mollusks	(3.0)	(1.167)	(0.950)	6.330	0.750	0.150
19	Benthos	(2.0)	(64.688)	0.600 <sup>c</sup>	(6.667)	0.500	0.090
20	Other fish	(3.1)	(7.809)	(0.700)	3.500	0.950	0.200
21	Zooplankton	(2.0)	(18.121)	5.915 <sup>c</sup>	20.085	0.500	(0.294)
22	Benthic producers	(1.0)	3,685 <sup>a</sup>	4.430 <sup>c</sup>	-	(0.008)	-
23	Phytoplankton	(1.0)	(4.598)	200	-	0.400	-
24	Detritus	(1.0)	200 <sup>a</sup>	-	-	-	-

<sup>a</sup>Both benthic producers and detritus were assumed not to have changed in biomass between 1950 and 1997. Thus, biomass input for these two groups were taken from the 1997 model.

<sup>b</sup>In his electronic database and his report, Valtýsson (2001) indicated that whaling and sealing were more common in 1950 than in the 1990s. Therefore, P/B for all marine mammals groups in 1950 were assumed to be twice as high as in 1997. In the 1997 model, P/Bs for toothed whales, baleen whales and pinnipeds are 0.003 year<sup>-1</sup>, 0.009 year<sup>-1</sup> and 0.023 year<sup>-1</sup>, respectively.

<sup>c</sup>The P/B ratio for these groups were assumed to be the same as those in the 1997 model.

<sup>d</sup>Landing of *Nephrops* in 1950 was 1/75<sup>th</sup> of that in 1997. Therefore, for the 1950 model, the P/B of *Nephrops* was reduced to its M, which is 0.2 year<sup>-1</sup> (see Table 3.22.6 in Marine Research Institute, 2000). P/B for *Nephrops* in the 1997 model is 0.3095 year<sup>-1</sup>.

<sup>e</sup>Assuming that magnitude of consumption for these species did not change over a period of four decades, the Q/B ratios were taken from the 1997 model.

<sup>f</sup>Following suggestion by Christensen *et al.* (2000), EE were fixed at 0.95 for many groups. The EE for mollusks, benthos and phytoplankton were fixed at 0.75, 0.5, and 0.4, respectively.

<sup>g</sup>The P/Q ratio were fixed at values of 0.15 through 0.3 (Christensen *et al.*, 2000); except for benthos which was fixed at 0.09 (Brey, 1995).

**RESULTS**

**Basic Estimates**

Trophic level estimates (Table 1) were the same as those in the 1997 model (Mendy and Buchary, this volume), as the same diet composition information (see Table 3 in Mendy and Buchary, this volume) were used in the 1950 model.

The results suggest that in 1950 the fisheries targeted organisms at much higher trophic levels, with the mean trophic level of the catch at 3.36 (Table 2), compared to 2.85 in 1997 (Mendy and Buchary, this volume); this is in line with

observations (H. Valtýsson, pers. comm.). In 1950 (Table 2), the total catch was 1.975 t·km<sup>-2</sup>·year<sup>-1</sup>, comprising of 1.932 t·km<sup>-2</sup>·year<sup>-1</sup> of landing and 0.044 t·km<sup>-2</sup>·year<sup>-1</sup> of discards. By 1997, the total catches increased three-fold (see Table 2 in Mendy and Buchary, this volume).

The biomass estimates in the 1950 model (calculated by Ecopath), were generally higher (Figure 2), than those in the 1997 model, which were mainly estimated by single species VPA (Marine Research Institute, 2000). This comparison (Figure 2) also suggest that the highest biomass depletion was experienced by the baleen whales.

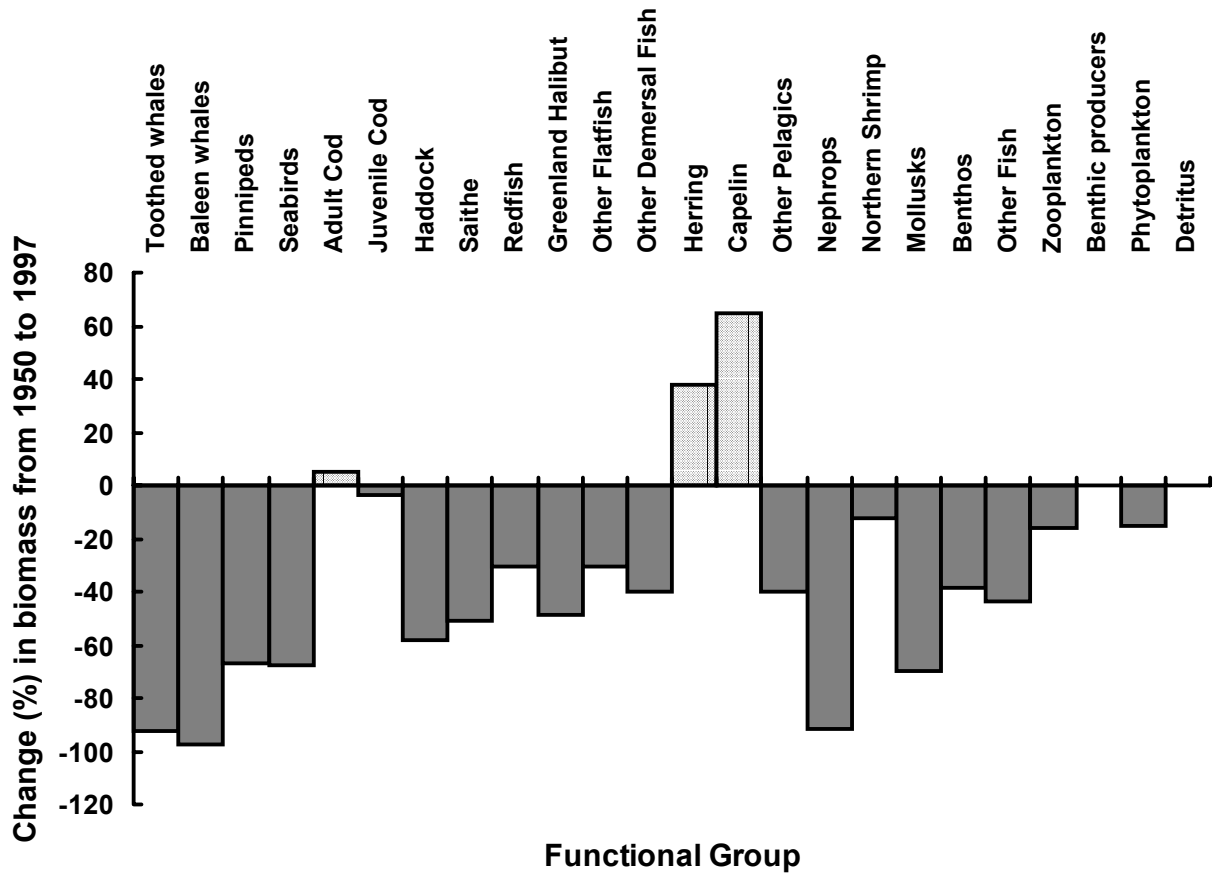

**Figure 2:** Percentage change in biomass of all functional groups in the Icelandic marine ecosystem model from 1950 (estimated by Ecopath and documented in this paper) to 1997 (Mendy and Buchary, this volume). Biomass estimates for the 1997 model, except for the marine mammals, were mainly sourced from single species stock assessment using virtual population analysis (Marine Research Institute, 2000). Biomass of marine mammals in the 1997 model were derived from the Marine Mammals Database of the *Sea Around Us* project (Kaschner *et. al.*, 2001).

**Table 2:** Catch data (t·km<sup>-2</sup>·year<sup>-1</sup>) for the model of Icelandic marine ecosystem in 1950 and the estimated mean trophic level of the catch for each fishing sector. Catches with very low values are represented by '0' in the matrix.

Group	Catch (t·km <sup>-2</sup> ·year <sup>-1</sup> )														Total
	Foreign pelagic	Foreign demersal	Line & gillnet	Danish seine	Bottom trawl	MW trawl	Lobster trawl	Herring seine	Capelin seine	Capelin MWT	Shrimp trawl	Dredge & traps	Seal guns	Harpoon	
Toothed whales														0.0008	0
Baleen whales														0.0417	0.04
Pinnipeds													0.001		0
Adult cod		0.33739	0.30507	0	0.23205		0				0				0.87
Haddock		0.09582	0.05967	0	0.01837		0								0.17
Saithe		0.12429	0.01933	0	0.02811		0								0.17
Redfish		0.1407			0.19348	0.00003									0.33
Greenland halibut		0.0001									0				0
Other flatfish		0.03654	0.00824	0	0.00903		0								0.05
Other dem. fish		0.06335	0.02462	0	0.00686	0	0								0.09
Herring	0.03748		0.07985		0.00266			0.07985	0	0					0.2
Capelin									0.00003	0					0
Other pelagics	0.00067		0.00071							0		0.00053			0
Nephrops		0.00004					0								0
Northern shrimp											0				0
Benthic producers												0.02654			0.03
Total catch	0.03815	0.79823	0.49749	0	0.49057	0.00003	0	0.07985	0.00003	0	0	0.02707	0.001	0.0425	1.97489
Mean trophic level	2.9	3.44	3.44	3.45	3.4	3.11	3.33	2.9	2.9	2.92	2.85	1.04	3.93	3.22	3.36

Note: MW = mid-water; MWT = mid-water trawls



However, the comparison also suggests that the cod biomass in 1997 was 5% higher than that in 1950 (Figure 2). This requires closer attention, as uncertainties have recently been detected in stock assessment results for cod, one of the major commercial species (H. Valtýsson, pers. comm. June 2001; see also Pitcher, 2001b). Recent assessment by the Marine Research Institute as documented in their *State of Marine Stocks in Icelandic Waters Report for 2000/2001* (Marine Research Institute, 2001) confirmed an overestimation of cod stock size over the past few years. This report indicates the potential for social and economic crisis in Icelandic fisheries, similar to those experienced on the east coast of Canada in the early 1990s.

Valtýsson (2001) reported that there are three herring stocks in Icelandic waters: the Icelandic spring spawning stock, the Icelandic summer spawning stock and the Norwegian spring spawning stock. All three stocks collapsed in the late 1960s. The Icelandic spring spawning stock has not recovered, but the other two have (Valtýsson, 2001). The summer spawning stock recovered in the 1990s (Jakobson 1983). Since the collapse, the Icelandic fishery exclusively exploit the Icelandic summer spawning stock (Valtýsson, 2001), which is the stock modeled in both the 1950 and 1997 models.

### **Fitting model prediction with time series data**

To gain insights on how the 1950 model behaves when forced with time series data and how it compares with observed data, some temporal simulations were run and model prediction were contrasted with reference time series data. The 1950 model was used as the basis of the temporal (Ecosim) simulation (1950 - 1997) using the time series data of Icelandic summer spawning herring (*Clupea harengus*, Table 3) and cod (*Gadus morhua*, Table 3) from R.A. Myers' stock recruitment database (<http://fish.dal.ca/~myers/data.html>). These reference time series data are the fishing mortality (F, based on single species stock assessment using VPA carried out by the Marine Research Institute) and biomass (estimated as Catch/F) from 1950 to 1997. During the Ecosim simulations, vulnerability parameters for all functional groups in the 1950 model were set at an intermediate control level (i.e., 0.3).

Results indicated that by simulating from 1950 to 1997 using the reference time series data, the model was able to emulate several features of both the herring and the cod fisheries (Figures 3 and 4).

In the case of the Icelandic summer spawning herring stock, the model was able to replicate the herring collapse in the late 1960s and its recovery in the 1970s (Figure 3, upper panel). Despite the increase of fishing mortality in the late 1960s (Figure 3, middle panel), yield continued to decline (Figure 3, lower panel). Trend of biomass recovery in later years also follow the same pattern (Figure 3, upper panel), though its absolute biomass prediction for each year differ markedly from the corresponding reference time series biomass data.

The model was also able to simulate most of the observed trends of cod biomass from 1950 to 1997 (Figure 4, upper panel). Using the 1950 model 'forced' by the reference time series fishing mortality data (Figure 4, middle panel), in general, the cod biomass was predicted to have a declining trend over the years, except for two data points in 1996 and 1997 (see circled dots in Figure 4, upper panel).

In its report on the *State of Marine Stocks in Icelandic Waters 1997/1998*, the Marine Research Institute (1998) reported a recovery of cod biomass in 1997 of about one and half time the level of biomass in 1995, which were thought to be a result of conservation measures. Meanwhile the reference time series data collated in the R.A. Myers database (Table 3, which also came from the same source but from an earlier VPA study, and used in the simulation) estimated a four-fold biomass recovery from 1995 to 1996/1997. However, the model prediction simulated by Ecosim for 1996 and 1997 estimated a 40% lower cod biomass compared to the reference time series data (see solid line for 1996 and 1997 in Figure 4, upper panel, versus the two circled dots).

As mentioned above, what seemed to be a recovery of cod as noted in the reference data and the Marine Research Institute's report of 1998 is now considered as an overestimation of stock size, and consequently, landings have amounted to 27-42% of the fishable stock, far exceeding the 25% aimed at by management (Marine Research Institute, 2001).

### **DISCUSSION**

What can be learned from this modelling exercise - in particular with the Icelandic herring and cod examples - is that parallel exploration using different analytical approaches (i.e., single species versus ecosystem-based) and different models at different time period (i.e., past and present-day

**Table 3:** Time series data of fishing mortality (F, based on single species stock assessment using virtual population analysis) and estimated biomass (B, estimated as Catch/F) for Icelandic summer spawning stock herring (*Clupea harengus*) and cod (*Gadus morhua*) from 1950 to 1997, as documented in the R.A. Myers' stock recruitment database (<http://fish.dal.ca/~myers/data.html>).

Year	<i>Clupea harengus</i>		<i>Gadus morhua</i>	
	F (year <sup>-1</sup> )	B <sup>a</sup> (t·km <sup>-2</sup> )	F (year <sup>-1</sup> )	B <sup>a</sup> (t·km <sup>-2</sup> )
1950	0.195	0.1851	0.25	0.0039
1951	0.2573	0.163	0.29	0.0031
1952	0.4372	0.0637	0.32	0.0033
1953	0.3589	0.1302	0.3	0.0047
1954	0.148	0.1973	0.27	0.0054
1955	0.1398	0.3892	0.3	0.0048
1956	0.1479	0.3661	0.25	0.0051
1957	0.201	0.3011	0.31	0.0039
1958	0.2199	0.4043	0.32	0.0042
1959	0.2531	0.367	0.32	0.0038
1960	0.0713	1.0609	0.37	0.0033
1961	0.2849	0.6894	0.33	0.003
1962	0.4722	0.5222	0.39	0.0026
1963	0.775	0.4462	0.45	0.0024
1964	0.802	0.2863	0.54	0.0021
1965	1.2134	0.2688	0.61	0.0017
1966	0.7637	0.203	0.54	0.0018
1967	1.3328	0.1348	0.49	0.0019
1968	0.7793	0.0572	0.67	0.0015
1969	0.9457	0.0587	0.53	0.002
1970	1.167	0.0374	0.56	0.0022
1971	1.5835	0.0198	0.62	0.0019
1972	0.1683 <sup>b</sup>	0.0058	0.71	0.0015
1973	0.049	0.0138	0.71	0.0014
1974	0.0292	0.1158	0.75	0.0013
1975	0.1098	0.321	0.8	0.0012
1976	0.1573	0.2897	0.76	0.0012
1977	0.3	0.2559	0.63	0.0014
1978	0.3229	0.3069	0.48	0.0018
1979	0.2331	0.5132	0.43	0.0023
1980	0.2827	0.5001	0.45	0.0026
1981	0.4471	0.2347	0.68	0.0018
1982	0.4598	0.3263	0.78	0.0013
1983	0.2121	0.7341	0.78	0.001
1984	0.1311	1.0182	0.62	0.0012
1985	0.1573	0.8283	0.66	0.0013
1986	0.3094	0.5611	0.78	0.0013
1987	0.4711	0.425	0.83	0.0013
1988	0.7022	0.3468	0.96	0.001
1989	0.4634	0.577	0.67	0.0014
1990	0.5661	0.4951	0.71	0.0013
1991	0.4634	0.6272	0.77	0.0011
1992	0.3504	0.8092	0.79	0.0009
1993	0.2487	1.0971	0.9	0.0007
1994	-	-	0.64	0.0007
1995	-	-	0.47	0.001
1996	-	-	0.19	0.0038
1997	0.3502	0.3623	0.2	0.004

<sup>a</sup>The original estimated biomass data were in tonnes. Here, it is converted to t·km<sup>-2</sup>, using the total area for ICES area Va (*i.e.*, 376,766 km<sup>2</sup>, R. Watson, pers. comm.).

<sup>b</sup>Due to the herring stock collapse in the late 1960s, a moratorium on herring fishing was introduced in 1972. The fishery partially resumed in 1975.

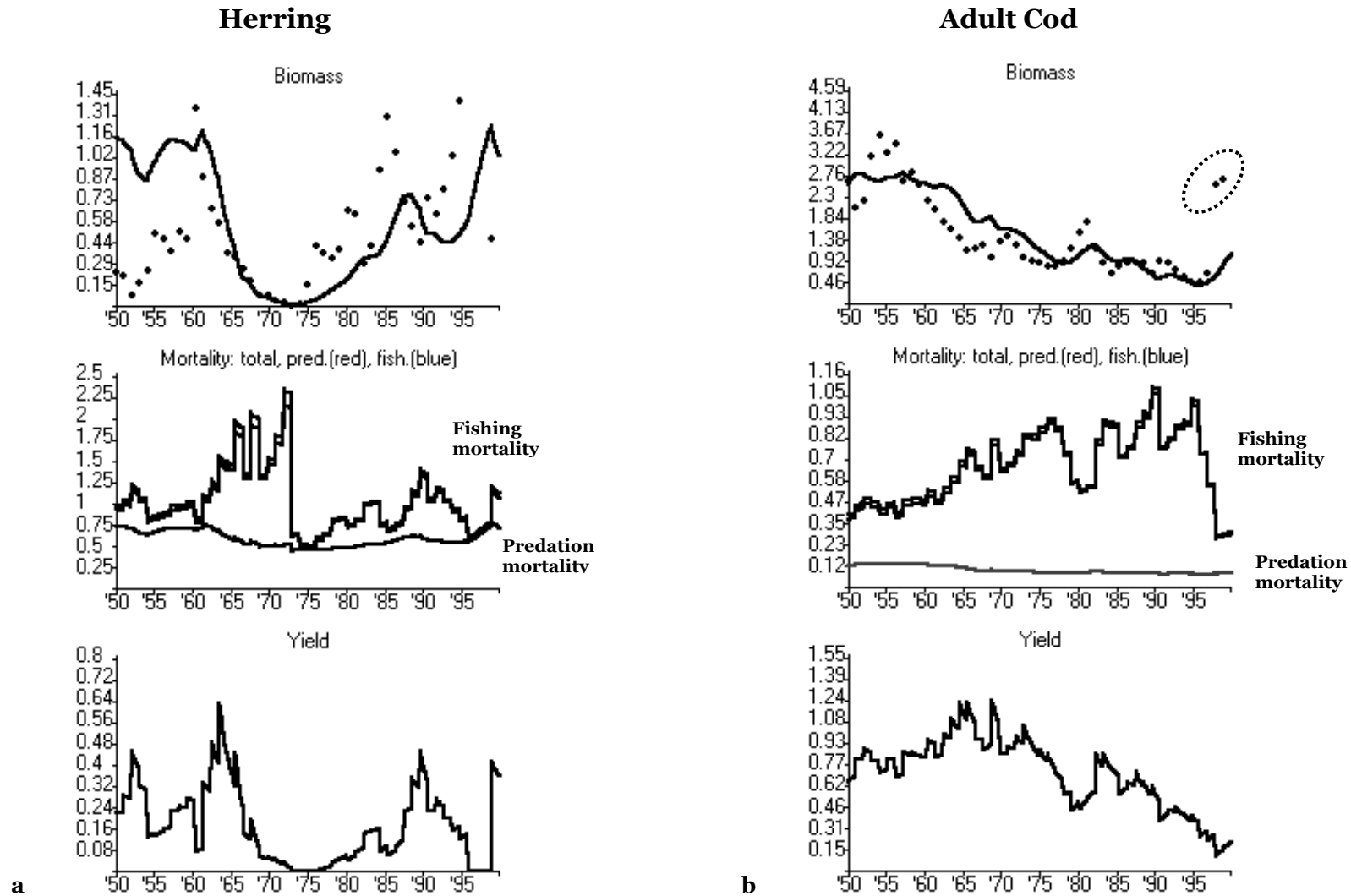

**Figure 3ab.** Model prediction (represented by the solid line in the top panel) of the biomass ( $t\text{-km}^{-2}$ ) of Icelandic summer spawning herring (*Clupea harengus*) and cod (*Gadus morhua*) simulated using Ecosim from 1950 to 1997. The simulation used the 1950 model of the Icelandic marine ecosystem and reference time series data (from assessment) on fishing mortality (middle panel) and estimated biomass (represented by the dotted line in the top panel) of the same stock (see also Table 3). Predicted yield is presented in the lower panel;

**3a.** A dramatic drop in fishing mortality (middle panel) in the early 1970s was caused by a moratorium on herring that was introduced in 1972.;

**3b.** The model was able to simulate the trend of general decline in cod biomass that spans over forty eight years. Two outlier biomass data estimated for 1996 and 1997 (see circled dots in the top panel) are here suspected to be overestimated as cod stock size, as discussed in the text.

models) that are linked with time series data, are very useful in understanding decadal population dynamics in an ecosystem context. This will allow us to gain insights into critical uncertainties and gaps in the present knowledge on the ecosystem and/or species of interest.

In addition, by having the ecosystem models of the past and the present-day as reference points, policy makers would have more versatile access and tools to weight the benefits and costs of particular fisheries management plans and policies.

Further improvements to the 1950 model should include: (1) replacing the Ecopath estimated biomass values with biomass data estimated from careful analysis of historical documents and of local ecological knowledge; and (2) including reference time series data of more species, in particular from fisheries independent surveys, in order to tune the vulnerability parameter. As in the 1997 model, the main uncertainties in this 1950 model lie in the diet composition information.

#### ACKNOWLEDGEMENTS

Thanks are due to the Pew Charitable Trusts, Philadelphia, USA, for funding the *Sea Around Us* project at the University of British Columbia, Canada. The author wishes to thank Dr. Reg Watson, Dr. Dirk Zeller, Hreidar Valtýsson and Fred Valdez for their help.

#### REFERENCES

Brey, T. 1995. Empirische Untersuchungen zur Populationdynamik makrobenthischer Evertrebraten. Habilitationsschrift, Universität Bremen, 170 p.

Christensen, V. and Pauly, D. 1993. Flow characteristics of aquatic ecosystems, p. 338-352. In: V. Christensen and D. Pauly (eds.). Trophic models of aquatic ecosystems. ICLARM Conference Proceedings 26.

Christensen, V. and Walters, C.J. 2000. Ecopath with Ecosim: methods, capabilities and limitations. pp. 79-105. In: Methods for Evaluating the Impacts of Fisheries on North Atlantic Ecosystems. Ed. by D. Pauly and T.J. Pitcher. Fisheries Centre Research Report 8(2).

Christensen, V., Walters, C.J. and Pauly, D. 2000. Ecopath with Ecosim: A User's Guide. Univ. of British Columbia, Fisheries Centre, Vancouver, Canada and ICLARM, Penang, Malaysia. 125 p.

Jakobson, J. 1983. Echo surveying of the Icelandic summer spawning herring 1973-1982. In: Selected papers of the ICES/FAO Symposium on Fisheries Acoustics, Bergen, Norway, 21-24 June 1982. FAO (Food and Agriculture Organization of the United Nations) Fisheries Reports, pp. 240-248, No. 300.

Kaschner, K., Watson R., Christensen V., Trites A.W., and Pauly D. 2001. Modeling and mapping trophic overlap between marine mammals and commercial fisheries in the North Atlantic. pp. 35-45. In: Fisheries Impacts on North Atlantic Ecosystems: Catch, effort and national/regional data sets. Ed. by D. Zeller, R. Watson, and D. Pauly. Fisheries Centre Research Report 9 (3).

Longhurst, A.R. 1995. Seasonal cycle of pelagic production and consumption. Progress in Oceanography, 36: 77-167.

Longhurst, A.R. 1998. Ecological Geography of the Sea. Academic Press, San Diego. 398 pp.

Marine Research Institute. 1998. Nyttjastofnar sjávar 1997/1998. Aflahorfur fiskveiðiárid 1998/1999 (State of Marine Stocks in Icelandic Waters 1997/1998. Prospects for the Quota Year 1998/1999). Icelandic with English summary, available at [www.hafro.is/hafro/Radgjof/1998/summary.html](http://www.hafro.is/hafro/Radgjof/1998/summary.html).

Marine Research Institute. 2000. Nyttjastofnar sjávar 1999/2000. Aflahorfur fiskveiðiárid 2000/2001 (State of Marine Stocks in Icelandic Waters 1999/2000. Prospects for the Quota Year 2000/2001). Fjölrit Hafrannsóknastofnunar No. 75. Icelandic with English summary, available at [www.hafro.is/hafro/Radgjof/2000/summary.html](http://www.hafro.is/hafro/Radgjof/2000/summary.html).

Marine Research Institute. 2001. Nyttjastofnar sjávar 2000/2001. Aflahorfur fiskveiðiárid 2001/2002 (State of Marine Stocks in Icelandic Waters 2000/2001. Prospects for the Quota Year 2001/2002). Icelandic with English summary, available at [www.hafro.is/Astand/englsum.pdf](http://www.hafro.is/Astand/englsum.pdf), and [www.hafro.is/Astand/aflatohur.doc](http://www.hafro.is/Astand/aflatohur.doc).

Marten, G.G. and Polovina, J.J. 1982. A comparative study of fish yields from various tropical ecosystems, p. 255-289. In: D. Pauly and G.I. Murphy (eds.). Theory and management of tropical fisheries. ICLARM Conference Proceedings 9.

Pauly, D. 2001. What we did: a very preliminary report of the first two years of the *Sea Around Us* project. The *Sea Around Us* project Newsletter, Issue 9 - May/June 2001, p. 1-3.

Pauly, D. and Pitcher, T.J. 2000. Assessment and mitigation of fisheries impacts on marine ecosystems: a multidisciplinary approach for basin-scale inferences, applied to the North Atlantic. pp. 1-12. In: Methods for Evaluating the Impacts of Fisheries on North Atlantic Ecosystems. Ed. by D. Pauly and T.J. Pitcher. Fisheries Centre Research Report 8(2).

Pauly, D., Christensen, V., Froese, R., Longhurst, A., Platt, T., Sathyendranath, S., Sherman, K. and Watson, R. 2000. Mapping fisheries onto marine ecosystems: a proposal for a consensus approach for regional, oceanic and global integrations. pp. 13-22. In: Methods for Evaluating the Impacts of Fisheries on North Atlantic Ecosystems. Ed. by D. Pauly and T.J. Pitcher. Fisheries Centre Research Report 8(2).

Pitcher, T.J. 2001a. Fisheries managed to rebuild ecosystems? Reconstructing the past to salvage the future. Ecological Application, 11(2): 601-617.

Pitcher, T.J. 2001b. Cod (again) acting in a mysterious way. FishBytes [Fisheries Centre, UBC], 7(3): 3.

Valtýsson, H. T. 2001. The sea around Icelanders: Catch history and discards in Icelandic waters. pp. 52-87. In: Fisheries Impacts on North Atlantic Ecosystems: Catch, effort and national/regional data sets. Ed. by D. Zeller, R. Watson, and D. Pauly. Fisheries Centre Research Report 9 (3).

Watson, R., Guénette, S., Fanning, P., and Pitcher, T.J. 2000. The basis for change: Part 1 - Reconstructing fisheries catch and effort data. pp. 23-39. In: Methods for Evaluating the Impacts of Fisheries on North Atlantic Ecosystems. Ed. by D. Pauly and T.J. Pitcher. Fisheries Centre Research Report 8(2).

## A NORTH-EAST ATLANTIC MARINE ECOSYSTEM MODEL FOR THE FAROE ISLANDS (ICES AREA Vb): INPUT DATA

**D. Zeller and K. Freire**

Fisheries Centre, University of British Columbia  
2204 Main Mall, Vancouver, V6T 1Z4, Canada  
email: d.zeller@fisheries.ubc.ca

### ABSTRACT

This report documents the construction and input data of the Ecopath with Ecosim model for the Faroe Islands marine ecosystem (ICES area Vb), covering the year 1997. The model comprises 19 functional groups, including two marine mammal groups and seabirds. The fisheries component consist of national and foreign fleets, with an emphasis on demersal fisheries.

### FAROE ISLANDS AND ICES AREA Vb

The Faroe Islands (population ~ 46,000) are located in the North-East Atlantic between the British Isles and Iceland, and consist of a group of 18 islands covering 1,399 km<sup>2</sup>. While officially part of the Danish kingdom, the Faroe Islands hold a special status since 1948, involving local autonomy. The major industries are fishing, sheep farming and cloth manufacturing, with fishing being the major export industry, contributing 44.5% of GDP and over 95% of all exports (<http://encarta.msn.com>). Commercial as well as subsistence fisheries play a significant role in Faroese culture and society (Anon., 1999a).

The waters surrounding the Faroe Islands are dominated by the North-Atlantic drift, which provides temperate conditions throughout the year (Anon., 1999a). ICES Area Vb covers 190,200 km<sup>2</sup> and is subdivided into Vb1 (169,800 km<sup>2</sup>) which includes the Faroe Islands, Faroe plateau, Bill Baileys Bank and areas of deep, pelagic waters, and Vb2 (20,400 km<sup>2</sup>) which surround the Faroe Bank. The fisheries in the Faroe islands can be characterized as multi-gear and multi-species (Anon., 1997). In 1994 the Faroe Islands introduced an 'individual transferable quota'-based management system, but this was not successful, resulting in substantial increases in discarding and misreporting. Therefore, by mid 1996, a new management system based on individual transferable effort quotas (within same-gear

categories only) and seasonally closed areas (spawning periods) was introduced (Anon., 1997; Anon., 1999b). Thus, the focus of the new management system has shifted from catch to effort (Anon., 1999a).

### Brief review of Faroe and ICES Area Vb fisheries

Cod stocks (*Gadus morhua*) and other demersal species form the most significant component for the Faroese fishing industry (Anon., 1999a). Since the establishment of the Faroese EEZ in 1977, the demersal fishery by foreign nations has decreased (Anon., 1999b), while the local fishing fleet underwent a period of over-investment in the 1980s (Anon., 1999a). Cod stocks in Faroese waters were reported to have declined substantially from the mid 1980s to mid 1990s, due to environmental effects and overfishing (Anon., 1999a). Fishing mortalities for cod increased considerably in the 1980s, but more recently has declined to close to recommended levels (Anon., 1999b). Fishing mortalities for saithe (*Pollachius virens*) increased considerably during the last few decades, primarily due to the introduction of pair-trawlers, but since 1995 have been decreasing steadily. Fishing mortalities on haddock (*Melanogrammus aeglefinus*) have been very low since the 1980s, a result of very low stocks and poor recruitment. During the late 1990s, however, fishing mortalities increased due to two strong recruitment year classes (Anon., 1999b). With respect to the demersal fisheries, the new effort management system aims for average fishing mortalities of 0.45-year<sup>-1</sup>. This corresponds to an average annual catch of approximately 33% of the exploitable biomass (Anon., 1999b).

Blue whiting (*Micromesistius poutassou*), Norwegian spring spawning herring (*Clupea harengus*) and mackerel (*Scomber scombrus*) form the main components of the pelagic fisheries (both foreign and Faroese fleets) in ICES Area Vb. Blue whiting are caught from the Barents Sea to the Strait of Gibraltar, and the stock is considered to be relatively stable since the early 1980s, though estimates of abundance are imprecise (Anon., 1997). The total 1997 landings of blue whiting in all ICES areas exceeded management advice by nearly 15% (Anon., 1998a). Average fishing mortality has been estimated at 0.325-year<sup>-1</sup>, and a projected increase to 0.4-year<sup>-1</sup> is beyond the suggested safe level (Anon., 1998a). In Area Vb, blue whiting are caught primarily by Russia and Norway, with only ~ 4% of the 1997 catch taken by Faroese vessels (as established from the ICES STATLANT database).

In contrast, over 90% of the total herring catch in Area Vb was taken by Faroese vessels in 1997. Overall, the fisheries on the Norwegian spring spawning herring stock imposed a fishing mortality of  $0.19\text{-year}^{-1}$  in 1997 (Anon. 1999c). Nearly 40% of the mackerel catches in Area Vb during 1997 were taken by the local fleet. The other major nations catching mackerel in this area were Russia, Denmark, Estonia and the U.K. (ICES STATLANT). Average fishing mortalities for the complete North-East Atlantic mackerel stock varied from a high of  $0.25\text{-year}^{-1}$  in the mid 1980s to a low of  $0.19\text{-year}^{-1}$  in 1991, before increasing again to 0.25 in the mid 1990s (Anon., 2000). Mackerel are considered to be outside of safe biological limits and ICES advises significant reductions in fishing mortalities (Anon., 1997).

The deep-water fisheries catch target Greenland halibut (*Reinhardtius hippoglossoides*), redfish (*Sebastes* spp.), silver smelt (*Argentina* spp.), ling (*Molva molva*) and others. The long life-span and associated low rate of increase of many of these species means that catches are sustained for a number of years as the stocks are 'mined', before they suddenly collapse (Anon., 1997). The deepwater fisheries in ICES Area Vb was separated into three components for the present modeling attempt: redfish, Greenland halibut and other deep water species. Total landings from ICES Vb for 1997 were over 34,000 tonnes, of

which the Faroese fleets took over 97% of the Greenland halibut and redfish catch, and 78% of the other deep water species.

#### ECOSYSTEM MODEL

An ecosystem model of the Faroese waters (covering ICES Area Vb) was constructed for 1997, using Ecopath with Ecosim (4.0 beta; [www.ecopath.org](http://www.ecopath.org), date: June 2000). The present model is a preliminary version, and much of the data used had to be obtained from indirect sources and areas that are close to, but not identical to ICES Area Vb (i.e., non-Faroe area data). The authors, in collaboration with scientists from the Faroe Islands, are in the process of updating the present model, and undertake ecosystem level simulations (Zeller and Reinert, in review). The parameterized Ecopath input data used are summarized in Table 1, and sources for the group specific information are summarized in Table 2. The areas of emphasis of subsequent simulations initiated during the FAO sponsored workshop conducted at UBC in July 2000 were to explore the new open and closed loop fisheries policy search routines in Ecosim using three extreme scenarios (economic, social and ecosystem stability) and an initial attempt to simulate a potential compromise scenario (Zeller and Freire, 2002). Here, we report only on the Ecopath input data.

**Table 1:** Ecopath parameters used to describe the 1997 ICES Area Vb (Faroe Islands) marine ecosystem with 20 functional groups. P/B and Q/B are the production/biomass and consumption/biomass ratios, respectively.

Group	Biomass (t·km <sup>-2</sup> )	P/B (year <sup>-1</sup> )	Q/B (year <sup>-1</sup> )	Ecotrophic efficiency	Catch (t·km <sup>-2</sup> )	Trophic level	Vulnerability setting
Baleen whales	0.059	0.050	5.059	0.069	-	3.9	0.7
Toothed mammals	0.034	0.050	12.266	0.981	-	4.6	0.9
Seabirds	0.017	0.010	35.000	0.000	-	3.8	0.7
Cod	0.570	0.653	3.100	0.638	0.20	4.1	0.8
Haddock	0.723	0.346	3.800	0.660	0.09	3.6	0.7
Saithe	0.611	0.443	3.300	0.739	0.12	4.1	0.8
Redfish	2.133	0.350	4.500	0.552	0.04	3.7	0.7
Greenland Halibut	0.109	0.446	3.500	0.950	0.03	3.6	0.7
Other demersal fish	1.869	0.450	3.000	0.950	0.03	3.7	0.7
Other deep water	0.765	0.350	3.100	0.950	0.10	4.1	0.8
Herring	1.903	0.296	4.600	0.949	0.10	3.4	0.6
Blue Whiting	3.557	0.355	9.060	0.950	0.57	3.6	0.7
Mackerel	1.030	0.276	4.400	0.950	0.06	3.7	0.7
Other pelagics	9.641	0.585	4.500	0.947	0.02	3.2	0.6
Benthos	9.259	3.000	10.000	0.950	0.02	2.5	0.4
Nekton	4.647	0.600	3.500	0.950	-	3.6	0.7
Lrg. Zooplankton	16.193	7.763	40.000	0.950	-	2.6	0.5
Sm. Zooplankton	11.526	40.000	140.000	0.950	-	2.1	0.3
Phytoplankton	54.360	50.000	-	0.682	-	1.0	0.1
Detritus	-	-	-	0.027	-	1.0	0.1

**Table 2:** Sources of input parameters for the Faroe Islands Ecopath with Ecosim Model. Dash means parameters estimated by the model (P/B & Q/B values are annual).

GROUP	B	P/B	Q/B	EE	Diet
<b>1. Baleen whales:</b> <i>Balaenoptera acutorostrata</i> , <i>B. borealis</i> , <i>B. physalus</i> , <i>Megaptera novaeangliae</i>					
	Trites & Pauly, 1998 Pauly <i>et al.</i> 1998	V.Christensen, pers. com.	Trites & Pauly, 1998 Pauly <i>et al.</i> 1998	—	Trites & Pauly, 1998 Pauly <i>et al.</i> 1998
<b>2. Toothed mammals:</b> seals ( <i>Halichoerus grypus</i> , <i>Phoca vitulina</i> ); dolphins ( <i>Lagenorhynchus acutus</i> , <i>L. albirostris</i> , <i>Phocoena phocoena</i> , <i>Grampus griseus</i> ); whales ( <i>Globicephala melas</i> , <i>Orcinus orca</i> , <i>Physeter catodon</i> )					
	Trites & Pauly 1997, 1998 Pauly <i>et al.</i> 1998	V.Christensen, pers. com.	Trites & Pauly 1997, 1998 Pauly <i>et al.</i> 1998	—	Trites & Pauly 1997, 1998 Pauly <i>et al.</i> 1998
<b>3. Seabirds</b>					
	Anon. 1998c, Anon. 1999d	Anon. 1998c, Anon. 1999d	Anon. 1998c, Anon. 1999d	—	Lilliendahl & Solmundsson 1997
<b>4. Cod:</b> <i>Gadus morhua</i>					
	ICES single sp. VPA: Anon. 1998b, Anon. 1999b	ICES single sp. VPA: Anon. 1998b, Anon. 1999b	Christensen & Pauly 1992 Jónsson 1957, 1965 Schopka & Hempel 1973	—	Du Buit 1989
<b>5. Haddock:</b> <i>Melanogrammus aeglefinus</i>					
	ICES single sp. VPA: Anon. 1998b, Anon. 1999b	ICES single sp. VPA: Anon. 1998b, Anon. 1999b	Christensen & Pauly 1992 Blacker 1971	—	Du Buit 1989
<b>6. Saithe:</b> <i>Pollachius virens</i>					
	ICES single sp. VPA: Anon. 1998b, Anon. 1999b	ICES single sp. VPA: Anon. 1998b, Anon. 1999b	Christensen & Pauly 1992 Jones & Jónsson 1971	—	Du Buit 1989
<b>7. Redfish:</b> <i>Sebastes</i> spp.					
	Guesstimate	Christensen <i>et al.</i> 2000	Bundy <i>et al.</i> 2000	—	Gunnarson <i>et al.</i> 1998
<b>8. Other deep water fishes:</b> angler ( <i>Lophius piscatorius</i> ), black scabbardfish ( <i>Aphanopus carbo</i> ), silver smelt ( <i>Argentina</i> spp.); tusk ( <i>Brosme brosme</i> ), greater forkbeard ( <i>Phycis blennoides</i> ), roundnose grenadier ( <i>Coryphaenoides rupestris</i> ), roughhead grenadier ( <i>Macrourus berglax</i> ), megrim ( <i>Lepidorhombus whiffiagonis</i> ), orange roughy ( <i>Hoplostethus atlanticus</i> ), blue ling ( <i>Molva dypterygia</i> ), ling ( <i>M. molva</i> )					
	—	V. Christensen, pers. com.	V. Christensen, pers. com.	V. Christensen, pers. com.	V. Christensen, pers. com., incl. cannibalism: Anon. 1998d, Bjelland & Bergstad 1998
<b>9. Greenland Halibut:</b> <i>Reinhardtius hippoglossoides</i>					
	—	ICES VPA: Anon. 1999b	Bundy <i>et al.</i> 2000	V. Christensen, pers. com.	Gunnarson <i>et al.</i> 1998 Michalsen & Nedreaas 1998.
<b>10. Other demersal fishes</b>					
	—	V. Christensen, pers. com.	Bundy <i>et al.</i> 2000	V. Christensen, pers. com.	Gunnarson <i>et al.</i> 1998

**Table 2 cont.:** Sources of input parameters for the Faroe Islands Ecopath with Ecosim Model. Dash means parameters estimated by the model.

GROUP	B	P/B	Q/B	EE	Diet
<b>11. Herring:</b> <i>Clupea harengus</i>					
	—	ICES VPA for Areas V and XIV: adjusted to Area Vb (Holst <i>et al.</i> 1998, 1999c). Anon.	Christensen & Pauly 1992 Beverton & Holt 1959	V. Christensen, pers. com.	Christensen 1995 V. Christensen, pers. com.
<b>12. Blue whiting:</b> <i>Micromesistius poutassou</i>					
	—	ICES VPA: Anon. 1999c	<i>www.fishbase.com</i>	V. Christensen, pers. com.	<i>www.fishbase.com</i>
<b>13. Mackerel:</b> <i>Scomber scombrus</i>					
	—	VPA (western stock): Anon. 2000	<i>www.fishbase.com</i>	V. Christensen, pers. com.	North Sea (Christensen 1995) Western Atlantic (Studhome <i>et al.</i> 1999)
<b>14. Other pelagics</b> (zooplanktivores): capelin ( <i>Mallotus villosus</i> ), European smelt ( <i>Osmerus eperlanus</i> ), Atlantic horse mackerel ( <i>Trachurus trachurus</i> ), Norway pout ( <i>Trisopterus esmarkii</i> )					
	—	Christensen 1995	Christensen 1995	Christensen 1995	Christensen 1995
<b>15. Benthos:</b> Norway lobster ( <i>Nephrops norvegicus</i> ), northern prawn ( <i>Pandalus borealis</i> ), crab ( <i>Cancer pagurus</i> ), Queen scallop ( <i>Chlamys opercularis</i> )					
	—	Bundy <i>et al.</i> 2000	V. Christensen, pers. com.	V. Christensen, pers. com.	Gunnarson <i>et al.</i> 1998
<b>16. Nekton:</b> cephalopods					
	—	V. Christensen, pers. com.	Bundy <i>et al.</i> 2000	V. Christensen, pers. com.	Gunnarson <i>et al.</i> 1998
<b>17. Large zooplankton:</b> large amphipods, copepods (e.g., <i>Calanus finmarchicus</i> ), euphausiids ( <i>Thysanoessa</i> spp.).					
	Dry weight biomass for south-west Iceland (Gislason & Astthorson 1995); DW=0.26*WW, Opitz 1996; adjusted to ICES Area Vb	—	V.Christensen, pers. com.	V.Christensen, pers. com.	V.Christensen pers. com.
<b>18. Small zooplankton</b>					
	—	V. Christensen, pers. com.	V. Christensen, pers. com.	V. Christensen, pers. com.	V. Christensen pers. com.
<b>19. Phytoplankton</b>					
	P from Longhurst <i>et al.</i> 1995; converted to wet weight using Pauly & Christensen 1995	Mackinson 1996 V. Christensen, pers. com.	—	—	



## Fishing fleet information

Landings for 1997 by species for all fleets in ICES Area Vb were obtained from the ICES STATLANT database. No information on discards is currently incorporated into the model. All non-Faroese fleets (mainly Iceland, Norway, Russia, United Kingdom, Germany, France, Denmark and Estonia) were pooled into a single 'Foreign' category (Table 3). The Faroese fleets were separated by gear according to the ICES NWWG report (Anon., 1999b) and the Faroe Fisheries Laboratory report (Anon., 1998e), with the following changes: 1) addition of a 'Pelagic' gear type accounting for all Faroese catches of pelagic species, 2) pooling of 'Industrial' and 'Others' gear type due to low catches. ICES catches were allocated to Faroese gear types according to the percentage distributions of landings documented in Anon. (1998e).

**Table 3:** Fishing gear categories as defined for the present ecosystem modeling. Changes to the Faroese fisheries management gear categories include: pooling of all foreign vessels into one category, addition of a domestic pelagic gear type ('Pelagic'), and pooling of industrial and other gear type into one ('Other') due to low catches (Anon. 1999b).

Fleet/gear type	Foreign/Domestic
Foreign (pelagic & demersal)	Foreign
Open boat	Domestic
Longline max 100t	Domestic
Longline > 100t	Domestic
Singletrawl max 400hp	Domestic
Singletrawl 400-1000hp	Domestic
Singletrawl > 1000hp	Domestic
Pairtrawl max 1000hp	Domestic
Pairtrawl > 1000hp	Domestic
Gillnet	Domestic
Jigger	Domestic
Others	Domestic
Pelagic	Domestic

Fish prices (market price) for each species/group were obtained from Fish Information Service ([www.fis.com](http://www.fis.com)). For Faroese landings, market prices from Faroese markets were used; for foreign fleets, market prices for Danish, Icelandic and Norwegian markets were averaged. All prices are reported in US\$ kg<sup>-1</sup>, and refer to June 2000. For non-single species groups, prices for group members were averaged to derive average group market prices. The assumed discount rate is 4%, and non-market values have not been considered.

Costs (by gear type) are approximated from Anon. (1994) and expressed as a percentage of the total landed value. However, these costs are based on Canadian fisheries and location specific information is required.

## CONCLUSIONS

The society and economy of the Faroe Islands is highly dependent on fisheries as the major export earner. Thus, Faroe society is highly vulnerable to fluctuations in stocks and hence catch, making efficient management strategies a priority (Anon., 1999a). This is particularly relevant as most commercial species are considered fully or over-exploited (Anon., 1997, 1999a). This situation has been brought about largely by long-term overfishing in most areas of the north-east Atlantic, although environmental factors may have played a role in a few stocks (Anon., 1997). At the same time, this high dependence on what is essentially a 'single-crop' economy, should result in very cautious management. We consider that improvements to the present model in the form of more accurate data and time series information will permit options for management scenarios to be simulated and evaluated, (e.g., Zeller and Reinert, in review). Such evaluations might point to policies that can lead to sustainable landings and economic yields, with improved stability in catches and reduced risk of stock collapse.

## ACKNOWLEDGEMENTS

We would like to thank the Pew Charitable Trusts for funding the *Sea Around Us* project, and FAO and Japan and the Fisheries Centre (UBC) for supporting and organizing the Ecopath workshop held in June 2000. Furthermore, we would like to thank Dr Jakup Reinert from the Faroese Fisheries Branch for his assistance in data assimilation. K. Freire would like to acknowledge her sponsorship from the Conselho Nacional de Desenvolvimento Científico e Tecnológico/Brazil.

## REFERENCES

- Anon. 1997. Review of the state of world fishery resources: marine fisheries. FAO Fisheries Circular No. 920 FIRM/C920 (ISSN 0429-9329), Rome, FAO. 173 pp.
- Anon. 1998a. Report of the northern pelagic and blue whiting fisheries working group. ICES CM 1998/ACFM:18, 276 pp.
- Anon. 1998b. Report of the north-western working group. ICES CM 1998/ACFM:19, 350 pp.
- Anon. 1998c. Report of the working group on seabird ecology. ICES CM 1998/C:5, 37 pp.
- Anon. 1998d. Report of the study group on redfish stocks. ICES CM 1998/G:3, 36 pp.
- Anon. 1998e. Fiskastovnar og umhvørvi. Lagt til rættis: Fiskirannsóknarstovan. Faroe Islands Fisheries Laboratory. [www.frs.fo/fiskif/fiskogum/index.htm](http://www.frs.fo/fiskif/fiskogum/index.htm).
- Anon. 1999a. Fishery Country Profile: Faroe Islands. FID/CP/FRO Rev. 3. Rome, FAO. [www.fao.org/fi/fcp/faroeise.asp](http://www.fao.org/fi/fcp/faroeise.asp).
- Anon. 1999b. Report of the north-western working group. ICES CM 1999/ACFM:17, 327 pp.
- Anon. 1999c. Report of the northern pelagic and blue whiting fisheries working group. ICES CM 1999/ACFM:18, 238 pp.
- Anon. 1999d. Report of the working group on seabird ecology. ICES CM 1999/C:5, 58 pp.
- Anon. 2000. Report of the working group on the assessment of mackerel, horse mackerel, sardine and anchovy. ICES CM 2000/ACFM:5, 456 pp.
- Bjelland, O., and Bergstad, O.A. 1998. Trophic ecology of deepwater fishes associated with the continental slope of the eastern Norwegian Sea. ICES CM 1998/O:51, 26 pp.
- Blacker, R. 1971. Synopsis of biological data on haddock *Melanogrammus aeglefinus* (Linnaeus) 1758. FAO Spec. Synop. (84).
- Bundy, A., G.R. Lilly, P. Shelton. 2000. A mass balance model of the Newfoundland-Labrador Shelf. Canadian Technical Report of Fisheries and Aquatic Sciences No. 2310.
- Christensen, V. 1995. A model of trophic interactions in the North Sea in 1981, the Year of the Stomach. *Dana* 11(1): 1-28.
- Christensen, V. and D. Pauly. 1992. A guide to the ECOPATH II software system (version 2.1). ICLARM Software 6, 72 p.
- Christensen, V., C.J. Walters, and D. Pauly. 2000. Ecopath with Ecosim: A User's Guide. Univ. of British Columbia, Fisheries Centre, Vancouver, Canada and ICLARM, Penang, Malaysia. 125 p.
- Du Buit, M.H. 1989. Quantitative analysis of the diet of cod (*Gadus morhua*) off the coast of Scotland, *Annals of the Institute of Oceanography*, Paris 65(2):147-158.
- Gislason, A., and Astthorson, O.S. 1995. Seasonal cycle of zooplankton southwest of Iceland. *Journal of Plankton Research* 17(10):1959-1976.
- Gunnarsson, K., Jónsson, G. and Pálsson, Ó.K. 1998. Sjávarnytjar við Ísland (Marine resources of Iceland). Mál og menning, Reykjavík, Iceland. (In Icelandic)
- Holst, J.C., Arrhenius, F., Hammer, C., Hakansson, N., Jacobsen, A., Krysov, A., Melle, W., and Vilhjalmsen, H. 1998. Report on surveys of the distribution, abundance and migrations of the Norwegian spring-spawning herring, other pelagic fish and the environment of the Norwegian Sea and adjacent waters in late winter, spring and summer of 1998. ICES CM 1998/D:3, 26 pp.
- Jones, B.W., and J. Jónsson. 1971. Coalfish tagging experiments at Iceland. *Rit. Fiskideildar* 5(1): 27 p.
- Jónsson, J. 1957. Icelandic cod investigation in Southwest and Southeast Greenland waters 1957. *Cons. Int. Explor. Mer. Ann. Biol.* 14: 115-118.
- Jónsson, J. 1965. Temperature and growth of cod in Icelandic waters. *ICNAF Spec. Publ.* 6: 537-539.
- Lilliendahl, K. and J. Solmundsson. 1997. An estimate of summer food consumption of six seabird species in Iceland. *ICES J. Mar. Sci.* 54 (4): 624-630.
- Longhurst, A.R., Sathyendranath, S., Platt, T., and Caverhill, C.M. 1995. An estimate of global primary production in the ocean from satellite radiometer data. *Journal of Plankton Research* 17: 1245-1271.
- Mackinson, S. 1996. Strait of Georgia Model: system definition and primary production. pp 63-64. In: *Mass-balance models of north-eastern Pacific ecosystems*. Ed. by D. Pauly and V. Christensen. Fisheries Centre Research Report 4 (1).
- Mendy, A. 1997. Trophic modeling as a tool to evaluate and manage Iceland's multispecies fisheries. Report of the Marine Research Institute of Iceland. MS.
- Michalsen, K., and Nedreaas, K.H. 1998. Food and feeding of Greenland halibut (*Reinhardtius hippoglossoides*), *Sarsia* 83(5):401-407.
- Opitz, S. 1996. Trophic interactions in Caribbean reefs. ICLARM Technical Report 43:341 pp.
- Schopka, S.A. and G. Hempel. 1973. The spawning potential of populations of herring *Clupea harengus* L. and cod *Gadus morhua* L. in relation to the rate of exploitation. *Rapp. P.-v. Réunion. Council Int. Explor. Mer* 164: 178-175.
- Studhome, A., Packer, D., Berrien, P., Johnson, D., Zetlin, C., and Morse, W. 1999. Essential fish habitat survey document: Atlantic mackerel, *Scomber scombrus*, life history and habitat characteristics. NOAA Technical Memorandum NMFS-NE-141, 35 pp.
- Pauly, D., and Christensen, V. 1995. Primary production required to sustain global fisheries. *Nature* 374:255-257.
- Pauly, D., Trites, A.W., Capuli, E., and Christensen, V. 1998. Diet composition and trophic levels of marine mammals. *ICES Journal of Marine Science* 55:467-481.
- Trites, A.W., and Pauly, D. 1998. Estimating mean body masses of marine mammals from maximum body lengths. *Canadian Journal of Zoology* 76:886-896.
- Zeller, D., and Freire, K. 2002. A preliminary North-east Atlantic marine ecosystem model: Faroe Islands and ICES area Vb. pp 39-45. In: *The Use of Ecosystem Models to Investigate Multispecies Management Strategies for Capture Fisheries*. Ed. by T. Pitcher and K. Cochrane. Fisheries Centre Research Report 10(2).
- Zeller, D., and Reinert, J. in review. The effects of fishing-gear specific spatial closures and effort restrictions in an ecosystem context: The Faroe Island marine ecosystem model. Proceedings of the ACP-EU Ecopath conference, Galapagos Islands, Dec. 2000.

## AN ECOPATH MODEL FOR THE NORWEGIAN SEA AND BARENTS SEA

**Are Dommasnes<sup>1</sup>, Villy Christensen<sup>2</sup>, Bjørnar Ellertsen<sup>1</sup>, Cecilie Kvamme<sup>1</sup>, Webjørn Melle<sup>1</sup>, Leif Nøttestad<sup>1</sup>, Torstein Pedersen<sup>3</sup>, Sigurd Tjelmeland<sup>1</sup>, and Dirk Zeller<sup>2</sup>**

<sup>1</sup>*Institute of Marine Research, P.O. Box 1870 Nordnes, 5024 Bergen, Norway*

<sup>2</sup>*Fisheries Centre, University of British Columbia, Vancouver, V6T 1Z4, Canada*

<sup>3</sup>*Norwegian College of Fisheries Sciences, Tromsø, Norway*

### ABSTRACT

This report documents the construction and basic input data used to generate a 1997 Ecopath with Ecosim model for the Norwegian Sea and Barents Sea, initially assembled during a workshop held at the Institute of Marine Research in Bergen, Norway, in November 2000. This was part of the ocean-wide assessment of ecosystem effects of fishing in the North Atlantic conducted by the *Sea Around Us* project at the University of British Columbia in cooperation with the 'Ecosystem Norwegian Sea' program of the Institute of Marine Research, Bergen. The model area covers 3,116,000 km<sup>2</sup> of Atlantic, arctic and shelf waters. Thirty functional groups were included, ranging from marine mammals to phytoplankton and detritus. In the future, this model can be used to evaluate specific local and regional questions of interest to the Institute of Marine Research, Norway.

### INTRODUCTION

At the Institute of Marine Research in Bergen, Norway, an internal project 'Flux of biomasses', under the program 'Ecosystem Norwegian Sea', has been aimed at the quantification of biomass fluxes between trophic levels in the Norwegian Sea. In June 2000, Villy Christensen at the University of British Columbia, Vancouver, Canada, offered to cooperate in the construction of an Ecopath model for the Norwegian Sea and the Barents Sea. Such a model was needed for the project *Sea Around Us* which aims to present

material documenting large-scale fisheries impact on marine ecosystems, and to show how such impacts may be mitigated and reversed. It was decided to carry out this cooperation as a workshop, which was held in Bergen 15-17 November 2000, with the following as participants: Villy Christensen and Dirk Zeller, University of British Columbia, Vancouver, Canada; and Sigurd Tjelmeland, Leif Nøttestad, Webjørn Melle, Bjørnar Ellertsen, Are Dommasnes, Institute of Marine Research, Bergen. In addition to these workshop participants, Torstein Pedersen from the Norwegian College of Fisheries Sciences in Tromsø, a member of the modeling group, helped prepare the workshop and supplied data. Cecilie Kvamme from the Institute of Marine Research cooperated with Leif Nøttestad in the preparation of data on benthic fish and squid.

Biological data on primary and secondary production, fishes, seabirds and marine mammals were collected prior to the workshop. Fisheries landings for the most important species were obtained from ICES files, and time series for many species of fish were available from ICES Working Group reports. An Ecopath with Ecosim model (Christensen and Pauly, 1993; Christensen, 1995; Pauly and Christensen, 1996; Christensen, Walters and Pauly, 2000) covering ICES areas I, IIa and IIb was constructed for the year 1997 (Figure 1). In addition, using the time series data and working backwards from the 1997 model, a similar model was constructed for 1950.

Plans for future simulations in order to increase understanding of the food chains in the Norwegian Sea and Barents Sea, and publication of the results, will be formulated once the Technical Report of the Institute of Marine Research, Bergen, Norway is completed.

### MODEL AREA

The model covers ICES areas I, IIa and IIb north to approximately 81° N, which includes the Barents Sea (area 1) and the Norwegian Sea (area 2) west to 11° W and south to 63°-64° N (Figure 1). The total surface area is 3,116,000 km<sup>2</sup> (see Table 1 and Figure 1 for sub-areas).

**Table 1.** Surface area (km<sup>2</sup>) of ICES fisheries statistical areas incorporated into the model.

Area	All depths	< 200 m	200-500 m	500-1000 m	1000-2000 m	2000-3000 m	> 3000 m
ICES Area I	1,006,100	472,867	533,233	-	-	-	-
ICES Area IIa	1,348,000	67,400	229,160	80,880	242,640	525,720	202,200
ICES Area IIb	761,900	190,475	152,380	83,810	68,570	175,237	91,428
<b>Total</b>	<b>3,116,000</b>	<b>730,742</b>	<b>914,773</b>	<b>164,690</b>	<b>311,210</b>	<b>700,957</b>	<b>293,628</b>

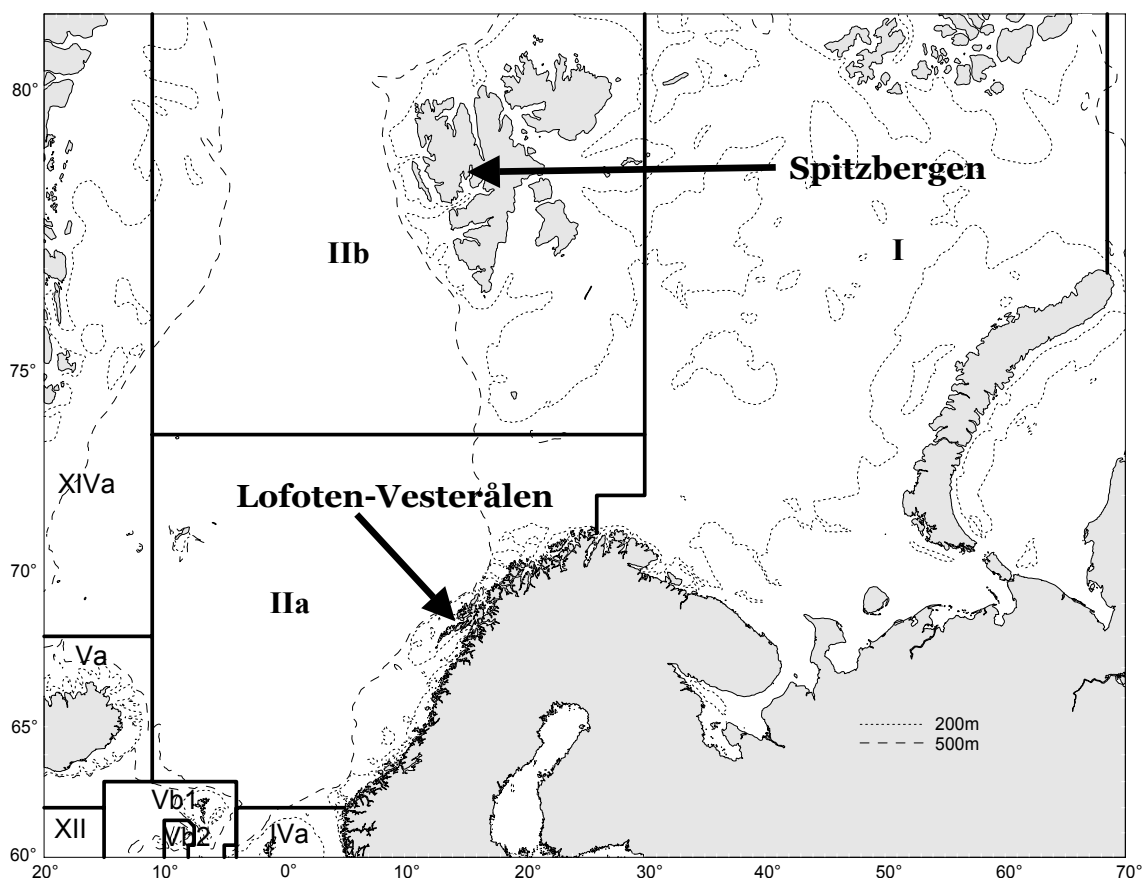

**Figure 1.** Map of model area, ICES areas I (Barents Sea), IIa and IIb (Norwegian Sea). 200m and 500m depth contours are indicated.

A submarine ridge between Scotland and Greenland forms the border between the Norwegian Sea and the North Atlantic. Iceland and the Faroe Islands form part of the ridge while the deepest sills are located in the Faroe Bank Channel (840 m; area Vb) and in the Denmark Strait (620 m). Topographic structures within the Nordic Seas divide the area into three subareas, the Greenland, Iceland and Norwegian Seas.

The Norwegian and Spitzbergen continental shelf borders the Norwegian Sea to the east, from 62°N to north of 80°N. From 62°N to approximately 64°N the shelf is rather narrow and shelf break depths are generally less than 200 m. Further north the shelf break depth is 500-600 m, and from 64°N to the Lofoten peninsula (67°N) the shelf is wider as well. The Barents Sea is a shelf sea where bottom depths are generally less than 300 m.

The hydrographic conditions in the eastern Norwegian Sea were described by Bjørke *et al.* (1999). The surface circulation is constrained by the bathymetry. In general the large scale

circulation is cyclonic with a northward flow of Atlantic and coastal water (7-8°C) in the eastern part of the Norwegian Sea and a southward flow of arctic water along the coast of East Greenland. A branch of the East Greenland current flows into the Norwegian Sea north and east of Iceland as the East Iceland current. In the north-western part of the model area (west of the Spitzbergen shelf) and along the western part of the model area the water is generally cold and arctic (less than 2°C). The coastal water over the Norwegian shelf is generally 7-8°C, with somewhat higher temperatures in summer. Between the coastal water in the east and the arctic water in the west and north, the water in the Norwegian Sea is of Atlantic origin, entering from the south. Typical temperatures for the Atlantic water during summer are 5-7°C.

Atlantic water enters the Barents Sea from the west in the North Cape Current, which divides into a northern and a southern branch. In the northern Barents Sea low-salinity and cold arctic water generally flows from north east to south west. In the west the Atlantic and arctic water

meets in a well defined front held in place by the shallow banks of the region. Over the deeper east basin the front is less definite and a substantial mixing of water masses occurs. Over the Norwegian shelf low-salinity coastal water flows northward, entering the Barents Sea along the Norwegian coast.

### TIME SERIES DATA

The time series data on biomass, catch and fishing mortalities are based on ICES Working Group reports wherever possible. We have used the latest working groups reports available to us at the time of writing, generally for the year 2000. In most cases, biomass data from the working groups have been produced by Virtual Population Analysis (VPA) carried out by the working groups, and represent the situation at the start of the

year. In some cases, catch data from the ICES Fisheries Statistics database has been used when no catch data from working groups were available, or to extend such data.

The time series for biomass and catch are given as tonnes per square kilometer. The values obtained from working groups or other sources have been divided by the area covered by the model (3,116,000 km<sup>2</sup>).

### SPECIES AND SPECIES GROUPS

Thirty functional groups or species were defined for the purpose of this model, ranging from marine mammals to phytoplankton and detritus (Table 2). The diet matrix for the thirty groups is presented in Table 3.

**Table 2.** Basic parameters used to describe the 1997 Ecopath model for the Norwegian Sea and Barents Sea, with 29 functional groups, plus detritus. P/B and Q/B are the production/biomass and consumption/biomass ratios, respectively. Trophic level and values in brackets were estimated by the model.

Group	Biomass (t·km <sup>-2</sup> )	P/B (year <sup>-1</sup> )	Q/B (year <sup>-1</sup> )	Ecotrophic Efficiency	Biomass accumulation (t·km <sup>-1</sup> ·year <sup>-1</sup> )	Trophic level
Toothed whales	0.067	0.06	4.90	(0.000)	0.000	4.2
Baleen whales	0.134	0.03	6.56	(0.249)	0.000	3.9
Seals	0.087	0.07	14.52	(0.042)	0.000	4.0
Seabirds	0.005	1.00	99.29	(0.000)	0.000	4.2
Cod 4+	0.448	1.20	2.50	(0.681)	-0.105	4.2
Cod juveniles	(0.351)	1.00	3.50	0.900	0.000	4.1
Haddock	0.134	1.00	2.80	(0.571)	-0.036	3.2
Saithe	0.181	1.00	5.00	(0.861)	0.016	3.5
Other benthic fish	0.700	1.00	5.00	(0.685)	0.000	3.5
Redfish	0.257	0.35	4.50	(0.895)	0.000	3.4
Blue whiting	0.925	0.60	6.00	(0.341)	0.020	3.4
Mackerel	0.180	0.60	6.00	(0.576)	0.009	3.1
Herring 4+	3.261	0.38	4.47	(0.092)	-0.430	3.2
Herring juveniles	(0.326)	0.80	4.47	0.950	-0.002	3.1
Polar cod	(0.472)	1.50	5.00	0.950	0.000	3.4
Capelin	(1.132)	1.00	5.00	0.950	0.000	3.3
Large pelagic fish	(1.652)	0.50	2.50	0.950	0.000	3.1
Small pelagic fish	(0.068)	1.50	5.50	0.950	0.000	3.6
Mesopel fish	(2.079)	2.00	10.00	0.950	0.000	3.3
Squid	2.632	2.44	12.00	(0.059)	0.000	3.3
Benthos	66.000	1.50	9.75	(0.997)	0.000	2.3
Prawns	0.300	1.25	5.00	(0.851)	0.000	2.9
Krill	47.000	2.50	15.00	(0.217)	0.000	2.3
Amphipods	16.000	2.50	15.00	(0.421)	0.000	2.8
Large zooplankton	(16.882)	4.00	15.00	0.950	0.000	2.2
Small zooplankton	50.000	10.00	25.00	(0.909)	0.000	2.0
Jellyfish	4.000	3.00	10.00	(0.339)	0.000	3.2
Seaweeds	4.400	0.65	-	(0.000)	0.000	1.0
Phytoplankton	15.000	117.73	-	0.950	0.000	1.0



**Table 3.** Diet matrix for the Norwegian Sea-Barents Sea ecosystem model (cont.).

Group	Prey	Predator										
		17	18	19	20	21	22	23	24	25	26	27
1	Toothed whales											
2	Baleen whales											
3	Seals											
4	Seabirds											
5	Cod 4+											
6	Cod juveniles											
7	Haddock											
8	Saithe											
9	Other benthic fish											
10	Redfish											
11	Blue whiting		0.040									
12	Mackerel		0.040									
13	Herring 4+											
14	Herring juveniles		0.020									
15	Polar cod											
16	Capelin		0.020									
17	Large pelagic fish		0.040									
18	Small pelagic fish											
19	Mesopel fish		0.040	0.048	0.077							
20	Squid		0.120									
21	Benthos					0.150	0.250					
22	Prawns		0.040									
23	Krill	0.100	0.200	0.238	0.153							0.044
24	Amphipods	0.100		0.238	0.153							0.044
25	Large zooplankton	0.100	0.200	0.238	0.463	0.030	0.250		0.050			0.100
26	Small zooplankton	0.700	0.200	0.238	0.153	0.030	0.250	0.250	0.700	0.164		0.712
27	Jellyfish		0.040									0.100
28	Seaweeds											
29	Phytoplankton					0.021		0.500		0.736	0.900	
30	Detritus					0.769	0.250	0.250	0.250	0.100	0.100	

## Toothed whales

The toothed whales included in the model are the following four species: White-beaked dolphin (*Lagenorhynchus albirostris*), Harbor porpoise (*Phocoena phocoena*), Killer whale (*Orcinus orca*) and Sperm whale (*Physeter macrocephalus*). The most numerous species in the Barents Sea are believed to be the white-beaked dolphin and harbor porpoise. The available data are summarized in Tables 4 and 5, and the model input data for this group can be found in Table 2.

### White-beaked dolphins (*Lagenorhynchus albirostris*)

Sighting surveys indicate that the population size of white-beaked dolphins may be about 60,000–70,000 animals in the Barents Sea (Øien, 1993). There are no data on the feeding habits of this species (Bogstad *et al.*, 2000). Average body weight is 225 kg (Sigurjonsson and Vikingsson, 1997). With an assumed population size of 65,000, this gives a biomass of 14,625 tonnes. Assuming a Q/B similar to harp seals (Q/B = 15), gives a consumption of 219,000 t·year<sup>-1</sup>.

### Harbor porpoises (*Phocoena phocoena*)

Sighting surveys estimated the abundance of harbor porpoises to be nearly 11,000 animals for the Lofoten-Barents Sea area (Bjørge and Øien, 1995). Diet of harbor porpoises from coastal areas north of Lofoten was estimated from animals captured as by-catch in commercial fisheries (Aarefjord and Bjørge, 1995). The average body weight is set to be 39 kg (Sigurjonsson and Vikingsson, 1997). The biomass is then 429 tonnes, and assuming a Q/B of 15·year<sup>-1</sup> gives a consumption of 6000 t·year<sup>-1</sup>.

### Killer whales (*Orcinus orca*)

The abundance of killer whales was estimated from sightings to be about 7,000 animals in the northern North Sea and the Barents Sea up to Bear Island (NAMMCO, 1998). Killer whales feed almost exclusively on herring in coastal waters off north Norway (Christensen, 1982; Simila *et al.*, 1996). Average body weight was assumed to be

2,350 kg (Sigurjonsson and Vikingsson, 1997), resulting in an estimated biomass of 16,450 tonnes. With an assumed Q/B of 6.0·year<sup>-1</sup> (slightly higher than for minke whales), a consumption of 99,000 t·year<sup>-1</sup> is calculated.

### Sperm whales (*Physeter macrocephalus*)

Christensen *et al.* (1992a) used the 1989 sightings survey to estimate an abundance of 5,231 sperm whales in the Norwegian Sea. Sperm whales were not sighted in the Barents Sea. Sigurjonsson and Vikingsson (1997) used a mean weight of 34,322 kg for sperm whales in Icelandic and adjacent waters, based on Lockyer (1976), and we also use that value here. Sigurjonsson and Vikingsson (1997) also calculated consumption, based on two methods: (a) actual feeding rates of cetaceans in captivity, and (b) energy requirements based on physiological parameters and body weight. Their results correspond to consumption/biomass ratios (Q/B) varying from 1.55 to 2.20·year<sup>-1</sup>. This seems a very low value, even if we account for the large body size, and in our calculations we have used a value of 4.0·year<sup>-1</sup> instead.

Sperm whales occurring at latitudes above 45° N are males, whereas females and immatures remain in family groups in warmer water throughout the year (Martin and Clarke, 1986). Thus, even the males will be outside the model area for certain periods of time. In most areas cephalopods form the bulk of the food, with fish forming a relatively small part. In a few areas the situation is reversed and fish assume a higher importance (Kawakami, 1980; in Martin and Clarke, 1986). Martin and Clarke (1986) studied the diet of sperm whales captured between Iceland and Greenland during the years 1978–1981, and demonstrated that this is one area where fish dominates in the diet. Common species found in the stomachs were lumpfish, redfish, cod and blue whiting, with the lumpfish providing almost half of the total biomass taken by sperm whales in the area. Sigurjonsson and Vikingsson (1997) interpreted their data as showing that fish made up 76% of the stomach content and cephalopods 24%. We have used this as a basis for the diet used in the model.

**Table 4.** Data for major species of toothed whales present in the Norwegian Sea and Barents Sea.

Species	Abundance	Body weight (kg)	Biomass (tonnes)	Q/B	Consumption ('000 tonnes)
White-beaked dolphin	65,000	225	14,625	15.0	219
Harbor porpoise	11,000	39	429	15.0	6
Killer whale	7,000	2,350	16,450	6.0	99
Sperm whale	5,231	34,322	179,538	4.0	718
<b>Totals (mean)</b>	<b>88,231</b>	<b>-</b>	<b>211,042</b>	<b>(4.9)</b>	<b>1,042</b>



**Beluga (*Delphinapterus leucas*)**

White whale or beluga occurs in the Barents Sea, but there is no data on abundance of this species. Capelin, herring and gadoids have been observed

in their diet. This species has not been taken into account for this model.

In 1997 there were no catches of toothed whales from this area. However, catches for other years are included in the time series.

**Table 5.** Diet composition for the toothed whales. Predation by toothed whales in tonnes by species, and total predation in tonnes and by fraction. Note that for white-beaked dolphin and sperm whales, diet compositions are based on Icelandic data.

Prey	Predator				Total	
	White-beaked dolphin	Harbor porpoise	Killer whale	Sperm whale	Tonnes	Fraction
Toothed whales	0	0	0	0	0	0.00
Baleen whales	0	0	0	0	0	0.00
Seals	0	0	0	0	0	0.00
Seabirds	0	0	0	0	0	0.00
Cod 4+	0	0	0	0	0	0.00
Cod juveniles	0	0	0	0	0	0.00
Haddock	0	0	0	0	0	0.00
Saithe	0	1	0	0	1	0.00
Other benthic fish	0	1	0	0	1	0.00
Redfish	0	0	0	144	144	0.14
Blue whiting	0	0	0	287	287	0.28
Mackerel	0	0	0	0	0	0.00
Herring 4+	22	1	99	0	121	0.12
Herring juv.	55	1	0	0	55	0.05
Polar cod	0	0	0	0	0	0.00
Capelin	132	1	0	0	133	0.13
Large pelagic fish	0	0	0	0	0	0.00
Small pelagic fish	0	2	0	0	2	0.00
Mesopelagic fish	0	0	0	0	0	0.00
Squid	0	0	0	172	172	0.17
Benthos	0	0	0	0	0	0.00
Prawns	0	0	0	115	115	0.11
Krill	0	0	0	0	0	0.00
Amphipods	0	0	0	0	0	0.00
Large zooplankton	11	0	0	0	11	0.01
Small zooplankton	0	0	0	0	0	0.00
Jellyfish	0	0	0	0	0	0.00
Seaweeds	0	0	0	0	0	0.00
Phytoplankton	0	0	0	0	0	0.00
Detritus	0	0	0	0	0	0.00
<b>Sum</b>	219	6	99	718	1,042	1.00

## Baleen whales

In the Barents Sea and the Norwegian sea the main baleen whale species is the minke whale (*Balenoptera acutorostrata*). There are also humpback whales (*Megaptera novaeangliae*) and fin whales (*Balaenoptera physalus*) (Christensen *et al.*, 1992a).

### **Minke whales (*Balenoptera acutorostrata*)**

#### *Minke whales in the Barents Sea*

Minke whales migrate into the model area and feed there between mid-April and mid-October (Bogstad *et al.*, 2000). Consumption data for minke whales is based on the consumption from 85,000 individuals (Schweder *et al.*, 1996) during an assumed 180 days feeding period (mid-April to mid-October) in the Barents Sea and in Norwegian coastal waters using data from 1992-1995 (Bogstad *et al.*, 2000). Total consumption was 1,817,000 tonnes. Average body weight of minke whales is 5,251 kg (Sigurjonsson and Vikingsson, 1997). The average biomass for the model area is the product of the abundance and individual weight divided by two, as this group only stays in the model area during the 6 month feeding period. This gives a Q/B of 8.14·year<sup>-1</sup>, which we have used in our calculations.

#### *Minke whales in the Norwegian Sea*

The abundance is obtained from the difference between the total abundance in the Norwegian blocks of the North Atlantic Sighting Survey-95 and the Barents Sea and North Sea estimate (NAMMCO, 1998). The estimate for Norwegian blocks also includes the North Sea block (south of 62°N). This gives an abundance estimate of 13,000 individuals for the Norwegian Sea.

Sigurjonsson and Vikingsson (1997) also calculated consumption for minke whales in Icelandic and adjacent waters. Assuming that baleen whales feed in Icelandic waters for four months each year, and that the daily energy intake during this period was 10 times the daily energy intake during the remaining eight months of the year, their population and consumption data give a Q/B of about 6.3·year<sup>-1</sup>. It is not clear from their publication whether the consumption data refer to the feeding in Icelandic waters only. But if that is the case, and if one also compensates for the absence of minke whales from Icelandic waters for  $\frac{2}{3}$  of the year, the Q/B ratio for that area could be set as high as 18.9·year<sup>-1</sup>. This indicates that the consumption data should be considered as highly uncertain.

At present, data on prey size composition in minke whale stomachs are not available, but will be in the near future (Bogstad *et al.*, 2000). It was assumed that 70% of the consumed cod were from the age 4+ group. It is known that the majority of herring eaten are immature 1-5 years old (Lindstrøm *et al.*, 1999). It is also likely that minke whales feed on adult herring during their southward migrations from the Barents Sea (Folkow *et al.*, 2000). Note that minke whales are opportunistic feeders, and prey will vary significantly in space and time (see Nordøy *et al.*, 1995; Pauly *et al.*, 1998; Bogstad *et al.*, 2000). The diet for minke whales in the model area is summed from the data from the Barents Sea and from the assumed values from the Norwegian Sea.

### **Humpback whales (*Megaptera novaeangliae*)**

It has been suggested that humpback whales stay in their northern feeding areas during most of the year (Ingebrigtsen, 1929). There are about 1,000 humpback whales in the Norwegian and the Barents Sea (Christensen *et al.*, 1992b). This species feeds on capelin in the Barents Sea usually from September to January/February and on krill for the rest of the year (Bogstad *et al.*, 2000). Average body weight is 32 tonnes based on Sigurjonsson and Vikingsson (1997). With a Q/B of 4·year<sup>-1</sup>, this give a total consumption of 127,000 t·year<sup>-1</sup>. According to Sigurjonsson and Vikingsson (1997), data from Canadian waters indicate a diet with 60% fish and 40% crustaceans (probably krill) (Mitchell, 1973, in Sigurjonsson and Vikingsson, 1997).

### **Fin whales (*Balaenoptera physalus*)**

Data on distribution and stock structure do not suggest that the fin whales have a pattern of migration in and out of the model area similar to that of minke whales (Christensen *et al.*, 1992a). The abundance has been estimated to be about 3,000 individuals for the Norwegian and the Barents Sea (NAMMCO, 1998). It does appear that the area defined as 'Iceland' by NAMMCO (1998) overlaps with ICES area IIa (about 10%), and the abundance of fin whales in the area 'Iceland' was 9,867 in 1995. Krill has been reported to be the main food item for fin whales (Johnsgård, 1966). This species also feeds on fish, and in north Norway, capelin dominate the diet in early spring, while in summer crustaceans comprise most of the diet. Some herring is also consumed in summer. The fin whales disappear from the coastal waters in April, probably moving westwards into the Norwegian Sea. In

June/August, they again appear at the coast feeding on krill (Ingebrigtsen, 1929). In recent years it has been suggested that fin whales may be significant predators of herring in the Norwegian Sea (Misund *et al.*, 1997). Average body weight is 42 tonnes (Sigurjonsson and Vikingsson, 1997), giving a total biomass of 127,000 tonnes. With a Q/B of 4·year<sup>-1</sup> (Bonner, 1993, pp. 47) the consumption is 507,000 t·year<sup>-1</sup>. The fraction of the diet made up of fish (only 0.03, based on Icelandic data) used in this calculation may be too low and not reflect that they probably feed on herring in the Norwegian Sea.

### Other baleen whales

Blue whales (*Balaenoptera musculus*), sei whales (*Balaenoptera borealis*) and Greenland right

whales (*Balaena mysticetus*) are known to be pure plankton feeders in this area (Christensen *et al.*, 1992a). Abundance estimates are not available, but numbers are less than for humpback and fin whales.

The baleen whales included in the model are the following three species: minke whale, humpback whale, and fin whale. Data for baleen whales from the model area are summarized in Table 6, and model input data are in Table 2. Diet composition data for baleen whales used in the model are given in Table 3, and are based on Bogstad *et al.* (2000) data from 1992-1995 and the data presented in Table 7. A total of 2,817 tonnes of baleen whales were caught in 1997, which represents 0.000904 t·km<sup>-2</sup> for the model area (Gjert Dingsoer, University of Bergen, Norway).

**Table 6.** Summary data for baleen whales in the study area.

Species	Abundance	Body weight (kg)	Biomass (tonnes)	Q/B	Consumption ('000 tonnes)
Minke whale <sup>a)</sup>	98,000	5,251	257,299	8.14	2,094
Humpback whale	1,000	31,782	31,782	4.00	127
Fin whale	3,000	42,279	126,837	4.00	507
<b>Totals</b>	117,000	-	415,918	6.56	2,728

a) Biomass for minke whale is (Abundance \* Body weight)/ 2, as they only stay in the model area during the half year feeding period.

**Table 7.** Food composition (% weight) of baleen whales in Icelandic and adjacent waters. 'MRI' refers to data from Marine Research Institute, Iceland.

Species	Fish	Crustaceans	Source
Minke whale	59	41	Sigurjonsson and Galan (1991)
Humpback whale	60	40	Mitchell (1973)
Fin whales	3	97	MRI

## Seals

### Harp seal (*Phoca groenlandica*)

The harp seals in the model area are divided into two populations. One breeds in the White Sea (the 'East Ice'), feeds along the ice edge in the Barents Sea, and occasionally migrates south to the Norwegian Coast. The other population breeds on the ice along the east coast of Greenland (the 'West Ice', partly outside the model area), and feeds in the Norwegian Sea. In years with low food abundance, individuals of this population may also migrate to the Norwegian coast.

### Harp seal in the 'East Ice'

Harp seal is the main species of seal in the Barents Sea (Bogstad *et al.*, 2000). At present, data on prey size composition in harp seal stomachs are not available (Bogstad *et al.*, 2000). Consumption is calculated on the basis of an abundance estimate of 2,223,000 individuals (Anon., 1999). Assuming an average body weight of 100 kg (pp. 97 in Haug *et al.*, 1998) this gives a Q/B of 15.7 and 15.16·year<sup>-1</sup> for the periods with low and high capelin biomass, respectively (Bogstad *et al.*, 2000, data from 1990-1996). The prey item groups 'Other fish' (622,000 t) and 'Other crustaceans' (356,000 t) given by Bogstad *et al.* (2000) have been distributed amongst model groups based on working group opinion.

*Harp seal in the 'West Ice'*

In 1998 it was estimated that the abundance was 379,000 individuals (age 1+) and there was a pup production of 67,000 individuals (pp. 37 in Øien, 2000). This gives a biomass of 37,900 tonnes (assuming average body weight of 100 kg), and with a Q/B of 15-year<sup>-1</sup> this gives a consumption of 569,000 t-year<sup>-1</sup>. According to Haug *et al.* (1998), polar cod is an important prey during the summer. During the spring, amphipods and krill are important prey. Generally, there is little knowledge of the diet composition. It was assumed that the population takes half of its consumption (284,000 t) within the model area.

**Harbor seal (*Phoca vitulina*)**

This species is found in coastal areas, where it feeds on herring, cod, saithe, wolffish, flatfishes and sand eels. Abundance in the Norwegian coastal waters is between 2,500 and 6,680 animals (Øien, 2000). Estimates of average body weight are not available, but Markussen *et al.* (1989) reported an asymptotic weight of about 74.8 kg for females and 89.6 kg for males. Taking an average for both sexes and assuming that the average population body weight is 70% of the asymptotic weight (Bonner, 1994) gives an average body weight of 58 kg. Thus, population biomass is approximately 388 tonnes, and with a Q/B of 15-year<sup>-1</sup> this gives a total consumption of 6,000 t-year<sup>-1</sup>.

**Grey seal (*Halichoerus grypus*)**

Grey seals are found in coastal areas, and feed on herring, cod, saithe, wolffish, flatfishes and sand eels. However, they feed more on benthic fish than do harbor seals. Total abundance along the coast is about 4,413 animals (Øien, 2000). Average body weight is 134 kg based on 70% of the adult weight of the range (170-310 kg, males and 105-186 kg, females, given by Bonner, 1994). This gives a population biomass of 590 tonnes,

and with a Q/B of 15-year<sup>-1</sup> gives a consumption of 9,000 t-year<sup>-1</sup>.

**Hooded seal (*Cystophora cristata*)**

Within the model area, the hooded seals breed on the ice east of Greenland (the 'West Ice') and feed in the Norwegian Sea. In 1998 the 'West Ice' abundance of age 1+ was 109,100 individuals and the pup production was 26,300 individuals (Øien, 2000). Average body weight is 262 kg based on 70% of the adult weight of the average range (350 kg females, and 400 kg males) as given by Bonner (1994) and Øien (2000). In areas with ice, polar cod is an important prey (Haug *et al.*, 1998). In the Norwegian Sea, squid (*Gonatus* spp.), redfish (*Sebastes* spp.), blue whiting and Greenland halibut are important prey (Øien, 2000). The biomass was calculated as 28,600 tonnes, and with an assumed Q/B of 10-year<sup>-1</sup> (somewhat lower than in harp seals) this gives a consumption of 286,000 t-year<sup>-1</sup>. It is uncertain how much of the stock is distributed in the Norwegian Sea within the area of interest (ICES area IIa). It was assumed that half the total consumption (143,000 tonnes) was taken within the model area.

**Other seals**

Ringed seal (*Phoca hispida*), bearded seal (*Erignathus barbatus*) and walrus (*Odebenus rosmarus*) are also known to occur in this area (e.g., Bonner, 1994). Abundance estimates are not available, but numbers are thought to be less than for the species mentioned above.

Data for all species of seals are given in Table 8, and the final model input data is in Table 2. The diet composition for seals is given in Table 3, and was based on Table 9. For Harp seal in the Barents Sea the composition of the diet depends on the size of the capelin stock (Nilssen *et al.*, 2000). This model represents the year 1997, when the capelin stock was relatively low, and this is reflected in Table 3.

**Table 8.** Data summary for all species of seals occurring in the model area.

Species	Abundance	Body weight (kg)	Biomass (tonnes)	Q/B	Consumption ('000 tonnes)
Harp seals 'East Ice'	2,223,000	100	222,300	15.70	3,491
Harp seals 'West Ice' <sup>a</sup>	379,000	100	18,950	15.00	284
Harbor seals	2,500-6,684	58	388	15.00	6
Grey seals	4,413	134	591	15.00	9
Hooded seal	109,000	262	28,558	10.00	143
<b>Total</b>	<b>2,722,097</b>	<b>-</b>	<b>270,787</b>	<b>14.52</b>	<b>3,933</b>

<sup>a</sup>It is assumed that the harp seals in the West Ice stay in the model area for half the year – hence the mean biomass during the year is half the total biomass of the stock.

**Table 9.** Diet composition for seals in the Norwegian Sea and Barents Sea.

Prey	Harp seals 'East Ice'	Harp seals 'West Ice'	Harbor seals	Grey seals	Hooded seals	Total (‘000 tonnes)	Fraction
Toothed whales						0	0.00
Baleen whales						0	0.00
Seals						0	0.00
Seabirds						0	0.00
Cod 4+	149			1.0		150	0.04
Cod juveniles	149			1.0		150	0.04
Haddock	47			1.0		48	0.01
Saithe	20		1.7	1.0		23	0.01
Other benth fish	50			4.9		55	0.01
Redfish	50				36	86	0.02
Blue whiting	50				36	86	0.02
Mackerel						0	0.00
Herring 4+						0	0.00
Herring juv	394		1.5			395	0.10
Polar cod	880	85	0.6			966	0.25
Capelin	55	28	1.7			85	0.02
Large pel fish	50					50	0.01
Small pel fish	150	28			14	193	0.05
Mesopel fish	178					178	0.05
Squid	59				57	116	0.03
Benthos	156					156	0.04
Prawns	200					200	0.05
Krill	550	57	0.3			607	0.15
Amphipods	304	85				389	0.10
Large zoopl						0	0.00
Small zoopl						0	0.00
Jellyfish						0	0.00
Seaweeds						0	0.00
Phytoplankton						0	0.00
Detritus						0	0.00
<b>Totals</b>	<b>3,491</b>	<b>284</b>	<b>5.8</b>	<b>8.9</b>	<b>143</b>	<b>3,933</b>	<b>1.00</b>

The catch of seals for 1997 was reported as 0.000261 t·km<sup>-2</sup>, which equates to 813 tons for the total model area (K. Kaschner, Marine Mammal Unit, Fisheries Centre, University of British Columbia, pers. comm.).

### ***P/B values for marine mammal groups***

Estimates of natural mortality for marine mammals are difficult to obtain. In the present model P/B values used for marine mammals were based on consensus expert opinion of total mortality (Z) estimates obtained from scientists in the Institute of Marine Research, Bergen. Future re-evaluations of the model input data

should especially re-examine mortality rates for seals.

### **Sea birds**

#### **Seabirds (Barents Sea)**

It is estimated that 5,400,000 pairs of seabirds are breeding in the Barents Sea (Anon., 2000a). Consumption in the Barents Sea (ICES area I and the eastern part of areas IIa and IIb) was estimated at 1,000,000 t·year<sup>-1</sup>, with approximately 480,000 tonnes of this being fish and the rest being invertebrates (Anon., 2000a).

The common guillemot (*Uria algae*) accounts for about 10% of the consumption, and this species eats mainly capelin. The Brünnich's guillemot (*Uria lomvia*) accounts for 61% of the fatty fish and 56% of the invertebrates consumed. This species has a much lower proportion of capelin in the diet than *Uria algae*. The total consumption of capelin by these two species has been assumed to be in the order of 200,000 to 300,000 t-year<sup>-1</sup> (Gjøsæter, 1998). Polar cod and pelagic crustaceans are also important prey species for several species of birds (Mehlum and Gabrielsen, 1995). The Q/B ratio was calculated so as to reflect that some birds were present only part of the year in the Barents Sea.

### Seabirds (Norwegian coast / Norwegian Sea)

Puffins (*Fratercula arctica*) are numerous, and breed along the Norwegian coast. They are known to feed on small pelagic fish (e.g., herring and sand eel) and o-group pelagic gadoids. The total number of puffins and other sea birds (except for cormorants and shags) breeding along the Norwegian coast are estimated to be about 10,000,000 individuals (Anon., 2000a). The consumption from cormorants and shags are

included in the estimate for consumption both for the Barents Sea and for the Norwegian Sea.

The diet composition is uncertain and has been estimated for the Barents Sea as well as for the Norwegian coast and the Norwegian Sea. However, we have tried to use the information given in Anon. (2000a). The ICES report points out that the consumption estimate does not include “the very large but unknown number of fulmars that are spread over most of the area throughout the year”. In addition, an unknown but similarly very large, number of little auks from the Barents Sea spend the winter in the Norwegian Sea. As well, the estimate “does not include the large numbers of seabirds which breed on Shetland and Faroe Islands, many of which probably also forage in the Norwegian Sea a large part of the year” (Anon., 2000a). This means that the estimates for the Norwegian Sea are most likely underestimated.

The biological data for seabirds are summarized in Table 10, and the model input data is found in Table 2. The diet composition for Barents Sea and Norwegian Sea are in Tables 11 and 12, respectively, while the model diet compositions are in Table 3.

**Table 11.** Diet composition and consumption data for seabirds in the Barents Sea. Source: Anon. (2000).

Species	Body weight (g)	Abundance	Biomass (tonnes)	Consumption (t-year <sup>-1</sup> )			Sum
				Fat fish	Other fish	Invertebrates	
Northern fulmar	820	1,650,000	1,353	0	41,518	107,638	149,156
Northern gannet	3,204	4,950	16	865	0	0	865
Great cormorant	3,250	13,000	42	896	1,344	299	2,539
Shag	1,836	15,600	29	882	1,058	0	1,940
Great skua	1,400	780	1	0	7	0	7
Arctic skua	350	15,600	5	135	0	0	135
Mew gull	380	52,000	20	0	499	740	1,239
Herring gull	1,000	260,000	260	0	11,999	8,888	20,887
Lesser black-backed gull	800	1,300	1	0	22	0	22
Great black-backed gull	1,680	65,000	109	3,103	2,979	0	6,082
Glacous gull	1,800	31,200	56	0	326	362	688
Black-legged kittiwake	409	2,210,000	904	73,130	0	10,834	83,964
Common tern	125	2,600	0	0	26	0	26
Arctic tern	110	130,000	14	0	589	654	1,243
Razorbill	711	66,000	47	3,465	0	0	3,465
Common guillemot	1,028	396,000	407	33,354	0	0	33,354
Brünnich guillemot	998	5,940,000	5,928	293,658	0	261,029	554,687
Black guillemot	410	130,000	53	2,727	0	5,453	8,180
Atlantic puffin	480	1,650,000	792	63,757	0	0	63,757
Little auk	160	4,290,000	686	5,838	0	70,053	75,891
<b>Total</b>	-	16,924,030	10,725	481,810	60,367	465,950	1,008,127

**Table 10.** Data summary for seabirds in the Norwegian Sea and Barents Sea.

Area	Abundance	Body weight (kg)	Biomass (tonnes)	Q/B	Consumption ('000 tonnes)
Barents Sea	16,924,030	0.63	10,725	93.99	1,008
Norwegian Sea	10,774,015	0.50	5,390	109.83	592
<b>Totals</b>	27,698,045	-	16,115	99.29	1,600

**Table 12.** Diet composition and consumption data for seabirds in the Norwegian Sea. Source ICES (2000).

Species	Body weight (g)	Abundance	Biomass (tonnes)	Consumption (tonnes)			Sum
				Fat fish	Other fish	Invertebrates	
Northern fulmar (residents)	810	24,750	20	0	618	1,601	2,219
Northern fulmar (visitors)	810	2,000,000	1,620	0	47,557	123,295	170,852
European storm petrel	24	16,500	0	0	0	91	91
Leach's storm petrel	42	1,650	0	0	0	14	14
Northern gannet	3,204	7,425	24	1,297	0	0	1,297
Great cormorant	3,250	54,000	176	10,326	0	3,442	13,768
Shag	1,836	45,000	83	1,056	5,915	939	7,910
Great skua	1,400	90	0	0	1	0	1
Arctic skua	350	18,000	6	148	0	0	148
Common gull	380	270,000	103	0	2,850	4,222	7,072
Herring gull	1,000	45,000	45	0	3,206	2,375	5,581
Lesser black-backed gull	800	6,300	5	0	102	0	102
Great black-backed gull	1,680	117,000	197	8,570	8,227	0	16,797
Black-legged kittiwake	409	585,000	239	0	19,873	5,520	25,393
Common tern	125	10,800	1	76	0	11	87
Arctic tern	110	90,000	10	0	769	0	769
Razorbill	711	49,500	35	2,870	0	0	2,870
Common guillemot	1,028	16,500	17	1,385	0	0	1,385
Black guillemot	410	54,000	22	1,195	1,753	0	2,948
Atlantic puffin	460	5,362,500	2,467	36,376	266,399	0	302,775
Little auk	160	2,000,000	320	0	8,443	21,890	30,333
<b>Total</b>	-	10,774,015	5,390	63,299	365,713	163,400	592,412

### Cod 4+ (*Gadus morhua*)

Within the model area there is one large stock of cod, the North East Arctic Cod (also called Barents Sea cod). In addition there is a smaller stock, the Norwegian Coastal Cod, and possibly other and still smaller stocks.

The North East Arctic Cod spawns along the Norwegian Coast from 62° N and northwards, with the main spawning at Lofoten - Vesterålen (67°-69° N). Eggs and larvae drift into the Barents Sea, and the juveniles feed there until they mature at an age of 6-7 years. Maturing cod migrate to the Norwegian coast to spawn, and back to the Barents Sea after spawning. Recruitment to the fishery starts at age 3.

The Norwegian Coastal Cod (which may consist of several stocks) has only in recent years been subject to research, and little is known about stock sizes as yet. It is also difficult to differentiate the catches of this stock from those of North East Arctic Cod - although landings in some statistical areas in specific months are recorded as being Norwegian Coastal Cod. In the present model, all catches of cod are treated as one unit.

As there is a considerable amount of cannibalism by large cod upon smaller cod, this species is split in two groups for modeling: Cod 4+ years and Cod juveniles (1-3 years).

The ICES Arctic Fisheries Working Group (Anon., 2001a) gives a time series of biomass by age for ages 3-13+, calculated by VPA, which includes the years 1950-1997. The biomass of Cod 4+ for 1997 has been calculated as the sum of the biomasses for ages 4-13+ in 1997, and divided by the model area (3,116,000 km<sup>2</sup>) gives a biomass of 0.448 t·km<sup>-2</sup> (Table 2). The biomass for 1998 has been calculated in the same way to 0.344 t·km<sup>-2</sup>, and the biomass accumulation is 0.104 t·km<sup>-2</sup> (Table 2).

Bogstad *et al.* (2000) give biomass and consumption for cod in the Barents Sea for the years 1984-1989. The Q/B ratios calculated from these data vary from 3.118 to 1.644·year<sup>-1</sup>, with a mean of

2.433·year<sup>-1</sup>. These figures do not include consumption by mature cod in the period when they are outside the Barents Sea, which, according to Bogstad *et al.*, may be significant. The Q/B ratio used (Table 2) should therefore be considered a minimum value.

Bogstad *et al.* (2000) give the diet composition for the years 1984-1998 for cod in the Barents Sea, with averages for the years 1991-1993 when the capelin stock was high, and for the years 1994-1996 when the capelin stock was low. The consumption data are summarized in Table 13. During 1997, the capelin stock was low (Anon, 2000b; Bogstad *et al.*, 2000), and the average diet for 1994-1996 has been used as a basis for the diet composition for Cod 4+ in the model (Table 3).

The ICES Arctic Fisheries Working Group (Anon, 2001a) gives a time series of biomass for ages 3-13+ calculated by VPA, as well as catch in numbers by age and weight in catch by age, for a period which includes the years 1950-1997. Using the data from Anon. (2001a), biomass for each of the years 1950-1997 has been calculated as the sum of the biomasses for ages 4-13+.

Catch for each age for the years 1950-1997 has been calculated as the product of catch in numbers by age and weight in catch for that age, whereupon the catches for ages 4-13+ were summed to give catch for that year.

**Table 13.** Diet composition of cod 4+ for the Barents Sea.

Prey	High capelin stock years Average for 1991-1993		Low capelin stock Average for 1994-1996	
	Fraction	'000 tonnes	Fraction	'000 tonnes
Amphipods	0.027	141	0.163	732
Krill	0.061	318	0.180	808
Shrimp	0.056	294	0.093	416
Capelin	0.538	2,805	0.171	769
Herring	0.032	168	0.023	104
Polar cod	0.025	129	0.072	322
Cod	0.023	122	0.088	393
Haddock	0.013	66	0.018	79
Redfish	0.038	199	0.028	124
Greenland halibut	0.000	10	0.000	0
Others	0.185	967	0.165	742
<b>Total</b>	-	5,219	-	4,491



### **Cod juveniles (1-3 years)**

According to the ICES Arctic Fisheries Working Group (Anon., 2001a), biomass for 3 year old cod in 1997 was 146,245 tonnes, corresponding to 0.047 t·km<sup>-2</sup>. Biomass for 1 and 2 year old cod is not known. Mortality rates for juvenile cod are uncertain, and back-calculation from 3 years to younger ages would also be uncertain. We therefore let Ecopath calculate the biomass, using an ecotrophic efficiency of 0.9 (Table 2).

For 1997, the Working Group report (Anon., 2001a) gives  $M=0.5\cdot\text{year}^{-1}$  and  $M=0.3\cdot\text{year}^{-1}$ , as well as  $F=0.02$  and  $F=0.2$  for 3 and 4 year old cod, respectively. Based on this, we estimated a production/biomass ratio of  $1.0\cdot\text{year}^{-1}$  for juvenile cod (Table 2). The Q/B ratio was also estimated at  $3.5\cdot\text{year}^{-1}$  (Table 2). The diet composition was based on Bogstad *et al.* (2000) and on the expert opinions of model working group participants.

### **Haddock (*Melanogrammus aeglefinus*)**

Haddock is distributed along the coast of Norway from 62° N northwards, and into the Barents Sea. They mature at an age of 4-7 years, and the spawning area is along the continental slope from approximately 66° N to approx. 74° N (Torsvik *et al.*, 1995).

Biomass and catch for haddock (3+ years) are given in Anon. (2001a), who presents time series back to 1950. Bogstad *et al.* (2000) give stock size for 1+ haddock for the years 1984-1998, based on the VPA in Anon. (2001a), and  $M = 0.2$  per year. According to their calculations, the biomass of 1+ haddock in 1997 was 416,000 tonnes, corresponding to 0.134 t·km<sup>-2</sup> (Table 2). In 1998, the biomass of 1+ haddock was 293,000 tonnes, corresponding to 0.094 t·km<sup>-2</sup>. Therefore, biomass accumulation of haddock was 0.036 t·km<sup>-2</sup> (Table 2).

Fishing pressure on haddock is lower than for cod (Anon., 2001a), but the group 'haddock' includes all 1+ fish, while cod was split in juveniles and 4+ fish. Estimating the production/biomass ratio for haddock as  $1.0\text{ year}^{-1}$  appears reasonable (Table 2). It is likely that the consumption/biomass ratio for cod and haddock of the same size is similar, and a value for haddock that is in between those for Cod juveniles (3.500) and Cod 4+ (2.500) seems reasonable. The value was estimated to  $2.8\cdot\text{year}^{-1}$  (Table 2).

Diet composition is estimated to be mostly benthos organisms, and some large zooplankton

(Table 3). Jiang and Jørgensen (1996) described the food composition of haddock in the Barents Sea on a quarterly basis during the years 1984-1991. Crustaceans and echinoderms were important food items, followed in importance by fish, molluscs and annelids. There was considerable variation between years and seasons, and the authors warned that the precision of data from this kind of investigations is low.

The ICES Arctic Fisheries Working Group (Anon., 2001a) ran a VPA for ages 3-13+ for the years 1950-1999. The stock summary table in Anon. (2001a) gives total biomass and landings for each of the years 1950-1999, and we have used these data as the basis for our time series for biomass and catch. We have made no attempt to estimate data for 1-3 year old haddock.

### **Saithe (*Pollachius virens*)**

Saithe is found along the Norwegian coast and on the continental shelf from approximately 62° N to the border with Russia. Spawning takes place on the shelf from 62° N to 69° N (Torsvik *et al.*, 1995).

Biomass and catch for saithe 2+ back to 1960 were taken from the ICES Arctic Fisheries Working Group report (Anon., 2001a). Data for age 1 saithe are not given. Biomass of the stock in 1997 was 564,750 tonnes, corresponding to 0.181 t·km<sup>-2</sup> (Table 2). Biomass in 1998 was 612,836 tonnes, corresponding to 0.197 t·km<sup>-2</sup>. The biomass accumulation was therefore 0.016 t·km<sup>-2</sup> (Table 2).

Production/biomass ratio and consumption/biomass ratio were estimated as  $1.0\cdot\text{year}^{-1}$  and  $5.0\cdot\text{year}^{-1}$ , respectively (Table 2). Diet composition was based on Robb and Hislop (1980) and Robb (1981), with pelagic fish and zooplankton as the most important prey (Table 3).

The ICES Arctic Fisheries Working Group (Anon., 2001a) ran a VPA for ages 2-11+ for the years 1960-1999. The stock summary table calculated by the VPA program (Anon., 2001a) gives total biomass and landings for each of the years 1960-1999, and we have used these data as the basis for our time series for the years 1960-1997. Fishing mortality for those years has been calculated as the ratio catch/biomass.

The ICES Fisheries Statistics database gives catches for the years 1950-1959, and these catches

have been used to supplement the catches given by Anon. (2001a), in order to extend the time series for catches back to 1950. Noting that the ratio of catch to biomass (C/B) for the years 1960-69, while varying from 0.10 to 0.22, has no clear trend, we have calculated the mean C/B for these years to be 0.164 year<sup>-1</sup>. We then used this value to represent the C/B ratio for the years 1950-1959. Having thus established a C/B ratio for the 1950s, we have calculated biomass densities for those years using equation (1):

$$B = \frac{C}{(C/B)} \quad \dots 1)$$

We have made no attempt to estimate time series data for 1-2 years old saithe.

### Other benthic fish

The group 'Other benthic fish' has been used to represent all benthic fish not already included in one of the other groups. Species of major fisheries importance in this group include: Atlantic halibut (*Hippoglossus hippoglossus*), Greenland halibut (*Reinhardtius hippoglossoides*), European plaice (*Pleuronectes platessus*), long rough dab (*Hippoglossoides platessoides*), monkfish (*Lophius piscatorius*), wolffishes (*Anarhichas* spp.), pollack (*Pollachius pollachius*), whiting (*Merlangius merlangus*), ling (*Molva molva*), blue ling (*M. dypterygia*), cusk (*Brosme brosme*) and skates (*Raja* spp.). Apart from catch statistics, parameters for this group can only be assumed, which is reflected in the input to the model (Table 2). The biomass density used (0.700 t·km<sup>-2</sup>) is fairly high, and the diet composition is spread over a wide range of groups (Table 3), which is reasonable when the predator group itself is so diverse.

A time series for catch of this group was prepared for the years 1973-1997 from the ICES Fisheries Statistics database. We have tried to include in the catch statistics of this group all species of benthic fish which are important in the fishery and which are not already included in one of the other groups.

### Redfish (*Sebastes* spp.)

There are three species of redfish in the model area, *Sebastes marinus*, *S. mentella* and *S. viviparus*. There are some differences in the distribution area and depth preferences of these species, but in general 'redfish' are found on the

continental shelf (also to some extent in the Barents Sea), along the continental slope, and westwards from the slope as pelagics (Torsvik *et al.*, 1995).

*Sebastes marinus* and *S. mentella* are the main species targeted by the fishery. The last analytical assessment of *S. mentella* in the model area was done by the ICES Arctic Fisheries Working Group in 1997 (Anon., 1998). They calculated that the biomass of age 6+ *S. mentella* was 233,938 tonnes in 1996. There is no analytical assessment available for the two other species, and it is assumed that the total biomass of all three species of redfish, including the younger ages, is 800,000 tonnes, corresponding to 0.257 t·km<sup>-2</sup> (Table 2). Production/biomass and consumption/biomass ratios (Table 2) were taken from the Icelandic model (Mendy and Buchary *et al.*, this volume).

The diet composition used in the model was estimated (Table 3), and consists mainly of large and small zooplankton, krill and benthos (see also Hureau and Litvinenko, 1986).

The ICES Arctic Fisheries Working Group in 1997 (Anon., 1998) carried out an analytical assessment for *Sebastes mentella*, and the stock summary table calculated by the VPA program (for ages 1-19+) gives a time series of stock biomass and landings for the years 1965-1996. However, there are no corresponding data for the other redfish species, and a time series of biomass for the complete group 'redfish' is therefore not available. However, a time series of catch data for 'redfish' for the years 1950-1997 is available from the ICES Fisheries Statistics database and has been used.

### Blue Whiting (*Micromesistius poutassou*)

There is possibly more than one stock of Blue Whiting in the model area. However, the ICES Northern Pelagic and Blue Whiting Fisheries Working Group treats all Blue Whiting in the North East Atlantic north of Gibraltar as one stock (Anon., 2000b). This stock has its main spawning area west of the British Isles, but there seems to be at least one smaller spawning area within the model area, west of the Norwegian continental slope at about 67° N. At least part of the juveniles grow up in the North Sea, and a large part of the stock feeds in the Norwegian Sea during summer, but migrates to the south of the model area for spawning.

The ICES Northern Pelagic and Blue Whiting Fisheries Working Group (Anon., 2000b)

calculated the 1997 stock biomass (0-10+ years) of Blue Whiting as 5,763,250 tonnes, corresponding to 1.850 t·km<sup>-2</sup>. Only 2+ year fish will be in the Norwegian Sea, and the spawning stock will be out of the model area during the migration to and from the spawning area. To compensate for this, it is assumed that 50% of the biomass of blue whiting is found in the model area, giving a value of 0.925 t·km<sup>-2</sup> for the biomass density (Table 2). The stock biomass in 1998 was calculated to 5,889,000 tonnes, and assuming that 50% of the biomass is found in the model area, this corresponds to 0.945 t·km<sup>-2</sup> in 1998. Hence, a biomass accumulation of 0.020 t·km<sup>-2</sup> was estimated (Table 2). Production/biomass and consumption/biomass ratios were based on working group opinion (Table 2).

Timokhina (1974) presented approximate diet composition for blue whiting, showing that the main food items are euphausiids and copepods, with a small proportion of amphipods and chaetognaths. This data formed the basis for the model diet composition for this species (Table 3).

The ICES Northern Pelagic and Blue Whiting Fisheries Working Group (Anon., 2000b) has a Stock Summary table for blue whiting that gives stock biomass for the years 1981-1999. This table has been used as a basis for the time series of biomass density for those years, assuming that 50% of the biomass is found within the model area. Most of the catches of blue whiting are taken outside the model area, west of the British Isles (spawning fish) or in the North Sea (juveniles). The time series of catches for the years 1950-1979 used here comes from the ICES Fisheries Statistics database and only includes catches within the model area.

### **Mackerel (*Scomber scombrus*)**

Mackerel are common in the model area from the south and into the western part of the Barents Sea, and comes from the western mackerel stock which spawns west of the Ireland. Part of the stock migrates into the Norwegian Sea during summer to feed, but moves to the south of the model area for spawning. In the model, the main food items are zooplankton, krill and pelagic fish (Table 3).

The ICES Working Group on the Assessment of Mackerel, Horse Mackerel, Sardine and Anchovy (Anon., 2001b) assessed the stock of the North East Atlantic Mackerel stocks (ages 0-12+) for the years 1984-1998. The total biomass in 1997 was

calculated as 4,474,264 tonnes, corresponding to 1.436 t·km<sup>-2</sup>. However, mackerel are found within the model area only for part of the year, and then it is only part of the stock that feeds in the area. It is assumed that 25% of the stock feeds in the Norwegian Sea during the summer season (6 months). Consequently, 12.5% of the biomass (0.180 t·km<sup>-2</sup>, Table 2) was allocated to the model area. The total biomass in 1998 was 4,732,194 tonnes, and allocating 12.5% of the biomass to the model area gives 0.189 t·km<sup>-2</sup>. Hence, a biomass accumulation of 0.009 t·km<sup>-2</sup> was estimated (Table 2).

The ICES Working Group on the Assessment of Mackerel, Horse Mackerel, Sardine and Anchovy (Anon., 2001b) has a Stock Summary table for mackerel that gives biomasses for the years 1981-1997. This table has been used as a basis to calculate a time series of biomass density, assuming that 12.5% of the biomass is found within the model area. Most of the catches of mackerel are taken outside the model area. The time series of catch data used here is based on the ICES Fisheries Statistics database and only includes catches within the model area.

### **Large pelagic fish**

The pelagic species that are not specifically named were split into two groups, smaller and larger than approximately 50 cm, in order to make it easier to estimate the diet composition. The species of large pelagics of major fisheries interest include: porbeagle (*Lamna nasus*), basking shark (*Cetorhinus maximus*), Greenland shark (*Somniosus microcephalus*), spiny dogfish (*Squalus acanthius*), Northern bluefin tuna (*Thunnus thunnus*), hake (*Merluccius merluccius*) and Atlantic salmon (*Salmo salar*).

We have let the model calculate the biomass of the group of large pelagic fish, using an ecotrophic efficiency of 0.950 (Table 2). Consumption/biomass has been set at 2.500·year<sup>-1</sup> and a total mortality rate of 0.5·year<sup>-1</sup> was assumed (Table 2). The food items for this group has been estimated through expert opinion during the workshop, and covers a large number of items, from fish like mackerel and blue whiting to zooplankton (Table 3).

A time series for catch of this group was prepared for the years 1973-1997 from the ICES Fisheries Statistics database. We have included all species of large pelagic fish (larger than approximately 50 cm) which are important in the fishery and which

are not already included in one of the other groups.

### Small pelagic fish

This group consists of pelagic fishes smaller than 50 cm. Species in this group that are of commercial importance include: Atlantic eel (*Anguilla anguilla*), sprat (*Sprattus sprattus*), greater argentine (*Argentina silus*), Norway pout (*Trisopterus esmarckii*), horse mackerel (*Trachurus trachurus*) and lumpsucker (*Cyclopterus lumpus*).

We have let the model calculate the biomass of small pelagic fish, using an ecotrophic efficiency of 0.950 (Table 2). Consumption/biomass has been set at 5.000 and production/biomass to 1.500 (Table 2).

The diet is assumed to be krill, amphipods and other zooplankton (Table 3).

A time series for catch of this group was prepared for the years 1973-1997 from the ICES Fisheries Statistics database. Included are all species of small pelagic fish (smaller than approximately 50 cm) which are important in the fishery and which are not already included in one of the other groups.

### Herring 4+ (*Clupea harengus*)

During their first 3 years of life, young herring of the Norwegian Spring Spawning Herring stock feed in the Barents Sea and in Norwegian fjords (Devold, 1963; Dragesund *et al.*, 1980). In the summer of their third year they migrate out of the Barents Sea and into the Norwegian Sea. These immature herring feed mostly in the eastern part of the Norwegian Sea on or near the continental shelf, while older and larger herring tend to feed further west (Anon., 1995, 1996; Vilhjalmsson *et al.*, 1997; Holst *et al.*, 1998, 1999). Most of the herring mature as 5 years old fish, and they spawn in February-April on the shelf along the Norwegian coast, from Lindesnes (58°N, 7°E) in the south to Vesterålen (69°N, 15°E) in the north (e. g. Slotte and Dommasnes, 1998). After spawning, adults migrate into the Norwegian Sea and feed from April to September (Anon., 1995, 1996; Vilhjalmsson *et al.*, 1997; Holst *et al.*, 1998). The exception to this pattern occurred from 1970-1990 when the stock was very small, and fed along the Norwegian coast (Anon., 1979, 1982, 1986, 1991; Dragesund *et al.*, 1997). From October until the spawning migration starts in

January the herring stay in deep water. In the period 1950-1969 they over-wintered in the Norwegian Sea. During the years from 1970 until the late 1980s the stock was split in two components which over-wintered in western Norway and in Lofoten, respectively. Since 1987 the herring has over-wintered in the Vestfjord fjord system (North of Lofoten) (Dommasnes *et al.*, 1994).

As the young herring ('juveniles' 1-3 years old) are found in a different area from the older ones (4 years and older), the herring has been split into two groups in the model.

Biomass and catch data for Norwegian Spring Spawning herring for ages 0-15+ back to 1950 were taken from the VPA tables in the annual reports from the ICES Northern Pelagic and Blue Whiting Fisheries Working Group (Anon., 2000b). Based on data in this Working Group report, the biomass of 4-16+ herring in 1997 was 10,161,650 tonnes, corresponding to 3.261 t·km<sup>-2</sup> (Table 2). By 1998 the biomass of 4-16+ herring was calculated to 8,820,590 tonnes, corresponding to 2.831 t·km<sup>-2</sup>. Thus, biomass accumulation during 1997 was -0.430 t·km<sup>-2</sup> (Table 2).

Fishing mortality for 5-16+ herring is given as 0.23 and the natural mortality as 0.15, giving a total instantaneous mortality of 0.38·year<sup>-1</sup> (Anon., 2000b). If this is assumed to be valid also for 4 years old herring, this gives a production/biomass ratio of 0.38·year<sup>-1</sup> for the part of the stock that is in the Norwegian Sea (Table 2).

According to Palomares and Pauly (1989) the following formula can be utilized to estimate the consumption/biomass ratio:

$$Q/B = 3.06 * W_{\infty}^{-0.2018} * T_c^{0.6121} * A_r^{0.5156} * 3.53^{H_d} \quad \dots 2)$$

where:

$W_{\infty}$  = the asymptotic weight (in g) as defined by the von Bertalanffy equation;

$T_c$  = the mean habitat temperature in °C;

$A_r$  = the aspect ratio for the caudal fin (see Pauly, 1989);

$H_d$  = the food type (0 for carnivores and 1 for herbivores and detritivores).

Analysis of age-length data at the Institute of Marine Research (A. Dommasnes, unpublished data) gives  $L_{\infty} = 36.7$  cm. The corresponding weight is approximately 330 g (Slotte, 1998). The habitat temperature varies from year to year,

particularly in the feeding areas (Anon., 1995, 1996; Vilhjalmsen *et al.*, 1997; Holst *et al.*, 1998, 1999), but an acceptable average is 6.0° C. Pauly (1989) gives a value of  $A_r = 1.9$  for herring from Georges Bank and Scotland. That value is also used here.

Pauly *et al.* (1990) give an alternative formula for calculating the consumption/biomass ratio:

$$Q/B = 10^{6.37} * 0.0313^{T_k} * W_c^{-0.168} * X * 1.38^{P_f} * 1.89^{H_d} \dots (3)$$

where:

$T_k$  = an expression for mean annual temperature,  $T_k = 1000 / (\text{temperature} + 273.1)$ ;

$P_f = 1$  for apex or pelagic predators and/or zooplankton feeders.

Formulas (2) and (3) give consumption/biomass ratios of 3.96 and 4.97 respectively. The mean of these, 4.47, is used in the present model (Table 2). It should be noted that according to Pavshikov and Timokhina (1972) one tonne of herring consumes, on average, 6-8 tonnes of plankton per year. The value used for Q/B in the model may therefore be rather low.

Diet composition for herring in the Norwegian Sea has been investigated by Dalpadado *et al.* (2000) and is summarized in Table 14. Krill and copepods were dominant food items, amphipods were also important in the autumn, and the stomach samples also contained some other zooplankton and some fish larvae (Table 3).

The ICES Northern Pelagic and Blue Whiting Fisheries Working Group (Anon., 2000b) gives a time series of biomass for ages 0-16+ calculated by VPA, as well as catch in numbers by age and weight in catch by age, for the years 1950-1999. Using the data from Anon. (2000b), biomass for each of the years 1950-1997 has been calculated as the sum of the biomasses for ages 4-16+. Catch for each age has been calculated as the product of catch in numbers by age and weight in catch for

that age, whereupon the catches for ages 4-16+ were summed to give catch for that year. Fishing mortality time series has been calculated as the ratio catch/biomass.

### Herring juveniles

Herring juveniles are 1-3 years old herring, living mainly in the Barents Sea.

The VPA tables in the annual reports from the ICES Northern Pelagic and Blue Whiting Fisheries Working Group (ICES, 2000b) give biomass for 1-3 years old herring of 979,560 tonnes, corresponding to 0.275 t·km<sup>-2</sup>. By 1998 the corresponding value was 973,570 tonnes, corresponding to 0.275 t·km<sup>-2</sup>, and the biomass accumulation during 1997 was -0.002 t·km<sup>-2</sup>. Upon balancing the model, however, it was noted that a biomass of 0.275 was too low to satisfy the demand for herring juveniles as prey. Thus, Ecopath estimated a biomass of 0.323 t·km<sup>-2</sup> using an ecotrophic efficiency of 0.950 (Table 2).

A production/biomass ratio of 0.8·year<sup>-1</sup> was assumed based on expert opinion (Table 2). The ICES Working Group report uses  $M=0.9$ ·year<sup>-1</sup> for ages 0-2, and  $M=0.15$ ·year<sup>-1</sup> for older ages (Anon., 2000b). The consumption/biomass ratio was set at 4.470·year<sup>-1</sup>, as for the older herring (Table 2).

An investigation by Huse and Toresen (1996) on the feeding habits of herring and capelin in the Barents Sea in 1992 and 1993 showed that copepods and krill were the most important prey items, accounting for over 80% of the diet. The diet composition used in the model is given in Table 3.

Using VPA data Anon. (2000b), biomasses for the years 1950-1997 have been calculated as the sum of the biomasses for ages 1-3. Catch for each age has been calculated as the sum of the product of catch in numbers by age and weight in catch for that age. Fishing mortality time series has been calculated as the ratio catch/biomass.

**Table 14.** Diet fraction for herring in the Norwegian Sea, based on Dalpadado *et al.* (2000).

Fish larvae	Copepods	Amphipods	Krill	Other zooplankton
0.1	0.4	0.05	0.4	0.05

### **Polar cod (*Boreogadus saida*)**

Polar cod is an important stock in the Barents Sea, but is also found to a smaller extent in the northern and western part of the Norwegian Sea. Only the stock in the Barents Sea is taken into account in the model.

An acoustic estimate in the Barents Sea in September-October 1997 gave a total stock biomass of 400,700 tonnes (Anon., 2000), corresponding to 0.129 t·km<sup>-2</sup> for the whole model area. Upon balancing the model, the initial biomass estimate based on the acoustic survey was too low to sustain the demands for polar cod as prey. Thus, we let the model calculate the biomass density, using an ecotrophic efficiency of 0.950. The biomass calculated by the model was 0.4727 t·km<sup>-2</sup> (Table 2). Production/biomass ratio and consumption/biomass ratio have been estimated based on expert opinion during the workshop (Table 2).

Ajiad and Gjørseter (1990) showed that, in the north-eastern part of the Barents Sea, amphipods made up 89% of the diet of polar cod. In the central part amphipods and krill were most important, and in the south-eastern part of the Barents Sea copepods, amphipods and krill were most important. In addition, prawns and fish larvae were taken. This information has been used to specify the diet in the model (Table 3).

Anon. (2000) gives a time series of acoustic estimates of the biomass of polar cod in the Barents Sea for the years 1986-2000, which has been used here. The time series for catch of this group comes from the ICES Fisheries Statistics database.

### **Capelin (*Mallotus villosus*)**

There are two capelin stocks in the model area: The Iceland-East Greenland-Jan Mayen stock and the Barents Sea stock.

The Iceland-East Greenland-Jan Mayen stock spawns along the south east and west coasts of Iceland and feeds in the area between Iceland, East Greenland and Jan Mayen. This stock will migrate into the model area in significant numbers only in some years for a brief period in summer/autumn (the last record in the 1980s). Data from this stock were not included in the model.

The Barents Sea stock spawns along the coasts of northern Norway, and sometimes also along the

coasts of northern Russia. This stock feeds in the Barents Sea.

Estimates of biomass (ages 1-5+) for the years 1972-1999, and landings for the years 1965-1999 were obtained from the ICES Northern Pelagic and Blue Whiting Fisheries Working Group (Anon., 2000b). The biomass for capelin given by the Working Group are based on acoustic estimates in September-October, and the biomass estimated for 1997 was 866,000 tonnes, corresponding to a biomass density of 0.276 t·km<sup>-2</sup>. The model could not be balanced with the estimate of biomass for 1997, indicating that it was too low. We therefore let the model calculate the biomass, using an ecotrophic efficiency of 0.950. The biomass density calculated by the model was 1.132 t·km<sup>-2</sup> (Table 2). Production/biomass ratio and consumption/biomass ratio have been estimated by the working group (Table 2).

The investigation by Huse and Toresen (1996) on the feeding habits of herring and capelin in the Barents Sea in 1992 and 1993 showed that capelin feed mainly on copepods and krill, which accounts for nearly 80% of their diet. An approximate representation of the findings of Huse and Toresen (1996) was used for the present model (Table 3).

The report of the ICES Northern Pelagic and Blue Whiting Fisheries Working Group (Anon., 2000b) gives a time series of acoustic estimates of the biomass of Barents Sea capelin for the years 1990-1999. The report of the ICES Atlanto-Scandian Herring, Capelin and Blue Whiting Assessment Working Group in 1995 (Anon., 1995b) extends this time series back to 1973. The time series for biomass for these two working groups is the basis for our time series of biomass for the years 1973-1997.

Anon., (2000b) gives catches of Barents Sea capelin for the years 1965-1999. The ICES Fisheries Statistics database is used to extend the catches back to 1958. The catches before 1958, if any, were very small, and we have set those catches to zero.

### **Mesopelagic fish**

The mesopelagic fish in this area are mainly Müller's pearlside (*Maurollicus muelleri*) and lanternfish (*Benthosema glaciale* and *Notoscopelus* spp.). Dalpadado *et al.* (1998) reported on densities of *Benthosema glaciale*, *Maurollicus muelleri* and *Notolepis rissoi* in

different water-masses in the Norwegian Sea based on cruises during the summers of 1993-1995. *Benthosema glaciale* occurred in lowest densities in arctic water, and highest in Atlantic waters. *Maurolicus mülleri* and *Notolepis rissoi* were mainly restricted to coastal and Atlantic waters. The total biomass for the three species was estimated as 3.85 million tonnes wet weight. The area investigated was 1.7 million km<sup>2</sup>, giving a mean biomass of 2.26 t·km<sup>-2</sup>. A lower biomass density of 1.840 t·km<sup>-2</sup> was initially used for this model, considering that the density of mesopelagic fish in the Barents Sea is low. However, a biomass of 1.840 t·km<sup>-2</sup> was not sufficient to sustain the demand from predation, and instead we let the program calculate the biomass density, using an ecotrophic efficiency of 0.950. The model estimated biomass of 2.079 t·km<sup>-2</sup> (Table 2) was close to the estimate based on Dalpadado *et al.* (1998).

The values used for production/biomass and consumption/biomass ratio have been estimated during the workshop (Table 2).

Mesopelagic fish appear to feed mainly on copepods and krill (Gjøsæter, 1973, 1981a,b; Kawaguchi and Mauchline, 1982; Sameoto, 1988, 1989; Giske *et al.*, in Skjoldal *et al.*, 1993). In the model, predation by mesopelagic fish was distributed evenly between krill, amphipods, and large and small zooplankton, and a small fraction was allocated to cannibalism (Table 3).

## Squid

The boreo-Atlantic gonate squid *Gonatus fabricii* is one of the most abundant nektonic organisms in the subarctic North Atlantic and Arctic Oceans (Nesis, 1971; Kristensen, 1984). In the pelagic and mesopelagic phase juvenile *Gonatus* (0-group) are very active. The subadult squid migrate to larger depths where the males and immature females remain active, while maturing, mature and spent females reduce their activity and cease feeding. Bjørke and Gjøsæter (1998) have made rough calculations of biomass, production and predation on *Gonatus fabricii* in the Norwegian Sea. They assumed a life cycle of 24 months, meaning that two cohorts are present at any time. Using their figure 3, it is possible to calculate that the mean biomass present during the first year of a cohort is 1.8 million tonnes, and during the second year the mean biomass present for the cohort is 6.4 million tonnes. The mean biomass during the year of the two cohorts present is then 8.2 million tonnes. This results in a biomass estimate of 2.632 t·km<sup>-2</sup> (Table 2).

The mean production of *Gonatus fabricii* during a year was calculated to 20 million tonnes. If we assume that *Gonatus* makes up the larger part of the squids and that the lack of precision in the *Gonatus* data covers the other species, we can let the data for *Gonatus* represent all the squid species in the model area. The production/biomass ratio is 20,000,000/8,200,000 = 2.44·year<sup>-1</sup> (Table 2).

Sennikov *et al.* (1989) investigated stomach content of juvenile and adult *Gonatus fabricii* in the Norwegian and Barents Seas, and found that their food items changed with age (Table 15). A preliminary investigations of 141 *Gonatus fabricii* (50-337 mm length) caught in the Norwegian Sea in 1999 indicated that amphipods (*Themisto* spp.) constituted 42% of the stomach content, euphausiids 17%, remains of mesopelagic fishes 11%, and other remains (decapods, *Gonatus*, etc.) 30% (H. Bjørke, Institute of Marine Research, Bergen, pers. comm.). The diet composition used in the model is listed in Table 3.

The feeding rates of squids are usually high, a number of estimations are made in captive and wild *Illex illecebrosus* giving feeding rates varying from 3.6-6.7% of the body weight per day (see O'Dor and Dawe, 1998). The feeding rates are usually higher in juvenile squid. At present we suggest a daily feeding rate of 5% of the body weight in the pelagic juvenile *Gonatus fabricii*, and an average daily feeding rate of 2% in bathy- and mesopelagic adults.

**Table 15.** Diet of the squid *Gonatus fabricii*, based on Sennikov *et al.* (1989) in percent.

Prey	0-200 m depth (mainly juveniles)	350-450 m (mainly adults)
Copepods	28	1
Amphipods	36	5
Euphausiids	11	33
Decapods	1	19
Chaetognaths	13	-
<i>Gonatus</i>	2	5
Pteropods	3	-
Fish	3	38

Using Bjørke and Gjørseter's (1998) estimate of biomass, the above mentioned feeding rates and the stomach content found by Sennikov *et al.* (1989) and H. Bjørke (pers. comm.) we estimated the annual consumption of different prey by *Gonatus fabricii* in the Norwegian Sea to 99.4 million tonnes (Table 16). Combined with the biomass estimate by Bjørke and Gjørseter (1998), this gives a consumption/biomass ratio of 12.0·year<sup>-1</sup> (Table 2).

The time series for catch of this group comes from the ICES Fisheries Statistics database.

**Table 16.** Estimates of consumption for *Gonatus fabricii* in the Norwegian Sea, based on Bjørke and Gjørseter (1998) and Sennikov *et al.* (1989).

Prey	Juveniles (10 <sup>6</sup> tonnes)	Adults (10 <sup>6</sup> tonnes)
Copepods	9.2	1.3
Amphipods	12.8	11.0
Euphausiids	4.6	11.7
Decapods	0.3	22.3
Chaetognaths	4.3	-
<i>Gonatus</i>	0.5	5.3
Pteropods	0.9	1.2
Fish	2.0	12.0
<b>Sum</b>	<b>34.6</b>	<b>64.8</b>

## Benthos

Christensen (1995), in his model for the North Sea, used the groups echinoderms, polychaetes and other macrobenthos, and the sum of the biomasses for these groups is 105 t·km<sup>-2</sup>. The production/biomass ratio used for the three benthos groups was 2.0·year<sup>-1</sup>, and the consumption/biomass ratio used for the three groups was 13.0·year<sup>-1</sup>.

Zatsepin & Rittikh (1976) investigated the quantitative distribution of macrobenthos in the

Norwegian Sea and southern part of the Greenland Sea using grab sampling, and found that biomass was closely related to depth (Table 17). Romero-Wetzel (1989) used a box-corer at the Vøring Plateau (about 67°N 5°E), the continental slope, and the deep sea off the plateau, and found the highest biomass 8 g·m<sup>-2</sup> at about 600 m depth, and a biomass of 0.5 g·m<sup>-2</sup> at 2-3000 m depth.

The box-corer sampling may be less efficient than sampling with a grab and may explain the lower values observed by Romero-Wetzel (1989). The grab data may also be underestimated, as the grab catches fewer organisms than a sledge that covered the same area (T. Brattegard, Institute of Marine Research, Bergen, pers. comm.)

Using the data from the Norwegian/Greenland Seas given by Zatsepin & Rittikh (1976) and the depth distribution given in Table 1, we estimated the approximate biomass by interpolating the Zatsepin & Rittikh biomass data to fit the depth intervals. This gave a total biomass in the modelled area of 205,699,671 tonnes, or 66.0 t·km<sup>-2</sup>, all depths included.

The average biomass in the upper 500 m was about 120-140 g·m<sup>-2</sup>, which is not too far from the biomass observed by Christensen (105 g·m<sup>-2</sup>, 1985), who excluded the less important groups from the biomass estimates.

The production/biomass and consumption/biomass ratios are likely to be lower due to lower temperatures, and tentatively we have reduced the North Sea values by about 25%. This gives a production/biomass ratio of 1.50·year<sup>-1</sup> and a consumption/biomass ratio of 9.75·year<sup>-1</sup>.

The diet composition parallels that of Christensen (1995), with mainly detritus, plankton and some cannibalism (Table 3).

The time series for catch of this group comes from the ICES Fisheries Statistics database.

**Table 17.** Biomass (wet weight) of macrobenthos at different depths in the Norwegian Sea and southern part of the Greenland Sea based on grab sampling. From Zatsepin & Rittikh (1976).

Depth range (m)	0-100	100-200	200-400	400-600	600-800	800-1,500	> 1,500
Biomass (g·m <sup>-2</sup> )	217	111	60	54	27	11	2.2



### Prawns (*Pandalus borealis*)

Bogstad *et al.* (2000) give biomass estimates for prawns in the Barents Sea for the years 1984-1999. The value for 1997 is 300,000 tonnes, corresponding to 0.096 t·km<sup>-2</sup>. However, the estimates were obtained by the swept area method and only reflect what was available to the bottom trawl. The total biomass is believed to be higher. In order to compensate for the underestimate, a biomass density of 0.300 t·km<sup>-2</sup> was used in the model (Table 2). The values used for production/biomass and consumption/biomass ratios were estimated by the working group (Table 2).

In the model, prawns feed on benthic organisms, large and small zooplankton, and detritus (Table 3).

The ICES Arctic Fisheries Working Group (Anon., 2001a) gives catches for prawns in the Barents Sea for the years 1970-1999. We have extended this time series back to 1950, using catches from the ICES Fisheries Statistics database. Anon. (2001a) also gives two series for catch per unit of effort, for the Russian and Norwegian Prawn fishery in the Barents Sea. The two series follow each other very well. The series for the Norwegian fishery goes back to 1980, one year longer than the Russian series, and we use the Norwegian series as a relative measure for biomass density of prawns for the years 1980-1997. These numbers have not been divided by area, as have been done for the other time series of biomass.

### Krill (Euphausiidae)

Of the species found, *Meganyctiphanes norvegica* is widely distributed, and most abundant in Atlantic and coastal waters. *Thysanoessa inermis* is more of a cold water species. The smallest of the dominant krill species, *T. longicaudata*, was widespread with large abundances in arctic waters.

Dalpadado *et al.* (1998) reported a total biomass of krill in a selected area of the Norwegian Sea (1,700,000 km<sup>2</sup>) during summer of 50 million t, with the highest biomass in arctic waters. This corresponds to a density of 29.41 t·km<sup>-2</sup>.

A new estimate of the total biomass of krill within ICES areas I, II and III was calculated by horizontal integration of the biomass of krill in trawl stations within 6 depth layers from 0 to 500 m during the time period 1990-2000. The krill was sampled with a large pelagic trawl (Åkra

trawl) equipped with a fine meshed (16 mm) net in the cod end. These mesh sizes are too large to retain the 0-group and most of the 1-group, and calibration by simultaneous hauls with a fine-meshed plankton trawl (7.5 mm stretched mesh size) indicated that the krill populations were underestimated by 60% with the pelagic trawl (Hassel and Melle, 2000). Thus, all catches were multiplied by 1.6. Total biomass of krill within the area (3,116,000 km<sup>2</sup>) was estimated at 161 million t, corresponding to 52 t·km<sup>-2</sup>. Dalpadado *et al.* (1998) obtained their results with the Åkra trawl as well and after adjusting their result due to loss of small individuals (multiplying by 1.6) the total biomass was 47 t·km<sup>-2</sup>. That is very similar to our new estimate at 52 t·km<sup>-2</sup> which we used in the model (Table 2).

Pavshstiks and Timokhina (1972) calculated the approximate production of the predominating zooplankton organisms in the Norwegian Sea for some of the years 1959-1969. According to their calculations the production of juvenile krill varied between 3.3 and 13.0 million tonnes (average 7.1 million t). The authors point out that this is a minimum value, and given the gears they used they probably did not sample the larger krill (Dalpadado *et al.*, 1998). The value seems very low if used together with the biomass estimate by Dalpadado *et al.* (1998) for a limited region of the Norwegian Sea it gives a production/biomass ratio of only 0.14 year<sup>-1</sup>.

Given the life history of krill, and the likely high predation levels, it would be reasonable to expect a production/biomass ratio similar to *Gonatus fabricii* (i.e., 2.5 year<sup>-1</sup>, Table 2). Lacking other data, we also used a consumption/biomass ratio of 15.0·year<sup>-1</sup> that was similar to *Gonatus fabricii* (Table 2).

The diet of krill was assumed to consist of small zooplankton, phytoplankton, and detritus (Table 3).

### Amphipods

The large *Themisto libellula*, reported to be a typical cold water species, dominated the trawl catches in Arctic water in the survey by Dalpadado *et al.* (1998). The smaller species *T. abyssorum* and *T. compressa*, being most abundant in Atlantic water, were probably not efficiently collected by the trawl and therefore underestimated. Juveniles of *Themisto libellula* were probably underestimated to the same extent as krill of similar size.

Dalpadado *et al.* (1998) found that the total biomass of hyperid amphipods (*Themisto* spp.) in the Norwegian Sea (1,700,000 km<sup>2</sup>) was 110 million tonnes. This corresponds to a density of 64.71 t·km<sup>-2</sup>.

The unpublished data set used for krill in the previous section also includes catches of amphipods. By the same procedure of horizontal integration the total biomass of amphipods in the ICES areas I, II and III was estimated at 49 million t, corresponding to 16 t·km<sup>-2</sup>, which was the input biomass to the model (Table 2). Even though a loss of juvenile *T. libellula* and the smaller species of the genus *Themisto* through the meshes of the trawl is probable, no correction factor to account for this loss was available to us.

No data was available for mean production/biomass or consumption/biomass, but as a 'guesstimate' we used the same value as for krill, 2.5·year<sup>-1</sup> and 15.00·year<sup>-1</sup>, respectively (Table 2).

### Large zooplankton

Dalpadado *et al.* (1998) found that the total biomass of the small shrimps *Sergestes* spp. and *Pasiphaea* spp. in the Norwegian Sea (1,700,000 km<sup>2</sup>) was 1.60 million t, mainly in coastal and Atlantic waters. This corresponds to a density of 0.94 t·km<sup>-2</sup>.

Zooplankton biomass in the ICES areas I, II and III was measured with MOCNESS hauls to 700 m or to the bottom during several annual cruises conducted by IMR (Wiebe *et al.*, 1985). During these cruises the samples were size fractionated by sieving on 180, 1000 and 2000 µm sieves. From the size fraction larger than 2000 µm shrimps, krill and small fishes which are not sampled quantitatively were removed. The rest is termed 'large zooplankton'. No single cruise covered all areas, and a complete annual coverage from all areas was not available to us. Thus, biomass measured during the June-July cruise in ICES area II and the September-October cruise in ICES area I was used to calculate the average biomass for all areas. It was also assumed that this biomass was representative for the whole year. The biomass of large zooplankton in area I and II was estimated at 40 million t, corresponding to 13 t·km<sup>-2</sup>, when used for the total model area. The biomass of 13 t·km<sup>-2</sup> was not sufficient to account for the predation, and we enabled the model to estimate the biomass using a P/B of 4·year<sup>-1</sup>, Q/B of 15·year<sup>-1</sup> and EE of 0.95. The calculated biomass was 16.9 t·km<sup>-2</sup> (Table 2).

### Small zooplankton

Sakshaug *et al.* (1994) estimated biomass of *Calanus* in the Barents Sea to 2 t C·km<sup>-2</sup>. Using their conversion factors, this corresponds to 15 t·km<sup>-2</sup> wet weight. They also estimated the production/biomass ratio for *Calanus* in the Barents Sea to 4.0 year<sup>-1</sup>.

Timokhina (1964, translation by Serebryakov, 1993) estimated the biomass of different plankton organisms in the Norwegian Sea for different months in 1959 and 1960. The average biomass of *Calanus finmarchicus* and *C. hyperboreus* over all months sampled was 8.49 and 5.17 t·km<sup>-2</sup> for 1959 and 1960, respectively. This gave an average for the two years of 6.83 t·km<sup>-2</sup>. For other copepods (*Pseudocalanus elongatus*, *Metridia longa*, *M. lucens*, and others) the averages were 2.77 t·km<sup>-2</sup> and 1.19 t·km<sup>-2</sup> for 1959 and 1960, respectively, with an average of 1.98 t·km<sup>-2</sup>.

When comparing the biomass densities calculated by Timokhina (1964) for the Norwegian Sea and those calculated by Sakshaug *et al.* (1994) from the Barents Sea one has to keep in mind that the variation in plankton biomass between years can be very large (e.g., Pavshitski and Timokhina, 1972). Still, the deep Norwegian Sea is considered to be the center of production of *Calanus finmarchicus* (Melle, 1998), and it seems unlikely that the standing stock of *C. finmarchicus* is less than in the Barents Sea. Possibly, the use of very different methods to calculate biomass by Timokhina (1964) as compared with Sakshaug *et al.* (1994) is the main reason for the higher biomass estimate in the Barents Sea compared to the Norwegian Sea.

The sum of the biomass in size fractions 180 and 1000 µm is termed 'small zooplankton'. The biomass sampled in June-July in ICES area II and in September-October in area I was considered representative for the whole area as described in the section above. The total biomass of small zooplankton in areas I and II was 103 million t, and the average biomass for the model region was 33 t·km<sup>-2</sup>.

Given that this value ignores the considerable component of very small zooplankton (less than 180 µm), we accounted for this by increasing the biomass to 50 t·km<sup>-2</sup>, and the P/B value to 10.0 year<sup>-1</sup> (Table 2). No value was available for consumption/biomass, but we estimated a value of 25.0 year<sup>-1</sup> (Table 2).

## Jellyfish

Dalpadado *et al.* (1998) found that the total summer time biomass of the jellyfish *Periphylla periphylla* in the Norwegian Sea (1.7 million km<sup>2</sup>) was 11.0 million tonnes, mainly in arctic and Atlantic waters. This corresponds to a density of 6.47 t·km<sup>-2</sup>. This value is likely to vary greatly during the year, and a value of 4.0 t·km<sup>-2</sup> was used for mean biomass during the year (Table 2).

In the workshop model for the Alaska gyre, Pauly and Christensen (1996) used the values 3.00 year<sup>-1</sup> and 10.00 year<sup>-1</sup> for production/biomass and consumption/biomass, respectively. In the absence of other data, we adopted these values (Table 2).

## Seaweeds

The large brown algae of genera *Laminaria*, *Ascophyllum* and *Fucus* make up the bulk of macroalgae (kelp and seaweeds) along the coasts within the model area. Along the whole Norwegian coast the estimated area with macroalgae is approximately 8-10,000 km<sup>2</sup>, and about half of this area is covered with *L. hyperborea*. The biomass of *L. hyperborea* alone is estimated to at least 10 million tonnes wet weight, averaging 2,000 t·km<sup>-2</sup> in the areas where *L. hyperborea* actually grow (Sivertsen *et al.*, 1990).

In the littoral zone the genera *Ascophyllum* and *Fucus* dominate. The biomass of *Ascophyllum* alone along the Norwegian coast is estimated to 1.8 million tonnes wet weight (Baardseth 1970, Rueness 1980). The weight ratio of *Ascophyllum* to *Fucus vesiculosus* in the Møre region is found to be 100:30 (Baardseth and Grenager, 1961), further north along the west coast of Norway the weight ratio *Ascophyllum* to *F. vesiculosus* and *F. serratus* was found to be 100:39:41, indicating a total biomass of *Fucus* spp. to be 1.8 million tonnes \* 0.8 = 1.4 million tonnes. From the Murman part of the Russian coast more than 0.5 million tonnes wet weight of rockweeds (*Ascophyllum* and *Fucus*) has been reported (Zenkevitch, 1963).

These macroalgae are scarce or absent in the Svalbard (Spitsbergen) area. As for *Ascophyllum*, the distribution stops at the eastern limit of the White Sea.

A minimum estimate of the biomass of macroalgae in the model area thus is 13.2 million tonnes kelp and rockweeds along the Norwegian

coast and 0.5 million tonnes of rockweeds along the Murman coast, summing up to 13.7 million tonnes. If we assume that the total area with macroalgae along the Norwegian coast and the Murman coast is 10,000 km<sup>2</sup>, this is 1,370 t·km<sup>-2</sup> of macroalgae in the areas where they actually grow, or 4.4 t·km<sup>-2</sup> as a mean for the total model area.

The annual biomass production of *L. hyperborea* in mid-Norway is approximately 1.5-2 kg·m<sup>-2</sup> dry weight, and in northernmost Norway 0.8 kg·m<sup>-2</sup> dry weight (Gunnarsson 1931, in Sjøtun *et al.*, 1995). The estimates of biomass production per m<sup>2</sup> of *L. hyperborea* found in different regions of Norway are within the same range as those reported from other studies in Europe, where the biomass production is between 0.8 and 3.9 kg·m<sup>-2</sup> dry weight (Sjøtun *et al.*, op. cit.). In some areas of western Norway the annual production of *L. hyperborea* has been estimated to 2 kg·m<sup>-2</sup> dry weight, the equivalent values for the Vega and Finnmark regions were 13 kg-1.3 kg and 8-0.8 kg, respectively (Sjøtun *et al.*, 1995). Dry weight of *L. hyperborea* is approximately 15% of the wet weight (Kain, 1977). It is not possible from these data to calculate an exact production of *L. hyperborea* that is valid for the whole coast, but if we assume a mean production of 2 kg·m<sup>-2</sup> dry weight, this equals approximately 13 kg·m<sup>-2</sup> or 1,300 t·km<sup>-2</sup> wet weight. The P/B ratio for *L. hyperborea* alone is then approximately 0.65·year<sup>-1</sup>.

Several studies have been made with regard to the *in situ* production of *A. nodosum*; in the White Sea Vozzinskaya (1970) estimated an annual production of 1.3 kg·m<sup>-2</sup> dry weight; in New England Chock and Mathieson (1979) found 1.5 kg·m<sup>-2</sup>; in northern Spain Soneira and Niell (1975) estimated 2.3 kg·m<sup>-2</sup>; while Cousens (1984) found that annual production estimates from the coast of Nova Scotia ranged from 0.61 to 2.82 kg·m<sup>-2</sup> depending upon the site, the method and the assumptions made. Baardseth (1970) reported that after harvesting it is possible to restore the original biomass of *A. nodosum* after 4-6 years, which means it is a rather slow growing and low productive species.

As mentioned above *L. hyperborea* makes up the bulk of the biomass of macroalgae. *A. nodosum* may have a somewhat lower P/B ratio than *L. hyperborea*, but we have no data for *Fucus* and other species of macroalgae. We have therefore adopted P/B = 0.65·year<sup>-1</sup> as representative for all the macroalgae.

The time series for harvest of seaweeds comes from the ICES Fisheries Statistics database.

## Phytoplankton

The phytoplankton consists partly of ice biota and partly of a true pelagic community. Sakshaug *et al.* (1994) estimated biomass density of phytoplankton in the Barents Sea to 2,000 kg C km<sup>-2</sup>. Using their conversion factors this corresponds to 15 tonnes wet biomass·km<sup>-2</sup> (Table 2). Using an ecotrophic efficiency of 0.95 leads to a P/B ratio of 117.7 year<sup>-1</sup> in the balanced model (Table 2). This indicates a required production of approximately 1,600 t·km<sup>-2</sup>. This level of required production is supported by data of primary productivity from satellite imagery. The total primary productivity for the Norwegian-Barents Sea area for 1998 is estimated to 225 g C·m<sup>-2</sup>, which (using a conversion factor of 1:9 for carbon to wet weight) corresponds to approximately 2000 t·km<sup>-2</sup>·year<sup>-1</sup>. This estimate is based on a model incorporating 'SeaWiFS' monthly Chlorophyll, photosynthetically active radiation and sea surface temperature, obtained through the Marine Environment Unit of the SAI, EC Joint Research Centre, Ispra, Italy (V. Christensen, pers. comm.).

## CONCLUSIONS

The main purpose of this report was to document the basic input data used to generate the 1997 Ecopath model for the Norwegian Sea and Barents Sea as constructed during the workshop held at the Institute of Marine Research in Bergen, Norway, in November 2000. This model forms part of the ocean-wide assessment of ecosystem effects of fishing in the North Atlantic as conducted by the *Sea Around Us* project at the University of British Columbia. In the future, this model can be used as well to evaluate specific local and regional questions of interest to the Institute of Marine Research. It is anticipated that the model input data will change as better and more location specific data becomes available for various model parameters.

## ACKNOWLEDGEMENTS

We would like to thank the Pew Charitable Trusts, Philadelphia, USA, for funding the *Sea Around Us* project at the University of British Columbia, Canada. Our thanks to the Institute of Marine Research, Bergen, Norway, for hosting the workshop.

## REFERENCES

- Aarefjord, H. and Bjørge, A. J. 1995. Diet of the harbour porpoise (*Phocoena phocoena*) in Scandinavian waters. In *Biology of the Phocoenids*. Report of the International Whaling Commission, Special Issue 16, pp. 212-222. Ed. by A. Bjørge and G. P. Donovan. Cambridge.
- Ajiad, A. M. and Gjosæter, H. 1990. Diet of Polar Cod, *Boreogadus saida*, in the Barents Sea Related to Fish Size and Geographical Distribution. ICES CM 1990/G:48. 9 pp.
- Anon. 1979. Ressursoversikt for 1979-1980. Fisken og Havet 1979, Særnummer 1.
- Anon. 1982. Ressursoversikt for 1981-1982. Fisken og Havet 1982, Særnummer 1.
- Anon. 1986. Ressursoversikt for 1986. Fisken og Havet 1986, Særnummer 1.
- Anon. 1991. Ressursoversikt for 1991. Fisken og Havet 1991, Særnummer 1.
- Anon. 1995a. Report on Surveys of the Distribution and Migrations of the Norwegian Spring Spawning Herring and the Environment of the Norwegian Sea and Adjacent Waters in the Spring and Summer of 1995. Reykjavik 11-13 September 1995. 51 pp.
- Anon. 1995b. Report of the Atlanto-Scandian Herring, Capelin and Blue Whiting Assessment Working Group. ICES CM 1996/Assess:9. 150 pp.
- Anon. 1996. Report on Surveys of the Distribution and Migrations of the Norwegian Spring Spawning Herring and the Environment of the Norwegian Sea and Adjacent Waters in Late Winter, Spring and Summer of 1996. Marine Research Institute, Reykjavik, Iceland, 24-26 Sept. 1996. 49 pp.
- Anon. 1998. Report of the ICES Arctic Fisheries Working Group. ICES CM 1998/Assess:2. 366 pp.
- Anon. 1999. Report of the Joint ICES/NAFO Working Group on Harp and Hooded Seals. ICES CM 1999/ACFM:7 :1-36.
- Anon. 2000. Survey Report from the Joint Norwegian/Russian Acoustic Survey of Pelagic Fish in the Barents Sea, September-October 2000. IMR, PINRO Joint Report Series, Vol. 1. Murmansk. 30 pp.
- Anon. 2000a. Report of the Working Group on Seabird Ecology. ICES CM 2000/C:4. 72. pp.
- Anon. 2000b. Report of the Northern Pelagic and Blue Whiting Fisheries Working Group. ICES 2000/ACFM:16. 303 pp.
- Anon. 2001a. Report of the Arctic Fisheries Working Group. ICES CM 2001/ACFM:02. 340 pp.
- Anon. 2001b. Report of the Working Group on the Assessment of Mackerel, Horse Mackerel, Sardine and Anchovy. ICES CM 2001/ACFM:06. 456 pp.
- Baardseth, E. 1970. Synopsis on Biological Data on Knobbed Wrack *Ascophyllum nodosum* (Linnaeus) Le Jolis. FAO Fisheries Synopsis, Vol. 38, no. 1. 48 pp.
- Baardseth, E. and Grenager, B. 1961. A method of estimating seaweed quantities. Rep. Norw. Inst. Seaweed. Res., 25. 39 pp.
- Bjørge, A. and Øien, N. 1995. Distribution and abundance of harbour porpoise, *Phocaena phocaena*, in Norwegian waters. In *Biology of the Phocoenids*. Report of the International Whaling Commission, Special Issue 16, pp 89-98. Ed. By A. Bjørge and G. P. Donovan. Cambridge.
- Bjørke, H., Blindheim, J., and Melle, W. 1999. Hydrographic Conditions and Vertical Distribution of Plankton and Nekton in the Eastern Norwegian Sea. Fisken og Havet 2. Institute of Marine Research, Bergen, Norway. 30 pp.
- Bjørke, H. and Gjosæter, J. 1998. Who Eats the Larger *Gonatus fabricii* (Lichtenstein) in the Norwegian Sea? ICES CM M:10. 11 pp.
- Bogstad, B., Haug, T., and Mehl, S. 2000. Who eats whom in the Barents Sea. North Atlantic Marine Mammals Commission Scientific Publications, 2: 98-119.
- Bonner, N. 1993. Whales of the World. Blandford, London. 191 pp.
- Bonner, N. 1994. Seals and Sea Lions of the World. Blandford A Cassel Imprint, London. 224 pp.

- Chock, J. S. and Mathieson, A. C. 1979. Physiological ecology of *Ascophyllum nodosum* and its detached ead *scorpioides* (Fucales, Phaeophyta). *Botanica Marina*, 22: 21-26.
- Christensen, I. 1982. Killer whales in Norwegian coastal waters. Report of the International Whaling Commission, 32: 633-642.
- Christensen, I., Haug, T., and Øien, N. 1992a. A review of feeding and reproduction in large baleen whales (Mysticeti) and sperm whales *Physeter macrocephalus* in Norwegian and adjacent waters. *Fauna Norvegica, Series A*, 13: 39-48.
- Christensen, I., Haug, T. and Øien, N. 1992b. Seasonal distribution, exploitation and present abundance of stocks of large baleen whales (Mysticeti) and sperm whales (*Physeter macrocephalus*) in Norwegian and adjacent waters. *ICES Journal of Marine Science*, 49: 341-355.
- Christensen, V. 1995. A model of trophic interactions in the North Sea in 1981, the year of the stomach. *Dana*, 11: 1-28.
- Christensen, V. and Pauly, D. (Editors) 1993. *Trophic Models of Aquatic Ecosystems*. ICLARM Conference Proceedings, no. 26. 390 pp.
- Christensen, V., Walters, C. J. and Pauly, D. 2000. *Ecopath with Ecosim: A User's Guide*. University of British Columbia, Fisheries Centre, Vancouver, Canada and ICLARM, Penang, Malaysia. 131 pp.
- Cousens, R. 1984. Estimation of annual production by the intertidal brown alga *Ascophyllum nodosum* (L.) *Le Jolis. Botanica Marina*, 17: 217-227.
- Dalpadado, P., Melle, W., Ellertsen, B. and Dommasnes, A. 2000. Food and feeding conditions of herring *Clupea harengus* through its feeding migrations. *ICES Journal of Marine Science*, 57: 843-857.
- Dalpadado, P., Ellertsen, B., Melle, W. and Skjoldal, H. R. 1998. Summer distribution patterns and biomass estimates of macrozooplankton and micronekton in the nordic seas. *Sarsia*, 83: 103-116.
- Devold, F. 1963. The life history of the Atlanto-Scandian herring. *Rapports et Procès-Verbaux des Réunions du Conseil International pour l'Exploration de la Mer*, 154: 98-108.
- Dragesund, O., Hamre, J. and Ulltang, Ø. 1980. Biology and population dynamics of the Norwegian spring-spawning herring. In *The Assessment and Management of Pelagic Fish Stocks*, pp. 43-71. Ed. by A. Saville. *Rapports et Procès-Verbaux des Réunions du Conseil International pour l'Exploration de la Mer*, Vol. 177.
- Dommasnes, A., Rey, F. and Røttingen, I. 1994. Reduced oxygen concentrations in herring wintering areas. *ICES Journal of Marine Science*, 51: 63-69.
- Folkow, L., Haug, T., Nilssen, K. T. and Nordøy, E. S. 2000. Estimated food consumption of minke whales *Balaenoptera acutorostrata* in Northeast Atlantic waters in 1992-1995. *North Atlantic Marine Mammals Commission Scientific Publications*, 2: 65-80.
- Giske, J. *et al.* 1990. Vertical distribution and trophic interactions of zooplankton and fish in Masfjorden, Norway. *Sarsia*, 75: 65-81.
- Gjosæter, J. 1973. The food of the myctophid fish, *Benthosema glaciale* (Reinhardt), from western Norway. *Sarsia*, 52: 53-58.
- Gjosæter, J. 1981a. Life history and ecology of *Maurollicus muelleri* (Gonostomatidae) in Norwegian waters. *Fiskeridirektoratets Skrifter Serie HavUndersøkelser*, 17: 109-131.
- Gjosæter, J. 1981b. Life history and ecology of the myctophid fish *Notoscopelus elongatus kroeyeri* from the northeast Atlantic. *Fiskeridirektoratets Skrifter Serie Havundersøkelser*, 17: 133-152.
- Gjosæter, H. 1998. The population biology and exploitation of capelin (*Mallotus villosus*) in the Barents Sea. *Sarsia*, 83: 453-496.
- Hassel, A. and Melle, W. 1999. Plankton som råstoffkilde for fremstilling av føremiddel til bruk innen fiskeoppdrett. Et forprosjekt. Delprosjekt: Utredning av forekomster og tilgjengelighet av dyareplankton. Institute of Marine Research, Bergen. Interne notat, no. 3.
- Haug, T. *et al.* 1998. Sjøpattedyr-om hval og sel i norske farvann. Universitetsforlaget, Oslo. 239 pp.
- Holst, J. C. *et al.* 1998. Report on Surveys of the Distribution, Abundance and Migrations of the Norwegian Spring-Spawning Herring, Other Pelagic Fish and the Environment of the Norwegian Sea and Adjacent Waters in Late Winter, Spring and Summer of 1998. *ICES CM 1998/D:3*. 67 pp.
- Holst, J. C. *et al.* 1999. Report on Surveys of the Distribution, Abundance and Migrations of the Norwegian Spring-Spawning Herring, Other Pelagic Fish and the Environment of the Norwegian Sea and Adjacent Waters in Late Winter, Spring and Summer of 1999. *ICES CM 1999/D:3*. 50 pp.
- Hureau, J. C. and Litvinenko, N. I. 1986. *Scorpaenidae*. In *Fishes of the North-Eastern Atlantic and the Mediterranean*, Vol. 3, pp. 1211-1229. Ed. by P. J. P. Whitehead, M. L. Bauchot, J. C. Hureau, J. Nielsen and E. Tortonese. UNESCO, Paris.
- Huse, G. and Toresen, R. 1996. A comparative study of the feeding habits of herring (*Clupea harengus*, Clupeidae, L.) and capelin (*Mallotus villosus*, Osmeridae, Müller) in the Barents Sea. *Sarsia*, 81: 143-153.
- Ingebrigtsen A. 1929. Whales Caught in the North Atlantic and Other Seas. *Rapports et Procès-Verbaux des Réunions du Conseil International pour l'Exploration de la Mer*, 56: 1-26.
- Jiang, W. and Jørgensen, T. 1996. The diet of haddock (*Melanogrammus aeglefinus* L.) in the Barents Sea during the period 1984-1991. *ICES Journal of Marine Science*, 53: 11-21.
- Johnsgård, Å. 1966. Biology of the North Atlantic fin whale *Balaenoptera physalus* (L.). Taxonomy, distribution, migration and food. *Hvalrådets Skrifter*, 49: 1-62.
- Kain, J. M. 1977. The biology of *Laminaria hyperborea* X. The effect of depth on some populations. *Journal of the Marine Biological Association of the U. K.*, 57: 587-607.
- Kawaguchi, K. and Mauchline, J. 1982. Biology of myctophid fishes (family Myctophidae) in the Rockall Through, northeastern Atlantic Ocean. *Biological Oceanography*, 1: 337-373.
- Kawakami, T. 1980. A review of sperm whale food. *Scientific Reports of the Whales Research Institute*, 32: 199-218.
- Kristensen, T. K. 1984. Biology of the squid *Gonatus fabricii* (Lichtenstein, 1818) from West Greenland waters. *Meddelelser om Grønland, Bioscience*, 13: 3-17.
- Lindstrøm, U., Haug, T. and Røttingen, I. 1999. Consumption of herring *Clupea harengus* by minke whales *Balaenoptera acutorostrata* in the Barents Sea. Report of the International Whaling Commission, SC/51/E7: 1-19.
- Lockyer, C. 1976. Body weights of some large whales. *ICES Journal of Conservation*, 36: 259-273.
- Markussen, N. H., Bjørge, A. and Øritsland, N. A. 1989. Growth in harbour seals (*Phoca vitulina*) on the Norwegian coast. *Journal of Zoology*, 219: 433-440.
- Martin, A. R. and Clarke, M. R. 1986. The diet of sperm whales (*Physeter macrocephalus*) captured between Iceland and Greenland. *Journal of the Marine Biological Association of the U. K.*, 66: 779-790.
- Mehlum, F. and Gabrielsen, G. W. 1995. Energy expenditure and food consumption by seabird populations in the Barents Sea region. In *Ecology of Fjords and Coastal Waters*, pp 457-470. Ed. by H. R. Skjoldal, C. C. E. Hopkins, K. E. Erikstad and H. P. Leinaas. Elsevier Science B. V., Amsterdam.
- Melle, W. 1998. Reproduction, life cycles, and distributions of *Calanus finmarchicus*, *C. glacialis* and *C. hyperboreus* in relation to environmental conditions in the Barents Sea. Ph. D. Thesis. Department of Fisheries and Marine Biology, University of Bergen, Norway. 164 pp.
- Misund, O. A., Melle, W. and Fernø, A. 1997. Migration behaviour of Norwegian spring spawning herring when entering the cold front in the Norwegian Sea. *Sarsia*, 82: 107-112.

- Mitchell, E. 1973. Draft report on humpback whales taken under special scientific permit by eastern Canadian land stations, 1969-1971. Report of the International Whaling Commission, 23: 138-154.
- NAMMCO. 1998. Report of the Fifth Meeting of the Scientific Committee, Tromsø, Norway. 10-14 March 1997. North Atlantic Marine Mammal Commission Annual Report 1997: 85-202.
- Nesis, K. N. 1971. Squid *Gonatus fabricii* (Lichtenstein) in the centre of the Arctic region. Hydrobiological Journal, 7: 93-96.
- Nilssen, K. T., Pedersen, O.-P., Folkow, L. and Haug, T. 2000. Food consumption estimates of Barents Sea harp seals. North Atlantic Marine Mammals Commission Scientific Publications, 2: 9-27.
- Nordøy, E. S., Folkow, L. P., Mårtensson, P. E. and Blix, A. S. 1995. Food requirements of Northeast Atlantic minke whales. In Whales, Seals, Fish and Man. Ed. by A. S. Blix, L. Walløe and Ø. Ulltang. Elsevier Science B. V., Amsterdam. 307 pp.
- O'Dor, R. K. and Dawe, E. G. 1998. *Illex illecebrosus*. In Squid Recruitment Dynamics, pp. 77-104. Ed. by P. G. Rodhouse, E. G. Dawe and R. K. O'Dor. FAO Fisheries Technical Paper, 376.
- Øien, N. 1993. A Note on *Lagenorhynchus* Species in Norwegian waters. ICES Study Group on Seals and Small Cetaceans in European Seas, Cambridge, 31 March-2 April 1993. Working Paper. 9 pp.
- Øien, N. 2000. Sel. In Havets Ressurser 2000. Særnummer 1-2000, pp. 35-40. Ed. by R. Toresen. Institute of Marine Research, Bergen.
- Palomares, M. L. D. and Pauly, D. 1989. A multiple regression model for predicting the food consumption of marine fish populations. Australian Journal of Marine and Freshwater Research, 40: 259-273.
- Pauly, D. 1989. Food consumption by tropical and temperate marine fishes: some generalizations. Journal of Fish Biology, 35 (Suppl. A): 11-20.
- Pauly, D., Christensen, V. and Sambilya, V. 1990. Some Features of Fish Food Consumption Estimates Used by Ecosystem Modellers. ICES Council Meeting, 1990/G:17. 8 pp.
- Pauly, D. and Christensen, V. (eds.) 1996. Mass-Balance Models of North-Eastern Pacific Ecosystems. Fisheries Centre Research Report 4(1), 131 pp.
- Pauly, D., Trites, A. W., Capuli, E. and Christensen, V. 1998. Diet composition and trophic levels of marine mammals. ICES Journal of Marine Science, 55: 467-481.
- Pavshchik, E. A. and Timokhina, A. F. 1972. History of investigations on plankton in the Norwegian Sea and the main results of Soviet investigations. Proceedings of the Royal Society of Edinburgh (B), 73: 267-278.
- Robb, A. P. 1981. Observations on the food and diel feeding behaviour of pelagic 0-group gadoids in the northern North Sea. Journal of Fish Biology, 18: 183-194.
- Robb, A.P. and Hislop, J. R. G. 1980. The food of five gadoid species during the pelagic 0-group phase in the northern North Sea. Journal of Fish Biology, 16: 199-217.
- Romero-Wetzel, M. 1989. Struktur und Bioturbation des Makrobenthos auf dem Vöring-Plateau (Norwegische See). Berichte aus dem Sonderforschungsbereich 313, no. 13. 204 pp.
- Rueness, J. 1980. Praktisk betydning av marine makroalger. Naturen, 5: 196-210.
- Soneira, A. and Niell, F. X. 1975. Sobre la biología de *Ascophyllum nodosum* en Galicia I. Distribución y abundancia en la ría de Vigo. Investigación Pesquera, 39: 43-59.
- Sakshaug, E., Bjørge, A., Gulliksen, B., Loeng, H. and Mehlum, F. 1994. Structure, biomass distribution, and energetics of the pelagic ecosystem in the Barents Sea: A synopsis. Polar Biology, 14: 405-411.
- Sameoto, D. D. 1988. Feeding of lantern fish *Bentosema glaciale* off the Nova Scotia Shelf. Marine Ecology Progress Series, 44: 113-129.
- Sameoto, D. D. 1989. Feeding ecology of the lantern fish *Bentosema glaciale* in a subarctic region. Polar Biology, 9: 161-178.
- Schweder, T., Skaug, H. J., Dimakos, X. K. and Langaas, M. 1996. Abundance of northeastern Atlantic minke whales, estimates for 1989 and 1995. Report of the International Whaling Commission, 47: 453-483.
- Sennikov, A. M., Mukhin, S. G. and Bliznichenko, T. E. 1989. Distribution and trophic importance of juvenile squid (*Gonatus fabricii* Lichtenstein) in the Norwegian and Barents Seas in 1986-1988. ICES CM K:15.
- Sigurjonsson, J. and Vikingsson, G. A. 1997. Seasonal abundance of and estimated food consumption by cetaceans in Icelandic and adjacent waters. Journal of Northwest Atlantic Fishery Science, 22: 271-287.
- Similä, T., Holst, J. C. and Christensen, I. 1996. Occurrence and diet of killer whales in northern Norway: seasonal patterns relative to the distribution and abundance of Norwegian spring spawning herring. Canadian Journal of Fisheries and Aquatic Sciences, 53: 769-779.
- Sivertsen, A., Indergaard, M., Jensen, A. and Jørgensen, L. 1990. Høsting og økologisk betydning av stortare (*Laminaria hyperborea*) langs kysten av Sør-Trøndelag. SINTEF Rapport, 3 Sep 1990, no. 21. 37 pp.
- Sjøtun, K., Fredriksen, S., Rueness, J. and Lein, T. E. 1995. Ecological studies of the kelp *Laminaria hyperborea* (Gunnerus) Foslie in Norway. In Ecology of Fjords and Coastal Waters, pp 525-536. Ed. by H. R. Skjoldal, C. C. E. Hopkins, K. E. Erikstad and H. P. Leinaas. Elsevier Science B. V., Amsterdam.
- Skjoldal, H. R., Noji, T. T., Giske, J., Fosså, J. H., Blindheim, J. and Sundby, S. 1993. Mare Cognitum: Science Plan for Research on Marine Ecology of the Nordic Seas (Greenland, Norwegian, Iceland Seas), 1993-2000. Institute of Marine Research, Bergen, Norway. 162 pp.
- Slotte, A. 1998. Spawning migration of Norwegian spring spawning herring (*Clupea harengus* L.) in relation to population structure. Ph. D. Thesis. Department of Fisheries and Marine Biology, University of Bergen, Norway. 180 pp.
- Slotte, A. and Dommasnes, A. 1998. Distribution and Abundance of Norwegian Spring Spawning Herring During the Spawning Season in 1998. Fisken og Havet, no. 5.
- Timokhina, A. F. 1964. On zooplankton production in different water masses of the Norwegian Sea. Trudy PINRO, 16: 165-182.
- Timokhina, A. F. 1974. Feeding and daily food consumption of the Blue Whiting (*Micromesistius poutassou*) in the Norwegian Sea. Journal of Ichthyology, 14: 760-765.
- Torsvik, N., Mortensen, S. and Nedreaas, K. H. (Editors) 1995. Fiskeribiologi. Landbruksforlaget, Oslo.
- Vilhjalmsson, H. et al. 1997. Report on Surveys of the Distribution, Abundance and Migrations of the Norwegian Spring-Spawning Herring, Other Pelagic Fish and the Environment of the Norwegian Sea and Adjacent Waters in Late Winter, Spring and Summer of 1997. ICES CM 1997/Y:04. 32 pp.
- Vozzhinskaya, V. B. 1970. Fucoids of the White Sea, Their Distribution, Developmental Biology and Production, pp. 170-182. Nauka, Moscow.
- Wiebe, P. H. et al. 1985. New developments in the MOCNESS, an apparatus for sampling zooplankton and micronekton. Marine Biology, 87: 313-323.
- Zatsepin V. I. and Rittikh, L. A. 1976. Quantitative distribution of macrobenthos in the Norwegian Sea and southern part of the Greenland Sea. Oceanology, 16: 397-400
- Zenkevitch, L. 1963. Biology of the Seas of the U.S.S.R. George Allen & Unwin Ltd., London. 95 pp.

# The Azores Archipelago, 1997

**Sylvie Guénette and Telmo Morato<sup>2</sup>**

<sup>1</sup>*Fisheries Centre, University of British Columbia, 2204 Main Mall, Vancouver BC, V6T 1Z4, Canada  
email: s.guenette@fisheries.ubc.ca*

<sup>2</sup>*Departamento de Oceanografia e Pescas, Universidade dos Açores, Horta, Portugal (present address: Fisheries Centre, UBC).*

## ABSTRACT

The Azores Archipelago consists of a small shelf surrounded by a large component of deep oceanic waters dotted with seamounts. The present model is structured by depth and constitutes a first step in applying the Ecopath modeling approach to Atlantic seamounts. It is the result of a collaborative effort with several researchers of the University of the Azores. The model is composed of 43 functional groups including 26 groups of fish classified according to their size and their preferred depth range. Suggestions for future developments are presented.

## INTRODUCTION

The Azores archipelago is a group of nine volcanic islands that are parts of the Mid-Atlantic ridge (Figure 1). The islands and the contiguous shallower waters (< 500 m depth) have an estimated area of 412 km<sup>2</sup>, only 0.4% of the EEZ area of about one million km<sup>2</sup>, while seamounts (< 500 m depth) account for another 0.3% (Isidro, 1996). The present model considers only the area that is being exploited by Azorean fishers, 584,000 km<sup>2</sup>, i.e., slightly more than half the EEZ. We assumed an annual average water temperature of 19EC (range: 16-22EC). The present model is the product of a collaboration with many scientists of the University of the Azores who shared their knowledge of the ecosystem with the two researchers in charge of constructing the model. (The collaborating researchers are mentioned under the title of the functional group they helped with.)

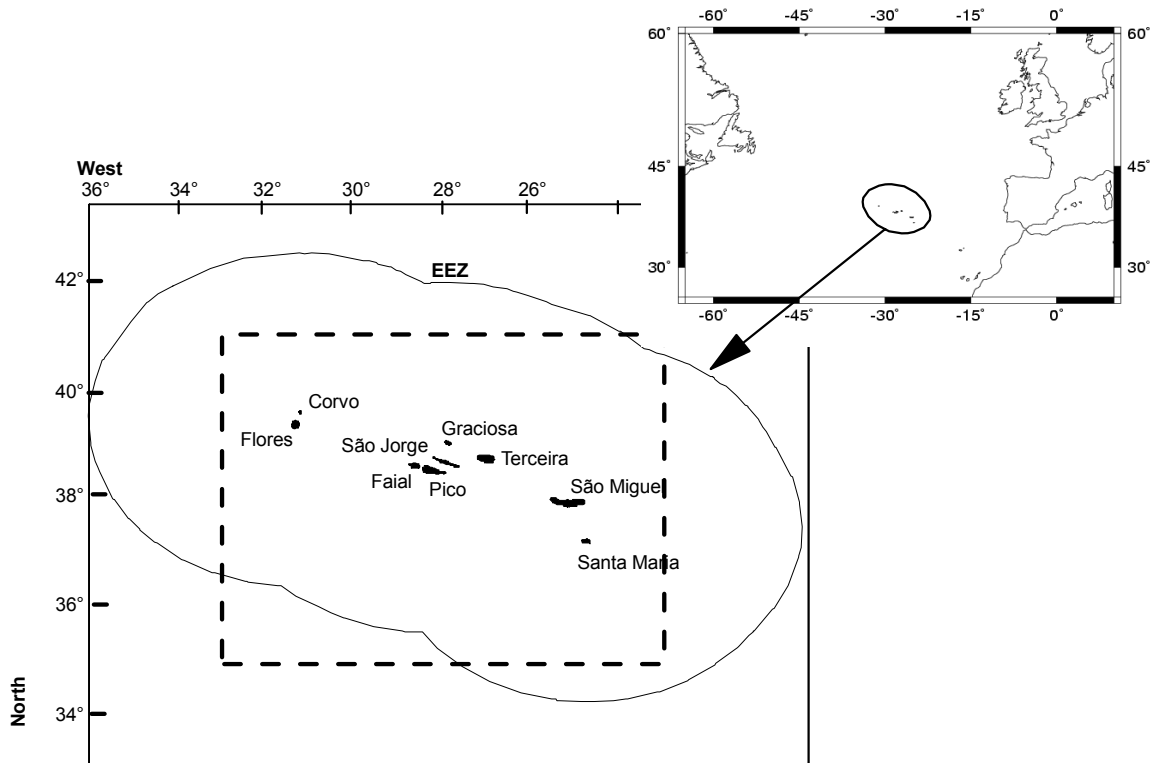

**Figure 1.** Location of the Azores Archipelago, its EEZ, and the area covered by the model (broken line).

## Fisheries

Fishing grounds are limited to the narrow belt of shallow water, around the islands and to nearby seamounts. The fishery is characterized by small-scale vessels using gillnets, traps and various forms of hook and lines (Morato *et al.*, 2001). Trawlers have never been used around the Azores. Landing data were obtained from the Secretary of Agriculture and Fisheries of the Azores and described in Morato *et al.* (2001). The Azorean fisheries have been divided in 13 fleets: sharks (*Dalatias*), demersals (bottom longline), deep water longline (black scabbardfish), handline, lobsters, squids (*Loligo*), nets and hook and line (*Balistes*), octopus, other benthos, algae, small pelagics, swordfish, and tuna (Table 1). The fish species presented as a group in the fisheries statistics (i.e., 'various species') were redistributed into groups exploited by the demersal (or bottom longline) fishery. All other groups were easily attributed to a given fleet.

## Parameters

The model parameters, production per biomass (P/B), consumption per biomass (Q/B) are calculated on a yearly basis. Biomass and catch are expressed in tonnes wet weight per square kilometer. When no biomass estimate was available, this parameter was left to be estimated by Ecopath using a value of 0.95 for the ecological efficiency (EE). It was assumed that, under steady-state conditions, production per biomass per year (P/B) equals total mortality, the sum of natural (M) and fishing mortality (F).

A preliminary diet matrix was assembled using published data, unpublished local information, or empirical knowledge. When unidentified categories were found in the literature, data were re-scaled to 100% to exclude these groups.

## Phytoplankton, group 1

The biomass of phytoplankton is based on the samples taken at the Azores front (south of Azores), in early October (Li, 1994). This author measured Chlorophyll *a* in the first 200 m, which sums up to 22.4 mg Chl *a* m<sup>-2</sup>. Using a ratio of 1 g Chl *a* for 32 g of carbon for the Eastern Atlantic Water (Fasham *et al.*, 1985) and a ratio of 10 g wet weight for each gram of carbon (Pauly and Christensen, 1995), we obtained a biomass of 7.16 g C m<sup>-2</sup>. Fasham *et al.* (1985) obtained 3.52 g C m<sup>-2</sup> WW in April-May in the same area for the upper 30 m. Assuming that the general pattern of plankton biomass (one peak in April and a lesser one in October) described for the North Atlantic by Lalli and Parsons (1993), applies for the Azores region we took the value found in October by Li (1994) as a proxy for the annual average. The primary productivity of phytoplankton (SeaWiFS data set, [www.me.sai.jrc.it](http://www.me.sai.jrc.it)) was estimated at 203 g C m<sup>-2</sup> year<sup>-1</sup> or 2,030 g WW m<sup>-2</sup> year<sup>-1</sup> using the same conversion factors. The production divided by the biomass yielded a P/B value of 290 year<sup>-1</sup>.

## Macrophytes, group 2

(with the collaboration of Fernando Tempera)

Macrophytes are present in rocky habitats around the islands which generally have a narrow shelf area. Using bathymetric maps, we estimated the percentage of rocky habitats around the islands from the shore to a depth of about 25 m (Table 2). The surface of macrophytes beds were estimated with two methods: (1) by using the surface of the islands as a proxy for the area available; (2) calculating the surface by using the perimeter of the island ( $S_i$ ), and, assuming that macrophytes bed would extend 100 m from the shore, a radius of 100 m ( $S_{i+100}$ ) was added to the island radius so that the resulting area has the shape of a doughnut  $S_{i+100} - S_i$ . The mean of the two estimates, 827 km<sup>2</sup>, was kept.

**Table 2.** Calculation of the surface of rocky bottom around the Azores Islands. See explanation of surface method in text; areas are in km<sup>2</sup> and perimeter in km.

Islands	Island area km <sup>2</sup>	% of rocky habitat	Surface method 1	Island perimeter	Area of the donut	Surface method 2
Santa Maria	97.18	80	77.74	50.00	106.80	85.44
São Miguel	746.76	15	112.01	175.45	1720.43	258.06
Terceira	402.17	25	100.54	95.00	325.55	81.39
Graciosa	61.17	80	48.94	36.25	47.06	37.64
São Jorge	245.76	30	73.73	124.00	990.25	297.08
Pico	447.74	10	44.77	109.50	517.40	51.74
Faial	173.11	70	121.18	61.15	130.60	91.42
Flores	141.70	65	92.11	57.00	122.58	79.68
Corvo	17.12			17.75		
<b>Sum</b>	-	-	671.02	-	-	982.45



**Table 1.** Reported landings by fleet as allocated for the model (not incl. 570 t of algae; see text). The demersal fleet catch is the sum of the species known to be caught by the demersal fishery and the unidentified demersal fish. The catch of the other benthos fishery already includes unreported catch.

Fishery:	Demersal		DW Longline	Handline	Lobsters	Loligo	Nets + Balistes	Octopus	Other Benthos	Small pelagic	Swordfish	Tuna	Sum
	Group name	Dalatias											
5	<i>Loligo</i>					302.9							302.9
6	<i>Octopus</i>							47.2					47.2
9	Lobsters				5.90 <sup>a</sup>								5.9
10	Shrimps and crabs								22.16 <sup>b</sup>				22.16
11	Other Benthos								100.16 <sup>c</sup>				100.16
14	Coastal S Inv						8.1						8.1
16	Coastal M Herb						53.2						53.2
17	Coastal M Inv		15.8	0.5		25.4							117.5
18	Coastal M Pred		54.4	1.7		108.6							164.7
19	Coastal L Pred					70.3							70.3
21	<i>P. bogaraveo</i>		1012.0	31.0									1043.3
22	Demersal M Inv		459.4	14.0									473.5
23	Demersal M Pred		95.3	2.9									98.3
24	<i>H. dactylopterus</i>		410.3	13.0									422.9
25	Demersal L Pred		1738.8	53.0		177.2							1969.4
26	<i>Phycis phycis</i>		363.5	11.0									374.6
27	Pelagic S Inv									1.3			1.3
28	Pelagic S Pred		709.8	22.0			17.6			1921.8			2671.0
29	Pelagic M Pred					7.7	60.1						67.8
30	Pelagic L Pred										147.5		147.5
34	Deep Water L					0.3							0.3
35	Rays Pred		99.0										102.0
36	Sharks M Pred	30											30.1
37	Sharks L Pred		103.8								96.1		203.1
38	Tunas Pred											6513	6513.3

<sup>a</sup>Includes reported (2.95t.) and unreported (2.95t.) catches;

<sup>b</sup>Includes reported (13.36t.) and unreported (8.8t.) catches;

<sup>c</sup>Includes reported (6.66t.) and unreported (98.82t.) catches.

A study of the algae density on the shore of São Vicente showed an average dry weight of 500–600  $\text{g}\cdot\text{m}^{-2}$  (Neto, 1997). Assuming that dry weight equals 21% of wet weight (Mackinson, 1996), we obtained a density of 2,619  $\text{t}\cdot\text{km}^{-2}$  for 827  $\text{km}^2$  of potential algae beds. Reported on the total area of study, the biomass of macroalgae was: 3.71  $\text{t}\cdot\text{km}^{-2}$ . In absence of other data, we used the P/B ratio for benthic plants of 4.34  $\text{year}^{-1}$  used in the Strait of Georgia model (Canada) (Mackinson, 1996). Algae landings amount to 570 t or 0.00098  $\text{t}\cdot\text{km}^{-2}$  (Azorean Regional Statistical Services at [www.ine.pt/srea/](http://www.ine.pt/srea/)).

## Zooplankton

Some recent descriptive studies focusing on the zooplanktonic community around Faial Island found that abundance estimates for the Azores were similar to that of the Canary Islands and Iberian Peninsula continental shelf (Sobrinho-Gonçalves and Isidro, 2001). They also reported that abundances were not significantly correlated to distance from the coast or depth. However, one should keep in mind that sampling did not occur on seamounts, which have peculiar current patterns. Sobrinho-Gonçalves and Isidro (2001) considered a group of 'Partial Zooplankton' that included individuals with a displacement volume smaller than 5 ml. This group includes organisms we have classified both as small and large zooplankton. Silva (2000) reported the small zooplankton around Faial island to be composed of copepods (68.9% by number), chaetognaths (5.2%), euphausiids (4.7%), ostracods (3.9%), thaliacea (3.0%), and appendicularia (2.5%), with other groups remaining undefined.

## Small zooplankton, group 3

We defined this group as small herbivores, such as copepods. The most common copepod species in the Azores are *Clausocalanus arcuicornis*, *Pleuromamma gracilis*, *Calanus minor*, and *Acartia danae* (Silva, 2000). The production estimates for *Pseudocalanus* are highly variable for different regions (Table 3); we used an average value of 60  $\text{year}^{-1}$ . The ratio between production and consumption (P/Q), 0.3, was taken from Christensen (1996). Zooplankton was sampled over the first 100 meters at night (Sobrinho-Gonçalves and Isidro, 2001). As plankton migrates towards the surface at night, the value probably represents the bulk of the zooplankton in the upper 300 m. Thus we assumed that this value could be used as a first estimate of depth-integrated biomass. The resulting average yearly abundance of 15.2  $\text{ml}\cdot\text{100 m}^{-2}$  (Table 4) for the first 100 meters depth was converted to 12.7  $\text{g}\cdot\text{m}^{-2}$ , using the conversion factor found in Cushing *et al.* (1958). Because we were not sure of these values, and it was difficult to balance the model, we left the biomass to be estimated by the model, and obtained a value of 3.84  $\text{g}\cdot\text{m}^{-2}$ .

**Table 3.** P/B for *Pseudocalanus* by area according to Corkett and McLaren (1978)

Location	P/B ( $\text{year}^{-1}$ )
Black Sea	32
Sea of Japan	66
Baltic Sea	38
North Sea	73
<b>Average</b>	<b>52</b>

**Table 4.** Estimative of biomass for small and large zooplankton for the first 100 meters depth in the Azores.

Group	Months Sampled	Plankton Biomass <sup>a</sup> ( $\text{ml}\cdot\text{100m}^{-3}$ )	N months with similar biomass	Weight average <sup>b</sup> ( $\text{ml}\cdot\text{100m}^{-3}$ )	Weight average ( $\text{g}\cdot\text{m}^{-2}$ )
<b>Small</b>	February	11.5	5	4.79	3.99
	March	14.2	2	2.37	1.97
	May	48.7	1	4.06	3.38
	June	12.0	4	4.00	3.33
	<b>Weighted mean<sup>c</sup></b>			<b>15.22</b>	<b>12.68</b>
<b>Large</b>	March	3.4	4	1.13	0.94
	May	51.0	1	4.25	3.54
	June	0.4	7	0.23	0.19
	<b>Weighted mean<sup>c</sup></b>			<b>5.62</b>	<b>4.68</b>

<sup>a</sup>from Sobrinho-Gonçalves and Isidro (2001);

<sup>b</sup>using the conversion factor found in Cushing *et al.* (1958), i.e. 1 ml of displacement volume represents 0.0012 mg;

<sup>c</sup>if we consider two months with bloom phenomena; i.e., the value of march representing one month and the value of May representing 2 months (April and May), we obtain a biomass of 15.08  $\text{g}\cdot\text{m}^{-2}$  and 7.99  $\text{g}\cdot\text{m}^{-2}$  for small and large zooplankton, respectively.

### Large zooplankton, group 4

A first estimate of large zooplankton was derived from integrated profiles (0-1900 m) of zooplankton for the Azores Front (Angel, 1989). A very general relationship between volume and biomass (Wiebe *et al.*, 1975) was used to obtain a first estimate of biomass of the species considered: chaetognaths, amphipods, decapods, mysids, euphausiids, and salps, and it added up to 29 g·m<sup>-2</sup>. The jellies were probably underestimated as they are easily destroyed in nets; however they still constituted 50% of the volume of the samples. Assuming a conversion factor for jellies similar to zooplankton, 15 ml of displacement volume would equal 12.3 g·m<sup>-2</sup>. The total biomass is then close to 30 g·m<sup>-2</sup>.

Using the same study as for the small zooplankton (Sobrinho-Gonçalves and Isidro, 2001), large zooplankton was evaluated at 4.68 g·m<sup>-2</sup> (Table 4), a value much smaller than that derived from Angel (1989), i.e., ~ 30 g·m<sup>-2</sup> (Table 5). However, because of the discrepancy between the two estimates, we let the model estimate the biomass using an EE value of 0.8, which resulted in a biomass of 7.31 g·m<sup>-2</sup>. We used a P/B of 5 year<sup>-1</sup> and a Q/B of 32 year<sup>-1</sup> based on average estimates for euphausiids, carnivorous jellies, salps, and chaetognaths (Table 6).

**Table 5.** Biomass estimates for large zooplankton in the Front of the Azores derived from Angel (1989).

	Integration 0-1900m <sup>a</sup>		Weight <sup>b</sup> (g·m <sup>-2</sup> )
	Volume (ml·m <sup>-2</sup> )	Numbers (n·m <sup>-2</sup> )	
Chaetognatha	14.2	54.22	5.41
Amphipoda	8.5	1.66	3.90
Mysidacea	3.6	2.93	2.26
Euphausiacea	3.8	15.28	2.34
Salpa	4.6	9.25	2.64
Siphonophora <sup>c</sup>	15.4		12.32
<b>Total/mean</b>			<b>28.88</b>
Decapoda <sup>d</sup>	1.1	3.31	1.06

<sup>a</sup>according to Angel (1989);

<sup>b</sup>weight according to the general equation from Wiebe *et al.* (1975);

<sup>c</sup>jellyfishes: weight based on a conversion factor of 1 ml = 0.8 g;

<sup>d</sup>Decapods were not kept in this group as they were already included in the Shrimps and crabs group.

**Table 6.** P/B and Q/B (per year) estimates for Large zooplankton in the Front of the Azores.

	P/B	Q/B
Chaetognatha	3 <sup>a</sup>	19.5 <sup>c</sup>
Amphipoda	-	-
Mysidacea	-	-
Euphausiacea	6 <sup>b</sup>	48 <sup>b</sup>
Salpa	2 - 4 <sup>a</sup>	30 <sup>a</sup>
<b>Mean</b>	5	32

<sup>a</sup>Alaska Gyre, (Arai, 1996);

<sup>b</sup>Alaska Gyre, (Jarre-Teichmann and Guénette, 1996);

<sup>c</sup>Bundy *et al.* (2000), Newfoundland shelf.

Mysids are omnivorous, preying on dead and live animals and plants. Salps eat mainly phytoplankton, plus other particles (Raymont, 1983). Adult amphipods are free-living carnivores feeding on copepods, chaetognaths, euphausiids, and fish larvae (Lalli and Parsons, 1993). Chaetognaths eat mainly copepods but also fish larvae, other chaetognaths, medusae, siphonophores, salps, etc. (Raymont, 1983). The average diet derived from these qualitative descriptions is: 30% phytoplankton, 44% small zooplankton, 15% detritus and 11% cannibalism. The diet has been slightly modified while balancing the model, by increasing the proportion of small zooplankton to 73% and decreasing cannibalism to 2% (see Table 18).

### Cephalopods, groups 5-8

Squid, *Loligo forbesi* (group 5), and the common octopus, *Octopus vulgaris* (group 6), were separated from the other cephalopods because of their commercial exploitation. All other cephalopods were separated in two size class, smaller and larger than 30 cm (small cephalopods, group 7; large cephalopods, group 8). Squids are fished at depths of 135-270 m close to the islands using manual jigs. Male squids can reach a dorsal mantle length of 95 cm and a weight of 9 kg while females reach 46 cm and 2 kg (Porteiro, 1994). Squid landings amounted to 302.9 t·year<sup>-1</sup> or 0.000519 t·m<sup>-2</sup>·year<sup>-1</sup>. Octopus landings were estimated at 47.1 t·year<sup>-1</sup> or 0.000081 t·m<sup>-2</sup>·year<sup>-1</sup>.

Daily food consumption has been estimated at 14% of body weight for *Loligo* (Segawa 1990 in Pierce *et al.*, 1994), which amounts to an annual Q/B of 51 year<sup>-1</sup>. However, taking into account that most cephalopods are carnivorous, this estimate was considered too high. A more conservative value of Q/B of 10 year<sup>-1</sup> was used (Christensen, 1996).

Gonçalves (1993), using various methods, estimated the total mortality of the Azores octopus to be between 0.22 to 2.89 year<sup>-1</sup> ( $M=0.62$  year<sup>-1</sup> using Pauly's empirical equation). We chose the higher value for the model. As they have about the same life expectancy, we used the same P/B value for squids. We assumed that the P/B of small squids would be higher than that of *Loligo* (P/B= 4 year<sup>-1</sup>) based on their size. Large squids were assumed to live longer and have less predators than the small ones and *Loligo*, so their P/B = 2.5 year<sup>-1</sup>.

Fish consumption represented 71-85% in weight for *Loligo vulgaris* and 9-19% of cephalopods depending on the location (Morocco or Algarve Coelho *et al.*, 1997). Occurrence of preys in *Loligo forbesi* stomachs showed that fish contributed 82%, among which *Trachurus picturatus*, *Boops boops*, *Lepidopus caudatus*, *Phycis phycis*, and *Capros aper* were dominant. Juvenile octopus and other cephalopods accounted for 12.7%, crustaceans (mainly planktonic) 12.1%, and other invertebrates (polychaetes and others) for 2.6% (Martins, 1985). Although the range of fish species was similar, Pierce *et al.* (1994) found that fish occur in 60% of the stomach, while other cephalopods amounted to 16%. In absence of average sizes for their preys and to account for the larger weight of fish, we used the percentage occurrence as a proxy for the percentage in weight, assuming that each stomach contains only one type of prey most of the time (Martins, 1985). This added up to 77%, and the remaining 27% were redistributed among the categories of fish already listed.

Small pelagics constituted 67% of *Loligo* prey; this was considered excessive, so this figure was split between small pelagics (31%), small pelagic invertebrates eaters (32%), *Pagellus bogaraveo* (0.2%), and deepwater small (Group 32) (5%). Invertebrate preys were 1.3% other benthos, 3.9% shrimps/crabs, and 6% cephalopods, separated equally between *Loligo* (cannibalism) and small cephalopods. The proportion of large and medium fish in the diet was difficult to maintain in the present model structure, as this does not separate the juveniles (high production) from the adults (low production). Thus, all large and medium fish were removed from the diet composition while predation on small fish was increased (Table 19).

Octopus continue to feed on crustaceans even as adults (Akimushkin, 1965). The frequency of prey occurrence in octopus stomach found in Gonçalves (1991) were: 14% worms, 14% gastropods, 21% cephalopods, 92% shrimps. In

absence of weight information, we assumed that octopus ate 40% each of shrimps/crabs, and other benthos, 3% of small cephalopods, while the remaining 17% were distributed equally between lobsters and octopus (cannibalism). The diet had to be modified to balance the model by increasing the proportion of other benthos to 44.2%, decrease lobster to 0.1% and add sea stars (0.1%) (see Table 19).

Small cephalopods (2-20 cm) feed on planktonic organisms (crustaceans, pteropods, mollusks) (Akimushkin, 1965). We assumed their diet to be 71% large zooplankton, 5% each of small pelagics (invertebrate and fish feeders, groups 27-28) and small deepwater fishes, 10% mesopelagics, 1% *Loligo* and 3% cannibalism.

Large squids feed on pelagic fish and smaller cephalopods (Akimushkin, 1965). Their diet was assumed to be composed of 20% small cephalopods, 10% pelagics, 20% mesopelagics, and 40% deepwater fish. For the same reason as for *Loligo*, all medium and large fish were removed from the diet while large zooplankton were added (41%) (Table 19).

### Lobsters, group 9

This groups includes the common spiny lobster (*Palinurus elephas*) and the Spanish lobster (*Scyllarides latus*). The mean weight of lobsters caught by fishers was estimated from Martins (1985) at 714 and 818 g for males and females respectively. Using a temperature of 19EC and an empirical equation (Brey, 1999), natural mortality was estimated at 0.3 year<sup>-1</sup>. Assuming that fishing mortality is equal to M resulted in a P/B of 0.6 year<sup>-1</sup>. In absence of data on their consumption we used a gross efficiency of 0.06 from the crab and lobster group of the French Frigate shoals (Pauly *et al.*, 1993). Reported landings were estimated at 2.95 t·year<sup>-1</sup>, which we doubled to account for the large unreported catch, yielding a relative landing value of 0.00001 t·km<sup>-2</sup>·year<sup>-1</sup> (Table 6). This value is probably still an underestimate.

In absence of better data, we used the relative abundance from the Newfoundland shelf based on the assumption that lobster habitat constitutes a small proportion of the area considered in both models. The relative biomass from the Newfoundland model, 0.0045 t·km<sup>-2</sup> (Bundy *et al.*, 2000), seemed credible when compared with the other biomasses in the model.

Spanish lobster was found to eat mainly limpets in the summer in the Azores (Martins, 1985).

Spiny lobster feed preferentially on echinoderms (ophiuroids and crinoids) and mollusks, although macroalgae, polychaetes, bryozoans, shrimp larvae and fish are also found in their stomachs (Hunter, 1999). Lobsters were assumed to feed on other benthos (66%), detritus (14%), coastal small fishes (5%), large zooplankton (10%) and shrimps (5%). During the balancing process, a number of lobster predators had to have their diets modified to decrease the quantity of lobsters consumed (see Tables 18 and 19).

### Shrimps and crabs, group 10

This group includes pelagic and benthic shrimps such as the pandalids *Plesionika narval*, *P. edwardsii*, *P. martia*, *P. gigliolii*, and the hippolytids *Ligur ensiferus* (Martins and Hargreaves, 1991). There are several species of crabs in the area, among which some species are assumed to be moderately fished (*Maja squinado*, *Grapsus grapsus* and *Cancer bellianus*).

Crabs catches were estimated at 24.16 tonnes per year or  $0.00004 \text{ t km}^{-2}\text{-year}^{-1}$  (See Table 7). In absence of local estimates, we used  $P/B=1.4 \text{ year}^{-1}$  for shrimps based on the Newfoundland shelf model (Bundy *et al.*, 2000).  $P/B$  for crabs was based on the value used for the Prince Williams Sound (Dean, 1999);  $P/Q$  for shrimps and crabs was assumed equal to 0.15 (Jarre-Teichmann and

Guénette, 1996), which gives a  $Q/B$  of  $10 \text{ year}^{-1}$ .  $P/B$  was increased to  $1.6 \text{ year}^{-1}$  to balance the model and account for the smaller pelagic shrimps.

Pelagic shrimps were assumed to eat detritus, euphausiids and chaetognaths. Benthic shrimps and crabs diet were taken from Jarre-Teichmann and Guénette (1996). The resulting diet is: 10% each of small and large zooplankton, 10% of shrimps and crabs, 30% of other benthos, 40% detritus.

### Other benthos, group 11

This group includes mollusks such as *Patella*, small crustaceans such as *Gammarus*, brittle stars, worms, and sponges, urchins (*Arbacia lixula*, *Arbaciella elegans*, *Centrostephanus longispinus*, *Paracentrotus lividus*). A small fishery targeted mainly *Patella* and *Megabalanus*. In the 1980s, the abundance of *Patella* decreased dramatically, possibly because of an epidemic (Ferraz *et al.*, 2001), and thus the catch is now very low (around 1 tonne per year). Annual landings of other benthos were very small (1.4 t) and composed of a variety of organisms. However, including estimates of unreported catch leads to landings of  $100.16 \text{ t-year}^{-1}$ , or  $0.00017 \text{ t km}^{-2}\text{-year}^{-1}$  (see Table 7).

**Table 7.** Estimated annual landings (tonnes) for some commercially important crustaceans and mollusks.

Group	Species	Values in tonnes		Commercial landings		Total
		Reported	Unreported	Reported	Unreported <sup>a</sup>	
Lobsters	<i>Palinurus elephas</i>	2.60	2.60 <sup>a</sup>	-	-	5.20
Lobsters	<i>Scyllarus latus</i>	0.35	0.35 <sup>a</sup>	-	-	0.70
<b>Subtotal</b>	-	-	-	-	-	<b>5.90</b>
Shrimps and crabs	<i>Grapsus grapsus</i>	0.57	8.80 <sup>b</sup>	2	-	11.37
	<i>Maja squinado</i>	0.22	-	-	-	0.22
	<i>Cancer bellianus</i>	12.57	-	-	-	12.57
<b>Subtotal</b>	-	-	-	-	-	<b>24.16</b>
Other benthos	<i>Patella</i> spp.	5.30	60 <sup>c</sup>	30 <sup>d</sup>	-	90.00
Other benthos	<i>Megabalanus tintinabulum</i>	0.12	8.80 <sup>b</sup>	0	-	8.92
Other benthos	<i>Thaio haemastoma</i>	1.24	-	-	-	1.24
<b>Subtotal</b>	-	-	-	-	-	<b>100.16</b>

<sup>a</sup>Values similar to the reported landings were empirically assigned. It is probably still very low and will be refined in the next versions of the model;

<sup>b</sup>Estimated by T. Morato based on an average consumption during the summer festivals;

<sup>c</sup>Estimated by R. Ferraz including the reported landings;

<sup>d</sup>Estimated by T. Morato based on an average annual consumption per family.

**Table 8.** P/B (year<sup>-1</sup>), gross efficiency (GE), and Q/P (year<sup>-1</sup>) from various sources for the Other benthos group.

Group	Common name	P/B	GE <sup>a</sup>	Q/B
Crustaceans	<i>Gammarus</i>	2.44 <sup>b</sup>	0.25	-
Echinoderms	Urchins, sea cucumbers	0.54	0.095	-
Mollusks	<i>Littorina</i> , bivalves	2.24 <sup>b</sup>	0.095	62 <sup>d</sup>
Annelida	Polychaetes	2.54 <sup>b</sup>	0.095	-
Cnidaria	Sponges	0.68 <sup>c</sup>	-	36.5 <sup>d</sup>
Tunicata	Ascidians	-	-	36.5 <sup>d</sup>
Hydrozoa	Hydroids	-	-	60 <sup>d</sup>
<b>Mean</b>		<b>2</b>	<b>0.12</b>	<b>-</b>

<sup>a</sup>Jarre-Teichmann and Guénette (1996); <sup>b</sup>Brey's data base (Brey, 1995); <sup>c</sup>Florida Bay (Banse and Mosher, 1980); <sup>d</sup>Coma *et al.* (1995).

In absence of local data, we based our estimates on T. Brey's data base (Brey, 1995), by first looking for similar organisms and most importantly, choosing groups of animals with a range of temperature of 15 to 26 (average = 20.8EC). Only three genera present in the Azores were directly represented in Brey's data base: *Tellina* and *Patella* (Mollusks), *Holothuria* (Echinoderms) (Table 8). GE for these groups was calculated as the average GE (=0.12) used in the southern British Columbia shelf model (Jarre-Teichmann and Guénette, 1996) (Table 8).

Bivalves were assumed to feed on 70% detritus, 20% zooplankton, 10% phytoplankton; polychaetes feed on 100% detritus; small crustaceans (amphipods, isopods) feed on 90% detritus and 10% zooplankton. Hydroids eat 40% zooplankton, 60% detritus, based on a study on *Campanularia* (Coma *et al.*, 1995). The diet of sea anemones is composed of zooplankton, polychaetes, detritus and small crustaceans (Van-Praët, 1985) which was allocated as: 30% zooplankton 10% small benthos, and 60% detritus. Thus the global diet for this group is 10% zooplankton, 1.4 phytoplankton, 6.6% benthic plants, 10% cannibalism, and 72% detritus. This diet was then modified to release pressure on macrophytes (to 1%) and decrease cannibalism (2%) which had the effect of inflating the biomass of the group (see Table 19).

### Carnivorous sea stars, group 12

In absence of any detailed information, we took the P/B (=0.4 year<sup>-1</sup>) and P/Q (=0.09 year<sup>-1</sup>) values used in the British Columbia shelf model (Jarre-Teichmann and Guénette, 1996). Sea stars were assumed to feed upon 70% benthos and 30% detritus (Jarre-Teichmann and Guénette, 1996).

### Fish

One hundred sixty five fish species were considered, based on a checklist of marine fishes of the Azores (Santos *et al.*, 1997). These species were separated in 26 functional groups based on their habitat, size and diet. In addition, some species were separated out into their own groups because they are the target of fisheries. Coastal fishes are defined as sedentary species that live mainly around the islands and have their maximum abundance distribution situated at depth less than 200 meters. Demersal species live both around the islands and at offshore banks and at depths between 200 and 800 meters. Deepwater species are most abundant below 800 meters depth and can occur at depth of 3,000 meters or more. Pelagic species are defined as fish living both around the islands and at offshore banks. However, this category excludes tunas and sharks.

Coastal demersal and deepwater fishes are divided into 3 group sizes based on their maximum length: small (<35 cm), medium (35-80 cm) and large (>80 cm). Small pelagics are smaller than 80 cm, medium pelagics between 80 and 150 cm, while large pelagics are larger than 150 cm. *Phycis phycis* was separated for use as a case study of a highly caught coastal medium predator. *Pagellus bogaraveo* was separated for use as a case study of a highly fished demersal medium invertebrate feeder. *Helicolenus dactylopterus* was distinguished to serve as an example of a highly fished demersal medium predator. The source and region of each diet used in the model is listed in Table 9.

Fish natural mortality was derived from the empirical model of Pauly (1980):

$$M = K^{0.65} L4^{-0.279} T^{0.463} \dots 1)$$

where K and L4 (cm) refer to the curvature and asymptotic length parameters, respectively, of the von Bertalanffy growth function, and T is the mean annual water temperature in degrees Celsius. When no published growth data was available, K was estimated through the equation of Pauly and Munro (1984):  $\log_{10} K = \Phi - 2\log_{10} L4$  where  $\Phi$  was estimated from the growth parameters of similar species, generally of the same genus, i.e., with similar shape and habits (in FishBase).

**Table 9:** Source and region of the study for the diets used in the model.

Nº	Group Species	Location	Source
13	<b>Coastal Small Herbivorous</b>		
	<i>Ophioblennius atlanticus</i> <i>atlanticus</i>	Azores	Adapted from (Azevedo, 1997)
	<i>Parablennius sanguinolentus</i>	Azores	Adapted from (Santos and Barreiros, 1993)
14	<b>Coastal Small Invertebrate feeders</b>		
	<i>Abudefduf luridus</i>	Azores	(Ribeiro, 1998)
	<i>Chromis limbata</i>	Mediterranea and Black Seas	Adapted from (Duka and Shevenko, 1988)
	<i>Coris julis</i>	Mediterranean	(Khoury, 1987)
	<i>Coryphoblennius galerita</i>	Azores	(Azevedo, 1995)
	<i>Diplecogaster bimaculata</i>	Scotland	Adapted from (Gibson and Ezzi, 1987)
	<i>Echiichtys vipera</i>	Azores	Adapted from (Azevedo, 1995; Gibson and Robb, 1996)
	<i>Gobius paganellus</i>	Azores	Adapted from (Azevedo, 1997)
	<i>Lipophrys pholis</i>	Azores	Adapted from (Azevedo, 1995; Gibson and Robb, 1996)
	<i>Parablennius ruber</i>	Azores	Adapted from (Azevedo, 1997)
<i>Thalassoma pavo</i>	Azores	Adapted from (Azevedo, 1997)	
<i>Tripterygion delaisi</i>	Azores	(Oliveira, 1997)	
<i>Xyrichtys novacula</i>	West Indies	Adapted from (Randall, 1967)	
15	<b>Coastal Small Predators</b>		
	<i>Apogon imberbis</i>	Medit	(Garnaud, 1962)
	<i>Atherina presbiter</i>	Canaries	Adapted from (Moreno and Castro, 1995)
	<i>Bothus podas, maderensis</i>	Azores	Adapted from (Nash <i>et al.</i> , 1991)
	<i>Scorpaena maderensis</i>	Azores	Adapted from (Azevedo, 1997)
<i>Scorpaena notata</i>	Medit	Adapted from (Harmelin-Vivien <i>et al.</i> , 1989)	
16	<b>Coastal Medium Herbivorous (and small invertebrates)</b>		
	<i>Chelon labrosus</i>	general	Fishbase
	<i>Kyphosus spp.</i>	West Indies	Adapted from (Randall, 1967)
	<i>Sarpa salpa</i>	Mediterranean	Adapted from (Verlarque, 1990)
	<i>Sparisoma cretense</i>	Mediterranean + NE Atl.	(Quignard and Pras, 1986)
17	<b>Coastal Medium Invertebrate feeders</b>		
	<i>Aspitrigla cuculus</i>	Cantabrian shelf, Spain	(Velasco <i>et al.</i> , 1996)
	<i>Boops boops</i>	Canaries	Adapted from (Moreno and Castro, 1995)
	<i>Diplodus sargus cadenati</i>	Azores	(Figuerido, 1999)
	<i>Labrus bergylta</i>	Azores	(Figuerido, 1999)
	<i>Mullus surmuletus</i>	Azores	(Vieira, unpublished data)
<i>Pseudocaranx dentex</i>	general	Fishbase	
18	<b>Coastal Medium Predators</b>		
	<i>Pagrus pagrus</i>	Mediterranean	(Papaconstantinou and Caragitsou, 1989)
	<i>Scorpaena scrofa</i>	Mediterranean	(Harmelin-Vivien <i>et al.</i> , 1989)
	<i>Serranus atricauda</i> <i>Synodus saurus</i>	Azores	(Morato <i>et al.</i> , 2000)
19	<b>Coastal Large Predators</b>		
	<i>Enchelycore anatina</i>	general	FishBase
	<i>Epinephelus marginatus</i>	Azores	(Barreiros and Santos, 1998)
	<i>Gymnothorax unicolor</i>	FishBase	Fishbase
	<i>Muraena augusti</i> <i>Muraena helena</i>	Azores Azores	(Azevedo, 1995) (Azevedo, 1995)
20	<b>Demersal Small Invertebrate feeder</b>		
<i>Callyonimus reticulatus</i>	FishBase	Adapted from (Gibson and Ezzi, 1987) and information in Fishbase	
21	<b><i>Pagellus bogaraveo</i></b>	Azores	(Morato <i>et al.</i> , in press)
22	<b>Demersal Medium Invertebrate and predators</b>		
	<i>Beryx decadactylus</i>	Azores	(Morato-Gomes <i>et al.</i> , 1998)
	<i>Beryx splendens</i>	Azores	(Morato-Gomes <i>et al.</i> , 1998)
	<i>Pagellus acarne</i>	Azores	(Morato <i>et al.</i> , in press)

<b>23 Demersal Medium Predator</b>		
<i>Lepidorhombus whiffiagonis</i>	Thyrrenes Sea, Medit	Adapted from (Mannini <i>et al.</i> , 1990)
<i>Phycis blennoides</i>	FishBase	Fishbase
<i>Serranus cabrilla</i>	Canary islands + Medit	Adapted from (Tuset <i>et al.</i> , 1996; Labropoulou and Eleftheriou, 1997)
<i>Zeus faber</i>	Atlantic Portuguses	(Silva, 1999)
<b>24 <i>Helicolenus d. dactylopterus</i></b>		(Meyer and Smale, 1991a)
	South Africa	
<b>25 Demersal Large Predator</b>		
<i>Conger conger</i>	Azores	(Morato <i>et al.</i> , 1999)
<i>Lepidopus caudatus</i>	Azores	(Morato-Gomes <i>et al.</i> , 1998)
<i>Lophius Piscatorius</i>	Spain VIIIc	Adapted from (Velasco <i>et al.</i> , 1996) and information in Fishabse
<i>Molva Dyterygia macrophthalmia</i>	FishBase	Fishbase
<b>26 <i>Phycis phycis</i></b>	Azores	(Morato <i>et al.</i> , 1999)
<b>27 Pelagic Small Invertebrate and plankton feeder</b>		
<i>Sardina pilchardus</i>	general	Fishbase
<i>Scomberesox saurus saurus</i>	general	Fishbase
<b>28 Pelagic Small Predator</b>		
<i>Balistes carolinensis</i>	West Indies	Adapted from (Randall, 1967)
<i>Scomber japonicus</i>	general	Fishbase
<i>Trachurus picturatus</i>	general	Fishbase
<b>29 Pelagic Medium Predator</b>		
<i>Cubiceps gracilis</i>	general	(Gorelova <i>et al.</i> , 1994)
<i>Sphyrnaena viridensis</i>	Azores	J.P. Barreiros, University of the Azores, unpublished data
<b>30 Pelagic Large Predator</b>		
<i>Xiphia gladius</i>	Azores	(Clarke <i>et al.</i> , 1995)
<b>31 Mesopelagic</b>		
<i>Ceratoscopelus maderensis</i>	general	(Tsarin, 1997)
<b>33 Deep-water Medium</b>		
<i>Epigonus telescopus</i>	Mediterranean and Rockall Through	(Macpherson, 1981)
<i>Hoplostethus atlanticus</i>	Rockall through	(Mauchline and Gordon, 1984)
<i>Nezumia aequalis</i>	Mediterranean	(Macpherson, 1981)
<b>34 Deep-water Large</b>		
<i>Aphanopus carbo</i>	Rockall through	(Mauchline and Gordon, 1984)
<i>Synaphobranchus kaupii</i>	Rockall through	(Gordon and Mauchline, 1996)
<b>35 Rays</b>		
<i>Raja brachyura</i>	NE Atlantic	(Ellis <i>et al.</i> , 1996)
<i>Raja clavata</i>	Azores	(Morato <i>et al.</i> , unpublished data)
<b>36 Sharks Medium</b>		
<i>Dalatias licha</i>	Catalan waters	(Matallanas, 1982)
<i>Galeus melastomus</i>	W Mediterranean	(MacPherson, 1980)
<b>37 Sharks Large</b>		
<i>Galeorhinus galeus</i>	Azores	(Morato <i>et al.</i> , unpublished data)
<i>Lamna nasus</i>	Bristol Channel	(Ellis and Shackley, 1995; Cortés, 1999)
<i>Prionace glauca</i>	Azores	(Clarke <i>et al.</i> , 1996)
<b>38 Tunas</b>		
<i>Thunnus thynnus</i>	Bay of Biscay	(Clarke <i>et al.</i> , 1996)



Fish consumption per biomass (Q/B) per year was calculated according to the empirical regression of Palomares and Pauly (1988).

$$Q/B = 10^{6.37} @ 0.0313^T @ W_4^{-0.168} @ 1.38^P @ 1.89^H \dots 2)$$

where  $W_4$  is the asymptotic body weight in grams, T is the mean annual temperature expressed as  $1000/(TEC + 273.1)$ , P equals one for predators and zooplankton feeders and zero for all others, and H equals one for herbivores and zero for carnivores.  $W_4$  is generally calculated from  $L_4$  using published length-weight relationships or, in absence of data,  $L_4$  was assumed to be equal to  $L_{max} @ 0.95$  (Pauly, 1984).

#### **Coastal small herbivorous, group 13**

This group included redlip blenny (*Ophioblennius atlanticus*) and herbivorous blenny (*Parablennius sanguinolentus*), which are not fished. The growth data came from the Mediterranean and Florida. The values of Q/B and P/B were 13 year<sup>-1</sup> and 0.53 year<sup>-1</sup> respectively, based on Azores growth data on herbivorous blenny (Santos *et al.*, 1995). However the value of P/B was considered too low for such a small fish and increased to 1.07 year<sup>-1</sup>. The diet, adapted from studies done in the Azores, show that benthic algae constituted 88% of their diet, which was too high. The proportion of macrophytes was reduced to 46% and the remaining redistributed into phytoplankton, small zooplankton and other benthos.

#### **Coastal small invertebrate feeders, group 14**

This group included species such as the Canary damsel (*Abudefduf luridus*), Atlantic wrasse (*Centrolabrus trutta*), Azores chromis (*Chromis limbata*), Mediterranean rainbow wrasse (*Coris julis*), ornate wrasse (*Thalassoma pavo*). The value of Q/B was estimated at 10.5 year<sup>-1</sup>. In absence of a value for P/B we assumed a ratio production/consumption of 0.25. Most of the feeding studies were from the Azores. The diet composition is dominated by small benthic invertebrates (64%) such as amphipods, isopods, copepods, small gastropods, small bivalves, and small decapods. The diet was then modified to decrease the proportion of other benthos and shrimps and crabs consumed (Table 19). In 1997, landings of *Coris julis*, the only species fished in this group, amounted to 8 t or 0.000014 t@m<sup>-2</sup>. Unreported catch (including subsistence fishery) was estimated at 10% of the reported landings, which brings the total landings to 8.8 t.

#### **Coastal small predators, group 15**

This group included several species such as swallowtail seaperch (*Anthias anthias*), wide-eyed flounder (*Bothus podas maderensis*), Madeira rockfish (*Scorpaena maderensis*), small red scorpionfish (*Scorpaena notata*) and cardinal fish (*Apogon imberbis*). Natural mortality for the latter was first estimated at 1.7 year<sup>-1</sup> but lowered to 0.8 year<sup>-1</sup> based on a maximum age of around 6-7 years. Q/B was estimated at 8.4 year<sup>-1</sup>. None of these species are fished. The diet composition, taken from studies made in the Azores, the Canaries and the Mediterranean, is dominated by coastal small invertebrate feeders (18%), shrimps and crabs (36%) and other benthos (22%). The proportion of shrimps and crabs was reduced by a factor of 10 to reduce the inflation of the biomass estimated by Ecopath (Table 19).

#### **Coastal medium herbivorous, group 16**

This group includes species such as thicklip grey mullet (*Chelon labrosus*), salema (*Sarpa salpa*) and parrotfish (*Sparisoma cretense*). Natural mortality was estimated at 0.25 year<sup>-1</sup> and fishing mortality assumed to amount to about two thirds of M for a P/B value of 0.4 year<sup>-1</sup>. Q/B was estimated at 6 year<sup>-1</sup>. Growth data originated from various location on the coasts of Northeast Atlantic, the Mediterranean and the Azores. Data on diet is derived from general information found in FishBase. Fish of this group were assumed to feed mainly on benthic algae (78%), but could also feed in a small proportion upon small crustaceans such as copepods and amphipods. Reported landings for the three species amount to 53 t, to which can be added 20% of unreported catch (including the spearfishing and subsistence fisheries) or 0.000109 t@m<sup>-2</sup>.

#### **Coastal medium invertebrate feeders, group 17**

This group is composed of bogue (*Boops boops*), white seabream (*Diplodus sargus cadenati*), ballan wrasse (*Labrus bergylta*), striped red mullet (*Mullus surmuletus*), gully jack (*Pseudocaranx dentex*) and various Labridae. Most of the growth information for this group came from the French coast and the Azores. Values of P/B and Q/B were estimated at 0.89 year<sup>-1</sup> and 6.9 year<sup>-1</sup> respectively. Data on feeding habits were mainly taken from studies of the Azores and the Canaries. Fish of this group feed mainly on shrimps and crabs (20%), and other benthos (32%) such as gastropods, bivalves, polychaetes. Also these species could occasionally feed upon fish, amounting to a small proportion

of the diet (2%). Landings for the three species amounted to 117.4 t·year<sup>-1</sup>. We assumed that unreported catches amounted to at least 20% resulting from spearfishing (for *Diplodus* and *Labrus*), subsistence fishing (*Diplodus*) and commercial fishing, for a total of 0.00024 t·km<sup>-2</sup>·year<sup>-1</sup>.

### **Coastal medium predators, group 18**

This group is composed of common seabream (*Pagrus pagrus*), great rockfish (*Scorpaena scrofa*), blacktail comber (*Serranus atricauda*) and Atlantic lizardfish (*Synodus saurus*). The growth data came from the Azores and the Canaries. P/B and Q/B were estimated at 0.45 year<sup>-1</sup> and 6.6 year<sup>-1</sup> respectively. P/B was calculated as the sum of F (=0.1 year<sup>-1</sup>) estimated for seabream (Menezes *et al.*, 1998) and M (=0.35). Only one of the 3 diet compositions available was for the Azores, the remaining being taken from Mediterranean studies. The diet is dominated by small coastal (27%) and demersal fish (21%), shrimps and crabs (23%) and other benthos (12%). The presence of medium and large fish in the diet albeit in small proportions, inflated their respective biomass. Thus, their proportion were reduced or eliminated, and mesopelagics were added to the list (Table 19). Landings for this group amounted to 164.6 t. We assumed that unreported catches amounted to at least 20% resulting from spearfishing (*Serranus*), subsistence fishing (*Serranus*, *Pagrus*) and other commercial sources (*Pagrus*) for a total landing of 0.0003 t·km<sup>-2</sup>.

### **Coastal large predators, group 19**

This group included dusky grouper (*Epinephelus marginatus*), brown moray (*Gymnothorax unicolor*), Duke Augustus moray (*Muraena augusti*), and Mediterranean moray (*Muraena helena*). For 3 species out 5, the diet information was taken from Azorean studies while the two others were adapted from general diet information from FishBase (Table 9). Fish of this group feed mainly on fish (51%), octopus (17%), shrimps and crabs (23%), cephalopods (2%) and lobster (1%). As in the precedent group, predation on large fish was reduced (Table 19). P/B (based on dusky grouper only) and Q/B were estimated at 0.25 year<sup>-1</sup> and 4.1 year<sup>-1</sup> respectively. P/B was estimated from the addition of M (=0.15 year<sup>-1</sup>) and an assumed value of F roughly equal to two thirds of M (i.e., F =0.1 year<sup>-1</sup>).

Landings amounted to 70.3 t·year<sup>-1</sup>. We assumed unreported catches of at least 10% resulting from spearfishing, subsistence fishing and other

sources for total landings of 0.00013 t·km<sup>-2</sup>·year<sup>-1</sup>. A first guess of biomass (0.02t·km<sup>-2</sup>) was required to run the model.

### **Demersal small invertebrate feeders, group 20**

This group is composed of boarfish (*Capros aper*), longspine spinefish (*Macroramphosus scolopax*), reticulated dragonet (*Callynyminus reticulatus*), gadella (*Gadella maraldi*), blackfin waryfish (*Scopelosaurus lepidus*), *Scopelosaurus argenteus*, and *Synchiropus phaeton*. Few data were available for species of this group. Estimation of natural mortality was only possible for spinefish (P/B=1.02 year<sup>-1</sup>). This was considered too low for such a small fish and increased to 2. Q/B (=11.5 year<sup>-1</sup>) was based on boarfish and spinefish. Based on a general description of the diet for the reticulated dragonet only (in FishBase), we assumed that this group fed upon other benthos (86%) and shrimps and crabs (14%). The consumption of shrimps was reduced to 1.1%, the remaining redistributed among the other groups and a new prey item, *Loligo*.

### **Pagellus bogaraveo, group 21**

Blackspot seabream *Pagellus bogaraveo* was singled out as a case study of a highly fished demersal medium invertebrate feeder. Both growth data and diet information came from Azorean studies. Fishing mortality was estimated at 0.34 year<sup>-1</sup> (Menezes *et al.*, 1998) which, added to natural mortality (M=0.33 year<sup>-1</sup>), yielded a P/B value of 0.66 year<sup>-1</sup>. Q/B was estimated at 5.2 year<sup>-1</sup>. Seabreams' diet is dominated by large zooplankton (23%), mesopelagics (33%) and small demersal invertebrates (33%). Landings amounted to 1,043 t·year<sup>-1</sup> or 0.001786 t·km<sup>-2</sup>·year<sup>-1</sup>. The biomass was calculated from the ratio catch/F and equal 0.006 t·km<sup>-2</sup>.

### **Demersal medium invertebrate and predators, group 22**

Species of this group are of high commercial value and included alfonsinos (*Beryx decadactylus* and *B. splendens*) and axillary seabream (*Pagellus acarne*). Growth and diet data both came from the Azores. Landings amounted to 473.5 t (459.4 t as in Table 10 plus 14.1 t of unidentified fish, see Table 1). Unreported landings were estimated to amount to 5% of the landings of *Pagellus acarne* (4 t), for total landings of 0.000811 t·km<sup>-2</sup>·year<sup>-1</sup>.

The average fishing mortality for the two species of alfonsinos was estimated at 0.29 year<sup>-1</sup>

**Table 10.** Calculation of biomass for species of group 22 using the estimation of F provided in Menezes (1998). A value in parenthesis indicates that the biomass was obtained by using the relative abundance index.

Species	Landing (t year <sup>-1</sup> )	F (year <sup>-1</sup> )	Relative abundance (%) <sup>a</sup>	Biomass (t)	Relative biomass (t·km <sup>-2</sup> )
<i>Beryx decadactylus</i>	110.694	0.38	20	291.3	0.0005
<i>Beryx splendens</i>	267.677	0.19	50	1408.826	0.0024
<i>Pagellus acarne</i>	81.029	-	30	(728.63)	0.0012
<b>Sum</b>	459.4	-	-	2428.752	0.0042

<sup>a</sup>from T. Morato, personal observation.

(Menezes *et al.*, 1998) (see Table 10). Natural mortality being estimated to 0.544, P/B amounted to 0.83 year<sup>-1</sup>. P/B was considered too low and increased to 1.2 year<sup>-1</sup>, which is close to the value used in the Hong Kong model for a similar functional group (Buchary *et al.*, 2001). The total biomass of this group (0.0042 t·km<sup>-2</sup>) was based on the ratio catch/F and the use of relative abundance index for seabream (T. Morato, pers. obs.). Alfonsinos' biomasses were estimated by dividing the landing by the estimate of F for each species.

Q/B (=8.149 year<sup>-1</sup>) was based on data from *P. acarne* only. Fish of this group feed upon large zooplankton (19%), shrimps and crabs (25%), other benthos (8%) and small fish (demersal small inv. 39%, deep-water medium inv. 1%).

#### **Demersal medium predators, group 23**

The group is composed of John dory (*Zeus faber*), megrim (*Lepidorhombus whiffiagonis*), greater forkbeard (*Phycis blennoides*), yellow-orange scorpionfish (*Pontinus kuhlii*), comber (*Serranus cabrilla*). Natural mortality based on growth data from the North-East Atlantic, varied largely among species of this group with an average of 0.426 year<sup>-1</sup> (Table 11). Fishing mortality (F=0.13 year<sup>-1</sup>) was taken from Menezes (1998) based on *P. kuhlii*, for a P/B ratio of 0.556 year<sup>-1</sup>. This value was believed to low and increased to 0.8 year<sup>-1</sup>. Landings amounted to 98 t or 0.000168 t·km<sup>-2</sup>·year<sup>-1</sup>. Q/B was estimated at 6.82 year<sup>-1</sup>. Diet information came from various studies in the Mediterranean and North-East Atlantic. These fish feed upon small demersal and small pelagic fishes (55%), shrimps and crabs (22%) and other benthos (12%). During the balancing process, cannibalism was reduced from 11 to 4.1% and the consumption of group 20 reduced to a fourth of its original value.

**Table 11.** Calculation of natural mortality (year<sup>-1</sup>) by species of group 23.

Species	M
<i>Phycis blennoides</i>	0.519
<i>Lepidorhombus whiffiagonis</i>	0.332
<i>Pontinus kuhlii</i>	0.237
<i>Zeus faber</i>	0.617
<b>Mean</b>	0.426

#### ***Helicolenus dactylopterus*, group 24**

Blackbelly rosefish *Helicolenus dactylopterus* was distinguished to serve as an example of a highly fished species. The problem is related with the multispecies characteristic of the bottom longline fishery which is catching 11 fish groups. There are concerns that the target fishing mortality based on *Pagellus bogaraveo* is being overfished. Fishing mortality has been estimated at 0.23 year<sup>-1</sup> (Menezes *et al.*, 1998) which, added to natural mortality (M=0.27 year<sup>-1</sup>), yielded a P/B value of 0.5 year<sup>-1</sup>. This value was increased to 0.8 year<sup>-1</sup> while balancing the model. Q/B was estimated at 7.3 year<sup>-1</sup>. Growth data came from the Azores (Isidro, 1996) while the diet was adapted from a South African study (Meyer and Smale, 1991b). The biomass was estimated at 0.003 t·km<sup>-2</sup> from the ratio Catch/F.

Rosefish feed on small demersal, deepwater, pelagic and mesopelagic fish (50%), other benthos (42%), shrimps and crabs (6%) and cephalopods (2%). Diet was adjusted by decreasing the consumption of group 22 (medium demersal) to a twentieth of the value assumed originally (see Table 19). Landings amounted to 422.9 t·year<sup>-1</sup>. We assumed a small level of discards of 1-2%, contributed by small individuals of no commercial value.

**Demersal large predator, group 25**

This group includes high-value commercial species such as European conger (*Conger conger*), silver scabbardfish (*Lepidopus caudatus*), wreckfish (*Polyprion americanus*), anglerfish (*Lophius piscatorius*), and blue ling (*Molva macrophthalma*).

Menezes (1998) estimated fishing mortality of *L. caudatus* at 0.31 year<sup>-1</sup>; adding a natural mortality of 0.28 year<sup>-1</sup>, P/B equals 0.59 year<sup>-1</sup>. Annual landings amounted to 1916 t (Table 12) plus 53 t from unidentified fish that is 1,969 t or 0.0034 t·km<sup>-2</sup>·year<sup>-1</sup>. The biomass of *L. caudatus* was estimated by dividing landings by F (Menezes, 1998). The abundance of other species was estimated using relative abundance (T. Morato, pers. obs.). The resulting biomass amounted to 0.0239 t·km<sup>-2</sup>.

The average Q/B was equal to 4.7 year<sup>-1</sup>. Most diet information came from the Azores. Fish of this group feed almost exclusively upon demersal and pelagic fishes (80%), cephalopods (7%), sea stars (6%), shrimps (1%) and sharks medium (1%). Cannibalism was estimated at 5%. The consumption of medium and large fish (groups 21-25) was decreased in order to diminish the inflated biomass.

**Phycis phycis, group 26**

The forkbeard *Phycis phycis* was singled out as an example of a highly fished member of the coastal large predator functional group. Based on growth data from the Azores, natural mortality was estimated as 0.25. Menezes (1998) estimated a fishing mortality of 0.24 year<sup>-1</sup>, which led to a P/B value of 0.49 year<sup>-1</sup>. Q/B was estimated at 5.5 year<sup>-1</sup>. Diet information came from an Azorean study. Landings amounted to 374.6 t·year<sup>-1</sup> or 0.000641 t·km<sup>-2</sup>·year<sup>-1</sup>. The biomass was estimated at 0.003 t·km<sup>-2</sup> from the ratio catch/F. Forkbeard feed mainly on fish (80%) and shrimps and crabs (19%).

**Pelagic small invertebrate and plankton feeders, group 27**

This group is composed of European sardine (*Sardina pilchardus*), European anchovy (*Engraulis encrasicolus*), Atlantic saury (*Scorpaenopsis scorpaenoides*) and silvery cod (*Gadiculus argenteus*). M was estimated at 1.06 year<sup>-1</sup> based on growth data from various locations in NE Atlantic and the Mediterranean, while F was originally given a low value of 0.2 year<sup>-1</sup> to account for a small fishery for bait amounting to 1.3 t·year<sup>-1</sup> or 0.000002 t·km<sup>-2</sup>·year<sup>-1</sup>. Upon balancing the model, F was assumed to be equal to M. Q/B was equal to 11.3. Diet information came from general information in FishBase for sardine and saury. These fish feed on phytoplankton (50%) and small zooplankton (50%).

**Pelagic small predators, group 28**

This group includes garpike *Belone belone*, chub mackerel (*Scorpaenopsis scorpaenoides*), derbio (*Trachinotus ovatus*), blue jack mackerel (*Trachurus picturatus*), grey triggerfish (*Balistes carolinensis*). They feed mainly upon small pelagic and demersal fishes. Based on growth data for chub mackerel, natural mortality was estimated at 0.58 year<sup>-1</sup>. In absence of data we first assumed that fishing mortality equaled natural mortality (P/B = 1.2 year<sup>-1</sup>). Landings amounted to 2671 t·year<sup>-1</sup> or 0.00457 t·km<sup>-2</sup>·year<sup>-1</sup>.

Q/B was estimated at 6.58 year<sup>-1</sup> based on chub mackerel and derbio. Diet information was based on general information found in FishBase and one study from the West Indies, and was available for three species out of five. Fish of this group were assumed to eat mainly benthos (35%), shrimps (20%) and plankton (13%), the remaining of the diet is composed of small pelagic fish (11%) and cannibalism (7%). In order to deflate the biomass of fish (including cannibalism), other benthos and shrimps, their importance in the diet was decreased (Table 19).

**Table 12.** Calculation of biomass for species of group 25, using the estimation of F (per year) provided in Menezes (1998). A value in parenthesis indicates that the biomass was obtained by using the relative abundance index.

Species	Landings (t year <sup>-1</sup> )	F	Relative abundance (%) <sup>a</sup>	Biomass (t)	Biomass (t·km <sup>-2</sup> )
<i>Conger conger</i>	596.456	-	25	-	(0.006)
<i>Lepidopus caudatus</i>	1114.667	0.31	30	4182	0.0072
<i>Lophius piscatorius</i>	6.635	-	10	-	(0.0024)
<i>Polyprion americanus</i>	177.153	-	20	-	(0.0048)
<i>Molva macrophthalma</i>	21.054	-	15	-	(0.0036)
<b>Sum</b>	1915.965	-	-	-	0.0239

<sup>a</sup>from T. Morato personal observation.

### ***Pelagic medium predators, group 29***

This group is composed of bluefish (*Pomatomus saltator*), Atlantic bonito (*Sarda sarda*), almaco jack (*Seriola dumerili*), barracuda (*Sphyraena viridensis*), driftfish (*Cubiceps gracilis*), longnose lancetfish (*Alepisaurus ferox*), and blue runner (*Caranx crysos*). M was estimated at 0.246 year<sup>-1</sup> based on bluefish and Atlantic bonito. F was assumed to be equal to half the M value, for a total P/B of 0.36 year<sup>-1</sup>. Landings amounted to 67.8 t·year<sup>-1</sup>. We assumed unreported catches of at least 5% from spearfishing, subsistence fishing and other commercial sources, resulting in total landings of 0.00011 t·km<sup>-2</sup>·year<sup>-1</sup>.

Q/B was estimated at 5.2 year<sup>-1</sup>. Diet information was based on driftfish (Gorelova *et al.*, 1994, Atlantic Ocean) and barracuda (Azores, J.P. Barreiros, unpublished data). The resulting diet was dominated by large zooplankton (jellyfish, salpida; 46%) and small pelagic fish (50%). The large proportion of large zooplankton in the diet of driftfish may have skewed the resulting diet. A revised version of the model would include better information on feeding habits of bonitos and jacks. In order to deflate the biomass of fish that were estimated by Ecopath, it was necessary to decrease the consumption of most fish. The remaining was redistributed to large zooplankton and *Loligo*, a new item, was added (Table 20).

### ***Pelagic large predators, group 30***

This group includes dolphinfish (*Coryphaena equiselis* and *C. hippurus*), billfish (*Makaira nigricans*), white marlin (*Tetrapturus albidus*), longbill spearfish (*Tetrapterus pfluegeri*), and swordfish (*Xiphias gladius*). However, the group is really represented by swordfish, if only because of lack of data for the other species.

In FishBase, natural mortality and maximum age of swordfish were estimated at 0.09 (0.06-0.14) year<sup>-1</sup> and 73 years, respectively (based on estimations of growth parameters). However, measurements of radiocarbon in vertebrae, suggest that this species rarely live past 25 years (Ward and Elscot, 2000). This would lead to a natural mortality of about 0.2 year<sup>-1</sup>. Fishing mortality was estimated at 0.25 year<sup>-1</sup> for males (5+) and 0.57 year<sup>-1</sup> for females (9+), which was over  $F_{msy}$  in the late 1990s (Anon., 1999b). We used an F of 0.3 year<sup>-1</sup> and M of 0.2 year<sup>-1</sup> for a total P/B value of 0.5 year<sup>-1</sup>. Landings, composed of swordfish (147 t) and dolphinfish (mainly *C. hippurus*), were estimated at 147.4 t·year<sup>-1</sup> or 0.00025 t·km<sup>-2</sup>·year<sup>-1</sup>. Biomass of swordfish alone would be of 0.0008 t·km<sup>-2</sup> (catch/F). The biomass

for the whole group was assumed to amount to 0.02 t·km<sup>-2</sup>.

Q/B was based on growth data for swordfish only and equaled 2.8 year<sup>-1</sup>. Diet information was based on a study of swordfish in Azorean waters, which shows that this species feed on small cephalopods (52%) as well as pelagic and demersal fish (48%) (Clarke *et al.*, 1995). The proportion of demersal large and medium (groups 23 and 25) in the diet had to be reduced to balance the model (Table 19).

### ***Mesopelagics, group 31***

Although they represent an important part of the pelagic environment, little is known about this group which includes all species of the families Myctophidae, Stomiidae, and Gonostomatidae. P/B (=2.39 year<sup>-1</sup>) was based on two species only and quite variable (*Maurolicus muelleri*, 2.19 year<sup>-1</sup>; *Myctophum punctatum*, 0.96 year<sup>-1</sup>). This value was increased to 3 to account for very small species in this group. Q/B was estimated at 14.4 year<sup>-1</sup>. Based on a trawl survey done in 1970-71 (Babcock and Merret, 1976; in Gjøsaeter and Kawaguchi, 1980), the biomass was estimated at 2 t·km<sup>-2</sup>. None of these species are fished. In absence of field data, this group was assumed to prey on small (33%) and large zooplankton (67%).

### ***Small deepwater, group 32***

Small deepwater are composed of Dana viperfish (*Chauliodus danae*), and Sloane's viperfish (*Chauliodus sloani*). In the absence of field data, P/B and Q/B were assumed to be similar to other deepwater fish and given values of 0.35 year<sup>-1</sup> and 5 year<sup>-1</sup> respectively. It became evident that this was too low and the P/B should rather be similar to small demersal fish (P/B = 0.8 year<sup>-1</sup>). There is no landings for this group. We assumed that this group fed on mesopelagics (60%), small demersal invertebrate (10%), shrimps (20%) and other benthos (10%). The diet was modified by adding small zooplankton (10%) to the prey list and decreasing the proportion of mesopelagics, shrimps and other benthos.

### ***Medium deepwater, group 33***

Fish of the medium deepwater group include orange roughy (*Hoplostethus atlanticus*), Mediterranean slimehead (*Hoplostethus mediterraneus*), common mora (*Mora moro*), common Atlantic grenadier (*Nezumia aequalis*), roundhead grenadier (*Odontomacrus murrayi*), Valiant's grenadier (*Bathygadus melanobranchus*), hollowsnout grenadier

(*Coelorhynchus coelorhynchus*), and bulls-eye (*Epigonus telescopus*).

Growth information was taken from studies done in New Zealand (Mace *et al.*, 1990) and the Mediterranean (D'Onghia *et al.*, 1998) for the two *Hoplostethus* species only, and P/B and Q/B were estimated at 0.3 year<sup>-1</sup> and 8 year<sup>-1</sup> respectively. Although none of these species are fished, a small proportion of the catch of common mora is commonly misidentified as *Phycis blennoides* at fish auctions. Assuming that proportion to be 10% of the catch of *Phycis*, the resulting by-catch of common mora would be 2.9 t·year<sup>-1</sup>. Diet information was taken from studies made in the Mediterranean and the Rockall Through (NE Atlantic). Their diet is dominated by shrimps (30%), other benthos (23%), small (8%), large (12%) zooplankton, and various small fish. To deflate their biomass, the consumption of shrimps and some fish (groups 20, 31, 32) was decreased.

### **Large deepwater, group 34**

The group includes black scabbardfish (*Aphanopus carbo*) and roundnose grenadier (*Coryphaenoides rupestris*). Natural mortality for the scabbardfish was estimated to 0.17 year<sup>-1</sup> based on growth data from the Azores. Using data from Madeira islands (scabbardfish, M=0.4 year<sup>-1</sup>) and Rockall Trough (grenadier, M= 0.31 year<sup>-1</sup>), M would amount to 0.35 year<sup>-1</sup>. We chose to keep the estimate for the Azores and add F of 0.13 year<sup>-1</sup> to obtain a P/B of 0.3 year<sup>-1</sup>. Q/B was estimated at 6.5 year<sup>-1</sup>. Diet data were taken from the Rockall Through (NE Atlantic). The fish of this group prey on various fish of small and medium sizes (67%), 9% on small cephalopods, and the rest on small invertebrates. Their landings amounted to 256 kg·year<sup>-1</sup>.

### **Rays, group 35**

Although this group includes all rays occurring around the Azores (Table 13), the lack of data obliged us to use thornback ray (*Raja clavata*) as a representative. Natural mortality (0.409 year<sup>-1</sup>) was based on the median value found in FishBase for *R. clavata*. We assumed a fishing mortality equals to half the M value, which leads to a P/B value of 0.61 year<sup>-1</sup>. Q/B was estimated at 5.8 year<sup>-1</sup>. Rays are assumed to eat various fish living at the bottom (48%) and shrimps and crabs and other benthos (17% each), and large zooplankton (14%). Diets were derived from *R. clavata* (Azores, Morato-Gomes *et al.*, 1998) and *R. brachyura* (North-east Atlantic, Ellis *et al.*, 1996). Landings were estimated at 102 t·year<sup>-1</sup> or

0.000175 t·km<sup>-2</sup>·year<sup>-1</sup>. In absence of other information, a tentative value of 0.02 t·km<sup>-2</sup>, equivalent to the biomass of large pelagic predators, was entered in Ecopath.

**Table 13.** Species of rays occurring in the Azores

Scientific name	Common name
<i>Torpedo nobiliana</i>	Atlantic torpedo
<i>Raja fullonica</i>	Shagreen ray
<i>Raja brachyura</i>	Broadnose ray
<i>Raja cf. clavata</i>	Thornback ray
<i>Raja cf. maderensis</i>	Madeiran ray
<i>Raja bigelowi</i>	Bigelow's ray
<i>Raja batis</i>	Blue skate
<i>Raja oxyrinchus</i>	Longnosed skate
<i>Dasyatis pastinaca</i>	Common stingray
<i>Dasyatis violacea</i>	Pelagic stingray
<i>Taeniura grabata</i>	Round stingray
<i>Manta birostris</i>	Manta
<i>Mobula tarapacana</i>	Devil ray
<i>Myliobatis aquila</i>	Eagle ray

### **Sharks medium, group 36**

This group is composed of kitefin (*Dalatias licha*), smooth lanternshark (*Etmopterus pusillus*), velvet belly (*Etmopterus spinax*), smallspotted catshark (*Scyliorhinus canicula*), blackmouth catshark (*Galeus melastomus*), and *Deania* spp.

Natural mortality and Q/B were estimated at 0.394 year<sup>-1</sup> and 6.9 year<sup>-1</sup>. We assumed a fishing mortality equals to a third the M value, which leads to a P/B value of 0.51. Landings were estimated at 30 t·year<sup>-1</sup> or 0.00005 t·km<sup>-2</sup>·year<sup>-1</sup>. We assumed discards of 10%. A tentative biomass value of 0.03 t·km<sup>-2</sup> was entered in Ecopath.

Diets were derived from information for kitefin (Catalan waters, Matallanas, 1982) and catshark (West Mediterranean, MacPherson, 1980). Sharks were assumed to eat various fish in the water column (69%), small cephalopods (14%), shrimps and crabs (13%).

### **Sharks large, group 37**

This group is composed of tope shark (*Galeorhinus galeus*), bluntnose sixgill shark (*Hexanchus griseus*), short fin mako (*Isurus oxyrinchus*), blue shark (*Prionace glauca*), and porbeagle (*Lamna nasus*). Growth data came from various locations, but mainly from the North-East Atlantic. Natural mortality and Q/B were estimated to 0.2 year<sup>-1</sup> and 3.1 year<sup>-1</sup>

respectively. We assumed a fishing mortality equals to half the M value, which leads to a P/B value of 0.3. Landings were estimated at 203 t·year<sup>-1</sup> or 0.000348 t·km<sup>-2</sup>·year<sup>-1</sup>. A tentative biomass value of 0.01 t·km<sup>-2</sup> was entered in Ecopath.

Diets were taken after descriptions of tope shark (Azores, Morato-Gomes *et al.*, 1998), porbeagle (Bristol Channel, Ellis and Shackley, 1995) and blue shark (Azores, Clarke *et al.*, 1996). Large sharks eat fish of various habitats (57%) and small cephalopods (30%).

### **Tunas, group 38**

This group includes all species of tunas (Scombridae), except *Sarda sarda*, that occur and are fished around the Azores: skipjack (*Katsuwonus pelamis*), albacore (*Thunnus alalunga*), yellowfin (*T. albacares*), bigeye (*T. obesus*) and northern bluefin (*T. thynnus*). Natural mortality was estimated at 0.33 year<sup>-1</sup>. Fishing mortality (=0.57 year<sup>-1</sup>) for the whole group was obtained by using the average fishing mortality weighted by the 1997 catch (Table 14). However, this seems overestimated due to the large catch and high F estimate for skipjack. P/B was considered too high for a fish that lives so long and its value was reduced to 0.7 year<sup>-1</sup>. Biomass (=0.031 t·km<sup>-2</sup>) was estimated from the ratio catch/F.

Q/B was estimated as 3.5 year<sup>-1</sup>. Total landings were estimated at 6,513 t·year<sup>-1</sup> or 0.011 t·km<sup>-2</sup>·year<sup>-1</sup>. Diet information was scarce, and thus this group is represented by bluefin tuna only (Bay of Biscay, Ortiz de Zarate, 1987). Tuna were assumed to feed mainly on small pelagic inv. (68%), medium pelagic (14%) and planktonic invertebrates (8%).

### **Turtles, group 39**

with the collaboration of Helen R. Martins

The turtles occurring in the Azores are loggerhead (*Caretta caretta*), leatherback (*Dermochelys coriacea*), and green turtles (*Chelonia mydas*), whereas *Eretmochelys imbricata* and *Lepidochelys kempfi* were observed only few times during the last twenty years. Adult loggerhead turtles, *Caretta caretta*, live a benthic life along the Florida coast (Carr, 1986). Juvenile turtles are transported by the North Atlantic Gyre current and live a pelagic life for about 8 years in the Eastern Atlantic, including around the Azores (Bjorndal *et al.*, 2000) where they appear to feed mainly on jellyfish. Turtles have been found in sharks stomach (H.R. Martins, unpublished data). Their abundance is unknown but the by-catch by the pelagic longline swordfish fishery was estimated to be about 4,910 for the entire fleet fishing in the Exclusive Economic Zone of the Azores during the swordfish season, i.e., May to December (estimates of 0.04-0.79 per 1000 hooks) (Ferreira *et al.*, 2001).

Leatherback turtles, *Dermochelys coriacea*, are also caught by the swordfish fishery. Their abundance ratio with loggerhead is thought to be 1:100. We concentrated on the loggerhead turtle at this stage.

P/B and Q/B were based on data used for green turtles in Polovina's Frigate Shoal model (Pauly *et al.*, 1993). Opitz (1996) used a Q/B of 2.8 year<sup>-1</sup> based on studies on two species of turtles feeding respectively on benthic invertebrates and algae. As juvenile loggerheads are likely feeding on jellyfish and perhaps other large planktonic organisms, a value of 3.5 year<sup>-1</sup> would be conservative. As a preliminary estimate, the biomass was assumed to 10% of the biomass used in a Caribbean reef model (Opitz, 1996), that is 0.001 t·km<sup>-2</sup>, and the discards assumed to be 2% of the population size.

**Table 14.** Calculation of fishing mortality (per year) for tunas.

Species	1997 catch (t)	F (year <sup>-1</sup> )	Source
<i>Thunnus obesus</i>	2789	0.35 <sup>a</sup>	(Anon., 1999a)
<i>Thunnus thynnus</i>	108.2	0.25 <sup>b</sup>	(Anon., 1998b)
<i>Katsuwonus pelamis</i>	3610.3	0.75	(Anon., 1999b)
<i>Thunnus alalunga</i>	179.4	0.44	(Anon., 1998a)
<b>Weighted mean</b>	-	0.57	-

<sup>a</sup>probably larger than 0.35 (Fmax) and considered overexploited;

<sup>b</sup>F is 0.1 for ages 6-7; 0.25-0.4 for ages 8+.

**Birds, group 40**

with the collaboration of Veronica Neves

Breeding birds in the Azores are Bulwer's petrel (*Bulweria bulwerii*), Cory's shearwater (*Calonectris diomedea borealis*), Manx shearwater (*Puffinus puffinus*), Madeiran storm petrel (*Oceanodroma castro*), common tern (*Sterna hirundo*) and Roseate tern (*Sterna dougalli*). There are only two resident birds, the little shearwater (*Puffinus assimilis*) and yellow-legged gull (*Larus cachinnans*). The Greater shearwater (*Puffinus gravis*) appear only on its migration path.

Natural mortality is thought to be very low (0.04 year<sup>-1</sup>) for most birds. The daily ration of birds in grams per day was derived using an empirical equation:  $\log R = 0.293 + 0.85 \cdot \log W$  (Nilsson and Nilsson, 1976 in Wada, 1996) where W is the body weight in grams and R the ration in grams per day. Biomass was calculated from the numbers of pairs reported in Monteiro *et al.* (1996b; 1999) multiplied by the body weight (Monteiro *et al.*, 1996a) and the number of days they are present in the Azores (Monteiro *et al.*, 1996a) (Table 15).

Diets came from analysis prey occurrences of the pellets contents (Monteiro *et al.*, 1996b; Granadeiro *et al.*, 1998) that we transformed into weight assuming one prey per pellet and calculating the mean prey of identified preys.

**Marine mammals, groups 41-43,**

with the collaboration of Rui Pietro and Mónica Silva

Marine mammals were separated in three groups based on their diets. Baleen whales (group 41) eat mainly zooplankton and squids and include sperm whales (*Physeter macrocephalus*), minke whales (*Balaenoptera acutorostrata*), sei whales (*Balaenoptera borealis*), blue whales (*Balaenoptera musculus*), fin whales (*Balaenoptera physalus*), and humpback whales (*Megaptera novaeangliae*). Dolphins and toothed whales (group 42) include long-finned pilot whales (*Globicephala melas*), short-finned pilot whales (*Globicephala macrorhynchus*), northern bottlenose whales (*Hyperoodon ampullatus*), Gervais' beaked whales (*Mesoplodon europaeus*), Sowerby's beaked whales (*Mesoplodon bidens*), Cuvier's beaked whales (*Ziphius cavirostris*), common dolphins (*Delphinus delphis*), striped dolphins (*Stenella coeruleoalba*), spotted dolphins (*Stenella frontalis*), Risso's dolphins (*Grampus griseus*), and bottlenose dolphins (*Tursiops truncatus*). The false killer whale (*Pseudorca crassidens*) has been kept in a separate group (43) because they eat other marine mammals.

The diet of sperm whale was taken after Clarke (1993). For all other species, diets were derived from general diet description given in (Pauly *et al.*, 1998) (Table 16). Diet composition attributed to general groups in Pauly *et al.* (1998) were reallocated into the model functional groups according to their most probable preys (Table 17).

**Table 15.** Number, biomass and residence times for aquatic birds present in the Azores.

Species	N pairs	Population abundance	Body weight (g)	N days present	Biomass (kg·km <sup>-2</sup> )
Bulwer's petrel	500-1,000 <sup>a</sup>	1,500	97.7	240	0.00016
Cory's shearwater	49,500-89,000 <sup>a</sup>	138,500	839	270	0.147
Manx shearwater	235 <sup>b</sup>	470	345	181	0.00033
Madeiran storm petrel	740 <sup>b</sup>	1,600	49.2	150	0.000005
Common tern	4,015 <sup>a</sup>	8,030	135.7	168	0.001
Roseate tern	379-1051 <sup>a</sup>	1,984	118.9	168	0.00019
Little shearwater	1,530 <sup>b</sup>	3,060	171	365	0.001
Yellow-legged gull	6,415 <sup>a</sup>	6,415	888	365	0.0195
<b>Sum</b>	63,314 - 194,961	303,629	-	-	0.169

<sup>a</sup>Monteiro *et al.* (1999);<sup>b</sup>Monteiro *et al.* (1996b).



**Table 16.** Marine mammals diet composition in % of wet weight consumed (from Pauly *et al.*, 1998).

Predator	Prey							Mammals
	Small squids	Large squids	Small pelagic	Large plankton	Mesopelagic	Other fish	Benthic invertebrates	
Sperm whale	0.318	0.632			0.05			
Minke whale			0.3	0.65		0.05		
Sei whale	0.05		0.05	0.8	0.05	0.05		
Blue whale				1				
Fin whale	0.05		0.05	0.8	0.05	0.05		
Humpback whale			0.15	0.55		0.3		
<b>Subtotal baleen whales</b>	<b>0.07</b>	<b>0.105</b>	<b>0.092</b>	<b>0.633</b>	<b>0</b>	<b>0.075</b>	<b>0</b>	<b>0</b>
Common dolphin	0.15	0.15	0.1		0.4	0.2		
Striped dolphin	0.2	0.15	0.05		0.3	0.25	0.05	
Northern bottlenose whale	0.35	0.35			0.05	0.1	0.15	
Sowerby's beaked whale	0.25	0.3	0.05		0.2	0.2		
Cuvier's beaked whale	0.3	0.3			0.15	0.15	0.1	
Risso's dolphin	0.5	0.35	0.05			0.05	0.05	
Bottlenose dolphin	0.2	0.05	0.15			0.6		
<b>Subtotal toothed whales</b>	<b>0.279</b>	<b>0.236</b>	<b>0.057</b>	<b>0</b>	<b>0.157</b>	<b>0.221</b>	<b>0.05</b>	<b>0</b>
False killer whale	0.2	0.3				0.3		0.2

**Table 17.** Redistribution of prey items of marine mammals

Original prey group Pauly <i>et al.</i> (1998)	New groups	Predator		
		Baleen whales	Toothed whales	Killer whales
Small squids	Small squids	0.07	0.277	0.2
Large squids	Large squids	0.1	0.236	0.3
	<i>Loligo</i>		0.01	
L. plankton		0.63		
Mesopelagics		0.03	0.157	
Small pelagics	Pelagic S inv.	0.045	0.057	
	Pelagic S pred.	0.046		0.1
Other fish	Pelagic M pred.	0.045		0.1
	Coastal S pred.		0.07	
	Coastal M inv.		0.07	
	Coastal L pred.		0.01	
	Demersal S inv.		0.07	
	Demersal M pred.			0.1
	Deepwater S	0.03		
Benthic invertebrates	Lobster		0.01	
	Shrimps and crabs		0.02	
	Other benthos		0.02	
Mammals	Toothed whales			0.2

The P/B of 0.06 year<sup>-1</sup> for baleen whales (average maximum age for this group is 79 years) was based on the natural mortality of sperm whales (Rice, 1989), which agrees with a maximum age of 69 years found for that species (Trites and Pauly, 1998). The natural mortality for dolphins and toothed whales, was based on an estimate for long-finned pilot whales (M=0.07 year<sup>-1</sup>, maximum age = 55 years), but was increased to 0.1 year<sup>-1</sup> to account for shorter life expectancy of dolphin species. Based on maximum age of the false killer whale, its natural mortality was estimated at 0.07 year<sup>-1</sup>.

Sperm whale's daily consumption was assumed to be of 2.5% of their body weight (Clarke *et al.*, 1998). Q/B values of all other species were calculated using an empirical equation for daily ration  $R=0.1*W^{0.8}$ , modified from Innes *et al.* (1987), where W is body weight in kg and R the daily ration in kg•day<sup>-1</sup>. The mean weight was obtained from Trites and Pauly (1998).

### Biomass

The biomass was taken from the *Sea Around Us* project (SAUP) data base (Kaschner *et al.*, 2001) and adjusted according to their occurrence in the Azores and the number of months they are thought to be present around the Azores, and the size of the model area, about 2% of the North Atlantic (Table 18).

**Table 18.** Abundance and biomass estimates for three groups of whales.

Species	Population	N days in the area	Biomass (t•km <sup>-2</sup> )
<b>Baleen whales</b>			
Sperm whale	3234	182	0.0897
Minke whale	1441 <sup>a</sup>	30 <sup>b</sup>	0.0011
Sei whale	120	90	0.00085
Blue whale	9	90	0.0004
Fin whale	1318	90	0.0309
<b>Sum</b>			0.123
<b>Toothed whales</b>			
Long-finned pilot whale	11,302	20	0.0009
Short-finned pilot whale	1,591	90	0.0004
Common dolphin	13,075	182	0.0009
Striped dolphin	37,845	45	0.0009
Spotted dolphin	1,480	90	0.00006
Northern bottlenose whale	88	182	0.0001
Sowerby's beaked whale	246	182	0.0001
Cuvier's beaked whale	282	182	0.0002
Risso's dolphin	662	365	0.0002
Bottlenose dolphin	1,634 <sup>a</sup>	365	0.0005
<b>Sum</b>			0.0044
<b>False killer whale</b>			
False killer whale	256	90	0.00006

<sup>a</sup>Taken from Trites *et al.* (1997).

<sup>b</sup>Minke whale are not commonly seen in the Azores.

### ***Baleen whales***

Sperm whales are thought to be present all year round in the Azores but are most common in summer. In whaling days, females were absent from the catch in January and February (Clarke, 1956). It is believed that only a small fraction of the population, males only, stays around the Azores while the rest spends the winter southward, in the Canary and Cape Verde Islands and come back in May. Clarke (1998) estimated that about 5600 sperm whales had to be present to sustain the catch during whaling times. Current observations yielded the identification of 400 individuals and it is believed that their population could reach over 900. We used the estimate of the database, that is 3234 individuals. Sperm whales were assumed to stay half the year.

The world population of minke whale is estimated at 800,000 (Trites *et al.*, 1997; Trites and Pauly, 1998; Kaschner *et al.*, 2001) divided in 3 populations: North Atlantic, Pacific, Southern hemisphere and 1,441 in the Azores alone. They are uncommon around the Azores and they prefer cold waters. As they make only brief appearances, we assumed that they stay only 30 days per year in the region.

Sei, blue and fin whales are observed for 3 months around the Azores. Their biomass was taken from the SAUP database. They are mostly seen during the spring (February to May), possibly feeding during their passage (days-weeks) in the Azores. Although there is no data for autumn, they might pass again on their way south. We ignored the humpback whales as they are assumed to migrate the same way through the region and are quite uncommon.

### ***Toothed cetaceans***

Although uncommon, members of the Ziphiidae family are generally considered more common in the Azores than elsewhere. Thus, the present estimate of biomass taken from the data base could be underestimated.

Long-finned whales stay only for a very short time as there are rarely observed around in the Azores. The short-finned pilot whale is observed in the summer with their calves in the region which is at the northern limit of their range distribution (Cawardine, 1995). False killer whales are not frequent around the Azores although are seen every year.

### **DISCUSSION**

We balanced the model by modifying diets that were implying that a fast growing and abundant species would eat large amounts of a scarce, slow growing group. For example, the proportion of lobster in the diet of octopus had to be decreased from 8.5 to 0.1% (Tables 19 to 21). Decreasing cannibalism was also crucial for some groups such as lobster, other benthos and birds.

The use of growth data originating from other region led to inconsistencies in the estimation of P/B and Q/B values and to low P/Q ratios for several fish species. For future versions of this model, this problem will have to be addressed. The construction of this model highlighted the lack of information in some groups, such as benthos density and composition, which would be required to validate the model later on. The islands and seamounts are believed to act as an aggregating device for nutrients and thus several species of fish (Koslow, 1997). Thus the structure of the study area, small islands/shelves surrounded by deep oceanic waters, would warrant the construction of a space-structured model (Ecospace).

### **ACKNOWLEDGEMENTS**

We would like to thank the Pew Charitable Trusts, Philadelphia, USA, for funding the *Sea Around Us* project at the University of British Columbia, Canada. We would also like to thank Dr Ricardo Santos, Director of the Department of the Oceanography Department of the University of the Azores for facilitating the collaboration between the two Universities. We also thank Cameron Ainsworth, Bridget Ferris and Teresa Ryan for the literature and FishBase searches. Our gratitude also goes to Villy Christensen for revising and improving the model considerably.

**Table 19.** Final diet matrix for fish groups. Numbers in italics at the second line of a cell indicate the values in the original matrix; for clarity differences of 0.001 or less have been ignored. L is large, M is medium, and S is small.

Prey \ Predator	13	14	15	16	17	18	19	20	21	22	23	24	25	26	27	28	29	30	31	32	33	34	35	36	37	38	
1 Phytoplankton	0.364 <i>0.08</i>			0.067											0.5	0.146 <i>0.104</i>											0.041
2 Macrophytes	0.455 <i>0.88</i>	0.162 <i>0.14</i>	0.011 <i>0.008</i>	0.783	0.139	0.008								0.004		0.023 <i>0.016</i>											0.002
3 Small zooplankton	0.114 <i>0.025</i>	0.119 <i>0.104</i>	0.204 <i>0.147</i>	0.1	0.070				0.027							0.5	0.088 <i>0.063</i>		0.333		0.133 <i>0.076</i>						0.081
4 Large zooplankton		0.032 <i>0.028</i>	0.056 <i>0.04</i>		0.174	0.006			0.23	0.189		0.019 <i>0.015</i>		0.002		0.088 <i>0.063</i>	0.707 <i>0.46</i>		0.667	0.094	0.215 <i>0.123</i>	0.042	0.137	0.033		0.065	
5 <i>Loligo</i>								0.02								0.001	0.076										
6 <i>Octopus</i>					0.018 <i>0.014</i>	0.174 <i>0.171</i>								0.001		0.001											0.001
7 Cephalopods S		0.005 <i>0.004</i>				0.021 <i>0.020</i>		0.036	0.003	0.002	0.025 <i>0.02</i>	0.087 <i>0.067</i>				0.012 <i>0.009</i>	0.607 <i>0.055</i>			0.038 <i>0.022</i>	0.119 <i>0.094</i>	0.007	0.143 <i>0.140</i>	0.0309 <i>0.306</i>	0.015		
8 Cephalopods L																						0.02					
9 Lobsters						0.006 <i>0.012</i>																					
10 Shrimps and crabs		0.004 <i>0.034</i>	0.038 <i>0.356</i>		0.198	0.26 <i>0.241</i>	0.239 <i>0.233</i>	0.011 <i>0.14</i>	0.005	0.248	0.218	0.073 <i>0.059</i>	0.012 <i>0.01</i>	0.190		-	0.199			0.069 <i>0.2</i>	0.059 <i>0.3</i>	0.185 <i>0.178</i>	0.171 <i>0.169</i>	0.132	0.002		
11 Other benthos	0.068 <i>0.015</i>	0.624 <i>0.642</i>	0.305 <i>0.218</i>	0.017	0.324	0.13	0.051 <i>0.050</i>	0.963 <i>0.856</i>	0.032	0.075	0.124	0.507 <i>0.416</i>	0.005	0.001		0.557 <i>0.354</i>				0.708 <i>0.1</i>	0.405 <i>0.231</i>	0.018	0.171		0.002	0.011	
12 Sea stars		0.001	0.025		0.021			0.004					0.081 <i>0.062</i>			0.002 <i>0.012</i>											
13 Coastal S herb		0.053 <i>0.01</i>			0.019	0.001					0.017 <i>0</i>																
14 Coastal S inv		0.034 <i>0.03</i>	0.25 <i>0.178</i>		0.012	0.182 <i>0.14</i>	0.172 <i>0.168</i>				0.077		0.006 <i>0.004</i>	0.163			0.024 <i>0.016</i>						0.046				
15 Coastal S predator		0.009	0.051 <i>0.036</i>		0.003	0.165 <i>0.127</i>	0.82 <i>0.080</i>						0.014 <i>0.010</i>	0.165													
16 Coastal M herbivorous						-	0.015 <i>0.045</i>																				
17 Coastal M Invertebrate feeder					0.036 <i>0.027</i>	0.07 <i>0.068</i>				0.03		0.018 <i>0.015</i>				0.024 <i>0.016</i>						0.029					
18 Coastal M predator					0.018 <i>0.014</i>	0.065 <i>0.063</i>		0	0.005				0.002 <i>-</i>									0.01				0.028	
19 Coastal L predator																											0.02 <i>0.012</i>
20 Demersal S Invertebrate feeder	0.009			0.018	0.084	0.103		0.331 <i>0.326</i>	0.388 <i>0.392</i>	0.3	0.28		0.422 <i>0.327</i>	0.388				0.179 <i>0.149</i>	0.047 <i>0.1</i>	0.057 <i>0.074</i>	0.104	0.395 <i>0.392</i>	0.191 <i>0.188</i>	0.087 <i>0.085</i>			

Prey \ Predator	13	14	15	16	17	18	19	20	21	22	23	24	25	26	27	28	29	30	31	32	33	34	35	36	37	38
21 <i>Pagellus bogaraveo</i>													0.001										0.007	0.01		
Demersal M						0.001						0.01	0.005				-	0.01				0.006	0.013	0.013	0.059	
22 Invertebrate feeder						0.005						0.2	0.089				0.008	0.056								
23 Demersal M predator									0.001	0.05		0.052	0.88					0.051				0.073	0.07	-	0.087	
<i>Helicolenus</i>													-	0.034							0			0.02		
24 <i>Dactylopterus</i>													0.04													
25 demersal L predator													0.021					0.02							0.059	
													0.035					0.174								
26 <i>Phycis phycis</i>						-	-																			
Pelagic S						0.001	0.02																			
27 Invertebrate feeder											0.109	0.122	0.043			0.058	0.015	0.041				0.053		0.319	0.160	0.681
											0.1	0.047				0.112	0.027	-				0.03		0.314	0.157	
28 Pelagic S predator					0.002						0.02		0.143			0.023	0.152	0.041				0.104	0.021		0.088	
												0.114				0.067	0.473	-							0.085	
29 Pelagic M predator											0.029		0.023	0.005								0.052			0.069	0.141
													0.018													
30 Pelagic L predator																									0.02	
31 Mesopelagics						0.074			0.338	0.087		0.122	0.041	0.045		0.036	0.031				0.082	0.036	0.022		0.107	0.002
						-			0.333			0.099	0.031			-	0.03				0.6	0.097			0.105	
32 Deepwater S										0.02		0.122										0.01	0.130		0.005	-
												0.099										0.047	0.125		0.005	
33 Deepwater M										0.006			0.002			0.014	0.012					0.130			0.007	
																-						0.125				
34 Deepwater L										0.003																
35 Rays																										
36 Sharks M													0.017													
													0.013													
37 Sharks L																										
38 Tunas																										
39 Turtles																										
40 Birds																										
41 Baleen whales																										
42 Dolphins																										
43 Killer whales																										
44 Detritus																										
45 Import																										

**Table 20.** Final diet matrix for non-fish groups. Numbers in italics at the second row of a cell indicate the values in the original matrix. L is large, M is medium, and S is small.

Prey \ Predator	3	4	5	6	7	8	9	10	11	12	39	40	41	42	43
1 Phytoplankton	0.9 <i>1</i>	0.1 <i>0.3</i>							0.017 <i>0.014</i>						
2 Macrophytes									0.002 <i>0.066</i>						
3 Small zooplankton		0.73 <i>0.44</i>						0.1 <i>0.1</i>	0.15 <i>0.1</i>						
4 Large zooplankton		0.02 <i>0.11</i>	0.004 <i>0.003</i>		0.71 <i>0.03</i>	0.41 <i>0.03</i>	0.1 <i>0.2</i>	0.1			1	0.036 <i>0.194</i>	0.63		
5 <i>Loligo</i>			0.05 <i>0.03</i>		0.01							0.054		0.01	
6 <i>Octopus</i>				0.094 <i>0.085</i>											
7 Cephalopods S			0.03	0.011 <i>0.03</i>	0.03	0.22 <i>0.2</i>						0.141 <i>0.194</i>	0.07	0.299 <i>0.277</i>	0.222 <i>0.2</i>
8 Cephalopods L													0.1	0.253 <i>0.236</i>	0.333 <i>0.3</i>
9 Lobsters				0.001 <i>0.085</i>										0.005 <i>0.01</i>	
10 Shrimps and crabs			0.04	0.442			0.05	0.1				0.083		0.022 <i>0.02</i>	
11 Other benthos			0.013	0.442 <i>0.4</i>			0.66	0.3	0.02 <i>0.1</i>	0.7		0.006		0.016 <i>0.02</i>	
12 Sea stars				0.001 <i>0</i>											
13 Coastal S herb.			0.018 <i>0</i>				0.05								
14 Coastal S Inv.			0.018 <i>0</i>									- <i>0</i>			
15 Coastal S predator												0.001		0.075 <i>0.07</i>	
16 Coastal M herbiv.															
17 Coastal M Inv.			0.004											0.011 <i>0.07</i>	
18 Coastal M pred.															
19 Coastal L predator														0.003 <i>0.01</i>	
20 Demersal S Inv.			0.13									0.26 <i>0.22</i>		0.075 <i>0.07</i>	
21 <i>Pagellus bogaraveo</i>			- <i>0.002</i>												
22 Demersal M inv.															
23 Demersal M pred.															- <i>0.1</i>
24 <i>H. dactylopterus</i>															
25 Demersal L pred.			- <i>0.05</i>												
26 <i>Phycis phycis</i>			- <i>0.02</i>												
27 Pelagic S Inv.			0.32 <i>0.31</i>		0.05							0.083	0.045	0.061 <i>0.057</i>	
28 Pelagic S predator			0.32 <i>0.31</i>		0.05	0.11 <i>0.1</i>						0.103	0.046		

<b>Prey \ Predator</b>	<b>3</b>	<b>4</b>	<b>5</b>	<b>6</b>	<b>7</b>	<b>8</b>	<b>9</b>	<b>10</b>	<b>11</b>	<b>12</b>	<b>39</b>	<b>40</b>	<b>41</b>	<b>42</b>	<b>43</b>
29 Pelagic M pred.						- 0.1							0.045		0.111 0.1
30 Pelagic L predator															0.111 0.1
31 Mesopelagics					0.1	0.22 0.2						0.176 0.164	0.034	0.169 0.157	
32 Deepwater S			0.05		0.05	0.11 0.1							0.03		
33 Deepwater M			0.003			- 0.2						0.001	-		
34 Deepwater L						- 0.1									
35 Rays															
36 Sharks M			0.004												
37 Sharks L															
38 Tunas															
39 Turtles															
40 Birds												0 0.008			
41 Baleen whales															
42 Dolphins															0.222 0.2
43 Killer whales															
44 Detritus	0.1	0.15						0.14	0.4	0.803	0.3				
	-									0.72					
45 Import													0.054		

**Table 21.** Parameters matrix after balancing. Parameters estimated by the model are in bold.

	Group name	Trophic level	Biomass (t·km <sup>-2</sup> )	P/B (year <sup>-1</sup> )	Q/B (year <sup>-1</sup> )	EE	P/Q
1	Phytoplankton	1.0	7	290	-	<b>0.32</b>	-
2	Macrophytes	1.0	3.71	4.34	-	<b>0.18</b>	-
3	Small zooplankton	2.0	<b>3.429</b>	60	<b>200</b>	<b>0.95</b>	0.3
4	Large zooplankton	2.5	<b>6.918</b>	5	32	0.8	<b>0.16</b>
5	<i>Loligo</i>	4.0	<b>0.066</b>	2.89	10	0.95	<b>0.29</b>
6	<i>Octopus</i>	3.5	<b>0.013</b>	2.89	10	0.95	<b>0.29</b>
7	Cephalopods S	3.8	<b>0.088</b>	4	10	0.95	<b>0.4</b>
8	Cephalopods L	4.7	<b>0.034</b>	2.5	10	0.95	<b>0.25</b>
9	Lobsters	3.1	0.0045	0.6	<b>10</b>	<b>0.35</b>	0.06
10	Shrimps and crabs	2.6	<b>1.306</b>	1.6	10	0.95	<b>0.16</b>
11	Other benthos	2.2	<b>7.932</b>	2	<b>16.70</b>	0.95	0.12
12	Sea stars	2.8	<b>0.271</b>	0.4	<b>4.44</b>	0.95	0.09
13	Coastal S herbivorous	2.0	<b>0.133</b>	1.07	13	0.95	<b>0.08</b>
14	Coastal S inv.	3.0	<b>0.330</b>	<b>2.625</b>	10.50	0.95	0.25
15	Coastal S predator	3.5	<b>0.259</b>	0.8	8.40	0.95	<b>0.1</b>
16	Coastal M herbivorous	2.1	<b>0.004</b>	0.4	6	0.95	<b>0.07</b>
17	Coastal M inv.	3.2	<b>0.083</b>	0.89	6.90	0.95	<b>0.13</b>
18	Coastal M predator	3.9	<b>0.035</b>	0.45	6.60	0.95	<b>0.07</b>
19	Coastal L predator	4.3	0.02	0.25	4.10	<b>0.18</b>	<b>0.06</b>
20	Demersal S inv.	3.2	<b>0.221</b>	2	11.60	0.95	<b>0.17</b>
21	<i>Pagellus bogaraveo</i>	4.0	0.006	0.66	5.20	<b>0.77</b>	<b>0.13</b>
22	Demersal M inv.	3.9	0.0042	1.2	8.10	<b>0.72</b>	<b>0.15</b>
23	Demersal M predator	3.9	<b>0.068</b>	0.8	6.80	0.95	<b>0.12</b>
24	<i>H. dactylopterus</i>	3.7	0.003	0.8	7.30	<b>0.54</b>	<b>0.11</b>
25	Demersal L predator	4.4	0.024	0.59	4.70	<b>0.62</b>	<b>0.13</b>
26	<i>Phycis phycis</i>	4.1	0.003	0.49	5.50	<b>0.52</b>	<b>0.09</b>
27	Pelagic S inv.	2.5	<b>0.303</b>	2.6	11.30	0.95	<b>0.23</b>
28	Pelagic S predator	3.3	<b>0.543</b>	1.2	6.58	0.95	<b>0.18</b>
29	Pelagic M predator	3.9	<b>0.207</b>	0.36	5.20	0.95	<b>0.07</b>
30	Pelagic L predator	4.6	0.02	0.5	2.80	<b>0.09</b>	<b>0.18</b>
31	Mesopelagics	3.2	2	3	14.40	<b>0.06</b>	<b>0.21</b>
32	Deepwater S	4.0	<b>0.184</b>	0.8	5	0.95	<b>0.16</b>
33	Deepwater M	3.7	<b>0.006</b>	0.3	8	0.95	<b>0.04</b>
34	Deepwater L	4.4	<b>0.0003</b>	0.3	6.50	0.95	<b>0.05</b>
35	Rays	3.9	0.02	0.61	5.80	<b>0.01</b>	<b>0.1</b>
36	Sharks M	4.0	0.03	0.51	6.90	<b>0.13</b>	<b>0.07</b>
37	Sharks L	4.3	0.01	0.3	3.10	<b>0.12</b>	<b>0.1</b>
38	Tunas	3.8	0.03	0.7	3.50	<b>0.5</b>	<b>0.2</b>
39	Turtles	3.5	0.001	0.15	3.50	<b>0</b>	<b>0.04</b>
40	Birds	4.2	0.0002	0.04	84.39	<b>0.21</b>	<b>0.0005</b>
41	Baleen whales	4.0	0.165	0.06	5.56	<b>0</b>	<b>0.01</b>
42	Dolphins	4.8	0.027	0.1	11.41	<b>0.46</b>	<b>0.01</b>
43	Killer whales	5.4	0.0002	0.07	10.27	<b>0</b>	<b>0.01</b>
44	Detritus	1.0	1	-	-	<b>0.12</b>	-



## REFERENCES

- Akimushkin, I. I., 1965. Cephalopods of the seas of the U.S.S.R. A. Mercado (translator), available from U.S. Dept. of Commerce, Clearinghouse for Federal Scientific and Technical Information, Springfield, Va, Jerusalem, Israel Program for Scientific Translations. 223 pp.
- Angel, M. V. 1989. Vertical profiles of pelagic communities in the vicinity of the Azores Front and their implications to deep ocean biology. *Progress in Oceanography*, 22:1-46.
- Anon., 1998a. Albacore 1998 detailed report. International Commission for the Conservation of Atlantic Tunas (ICCAT), Madrid, Spain, 49 pp
- Anon., 1998b. Report of the ICCAT SCRS bluefin tuna stock assessment session. International Commission for the Conservation of Atlantic Tunas (ICCAT), Genoa, Italy, SCRS/98/22. 191 pp
- Anon., 1999a. Report of the ICCAT SCRS skipjack stock assessment session. International Commission for the Conservation of Atlantic Tunas (ICCAT), Funchal, Madeira, Portugal, SCRS/99/21. 47 pp
- Anon., 1999b. Swordfish (*Xiphias gladius*). International Commission for the Conservation of Atlantic Tunas (ICCAT), Madrid, Spain, Report of the Standing Committee on research and statistics, Executive summary, 8 pp
- Arai, M., 1996. Carnivorous zooplankton, jellies and *Veleva* in the Alaska Gyre. pp. 18-19. In: Mass-balance models of North-eastern Pacific ecosystems. Ed. by D. Pauly and V. Christensen, Fisheries Centre Research Report 4(1).
- Azevedo, J. M. N. 1995. Food web of the Azorean shallow water marine ichthyological communities: a guild approach. *Bol. Mus. Mun. Funchal, Sup.* 4:25-53.
- Azevedo, J. M. V. O. N., 1997. Estrutura de uma comunidade ictiológica do litoral da ilha de S. Miguel (Açores): caracterização e variações espaço-temporais. Tese de Doutoramento thesis, Universidade dos Açores, Ponta Delgada, 178 pp.
- Banse, K., and Mosher, S. 1980. Adult body mass and annual production/ébiomass relationships of field populations. *Ecological Monographs*, 50:355-379.
- Barreiros, J. P., and Santos, R. S. 1998. Notes on the food habits and predatory behaviour of the dusky grouper, *Epinephelus marginatus* (Lowe, 1834) (Pisces: Serranidae) in the Azores. Arquipélago. Life and Marine Sciences., 16A:29-35. Ponta Delgada. ISSN 0873-4704.
- Bjorndal, K. A., Bolten, A. B., and Martins, H. R. 2000. Somatic growth model of juvenile loggerhead turtles in the Azores Arquipélago. *Marine Ecology Progress Series*, 202:265-272.
- Brey, T., 1995. Empirische Untersuchungen zur Populationsdynamik makrobenthischer Evertabraten. Habilitation thesis thesis, University of Bremen, Germany, 170 pp.
- Brey, T. 1999. A collection of empirical relations for use in ecological modelling. *NAGA, the ICLARM Quarterly*, 22(3):24-28.
- Buchary, E. A., Haggan, N., Sumaila, U. R., and Pitcher, T. J., (eds.). 2001. Spatial simulations of Hong Kong's Marine Ecosystem: ecological and economic forecasting of marine protected areas with artificial reefs. Fisheries Centre Research Report 10(3).
- Bundy, A., Lilly, G. R., and Shelton, P. A., 2000. A mass balance model of the Newfoundland-Labrador shelf. Canadian Technical Report of Fisheries and Aquatic Sciences, 2310. xiv + 157 pp
- Carr, A. 1986. Rips, FADS, and little loggerheads. *BioScience*, 36:92-100.
- Cawardine, M., 1995. Whales, dolphins and porpoises. The visual guide to all the cetaceans. Stoddart Publishing, Toronto, Canada. 256 pp.
- Christensen, V., 1996. Balancing the Alaska gyre model. pp. 32-36. In: Mass-balance models of North-eastern Pacific ecosystems. Ed. by D. Pauly and V. Christensen. Fisheries Centre Research Report 4(1).
- Clarke, M. R., Clarke, D. C., Martins, H. R., and Da Silva, H. M. 1996. The diet of the blue shark (*Prionace glauca* L.) in Azorean waters. Arquipélago. Life and Marine Sciences., 14A:41-56. Ponta Delgada. ISSN 0873-4704.
- Clarke, M. R., Clarke, D. C., Martins, H. R., and Silva, H. M. 1995. The diet of swordfish (*Xiphias gladius*) in Azorean waters. Arquipélago. Life and Marine Sciences., 13A:53-69. Ponta Delgada. ISSN 0873-4704.
- Clarke, M. R., Martins, H. R., and Pascoe, P. 1993. The diet of sperm whales (*Physeter macrocephalus* Linnaeus 1758) off the Azores. *Philosophical Transactions of the Royal Society of London Serie B*, 339:67-82.
- Clarke, M. R., Santos, M. B., and Pierce, G. J., 1998. The importance of cephalopods in the diets of marine mammals and other top predators. *ICES Council Meeting, 1998/M:8*. 8 pp
- Clarke, R. 1956. Sperm whales of the Azores. *Discovery reports*, 28:237-298.
- Coelho, M., Domingues, P., Balguerías, E., Fernandez, M., and Andrade, J. P. 1997. A comparative study of the diet of *Loligo vulgaris* (Lamarck, 1799) (Mollusca: Cephalopoda) from the south coast of Portugal and the Saharan Bank (Central-East Atlantic). *Fisheries Research*, 29:245-255.
- Coma, R., Gili, J.-M., and Zabala, M. 1995. Trophic ecology of a benthic marine hydroid, *Campanularia everta*. *Marine Ecology Progress Series*, 119:211-220.
- Corkett, C. J., and McLaren, I. A. 1978. The biology of *Pseudocalanus*. *Advances in Marine Biology*, 17:1-454.
- Cortés, E. 1999. Standardized diet compositions and trophic levels of sharks. *ICES Journal of Marine Science*, 56:707-717.
- Cushing, D. H., Humphrey, G. F., Banse, K., and Laevastu, T. 1958. Report of the committee on terms and equivalents. *Rapports et Procès-Verbaux des Réunions du Conseil Permanent International pour l'Exploration de la Mer*, 14(4):15-16.
- Dean, T. A., 1999. Shallow large infauna. pp. 21-22. In: Trophic mass-balance model of Alaska's Prince William Sound ecosystem, for the post-spill period 1994-1996. Second edition. Ed. by T. A. Okey and D. Pauly. Fisheries Centre Research Report 7(4).
- D'Onghia, G., Tursi, A., Marano, C. A., and Basanisi, M. 1998. Life history traits of *Hoplostethus mediterraneus* (Pisces: Beryciformes) from the North-Western Ionian Sea (Mediterranean Sea). *Journal of Marine Biology Association U.K.*, 78:321-339.
- Duka, L. A., and Shevenko, N. F. 1988. Morphology and nutrition of *Chromis chromis* (Linné) in the Mediterranean and Black Seas. *Ehkol Morya*, 3:26-33.
- Ellis, J., Pawson, R., G., M., and Shackley, S. E. 1996. The comparative feeding ecology of six species of shark and four species of ray (Elasmobranchii) in the north-east Atlantic. *Journal of Marine Biology Association U.K.*, 76:89-106.
- Ellis, J. R., and Shackley, S. E. 1995. Notes on porbeagle sharks, *Lamna nasus*, from the Bristol Channel. *Journal of Fish Biology*, 46:368-370.
- Fasham, M. J. R., T.Platt, Irwin, B., and Jones, K. 1985. Factors affecting the spatial pattern of the deep chlorophyll maximum in the region of the Azores Front. *Progress in Oceanography*, 14:129-165.
- Ferraz, R. R., Menezes, G. M., and Santos, R. S. 2001. Limpet (*Patella* spp.) (Mollusca: Gastropoda) exploitation in the Azores, during the period 1993-1998. Arquipélago.

- Life and and Marine Sciences, Supplement 2 (part B):59-65.
- Ferreira, R. L., Martins, H. R., Silva, A. A., and Bolten, A. B. 2001. Impact of swordfish fisheries on sea turtles in the Azores. *Arquipélago. Life and and Marine Sciences*, 18A:75-79.
- Figuerido, M., 1999. Ecologia alimentar do sargo, *Diplodus sargus* (Pisces: Sparidae), e do bodião vermelho, *Labrus bergylta* (Pisces Labridae), na ilha do Faial-Açores. Faculdade de Ciências da Universidade de Lisboa, Lisbon, Portugal, Relatório de estágio, licenciatura em Biologia Aplicada aos Recursos Animais, 18 pp
- Garnaud, J., 1962. Monographie de l'Apogon méditerranéen: *Apogon imberbis* (L.) 1758. Bull. Inst. Océanogr. Monaco, Vol. 1248, 83 pp.
- Gibson, R. N., and Ezzi, I. A. 1987. Feeding relationships of a demersal fish assemblage on the west coast of Scotland. *Journal of Fish Biology*, 31:55-69.
- Gibson, R. N., and Robb, L. 1996. Piscine predation on juvenile fishes on a Scottish sandy beach. *Journal of Fish Biology*, 49:120-138.
- Gonçalves, J. M. 1991. The octopoda (Mollusca: Cephalopda) of the Azores. *Arquipélago. Life and and Marine Sciences.*, 9:75-81.
- Gonçalves, J. M., 1993. *Octopus vulgaris* Cuvier 1797 (polvo comum): Sinopse da biologia e exploração. MSc thesis, University of the Azores, Horta, Portugal, 470 pp.
- Gordon, J. D. M., and Mauchline, J. 1996. The distribution and diet of the dominant slope-dwelling eel, *Synaphobranchus kaupi*, of the Rockall Through. *Journal of Marine Biology Association U.K.*, 76:493-503.
- Gorelova, T. A., Agafonova, T. B., and Lipskaya, N. J. 1994. Feeding of cigarfishes (Genus *Cubiceps*, Stromateoidei). *Journal of Ichthyology*, 34(7):70-82.
- Granadeiro, J. P., Monteiro, L. R., and Furness, R. W. 1998. Diet and feeding ecology of Cory's shearwater *Calonectris diomedea* in the Azores, north-east Atlantic. *Marine Ecology Progress Series*, 166:267-276.
- Harmelin-Vivien, M. L., Kaim-Malka, R. A., Ledoyer, M., and Jacob-Abraham, S. S. 1989. Food partitioning among scorpaenid fishes in Mediterranean seagrass beds. *Journal of Fish Biology*, 34:715-734.
- Hunter, E. 1999. Biology of the European spiny lobster, *Palinurus elephas* Fabricius, 1787 Decapoda, Palinuridea. *Crustaceana*, 72(6):545-566.
- Innes, S., Lavigne, D. M., Earle, W. M., and Kovacs, K. M. 1987. Feeding rates of seals and whales. *Journal of Animal Ecology*, 56:115-130.
- Isidro, E. J., 1996. Biology and population dynamics of selected demersal fish species of the Azores Archipelago. PhD thesis, University of Liverpool, Port Erin, Isle of Man, UK, 249 pp.
- Jarre-Teichmann, A., and Guénette, S., 1996. Invertebrate benthos. pp. 38-39. In: Mass-balance models of North-eastern Pacific ecosystems. Ed. by D. Pauly and V. Christensen. Fisheries Centre Research Report 4(1).
- Kaschner, K., Watson, R., Christensen, V., Trites, A. W., and Pauly, D., 2001. Modeling and mapping trophic overlap between marine mammals and commercial fisheries in the North Atlantic. pp. 35-45. In: Fisheries impacts on North Atlantic Ecosystems: Catch, effort and national/regional data sets. Ed. by D. Zeller, R. Watson, and D. Pauly. Fisheries Centre Research Report 9(3).
- Khoury, C., 1987. Ichthyofaune des herbiers de Posidonies du parc National de Port-Cros: composition, éthologie alimentaire et rôle dans le réseau trophique. Doctoral Thesis thesis, Université Aix-Marseille II, France.
- Koslow, J. A. 1997. Seamounts and the ecology of deep-sea fisheries. *American Scientist*, 85:168-176.
- Labropoulou, M., and Eleftheriou, A. 1997. The foraging ecology of two pairs of congeneric demersal fish species: importance of morphological characteristics in prey selection. *J. Fish Biol*, 50:324-340.
- Lalli, C. M., and Parsons, T. R., 1993. Biological oceanography. Pergamon Press, New York, 301 pp.
- Li, W. K. 1994. Phytoplankton biomass and chlorophyll concentration across the North Atlantic. *Scientia Marina*, 58(1-2):67-79.
- Mackinson, S., 1996. System definition and primary production. pp. 63-64. In: Mass-balance models of North-eastern Pacific ecosystems. Ed. by D. Pauly and V. Christensen. Fisheries Centre Research Report 4(1).
- MacPherson, E. 1980. Régime alimentaire de *Galeus melastomus* Rafinesque, 1810, *Etmopterus spinax* (L., 1758) et *Scymnorhinus licha* (Bonnaterre, 1788) en Méditerranée occidentale. *Vie et Milieu*, 30:139-148.
- Macpherson, E. 1981. Resource partitioning in a Mediterranean demersal fish community. *Marine Ecology Progress Series*, 4:183-193.
- Mannini, P., Reale, B., and Righini, P. 1990. Osservazioni sulla biologia e la pesca di *Lepidorhombus boscii* (Risso) (Osteichthyes, Scophthalmidae) nel tirreno settentrionale. *Oebelia*, 16(1):245-255.
- Martins, H. R. 1985. Biological studies of the exploited stock of the Mediterranean locust lobster *Scyllarides latus* (Latreille, 1803) (Decapoda: Scyllaridae) in the Azores. *Journal of Crustacean Biology*, 5:294-305.
- Martins, H. R., and Hargreaves, P. M. 1991. Shrimps of the families Pandalidae and Hippolytidae (Crustacea: Decapoda) caught in benthic traps of the Azores. *Arquipélago. Life and and Marine Sciences.*, 9:47-61.
- Matallanas, J. 1982. Feeding habits of *Scymnorhinus licha* in Catalan waters. *Journal of Fish Biology*, 20:155-163.
- Mauchline, J., and Gordon, J. D. M. 1984. Occurrence and feeding of berycomorphid and percomorphid teleost fish in the Rockall Trough. *Journal du Conseil International pour l'Exploration de la Mer*, 41:239-247.
- Menezes, G., Silva, H. M., Krug, H., Balguerias, E., Delgado, J., Pérez, J. G., Soldevilla, I. L., Nespereira, J. L., Carvalho, D., and Moralles, J. S., 1998. Design optimisation and implementation of demersal cruises surveys in the Macaronesian Archipelagos. Final report. Departamento de Oceanografia e Pescas, Universidade dos Açores, Horta, Portugal, Arquivos do DOP. Série Estudos, 3/98. 162 pp
- Meyer, M., and Smale, M. J. 1991a. Predation patterns of demersal teleosts from the Cape south and west coasts of South Africa. 1. Pelagic predators. *South African Journal of Marine Sciences*, 11:173-191.
- Meyer, M., and Smale, M. J. 1991b. Predation patterns of demersal teleosts from the Cape south and west coasts of South Africa. 2. Benthic and epibenthic predators. *South African Journal of Marine Sciences*, 11:409-442.
- Monteiro, L. R., Ramos, J. A., Furness, F. W., and del Nevo, A. J. 1996a. Movements, morphology, breeding, molt, diet and feeding of seabirds in the Azores. *Colonial Waterbirds*, 19:82-97.
- Monteiro, L. R., Ramos, J. A., and Furness, R. W. 1996b. Past and present status and conservation of the seabirds breeding in the Azores Archipelago. *Biological Conservation*, 78:319-328.
- Monteiro, L. R., Ramos, J. A., Pereira, J. C., Monteiro, P. R., Feio, R. S., Thompson, D. R., Bearhop, S., Furness, R. W., Laranjo, M., Hilton, G., Neves, V. C., Groz, M. P., and Thompson, K. R. 1999. Status and distribution of Fea's petrel, Bulwer's petrel, Manx shearwater, Little shearwater and Band-rumped storm-petrel in the Azores Archipelago. *Waterbirds*, 78:319-328.
- Morato, T., Guénette, S., and Pitcher, T., 2001. Fisheries of the Azores, 1982-1999. pp 214-220. In: Fisheries impacts on North Atlantic Ecosystems: Catch, effort and national/regional data sets. Ed. by D. Zeller, R.

- Watson, and D. Pauly. Fisheries Centre Research Report 9(3).
- Morato, T., Santos, R. S., and Andrade, J. P. 2000. Feeding habits, seasonal and ontogenic diet shift of balcktail comber, *Serranus atricauda* (Pisces: Serranidae), from the Azores, Northeastern Atlantic. Fisheries Research, 49:51-59.
- Morato, T., Solà, E., Grós, M. P., and Menezes, G. 1999. Diets of forkbead (*Phycis phycis*) and conger eel (*Conger conger*) off the Azores during spring of 1996 and 1997. Arquipélago. Life and and Marine Sciences., 17A:51-64. Ponta Delgada.
- Morato, T., Solà, E., Grós, M. P., and Menezes, G. in press. Feeding habits of two congener species of seabreams, *Pagellus bogaraveo* and *Pagellus acarne*, off the Azores (Northeastern Atlantic) during spring of 1996 and 1997. Bull Mar Sci,
- Morato, T., Solà, E., Grós, M. P., and Menezes, G. unpublished data. Diet of the two most common elasmobranchs in the bottom longline fishery of the Azores, northeastern Atlantic: thornback ray *Raja cf. clavata* and tope shark, *Galeorhinus galeus*.
- Morato-Gomes, T., Solà, E., Grós, M. P., Menezes, G., and Pinho, M. R., 1998. Trophic relationships and feeding habits of demersal fishes from the Azores: importance to multispecies assessment. ICES Council Meeting, 1998/O:7. 21 pp
- Moreno, T., and Castro, J. J. 1995. Community structure of the juvenile of coastal pelagic fish species in the Canary Islands waters. Scientia Marina, 59:405-413.
- Nash, R. D. M., Geffen, A. J., and Santos, R. S. 1991. The wide-eyed flounder, *Bothus podas* Delaroché, a singular flatfish in varied shallow-water habitats of the Azores. Netherlands Journal of Sea Research, 27:367-373.
- Neto, A. I. d. M. A., 1997. Studies on algal communities of São Miguel, Azores. PhD thesis, Universidade dos Açores, Ponta Delgada, Portugal, 309 pp.
- Oliveira, M. R., 1997. Ecologia alimentar de *Tripterygion delaisi* Cadenat & Blach (1971) (Pisces: Tripterygiidae) dos Açores: análise faseada do tracto digestivo, variação temporal e sexual da dieta. Tese de Licenciatura thesis, Universidade do Algarve, Faro, Portugal, 85 pp.
- Opitz, S., 1996. Trophic interactions in Caribbean coral reefs. ICLARM, Manila, Philippines, ICLARM Technical Report, 43. 341 pp
- Ortiz de Zarate, V. 1987. Datos sobre la alimentacion del atun blanco (*Thunnus alalunga* B.) juvenil capturado en el golfo de Viscaya. Collective volume of scientific papers. International Commission for the Conservation of Atlantic Tunas, 26(2):243-247.
- Papaconstantinou, C., and Caragitsou, E. 1989. Feeding interactions between two sympatric species *Pagrus pagrus* and *Phycis phycis* around Kastellorizo island (Dodecanese, Greece). Fish. Res, 7:329-342.
- Pauly, D. 1980. On the interrelationships between natural mortality, growth parameters, and mean environmental temperature in 175 fish stocks. Journal du Conseil International pour l'Exploration de la Mer, 39:175-192.
- Pauly, D., 1984. Fish population dynamics in tropical waters: a manual for use with programmable calculators. ICLARM Studies and Reviews, Vol. 8, 325 pp.
- Pauly, D., and Christensen, V. 1995. Primary production required to sustain global fisheries. Nature, 374:255-257.
- Pauly, D., and Munro, J. L. 1984. Once more on the comparison of growth in fish and invertebrates. Fishbyte, 2:21.
- Pauly, D., Soriano-Bartz, M. L., and Palomares, M. L. D., 1993. Improved construction, parametrization and interpretation of steady-state ecosystem models. In: Trophic models of aquatic ecosystems. pp. 1-13, Ed. by V. Christensen and D. Pauly, ICLARM Conference Proceeding, Vol. 26, 390 pp.
- Pauly, D., Trites, A. W., Capuli, E., and Christensen, V. 1998. Diet composition and trophic levels of marine mammals. ICES Journal of Marine Science, 55:467-481.
- Pierce, G. J., Boyle, P. R., Hastie, L. C., and Santos, M. B. 1994. Diets of squid *Loligo forbesi* and *Loligo vulgaris* in the Northeast Atlantic. Fisheries Research, 21:149-163.
- Porteiro, F. M. 1994. The present status of the squid *Loligo forbesi* in the Azores Arquipélago. Fisheries Research, 21:243-253.
- Quignard, J.-P., and Pras, A., 1986. Scaridae. In: Fishes of the north-eastern Atlantic and the Mediterranean. pp. 934-944, Ed. by M.-L. B. P.J.P. Whitehead, J.-C. Hureau, J. Nielsen and E. Tortonese, UNESCO, Paris, Vol. 2.
- Randall, J. E. 1967. Food habits of reef fishes of the West Indies. Stud. Trop. Ocean. Miami, 5:665-847.
- Raymont, J. E. G., 1983. Plankton and productivity in the oceans. Pergamon Press, Toronto. Vol. 2 - Zooplankton, 824 pp.
- Ribeiro, C. C. S., 1998. Carcaterização da ictiofauna da Baía do Cais do Carvão (Funchal – Ilha da Madeira) e aspectos da biologia de *Abudefduf luridus*. Relatório de estágio, Faculdade de Ciências, Universidade de Lisboa, Lisbon, Portugal, 50 pp
- Rice, D. N., 1989. Sperm whale- *Physeter macrocephalus* Linnaeus 1758. In: Handbook of marine mammals. pp. 177-235, Ed. by S. H. Ridgway and R. Harrison, Academic Press Ltd, London, 442 pp., Vol. 14.
- Santos, R. S., and Barreiros, J. P. 1993. The ethogram of *Parablennius sanguinolentus parvicornis* (Valenciennes in Cuvier & Valenciennes, 1836) (Pisces: Blennidae) from the Azores. Arquipélago. Life and and Marine Sciences, 11A:73-90.
- Santos, R. S., Nash, R. D. M., and Hawkins, S. J. 1995. Age, growth and sex ratio of the Azorean rock-pool blenny, *Parablennius sanguinolentus parvicornis*. Journal of Marine Biology Association U.K., 75:751-754.
- Santos, R. S., Porteiro, F. M., and Barreiros, J. P. 1997. Marine fishes of the Azores: annotated checklist and bibliography. Arquipélago. Life and and Marine Sciences, Supplement 1, 244 pp
- Silva, A. 1999. Feeding habits of John Dory, *Zeus faber*, off the Portuguese continental coast. Journal of Marine Biology Association U.K., 79:333-340.
- Silva, C. S. G. M., 2000. Estudo da comunidade epizooplancónica da costa sul da ilha do Faia, Arquipélago dos Açores. Relatório de Estágio thesis, Universidade de Lisboa, Lisboa, Portugal, 18 pp.
- Sobrinho-Gonçalves, L., and Isidro, E. 2001. Fish larvae and zooplankton biomass around Faial Island (Azores Archipelago). A preliminary study of species occurrence and relative abundance. Arquipélago. Life and and Marine Sciences, 18A:35-52.
- Trites, A., and Pauly, D. 1998. Estimating mean body masses of marine mammals from maximum body lengths. Canadian Journal of Zoology, 76:886-896.
- Trites, A. W., Christensen, V., and Pauly, D. 1997. Competition between fisheries and marine mammals for prey and primary production in the Pacific Ocean. Journal of Northwest Atlantic Fishery Science, 22:173-187.
- Tsarin, S. A., 1997. Myctophids of the sound scattering layer and their place in pelagic food webs. In: Proceedings of the International Symposium on the Role of Forage Fishes in Marine Ecosystems, pp. 271-275, University of Alaska Fairbanks. Vol. University of Alaska Sea Grant Program report: 97-01.
- Tuset, V. M., González, J. A., García-Díaz, M. M., and Santana, J. I. 1996. Feeding habits of *Serranus cabrilla* (Serranidae) in the Canary Islands. Cybium, 20(2):161-167.

- Velasco, F., Olaso, I., and de la Gándara, F., 1996. Alimentación de veintidós especies de peces demersales de la División VIIIc de la ICES. Otoños de 1992 y 1993. Informes Técnicos, Instituto Español de Oceanografía, 164. 62 pp.
- Verlarque, M. 1990. Relations entre *Sarpa salpa* (Linnaeus, 1758) (Téléostéen Sparidae), les autres poissons brouteurs et le phytobenthos algal méditerranéen. *Oceanologica Acta*, 13:373-388.
- Vieira, C., unpublished data. Eco-etologia alimentar de salmonete, *Mullus surmuletus*, dos Açores. Relatório de estágio, licenciatura em Ciências do Meio Aquático thesis, Instituto de Ciências Biomédicas Abel Salazar, Universidade do Porto, Porto, Portugal.
- Wada, Y., 1996. Marine mammals and birds. p. 71. In: Mass-Balance Models of North-eastern Pacific Ecosystems. Ed. by D. Pauly and V. Christensen. Fisheries Centre Research Report 4(1).
- Ward, P., and Elscot, S., 2000. Broadbill swordfish status of world fisheries. Bureau of Rural Sciences, Canberra, Australia, 208 pp.
- Wiebe, P. H., Boyd, S., and Cox, J. L. 1975. Relationships between zooplankton displacement volume, wet weight, dry weight, and carbon. *Fishery Bulletin*, 73:777-786.

## THE BAY OF BISCAY, FRANCE: 1998 AND 1970 MODELS

**Cameron Ainsworth, Bridget Ferriss, Emilie Leblond, and Sylvie Guénette**

*Fisheries Centre, University of British Columbia  
2204 Main Mall, Vancouver, BC, V6T 1Z4, Canada  
email: s.guenette@fisheries.ubc.ca*

### ABSTRACT

A present-day (1998) mass-balance model of the Bay of Biscay, France (ICES areas VIIIa/b) was constructed using the Ecopath with Ecosim software package. Over 200 species of fish, invertebrates, birds, marine mammals and primary producers were considered. Basic Ecopath parameters and diet matrices were determined from the literature, while catch information was obtained from the ICES STATLANT database. The initial model was submitted to French experts, and their suggestions were included in subsequent revisions of the model. The methodology used to construct a similar model, but covering the 1970s, is also presented.

### INTRODUCTION

In this model, 38 functional groups are represented by 158 species of fish, 16 cephalopods, 12 crustaceans (crabs, shrimps and prawns), 10 species of zooplankton (2 small, 8 large), 14 seabirds, 24 cetaceans (19 toothed, 5 baleen), 3 echinoderms, 2 worms and several more (generic) representatives of molluscs, benthic infauna and primary producers. Although this model covers a wide range of trophic interactions, it was sometimes difficult to estimate average group parameters as only the most abundant and/or commercially important species appear in the literature. Where practical, important species were given their own group, (e.g., common forage fish such as anchovy and sardine). Consumption, production and particularly biomass were consistently found only for important species. Data for less abundant, but ecologically similar species were often limited. Various assumptions were required to accommodate groups which included data-deficient species.

### Geography and Oceanography of Bay of Biscay

The Bay of Biscay is a feature of the North Atlantic, along the West coast of France, extending from the Brittany peninsula in the

north, to Spain in the south (Figure 1). The entire bay covers an area of approximately 223,000 km<sup>2</sup> but this model includes only ICES Areas VIIIa and b (96,587 km<sup>2</sup>; Figure 1) of which 20,867 km<sup>2</sup> are shallow (<50 m), 57,677 km<sup>2</sup> are of medium depth (<200 m) and 18,043 km<sup>2</sup> are deep (>200 m). The principal rivers flowing into the bay are the Loire, the Ardour, the Dordogne and the Garonne which forms the Gironde Estuary. The continental shelf is 160 km off the coast of Brittany in the north and narrows to 65 km off the Spanish coast. Neither ICES Areas VIIIa nor b extend as far as the continental slope.

### Currents

Surface currents in the Bay of Biscay circulate clockwise, as in the North Atlantic in general. The tidal range is 6 m in the north (Ouessant Is.) and 3.5 m in the south (Biarritz). The bay is subject to rough seas and gales in excess of 113 km·hours<sup>-1</sup>. Average ocean temperature is 13.9 °C, taken as the yearly average from Carnac and Saint-Nazaire in the north Bay of Biscay (Area VIIIa), and Royan and Hossegor in the south (Area VIIIb) (Fremy and Fremy, 1998).

### Notes on classifications of fish groups

All divisions were based on length first since this factor influences the size of prey items consumed. Classifications were further performed on the basis of weight where there was enough range to merit an additional group. Large-sized fish were defined as being greater than 60 cm, medium as between 30-60 cm and small as under 30 cm (based on  $L_{max}$ ; total length). Very small demersals (independently of trophic levels (TL)) were separated from the small demersals on the basis of weight, with an asymptotic weight of 20 g as cut-off weight. Very large demersals were large demersals with body weights in excess of 6 kg.

High and low trophic groups (e.g., small pelagic high TL/small pelagic low TL) were divided based on average approximate trophic levels (from FishBase; Froese and Pauly, 2000) of 3.67 and 3.07 for 'small pelagic high TL' and 'small pelagic low TL', respectively, 4.033 and 3.326 for 'very large demersal high TL' and 'very large demersal low TL', and 3.5 and 2.81 for 'very small demersal high TL' and 'very small demersal low TL'.

### Notes on the diets of fish groups

When diet information comes from other ecosystems, there is a broad range of prey items that are not included in any group representing the basic parameters. In such cases, the item is

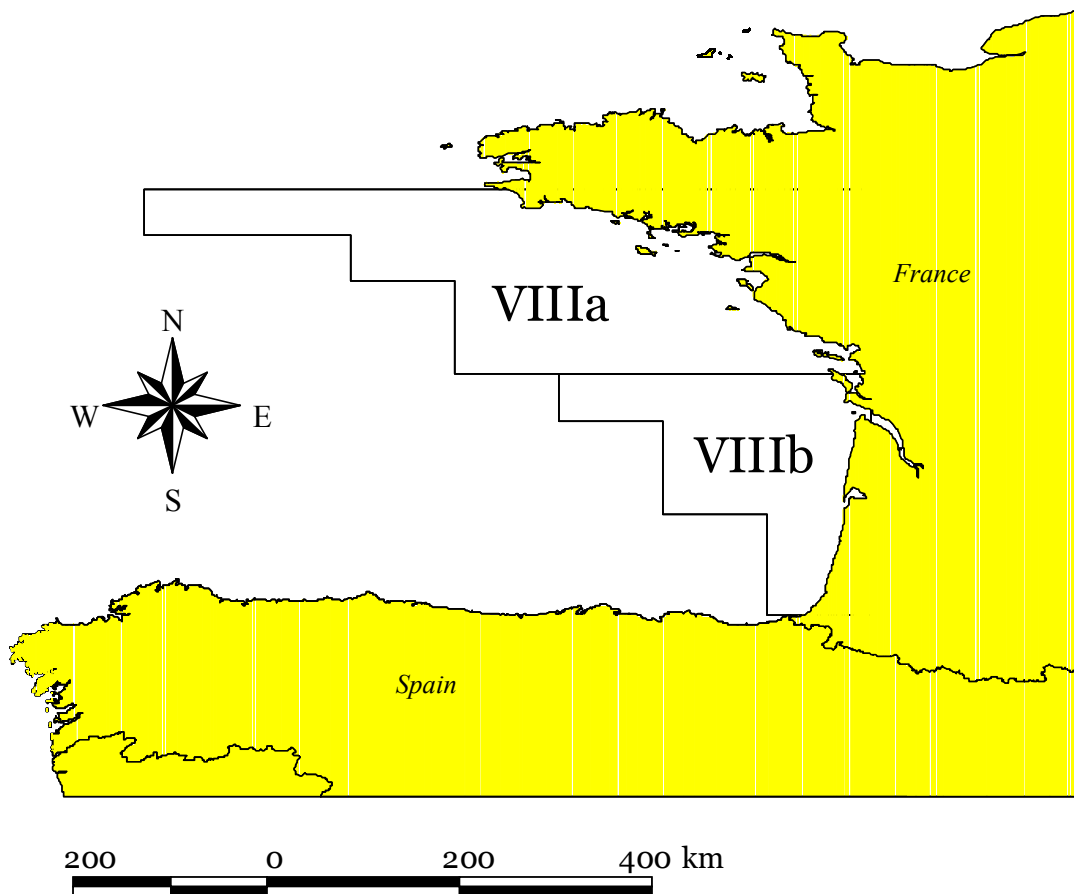

**Figure 1.** Location of the Bay of Biscay showing the two ICES statistical areas (VIII a and b) featured in this model.

classified into an existing group for the purpose of the diet matrix only. For instance, there are 50 prey items varying from species to family that have been classified as 'small deepwater' fish in the diet matrix, although the model is represented by only 9 fish.

When quantitative diet information was lacking, all identified prey items were assumed of equal importance in the initial diet matrix. Where qualitative descriptions of the diet were available, the following assumptions were made; 'primarily', 'principally' and 'mainly' were all assumed to equal 80%, 'predominantly' and 'major' were assumed to equal 60% and 'minor' to equal 20%.

For all fish groups, unidentified nekton, unidentified bony fish and unidentified finfish (from FishBase or the literature) were divided equally among likely prey for that predator group. Likely prey groups were generally assumed to occupy smaller size classes of the same habitat group, (e.g., large demersal prey; unidentified bony fish, was assumed to consist equally of 'medium demersal', 'small demersal' and 'very small demersal high/low TL'). 'Nekton' and 'bony fish' were distributed among all fish groups

except rays, small sharks and large sharks. 'Fin fish' included the cartilaginous fish as well.

**Notes on calculation of consumption / biomass for fish groups**

All Q/Bs were calculated using the empirical equation derived by Pauly (1986);

$$Q/B = 10^{6.37} * 0.0313^T * W_{inf}^{0.168} * 1.38^P * 1.89^H \dots 1)$$

where:

- T=1000/(T°C + 273.1);
- P=1 for predators and planctonophages, 0 for herbivores, detritivores, and omnivores;
- H=0 for carnivores and omnivores, 1 for detritivores and herbivores;
- W<sub>inf</sub> is weight at infinite length (grams).

Length/weight data were used to calculate W<sub>inf</sub> according to the equation W<sub>inf</sub>=a \* L<sub>inf</sub><sup>b</sup>. Area-specific length-weight data were usually available from the Bay of Biscay or a nearby area. Where this information was not available, W<sub>inf</sub> were taken directly from FishBase. Q/B is expressed as the annual consumption per biomass (year<sup>-1</sup>).

### Notes on calculation of production/biomass for fish groups

Given our assumption of mass-balance, all P/B values are assumed to equal natural mortality (M) plus fishing mortality (F) (Allen 1971). Non-commercial fish have an F=0 and so M is taken as P/B. For commercial fish, F was either taken from literature directly or calculated as catch/biomass in the area. In most cases, F was obtained by dividing the yield from the whole of ICES Area VIII by an estimate of biomass for the area. Both mortalities, as well as P/B are expressed as annual rates (year<sup>-1</sup>).

### Notes on commercial importance

Commercial data were based on historical ICES records for the whole of Area VIII (687,000 km<sup>2</sup>), which includes catches from all countries taken from VIIIa, b, and c. The main countries fishing in the Bay of Biscay are France, Spain and Portugal. Other countries are Finland, Belgium, the former USSR, Netherlands, Denmark, Sweden, UK and Poland. In this report, we use catch as a synonym of landings, i.e. we assumed that discarding is nil. This is likely to underestimate true catches.

### INITIAL PARAMETERS BY ECOPATH GROUP

#### Large deepwater (group 1)

Fish composing the large deepwater basic parameters are conger eel (*Conger conger*), angler (*Lophius piscatorius*), black-bellied angler (*Lophius budegassa*), rabbit fish (*Chimaera monstrosa*), Atlantic pomfret (*Brama brama*), roundnose grenadier (*Coryphaenoides rupestris*), daggertooth (*Anotopterus pharao*), alfonsino (*Beryx decadactylus*), black scabbardfish (*Aphanopus carbo*), silver scabbardfish (*Lepidopus caudatus*), roundhead grenadier (*Odontomacrus murrayi*) and lanternfish (*Lampanyctodes hectoris*). All species are found in deep water and generally feed on small

deepwater fish, large crustaceans (particularly crabs and shrimp) and cephalopods. Although rabbit fish tend to feed less on fish and more on invertebrates, they were included in this group rather than 'large demersal' because they are found quite deep (up to 500 m) and because large deepwater and large demersals' respective trophic levels largely overlap. Both diets have a significant fish component (21.4% vs. 18.9% - initial diet matrix).

Conger eel is present in the eastern Atlantic from Norway to Senegal, and also occurs in the Mediterranean and the Black Sea. The two anglerfish dominate this group in biomass, but not in abundance (F. Blanchard, IFREMER, pers. comm.). Angler is a widespread species found in the eastern Atlantic as far south as the Strait of Gibraltar, while black-bellied angler occurs from Britain to Senegal.

Overall 'large deepwater' is a fairly important commercial group. The most important fish are anglerfish (*L. piscatorius* and *L. budegassa*), Atlantic pomfret and conger eel (Figure 2). Minor commercial fish in this group are (in order of present-day importance), roundnose grenadier, black scabbardfish, alfonsino, and silver scabbardfish at less than 25 t yearly, although landings of roundnose grenadier reached 187 t in 1998 (Table 1). Angler yields were large in the early 1970s, averaging around 15,000 t yearly and gradually declining in the late 1980s to about 4,000 t by 1998. Until the late 1950s, conger eel was the most important commercial species. Conger eel yields have remained more-or-less constant for fifty years, but declining to about 300 t in the late 1990s (Figure 2). ICES records for Atlantic pomfret started in 1975 at over 16,000 t and fell sharply in the 1980s, averaging just over 500 t-year<sup>-1</sup> throughout that decade. The catch increased to about 2,000 t-year<sup>-1</sup> during the 1990s, although the most recent catch (1998) was a dismal 2 t.

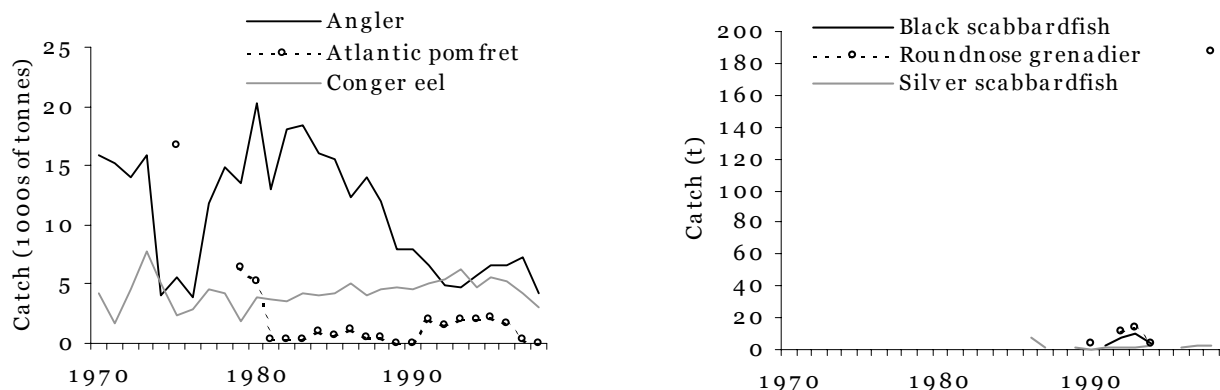

**Figure 2.** Evolution of the catches of 'Large deepwater' species for the period 1970-1998

**Table 1.** Initial basic parameter summary for 'Large deepwater' species.

Species	Q/B (year <sup>-1</sup> )	P/B (year <sup>-1</sup> )	Biomass (t·km <sup>-2</sup> )	F (year <sup>-1</sup> )	Catch in 1998 (t)
<i>Conger conger</i>	3.149	0.390	0.119	0.259 <sup>a</sup>	2966
<i>Lophius piscatorius</i>	3.336	0.489	0.17	0.259	4264
<i>Chimaera monstrosa</i>	3.551	0.220	-	0	0
<i>Brama brama</i>	3.508	-	-	0	2
<i>Coryphaenoides rupestris</i>	3.804	-	-	-	187
<i>Anotopterus pharao</i>	3.222	0.190	-	0	0
<i>Beryx decadactylus</i>	2.826	-	-	-	11
<i>Aphanopus carbo</i>	4.431	-	-	-	17
<i>Lepidopus caudatus</i>	6.307	-	-	0	2
<i>Odontomacrus murrayi</i>	4.851	0.260	-	0	0
<i>Lophius budegassa</i>	2.967	0.180	-	-	-
Group Value	3.532	0.288	0.304 <sup>b</sup>	-	7449

<sup>a</sup>Assumed to be equal to *Lophius* fishing mortality;

<sup>b</sup>Augmented from 0.289 by 5% to account for other species.

Asymptotic weights ( $W_{inf}$ ) were calculated using length-weight data (Froese and Pauly, 2000) from the Bay of Biscay for conger eel and anglerfish, from the UK for Atlantic pomfret and roundnose grenadier, from Portugal for black scabbardfish and from Spain for silver scabbardfish (Table 1). Q/B estimates from these localities are probably applicable to the Bay of Biscay; Q/B estimates for the remaining species were calculated using generic  $W_{inf}$  values taken from FishBase (i.e., area-specific length-weight relationships were not available). The average Q/B is 3.53 year<sup>-1</sup>.

Fishing mortality for anglerfish ( $F=0.259$  year<sup>-1</sup>) was taken from VIIb-k and VIIIa,b (Anon., 1999d) (Table 1). We assumed that conger eel was submitted to a similar exploitation rate as anglerfish. The biomass for these two species, calculated at the ratio of catch over F, amounted to 0.289 t·km<sup>-2</sup>. Assuming that these species constitute the main biomass of the large deepwater group, we augmented the biomass by 5% to cover for the remaining 3% of the catch and the species that are not exploited. The group's average natural mortality was equal to 0.216 year<sup>-1</sup>. The average P/B was estimated as 0.288 year<sup>-1</sup>.

In order to balance the model, the biomass had to be increased to 0.35 t·km<sup>-2</sup>, and the P/Q ratio increased by decreasing the consumption rate to 2.5 year<sup>-1</sup> and increasing the production rate to 0.33 year<sup>-1</sup>. *Lophius* being ambush predators, we assumed that their consumption and gross efficiency ought to be higher.

Diet compositions were based on conger eel, anglerfish, rabbit fish, Atlantic pomfret, roundnose grenadier, black scabbardfish, daggertooth, silver scabbardfish and alfonsino. Four of nine diets were quantitative, while five were qualitative.

### Medium deepwater (group2)

The group consists of ribbon barracudina (*Arctozenus risso*), argentine (*Argentina sphyraena*), greater argentine (*Argentina silus*), megrim (*Lepidorhombus whiffiagonis*), Sloane's viperfish (*Chauliodus sloani*), parrot seaperch (*Callanthias ruber*), deepbody boarfish (*Antigonia capros*), solenette (*Buglossidium luteum*), longfin gurnard (*Chelidonichthys obscurus*), bogue (*Boops boops*), greater weever (*Trachinus draco*), and slender codling (*Halargyreus johnsonii*). All the fish in this group occur in deep water, and most are bathydemersals, except for slender codling, Sloane's viperfish and ribbon barracudina which are bathypelagic. Sloane's viperfish differs from the other fish in this group in that it does not feed on bottom-dwelling fish; instead it feeds on pelagic fish and crustaceans during vertical migration. It was included in this group because its overall trophic level is comparable, and at 1000 m it is certainly deep-water (Froese and Pauly, 2000). Although greater argentine is bathydemersal and its diet is more similar to 'medium (big end) demersals', it was included in this group because it occurs as deep as 1440 m (F. Blanchard, IFREMER, pers. comm.), and because it has a trophic level of 3.4, similar to other members of this group.



The distribution of megrim covers the NE Atlantic, from Iceland to Western Sahara and in the western Mediterranean. It has been historically caught in amounts as much as ten times the next most commercial fish, so it is safe to assume that the megrim is among the most abundant fish of the group (Table 2). Megrim yields have been substantial since 1950, although variable in the 1970s (Figure 3). The catch gradually declined throughout the 1980s and remained quite low in the 1990s (1500-2000 t yearly). Records for bogue only started in the mid-1970s at 500-1000 t yearly until the catch declined in the late 1980s to 22 t in 1996. Greater weever landings have remained constant at 100 t per year since 1976. Longfin gurnard is absent from the time series ICES fisheries stats for Area

VIII, although a 1998 ICES value was available (148 t).

Asymptotic weights were calculated using length-weight data from the Bay of Biscay for greater weever, from other locations in France for solenette and deepbody boarfish, and from Spain for argentine and megrim (Froese and Pauly, 2000). All other estimates were taken from generic data in FishBase (Table 2). The resulting average Q/B was 6.513. We assumed that F equaled two-thirds of natural mortality for megrim and that all other exploited species were submitted to the same exploitation rate (=0.172). The average P/B for the group was estimated at 0.502 year<sup>-1</sup> (Table 2). There is no estimate of biomass for these fish.

**Table 2.** Initial basic parameter summary for ‘Medium deepwater’ species.

Species	Q/B (year <sup>-1</sup> )	P/B (year <sup>-1</sup> )	F <sup>a</sup> (year <sup>-1</sup> )	Catch in 1998 (t)
<i>Arctozenus risso</i>	7.128	0.650	0	0
<i>Argentina sphyraena</i>	7.520	0.710	0	0
<i>Argentina silus</i>	5.584	0.282	0	0
<i>Lepidorhombus whiffiagonis</i>	5.281	0.460	0.172 <sup>a</sup>	963
<i>Chauliodus sloani</i>	6.297	-	0	0
<i>Callanthias ruber</i>	5.010	0.360	0	0
<i>Antigonia capros</i>	4.153	0.580	0	0
<i>Buglossidium luteum</i>	9.767	0.685	0	0
<i>Chelidonichthys obscurus</i>	8.537	-	0.172 <sup>b</sup>	147.8
<i>Boops boops</i>	6.837	0.502	0.172 <sup>b</sup>	33
<i>Trachinus draco</i>	6.858	-	0.172 <sup>b</sup>	119
<i>Halargyreus johnsoni</i>	5.185	0.290	0	0
Group value	6.513	0.502	-	1262.8

<sup>a</sup>Assumed that F=0.6M;

<sup>b</sup>Assumed to be exploited at the same level as *Lepidorhombus*.

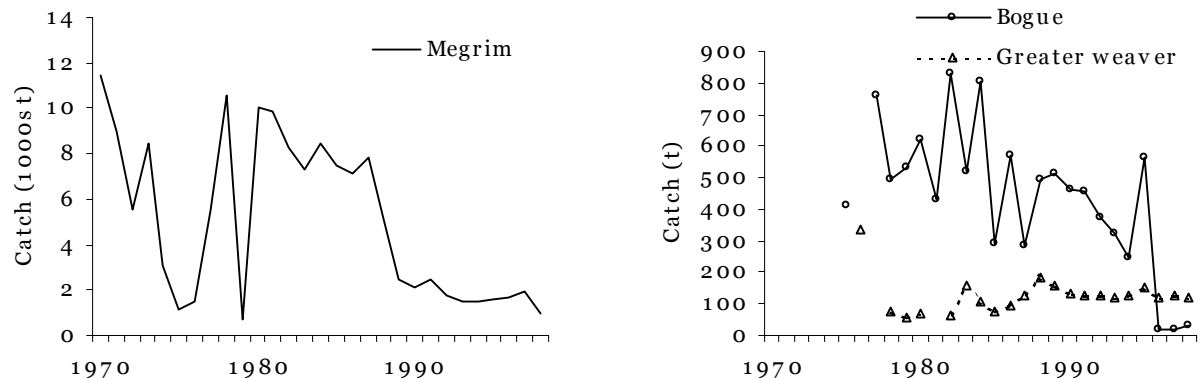

**Figure 3.** Evolution of the catches of Medium deepwater species for the period 1970-1998

Prey item types are quite consistent among fish in this group. They tend to consume primarily small deepwater fish and epibenthics. The greater argentine is the only fish in this group that consumes zooplankton. Most epibenthic prey items are listed in the literature only as 'unidentified benthic crustaceans'. Since it is unclear which particular crustaceans are preyed on, larger crabs (i.e., the 'crabs' group) may be underestimated. The main secondary prey items fall under 'molluscs' and 'shrimps/prawns' groups at about 12.5% of the diet each in the preliminary diet matrix. The diet of megrim in this group refers to the adult diet, while juvenile diet for this fish appears in small deepwater.

### Small deepwater (group4)

This group consists of half-naked hatchetfish (*Argyropelecus hemigymnus*), *Cataetyx alleni*, *Cataetyx laticeps*, small-headed clingfish (*Apletodon dentatus*), Fries' goby (*Lesueurigobius friesii*), pearlides (*Maurolicus muelleri*), and lanternfish (*Ceratoscopelus maderensis*). Most of these fish are generally deepwater benthic/mesopelagics and benthodemersals that feed on small benthos (crustaceans and polychaetes mostly). There is some variation in the depth at which these fish occur, most are in the order of several hundred meters deep. Pearlsides are the deepest, at over 1500 m (see FishBase, Froese and Pauly, 2000). Fries' goby lives in shallower waters at 130 m, but were included in this group because of its similarity in diet (worms and small benthos). Although the diet of lanternfish is different from the group average (zooplankton rather than zoobenthos), it has been included because it resides in deep water (650-700 m during the day, <250 m at night).

Although pearlides and lanternfish are commercially caught elsewhere, none of the fish in this group have catch records for ICES Areas VIIIa,b since 1950. Biomass data for the Bay of Biscay and the west coast of Portugal were available only for pearlides (0.5 g·m<sup>-2</sup>) (Gjøsaeter and Kawaguchi, 1980) (Table 3).

Length-weight relationships are not available for *Cataetyx alleni*, *C. laticeps* and small-headed clingfish, so  $W_{inf}$  was taken directly from FishBase. Most fish show similar consumption values except for pearlside which, at 17.4, is well above the group average of 12.6 (Table 3). Overall, the initial Q/B average for this group may be slightly overestimated. Since this is a non-commercial group, all P/Bs were assumed to equal natural mortality, that is 1.537 year<sup>-1</sup>, which

is the arithmetic mean of values for all group members, except small-headed clingfish and lanternfish.

Diet information is based on three species: half-naked hatchetfish, Fries' goby and megrim recruits/juveniles. All three are based on detailed, quantitative information although only Fries' goby is from Europe (Camas Nathais, Scotland). Megrim (recruits/juveniles) and half-naked hatchetfish diet data were from outside the Eastern North Atlantic. Although the systems are different from Atlantic France, the prey items were quite broad and we assumed they were a good indicator of diet in Biscay as well. Half the diet composition was unidentified copepods and the other half more specific items, especially Foraminifera (Hilbrecht, 1996).

The initial diet matrix indicated very heavy predation by this group on 'benthic infauna' (mostly from the half-naked hatchetfish). We were forced to reduce the predation on 'benthic infauna' by this group from 46.1 to 22.9%. The difference was added to small zooplankton and detritus. The latter may be questionable for small deepwater fish, but all other prey items were being overpreyed on already.

**Table 3.** Initial basic parameter summary for 'Small deepwater' species.

Species	Q/B (year <sup>-1</sup> )	P/B (year <sup>-1</sup> )
<i>Argyropelecus hemigymnus</i>	-	2.325
<i>Cataetyx alleni</i>	12.586	1.670
<i>Cataetyx laticeps</i>	10.932	1.730
<i>Apletodon dentatus</i>	13.940	-
<i>Lesueurigobius friesii</i>	11.229	0.976
<i>Maurolicus muelleri</i> <sup>a</sup>	17.409	1.179
<i>Ceratoscopelus maderensis</i>	9.779	-
Group value	12.646	1.537

<sup>a</sup>The biomass of this group is 0.5 t·km<sup>-2</sup>.

### Very large pelagic (meagre, group 4)

Basic parameters for this group are based on the meagre (*Argyrosomus regius*). Meagre is by far the most abundant pelagic fish in the model with an asymptotic weight of 105 kg (calculated with length/weight data from the Bay of Biscay). The second most massive pelagic is comparatively small at 19 kg (bluefish in 'large pelagic'). The 'very large pelagic' group is based solely on the meagre because it is so large and is of commercial importance and so presumed abundant. It is similar to 'tuna-like' fish in its basic parameters,

but does not migrate. Meagre preys more heavily on swimming crustaceans (50% of diet is 'shrimp/prawn') than do 'tuna-like' fish, which feed predominantly on nekton (forage fish and cephalopods) and consume less than 10% of shrimps, molluscs and zooplankton combined.

Meagre has a broad distribution, from Norway to Gibraltar and further south. The species also occurs in the Mediterranean and the Black Sea. Meagre is currently a moderately important commercial fish. After low landings in the 1970s and 1980s, the catch of meagre suddenly rose in the early 1990s, reaching 453 t in 1998 (Figure 4). No ICES catch records exist for this fish prior to 1975, and biomass information is not available either. A Q/B was estimated at 2.492 year<sup>-1</sup> based on the empirical estimate after Pauly (1986) for *Argyrosomus regius*. Natural mortality (M) was estimated at 0.13 year<sup>-1</sup> and fishing mortality was assumed to be equal to half of M, which yielded a P/B value of 0.195 year<sup>-1</sup>.

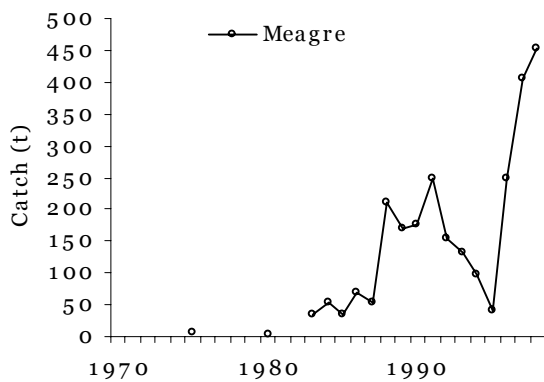

**Figure 4.** Evolution of the catches of Very Large pelagic species for the period 1970-1998

Meagre's diet essentially breaks down to 50% swimming crustaceans (mostly southern pink shrimp *Penaeus notialis*) and 50% pelagic forage fish, which includes large, medium and small pelagics with a wide trophic range. As mentioned, its earlier dependence on crustaceans is the reason that it merited its own group apart from 'tuna-like' fish. Diet information came from Senegal (Caverivière and Andriamirado, 1997) and Gulf of Tunisia (Chakroun and Ktari, 1981).

**Large pelagic (group 5)**

The 'large pelagic' group is very broad, and includes 12 species used to estimate the basic parameters and diet composition. Atlantic horse mackerel (*Trachurus trachurus*), adult whiting (*Merlangius merlangus*), blackspot seabream (*Pagellus bogaraveo*), garfish or garpike (*Belone belone*), Atlantic bonito (*Sarda sarda*), allis shad

(*Alosa alosa*), ocean perch (*Sebastes marinus*), forkbeard (*Phycis phycis*), chub mackerel (*Scomber japonicus*), greater forkbeard (*Phycis blennoides*), black seabream (*Spondyliosoma cantharus*) and bluefish (*Pomatomus saltator*). These animals feed on medium and small fish, zooplankton and zoobenthos (crabs mostly). Note that blackspot seabream is benthopelagic and occurs deeper than the other group members, but feeds on similar prey items (Bauchot and Hureau, 1990). *P. phycis* and *P. blennoides* are benthopelagic (F. Blanchard, IFREMER, pers. comm.).

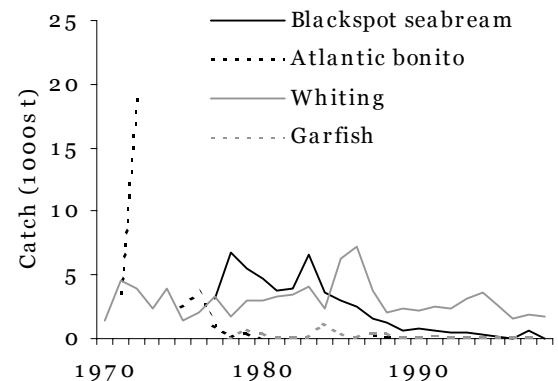
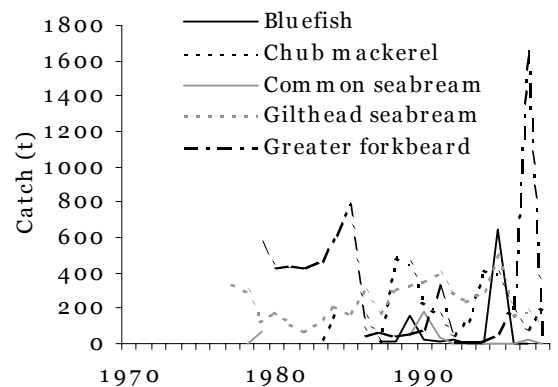
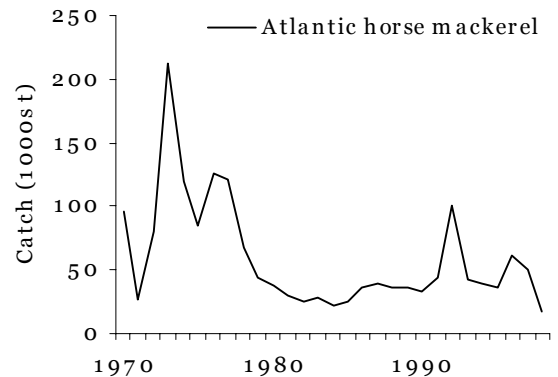

**Figure 5.** Evolution of the catches of Large pelagic species for the period 1970-1998

In the 1950s landings of Atlantic horse mackerel ranged from 30-50 thousand tonnes per year. There is a gap in the catch records until the early 1970s, when the landings reached a peak of over 211,000 t in 1973 and declined to 33,000 t in the 1980s (Figure 5). Although 1998 catches were only 16,547 t, the lowest in 30 years, Atlantic horse mackerel still remains a major target species. Atlantic bonito and blackspot seabream catches have been much higher in the past; 1972 saw peak catches for these two fish at 19,413 t and 26,416 t respectively, while they dropped dramatically to 11 t and 41 t in 1998. Whiting catch has remained very constant since 1970, at an average of 2,900 t per year. It peaked in 1986 at 7303 t, and has been low (below 2,000 t annually) since 1996. Black seabream (*S. cantharus*) is a commercial fish elsewhere, but no catch record exists for the study area. Other noteworthy commercial fish in this group are the greater forkbeard and bluefish (Figure 5).

The biomass of Atlantic horse mackerel and chub mackerel was estimated at 0.549 and 0.031 g·m<sup>-2</sup>, respectively, based on the 1997 stock assessment for the Bay of Biscay (Anon., 1999c) (Table 4). In absence of suitable quantitative data, we assumed that fishing mortality for whiting equaled that of horse mackerel ( $F=0.312 \text{ year}^{-1}$ ) and calculated its biomass by dividing catch by  $F$ . As the rest of the catch amount for 0.8% of the total, we augmented

the estimated biomass for the three main species (0.638) by 1% for a total of 0.645 t·km<sup>-2</sup>. The average P/B was 0.524 year<sup>-1</sup> and the average M was 0.165 year<sup>-1</sup>.

Overall, the length-weight information was from relevant areas. Of the 12 fish in the group, 11 had length-weight relationships: six were from France (four of these were Bay of Biscay), two from Portugal, one from the Irish Sea, and one from South Africa (ocean perch). The Q/B values were very consistent across the group, the largest consumption was from Atlantic horse mackerel (6.081 year<sup>-1</sup>) and the smallest from bluefish (3.541 year<sup>-1</sup>), average value was 5.033 year<sup>-1</sup> (Table 4).

Diet information for five out of the twelve fish was quantitative. 'Large pelagics' prey on a very wide range of items (22 groups in the initial diet matrix). Crabs are the most heavily preyed on group, commanding only 10.8% of the diet for 'large pelagics'. Six minor groups comprised of zooplankton and pelagic fish all contribute roughly equally to the diet, between 6-9% each. A large portion (10.2%) of the average diet for this group was based on unidentified 'nekton' and 'bony fish', which were divided equally among 'medium pelagic', 'small pelagic high TL' and 'small pelagic low TL' prey items when adjusting the diet matrix, in order to balance the model.

**Table 4.** Initial basic parameter summary for 'Large pelagic' species.

Species	Q/B (year <sup>-1</sup> )	P/B (year <sup>-1</sup> )	Biomass (t·km <sup>-2</sup> )	F (year <sup>-1</sup> )	Catch in 1998 (t)
<i>Trachurus trachurus</i>	6.081	0.622	0.549 <sup>a</sup>	0.312 <sup>a</sup>	16547
<i>Merlangius merlangus</i>	5.708	0.775	0.058 <sup>b</sup>	0.028 <sup>c</sup>	1759
<i>Pagellus bogaraveo</i>	4.641	-	-	-	41
<i>Belone belone</i>	5.321	-	-	-	33
<i>Sarda sarda</i>	4.876	-	-	-	11
<i>Alosa alosa</i>	4.423	-	-	-	30.5
<i>Sebastes marinus</i>	4.615	-	-	-	12
<i>Phycis phycis</i>	4.894	0.358	-	0	0
<i>Scomber japonicus</i>	6.032	0.620	0.031 <sup>a</sup>	0.059 <sup>a</sup>	178
<i>Spondyllosoma cantharus</i>	4.383	0.480	-	0	0
<i>Phycis blennoides</i>	5.990	-	-	-	28
<i>Pomatomus saltator</i>	3.541	0.287	-	0	0
Group value	5.033	0.524	0.654 <sup>d</sup>	-	18639.5

<sup>a</sup>From Bay of Biscay assessment;

<sup>b</sup>Obtained by using ratio Catch/F;

<sup>c</sup>F assumed equal to that of *Trachurus*;

<sup>d</sup>Augmented by 1% from 0.638.

**Medium pelagic (group 6)**

The 'medium pelagics' consist of 14 benthopelagic and pelagic species with a variable depth range, but usually occurring from 30 - 500 m. They tend to feed on benthic (mostly crabs and worms) and pelagic prey (shrimp and fish). This group consists of the hollowsnout grenadier (*Caelorinchus caelorhincus*), axillary seabream (*Pagellus acarne*), pouting (*Trisopterus luscus*), poor cod (*Trisopterus minutus*), Risso's smooth-head (*Alepocephalus rostratus*), twaite shad (*Alosa fallax*), adult European smelt (*Osmerus eperlanus*), Mediterranean flyingfish (*Cheilopogon heterurus*), adult Atlantic mackerel (*Scomber scombrus*), blue whiting (*Micromesistius poutassou*), big-eye scad (*Selar crumenophthalmus*), grenadier (*Nezumia bairdi*), Norway pout (*Trisopterus esmarkii*) and saury (*Scomberesox saurus*). Blue whiting is among the deeper fish in the group, occurring as deep as 3000 m. It is included in this group rather than 'medium deepwater' because it makes daily vertical migrations and tends to feed in the pelagic water column. Its diet is also consistent with the group, preying on amphipods and small fish. The European smelt is on the other end of the depth range, occurring only in the first 50 m. This fish is included because of its size and the overall similarity in diet composition. Prey items are mostly shrimp, small crustaceans and small fish.

Atlantic mackerel has a wide range, in the eastern Atlantic, also the Mediterranean and Black Sea. Blue whiting occurs from Iceland to Cape Bojador, Africa. Pouting has a more restricted range, from the British Isles to the west African coast. Norway pout is at the southernmost extent of its range, which extends North to the Barents Sea.

Except for Atlantic mackerel, catch records are missing for all species in this group prior to 1970. Landings of mackerels in the 1950s were small (1-5,000 t·year<sup>-1</sup>), while data were absent for the 1960s (Figure 6). Catches in the 1970s were very high, peaking in 1974 at 66,980 t, declining in the late 1970s to 15-20 thousand t per year, and again in the late 1980s. Landings of mackerel reached an all-time low in 1998 (5,119 t). Of less importance is pouting, at 1,321 t (1998) and blue whiting at 167 t (Table 5). The latter has been much more important in the past, with larger catches than Atlantic mackerel throughout most of the 1980s, and all of the 1990s (Figure 6).

The biomass of Atlantic mackerel from ICES Area VIII in 1997 was estimated at 108,000 t or 0.157 t·km<sup>-2</sup> (Table 5). As this was the only biomass

available for a commercially important group, the ecotrophic efficiency was set at 0.95, and Ecopath was left to estimate this parameter. Four length/weight relationships were from France (three from Bay of Biscay), one was from Spain and five were generic or from an unrelated area. Q/B was estimated at 6.503 year<sup>-1</sup> (Table 5). In absence of data, fishing mortality for all exploited species was assumed to be equal to that calculated for Atlantic mackerel (=0.047 year<sup>-1</sup>). The average natural mortality reached 0.581 while the average P/B was estimated at 0.609 year<sup>-1</sup> (Table 5). Fishing mortality could be underestimated here, but the overall P/B seems reasonable.

Only one of the 13 species had a qualitative diet description. Like 'large pelagics', this group also preys on a wide variety of prey groups. The most important preys are small zooplankton (11.4%), crabs (10.6%), shrimps (10.2%), large zooplankton (8.5%) and cephalopods (7.6%). All together, these five groups constitute the bulk (48.3%) of the 18 prey groups consumed. Diets for European smelt and Atlantic mackerel were divided into adults and juveniles. Juvenile data appear in the group 'small pelagic high TL'. The diet had to be changed only slightly, removing the predation on Very Large demersal High TL.

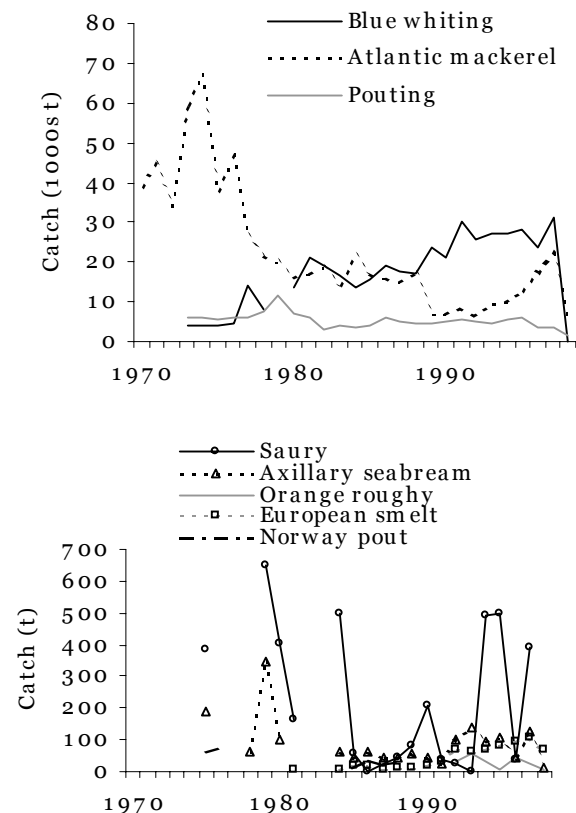

**Figure 6.** Evolution of the catches of 'Medium pelagic' species for the period 1970-1998

**Table 5.** Initial basic parameter summary for 'Medium pelagic' species.

Species	Q/B (year <sup>-1</sup> )	P/B (year <sup>-1</sup> )	Biomass (g·m <sup>-2</sup> )	F (year <sup>-1</sup> )	Catch in 1998 (t)
<i>Caelorinchus caelorhincus</i>	6.128	0.480	-	0	0
<i>Pagellus acarne</i>	6.885	0.606	-	0.047 <sup>a</sup>	15
<i>Nezumia bairdi</i>	6.128	0.550	-	0	0
<i>Alepocephalus rostratus</i>	5.991	-	-	0	0
<i>Alosa fallax</i>	6.656	0.803	-	0.047 <sup>a</sup>	30.5
<i>Osmerus eperlanus</i>	7.320	0.581	-	0.047 <sup>a</sup>	67
<i>Cheilopogon heterurus</i>	6.128	0.480	-	0	0
<i>Scomber scombrus</i>	7.083	0.847	0.157	0.047 <sup>b</sup>	5119
<i>Micromesistius poutassou</i>	6.622	0.432	-	0.047 <sup>a</sup>	167
<i>Selar crumenophthalmus</i>	4.309	-	-	0	0
<i>Trisopterus luscus</i>	5.907	0.899	-	0.047 <sup>a</sup>	1321
<i>Trisopterus minutus</i>	7.102	0.417	-	0	0
<i>Trisopterus esmarkii</i>	8.150	0.740	-	0.047 <sup>a</sup>	1
<i>Scomberesox saurus</i> <i>scombroides</i>	6.634	0.470	-	0	0
Group value	6.503	0.609	-	-	6720.5

<sup>a</sup>Assumed to be equal to that of *Scomber scombrus*;

<sup>b</sup>From Catch/Biomass.

### Anchovy (group 7)

This functional group is based solely on the European anchovy (*Engraulis encrasicolus*), because it is an important commercial species and forage fish in the Bay of Biscay. European anchovy has a very wide distribution in the Atlantic from Norway to southern Africa, as well as populations in the Mediterranean, Black and Azov Seas, and western Indian Ocean.

Biomass of the European anchovy in ICES Area VIIIa,b is estimated at 57,000 t (Anon., 1999c) or 0.590 g·m<sup>-2</sup>. No catch records are available prior to 1973. Catches in the 1980s fluctuated from year to year, averaging about 13,000 t yearly. The catch in 1998 was 18,906 t (Figure 7). Q/B was estimated at 8.684 based on length/weight data from the Bay of Biscay. A P/B value of 0.911 year<sup>-1</sup> was obtained by summing natural mortality (=0.66 year<sup>-1</sup>) and fishing mortality (=0.251 year<sup>-1</sup>) based on ICES stock assessment for area VIII (Anon., 2000). In order to balance the model, we increased P/B to 1.15 year<sup>-1</sup>.

Diet information in FishBase for the European anchovy is limited, with 50% of its diet reported to consist of small zooplankton, while the remaining 50% consists of unidentified 'bony fish', which was ultimately divided into four groups: 'small deep', 'small pelagic low TL', 'anchovy', and 'herring'. The relative proportion of each group was based on the average frequency of occurrence of those prey items in the diets of the top predator groups.

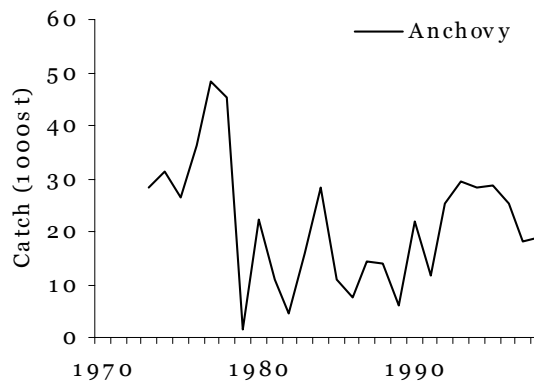
**Figure 7.** Evolution of the catches of anchovy for the

period 1970-1998

### Small pelagic high TL (group 8)

These are typically small pelagic, coastal forage fish. This group is separated from 'small pelagic low TL' only by trophic level, meaning that they typically consume more fish and less zooplankton. The basic parameters were estimated using sand smelt (*Atherina presbyter*) and *Argyrolepeucus olfersi*.

Sand smelt is a resident of the eastern Atlantic, from the British Isles to Canary Islands, also Mauritania and Cape Verde Islands and in the western Mediterranean. The juvenile forms of whiting, European smelt and Atlantic mackerel all tend to stay close to the coast. This group is less important than 'small pelagic low TL' in the commercial catch. Sand smelt is caught commercially, but only at low levels (65 t in

1998). There were no historical catch data available from ICES prior to 1998. In balancing the initial model, it was necessary to reduce the consumption of this group by higher predators.

Consumption rates for these small fish are high, averaging 10.15 year<sup>-1</sup> for the group (Table 6). Asymptotic weight is calculated for sand smelt using length-weight data from the Bay of Biscay, and a generic  $W_{inf}$  was used (from FishBase) for *Argyropelecus olfersi*. No biomass data were available for any fish in this group. Natural mortality was estimated at 1.315 year<sup>-1</sup> and F assumed to be low that is, a third of M which yielded a P/B value of 1.524 year<sup>-1</sup>.

Diet composition was estimated using sand smelt, juvenile whiting (*Merlangius merlangus*), juvenile European smelt (*Osmerus eperlanus*) and juvenile Atlantic mackerel (*Scomber scombrus*). This group depends very heavily on small zooplankton (75.1% of diet) and small fish, particularly 'small pelagic low TL' (16.5% of diet). The data were reliable as 3 of 4 are from quantitative, species-specific sources.

### Small pelagic low TL (group 9)

Like the above group, these are also small (less than 30 cm) pelagic, often inshore forage fish species, separated from the precedent group by their trophic level. Basic parameters are estimated with 3 species; lesser sandeel (*Ammodytes marinus*), sprat (*Sprattus sprattus*) and glacier lanternfish (*Benthoosema glaciale*). Sprat catches were largest in the early 1970s, and have largely declined in the last decade to 67 t in 1997 (Figure 8). Catches of *Ammodytes* were taken as a third of the ICES catch statistics for *Ammodytes* spp (Table 7).

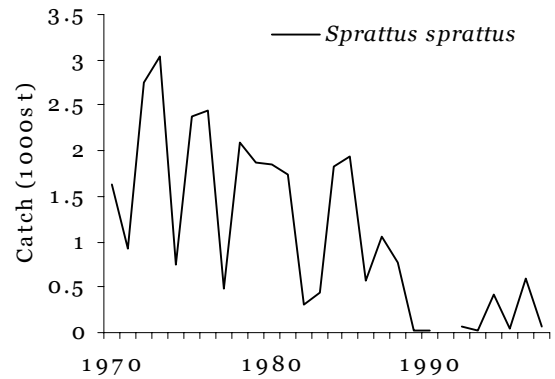

**Figure 8.** Evolution of the catches of 'Small pelagic low TL' species for the period 1970-1998

**Table 6.** Initial basic parameter summary for 'Small pelagic high TL' species.

Species	Q/B (year <sup>-1</sup> )	P/B (year <sup>-1</sup> )	F (year <sup>-1</sup> )	Catch in 1998 (t)
<i>Atherina presbyter</i>	10.775	1.68	0.42 <sup>a</sup>	65
<i>Argyropelecus olfersi</i>	12.859	1.38	0	
Group value	10.150	1.524	-	65

<sup>a</sup>Assumed to be small, i.e., a third of M.

**Table 7.** Initial basic parameter summary for 'Small pelagic low TL' species.

Species	Q/B (year <sup>-1</sup> )	P/B (year <sup>-1</sup> )	Biomass (t·km <sup>-2</sup> )	F (year <sup>-1</sup> )	Catch in 1998 (t)
<i>Ammodytes marinus</i>	7.829	~0.808	-	-	22
<i>Sprattus sprattus</i>	11.588	1.338	0.026 <sup>a</sup>	0.027 <sup>b</sup>	67
<i>Benthoosema glaciale</i>	13.565	0.700	0.200	0	0
Group values	10.994	0.949	0.226 <sup>c</sup>	-	89

<sup>a</sup>Assessment for Area VIII;

<sup>b</sup>From Catch/Biomass;

<sup>c</sup>Minimal estimate not used in the model.

**Table 8.** Initial basic parameter summary for 'Very large demersal high TL' species.

Species	Q/B (year <sup>-1</sup> )	P/B (year <sup>-1</sup> )	Biomass (g·m <sup>-2</sup> )	F (year <sup>-1</sup> )	Catch in 1998 (t)
<i>Dicentrarchus labrax</i>	5.190	0.773	0.054	0.241 <sup>a</sup>	1263
<i>Seriola dumerili</i>	2.883	0.334	-	0	0
<i>Merluccius merluccius</i> (adult)	4.066	0.549	0.169	0.241 <sup>b</sup>	3953
<i>Molva molva</i>	3.530	0.515	0.054	0.241 <sup>a</sup>	1254
<i>Molva dypterygia</i>	4.354	0.513	0.002	0.241 <sup>a</sup>	35
<i>Melanogrammus aeglefinus</i>	3.331	0.596	0.007	0.241 <sup>a</sup>	152
<i>Muraena helena</i>	3.180	0.19	-	0	0
<i>Pollachius pollachius</i>	3.337	0.222	0.041	0.241 <sup>a</sup>	957
<i>Pagellus erythrinus</i>	3.326	0.527	0.001	-	14
<i>Gadus morhua</i>	3.462	0.569	0.013	0.241 <sup>a</sup>	300
<i>Merluccius bilinearis</i> (adult)	4.908	0.467	-	0	0
Group value	3.779	0.499	0.341	0.176	7928

<sup>a</sup>Fishing mortality assumed to be equal for that of *Merluccius merluccius*;

<sup>b</sup>From Anon. (1999d).

The average consumption rate is taken to be 10.994 year<sup>-1</sup> (Table 8). Length-weight data were obtained from the North Sea (lesser sandeel) and Scotland (sprat). The asymptotic weight for glacier lanternfish was taken directly from FishBase and is not area-specific. Average natural mortality was 0.94 year<sup>-1</sup> for this group, while fishing mortality is rather low (Table 7). P/B was estimated at 0.949 year<sup>-1</sup>. Biomass of sprat based on assessment for Area VIII that is 18,000 t or 0.026 t·km<sup>-2</sup> (Anon., 1999d). The glacier lanternfish biomass estimate of 0.200 t·km<sup>-2</sup> refers to the Bay of Biscay in 1962 (Gjøsaeter and Kawaguchi, 1980). Total biomass for this group would be a total of 0.226 t·km<sup>-2</sup>. However, we left the biomass to be estimated by Ecopath because of the large uncertainty associated with this estimate.

Diet composition is based on sprat and sandeel. Although values are from qualitative or descriptive data, all accounts for sprat indicate that they consume 100% 'small zooplankton', particularly copepods and euphausiids. Lesser sandeel is said to consume a large portion of diatoms. We assumed its diet to be 50:50 'small zooplankton' and diatoms (i.e., 'primary producers').

### Sardine (group 10)

This group consists only of European pilchard (*Sardina pilchardus*). Upon revision of the model, these were given their own group because they are a highly commercial species and an important forage fish in the Biscay region. When 'herring' occurred in the diet composition of

piscivores (i.e., when data came from systems where herring was the dominant forage fish), that amount was divided evenly between sardines and anchovy, thus assuming that these two species were substitutes for herring as dominant forage fish in the Bay of Biscay (V. Christensen, Fisheries Centre, UBC, pers. comm.).

The species is widespread, occurring from the North Sea to Senegal. Sardines are a very important commercial species in the Bay of Biscay and throughout their range. Average landings were over 40,000 t·year<sup>-1</sup> since 1950, and peaked in 1973 at over 100,000 t (Figure 9). Recent years have seen a decline in catch but sardines still remain important (10,760 t in 1998).

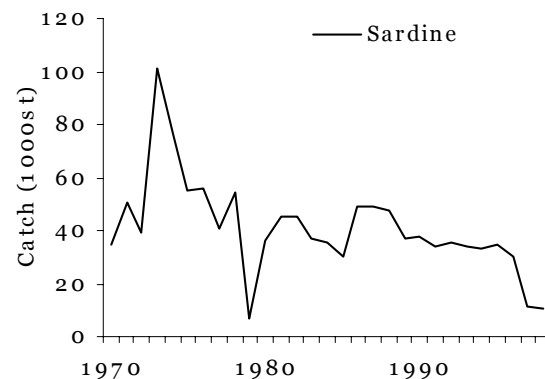

**Figure 9.** Evolution of the catches of sardine for the period 1970-1998



Sardine biomass is estimated to be 0.321 t·km<sup>-2</sup> in the Bay of Biscay, as obtained by reducing the absolute ICES estimate for Area VIII proportionately to represent only VIIIa,b. The value may be underestimated for coastal VIIIa,b since sardines are a littoral species (Brito, 1991) and so may occur in greater densities near shore compared to the whole of Area VIII.

The Q/B value of 8.965 year<sup>-1</sup> is based on length-weight data from the Bay of Biscay. The sum of natural mortality (M=0.903 year<sup>-1</sup>) and fishing mortality (F=0.049 year<sup>-1</sup>) (Whitehead, 1985) equals the production rate (P/B=0.952 year<sup>-1</sup>). The Council of the European Union (Anon., 1997) reports that sardines are overfished in the Iberian Peninsula (at risk of depletion). Were this to hold true for Biscay, we may expect a higher fishing mortality than our data suggest, and therefore P/B may be underestimated by as much as 40-50% if F approximately equals M. In order to balance the model we increased P/B to 1.1 year<sup>-1</sup>. Sardine diet consists of 100% small zooplankton.

**Very large demersal high TL (group 11)**

The group is composed of large (greater than 30 cm) demersal groundfish whose asymptotic weights are in the tens of kilograms. They tend to eat small fish which are usually, but not exclusively, demersal and small crustaceans (crabs and shrimps mostly). The species are European sea bass (*Dicentrarchus labrax*), greater amberjack (*Seriola dumerili*), ling (*Molva molva*), blue ling (*Molva dypterygia*), haddock (*Melanogrammus aeglefinus*), Mediterranean moray (*Muraena helena*), pollack (*Pollachius pollachius*), common pandora (*Pagellus erythrinus*), Atlantic cod (*Gadus morhua*), European hake (*Merluccius merluccius*) and silver hake (*Merluccius bilinearis*). The European sea bass is the least massive fish at 1.9 kg and was included in this group because its maximum length falls within the range for this group. This group is separated from the 'very large demersal low TL' group by trophic level alone (4.033 average vs. 3.326). European hake occurs from the coast of Norway and Iceland to West Africa.

Only three fish have no commercial value in the area: the greater amberjack, Mediterranean moray and silver hake. The most important commercial fish as of 1998 was the European hake at 3953 t, followed by the European seabass and ling at 1263 and 1254 t respectively (Table 8). In 1998, catches of less than 1,000 t were reported for pollack and Atlantic cod, and catches were negligible for haddock, blue ling and common pandora. Hake catches have gradually

declined from 1951 (59,207 t). Their landings peaked in 1973 at 75,096 t, then declined to about 25,000 t·year<sup>-1</sup> during the 1980s and 1990s, and reached their lowest level in recent years (Figure 10). The early 1970s also coincide with higher catch per unit effort. Ling catches have been highly variable, ranging from a low in 1971 of 192 t, to a peak in 1980 of 5,502 t (Figure 10).

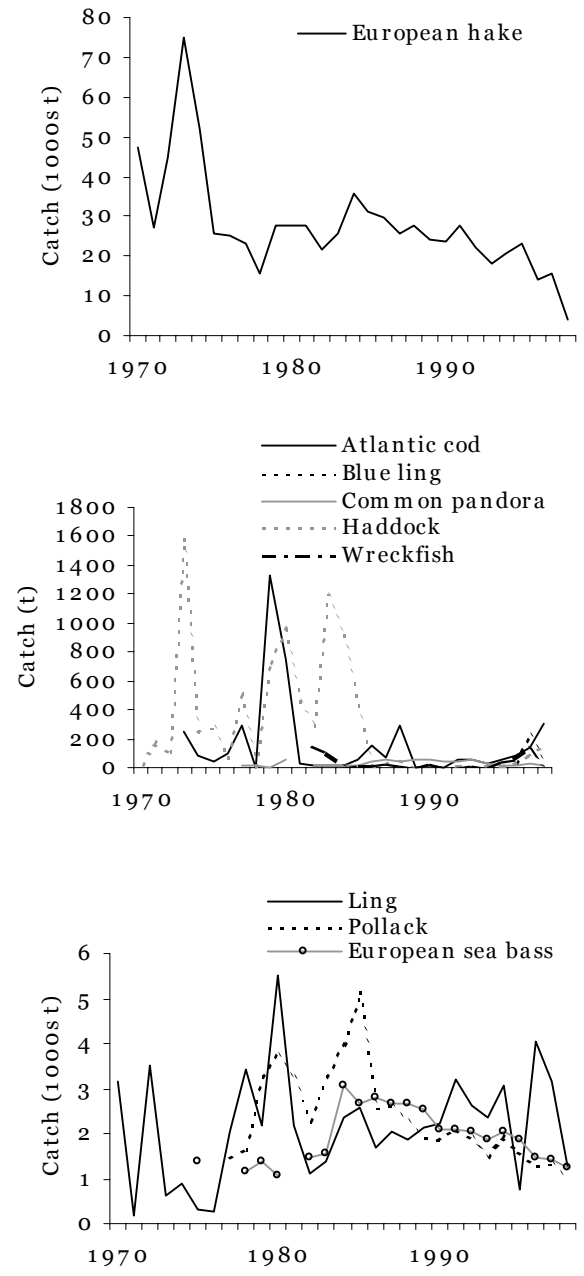

**Figure 10.** Evolution of the catches of 'Very large demersal high TL' selected species for the period 1970-1998

Hake biomass for was estimated from ICES stock assessment data for the entire northern Atlantic hake stock, including areas IIIa, IV, VII and VIIIa,b (Anon., 1999d). Biomass for Area VIIIa,b was back-calculated using the catch (3,953 t) divided by the fishing mortality (0.241) from the greater region (i.e., the entire northern stock). In absence of data for the other commercial species of the group, which are believed to be popular targets, we assumed that they are subjected to a similar fishing mortality as hake. The resulting biomass is then  $0.34 \text{ t}\cdot\text{km}^{-2}$ . The average natural mortality for this group was estimated at  $0.35 \text{ year}^{-1}$  and P/B to  $0.499 \text{ year}^{-1}$ .

Area specific length/weight relationships were used for 10 of 11 species, five from France (three from Biscay), two from UK, one from Portugal, one from the North Sea and one from western Atlantic. The range of consumption rates is narrow, although greater amberjack is at the low end of the scale with a Q/B of  $2.883 \text{ year}^{-1}$  (compared to average of  $3.779$  for group).

Diet information for six out of ten species that compose the diet matrix are from qualitative sources and are possibly unreliable. Diet items for this group are diverse. The initial matrix indicated strongest predation on 'small deepwater' fish (16.6%), and 'crabs' (12.5%), also 'benthic infauna' (7.3%), 'shrimp' (5.9%) and 10% plankton (large and small at 5.6% and 4.4% respectively). 3.8% of diet consisted of fish over 30 cm, and the remainder of fish under 30 cm, with heavy predation on herring in particular (5.9%).

### Very large demersal low TL (group 12)

This group is characterized by very large (166 cm average length) and heavy (72 kg average  $W_{inf}$ ) demersal feeders that prey on benthos and small fish of trophic level of about 3.3. The species included consisted of sturgeon (*Acipenser sturio*), wolffish (*Anarhichas lupus*), saithe (*Pollachius virens*), European plaice (*Pleuronectes platessus*) and turbot (*Psetta maxima*).

Saithe occurs from Barents Sea to the Bay of Biscay. Plaice occurs from Greenland and Norway to Morocco and in the Mediterranean. Sturgeon occurs from northern Norway and Iceland to Morocco, also in the Mediterranean and Black Seas. In fact, sturgeon being a critically endangered species, is protected by the Bern convention (see FishBase). Based on Robins *et al.* (1991) we assumed sturgeon biomass to be negligible.

Plaice has been called the most important flatfish in the European fishery, but in recent years the landings have fallen to only a fraction of their former amount (see [www.fao.org](http://www.fao.org)). Plaice and saithe catches were high in the early 1970s (over 2,000 t each), and tapered down to an average of 326 and 51 t per year respectively (Figure 11). Turbot landings have remained very constant over the last 30 years, averaging  $339 \text{ t}\cdot\text{year}^{-1}$ .

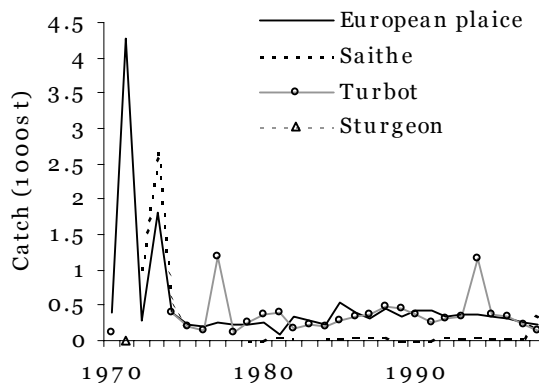

**Figure 11.** Evolution of the catches of 'Very large demersal low TL' species for the period 1970-1998

We assumed that the fishing mortality of plaice in the Bay of Biscay was equal to natural mortality ( $F = 0.159 \text{ year}^{-1}$ ). Then, we assumed that saithe and turbot were exploited at the same level. The resulting group P/B was  $0.254 \text{ year}^{-1}$  (Table 9) while the average M equaled  $0.159 \text{ year}^{-1}$ . Using the ratio Catch/F, the minimum biomass would amount to  $0.044 \text{ t}\cdot\text{km}^{-2}$  which seems too small. The biomass was thus left to be estimated by Ecopath. The length/weight relationships were taken from the North Sea for saithe, from the UK for wolffish, and from the Bay of Biscay for plaice and turbot. Sturgeon data were generic. Q/B was estimated at  $3.147 \text{ year}^{-1}$ .

Diets for sturgeon and wolffish are based on qualitative data, while information for saithe and plaice is quantitative. The diet of this group is quite homogeneous, and composed of benthos such as 'worms' (44.6%) and 'small zooplankton' (13.8%), higher benthos echinoderms (16.7%) and crabs (8.6%). The remaining prey items are small fish, which we assumed include sharks, skates and rays. 'Unidentified finfish', a significant component of sturgeon diet, was divided equally into 8 groups, 'large demersal', 'medium (big end) demersal', 'medium (small) dem', 'very small demersal high TL', 'very small demersal low TL', 'small sharks', and 'rays/skates'. Saithe tend to feed more on fish and less on benthos than the other species in the group although its trophic level is the same (3.3).

**Table 9.** Initial basic parameter summary for 'Very large demersal low TL' species.

Species	Q/B (year <sup>-1</sup> )	P/B (year <sup>-1</sup> )	Biomass (t·km <sup>-2</sup> )	F (year <sup>-1</sup> )	Catch in 1998 (t)
<i>Acipenser sturio</i>	2.310	0.094	-	0	0
<i>Anarhichas lupus</i>	2.146	0.100	-	0	0
<i>Pollachius virens</i>	3.010	0.300	0.02	0.159 <sup>a</sup>	301
<i>Pleuronectes platessus</i>	4.116	0.318	0.015	0.159 <sup>b</sup>	235
<i>Psetta maxima</i>	4.152	0.460	0.009	0.159 <sup>a</sup>	135
Group value	3.147	0.255	0.044 <sup>c</sup>	-	671

<sup>a</sup>Assumed equal to that of *P. platessus*; <sup>b</sup>assumed equal to M; <sup>c</sup>considered an absolute minimum.

**Large demersals (group 13)**

The species in this group are European eel (*Anguilla anguilla*), tub gurnard (*Chelidonichthys lucerna*), tusk (*Brosme brosme*), brill (*Scophthalmus rhombus*), common sole (*Solea solea*), John dory (*Zeus faber*), thicklip grey mullet (*Chelon labrosus*) and ballan wrasse (*Labrus bergylta*), gilthead seabream (*Sparus auratus*), dusky grouper (*Epinephelus marginatus*) and common seabream (*Pagrus pagrus*). Common seabream is benthopelagic, but is included in this group rather than 'large pelagic' because it feeds near the bottom and relies heavily on benthic and demersal prey. 'Large demersals' have a length ranging between 45 to 150 cm and can occur at depths of 400 m. They occur over a variety of substrates from soft sand (common sole), muddy sand, gravel (tub gurnard) and rock (John dory). Ballan wrasse occurs in the first 50 m and is reef-associated. John dory is benthopelagic in deep waters. John dory seemed out of place with a trophic level of 4.5 compared to the mean of 3.9. There is no group better suited to it, however, as it is not massive enough to be considered to be part of the 'very large demersal high TL' and given that this group is composed of higher trophic level fish. Tusk also has a high trophic level for the group. FishBase records 4.2 and this may be a low estimate (F. Blanchard, IFREMER, pers. comm.). By all accounts tusk is a large animal and may be a borderline candidate for 'very large demersal'. Thicklip grey mullet has a lower trophic level than other species in this group. Its length is on the borderline between 'medium' and 'large', but considering its bulk ( $W_{inf} = 6.6$  kg), it is an appropriate candidate for this group. Basic parameters are estimated using eight species, all above except the common seabream and dusky grouper.

Sole occurs from the North Sea to Senegal, and in the Mediterranean. Tub gurnard, ballan wrasse and brill are distributed from Norway to Morocco. Most populations of the gilthead seabream occur in the Northeast Atlantic, particularly around the British Isles and south to the Straits of Gibraltar.

All others show wide distribution throughout the eastern Atlantic.

Present day catches are greatest for common sole (4,335 t in 1998) (Figure 12). Common seabream and Moroccan white seabream (in 'medium (big end) demersal') have a combined catch of 4,860 t in 1998, although historical data were not available. European eel follow with 960 t while the other species catches were all below 200 t (Table 10). European eel has been much more important in the past, including an uncharacteristically large catch in 1997 of 14,289 t (Figure 12). Thicklip grey mullet had a catch of 601 t in 1998, but it does not appear in the historical catch records.

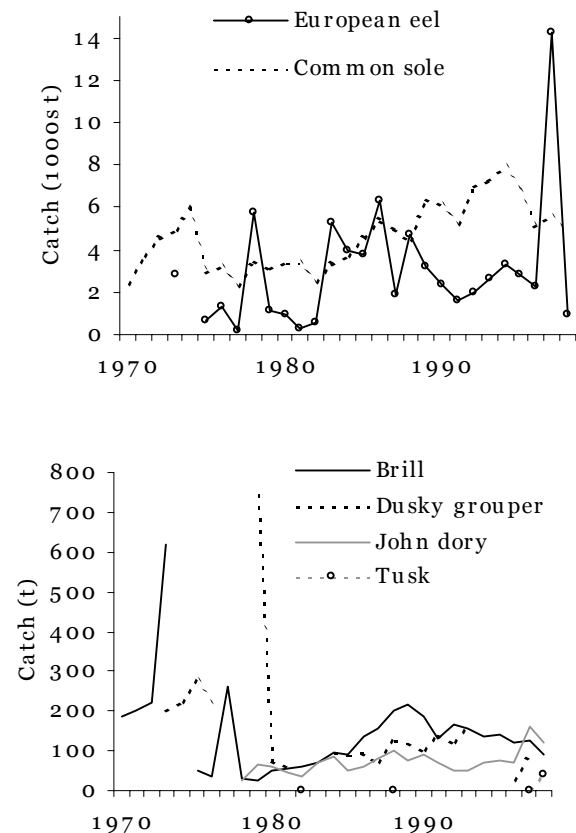

**Figure 12.** Evolution of the catches of 'Large demersal' selected species for the period 1970-1998

**Table 10. Initial basic parameter summary for 'Large demersals' species.**

Species	Q/B (year <sup>-1</sup> )	P/B (year <sup>-1</sup> )	Biomass (t·km <sup>-2</sup> )	F (year <sup>-1</sup> )	Catch in 1998 (t)
<i>Anguilla anguilla</i>	5.323	0.497	0.04	0.249	960
<i>Chelidonichthys lucerna</i>	5.618	1.11	0.003	0.557	148
<i>Sparus auratus</i>	4.898	0.932	0.002	0.466	105
<i>Brosme brosme</i>	4.298	0.521	0.002	0.261	40
<i>Scophthalmus rhombus</i>	6.000	-	0.003	0.332 <sup>a</sup>	92
<i>Solea solea</i>	5.423	0.768	0.104	0.430 <sup>b</sup>	4335
<i>Zeus faber</i>	4.395	0.604	0.004	0.302	123
<i>Labrus bergylta</i>	4.884	0.260	-	0	0
<i>Pagrus pagrus</i>	5.269	0.589	0.085	0.294	2430
<i>Chelon labrosus</i>	3.064	0.520	0.024	0.260	601
<i>Pleuronectidae</i>			0.015	0.430 <sup>c</sup>	605
Group value	4.917	0.647	0.28	0.156	9439

<sup>a</sup>Assumed F= average M for the group; from (Anon., 1999d); assumed equal to that of *S. solea*.

Biomass estimates are available only for common sole, at 0.216 t·km<sup>-2</sup> (Area VIIIa,b; Anon., 1999d) (Table 10). As sole fishing mortality is slightly higher than M we assumed that all the other commercial species in the group are exploited at a high level, which is F=M. The resulting P/B is 0.647 with average M=0.332 year<sup>-1</sup>.

Only the estimate for tusk was generated from generic length/weight relationships. Otherwise the consumption estimates appear to be reliable. Length/weight relationships were used to calculate asymptotic weights of seven species. The other relationships all came from France (including four from the Bay of Biscay). Thicklip grey mullet has a much lower Q/B (3.064 year<sup>-1</sup>) than the average (4.917 year<sup>-1</sup>).

Diet composition is based on six species: quantitative information for European eel, tusk and John dory, and qualitative information for tub gurnard, common sole, and brill. These species feed largely on benthos ('crabs', 'worms' and 'benthic infauna' at 10.8%, 7.6% and 5.9% respectively), medium demersal fish (12.2% allocated in 'medium (big end) demersal', 'medium (small end) demersal'), 'medium pelagic' fish (7.8%), small demersal fish (19.4% divided in 'very small demersal high/low TL', small demersal) and 'small pelagic' (4.8%). John dorys have been suggested to eat cephalopods (Stergiou and Fourtouni, 1991), but since quantitative data were not available, they were not included. A significant portion of the diet information of this group is referred to as 'unidentified' prey items. In these cases unidentified 'bony fish' was divided into 5 groups; 'medium (big end) demersal', 'medium (small end) demersal', 'small demersal', 'very small demersal high TL' and 'very small demersal low TL'.

### Medium (big end) demersals (group 14)

14 species compose this group; European flounder (*Platichthys flesus*), red gurnard (*Aspitrigla cuculus*), grey gurnard (*Chelidonichthys gurnardus*), boarfish (*Capros aper*), striped red mullet (*Mullus surmuletus*), cockoo wrasse (*Labrus bimaculatus*), streaked gurnard (*Chelidonichthys lastoviza*), lemon sole (*Microstomus kitt*), fourspotted megrim (*Lepidorhombus bosci*), bar jack (*Caranx ruber*), Atlantic bigeye (*Priacanthus arenatus*), Moroccan white seabream (*Diplodus sargus cadenati*), and sand sole (*Pegusa lascaris*). All species listed are used in the basic parameter estimates. Cockoo wrasse, bar jack, Moroccan white seabream and the Atlantic bigeye are reef dwellers, and the rest inhabit rocky (lemon sole), or sand and gravel (red gurnard) substrate from shallow demersal, to about 600 m (boarfish occur the deepest). They are between 30 and 60 cm in length, and tend to feed on small (usually) bottom-dwelling fish, benthos and other invertebrates. Note that boarfish are on the small end of the size range for the group, and the males are smaller still, compared to females (Sánchez *et al.*, 1995). For simplicity's sake, both sexes are included in this group.

The lemon sole is at the edge of its range, which extends from Iceland and the White Sea to the Bay of Biscay. Most others occur from as far north as the British Isles, (e.g., fourspotted megrim) or Norway (boarfish) and extend along the west coast of Africa. There were no available biomass data for any fish in this group. Present day catches for all species in this group are relatively low (Table 11). Historically the striped red mullet has been more important, with catches averaging 628 t·year<sup>-1</sup> during the 1980s, and a peak in 1976

**Table 11.** Initial basic parameter summary for 'Medium (big end) demersals' species.

Species	Q/B (year <sup>-1</sup> )	P/B (year <sup>-1</sup> )	F <sup>a</sup> (year <sup>-1</sup> )	Catch in 1998 (t)
<i>Platichthys flesus</i>	4.524	1.15	0.43	26
<i>Aspitrigla cuculus</i>	6.464	1.27	0.48	192
<i>Chelidonichthys gurnardus</i>	6.578	1.76	0.66	55
<i>Capros aper</i>	6.620	0.59	0	0
<i>Mullus surmuletus</i>	6.994	1.41	0.53	8
<i>Labrus bimaculatus</i>	6.354	0.34	0	0
<i>Chelidonichthys lastoviza</i>	6.395	1.49	0.56	148
<i>Microstomus kitt</i>	6.509	1.12	0.42	77
<i>Lepidorhombus boscii</i>	6.418	0.33	0	0
<i>Caranx ruber</i>	4.593	0.29	0	0
<i>Priacanthus arenatus</i>	5.751	0.47	0	0
<i>Pegusa lascaris</i>	6.061	0.39	0	0
<i>Diplodus sargus cadenati</i>	5.776	-	-	~2430
<i>Prionotus</i> sp.	-	-	-	148
Group value	6.080	0.885	-	3084

<sup>a</sup>Assuming F= 0.6 M.

of 1,318 t (Figure 13). Landings of European flounder, grey gurnard and lemon sole were generally lower than 100 t·year<sup>-1</sup> each. Sand sole catch increased in the 1990s, remaining above 100 t·year<sup>-1</sup> since 1993. Landings of the Moroccan white seabream are estimated at 2,430 t·year<sup>-1</sup>, one half of ICES' 'seabream' catch. The remaining half was relegated to the common seabream in 'large demersals'.

European flounder and bar jack are at the low end of the range of consumption rates (Q/B~4.5 year<sup>-1</sup>) compared to the average of 6.08 (Table 11). Asymptotic weights for 11 out of 13 species are based on length/weight relationships and two are directly from FishBase. Six length/weight relationships were from France (five from the Bay of Biscay), two from Spain, one from the western Atlantic, and one is generic. The average M value amounted to 0.628 year<sup>-1</sup>. Assuming that F=0.6 M for each commercial species, then P/B=0.885 year<sup>-1</sup>. The weighted average F would be of 0.51 year<sup>-1</sup>, and applied to the total catch, yielded a biomass of 0.062 t·km<sup>-2</sup>, which is probably underestimated. Thus, biomass was not entered and left to estimate by Ecopath.

The diet information for 11 out of 15 species were from quantitative sources. Major prey items for this group included 'benthic infauna', 'shrimp', 'worms' and 'small/large zooplankton' (all these items constituted greater than 6% of the diet). The remainder was generally small deepwater and small/medium demersal fish, as well as a small amount of primary producers (phytoplankton and seaweed). A significant portion of the diet of six fish was termed 'other benthic crustaceans' or 'unidentified benthic crustaceans' in the literature. Except for components which fell into other crustacean

categories such as 'crabs' or 'shrimp/prawn', the remainder was assigned to 'epibenthos', a general group for microbenthos occurring on the substrate (as opposed to benthic infauna). Unidentified fish such as 'bony fish' or 'nekton' were assigned to groups; 'medium (small end) demersal', 'very small demersal high TL' and 'very small demersal low TL'. Moroccan white seabream also feeds on small amounts of seaweed.

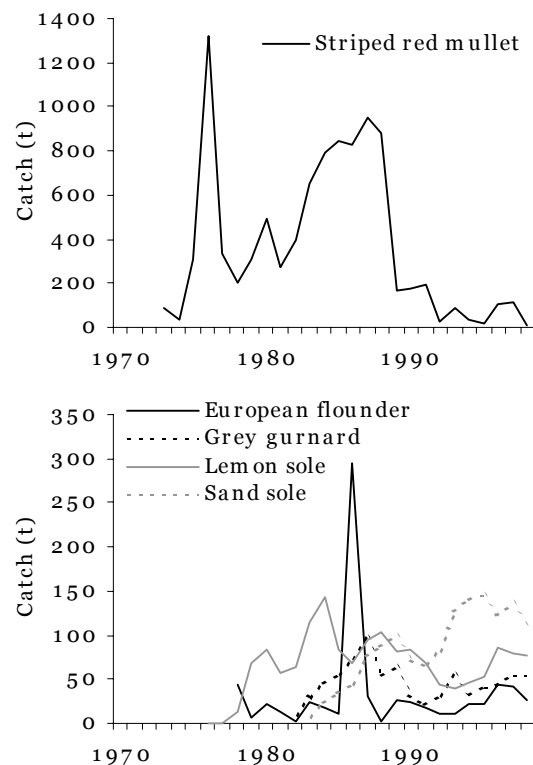

**Figure 13.** Evolution of the catches of 'Medium (big) demersal' selected species for the period 1970-1998.

### Medium (small end) demersals (group 15)

This group is separated from 'medium (big end) demersals' by difference in mass since there was a wide range of medium demersals when considering length alone. The species included in this group are red bandfish (*Cepola macrophthalma*), dragonet (*Callionymus lyra*), dab (*Limanda limanda*), witch flounder (*Glyptocephalus cynoglossus*), Mediterranean rainbow wrasse (*Coris julis*), and grey gurnard juveniles (*Chelidonichthys gurnardus*). These fish are between 30 and 60 cm in length ( $L_{max}$ ) except for the red bandfish (80 cm) because it is ribbon shaped, and thus its weight is quite low. These fish consume mainly small invertebrates and worms, and to a lesser extent, small fish. They occur on soft, sandy or muddy bottoms. Witch flounder is the species occurring in the deepest waters, down to 1460 m.

Red bandfish occurs in the eastern Atlantic from the British Isles to Senegal. Dragonet has a very wide distribution, ranging in the North Atlantic from Norway and Iceland to Algeria. The dab is at the southern end of its range, which extends from Norway and Iceland to the Bay of Biscay. This is the only fish of this group that has a small fish component in its diet. Witch flounder is also at the edge of its range, which extends from Norway to northern Spain. No biomass data were available for any fish in this group.

There is very little commercial interest in this group, the 1998 catch for witch flounder and dab combined reaching 23 t (Table 12). Since the 1950s there has been only a minor fishery for these animals. Dab catches were more substantial throughout the 1970s (average 172 t·year<sup>-1</sup>) and fell to less than 60 t·year<sup>-1</sup> in the 1980s (Figure 14). Witch flounder yields have been less than 30 t·year<sup>-1</sup> except for a surge in 1994 of 123 t, and again another in 1997 of 835 t.

**Table 12.** Initial basic parameter summary for 'Medium (small end) demersals' species.

Species	Q/B (year <sup>-1</sup> )	M (year <sup>-1</sup> )	Catch in 1998 (t)
<i>Cepola macrophthalma</i>	8.299	0.379	0
<i>Callionymus lyra</i>	8.772	0.796	0
<i>Limanda limanda</i>	8.291	1.030	7
<i>Glyptocephalus cynoglossus</i>	7.666	0.609	16
Group value	8.257	0.703	23

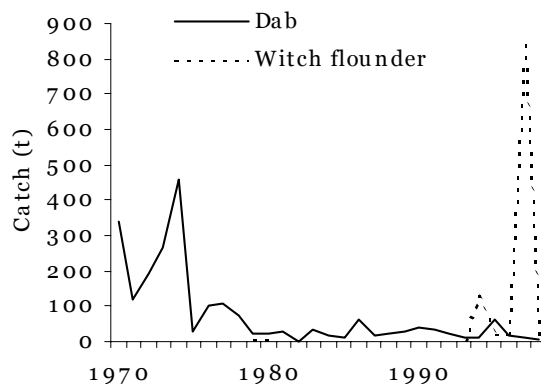

**Figure 14.** Evolution of the catches of 'Medium (small) demersal' species for the period 1970-1998

The length/weight relationships were from France (no locality), the Bay of Biscay, Spain and the North Sea. The average consumption rate was estimated at 8.257 year<sup>-1</sup>. The average natural mortality was estimated at 0.7 year<sup>-1</sup> (Table 12). However, in absence of an indicator for the level of exploitation of these species, we set the ratio production/consumption to 0.15 and let Ecopath estimate P/B and biomass.

The diet of this group, all based on quantitative information, was dominated by worms (33.5%), epibenthos (17.0%) and benthic infauna (16.7%, including 11.3% amphipods), adding up to 67%. The remainder of the diet was composed of 'shrimp' (11.8%), 'large zooplankton' (7.7%) and 'echinoderms' (4.0%), the remainder is small fish ('small deepwater' and 'small demersals'), 'cephalopods' and 'detritus'.

### Small demersals (group 16)

The 'small demersals' are small demersal and reef-associated fish, between 15 and 30 cm  $L_{max}$ . They reside in a wide range of depths from as shallow as 2-40 m (damselfish) to 110-1000 m (silvery cod), and occur over sandy, muddy or hard bottoms. Also, they may be associated with coral or aquatic vegetation. The group includes hooknose (*Agonus cataphractus*), imperial scaldfish (*Arnoglossus imperialis*), damselfish (*Chromis chromis*), butterfly blenny (*Blennius ocellaris*), goldsinny wrasse (*Ctenolabrus rupestris*), scaldfish (*Arnoglossus laterna*), tomtate grunt (*Haemulon aurolineatum*), red mullet (*Mullus barbatus*), silvery cod (*Gadiculus argenteus*) and wedge sole (*Dicologlossa cuneata*). Silver cod was identified as a pelagic animal (Cohen *et al.*, 1990), but it is better suited to this group over 'small pelagics' (high or low TL) as it feeds exclusively on the sea floor. The tomtate grunt occurs only in the western Atlantic

(Robins and Ray, 1986), but it was included in this model because ICES has a commercial catch record for it in Area VIII (1998).

The hooknose is probably a minor player in the ecosystem, as its range barely extends to the Bay of Biscay. Damsel fish was noted to occur more often on the islands of the eastern Atlantic, and less often close to mainland (Loris and Rucabado, 1990) and so probably plays a minor role as well. Butterfly blenny has a narrow range in the eastern Atlantic, from Morocco to the English Channel. Tomtate grunt probably occurs only in low numbers in the Bay of Biscay (see above). Judging by its relatively large catch, the wedge sole is likely the most abundant of these animals.

Only tomtate grunt and wedge sole are commercially fished. Tomtate grunt had a very low catch in 1998, at only 16 t, wedge sole catch was more substantial at 476 t (Table 13). Neither fish have a historical catch record. The biomass of this group was estimated by Ecopath using an ecotrophic efficiency of 0.95.

**Table 13.** Initial basic parameter summary for 'Small demersals' species.

Species	Q/B (year <sup>-1</sup> )	P/B (year <sup>-1</sup> )	Catch in 1998 (t)
<i>Agonus cataphractus</i>	7.914	0.986	0
<i>Arnoglossus imperialis</i>	8.052	0.670	0
<i>Chromis chromis</i>	8.507	0.670	0
<i>Blennius ocellaris</i>	8.291	0.780	0
<i>Ctenolabrus rupestris</i>	9.562	0.728	0
<i>Arnoglossus laterna</i>	10.239	1.087	0
<i>Haemulon aurolineatum</i>	6.761	-	19
<i>Mullus barbatus</i>	8.304	0.614	0
<i>Gadiculus argenteus</i>	10.003	0.991	0
<i>Dicologlossa cuneata</i>	8.551	-	476
Group value	8.618	1.2 <sup>a</sup>	545

<sup>a</sup>Increased from 0.816 year<sup>-1</sup> to increase P/Q.

Of the 10 fish that compose the average, four estimates of asymptotic weight are from Spain, three are from France (one of those from Biscay), one is from Greece (damsel fish, *Chromis chromis*), one from the USA (tomtate grunt, *Haemulon aurolineatum*) and one is a generic value. Temperatures from Greece and the USA may be too warm, and probably yield higher Q/B values. However, consumption rate for all animals falls under a narrow range between 8 and 10.2 year<sup>-1</sup>, except for tomtate grunt (USA figure, 6.8). The tomtate grunt is by far the most massive fish. Its weight and consumption rate are more

akin to the 'large demersals', but it was put in this group because its length is below 30 cm, and so its prey are presumably small. Wedge sole consumption rate is based on weight/length relationships from the Bay of Biscay. Since its Q/B appears to be reliable, and since it is probably the most abundant fish, it should be considered a yardstick for evaluating the accuracy of the group's average value. Indeed wedge sole Q/B is very close to the group's average (8.55 compared to average group value of 8.62 year<sup>-1</sup>).

Since most fish in this group are not commercially caught, total mortality (and therefore production rate) was assumed to equal natural mortality. There is a wide range of production values in this group, approximately from 0.6 (red mullet) to 1.0 (scaldfish) (Table 13). The average P/B for the group was 0.816 year<sup>-1</sup>, but that value was increased to 1.2 year<sup>-1</sup> in the initial model in order to fall between 'medium (small) demersals' and 'very small demersal high TL' groups. This yields a P/Q ratio of 0.14, which is reasonable.

Of the ten fish that compose this group, quantitative diet information was only available for six. Information for imperial scaldfish, butterfly blenny, wedge sole and damsselfish was qualitative and non-specific as for prey groups. The diet composition of scaldfish and butterfly blenny included 50% 'unidentified benthic crustaceans', which was put in 'epibenthic'. It is likely that a fraction of these unidentified crustaceans would represent 'crabs', 'shrimp', 'benthic infauna' or other alternate crustacean prey groups, but of all the crustacean groups, only epibenthos is consumed in quantity by the other members of the 'small demersals'. The diet of damsselfish was assumed to be composed of 50% of 'epibenthic' pycnogonids (sea spiders). This seems too exclusive for a prey that probably occurs in only minor abundance. However, this quantity of 'epibenthic' prey is not unreasonable, considering the diets of other fish in the group. Scaldfish diet is 50% 'unidentified finfish'. Although finfish is usually said to include sharks and rays, scaldfish are too small to prey on elasmobranchs and so their unidentified component is divided between very small demersal high and low TLs. In all, four of ten species had 'unidentified fin/bonyfish' components, which were uniformly divided between 'very small demersal high/low TL'. Initial diet matrix is probably reasonable, although 'epibenthos' may be overestimated.

### Very small demersal high TL (group 17)

This group is composed of 3 demersal and 2 reef-associated small fish (less than 30 cm  $L_{max}$ , less than 30 g  $W_{inf}$ ), differentiated from the 'very small demersal low TL' group only by trophic level (3.5 versus 3.0). They are the reticulated dragonet (*Callionymus reticulatus*), rock cook (*Centrolabrus exoletus*), dragonet (*Callionymus maculatus*), cardinal fish (*Apogon imberbis*) and Jeffrey's goby (*Buenia jeffreysi*). These animals occur as deep as 330 m (Jeffrey's goby) and feed on small benthic crustaceans, worms and small fish.

In the Northeast Atlantic, reticulated dragonet occurs from Portugal to the North Sea, rock cook occurs from Portugal to Norway. Dragonet *C. maculatus* occurs from Iceland and Norway to Senegal. Cardinalfish are at the northern extent of their range, they are common only as far north as Portugal. Jeffrey's goby is at the southern extent of their range, from Iceland to Brittany, France.

The length/weight relationships were from Scotland and Spain for rock cook and dragonet, respectively. The values for the three remaining fish were based on generic estimates of asymptotic weight from FishBase. The length/weight relationship for rock cook refers to females only. Except for cardinal fish, at  $Q/B=10.6 \text{ year}^{-1}$ , all consumption rates fall under a very narrow range, from 11.4 to 11.6  $\text{year}^{-1}$  (Table 14). The group average of 11.24  $\text{year}^{-1}$  is probably reasonable. Since there are no commercial fish in this group, production rate, is equal to natural mortality (average  $M=1.334 \text{ year}^{-1}$ ). The range is broad, from 0.9 for dragonet, to 1.8  $\text{year}^{-1}$  for Jeffrey's goby (Table 14). No biomass data were available for this group, though cardinal fish and Jeffrey's goby are probably minor in abundance.

**Table 14.** Initial basic parameter summary for 'Very small demersal high TL' species.

Species	Q/B ( $\text{year}^{-1}$ )	P/B ( $\text{year}^{-1}$ )
<i>Callionymus reticulatus</i>	11.630	1.190
<i>Centrolabrus exoletus</i>	11.525	1.294
<i>Callionymus maculatus</i>	11.423	0.920
<i>Apogon imberbis</i>	10.257	1.494
<i>Buenia jeffresii</i>	11.364	1.820
Group value	11.240	1.344

Diet information is based on five fish, all listed in Table 14 except for Jeffrey's goby and hake juveniles. Three of the five fish are based on qualitative information. 'Unidentified benthic

crustaceans' are assumed to fall under 'epibenthos' for reticulated dragonet and Jeffrey's goby, composing 50% and 100% of their diets respectively. A fraction of these amounts may be attributable to 'crabs', 'benthic infauna' and other large crustacean groups. However, considering the very small size of these two species, it is reasonable to assume that they prey on small enough crustaceans that they may be considered 'epibenthos'. Only dragonet (*C. maculatus*) and reticulated dragonet consume a large proportion of worms. Cardinal fish adults were exceptional as they consumed 100% small fish, which was assumed to be 50% 'very small demersal high TL' and 50% 'very small demersal low TL'. Elsewhere in the model, where diet is evenly divided among likely prey, exceptions are made to avoid cannibalism within the group. This was not done for cardinal fish because theirs is already the smallest size class.

### Very small demersal low TL (group 18)

This group represents only the small sandeel (*Ammodytes tobianus*), and later it was expanded to include transparent goby (*Aphia minuta*) as well. Transparent goby was in 'small deepwater' based on diet (100% small zooplankton), but its extremely small size and low trophic level merited the change. The transparent goby is demersal, coastal, and shallow (80 m), and at 0.3 g  $W_{inf}$ , it is by far the smallest fish in the model. The sand eel is much larger at 16.0 g  $W_{inf}$ , and lives inshore and over sandy bottoms, like the transparent goby.

Sand eel occurs from Spain to Murmansk. Transparent goby is found from Norway to Morocco. It has no catch and does not appear in the diets of higher predators and so probably occurs at a much lower abundance than sand eel. The sand eel is listed as a 'highly important commercial' fish in FishBase, but ICES catch in 1998 was only approximately 44 t (2/3 of the *Ammodytes* spp. statistics), and no information is available for ICES Area VIII prior to then. Transparent goby is not a commercial species.

The consumption rate ( $= 23.0 \text{ year}^{-1}$ ) for the transparent goby is the highest in the model, owing to its extremely small body size. Since this species is relatively unimportant in the system compared to the much more abundant sandlance. It was therefore omitted from the calculation and  $Q/B$  was set at 11.3  $\text{year}^{-1}$ . For the same reason, natural mortality ( $=1.18 \text{ year}^{-1}$ ) was based on sandeel only (Table 15). However, in absence of information on fishing mortality we let Ecopath



estimate both P/B and biomass based on EE of 0.95 and P/Q of 0.15.

Diet information for both species was based on a qualitative record. Sand eels consume diatoms which are grouped within 'primary producers'. It was assumed that sand eel prey on diatoms and large zooplankton evenly and that transparent goby preyed exclusively on copepods.

**Table 15.** Initial basic parameter summary for 'Very small demersal low TL' species.

Species	Q/B (year <sup>-1</sup> )	M (year <sup>-1</sup> )	Catch in 1998 (t)
<i>Ammodytes tobianus</i>	11.301	1.18	44
<i>Aphia minuta</i>	22.967	3.538	0
Group value	11.301 <sup>a</sup>	1.18 <sup>a</sup>	44

<sup>a</sup>Based on *Ammodytes tobianus* only.

**Rays/skates (group 19)**

The basic parameters were estimated using data from the longnosed skate (*Raja oxyrinchus*), shagreen ray (*Leucoraja fullonica*), thorny skate (*Amblyraja radiata*), blue skate (*Raja batis*), thornback ray (*Raja clavata*), spotted ray (*Raja montagui*), pale ray (*Bathyraja pallida*), Richardson's ray (*Bathyraja richardsoni*) and cuckoo ray (*Leucoraja naevus*). Most are demersal or bathydemersal, except for shagreen ray, which is benthopelagic. These creatures are found at a wide range of depths, from as shallow as 15 m (long nosed skate) to as deep as 2500 m (Richardson's ray) and all feed off the bottom.

There were no biomass data available for any species in this group. Most of them are found in coastal waters between Norway and Morocco, from the coast to the upper part of the continental slope. The thorny skate is at the southern most end of its distribution in the Bay of Biscay, and so probably occurs in small numbers. Blue skate has been critically overfished, and is endangered or extirpated in certain areas of its range (Hilton-Taylor, 2000). These animals are probably also low in abundance in the Bay of Biscay. Thornback ray is cited as one of the most abundant rays in the Northeast Atlantic (Hilton-Taylor, 2000). Pale ray is a rare fish (Stehmann and Bürkel, 1984) and its biomass is probably negligible. Richardson's ray occurs only in the northwest Bay of Biscay. Most of its habitat is deeper and on the continental slopes, beyond the western boundaries of ICES Area VIIIa,b.

There are six commercial species of the nine that compose this group. Cuckoo ray is the most important with 1124 t harvested in 1998 (Table

16). Spotted ray and thornback ray are and have historically been comparable in annual yields. Catch rates for both species have remained between 150-250 t·year<sup>-1</sup> since 1988 (Figure 15). In 1998, catch for spotted ray was 152 t, thornback ray was 162 t. ICES lists *Raja* spp. as a much more important element of the Biscay fishery, at a combined yield for 1998 of 5,444 t. It is unclear in the records to which species this number refers to, as all species mentioned by name total less than 1,500 t. The difference may be attributable to other species of rays and skates not elsewhere mentioned. The unknown *Raja* spp. component was included in the total landings of this group (total of 6912 t for Area VIII).

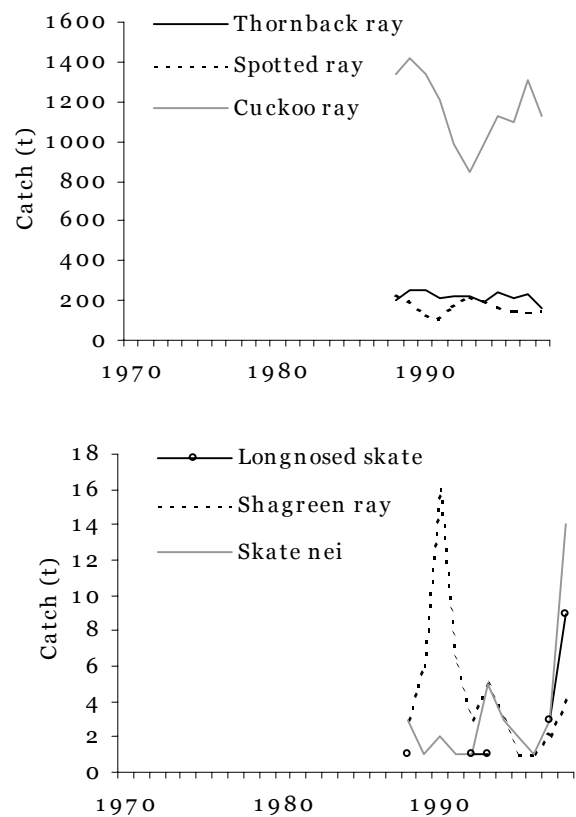

**Figure 15.** Evolution of the catches of 'Rays/skates' species for the period 1970-1998

Since there is no division in this group based on size, we see a great deal of variation in consumption rates. The lowest consumption rate belongs to Richardson's ray at 2.1 ( $W_{inf} = 56.8$  kg), and the highest to the spotted ray at 5.0 ( $W_{inf} = 2.4$  kg). The average Q/B is 3.612 year<sup>-1</sup> (Table 16). Three length/weight relationships came from the UK, one from Iceland and one from the Bay of Biscay. Waters of the UK and Iceland are colder than Biscay, and so we may expect  $W_{inf}$  to be underestimated. The remaining four estimates of

asymptotic weight are taken directly from FishBase. Assuming that fishing mortality amounted to two-thirds of natural mortality (= 0.245 year<sup>-1</sup>), P/B was estimated as 0.315 year<sup>-1</sup>. The biomass, was obtained from the ratio catch over biomass, was estimated at 0.487 t·km<sup>-2</sup>.

Diet information was based on the same species listed in Table 16, minus Richardson's ray and the pale ray. Over 80% of their diet consisted of benthic crustaceans, worms and demersal fish. The proportion of fish or crustaceans varied between species. Shagreen ray and long nosed skate consume only zoobenthos, cuckoo ray consumes roughly 50% zoobenthos and 50% fish and blue skate consumes only bony fish. All diet information is based on quantitative data, although a large fraction of the fish prey was termed 'unidentified bony fish'. These values were distributed evenly among what was considered the most likely prey; 'medium deepwater', 'small deepwater', 'medium (big end) demersal', 'medium (small end) demersal', 'small demersal', 'very small demersal high TL' and 'very small demersal low TL'.

### Small sharks (group 20)

This group is composed of four species of dogfish: the black dogfish (*Centroscyllium fabricii*), piked

dogfish (*Squalus acanthias*), Portuguese dogfish (*Centroscymnus coelolepis*), longnose velvet dogfish (*Centroscymnus crepidater*), as well as the catshark (*Scyliorhinus canicula*). These elasmobranchs are less than 150 cm in length, and have an average weight of 9.2 kg. They are demersal and bathydemersal and reside at 200 m or below on sand or sand/rock bottoms.

The sharks in this group occur on both sides of the Atlantic except for the longnose velvet dogfish and the small spotted catshark, which are only found in the eastern Atlantic. All species occur at least from Iceland to Senegal, but piked dogfish and Portuguese dogfish extend further towards South Africa. Deepest is the Portuguese dogfish at 3700 m, most others are found above 1500 m except for the small spotted catshark which resides no deeper than 400 m. Longnose velvet dogfish is cited as common (Last and Stevens, 1994) and piked dogfish is said to be the world's most abundant shark (Compagno, 1984) although a precise biomass estimate is unavailable for either species in the Biscay region. All animals occur on the continental slope or shelf and are bathydemersal, except for the small spotted catshark which is demersal, and the piked dogfish, a benthopelagic.

**Table 16.** Initial basic parameter summary for 'Rays/skates' species.

Species	Q/B (year <sup>-1</sup> )	M (year <sup>-1</sup> )	F (year <sup>-1</sup> )	Catch in 1998 (t)
<i>Raja oxyrinchus</i>	3.180	0.190	0.114	9
<i>Leucoraja fullonica</i>	3.889	0.210	0.126	4
<i>Amblyraja radiata</i>	4.129	0.404	-	0
<i>Raja batis</i>	2.261	0.112	0.067	14
<i>Raja clavata</i>	4.444	0.354	0.213	165
<i>Raja montagui</i>	5.006	0.353	0.212	152
<i>Bathyrāja pallida</i>	3.080	0.180	-	0
<i>Bathyrāja richardsoni</i>	2.134	0.170	-	0
<i>Leucoraja naevus</i>	4.389	0.228	0.137	1124
<i>Raja</i> sp.	-	-	0.147 <sup>a</sup>	5444
Group value	3.612	0.245	-	6912

<sup>a</sup>Assumed to equal 0.6 \* the average M of the group (=0.245).

**Table 17.** Initial basic parameter summary for 'Small sharks' species.

Species	Q/B (year <sup>-1</sup> )	M (year <sup>-1</sup> )	Biomass (t·km <sup>-2</sup> )	F <sup>a</sup> (year <sup>-1</sup> )	Catch in 1998 (t)
<i>Centroscyllium fabricii</i>	4.638	0.28		0	0
<i>Squalus acanthias</i>	4.158	0.11	0.031	0.17	193
<i>Centroscymnus coelolepis</i>	3.714	0.22		0	0
<i>Centroscymnus crepidater</i>	3.533	0.21		0	0
<i>Scyliorhinus canicula</i>	5.484	0.25	0.349	0.39	4983.5
Group value	4.305	0.213 <sup>b</sup>	0.38 <sup>c</sup>	-	5199.5

<sup>a</sup>Assuming F = 0.6 \* M; group P/B = 0.255; minimum biomass required to account for fishing pressure.

Catshark is the only major commercial fish in the group. ICES catch data indicate that Scyliorhinidae catches reached 9,967 t in 1998. This value was split evenly between 'small sharks' and 'large sharks' (each functional group has one Scyliorhinidae representative) (Table 17). A much smaller fishery exists for the piked dogfish. Catches for this animal have been higher in the 1980s, peaking at 608 t in 1981 and gradually declining throughout the 1980s, reaching the present day yields by about 1994 (Figure 16). The 1998 catch of piked dogfish was 193 t.

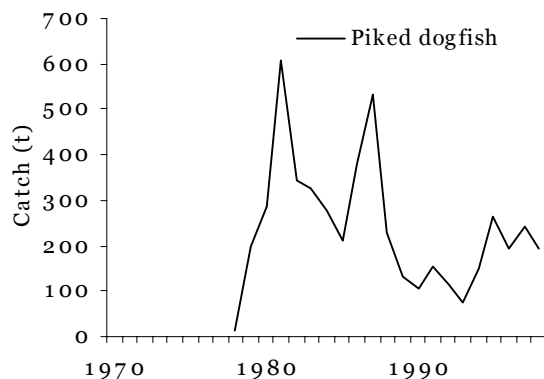

**Figure 16.** Evolution of the catches of 'Small sharks' species for the period 1970-1998

Length/weight data for three species were from Scotland, one was from the Bay of Biscay and one from the Northeast Atlantic. Consumption rates vary from 3.533 (longnose velvet dogfish) to 5.484 year<sup>-1</sup> (catshark), with an average of 4.305 year<sup>-1</sup> for the group. The average natural mortality was estimated at 0.245 year<sup>-1</sup> (Table 17). In absence of information on fishing mortality, it was assumed to be equal to 2/3 of M, yielding a P/B value 0.255 year<sup>-1</sup>. The minimum estimate of biomass for the group obtained by using the ratio Catch/F was 0.38 t·km<sup>-2</sup>. This value was later increased to 0.5 t·km<sup>-2</sup> to balance the model.

This group's diet information is based on quantitative data. A significant portion of the diet consists of what was called 'unidentified bony fish'. The most likely preys were assumed to be 'small deepwater', 'small demersal' and 'very small demersal high/low TL'. All species in this group consume cephalopods to some degree; from 65% of the diet in Portuguese dogfish, to 5.8% of the diet in catshark, yielding an average of 28%. 'Small deepwater' fish (including 'unidentified') constituted 17.9% of the diet of which 14.1% was lanternfish (Myctophidae). Other significant prey items are 'other demersal fish', shrimps and crabs.

## Large sharks (group 21)

This functional group is composed of pelagic, benthopelagic, demersal and bathydemersal sharks; nurse shark (*Ginglymostoma cirratum*), blue shark (*Prionace glauca*), basking shark (*Cetorhinus maximus*), great white shark (*Carcharodon carcharias*), nursehound (*Scyliorhinus stellaris*), frilled shark (*Chlamydoselachus anguine*), tope shark (*Galeorhinus galeus*), gulper shark (*Centrophorus granulosus*), leafscale gulper shark (*Centrophorus squamosus*), thintail thresher (*Alopias vulpinus*) and the porbeagle (*Lamna nasus*). Their average asymptotic weight (2,428 kg) represents a broad range of body sizes, from 44.0 kg (tope shark) to over 9,000 kg (great white shark). They may be oceanic like the blue shark, coastal like the tope shark and thintailed thresher, or reef associated like the nurse shark and nursehound. Their depths range from 350 m (blue shark) to 1280 m (great white shark). Most are consumers of fish and/or benthos. Basking shark is a filter feeder and the only shark to feed only on zooplankton. Accordingly its trophic level is much smaller than the other 'large sharks' at 3.4 compared to a group average of 4.2.

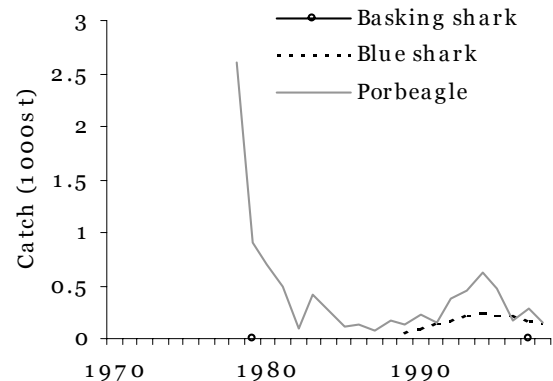

**Figure 17.** Evolution of the catches of 'Large sharks' species for the period 1970-1998

No biomass estimates were found for these sharks, accounts being generally qualitative. The nurse shark is incidental to France (Compagno, 1984) and is probably not a significant contributor to biomass. Basking shark is a protected animal (FAO, 1994) and presumed to be uncommon. Although great white sharks are widespread, they are endangered and very low in abundance (Hilton-Taylor, 2000). Frill shark is also cited as uncommon (Hilton-Taylor, 2000). The blue shark is historically an abundant species in the Atlantic, though their population are in decline. The porbeagle has been overexploited in the North Atlantic, but is not threatened (Hilton-Taylor, 2000) (Figure 17). The blue shark and

porbeagle are probably the most numerous large sharks in the Bay of Biscay. The distribution of 'large sharks' at least spans from Norway to Morocco, except for the great white shark, which is at the northern extent of its range in France. The basking shark, thintailed thresher and blue shark are highly migratory; the blue shark is considered the most widespread shark in the world (Compagno, 1984). The habitats of these animals extend from near shore to the continental shelf and beyond.

Besides the target fisheries, there is a lot of incidental bycatch which may be responsible for a large portion of the fishing mortality for large sharks (Compagno, 1984). Historically, the porbeagle and blueshark have been the most heavily exploited animals in this group. Trivial catches of basking shark were recorded in 1979 and 1997, at 7 t and 1 t respectively. Catch of nursehound was assumed to be half that of Scyliorhinidae in Area VIII (Table 18).

Length/weight relationships were available for 7 species out of 11 in this group. However, length/weight relationships from the Northeast Atlantic were available only for the blue shark

(from the UK). All other information was from the Atlantic or Pacific US, or generic. There is a large range of consumption rates for these animals, from the lowest rate of 1.2 for the great white shark, to the highest rate of 3.1 for the gulper and leafscale gulper sharks. Overall, consumption rate estimates (average  $Q/B=2.379$  year<sup>-1</sup>) may not be reliable for this group. The average natural mortality was estimated as 0.145 year<sup>-1</sup>. Using the same approach as for small sharks, we obtained an average  $P/B$  of 0.175 year<sup>-1</sup> and a biomass of 0.506 t·km<sup>-2</sup>. This could be an underestimate, as it does not take the non-commercial species into account.

Diet composition for all fish was from quantitative sources. The basking shark is unique in this group as it is a filter feeder consuming zooplankton (Compagno, 1984). The 'large sharks' are diverse and represent many different habitats, lifestyles and feeding strategies. Accordingly, this group has a very broad spectrum of prey items of fish and benthos. Each item contributes no more than 6.9% to the average diet, except for cephalopods (30%) which are heavily consumed by all species except for the basking shark.

**Table 18.** Initial basic parameter summary for 'Large sharks' species.

Species	Q/B (year <sup>-1</sup> )	M (year <sup>-1</sup> )	Biomass (t·km <sup>-2</sup> )	F (year <sup>-1</sup> )	Catch in 1998 (t)
<i>Ginglymostoma cirratum</i>	2.002	0.090	-	0	0
<i>Prionace glauca</i>	1.660	0.02	0.013	0.12	147
<i>Cetorhinus maximus</i>	1.393	0.08	-	0	0
<i>Carcharodon carcharias</i>	1.249	0.09	-	0	0
<i>Scyliorhinus stellaris</i>	3.061	0.18	0.478	0.11	4983.5
<i>Chlamydoselachus anguine</i>	2.757	0.15	-	0	0
<i>Galeorhinus galeus</i>	3.074	0.15	-	0	0
<i>Centrophorus granulosus</i>	3.080	0.18	-	0	0
<i>Centrophorus squamosus</i>	3.080	0.18	-	0	0
<i>Alopias vulpinus</i>	2.329	0.12	-	0	0
<i>Lamna nasus</i>	2.482	0.18	0.015	0.11	157
Group value	2.379	0.145	0.506 <sup>a</sup>	-	5287.5

<sup>a</sup>Minimum biomass required to account for fishing pressure.

**Tuna-like fish (group 22)**

This group is composed of highly commercial, large pelagic species with low natural mortalities and large fishing mortalities. They tend to have high trophic levels (group average is 4.3) and feed mainly on schooling forage fish and squid. They are typically oceanic, but may feed close to shore. The species are bluefin tuna (*Thunnus thynnus*), swordfish (*Xiphias gladius*), albacore (*Thunnus alalunga*), bullet tuna (*Auxis rochei rochei*), frigate tuna (*Auxis thazard thazard*), big eye tuna (*Thunnus obesus*), and skipjack tuna (*Katsuwonus pelamis*).

There were no biomass data available for these animals, which are all highly migratory, their distributions extending from at least Norway to the Canary Islands. Bullet tuna is found the most shallow (to 10 m) and occurs near the coastline. Bullet tuna and frigate tuna are cited as very abundant species, and probably important forage fish to other commercial ‘tuna-like’ species.

Albacore are historically the most important species (Figure 18). Annual yields declined after the peak season in 1974 (66,766 t) and oscillated between 15,000-25,000 t. Throughout the 1990s, catches remained at around 14,500 t·year<sup>-1</sup>, until a dismal catch in 1998 of only 1728 t. Bluefin tuna and swordfish similarly showed peak catches in the early 1970s and have since declined (Figure 18). Yields of bluefin tuna saw a resurgence in the early 1990s and have been high until very recently (5180 t in 1995). From 1995 to 1998, swordfish catches were low (225 t·year<sup>-1</sup> average), as compared to peak catches in 1973 of 5245 t (Table 19).

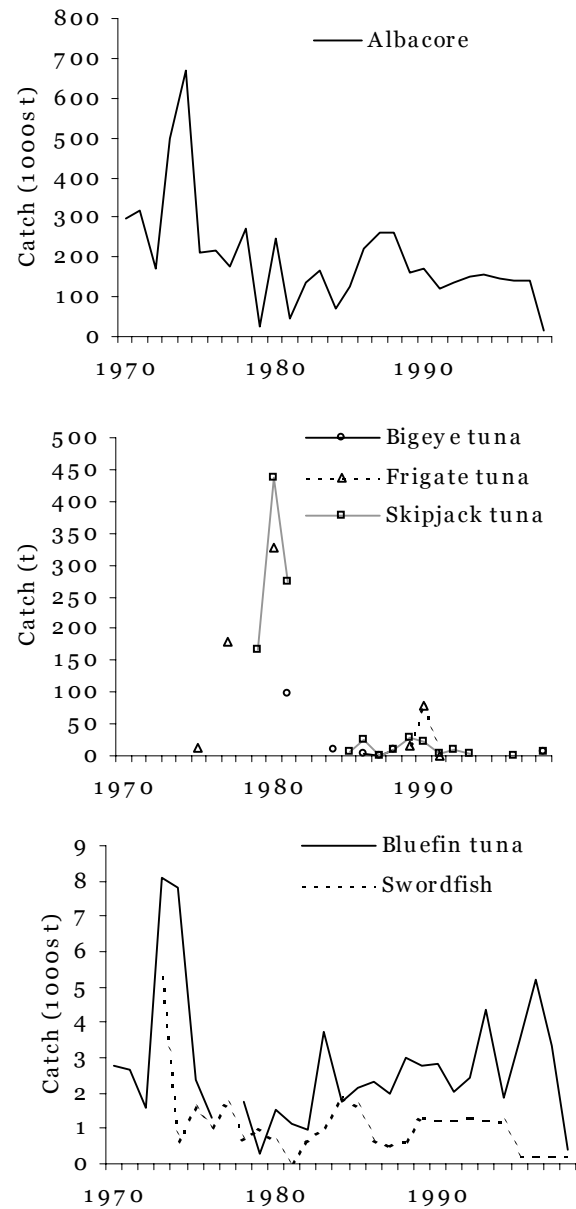

**Figure 18.** Evolution of the catches of ‘Tuna-like’ species for the period 1970-1998

**Table 19.** Initial basic parameter summary for ‘Tuna-like fish’ species.

Species	Q/B (year <sup>-1</sup> )	M (year <sup>-1</sup> )	Biomass (t·km <sup>-2</sup> )	F <sup>a</sup> (year <sup>-1</sup> )	Catch in 1998 (t)
<i>Thunnus thynnus</i>	1.800	0.115	0.015	0.25	372
<i>Xiphias gladius</i>	2.420	0.233	0.008	0.3	244
<i>Thunnus alalunga</i>	3.135	0.248	0.04	0.44	1728
<i>Auxis rochei rochei</i>	2.451	0.15	-	-	1.6
<i>Auxis thazard thazard</i>	3.189	0.119	-	-	1.6
Other tunas	-	-	-	-	11
Group value	2.599	0.373	0.064 <sup>b</sup>	0.174	2358.2

<sup>a</sup>Interpretation based on stock assessment documents;  
<sup>b</sup>Minimum biomass required to account for fishing pressure.

All estimates of asymptotic weight were calculated using generic length/weight relationships, except for bullet and frigate tuna, whose length/weight relationships were from the tropical Atlantic and Spain, respectively. The average Q/B was 2.599 year<sup>-1</sup> and the average natural mortality was estimated at 0.373 year<sup>-1</sup>. Fishing mortality was taken from the International Commission for the Conservation of Atlantic Tunas (ICCAT). Annual fishing mortality for bluefin tuna has been estimated at 0.1 for ages 6-7, 0.23 for age 8 and 0.25-0.4 for ages 8+ (Anon., 1998b). We chose 0.25 year<sup>-1</sup> for the entire population (Table 19). We estimated swordfish fishing mortality at 0.3 based on ICCAT estimate of 0.25 for age 5+ males and 0.57 for ages 9+ females (Anon., 1999e). Fishing mortality for albacore (= 0.44 year<sup>-1</sup>) was also taken from an ICCAT assessment report (Anon., 1998a). The minimum estimate of biomass obtained from the ratio catch/F is 0.064 t·km<sup>-2</sup>, which was later increased to 0.07 to balance the model.

The animals in this group feed from the entire water column. The unidentified bony fish component of their diets was divided evenly among what was considered the most likely prey items. In other groups the most likely prey items were taken to be all lesser size classes of fish that occupy similar habitats. This method would be ungainly for 'tuna-like' fish who have been shown

to consume pelagic and benthic-pelagic preys from all size classes. Therefore, the most likely prey groups were considered to be the four groups that most often appeared as prey items, namely: 'very large demersal high TL', 'very small demersal high TL', 'small deepwater', and 'small pelagic high TL'.

### Crabs (group 23)

This functional group consists of macrobenthic crabs and Norway lobster. Basic parameters are estimated using male and female edible crab (*Cancer pagurus*), green crab (*Carcinus maenas*), spinous spider crab (*Maja squinado*) and male and female Norway lobster (*Nephrops norvegicus*). Spinous spider crab occurs at 40-100 m depth, edible crab is found to 200 m and Norway lobster concentrates between 300-600 m.

Green crab landings increased abruptly in 1991 to about 200 t (Figure 19). All other commercial species of this group have seen their landings decline steadily starting in the 1970s or 1980s. The Q/B value (= 10 year<sup>-1</sup>) for this group was taken from Jarre-Teichmann and Guénette (1996). P/B (=2.12 year<sup>-1</sup>) was based on green crab (Swedish waters; Pihl, 1985), edible crab (Bay of Biscay; Anon., 1998d) and Norway lobster (Anon., 1999a) (Table 20).

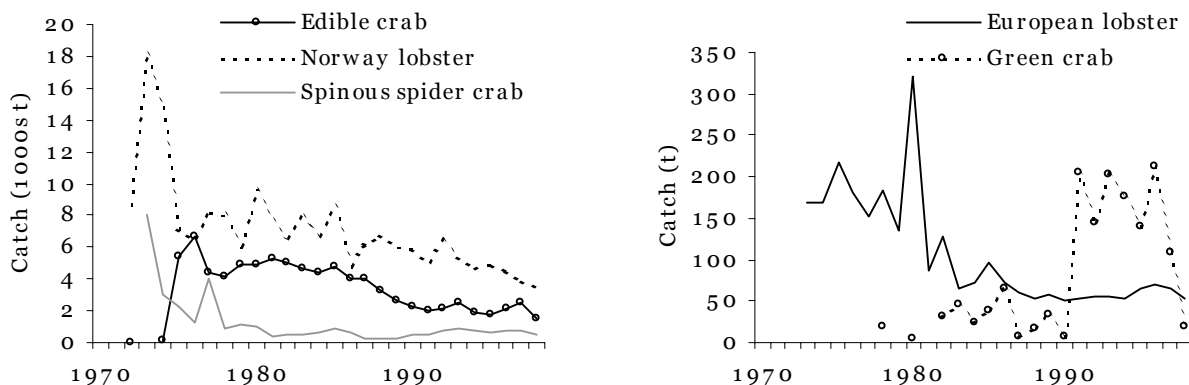

**Figure 19.** Evolution of the catches of 'Crabs' species for the period 1970-1998

**Table 20.** Initial basic parameter summary for 'Crabs' species.

Species	P/B (year <sup>-1</sup> )	Biomass (t·km <sup>-2</sup> )	F (year <sup>-1</sup> )	Catch in 1998 (t)
<i>Cancer pagurus</i>	1.04	0.017	0.940	1519
<i>Carcinus maenas</i> (1 group)	6.9	0.017	-	20
<i>Maja squinado</i>	-	-	-	489
<i>Nephrops norvegicus</i> (male)	0.489	0.097	0.189 <sup>b</sup>	1759.5 <sup>c</sup>
<i>Nephrops norvegicus</i> (female)	0.420	0.083	0.220 <sup>b</sup>	1759.5 <sup>c</sup>
Other crabs/lobsters	-	-	-	101
Group value	2.212	0.196 <sup>a</sup>	0.140	5648

<sup>a</sup>A very small proportion of the real biomass; <sup>b</sup>calculated from catch and biomass; <sup>c</sup>catches distributed equally among males and females.

Fishing mortality for edible crab ( $=0.94 \text{ year}^{-1}$ ), taken from a stock assessment report (Anon., 1998d) for the Bay of Biscay, was used to back-calculate the biomass to  $0.017 \text{ t}\cdot\text{km}^{-2}$ . The biomass of *Nephrops norvegicus* present in the Bay of Biscay was taken from a stock assessment report (Anon., 1999a). However, the total biomass calculated for this group is very small and represent only a small proportion of this group. Thus, biomass was left to be estimated by Ecopath.

Diet information is based on green crab (age 0 and age 1) (Leif, 1985), Norway lobster (Cristo, 1998) and velvet crab (*Necora puber*) (Gonzalez-Gurriaran *et al.*, 1995). Cannibalism in 'crabs' was high (18.7%) because large crabs feed on small crabs. The value was arbitrarily reduced by half, and this value shunted to the three most important prey groups; benthic infauna, molluscs and detritus. Of less importance in the crab diet are 'epibenthos', 'small demersal' fish and 'small zooplankton'.

### Shrimps/prawns (group 24)

This group is composed of pelagic and demersal shrimp, i.e., members of the families Penaeidae, Sergestidae and Oplophoridae. Basic parameters are estimated using northern shrimp (*Pandalus borealis*), common shrimp (*Crangon crangon*) and common prawn (*Palaemon serratus*).

Brown shrimp is cited as the most abundant shallow epibenthic species on the Swedish west coast (Pihl and Rosenber, 1982). Its distribution ranges in the North Atlantic from the coast of Norway and the North Sea to the Mediterranean (Cotman, 1993). The two most important commercial species in the Bay of Biscay are common shrimp and common prawn (Figure 20).

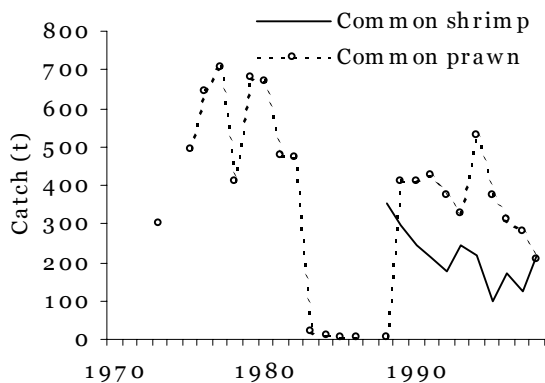

**Figure 20.** Evolution of the catches of 'Shrimp/prawn' species for the period 1970-1998

P/B ( $=1.45 \text{ year}^{-1}$ ) and Q/B ( $=9.667 \text{ year}^{-1}$ ) were taken from the Newfoundland/Labrador coast, i.e., for northern shrimp (Bundy *et al.*, 2000) (Table 21). For comparison, the P/B of penaeid shrimps in the Philippines was estimated at  $1.8 \text{ year}^{-1}$  (Pauly *et al.*, 1993). As the group includes several species that are not exploited or listed, we started by multiplying by five the biomass used in a model of the Newfoundland Labrador area ( $0.202 \text{ t}\cdot\text{km}^{-2}$ ). This initial value was too low because of the high predation to which shrimps are submitted. The final biomass value was  $6.1 \text{ t}\cdot\text{km}^{-2}$ .

The diet composition of shrimps/prawns is based on brown shrimp (*Crangon crangon*) (Pihl, 1985) and diets for herbivorous and predatory shrimps (Venier and Pauly, 1997). The most important food item for these animals is 'primary producers', at 35% of the diet, mainly from herbivorous shrimp. 'Benthic infauna' (28.1%) includes mostly small benthic crustaceans, meiofauna and amphipods. Detritus (18.4%) and worms constitute 18.4% and 8.4% of the diet respectively. The remainder are crabs, molluscs and 5.9% cannibalism, which was used in the initial diet matrix.

**Table 21.** Initial basic parameter summary for 'Shrimps/prawns' species.

Species	Q/B (year <sup>-1</sup> )	P/B (year <sup>-1</sup> )	Biomass (t·km <sup>-2</sup> )	Catch in 1998 (t)
Common shrimp	-	-	-	218
Common prawn	-	-	-	206
Group value	9.667 <sup>a</sup>	1.450 <sup>a</sup>	10.0 <sup>b</sup>	424

<sup>a</sup>From (Bundy *et al.*, 2000) assumes growth efficiency of  $0.15 \text{ year}^{-1}$ ;  
<sup>b</sup>Guesstimate.

### Worms (group 25)

Basic parameters were estimated for this group using generic data representing pelagic feeding polychaetes, detritivorous polychaetes (Venier and Pauly, 1997) and generic polychaetes (Jarre-Teichmann and Guénette, 1996). There are no commercial 'worm' species in the Bay of Biscay.

'Worms' Q/B was assumed to be  $22.2 \text{ year}^{-1}$  based on the value used for the southern BC shelf, and assuming polychaetes represent the 'worm' group (Jarre-Teichmann and Guénette, 1996). Bundy (2000) provided a range of P/B values of 2-3  $\text{year}^{-1}$  for polychaetes from the Scotian Shelf in eastern Canada. The lower estimate was used in the initial model as it is more indicative of the cold waters of the Bay of Biscay, and also consistent with Christensen's value from the North Sea, of  $2 \text{ year}^{-1}$  (Christensen, 1995).

EE was set at 0.95 and the biomass left to be estimated by Ecopath. The resulting biomass amounted to 12.964 t·km<sup>-2</sup>. For comparison, the biomass of Polychaeta in the North Sea was estimated at 32 t·km<sup>-2</sup> (Christensen, 1995). Polychaetes consume 100% detritus (Nesis, 1965 in Bundy *et al.*, 2000).

### Molluscs (group 26)

Basic parameters were estimated using only the arctic wedge clam (*Mesodesma deauratum*) as a representative species (Hutcheson *et al.*, 1981 in Bundy *et al.*, 2000). For the purpose of the diet matrix, prey items such as bivalves (oysters, scallops, clams, mussels), gastropods and barnacles were included in this group. We are aware of no catch for this group.

The Q/B ratio of molluscs (=6.3 year<sup>-1</sup>) is based on 'invertebrate benthos' of the southern BC shelf (Jarre-Teichmann and Guénette, 1996). Production rate is taken from Hutcheson *et al.* (1981 in Bundy *et al.*, 2000) study of arctic wedge clam from the Southeast Shoal area of the Grand Banks. The authors estimated the production rate of small individuals as 0.57 year<sup>-1</sup> and large individuals as 0.11 year<sup>-1</sup>. The larger production rate was used because the temperature in the Bay of Biscay is higher than the Grand Banks.

In absence of data, we left the biomass to be estimated by Ecopath using EE=0.95. The resulting biomass amounted to 33.512. For comparison, the 'molluscs' biomass of the Grand Banks (Eastern Canada) was estimated at 42.1 t·km<sup>-2</sup> (Hutcheson *et al.*, 1981; in Bundy *et al.*, 2000).

Bivalves are representative of the group 'molluscs'. They are filter-feeders and are assumed to feed on suspended detritus, small zoobenthos, zooplankton, and phytoplankton. Diet in the initial unbalanced model was taken to be 25% each of 'small zooplankton' and 'primary producers', and 50% 'detritus'. To balance the initial model, it became necessary to reduce their predation on 'small zooplankton' and 'small zooplankton' to 8% of their diet. The difference was transferred to 'detritus' and phytoplankton. Bundy (2000) assumed their diets to be exclusively detritus.

### Cephalopods (group 27)

This group is composed of squids, cuttlefish and octopus. Biomass information was not found for cephalopods in the Bay of Biscay and was left to

be estimated by Ecopath. These animals can occur deep (750 m *Illex illecebrosus*) (Amaratunga, 1983), in the open ocean or on the continental shelf (*Loligo* sp., *Sepia* sp.). Most of these cephalopods are benthic (Mangold, 1983 in Wood and Day, 2000).

Since the 1950s, the most important commercial species in this group have been the common cuttlefish (*Sepia officinalis*), the northern shortfin squid (*Illex illecebrosus*), and the Angolan flying squid (*Todarodes sagittatus angolensis*) (Figure 21), although this last species is absent from 1998 ICES records. ICES catch database indicates only minor catches for cuttlefish, but the database of the 'Centre Administratif des Affaires Maritimes', Ministère de la Mer (see Melnychuk *et al.*, 2001) indicates much higher catches, 15,000 t in 1998 for Area VIII (0.022 t·km<sup>-2</sup>). Catches of northern shortfin squid were highest between 1987 and 1992, averaging 1830 t·year<sup>-1</sup>. Mid and late 1990s saw lower catches, and present-day values are only a small fraction of the former quantity (Table 22).

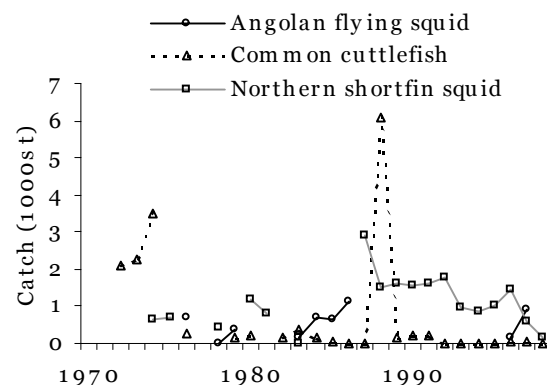

**Figure 21.** Evolution of the catches of Cephalopods for the period 1970-1998

**Table 22.** Initial basic parameter summary for 'Cephalopods' species.

Species	Q/B (year <sup>-1</sup> )	P/B (year <sup>-1</sup> )	Catch in 1998 (t)
<i>Illex</i> sp.	-	1.500	166
<i>Loligo</i> sp.	-	1.500	888
<i>Octopus vulgaris</i>	7.300	1.640	-
Generic squid	16.640	-	-
<i>Sepia officinalis</i>	-	-	~2125 <sup>a</sup>
Group value	8.0 <sup>b</sup>	2.5 <sup>c</sup>	~3179

<sup>a</sup>CAAM database (value scaled to represent area VIIIa, b);

<sup>b</sup>Reduced from 11.972 year<sup>-1</sup> to lower P/Q ratio;

<sup>c</sup>Assumes average cephalopod lifespan mid-value of 1.5-3 years (Gonçalves, 1993).



Basic parameters were estimated with *Illex* sp., *Loligo* sp. and octopus (*Octopus vulgaris*) (Cohen *et al.*, 1982) and generic squid from the Philippines (Pauly *et al.*, 1993). The consumption rate was based on a generic value for squids from the Philippines, and octopus (*O. vulgaris*) in the western Mediterranean (Guerra, 1979 in Pauly *et al.*, 1993). The value from the Mediterranean is probably reasonable, as the temperature is comparable (15°C compared to 13.9°C in Bay of Biscay). The values from the Philippines are probably too high, as the water is warmer. The overall value of 11.92 is very likely too high. This value was reduced to 8.0 year<sup>-1</sup> for the initial model.

The first estimate of P/B was based on *Illex* sp., *Loligo* sp. (Georges Bank, Cohen *et al.*, 1982) and *O. vulgaris* from the Mediterranean (Guerra, 1979 in Pauly *et al.*, 1993). A P/B value of 2.5 year<sup>-1</sup> was used instead of our original average value (1.547 year<sup>-1</sup>) because they live between 1.5-3 years (Gonçalves, 1993).

Diet information is estimated using European squid (*Loligo vulgaris*), European flying squid (*Todarodes sagittatus*), northern short-fin squid (*Illex illecebrosus*), octopus (*Octopus vulgaris*) and cuttlefish (*Sepia officinalis*). All diet information is based on detailed, but qualitative accounts from Cephbase (Wood and Day, 2000) except for common octopus (Boletzky and Hanlon, 1983). All food item entries in Cephbase for these species were weighted equally and assumed to equal 100%. For example, 100% of the diet of European squid was divided evenly among 50 food items (2% each). Food items were assigned groups and then repeats were weighted proportionally. Information for *L. vulgaris* came from the Galician coast, NE Atlantic, Algarve, Portugal and the Saharan Bank. The sources of cuttlefish data were the Tunisian coast and the Normano-Breton Gulf, France. European flying squid information was from northern Norwegian waters. The amount of cannibalism had to be decreased to 0.07 from 0.114.

### **Echinoderms (group 28)**

Basic parameters for this group were estimated from echinoderm values from the coral reef ecosystem of the Florida keys (Venier and Pauly, 1997); sea cucumbers (synaptid holothuroideans, *Holothuria floridana*), brittle stars (*Ophiostigma isacanthum*, amphiuroids, *Ophiolephs elegans*), sea urchins (*Echinaster sentus*, *Echinaster spiulosus*), sea stars (*Astropecten duplicatus*). Also included are *Echinometra mathaei*, *Diadema* spp., *Tripneustes* spp., generic

holothurian data from the Philippines (Pauly *et al.*, 1993), and generic echinoderm data from the southern BC shelf (Jarre-Teichmann and Guénette, 1996).

No biomass information was available for these species in the Bay of Biscay, so values from the North Sea model were used (Christensen, 1995). The Q/B value of generic echinoderms was taken from Jarre-Teichmann and Guénette (1996) for benthic groups of the southern BC shelf. Both areas are warmer than the Bay of Biscay so the average value of 4.7 year<sup>-1</sup> may be too high.

Production rate is based on *Echinometra mathaei* and generic holothurians from the Philippines (Pauly *et al.*, 1993) and sea cucumbers, brittle stars, sea urchins and sea stars from the Florida Keys coral reef system (Venier and Pauly, 1997). The average value (0.7 year<sup>-1</sup>) may be too high for the colder waters of the Bay of Biscay.

Diet information is based on Bundy and Gilkinson's echinoderms (Bundy *et al.*, 2000); sand dollar (*Echinarchnius parma*) (Hutcheson *et al.*, 1981; Mooi and Telford, 1982), sea urchin (*Strongylocentrotus pallidus*) (Gilkinson *et al.*, 1988) and brittle star (*Phiura robusta*) (Nesis, 1965 in Bundy *et al.*, 2000). Most described diets qualitatively. The most important diet item is 'molluscs', mostly gastropods and bivalves (36.9%). Also important is 'benthic infauna' (19.7% - exclusively from *Astropecten johnstoni*) and detritus (19.7%). Of less importance is epibenthos (12.7%). In the initial diet matrix there was 18.3% cannibalism in 'echinoderms', mostly from sea stars preying on sea urchins. This value was arbitrarily reduced by half in the initial model so that Ecopath could complete parameterization. The difference was divided among the three most important groups.

### **Epibenthos (group 29)**

This group consists of sessile/motile filter feeders and small benthic creatures that occur on top of the substrate, as opposed to 'benthic infauna' which are closely associated with the substrate. This distinction was created because the feeding modes of predators which consume 'epibenthos' and 'benthic infauna' differs in that infauna is filtered out of the sediment and epibenthos is consumed directly, i.e., grazed. Where diet items included unidentified benthos, these were usually assigned to 'epibenthos', as they were assumed to be on the surface of the sea floor and could not be more precisely categorized into crabs, worms, etc. Horseshoe worms (*Phoronis*) were placed in 'epibenthos' rather than 'worms' because they are

sessile organisms, which live in chitinous tubes anchored to rocks and shells. Sea spiders (pycnogonids) were placed in this group rather than with 'crabs' (where other arthropods were placed) because they largely feed on soft-bodied animals like *Cnidaria* and so their diet is inconsistent with more powerful predators like lobsters and crabs. Sessile filter-feeders in this group refer to sponges, other macrobenthic filter-feeders like bivalves and barnacles are included in 'molluscs'. Basic parameters are estimated using generic data representing cunaceans, tanaidaceans and ostracods (Venier and Pauly, 1997).

No information was found on the biomass of 'epibenthos' and was left for Ecopath to estimate. No species are exploited commercially. A Q/B of 9.0 year<sup>-1</sup>, was used in the initial model, based on sponges (Wilkinson, 1987 in Opitz, 1993) and corals (Sorokin, 1987 in Opitz, 1993) used for a Caribbean model.

Data for cunacean, tanaidecan and ostracod were from Sweden (Schwinghamer *et al.*, 1986 and Jorgensen *et al.*, 1991 both in Venier and Pauly, 1997). The P/B value was subsequently lowered from 4.79 to 2.7 year<sup>-1</sup> in order to produce a more reasonable GE value.

Diet information is based on bottom-living recruits/juveniles of common goby, sand goby, plaice and green crab (Pihl, 1985). Most of their diet is 'benthic infauna', largely amphipods (*Corophium volutator*). Ostracods are a small component of their diet (~8%), but this value was given to benthic infauna in the initial diet matrix to reduce cannibalism in this group.

### Large zooplankton (group 30)

Basic parameters were estimated based on euphausiids (*Thysanoessa longicaudata*, *Thysanopoda acutifrons*, *Meganctiphanes norvegica*), detritivorous amphipods (*Ampelisca* spp., *Gammarus mucronatus*, *Elasmopus* spp.), herbivorous amphipods (*Acunmindeutopus naglei*, *Ampithoe longimana*, *Caprella penantis*, *Cymadusa compta*, *Lembos rectangularis*) and isopods (*Paracereis caudata*, *Edotea triloba*, *Anthuridae*, *Spaeomatidae*).

The biomass used in the initial model was 18.343 t·km<sup>-2</sup>, after Koslow (1997, in Bundy *et al.*, 2000). This value was taken from the mid-continental shelf, off southeastern Australia, and included jellyfish, euphausiids and amphipods.

Q/B was based on three euphausiids from the Gulf of St. Lawrence (Sameoto, 1976) and krill from Nice, France (Heyraud, 1979 in Bundy *et al.*, 2000). The initial value used in the model was 28.417 year<sup>-1</sup>. Production rate was based on 3 euphausiids of the Rockall Trough (Mauchline, 1985), and detritivorous/herbivorous amphipods, and isopods from the Florida coral reef (Venier and Pauly, 1997). The original value of 2.979 year<sup>-1</sup> was then raised to 5.0 year<sup>-1</sup> in order to increase the P/Q ratio to something more reasonable for this group (=0.176).

The diet was based on euphausiids, isopods and herbivorous/detritivorous amphipods. A qualitative diet for euphausiids is provided by Bundy (2000) based on Mauchline (1980). Diet for isopods and amphipods are from qualitative accounts from Florida (Venier and Pauly, 1997).

### Small zooplankton (group 31)

Basic parameters are estimated using data on cyclopoid copepod (*Oithona similis*), and generic copepods. Cladocerans, calanoid copepods, mysids and barnacle larvae are also included in this group.

Biomass density of the 'small zooplankton' was taken from Bundy *et al.* (2000) at 21.7 t·km<sup>-2</sup>. This value was raised in subsequent versions of the model up to 32 t·km<sup>-2</sup>, to accommodate a high level of predation on this group. These animals are not taken commercially.

A generic consumption rate of 60 year<sup>-1</sup> was used from the North Sea (Bromley *et al.*, 1993). P/B of generic copepods is based on (Bromley *et al.*, 1993) and cyclopoid copepod (*O. similis*) from the Scotian Shelf (Sakshaug, 1997 in Bundy *et al.*, 2000). The original value of 20.5 year<sup>-1</sup> was arbitrarily decreased to 18.0 year<sup>-1</sup> in order to lower P/Q below 0.3. Diet of 'small zooplankton' is assumed to be 100% 'primary producers'.

### Benthic infauna (group 32)

This group includes small benthic crustaceans such as *Gammarus*, amphipods, nematods and other meiofauna. The biomass was unknown and left to be estimated. P/B (= 2.5 year<sup>-1</sup>) and Q/B (= 12.5 year<sup>-1</sup>) were taken from Jarre-Teichmann and Guénette (1996). The biomass estimated by the model, 20 t·km<sup>-2</sup>, is slightly higher than the biomass estimated by sampling obtained for the southern shelf of eastern Canada (region 3LNO) of 11.8 t·km<sup>-2</sup> (Bundy *et al.* 2000). Members of this groups were assumed to feed on detritus.

### Birds (group 33)

This functional group includes Cory's shearwater (*Calonectris diomedea borealis*), great shearwater (*Puffinus gravis*), Wilson's Petrel (*Oceanites oceanicus*), yellow-legged gull (*Larus cachinnans atlantis*), herring gull (*Larus argentatus*), British storm petrel (*Hydrobates pelagicus*), great cormorant (*Phalacrocorax carbo*), double crested cormorant (*Phalacrocorax auritus*) and Mediterranean shearwater (*Puffinus mauritanicus*). Also included in the diet matrix is brant goose (*Branta bernicla*). These are migrant and resident shorebirds.

Biomass density was calculated for Cory's shearwater, great shearwater, brant goose, little egrets, herring gull, British storm petrel and great cormorant. Their estimated population size was multiplied by their average weight (Monteiro *et al.*, 1996; Wada, 1996; Anon., 1999b; Montevecchi, 2000) to produce an overall biomass which was divided by the area of ICES Areas VIIIa,b to obtain the relative biomass. Body mass of brant goose was assumed to be equal to yellow-legged gull (both animals are 57 cm average length). Biomass density was reduced proportionally to the number of days out of the year that these (migratory) birds spend in the Bay of Biscay. There are six birds for which biomass was not known. The biomass of each of the unknown birds was assumed to be equal to the average biomass of the four known species, and then scaled down to reflect the number of days spent in the area. Three species, yellow-legged gull, great cormorant and double crested cormorant, were assumed to remain in the area all year round. The resulting biomass amounted to 0.0034 t·km<sup>-2</sup>.

Birds are not harvested in the Bay of Biscay and we have no information on the amount of by-catch. Daily ration (R) in g·day<sup>-1</sup> was calculated according to the empirical equation:

$$\log R = 0.293 + 0.85 * \log W \quad \dots 2)$$

where weight (W) is in grams (Nilsson and Nilsson, 1976, in Wada, 1996). This value was divided by the average weight of the species to provide a daily ration that was then multiplied by 365 to provide annual consumption per biomass (Q/B). Our value, 79.2 year<sup>-1</sup> (Table 23), is close to Wada's value for the Strait of Georgia (91.77). Most marine birds are long-lived and their natural mortality varies between 3-12% (Nelson, 1979). P/B for the group (=0.09 year<sup>-1</sup>) was based on estimates published in Nelson (1979).

Diet information was based on Cory's shearwater (Monteiro *et al.*, 1996), great shearwater (Prince and Morgan, 1987), herring gull (Anon., 1999b), British storm petrel (Prince and Morgan, 1987; D'Elbée and Hemery, 1998), Wilson's petrel (Prince and Morgan, 1987) and brant goose (Merrifield, 2000). Great cormorant and double crested cormorant diet information is from the Gulf of St. Lawrence (Gremillet *et al.*, 1999). Their single most important prey group was cephalopods, constituting 13.4% of the diet of seabirds. 46.2% of their diet is small fish including pelagic, demersal and deep water species. This number was divided among 7 groups in the initial model. Other important prey are 'large zooplankton' (mostly euphausiids) at 11.0% and 'primary producers' at 10.8% (exclusively brant geese). Of less importance in their diet are larger fish, crabs, and other zoobenthos.

**Table 23.** Initial basic parameter summary for 'Birds' species.

Species	Q/B (year <sup>-1</sup> )	P/B (year <sup>-1</sup> )	Biomass <sup>a</sup> (t·km <sup>-2</sup> )
<i>Calonectris diomedea borealis</i>	67.718	-	5.05 * 10 <sup>-4</sup>
<i>Puffinus gravis</i> <sup>b</sup>	67.125	-	1.54 * 10 <sup>-4</sup>
<i>Oceanites oceanicus</i> <sup>b</sup>	106.902	-	1.80 * 10 <sup>-4</sup>
<i>Branta bernicla hrota</i> <sup>b</sup>	-	-	1.82 * 10 <sup>-4</sup>
<i>Larus ridibundus</i> <sup>b</sup>	79.840	-	7.29 * 10 <sup>-4</sup>
<i>Larus cachinnans atlantis</i> <sup>b</sup>	67.148	-	7.29 * 10 <sup>-4</sup>
<i>Larus argentatus</i>	64.850	0.065	1.28 * 10 <sup>-4</sup>
<i>Hydrobates pelagicus</i>	111.616	-	2.17 * 10 <sup>-7</sup>
<i>Phalacrocorax carbo</i> <sup>b</sup>	60.395	0.1	3.35 * 10 <sup>-5</sup>
<i>Phalacrocorax auritus</i>	87.070	0.1	7.29 * 10 <sup>-3</sup>
Group value	79.185	0.09	0.0034

<sup>a</sup>Corrected for days per year spent in the area;

<sup>b</sup>Assumed to be equal to the average abundance of the 'known' species, divided by 6 and corrected (see text).

### Toothed cetaceans (group 34)

These are migratory and resident carnivorous whales, dolphins and porpoises that consume cephalopods and fish (mostly pelagic, fewer demersals). This group consists of Cuvier's beaked whale (*Ziphius cavirostris*), northern bottlenose whale (*Hyperoodon ampulatus*), Sowerby's beaked whale (*Mesoplodon bidens*), sperm whale (*Physeter macrocephalus*), harbour porpoise (*Phocoena phocoena*), common dolphin (*Delphinus delphis*), striped dolphin (*Stenella coeruleoalba*), Risso's dolphin (*Grampus griseus*), white-beaked dolphin (*Lagenorhynchus albirostris*), Atlantic white-sided dolphin (*Lagenorhynchus acutus*), bottlenose dolphin (*Tursiops truncatus*), false killer whale (*Pseudorca crassidens*), long-finned pilot whale (*Globicephala melas*), short-finned pilot whale (*Globicephala macrorhynchus*), killer whale (*Orcinus orca*), Gervais beaked whale (*Mesoplodon europaeus*), True's beaked whale (*Mesoplodon mirus*), pygmy sperm whale (*Kogia breviceps*) and dwarf sperm whale (*Kogia simus*). All variables except biomass were available for both males and females.

Several of these species are known to be present in the area all year round (harbour porpoise, common dolphin, striped dolphin bottlenose dolphin and long-finned pilot whale). Others are thought to be present all year round, although no sighting has confirmed this (Cuvier's beaked whale, northern bottlenose whale, Sowerby's beaked whale, Risso's dolphin, killer whale) (Tom Brereton, Biscay Dolphin Research Program, pers. comm.). The rest are migrants which arrive in late winter to early spring and depart late summer to early fall.

Cetacean population estimates were obtained from the database built within the *Sea Around Us* project (Kaschner *et al.* 2001). Population estimates were converted from biomass by multiplying each by the mass of the animal (mean of male and female body weight) (Trites and Pauly, 1998). Each biomass is then corrected for the time spent in the area by reducing it proportionately to the number of days the animals of a given species are known to be in the Bay of Biscay. The resulting total biomass for 'toothed cetaceans' was 0.318 t·km<sup>-2</sup>. These animals are not hunted in the Bay of Biscay so their production rate equals natural mortality, 0.02 year<sup>-1</sup>, i.e., one half of the cetacean production rate (Reilly and Barlow, 1986 in Trites and Heise, 1996). The average for Q/B was estimated at 11.693 year<sup>-1</sup> (Table 24).

Diet information for all 'toothed cetaceans' is from qualitative sources (Anon., 1998c) except for sperm whale (Martin and Clarke, 1986). They feed most heavily on pelagic fish (38%), cephalopods (25%), deep fish (20%) and demersal fish (11%).

**Table 24.** Initial basic parameter summary for 'Toothed cetaceans' species.

Species	Q/B <sup>a</sup> (year <sup>-1</sup> )	Biomass <sup>b</sup> (t·km <sup>-2</sup> )
<i>Ziphius cavirostris</i>	9.525	0.00016
<i>Hyperoodon ampulatus</i>	8.257	0.00481
<i>Mesoplodon bidens</i>	10.733	7.15 * 10 <sup>-5</sup>
<i>Physeter macrocephalus</i>	5.259	0.0639
<i>Phocoena phocaena</i>	18.366	0.1555
<i>Delphinus delphis</i>	15.229	0.00132
<i>Stenella coeruleoalba</i>	14.106	0.00676
<i>Grampus griseus</i>	12.375	0.0006
<i>Lagenorhynchus albirostris</i>	13.559	0.00023
<i>Lagenorhynchus acutus</i>	14.831	6.64 * 10 <sup>-6</sup>
<i>Tursiops truncatus</i>	12.825	0.0058
<i>Pseudorca crassidens</i>	10.280	0.00054
<i>Globicephala melas</i>	9.522	0.078
<i>Globicephala macrorhynchus</i>	10.109	8.88 * 10 <sup>-5</sup>
<i>Orcinus orca</i>	7.792	0.00026
<i>Mesoplodon europaeus</i>	11.150	0.0001
<i>Mesoplodon mirus</i>	10.789	0.00045
<i>Kogia breviceps</i>	12.963	3.11 * 10 <sup>-5</sup>
<i>Kogia simus</i>	14.502	3.18 * 10 <sup>-5</sup>
Group value	11.693	0.201

<sup>a</sup>Q/B values averaged for male and female;

<sup>b</sup>Corrected for days per year spent in the area.

### Baleen whales (group 35)

The baleen whales are resident and migratory filter feeding planktivores. Species include minke whale (*Balaenoptera acutorostrata*), humpback whale (*Megaptera novaengliae*), sei whale (*Balaenoptera borealis*), fin whale (*Balaenoptera physalus*) and blue whale (*Balaenoptera musculus*). Migrants proceed north to Biscay or beyond in the spring and make the return trip to the south beyond Spain in the late summer. Sei whales arrive later (late summer) and stay for as long as six months, until late winter. Minke whales are important to the Biscay ecosystem: theirs is the second largest biomass in the Bay of Biscay (~2100 t), next to fin whales (~2800 t), but their population in the area consumes 1.17 times as much as fin whales.

The minke whale and the fin whale are residents in the Bay of Biscay. The humpback and blue whale migrate north to Norway and above in summer and south to Spain in winter. They spend about 2 and 3 months in the Bay of Biscay,

respectively (return trip included). The sei whale winters south of Spain and travels as far north as Ireland in the summer. They typically spend about six months in the Bay of Biscay.

Baleen whales population estimates were obtained from the database built within the *Sea Around Us* project (Kaschner *et al.* 2001). Population estimates were converted from biomass by multiplying each by the mass of the animal (mean of male and female body weight) (Trites and Pauly, 1998). Each biomass is then corrected for the time they spend in the area by reducing it proportionately to the number of days the animal is known to be in the Bay of Biscay. The resulting total biomass for 'baleen whales' was 0.426 t·km<sup>-2</sup> (Table 25).

The daily consumption per animal (R) was calculated using the formula

$$R=0.1*W^{0.8} \quad \dots 3)$$

where W is mean body weight in kg, and R in kg·day<sup>-1</sup> (Innes *et al.* 1987; in Trites and Heise, 1996). The daily rate was multiplied by the number of days per year in the area to provide annual consumption estimates. The Q/B value was estimated at 4.777 year<sup>-1</sup>. Production rates for the 'baleen whales' are from Perry *et al.* (1999)

except for fin whale, which is from Aguilar and Lockyer (1987). P/B ranges from 0.075 year<sup>-1</sup> (sei whale) to 0.04 year<sup>-1</sup> (blue whale), with an average of 0.05 year<sup>-1</sup>.

Baleen whales only feed for four or five months during the year in the northern temperate and polar seas. They rely primarily on large zooplankton like euphausiids and pelagic crustaceans, but the minke, humpback and fin whales also consume cephalopods and small fish, primarily herring, mackerel and sandlance (Lindstrøm *et al.*, 1998; Perry *et al.*, 1999). Overall, the group diet in the initial matrix consists of 46% large zooplankton, 24% pelagic fish, 16% small zooplankton, 9% demersal fish, and 5% cephalopods.

### Primary producers (group 36)

Primary producers include phytoplankton and benthic macrophytes. Plankton primary productivity (240gC·m<sup>-2</sup>·year<sup>-1</sup>) was taken from Longhurst *et al.* (1995). Using a ratio carbon to wet weight of 1:14 (Pauly and Christensen, 1995), the productivity was estimated at 3360 gWW·m<sup>-2</sup>·year<sup>-1</sup>. Assuming an approximate turnover of about 3 days, the P/B was set at 100 year<sup>-1</sup> and biomass at 33.6 t·km<sup>-2</sup>. No estimate of benthic primary producers was available.

**Table 25.** Initial basic parameter summary for 'Baleen whales' species.

Species	Q/B <sup>a</sup> (year <sup>-1</sup> )	P/B (year <sup>-1</sup> )	Biomass <sup>b</sup> (t·km <sup>-2</sup> )
<i>Balaenoptera acutorostrata</i>	6.296	-	0.192
<i>Megaptera novaengliae</i>	4.634	0.049 <sup>c</sup>	0.015
<i>Balaenoptera borealis</i>	5.215	0.075 <sup>d</sup>	0.0007
<i>Balaenoptera physalus</i>	4.108	0.050 <sup>e</sup>	0.218
<i>Balaenoptera musculus</i>	3.633	0.040 <sup>d</sup>	0.0001
Group value	4.777	0.05	0.426

<sup>a</sup>Q/B values averaged for male and female;

<sup>b</sup>Corrected for days spent in the area (T. Breton, pers. comm.);

<sup>c</sup>From International Whaling commission;

<sup>d</sup>(Allen, 1980 in Perry *et al.*, 1999);

<sup>e</sup>(Clark, 1982 and De la Mare, 1985 in Aguilar and Lockyer, 1987).

### LANDINGS AND DISCARDS

Landings per fleet type were divided up based on information from the literature and correspondence with Dr. Guy Fontenelle, Ecole Nationale Supérieure Agronomique, Rennes, France. A breakdown is provided in Table 26. Discards were adapted from Morizur *et al.* (1996).

'Groundfish' applies to all demersal functional groups, 'large pelagics' applies to the 'large' and 'medium' pelagic groups, 'small pelagics' applies

to 'small' and 'very small' pelagic groups, the rest are self-explanatory. For the immediate need of the model, the Ecopath functional groups 'echinoderms' and 'primary producers' were assumed to be caught entirely by coastal trawl.

**Table 26.** Proportion of landings of important ecotrophic groups, by fishing fleet in (%).

	Large mesh gill nets	Small mesh gill nets	Coastal trawl	Offshore trawl (Manche)	Offshore trawl (Bristol/Small channels)
Groundfish	3.8	3.8	30.7	30.7	30.7
Large Pelagics	2.2	2.2	31.9	31.9	31.9
Small Pelagics	3.6	3.6	30.9	30.9	30.9
Sharks, rays, skates	1.3	1.3	32.5	32.5	32.5
Bivalves	0	0	33.3	33.3	33.3
Shrimps/prawns	1.3	1.3	32.5	32.5	32.5
Crabs	0	0	33.3	33.3	33.3

### BALANCING THE INITIAL MODEL

Biomass data were lacking in the initial model, so we tried to run the program by assigning EEs and having the model estimate the biomasses. We found that the program required more biomass information than initially provided in order to estimate some parameters and so we used some guesstimates based very roughly on other models. It was necessary to reduce the predation on large fish groups by groups of fish of similar or higher P/Bs. Several revisions were made, as improved biomass data became available. Still, benthic invertebrates are poorly known, and remain a source of uncertainty in the model. The final diet composition and basic parameters are presented in Table 27 and 28.

### EVALUATION BY FRENCH EXPERTS

Herring and capelin were dropped entirely from the model. Although herring is known to occur in the northern Bay of Biscay, it is the southern end of their distribution. Presumably, they contribute very little to the system. Sardines (European pilchard - *Sardina pilchardus*) were suggested to be major players in the system and so they were removed from 'small pelagic low TL' and given their own group. Where forage fish 'herring' or 'capelin' appeared in the diets of higher predators (i.e., where diet information was from other systems), 'anchovy' and 'sardine' were substituted directly and in equal proportion, those being the equivalent forage fish of the Biscay region. Poor cod (*Trisopterus minutus*) was removed from 'medium (big end) demersals' and put in 'medium pelagic' because it is ecotrophically similar to *T. luscus* and *T. esmarkii* (F. Blanchard, IFREMER pers. comm.). Greater argentine (*Argentina silus*) was added to 'medium deepwater', black seabream (*Spondyllosoma cantharus*) was added to 'large pelagic' and black-bellied angler (*Lophius budegassa*) was added to 'Large deepwater'.

### MODEL OF THE YEAR 1970

Having completed our model for 1998, we then adjusted biomasses to represent the Bay of Biscay as it may have looked in 1970. Time-series biomass data were collected for most major commercial stocks in the Bay of Biscay. This information would later be used to validate or refute the outcome of the time simulation, using 1970 values as a starting point. The biomasses for the 1970s were generally taken from ICES reports, in some cases their data did not extend as far back as 1970. In these instances, the biomass estimates of the earliest five years available were averaged and that value was taken as representative of the 1970 condition.

Most functional groups have one or two commercial fish, and many more animals that are non-commercial. Since biomass data were available only for commercial fish, those values were assumed to represent a certain fraction of the group's total biomass, based on how many other (non-commercial) animals were in the group. That same fraction was applied to the 1970 biomass estimates of those commercial animals. In this way, the populations of all non-commercial fish were assumed to increase or decrease in the same proportion as the commercial fish.

Since no biomass estimates are available, there is no way to determine what has actually happened in these non-commercial stocks. However, our assumption may be valid for several reasons. Commercial animals are often the most abundant, so in a large part their trend represents the group trend as well. As well, fish of similar habitats (i.e., fellow group members) are presumably similarly sensitive to fishing pressure through unreported bycatch and discards. For instance, a fishery for a particular commercial species will also impact other ecologically similar species by virtue of the similarities in size, habitat preference and vulnerability to gear type.

**Table 27 a.** Final Diet composition for the Bay of Biscay model.

Prey \ Predator	1	2	3	4	5	6	7	8	9	10	11	12	13	14	15	16	17	18
1 Large Deepwater	0.001																	
2 Medium Deepwater	0.117												0.005					
3 Small Deepwater	0.196	0.251		0.04	0.074	0.085	0.266	0.034			0.215		0.232	0.039	0.056			0.076
4 Very Large Pelagic																		
5 Large Pelagic	0.034			0.038	0.004						0.005							
6 Medium Pelagic	0.012			0.046	0.004	0.005					0.015		0.013					
7 Anchovy	0.002			0.005	0.005	0.02	0.008	0.004			0.01			0.003				0.001
8 Small Pelagic High TL	0.059			0.05	0.038	0.065		0.005			0.03							0.005
9 Small Pelagic Low TL	0.02			0.045	0.02	0.009	0.013	0.01			0.012							0.005
10 Sardine	0.008			0.03	0.002	0.003	0.002	0.001			0.009		0.009	0.001				
11 Very Large Demersal High TL	0.003										0.005		0.008	0.001				
12 Very Large Demersal Low TL	0.005										0.021							
13 Large Demersal	0										0.002	0.006		0.001				
14 Medium (Big end) Demersal	0.002			0.02	0.019	0.004					0.051	0.021	0.049	0.006				
15 Medium (Small end) Demersal				0.026	0.021						0.02	0.021	0.06	0.057	0.001			
16 Small Demersal					0.032						0.009	0.021	0.014	0.03	0.008			
17 Very Small Demersal High TL	0.043				0.034						0.008	0.021	0.06			0.045	0.025	
18 Very Small Demersal Low TL	0.003				0.048						0.097	0.033	0.146			0.045	0.038	
19 Rays/Skates				0.004							0.004	0.004			0.001			
20 Small Sharks	0.005			0.002							0.005	0.005			0.001			
21 Large Sharks																		
22 Tuna-like fish																		
23 Crabs	0.119		0.001	0.012	0.09	0.039		0.023			0.13	0.086	0.104	0.011	0.005	0.024	0.029	
24 Shrimps/Prawns	0.118	0.104	0.018	0.25	0.13	0.192					0.07		0.112	0.106	0.118	0.071	0.055	
25 Worms	0	0.069	0.06		0.035	0.078					0.039	0.487	0.075	0.203	0.336	0.139	0.235	
26 Molluscs		0.104	0.038	0	0.028	0.003					0.005		0.017	0.041	0.007	0.062	0.062	
27 Cephalopods	0.181	0.078		0.432	0.071	0.106					0.012			0.003	0.003			
28 Echinoderms	0.001		0.038	0		0.038					0.026	0.189	0.026	0.005	0.04	0.056	0.062	
29 Sponges/Epibenthic	0.011	0.243	0.024	0	0.088	0.059					0.03			0.188	0.17	0.191	0.35	
30 Zooplankton Large	0.012	0.075	0.021		0.044	0.084		0.131					0.005	0.037	0.077	0.085		
31 Zooplankton Small		0.075	0.06		0.05	0.075	0.711	0.789	0.75	1	0.044	0.1	0.01	0.042		0.185		0.4
32 Benthic Infauna	0.003	0.002	0.113		0.081	0.067		0.004			0.088	0.006	0.047	0.053	0.167	0.097	0.058	
33 Birds																		
34 Toothed Cetaceans																		
35 Baleen Whales																		
36 Primary Producers			0.175					0.25					0.005	0.041		0		0.6
37 Detritus	0.044		0.453		0.082	0.065					0.036		0.002	0.132	0.012			
38 Import																		
- Sum	1	1	1	1	1	1	1	1	1	1	1	1	1	1	1	1	1	1





**Table 28.** Basic parameters of the balanced 1998 model. Values **in bold** were estimated by Ecopath.

Group name	Trophic level	Biomass (t·km <sup>-2</sup> )	P/B (year <sup>-1</sup> )	Q/B (year <sup>-1</sup> )	EE (-)	P/Q (-)
1 Large Deepwater	3.9	0.35	0.33	2.5	<b>0.97</b>	<b>0.082</b>
2 Medium Deepwater	3.4	<b>0.921</b>	0.502	6.513	0.95	<b>0.077</b>
3 Small Deepwater	2.5	<b>5.732</b>	1.537	12.646	0.95	<b>0.122</b>
4 Very Large Pelagic	4.1	<b>0.287</b> <b>0.075</b>	0.195	2.492	0.95	<b>0.078</b>
5 Large Pelagic	3.5	0.645	0.53	5.033	<b>0.99</b>	<b>0.105</b>
6 Medium Pelagic	3.5	<b>0.622</b> <b>0.396</b>	0.609	6.503	0.95	<b>0.094</b>
7 Anchovy	3.2	0.59	1.15	8.684	<b>0.98</b>	<b>0.132</b>
8 Small Pelagic High TL	3.1	<b>0.85</b> <b>0.501</b>	1.524	10.15	0.95	<b>0.15</b>
9 Small Pelagic Low TL	2.8	<b>1.057</b> <b>0.591</b>	0.949	10.994	0.95	<b>0.086</b>
10 Sardine	3.0	0.321	1.1	8.965	<b>0.97</b>	<b>0.123</b>
11 Very Large Demersal High TL	3.6	0.34	0.499	3.779	<b>0.93</b>	<b>0.132</b>
12 Very Large Demersal Low TL	3.4	<b>0.347</b>	0.254	3.147	0.95	<b>0.081</b>
13 Large Demersal	3.6	0.28	0.703	4.917	<b>0.63</b>	<b>0.143</b>
14 Medium (Big end) Demersal	3.2	<b>0.742</b> <b>0.577</b>	0.885	6.08	0.95	<b>0.146</b>
15 Medium (Small end) Demersal	3.4	<b>0.733</b> <b>0.555</b>	<b>1.239</b>	8.257	0.95	0.15
16 Small Demersal	3.3	<b>1.035</b> <b>0.756</b>	1.2	8.626	0.95	<b>0.139</b>
17 Very Small Demersal High TL	3.4	<b>1.0407</b> <b>1.132</b>	1.344	11.24	0.95	<b>0.12</b>
18 Very Small Demersal Low TL	2.4	<b>1.601</b> <b>1.269</b>	1.886	11.301	0.95	<b>0.167</b>
19 Rays/Skates	3.5	0.487	0.315	3.612	<b>0.75</b>	<b>0.087</b>
20 Small Sharks	3.9	0.5	0.264	4.305	<b>0.96</b>	<b>0.061</b>
21 Large Sharks	4.1	0.506	0.175	2.379	<b>0.79</b>	<b>0.074</b>
22 Tuna-like fish	4.1	0.07	0.529	2.599	<b>0.99</b>	<b>0.204</b>
23 Crabs	2.6	<b>1.538</b> <b>1.336</b>	2.212	10	0.95	<b>0.221</b>
24 Shrimps/Prawns	2.3	6.1	1.6	9.667	<b>0.99</b>	<b>0.166</b>
25 Worms	2.1	<b>13.285</b> <b>11.066</b>	2.28	22.2	0.95	<b>0.103</b>
26 Molluscs	2.1	<b>35.599</b> <b>31.43</b>	0.6	6.3	0.95	<b>0.095</b>
27 Cephalopods	3.5	<b>2.310</b> <b>1.823</b>	2.5	8	0.95	<b>0.313</b>
28 Echinoderms	2.6	22	0.649	4.703	<b>0.86</b>	<b>0.138</b>
29 Sponges/Epibenthic	2.3	<b>20.994</b> <b>19.011</b>	2.7	9	0.95	<b>0.3</b>
30 Zooplankton Large	2.1	18.343	5	28.417	<b>0.34</b>	<b>0.176</b>
31 Zooplankton Small	2.0	32	18	60	<b>0.175</b>	<b>0.3</b>
32 Benthic Infauna	3.0	<b>20.991</b>	2.5	12.5	0.95	<b>0.2</b>
33 Birds	3.8	0.0034	0.09	79.185	<b>0.40</b>	<b>0.001</b>
34 Toothed Cetaceans	4.1	0.318	0.02	11.693	<b>0.13</b>	<b>0.002</b>
35 Baleen Whales	3.4	0.426	0.05	4.777	<b>0.06</b>	<b>0.01</b>
36 Primary Producers	1.0	33.6	100	-	<b>0.75</b>	-
37 Detritus	1.0	50	-	-	<b>0.35</b>	-

However, this assumption may introduce a degree of error if those few commercial fish for which we have time series information have changed much more or less so than the fish for which we do not. This was likely the chief source of error, causing a few unrealistic fishing mortality estimates in groups whose biomass was less in 1970, and whose catch was larger.

Groups prone to this error were generally much larger in total biomass than the one or two representative species whose 1970 biomass was known. For example, the representative species may have comprised as little as 5.7% of the total group biomass (as in 'very large demersal high TL'), so fluctuations in the representative species may not reflect the change in the group as a whole. With this in mind, 1970 landings of 'large deepwater', 'very large demersal high TL' and 'medium pelagic' were arbitrarily reduced so that the fishing mortality of these groups was the same as in the 1998 model.

No P/B or Q/B values were changed in the 1970 model from the original 1998 condition. The assumption that the production and consumption rates of these groups were the same 30 years ago is most likely valid, since the Bay of Biscay was already under intense fishing pressure at that time and so the average size of the fish was probably not too different from that of today.

The methodology explained thus far was used to generate 1970 biomass estimates for most groups. What follows is a more detailed account of the groups for which we had reliable estimates of 1970 biomass and fishing pressure.

#### *Large Deepwater*

The 1970 biomass estimate for large deepwater fish was based on anglerfish (*Lophius piscatorius*) and black-bellied anglerfish (*L. budegassa*). Available ICES biomass data only extended as far back as 1986 for either of these species and referred to areas VII and VIIIa/b combined. We used the same fishing mortality as in 1998 ( $F=0.259 \text{ year}^{-1}$ ) and used the ratio catch/ $F$  to obtain the biomass value of 0.64 t·km<sup>2</sup>.

#### *Medium Deepwater*

The sole commercial representative of the Medium Deepwater group is megrim; it is the only fish for which time series biomass was available. As a first approximation, its 1970 biomass was assumed equal to the average of the first five years of available data (1986-1990) and megrim is assumed to equal 1/2 of the entire group

biomass. The resulting biomass was assumed to be equal to 1.328 t·km<sup>2</sup>. The biomass trend for this group from 1970 to 1998 used in the temporal series file (presented below) is assumed to be the same as that of megrim. The biomass was increased to 1.5 t·km<sup>2</sup> to balance the model (Christensen *et al.*, 2000).

#### *Large Pelagic*

The 1970 biomass of large pelagics is based on its only commercial representative, whiting, which was assumed to compose 25% of this group by weight. ICES reports that the biomass of whiting was 1.87 times greater in 1978 than in 1997. That ratio was therefore applied to the estimate used in the 1998 model for the entire group to produce a 1970 value (2.003 t·km<sup>2</sup>). The biomass trend taken for the CSV file represents the trend of whiting as seen in area VIa, scaled to the overall biomass of this group.

#### *Medium Pelagics*

In order to calculate the 1970 biomass of medium pelagics in the Bay of Biscay, the trend in mackerel abundance since 1970 was assumed representative of the entire group, which in turn followed the same trend as the trend of the entire western mackerel stock. Since ICES reports that the western mackerel stock was about 1.45 times greater in 1972 than in 1996, the present day estimate of 0.396 t·km<sup>2</sup> was multiplied by the same factor to yield our 1970 estimate, which is 0.574 t·km<sup>2</sup>.

To calculate the historic trend of fishing pressure for medium pelagics for use in the CSV file for Ecosim simulation, we used time series catch data from area VIIIa/b, and assumed that the biomass trend of the group was the same as that of the western mackerel stock. Those annual biomass estimates were then combined with ICES catch record data to determine the trend in fishing pressure.

#### *Anchovies*

Anchovies time series biomass data were not available prior to 1983. The annual average of the first five available years (33,008 t) was not sufficient to explain the high catches listed in the ICES records (i.e.,  $F$  exceeded 1-year<sup>-1</sup>). Instead, we assumed that the 1970 biomass was equal to the 1983 level (50,000 t), which was higher than the four subsequent years. That value was divided by the area of ICES VIIIa/b to yield 0.518 t·km<sup>2</sup>. The time series biomass trend used in Ecosim's CSV file was taken from available ICES reports.

The data represents the trend in abundance of anchovy as seen in area VIII. The Bay of Biscay, i.e., area VIIIa/b geographically represents about 14% of ICES area VIII, so the biomass estimates were scaled down by a factor of 0.14. Those annual biomass estimates were then combined with ICES catch record data to determine the trend in fishing pressure.

#### *Sardines*

Sardines had reliable time series biomass data extending back to 1977 but the data referred to statistical areas VIIIc and IXa. That 1977 value was reduced by 50% to approximate the area of the Bay of Biscay, which yielded a biomass of 0.663 t·km<sup>2</sup>.

#### *Very Large Demersal High TL*

The very large demersal high TL functional group is represented by hake and cod. When combining the ICES time series estimates for these two species, we find that the 1970 biomass was approximately 1.2 times larger than in 1998. The biomass estimate of the present day model was therefore increased by that amount to yield 0.408 t·km<sup>2</sup>.

The historic trend in abundance, as provided by ICES records, applied to the entire northern stock for hake. The northern stock occupies statistical areas VIIIa/b, 7, 6, and part of 4. That value was reduced by 50% to represent VIIIa/b alone. Records for cod referred to area VIIa, which we took as equivalent to VIIIa/b.

#### *Very Large Demersal Low TL*

The very large demersal low TL group was represented by plaice. ICES records suggest that plaice was 1.45 times more plentiful in 1976 than in 1998. The present day estimate of biomass for the entire functional group was therefore increased by that factor to provide a 1970 estimate. The resulting value is 0.387 t·km<sup>2</sup>. The time series biomass trend of this group for use in the CSV file was assumed to follow the same trend as plaice. Available data referred to area VIIe, which was assumed equivalent to the Bay of Biscay.

#### *Large Demersal*

Common sole represented this group. The records suggest that sole's 1970 biomass was about 93% of today. Since the 1970 value is so similar, and since sole is only one of ten species in this group, we used the same value as in the 1998 model to

represent the 1970 value, that is 0.280 t·km<sup>2</sup>. The time series trend for use in our CSV file refers to area VIIe, which we took to be equivalent to the Bay of Biscay.

#### *Other groups*

Shrimps, worms, molluscs, cephalopods, echinoderms, zooplankton, sponges, benthic infauna and primary producers were absent from the series biomass data. 1970 biomass for these groups was assumed to equal the 1998 biomass. However, the biomass of shrimps and cephalopods had to be increased slightly to balance the model (Table 29). The diet was slightly adjusted to balance the model. The larger change was the virtual removal of predation on birds by large sharks from 0.2% to 0.05%.

### **PREPARING ECOSIM**

A comma-delimited DOS text file (.CSV) was created in Microsoft Excel for use in the time simulation. Time series fishing mortality (F) was calculated for 1970 to 1998 for each functional group, based on the commercial fish for which time series biomass (and catch) was available. Change in biomass over time was assumed for all groups to follow the pattern of the representative species. Again, the representative species were assumed to compose an unchanging fraction of the group's total biomass.

### **DISCUSSION**

The present model constitutes a first attempt to construct a trophic ecosystem model the Bay of Biscay. It is based on the literature that was available to us at the time and the kind review of French colleagues. This version of the model could be improved upon in two major ways. First the validity of the model 1998 could be tested by using the 1970 model and the time series and try to make the 1970 model gradually transform into the 1998 model. The catch series suggest a systematic depletion during that period. The problems and uncertainties identified, the second step would be to hold a workshop with the scientists of the region for a discussion of the problems and possible improvements.

We already identified several aspects of the model that would need improvements; for example, bycatch had not been considered. For the time being, crude bycatch values have been only estimated for the 1990s (Melnichuk *et al.*, 2001).

**Table 29.** Basic parameters of the balanced 1970 model. Values **in bold** were estimated by Ecopath.

Group name	Trophic level	Biomass (t·km <sup>2</sup> )	P/B	Q/B	EE	P/Q
1 Large Deepwater	3.9	0.64	0.33	2.5	<b>0.86</b>	<b>0.132</b>
2 Medium Deepwater	3.3	1.5	0.502	6.513	<b>0.78</b>	<b>0.077</b>
3 Small Deepwater	2.5	<b>4.803</b>	1.537	12.646	0.95	<b>0.122</b>
4 Very Large Pelagic	4.0	<b>0.110</b>	0.195	2.492	0.95	<b>0.078</b>
5 Large Pelagic	3.5	2.003	0.530	5.033	<b>0.67</b>	<b>0.105</b>
6 Medium Pelagic	3.4	0.574	0.609	6.503	<b>0.90</b>	<b>0.094</b>
7 Anchovy	3.1	0.518	1.150	8.684	<b>0.819</b>	<b>0.132</b>
8 Small Pelagic High TL	3.1	<b>1.177</b>	1.524	10.15	0.95	<b>0.15</b>
9 Small Pelagic Low TL	2.8	<b>1.121</b>	0.949	10.994	0.95	<b>0.086</b>
10 Sardine	3.0	0.663	1.100	8.965	<b>0.82</b>	<b>0.123</b>
11 Very Large Demersal High TL	3.7	0.408	0.499	3.779	<b>0.80</b>	<b>0.132</b>
12 Very Large Demersal Low TL	3.3	0.387	0.254	3.147	<b>0.57</b>	<b>0.081</b>
13 Large Demersal	3.6	0.28	0.703	4.756	<b>0.50</b>	<b>0.148</b>
14 Medium (Big end) Demersal High TL	3.1	<b>0.520</b>	0.885	6.08	0.95	<b>0.146</b>
15 Medium (Small end) Demersal	3.4	<b>0.593</b>	<b>1.239</b>	8.257	0.95	0.15
16 Small Demersal	3.3	<b>0.656</b>	1.200	8.618	0.95	<b>0.139</b>
17 Very Small Demersal High TL	3.3	<b>1.082</b>	1.344	11.24	0.95	<b>0.12</b>
18 Very Small Demersal Low TL	2.4	<b>1.186</b>	1.886	11.301	0.95	<b>0.167</b>
19 Rays/Skates	3.5	<b>0.336</b>	0.315	3.612	0.95	<b>0.087</b>
20 Small Sharks	3.9	<b>0.522</b>	0.264	4.305	0.95	<b>0.061</b>
21 Large Sharks	4.0	<b>0.337</b>	0.175	2.379	0.95	<b>0.074</b>
22 Tuna-like fish	4.0	<b>0.099</b>	0.529	2.599	0.95	<b>0.204</b>
23 Crabs	2.6	1.336	2.212	5.283	<b>0.97</b>	<b>0.419</b>
24 Shrimps/Prawns	2.3	6.5	1.45	9.667	<b>0.78</b>	<b>0.15</b>
25 Worms	2.1	11.066	2.28	22.2	<b>0.91</b>	<b>0.103</b>
26 Molluscs	2.1	31.43	0.6	6.3	<b>0.88</b>	<b>0.095</b>
27 Cephalopods	3.4	2.1	2.5	8	<b>0.95</b>	<b>0.313</b>
28 Echinoderms	2.6	22	0.649	4.703	<b>0.79</b>	<b>0.138</b>
29 Sponges/Epibenthic	2.3	19.011	2.7	9	<b>0.96</b>	<b>0.3</b>
30 Zooplankton Large	2.1	18.343	5	28.417	<b>0.37</b>	<b>0.176</b>
31 Zooplankton Small	2.0	32.000	18	60	<b>0.17</b>	<b>0.3</b>
32 Benthic Infauna	3.0	<b>22.560</b>	2.5	12.5	0.95	<b>0.2</b>
33 Birds	3.8	0.003	0.09	79.185	<b>0.03</b>	<b>0.001</b>
34 Toothed Cetaceans	4.1	0.103	0.02	11.693	<b>0.39</b>	<b>0.002</b>
35 Baleen Whales	3.4	0.210	0.05	4.777	<b>0.08</b>	<b>0.01</b>
36 Primary Producers	1.0	33.6	100	-	<b>0.74</b>	-
37 Detritus	1.0	50	-	-	<b>0.33</b>	-

Estimates for the 1970s would be needed to determine the trend. The catch has been attributed to the different fleets on qualitative information. The next model should include the estimation from Melnychuk *et al.* (2001). Fisheries management scenarios would be more consistent with reality if their relative importance were better known.

Several groups of large fish predators (e.g., the large sharks) were characterized by general informations and would benefit from more local knowledge, as might be retrieved from the grey literature. Although small benthic invertebrates are not well known and their parameter values have larger confidence intervals, they do not seem to be very influential in the model.

#### ACKNOWLEDGEMENTS

We would like to thank the Pew Charitable Trusts, Philadelphia, USA, for funding the *Sea Around Us* project at the University of British Columbia, Canada. Special thanks to Tom Brereton, Bay of Biscay Dolphin Research Program, Hampshire; Fabian Blanchard, IFREMER; Jean-Yves Quintin, IFREMER/Centre de Brest, Plouzané; Dominique Pelletier, IFREMER/Laboratoire MAERHA, Nantes; Jean Boucher, IFREMER, Nantes; Guy Fontenelle, Ecole Supérieure Agronomique, Rennes, and Villy Christensen, Fisheries Centre for correspondence and advice.

#### REFERENCES

- Aguilar, A., and Lockyer, C. H. 1987. Growth, physical maturity, and mortality of fin whales (*Balaenoptera physalus*) inhabiting the temperate waters of the Northwest Atlantic. *Canadian Journal of Zoology*, 65:253-264.
- Allen, K.R. 1971. Relation between production and biomass. *Journal of the Fisheries Research Board of Canada*, 28: 1573-1581.
- Amaratunga, T., 1983. The role of cephalopods in the marine ecosystem. In: *Advances in the assessment of world cephalopod resources*. pp. 379-415, Fisheries and Agricultural Organization, Rome, Vol. 231, 452 pp.
- Anon., 1997. List of critical stocks. Project Marsource, European Commission Directorate General XIV Fisheries, [www.marsource.maris.int/senstcks/list.html](http://www.marsource.maris.int/senstcks/list.html)
- Anon., 1998a. Albacore 1998 detailed report. International Commission for the Conservation of Atlantic Tunas (ICCAT), Madrid, Spain, 49 pp.
- Anon., 1998b. Report of the ICCAT SCRS bluefin tuna stock assessment session. International Commission for the Conservation of Atlantic Tunas (ICCAT), Genoa, Italy, SCRS/98/22. 191 pp.
- Anon., 1998c. Report of the Working Group on marine mammal population dynamics and trophic interactions. International Council for Exploration of the Sea, Copenhagen, ICES Council Meeting, CM 1998/G:6. 28 pp.
- Anon., 1998d. Study group on the biology and life history of crabs. International Council for the Exploration of the Sea, ICES CM 1998/G:10.
- Anon., 1999a. Report of the Working Group on nephrops stock. International Council for Exploration of the Sea., La Coruna, Spain, ICES Council Meeting, CM 1999/ACFM:13. 510 pp.
- Anon., 1999b. Report of the Working Group on seabird ecology. International Council for Exploration of the Sea, CM 1999/C:5. 64 pp.
- Anon., 1999c. Report of the Working Group on the assessment of mackerel, horse mackerel, sardine, anchovy. International Council for the Exploration of the Sea, ICES Council Meeting, ICES CM 1999/ACFM:6, 2 parts. 488 pp.
- Anon., 1999d. Report of the Working Group on the assessment of Southern Shelf demersal stocks. International Council for the Exploration of the Sea, ICES Council Meeting, CM 1999/ACFM:4, 3 parts. 730 pp.
- Anon., 1999e. Swordfish (*Xiphias gladius*). International Commission for the Conservation of Atlantic Tunas (ICCAT), Madrid, Spain, Report of the Standing Committee on research and statistics, Executive summary, 8 pp.
- Anon., 2000. Report of the Working Group on the assessment of mackerel, horse mackerel, sardine and anchovy. International Convention for Exploration of the Sea, ICES Council Meeting, ICES CM 2000/G:01. 54 pp.
- Bauchot, M.-L., and Hureau, J. C., 1990. Sparidae. In: *Checklist of the fishes of the eastern tropical Atlantic (CLOFETA)*. pp. 790-812. Ed. by J. C. Quéro, J. C. Hureau, C. Karrer, A. Post, and L. Saldanha, JNICT, SEI, UNESCO, Lisbon, Paris, Vol. 2.
- Boletzky, S. V., and Hanlon, R. T., 1983. A review of the laboratory maintenance, rearing and culture of cephalopod molluscs. In: *Memoirs of the National Museum of Victoria: Proceedings of the Workshop on the Biology and Resource Potential of Cephalopods*, pp. 147-187, Ed. by Roper, C. F.E., L. C.C., and H. F.G., Melbourne, Australia, 9-13 March, 1981. Vol. 44.
- Brereton, T. M., and Williams, A. D., 2000. A low-cost method to determine bathypelagic and seasonal occupancy of *Balaenoptera physalus* (fin whale) in the Bay of Biscay., Ed. by E. C. S. Cork, [www.biscay-dolphin.org.uk](http://www.biscay-dolphin.org.uk)
- Brito, A., 1991. *Catalogo de los peces de las Islas Canarias*. Francisco Lemus, la Laguna, 230 pp.
- Bromley, P. J., Last, J. M., and Pope, J. G., 1993. Energy Flow Model of the North Sea Ecosystem. In: *Trophic Models of Aquatic Ecosystems*. pp. 298-299, Ed. by V. Christensen and D. Pauly, International Center for Living Aquatic Resources Management, Metro Manila, Philippines
- Bundy, A., Lilly, G. A., and Shelton, P. A., 2000. A mass balance model of the Newfoundland-Labrador Shelf. *Canadian Technical Report of Fisheries and Aquatic Sciences*, Science, Oceans and Environment Branch. Department of Fisheries and Oceans, St. John's NF. Vol. 2310, 90 pp.
- Caverivière, A., and Andriamirado, G. A. R. 1997. Minimal fish predation for the pink shrimp *Penaeus notialis* in Senegal (West Africa). *Bulletin of Marine Science*, 61(3): 685-695.
- Chakroun, N., and Ktari, M. H. 1981. Diet of Sciaenidae (Fishes Teleosteans) of the Tunis Bay. *Bulletin de l'Institut National Scientifique et Technique d'Océanographie et de Pêche de Salammbô*, 8:69-80.
- Christensen, V. 1995. A model of trophic interactions in the North Sea in 1981, the Year of the Stomach. *Dana*, 11(1):1-28.

- Christensen, V., Walters, C.J., and Pauly, D., 2000. Ecopath with Ecosim: A user's guide. Fisheries Centre, University of British Columbia, Vancouver Canada and International Center for Living Aquatic Resources Management, Penang Malaysia, 131pp.
- Cohen, D. M., Inada, T., Iwamoto, T., and Scialabba, N., 1990. Gadiform fishes of the world, Order Gadiformes. In: An annotated and illustrated catalogue of cods, hakes, grenadiers and other gadiform fishes known to date. p. 442. FAO Fisheries Synopsis, Rome, Vol. 10.
- Cohen, E. B., Grosslein, M. D., Sissenwine, M. P., Steimle, E., and Wright, W. R. 1982. Energy budget of Georges Bank. In: Multispecies approaches to fisheries management advice, Ottawa, Canada, Ed. by M. C. Mercer, Canadian Special Publication of Fisheries and Aquatic Sciences, 59:95-107.
- Compagno, L. J. V., 1984. Sharks of the world. An annotated and illustrated catalogue of shark species known to date, Part 1. Hexanchiformes to Lamniformes. FAO Fisheries Synopsis, Rome. Vol. 4, 249 pp.
- Cotman, C., 1993. Faune sous-marine de zelande et de mer du nord. Zealand Underwater Biological Survey, Richard Sheridan (webmaster), Université de Mons-Hainaut, Belgium, <http://staff.umh.ac.be/sheridan.richard/inventaire/art/htm/crangan.htm>
- Cristo. 1998. Feeding ecology of *Nephrops norvegicus*. Journal of Natural History, 32:1493-1498.
- D'Elbée, J., and Hemery, G. 1998. Diet and foraging behaviour of the British storm petrel *Hydrobates pelagicus* in the Bay of Biscay during summer. Ardea, 85(2):1-10.
- FAO, 1994. World review of highly migratory species and straddling stocks. FAO Fisheries Department, Rome, 70 pp.
- Fremy, D., and Fremy, M., 1998. Le Quid 99. 2014 pp.
- Froese, R., and Pauly, D., 2000. FishBase 2000: concepts, design and data sources. ICLARM, Los Baños, Laguna, Philippines. Vol. 76, 344 pp.
- Gilkinson, K., Gagnon, J.-M., and Schneider, D., 1988. The sea urchin, *Strongylocentrotus pallidus*, (G.O. Sars) on the Grand Bank of Newfoundland. In: Echinoderm Biology, Proceedings of the Sixth International Echinoderm Conference, pp. 467-473, Ed. by R. Burke, P. Mladenov, P. Lambert, and R. Parsley, Victoria, 23-28 Aug 1987.
- Gjøsaeter, J., and Kawaguchi, K., 1980. A review of the world resources of mesopelagic fish. FAO Fisheries Technical Paper, No. 193. 151 pp.
- Gonçalves, J. M., 1993. *Octopus vulgaris* Cuvier 1797 (polvo-comum): Sinopse da biologia e exploração. M.Sc. thesis, University of the Azores, Horta, Portugal, 470 pp.
- Gonzalez-Gurriaran, E., Freire, J., and Fernandez, L. 1995. Feeding activity and the contribution of mussel raft culture in the diet of crabs in the Ria de Arousa (Galicia, NW Spain.). ICES Marine Science Symposia, 199:99-107.
- Gremillet, D., Wilson, R. P., and Storeh, S. 1999. Three dimensional space utilization by a marine predator. Marine Ecology Progress Series, 183:263-273.
- Hilbrecht, H., 1996. Extant planktic foraminifera and the physical environment in the Atlantic and Indian Oceans.- Mitteilungen aus dem Geologischen Institut der Eidgen. Technischen Hochschule und der Universität Zürich, Neue Folge., Zürich., No. 300. 93 pp.
- Hilton-Taylor, C., 2000. IUCN Red List of threatened species. IUCN, Switzerland and Cambridge, UK, 61 pp.
- Hutcheson, M., Stewart, P., and Spry, J., 1981. The biology of benthic communities on the Grand Bank of Newfoundland (including the Hibernia area). In: Grand Banks Oceanographic Studies 3, Prepared for Mobil Oil by MacLaren Plansearch. p. 99,
- IWC, 1994. The High North Alliance brochure; Living off the Sea, Minke Whaling in the North East Atlantic. The International Whaling Commission Scientific Committee, [www.highnorth.no/Library/Hunts/Norway/st-mi-wh.htm](http://www.highnorth.no/Library/Hunts/Norway/st-mi-wh.htm)
- Jarre-Teichmann, A., and Guénette, S., 1996. Invertebrate Benthos. p. 90. In: Mass-Balance Models of North-eastern Pacific Ecosystems. Ed. by D. Pauly and V. Christensen. Fisheries Centre Research Report 4(1).
- Kaschner K., Watson R., Christensen V., Trites A.W., and Pauly D. 2001. Modeling and mapping trophic overlap between marine mammals and commercial fisheries in the North Atlantic. pp. 35-45. In: Fisheries impacts on North Atlantic Ecosystems: Catch, effort and national/regional data sets. Ed. by D. Zeller, R. Watson and D. Pauly, Fisheries Centre Research Report 9(3).
- Last, P. R., and Stevens, J. D., 1994. Sharks and rays of Australia. CSIRO, Australia. 513 pp.
- Leif, P. 1985. Food selection and consumption of mobile epibenthic fauna in shallow marine areas. Marine Ecology Progress Series, 22:169-179.
- Lindstrøm, U., Haug, T., and Røttingen, I., 1998. Herring *Clupea harengus* as a key species in Northeast Atlantic Minke Whale *Balaenoptera acutorostrata* diets. ICES Council Meeting, ICES CM 1998/CC:3. 23 pp.
- Longhurst, A., Sathyendranath, S., Platt, T., and Caverhill, C. 1995. An estimate of global primary production in the ocean from satellite radiometer data. Journal of Plankton Research, 17:1245-1271.
- Loris, D., and Rucabado, J., 1990. Pomacentridae. In: Checklist of the fishes of the eastern tropical Atlantic (CLOFETA). pp. 842-850, Ed. by J. C. Quéro, J. C. Hureau, C. Karrer, A. Post, and L. Saldanha, JNICT, Lisbon; SEI, Paris; and UNESCO, Paris, Vol. 2.
- Martin, A. R., and Clarke, M. R. 1986. The diet of sperm whales (*Physeter macrocephalus*) captured between Iceland and Greenland. Journal of Marine Biology Association U.K., 66:779-790.
- Mauchline, J. 1980. The biology of Euphausiids. Advances in Marine Biology, 7:1-454.
- Mauchline, J. 1985. Growth and production of Euphausiacea (Crustacea) in the Rockall Trough. Marine Biology, 90:19-26.
- Melnychuk, M., Morissette, L., Fontenelle, G., Morizur, Y., and Guénette, S., 2001. The French fishery in the North Atlantic (ICES areas VII and VIII), 1996-1998. pp. 162-176. In: Fisheries impacts on North Atlantic Ecosystems: Catch, effort and national/regional data sets. Ed. by D. Zeller, R. Watson and D. Pauly, Fisheries Centre Research Report 9(3).
- Merrifield, K., 2000. The Oregon Birds Forum. Oregon State University Press, [www.orst.edu/pubs/birds](http://www.orst.edu/pubs/birds).
- Monteiro, L. R., Ramos, J. A., Furness, R. W., and del Nevo, A. J. 1996. Movements, Morphology, Breeding, Molt, Diet and Feeding of Seabirds in the Azores. Colonial Waterbirds, 19(1):82-97.
- Montevicchi, W. A., 2000. Seabirds. In: A Mass-Balance Model of the Newfoundland-Labrador Shelf. pp. 15-18, Ed. by A. Bundy, G. R. Lilly, and P. A. Shelton, Canadian Technical Report of Fisheries and Aquatic Sciences, St. John's, NF, Canada, Vol. 2310.
- Mooi, R., and Telford, M., 1982. The feeding mechanism of the sand dollar, *Echinarchnius parma* (Lamarck). In: Echinoderms: Proceedings of the International Conference, pp. 51-57, Ed. by J. Lawrence, Tampa Bay, A.A. Balkema, Rotterdam.
- Morizur, Y., N. Tregenza, H. Heessen, S. Berrow, S. Pouvreau, 1996. By-catch and discarding in pelagic trawl fisheries. IFREMER, Plouzané, report, Contract EC DG XIV-C-1; Study:Bioeco /93/017. 125 pp.
- Nelson, B., 1979. Seabirds: their biology and ecology. A and W Publishers Inc., New York. 224 pp.

- Opitz, S., 1993. A quantitative model of the trophic interactions in a Caribbean coral reef ecosystem. In: *Trophic Models of Aquatic Ecosystems*. pp. 259-267, Ed. by V. Christensen and D. Pauly, International Center for Living Aquatic Resources Management, Metro Manila, Philippines.
- Pauly, D. 1986. A simple method for estimating the food consumption of fish populations from growth data of food conversion experiments. *Fishery Bulletin*, 84(4):827-840.
- Pauly, D., and Christensen, V. 1995. Primary production required to sustain global fisheries. *Nature*, 374:255-257.
- Pauly, D., Sambilya, V. J., and Opitz, S., 1993. Estimates of relative food consumption by fish and invertebrate populations, required for modelling the Bolinao Reef ecosystem, Philippines. In: *Trophic models of aquatic ecosystems*. pp. 236-251, Ed. by V. Christensen and D. Pauly, ICLARM Conference Proceedings., Vol. 26.
- Perry, S. L., DeMaster, D. P., and Silber, G. K. 1999. The great whales: History and status of six species listed as endangered under the U.S. Endangered Species Act of 1973. *Marine Fisheries Review*, 61(1):1-74.
- Pihl, L. 1985. Food selection and consumption of mobile epibenthic fauna in shallow marine areas. *Marine Ecology Progress Series*, 22:169-179.
- Pihl, L., and Rosenber, R. 1982. Production, abundance and biomass of mobile epibenthic marine fauna in shallow waters, western Sweden. *Journal of Experimental Marine Biology and Ecology*, 57:273-301.
- Prince, P. A., and Morgan, R. A., 1987. Diet and Feeding Ecology of Procellariiforms. In: *Seabirds - Feeding ecology and Role in the Marine Ecosystem*. Ed. by J. P. Croxal, Cambridge University Press,
- Robins, C. R., Bailey, R. M., Bond, C. E., Brooker, J. R., Lachner, E. A., Lea, R. N., and Scott, W. B., 1991. *World fishes important to North Americans. Exclusive of species from the continental waters of the United States and Canada*. American Fisheries Society Special Publication, Vol. 21, 243 pp.
- Robins, C. R., and Ray, G. C., 1986. *A field guide to Atlantic coast fishes of North America*. Houghton Mifflin Company, Boston, USA. Vol. 354, 178 pp.
- Sameoto, D. D. 1976. Respiration rates, energy budgets, and molting frequencies of three species of euphausiids found the the Gulf of St. Lawrence. *Journal of the Fisheries Research Board of Canada*, 33:2568-2576.
- Sánchez, F., de la Gándara, F., and Gancedo, R., 1995. *Atlas de los peces demersales de Galicia y el Cantábrico. Otoño 1991-1993*. Publicaciones Especiales, Instituto Español de Oceanografía, Madrid, Spain. Vol. 20, 100 pp.
- Stehmann, M., and Bürkel, D. L., 1984. Rajidae. In: *Fishes of the north-eastern Atlantic and Mediterranean*. pp. 163-196, Ed. by P. J. P. Whitehead, M.-L. Bauchot, J.-C. Hureau, J. Nielsen, and E. Tortonese, UNESCO, Paris, Vol. 1.
- Stergiou, K. I., and Fourtouni, H. 1991. Food habits, ontogenetic diet shift and selectivity in *Zeus faber* Linnaeus, 1758. *Journal of Fish Biology*, 39:589-603.
- Tamura, T., and Ohsumi, S., 1999. Estimation of total food consumption by cetaceans in the world's oceans. *The Institute of Cetacean Research, Tokyo (Japan)*, 16 pp.
- Trites, A., and Heise, K., 1996. Marine mammals. pp. 51-55. In: *Mass-Balance Models of North-eastern Pacific ecosystems*. Ed. by D. Pauly and V. Christensen. Fisheries Centre Research Report 4(1).
- Trites, A., and Pauly, D. 1998. Estimating mean body masses of marine mammals from maximum body lengths. *Canadian Journal of Zoology*, 76:886-896.
- Venier, J. M., and Pauly, D., 1997. Trophic dynamics of a Florida Keys coral reef ecosystem. In: *Proceedings of the 8th International Coral Reef Symposium*, pp. 915-920.
- Wada, Y., 1996. Marine mammals and birds. p. 71. In: *Mass-Balance Models of North-eastern Pacific Ecosystems*. Ed. by D. Pauly and V. Christensen. Fisheries Centre Research Report 4(1).
- West, R. A. R. D., 2000. *Atlantic Ocean*. The Oceanographer of the Navy (CNO N096), US Navy, Spawarsyscen Charleston, South Carolina, USA, <http://oceanographer.navy.mil/atlantic.html>
- Whitehead, P. J. P., 1985. Clupeoid fishes of the world: An annotated and illustrated catalogue of the herrings, sardines, pilchards, sprats, shads, anchovies and wolf-herrings. Part 1 - Chirocentridae, Clupeidae and Pristigasteridae. *FAO Fisheries Synopsis*, Vol. 7, 303 pp.
- Wood, J. B., and Day, C. L., 2000. *Cephbase*. National Resource Center for Cephalopods, Dalhousie University, [www.cephbase.dal.ca/](http://www.cephbase.dal.ca/)

# A PRELIMINARY ECOSYSTEM MODEL FOR THE ATLANTIC COAST OF MOROCCO IN THE MID-1980S

*Richard Stanford, Kristin Lunn and Sylvie Guénette*

*Fisheries Centre, University of British Columbia, 2204 Main Mall, Vancouver BC, V6T 1Z4, Canada  
e-mail: s.guennette@fisheries.ubc.ca*

## ABSTRACT

This paper documents the construction of the model of the Atlantic coast of Morocco including the coast of Western Sahara (Tangier to Cape Blanc). The model includes 37 functional groups of which 23 are fishes, grouped by size and commercial importance. The balancing process is described and highlights knowledge gaps. Recommendations for improvements of the model are given.

## INTRODUCTION

The rich fishing grounds of the Moroccan Coast, are largely the consequence of an upwelling zone driven by the Canary Current (Belvèze and Erzini, 1984). The northeast to southwest flow transports cold waters along the northwest African coast and, combined with the trade winds, causes an upwelling of nutrient rich water to the surface. As a result, primary production is increased, generating rich fishing grounds (Nehring and Holzlohner, 1982). Upwelling intensity varies according to location and season, due to the variation in the trade winds throughout the year. The upwelling is weak in winter, develops in spring and peaks in intensity during the summer, coinciding with maximum irradiance. The upwelling ranges from 12°N to 33°N (Wooster, 1976 in Belvèze and Erzini, 1984), but can be subdivided into 3 main areas. North of 25°N upwelling primarily occurs in the summer, south of 20°N it occurs during the winter and spring, and between 20°N and 25°N, upwelling occurs throughout the year (Figure 1). Coastal topography is a significant factor in determining upwelling location. For a more detailed analysis of upwellings off the northwest African coast, see Belvèze and Erzini (1984).

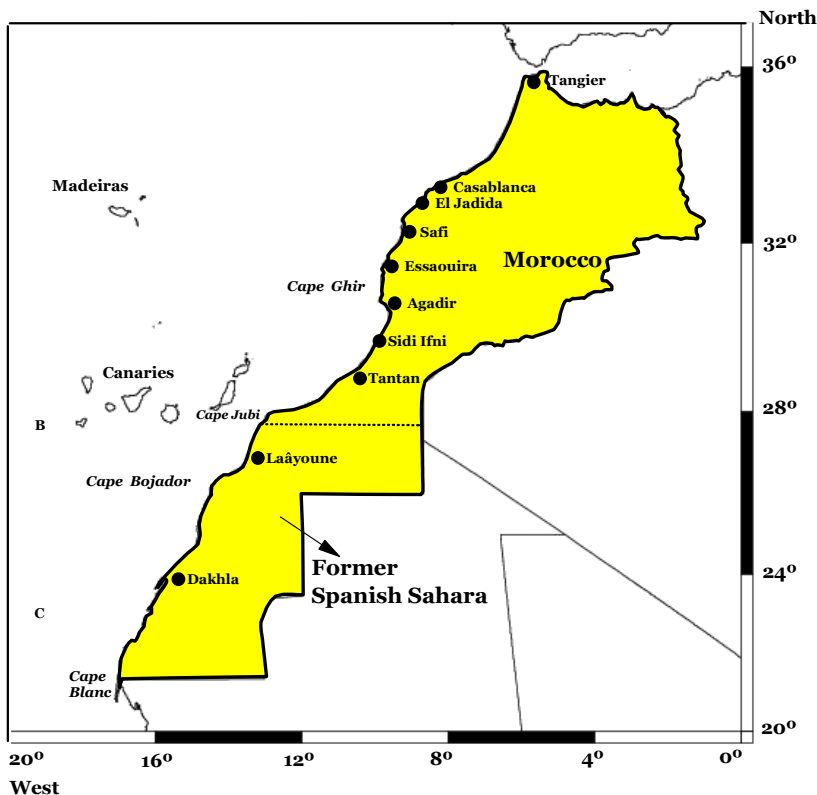

**Figure 1.** The Atlantic Moroccan coast showing the principal fishing ports, and the border of the former Spanish Sahara.



The ecosystem modeled here covers the Atlantic coast of Morocco extending from Tangier (36°N) to Cape Blanc (20°N) and is as wide as the EEZ. The resulting area is 586,900 km<sup>2</sup> (Figure 1). The mean annual water temperature, 19.4°C, was estimated by averaging over 1985-1986 from *www.noaa.gov*. At the time of the construction of the model, we did not have access to biomass estimates for the 1990s. Consequently, the model presented here represents the mid 1980s.

## MODEL PARAMETERIZATION

Five key meters are required for Ecopath models: biomass, production per unit of biomass (P/B), consumption per unit of biomass (Q/B), ecotrophic efficiency (EE) and diet composition. The average biomass in the model area (586,900 km<sup>2</sup>) is given in t·km<sup>-2</sup>. Since biomass estimates were extremely difficult to find for the coast of Morocco, they were left, for many groups, for Ecopath to estimate, by assuming an ecotrophic efficiency of 0.95. The ecotrophic efficiency is the fraction of production that is used in the system. Essentially, it refers to the mortality of a group explained by the model.

P/B expressed per year is equal to the instantaneous total mortality (Z), the sum of fishing mortality (F) and natural mortality (M). For commercial species, F was taken from stock assessment reports or obtained by dividing fisheries catch by biomass. Unless otherwise stated, the natural mortality for the fish groups in this model, were calculated from the following equation (Pauly, 1980):

$$M = K^{0.65} * L_{inf}^{-0.279} * T^{0.463} \quad \dots 1)$$

where K is the von Bertalanffy growth constant (per year),  $L_{inf}$  is the asymptotic length (in cm) and T is the average water temperature (in °C). For non-fish groups and when a K value was not available for the fish, different data sources were used and are recorded individually below. Generally, in absence of K values for a high proportion of the groups' species, natural mortality estimates from FishBase (Froese and Pauly, 2000) were used and labeled 'FishBase generic values'.

All Q/Bs, expressed per year, were calculated using an empirical equation derived by Palomares and Pauly 1989;

$$Q/B = 10^{6.37 * 0.0313^{Tk}} * Winf^{0.168} * 1.38^{Pf} * 1.89^{Hd} \quad \dots 2)$$

where,  $Tk = 1000 \cdot (\text{Temperature in } ^\circ\text{C} + 273.1)^{-1}$ ,  $W_{inf}$  = asymptotic weight in g,  $Pf = 1$  for predators and planktivores, zero for herbivores and detritivores, zero for omnivores  $Hd = 1$  for carnivores and omnivores, zero for detritivores and herbivores.  $W_{inf}$  was calculated using the a and b parameters of length-weight relationships of the form  $Winf = a \cdot Linf^b$ , taken from the location closest to Morocco in FishBase (Froese and Pauly, 2000). In some cases, Q/B was estimated from an empirical equation in the 'Keyfact Table' of Fishbase (*www.fishbase.org*) which uses the aspect ratio of the fish' caudal fins as an input.

The majority of fish diet composition data was taken from FishBase (*www.fishbase.org*) and relevant literature for the most important species. Literature diet data for species from other areas included prey items that did not occur in Morocco. These prey items were placed in a functional group with similar species. For many species, existing diet data were qualitative (present/not present) or were measured as frequency of occurrence rather than measures based on weight or volume. In these cases, percentages were equally apportioned among groups. Unless otherwise stated, unidentified dietary components were split proportionally into the diet groups that were already present and combined values or entirely qualitative data were split equally between the identified groups. The detailed diet matrix is presented in Tables 1 to 3.

## Description of functional groups

### Primary producers (Group 1)

Benthic macroalgae and phytoplankton are the primary producers in the system. Little is known of the dominant species of phytoplankton. Phytoplankton biomass was calculated using the values given in Li (1994). Using a conversion factor of 32 gC = 1 g Chl a and 43 gC = 1 g wet weight, the wet weight was estimated as 94.1 t·km<sup>-2</sup>. Lalli and Parsons (1993) gave a pictorial description of global phytoplankton production, with an approximate value of 150-250 gC·m<sup>-2</sup>·year<sup>-1</sup> for the Moroccan coast. Using the same conversion factor of 43 gC = 1 g wet weight·m<sup>-2</sup>, we were able to estimate the P/B for phytoplankton at 91.4 year<sup>-1</sup>.

Macrophyte biomass was calculated using data from Belvèze and Bravo de Laguna (1980). The authors listed the percentage of the total surface area (from 0-50 m depth) that can be trawled from Cap Spartel to Cap Blanc (the northern and southern limits of our study area). From these

**Table 1.** Source location and quality of the diet information for selected functional groups.

Scientific name	English name	Diet information	Location	Source
<b>Small demersal (group 14)</b>				
<i>Callionymus maculatus</i>	Dragonet	Quantitative	Scotland, Atlantic coast	Gibson and Ezzi (1987)
<i>Arnoglossus laterna</i>	Scaldfish	Quantitative	Scotland, Atlantic coast	Gibson and Ezzi (1987)
<i>Atherina boyeri</i>	Big-scale sand smelt	Quantitative	Black Sea	Zander (1986)
<i>Gobius niger</i>	Black goby	Quantitative	Norway	Fjøsne and Gjørseter (1996)
<i>Ctenolabrus rupestris</i>	Goldsinny wrasse	Quantitative	Norway	Fjøsne and Gjørseter (1996)
<b>Medium demersal (group 15)</b>				
<i>Coris julis</i>	Rainbow wrasse	Qualitative	Unknown	Fischer <i>et al.</i> (1987)
<i>Trachinus vipera</i>	Lesser weever	Quantitative	UK, Scotland	Gibson and Robb (1996)
<i>Parablennius gattorugine</i>	Tompot blenny	Qualitative	Unknown	Zander (1986)
<i>Callionymus lyra</i>	Dragonet	Qualitative	Unknown	Fricke (1986)
<i>Capros aper</i>	Boarfish	Qualitative	Unknown	Quéro (1986)
<i>Antigonia capros</i>	Deepbody boarfish	Qualitative	St Helena	Edwards (1990)
<i>Nezumia aequalis</i>	Atlantic grenadier	Qualitative	Namibia	MacPherson and Roel (1987)
<i>Labrus bimaculatus</i>	Cuckoo wrasse	Qualitative	Maritimes, Canada	Mérigoux and Ponton (1998)
<i>Caelorinchus caelorhincus</i>	Hollowsnout grenadier	Quantitative	Nova Scotia, Canada	Langton and Bowman (1980)
<i>Trisopterus minutus</i>	Poor cod	Quantitative	UK	Armstrong (1982)
<i>Lepidorhombus boscii</i>	Fourspotted megrim	Quantitative	North Tyrrhenian Sea, Italy	Mannini <i>et al.</i> (1990)
<i>Bothus podas</i>	Wide-eyed flounder	Qualitative	Azores	Nash <i>et al.</i> (1991)
<i>Syngnathus acus</i>	Greater pipefish	Quantitative	South Africa	Bennett (1989)
<i>Alepocephalus rostratus</i>	Risso's smooth-head	Quantitative	Namibia	Carrasson and Matallanas (1998)
<b>Medium demersal commercial (group 16)</b>				
<i>Diplodus vulgaris</i>	Common two-banded bream	Quantitative	Spain	Sala and Ballesteros (1997)
<i>Diplodus cervinus cervinus</i>	Zebra seabream	Qualitative	Unknown	Fischer <i>et al.</i> (1987)
<i>Balistes vetula</i>	Queen triggerfish	Quantitative	Puerto Rico	Randall (1967)
<i>Scorpaena notata</i>	Small red scorpionfish	Quantitative	France	Harmelin-Vivien <i>et al.</i> (1989)
<i>Brachydeuterus auritus</i>	Bigeye grunt	Qualitative	Senegal	Ben-Tuvia and McKay (1986)
<i>Mullus barbatus</i>	Red Mullet	Quantitative	Nova Scotia, Canada	Labropoulou and Eleftheriou (1997)
<i>Dicologlossa cuneata</i>	Wedge sole	Qualitative	Unknown	Quéro <i>et al.</i> (1986)
<i>Scorpaena porcus</i>	Black scorpionfish	Quantitative	France	Harmelin-Vivien <i>et al.</i> (1989)
<i>Oblada melanura</i>	Saddled seabream	Quantitative	France	Lenfant and Olive (1998)
<i>Pagellus acarne</i>	Axillary seabream	Quantitative	Central Eastern Atlantic	Domanevskaya and Patokina (1984)
<i>Solea lascaris</i>	Sand sole	Quantitative	France	Rodriguez (1996)
<i>Mullus surmuletus</i>	Striped Red Mullet	Quantitative	Spain	Olaso and Rodriguez-Marin (1995)
<i>Chelidonichthys lastoviza</i>	Longfin gurnard	Qualitative	unknown	Richards and Saksena (1990)
<i>Pagellus bellottii bellottii</i>	Red pandora	Qualitative	Senegal	Caverivière and Rabarison Andriamirado (1997)

Scientific name	English name	Diet information	Location	Source
<i>Trisopterus luscus</i>	Pouting	Quantitative	Isle of Man, UK	Armstrong (1982)
<i>Chelidonichthys cuculus</i>	East Atlantic red Gurnard	Quantitative	Spain	Velasco <i>et al.</i> (1996)
<i>Micromesistius poutassou</i>	Blue whiting	Quantitative	Spain	Olaso and Rodriguez-Marin (1995)
<i>Scorpaena scrofa</i>	Largescaled scorpionfish	Quantitative	Marseilles, France	Harmelin-Vivien <i>et al.</i> (1989)
<i>Pagellus erythrinus</i>	Common pandora	Quantitative	Spain	Olaso and Rodriguez-Marin (1995)
<b>Large demersal (group 17)</b>				
<i>Malacocephalus laevis</i>	Softhead grenadier	Quantitative	South Africa	Meyer and Smale (1991)
<i>Hoplostethus atlanticus</i>	Orange roughy	Quantitative	Australia	Kotlyar (1980)
<i>Scophthalmus rhombus</i>	Brill	Qualitative	Unknown	Bauchot (1987)
<i>Arius parkii</i>	Guinean sea catfish	Partially Quantitative	Senegal	Diouf, 1996; Caverivière and Rabarison Andriamirado (1997)
<i>Cepola macrophthalma</i>	Red bandfish	Qualitative	Unknown	Stergiou (1993)
<i>Rhinobatos rhinobatos</i>	Common guitarfish	Partially quantitative	Senegal	Caverivière and Rabarison Andriamirado (1997)
<i>Phycis phycis</i>	Forkbeard	Quantitative	Greece	Papaconstantinou and Caragitsou (1989)
<i>Alepocephalus bairdii</i>	Baird's smooth-head	Qualitative	Unknown	Markle and Quéro (1984)
<b>Large demersal commercial (group 18)</b>				
<i>Diplodus puntazzo</i>	Sharpsnout seabream	Quantitative	Spain	Sala and Ballesteros (1997)
<i>Umbrina canariensis</i>	Canary Drum	Quantitative	Spain	van der Elst and Adkin (1991)
<i>Chelidonichthys gurnardus</i>	Grey gurnard	Quantitative	Spain	Moreno-Amich (1994)
<i>Dentex macrophthalmus</i>	Large eye Dentex	Quantitative	Area between Cap Blanc and Cap Bojador	Domanevskaya and Patokina (1984)
<i>Sparus aurata</i>	Gilthead seabream	Qualitative	Australia	Winstanley (1983)
<i>Beryx splendens</i>	Splendid alfonso	Quantitative	Russian Fed. Naska seamount	Dubochkin and Kotlyar (1989)
<i>Pagellus bogaraveo</i>	Blackspot seabream	Qualitative	Can Mart Qeb	Bauchot and Hureau (1990)
<i>Pagrus caeruleostictus</i>	Bluespotted seabream	Qualitative	Senegal	Caverivière and Rabarison Andriamirado (1997)
<i>Zeus faber</i>	John Dory	Quantitative	Greece	Stergiou and Fourtouni (1991)
<i>Pagrus pagrus</i>	Red porgy	Quantitative	Greece	Papaconstantinou and Caragitsou (1989)
<i>Dicentrarchus labrax</i>	European seabass	Qualitative	Unknown	Fischer <i>et al.</i> (1987)
<i>Pseudotolithus typus</i>	Longneck croaker	Qualitative	Senegal	Diouf (1996)
<i>Pseudotolithus senegalens</i>	Cassava croaker	Qualitative	Senegal	Diouf (1996)
<i>Dentex dentex</i>	Common dentex	Quantitative	Spain, Balearic Is.	Morales-Nin and Moranta (1997)
<i>Phycis blenoides</i>	Greater forkbeard	Quantitative	Spain	Velasco <i>et al.</i> (1996)
<i>Epinephelus aeneus</i>	White grouper	Partially Quantitative	Unknown and Senegal	McCosker, 1988; Caverivière and Rabarison Andriamirado (1997)
<i>Anguilla anguilla</i>	European eel	Quantitative	Portugal	Costa <i>et al.</i> (1992)
<b>Large bathypelagic fish (group 23)</b>				
<i>Trachyearincus scabrus</i>	Roughsnout grenadier	Quantitative	Namibia	MacPherson and Roel (1987)
<i>Eurypharynx pelecanooides</i>	Pelican eel	Qualitative	California, USA	Eschmeyer <i>et al.</i> (1983)
<i>Mora moro</i>	Common mora	Qualitative	Australia	Coleman and Mobley (1984)
<i>Lepidocybium flavobrunneum</i>	Escolar	Qualitative	Cuba	Sierra <i>et al.</i> (1994)

Scientific name	English name	Diet information	Location	Source
<b>Very large demersal commercial (group 20)</b>				
<i>Merluccius merluccius</i>	European hake	Quantitative	Bay of Biscay, France	Guichet (1995)
<i>Seriola dumerili</i>	Greater amberjack	Qualitative	West Indies	Randall (1967)
<i>Lepidopus caudatus</i>	Silver scabbardfish	Quantitative	South Africa	Smale (1991)
<i>Argyrosomus regius</i>	Meagre	Qualitative	Senegal	Caverivière and Rabarison Andriamirado (1997)
<i>Trichiurus lepturus</i>	Largehead hairtail	Qualitative		
<b>Mesopelagic prey fish (group 24)</b>				
<i>Argyrolepecus hemigymnus</i>	half-naked hatchetfish	Quantitative	Gulf of Mexico	Hopkins and Baird (1985)
<i>Benthoosema glaciale</i>	glacier lanternfish	Qualitative	Unknown	Hulley (1990)
<i>Gadiculus argenteus argenteus</i>	silvery cod	Quantitative	Rockall area off Scotland	Conway (1980)
<i>Maurolicus muelleri</i>	pearlsides	Quantitative	South Atlantic	Gorelova and Krasil'nikova (1990)
<i>Sternoptyx diaphana</i>	diaphanous hatchet fish	Quantitative	Eastern Gulf of Mexico	Hopkins and Baird (1985)
<i>Vinciguerrria nimbaria</i>	oceanic lightfish	Quantitative	Tropical Atlantic	Shevchenko (1986)
<i>Atherina presbyter</i>	sand smelt	Qualitative	France	Billard (1997)
<b>Tunas (group 29)</b>				
<i>Katsuwonus pelamis</i>	Skipjack	Quantitative	Western Indian Ocean	Roger (1993)
<i>Thunnus albacares</i>	Yellowfin tuna	Quantitative	Western Indian Ocean	Roger (1993)
<i>Thunnus thynnus</i>	Bluefin tuna	Quantitative	Bay of Biscay	Ortiz de Zarate and Cort (1986)
<i>Thunnus alalunga</i>	Albacore	Quantitative	Bay of Biscay	Ortiz de Zarate and Cort (1986)
<i>Auxis thazard thazard</i>	Frigate tuna	Quantitative	Solomon Islands	Blaber <i>et al.</i> (1990)
<i>Auxis rochei rochei</i>	Little tunny	Quantitative	Indian Ocean	Kumaran (1964)
<i>Thunnus obesus</i>	Bigeye tuna	Quantitative	Northern Peru	Fuentes <i>et al.</i> (1988)
<i>Xiphias gladius</i>	Swordfish	Quantitative	Western Northern Atlantic	Scott and Tibbo (1968)
<i>Orcynopsis unicolor</i>	Plain bonito	Qualitative	Unknown	Collette and Nauen (1983)
<i>Sarda sarda</i>	Atlantic bonito	Qualitative	Unknown	Yoshida (1980)

values, it was determined that approximately 1,937 miles<sup>2</sup> (or 5,017 km<sup>2</sup>) of the total area (up to 50 m deep) was made up of non-trawlable rock bottom. Assuming the first 25 m depth to account for 50% of the area and that 75% of this rock surface could support algal growth up to 25 m, the total surface area used in our calculations of macrophyte biomass was 1,882 km<sup>2</sup>. Macrophytes density in the Azores was 550 g·m<sup>-2</sup> dry weight or 2,619 g·m<sup>-2</sup> wet weight (Neto, 1997), using a dry weight to wet weight ratio of 0.21 as given in Mackinson (1996). Using the same density, the Moroccan macrophyte biomass was estimated at 8.4 t·km<sup>-2</sup>. Combining the macrophyte and phytoplankton biomass gave a total of 102.5 t·km<sup>-2</sup> for this functional group. For macrophytes, we used a value of P/B = 15 based on a guesstimate (A. Jarre-Teichman, pers. comm.). A weighted average of the P/B values for

phytoplankton and macrophytes yielded an estimate of 84.6 t·km<sup>-2</sup>.

Artisanal fishers collected red and brown seaweeds, listed separately in the catch data as 'red seaweeds and other aquatic plants'. The red seaweeds were *Celidium* and *Graciliaris* species, and the brown algae *Laminaria*. The total landing of seaweeds was reportedly 5,190 t or 0.00884 t·km<sup>-2</sup>.

### **Small zooplankton (Group 2)**

Zooplankton were separated into large and small groups to reduce cannibalism. Small zooplankton were assumed to be copepods, cladocerans and polychaete larvae.

For the outer shelf and slope north of Cap Blanc, Weikert (1982) gave the average wet weight of invertebrate plankton (copepods and related invertebrates) as  $101 \text{ mg m}^{-3}$  up to 200 m depth. By integrating this value over depth, we calculated the total wet weight for the area to be  $20.2 \text{ g m}^{-2}$  in 1968.

Banse and Mosher estimated P/B for small zooplankton (microzooplankton) at  $25 \text{ year}^{-1}$ , which is consistent with the values used both in the Labrador model by Bundy *et al.* (2000) and the Alaskan Gyre model (Purcell, 1996). Our estimate for the Q/B ratio of small herbivorous zooplankton ( $90.4 \text{ year}^{-1}$ ) was taken directly from the Alaskan Gyre model (Purcell, 1996). Small zooplankton was assumed to feed exclusively on phytoplankton (Bundy *et al.*, 2000).

### **Large zooplankton (Group 3)**

Although zooplankton are a crucial link between primary production and fish production, there was little information on them from Morocco. The large zooplankton group included chaetognaths, euphausiids, amphipods, isopods, mysids and jellyfish.

We used the P/B ratio given for euphausiids in the Alaskan Gyre model by Polovina *et al.* (1996) as our estimate for this functional group (P/B=6  $\text{year}^{-1}$ ). The Q/B ratio for salps, tunicates, and euphausiids used in the Labrador model (Bundy *et al.*, 2000) was utilised as a basis for this model. The Labrador model estimated Q/B at  $21 \text{ year}^{-1}$ , but we used the slightly higher value of  $25 \text{ year}^{-1}$  to incorporate small jellyfish into our estimate. Jellyfish have very high Q/B ratios, (e.g.,  $110 \text{ year}^{-1}$  in the Alaskan Gyre model - considered high by the authors - Arai, 1996). To the best of our knowledge, jellyfish do not make up an important component of the Moroccan coastal ecosystem and were therefore not weighted heavily in our Q/B estimate.

Large zooplankton can be herbivorous (some euphausiid species), omnivorous (most euphausiids, amphipods and mysids) or carnivorous (chaetognaths and jellyfish) (Bundy *et al.*, 2000). The proportions of these groups off the coast of Morocco were unknown. The diet of euphausiids was based on Mauchline and Fisher (1980). Diet for isopods and amphipods are from qualitative accounts from Florida (Venier and Pauly, 1997). The resulting diet was: 58% for primary producers, 5% for small zooplankton, 10% for large zooplankton, and 2.25% for other benthos. These data were treated as very approximate and later modified (Table 2).

### **Worms (Group 4)**

This group was dominated by polychaetes, but also included other nematodes and flatworms. Because there are so many species of worms living on and in the sediment, this was a diverse group. Some worms are errant, and others sedentary, and some are deposit or suspension feeders, whilst others are carnivorous. No information was found specifically referring to worm populations off the coast of Morocco.

No estimate of biomass was available for this group. P/B ( $2 \text{ year}^{-1}$ ) and Q/B ( $22 \text{ year}^{-1}$ ) estimates for polychaetes were taken from the Labrador model (Bundy *et al.*, 2000). The worms were assumed to be entirely detritivorous (Nesis, 1965).

### **Other benthos (Group 5)**

This group includes non-predatory echinoderms, mollusks, pycnogonids, porifera, tunicates and benthic species of amphipod, isopod and copepoda. No estimate of biomass was available for this group. Using an average value of 'other benthic invertebrates' and 'mollusks' from the Labrador model by Bundy *et al.* (2000), we calculated the average P/B ratio for this functional group as  $1.55 \text{ year}^{-1}$ . Using the same method Q/B was estimated at  $9.4 \text{ year}^{-1}$ . In accordance with Nesis (1965), this group was assumed to feed entirely on detritus.

### **Predatory echinoderms (Group 6)**

This benthic group was created to avoid large intra-group cannibalism and includes the true starfish (Asteroidea) and some members of the brittle stars (Ophiuridae) that feed entirely carnivorously or omnivorously. The remainder of the echinoderms were placed in group 4 (other benthos).

No estimate of biomass was available for this group. The P/B value ( $1.1 \text{ year}^{-1}$ ) was obtained by averaging values given for sea stars ( $0.4 \text{ year}^{-1}$ ) and brittle stars ( $1.8 \text{ year}^{-1}$ ) given in the model of the southern BC shelf (Jarre-Teichmann and Guénette, 1996). The same procedure was used to estimate Q/B at  $4.44 \text{ year}^{-1}$  (Jarre-Teichmann and Guénette, 1996). Other benthos accounted for 80% of the diet (Sloan, 1980), while the rest was attributed to detritus.

**Table 2.** Final diet matrix for non-fish functional groups. The original value entered in Ecopath value is in italic on the second row of a cell. A value smaller than 0.001 is represented by zero, while S.=small; L.=large; V.L.=very large; dw=deep-water; C= commercial

Prey	Predator												
	2	3	4	5	6	7	8	9	33	34	35	36	37
1. Primary producers	1	0.579				0.007	0.32						
2. S. zooplankton		0.06				0.14	0.1		0.064				
		<i>0.05</i>							<i>0.056</i>				
3. L. zooplankton		0.1						0.11	0.136	1	0.125	0.71	
									<i>0.045</i>				
4. Worms						0.04	0.03		0.064				
									<i>0.056</i>				
5. Other benthos					0.986	0.25	0.2	0.667	0.1		0.05		0.01
		<i>0.022</i>				<i>0.45</i>		<i>0.66</i>	<i>0.16</i>				
6. Predatory echinoderms						0.003							
7. Crabs						0.02			0.197				0.01
						<i>0.09</i>			<i>0.16</i>				
8. Shrimps						0.006	0.02		0.183				0.01
									<i>0.16</i>				
9. Lobsters													
10. Detrital feeders									0.007				
11. S. dw benthic													
12. L. dw benthic													
13. L. dw C													
14. S. demersal						0.012		0.212	0.027		0.21	0.04	0.07
								<i>0.21</i>	<i>0.024</i>				
15. M. demersal												0.04	0.07
16. M. demersal C										0.15	0.04	0.04	0.07
									<i>0.015</i>				
17. L. demersal													0.03
18. L. demersal C													
19. V.L. demersal													
20. V.L. demersal C													
									<i>0.005</i>				
21. S. bathypelagic									0.058			0.03	0.045
									<i>0.051</i>				<i>0.04</i>
22. M. bathypelagic									0.001				0.045
									<i>0.015</i>				
23. L. bathypelagic									0.001				
									<i>0.009</i>				
24. Mesopelagic prey									0.041		0.225	0.03	0.045
									<i>0.036</i>				
25. M. pelagic												0.03	0.03
													<i>0.02</i>
26. M. pelagic C									0.067			0.03	0.03
									<i>0.059</i>				<i>0.02</i>
27. L. pelagic													
28. Sardines									0.02		0.04	0.03	0.022
													<i>0.02</i>
29. Tunas													
30. S. demersal sharks													
31. L. dem. sharks C													
32. Pelagic sharks													
33. Cephalopods								0.01	0.033		0.2	0.02	0.511
								<i>0.02</i>	<i>0.130</i>				
34. Turtles													
35. Seabirds													
36. Baleen whales													0.0001
37. Toothed whales													0.001
													<i>0.029</i>
Detritus		0.261	1	1	0.004	0.527	0.35						
					<i>0.2</i>	<i>0.27</i>							

### **Crabs (Group 7)**

This functional group consists of macrobenthic crabs. Basic parameters were estimated using male and female edible crab (*Cancer pagurus*), green crab (*Carcinus maenas*), and spinous spider crab (*Maja squinado*). No estimate of biomass was available for this group. In absence of local estimates a P/B of 1.8 year<sup>-1</sup> and a Q/B of 10 year<sup>-1</sup> were used from Southern British Columbia (Jarre-Teichmann and Gu enette, 1996).

Diet information was based on juvenile green crab and velvet crab (*Necora puber*) (Gonzalez-Gurriaran *et al.*, 1995). Cannibalism in crabs was high (18.7%) because large crabs feed on small crabs. This value was halved with the difference split equally into the dominant prey items, other benthos and detritus. The resulting diet was composed of 45% other benthos, 27% detritus, 9% crabs, 4% worms, 1% small demersal fish, 14% small zooplankton, 0.6% shrimps, 0.4% Predatory echinoderms. Cannibalism and predation on other benthos were reduced to balance the model (Table 2).

### **Shrimps (Group 8)**

The main species of shrimp found off the coast of Morocco are deepwater rose shrimp (*Parapanaeus longirostris*), and pink shrimp (*Penaeus notialis*) although scarlet shrimp (*Plesiopenaeus edwardsianus*), royal shrimp (*Pleoticus robustus*) and blue shrimp (*Aristeus antennatus*) are also present. No estimate of biomass was available for this group. There was no information for shrimp P/B in the waters off North Africa and a value of 1.7 was used from Norwegian waters (Hopkins, 1988). In absence of data for Q/B, P/Q was given a value of 0.15 year<sup>-1</sup> (Bundy *et al.*, 2000).

The shrimp diet was based on *Crangon crangon* (Pihl, 1985) and generic herbivorous and predatory shrimps (Venier and Pauly, 1997). Of the diet, 31% was allocated to primary production, 2% to worms, 10% each for other benthos, small and large zooplankton, 35% to the detritus and the remaining 2% to cannibalism.

### **Lobsters (Group 9)**

Three species of lobster were present in Moroccan waters, the European lobster (*Homarus gammarus*), the spiny lobster (*Palinurus elephas*) and the Norwegian lobster (*Nephrops norvegicus*). No estimate of biomass was available for this group. Values for P/B and Q/B were taken from the Newfoundland-Labrador Model of

Bundy *et al.* (2000) as 2.82 year<sup>-1</sup> and 5.85 year<sup>-1</sup> respectively.

The frequency of occurrence of various items in the diet of the Norwegian lobster has been described as consisting of 66% other benthos, 11% large zooplankton, 21% small demersal fish and 2% cephalopods (Cristo, 1998).

### **Detrital feeders and herbivores (Group 10)**

This small group is dominated by three species of mullet (Mugilidae) and also contains salemma (*Sarpa sarpa*) and planehead filefish (*Stephanolepis hispidus*). All of the mullet species were assumed to be commercially fished, although the catch data did not identify them. This demersal group inhabits coastal regions often forming shoals. No estimate of biomass was available for this group.

Natural mortality for this group was calculated from thinlip mullet (*Liza ramada*), thicklip grey mullet (*Chelon labrosus*) and golden grey mullet (*Liza aurata*) and averaged, equaling 0.368 year<sup>-1</sup>. As a first attempt, an assumption was made that F was equal to half of M which yielded a value of 0.552 year<sup>-1</sup>. This value may be overestimated. A Q/B of 7.161 year<sup>-1</sup> was estimated as an average for all species in this group.

The diet of mullet was described qualitatively in Fischer *et al.* (1987) and Billard (1997). Bennett provided diet composition data for *Sarpa salpa* from South Africa. Data for *Stephanolepis hispidus* came from Adams (1976), and is based on fish sampled off North Carolina, USA. All species were detritivores (37%) and herbivores (41%) although a small percentage of worms (1%) and other benthos (8%) were also assumed consumed.

### **Small deep-water benthic (Group 11)**

The fish in this small, non-commercial group generally inhabit depths below 200 m, are 30 to 65 cm in total length and remain close to the bottom. Although this group is labeled as small, they actually are of similar body size as the medium demersal group. They differ by their diet consisting of a high proportion of small demersals. Comprehensive data were not available for argentine (*Argentina sphyraena*), comber (*Serranus cabrilla*) and blackbelly rosefish (*Helicolenus dactylopterus*). Data were very scarce for deep-sea lizardfish (*Bathysaurus ferox*).

No estimate of biomass was available for this group. A natural mortality of  $0.352 \text{ year}^{-1}$  was used for P/B and was averaged from blackbelly rosefish and comber. The mean Q/B value of  $6.167 \text{ year}^{-1}$  was calculated using rough estimates from FishBase for blackbelly rosefish, comber and argentine.

Cohen's (1990) overview of Argentinidae provided the qualitative diet data for *Argentina sphyraena* from an unknown location. Diet composition data for *Serranus cabrilla* came from Greece (Labropoulou and Eleftheriou, 1997) and for *Helicolenus dactylopterus* from South Africa (Yap, 1988). Small deep-water benthic fish generally consumed mainly small demersals (33%) and other benthos (18%). Upon balancing the model, the proportion of lobsters in the diet had to be decreased from 3 to 0.1%, and that of small demersals to 24.9%, worms and other benthos have been augmented (Table 3), while the medium and large demersals were removed from the diet.

### **Large deep-water benthic (Group 12)**

The fish in this commercially unimportant group reach total lengths larger than 1 m. This group consisted of Kaup's arrowtooth eel (*Synaphobranchus kaupii*), rabbitfish (*Chimaera monstrosa*) and pudgy cuskeel (*Spectrunculus grandis*).

No biomass estimate was available for this group. The average P/B was calculated for all species in the group and resulted in a value of  $0.27 \text{ year}^{-1}$ . Following the same procedure, Q/B was found to equal  $2.985 \text{ year}^{-1}$ .

Detailed diet information for *Synaphobranchus kaupii* was obtained from Gordon and Mauchline (1996) from a study on the Rockall Trough in the North Atlantic and for *Chimaera monstrosa* from the Western Mediterranean (MacPherson, 1980). Only presence/absence data for *Spectrunculus grandis* were available (Mauchline and Gordon, 1984). A first approximation to a diet composition was thus obtained by dividing equally the whole diet into the groups represented. Large deep-water benthic fish fed mainly on crabs (28%), shrimps (20%), medium demersal commercial fish (11%), cephalopods (12%) and other benthos (20%).

### **Large deep-water benthic – commercial (Group 13)**

Fish in this group have the same characteristics as the large deep-water benthic fish, except that they

were caught commercially in 1984. The group includes alfonsino (*Beryx decadactylus*), wreckfish (*Polyprion americanus*), European conger eel (*Conger conger*), anglerfish (Lophiidae), black-bellied angler (*Lophius budegassa*), and angler (*Lophius piscatorius*).

Natural mortality was calculated for black-bellied angler, angler and conger eel. F was assumed to be half the natural mortality ( $0.355 \text{ year}^{-1}$ ) so a P/B value of  $0.533 \text{ year}^{-1}$  was used. Q/B was calculated for black-bellied angler, wreckfish and conger eel, yielding a mean of  $4.47 \text{ year}^{-1}$ .

Diet composition data were available from Spain for black-bellied angler, European conger eel (Olaso and Rodriguez-Marin, 1995) and angler (Velasco *et al.*, 1996). Dietary information for alfonsino was qualitative (Shimizu, 1984) and because it overlapped with other fish in the group, it was not used for the calculation. This group consumes a higher percentage of fish (63%) than the other deep-water benthic groups. Upon balancing the model, the percentage of medium demersal commercial fish and very large demersal commercial was decreased (from 63 to 28%), while medium pelagic and small sharks (group 30) were removed from the diet. To compensate, the other groups' percentages were increased (Table 3).

### **Small demersal (Group 14)**

Small demersals, while remaining close to the seafloor, inhabit shallower water than the deeper water groups (11-13 above) with some even being classified as intertidal. This large group is composed of fish smaller than 30 cm, including seargent major *Abudelduf scrutalis*, damselfish *Charis charis*, transparent goby (*Aphia minuta*), rocky goby (*Gobius paganellus*), black goby (*Gobius niger*), cardinal fish (*Apogon imberbis*), axillary wrasse (*Symphodus mediterraneus*), big-scale sand smelt (*Atherina boyeri*), scaldfish (*Arnoglossus laterna*), goldsinny wrasse (*Ctenolabrus rupestris*), longspine snipefish (*Macrorhamphosus scolopax*), Cadenat's rockfish (*Scorpaena loppei*), Madeira rockfish (*Scorpaena maderensis*) and corkwing wrasse (*Symphodus melops*).

None of these species were commercially fished and no biomass estimate was available for this group. P/B equaled natural mortality, estimated at  $1.445 \text{ year}^{-1}$ . Q/B was estimated at  $10.957 \text{ year}^{-1}$ .

Due to their small size and lack of commercial importance, relatively little is known on the diet composition of these species. Diet information







came from other countries (via FishBase), as no dietary studies were found for Morocco. The diet is dominated by other benthos (43%), shrimps (9%), crabs (8%), worms (6%) and small zooplankton (11%). Cannibalism was too high (13%) and this was halved with the remainder being allocated proportionally between the other groups (see Table 3). Upon balancing the model, the proportion of shrimps in the diet was found to be too high and was decreased to 0.9%.

### **Medium demersal (Group 15)**

This large group consists of fish from 30 to 60 cm that are not commercially caught. The group includes Mediterranean rainbow wrasse (*Coris julis*), broadnosed pipefish (*Syngnathus typhle*), dragonet (*Callionymus lyeara*), painted comber (*Serranus scriba*), cuckoo wrasse (*Labrus bimaculatus*), poor cod (*Trisopterus minutus*), fourspotted megrim (*Lepidorhombus boscii*), East Atlantic peacock wrasse (*Symphodus tinca*), European flounder (*Platichthys flesus*), lesser African threadfin (*Galeoides decadactylus*), blotched picarel (*Spicara maena*), common Atlantic grenadier (*Nezumia aequalis*), hollowsnout grenadier (*Caelorinchus caelorhincus caelorhincus*), slender rockfish (*Scorpaena elongata*) and ballan wrasse (*Labrus bergylta*). The threshold (30 cm) between small and medium demersals was based mainly on the diet, the present group consuming very small demersal fish. The lesser weever (*Trachinus vipera*) was placed in the medium demersal group along with the greater weever (*Trachinus draco*), although it is small, because 92% of its diet is 'other fish' (Gibson and Robb, 1996), assumed to be small demersals.

No biomass estimate was available for this group. P/B, assumed equal to natural mortality, was estimated at 0.69 year<sup>-1</sup>. Q/B was estimated at 8.558 year<sup>-1</sup>.

Of the 18 medium demersal fish species that diet data was available for, 10 merely provided presence/absence of food items. Table 1 highlights these data, which originate from a number of unknown locations and from North Carolina and Namibia. The diet of medium demersal (non-commercial) feeders is dominated by other benthos (32%), crabs (14%), shrimps (16%), worms (10%) and fish (15%).

### **Medium demersal – commercial (Group 16)**

Medium demersal commercial species are caught in large numbers by trawling. The group is

primarily represented by bogue (*Dentex maroccanus*), common two-banded bream (*Diplodus vulgaris*), Senegal seabream (*Diplodus bellotti*), common pandora (*Pagellus erythrinus*), axillary seabream (*Pagellus acarne*) and *Pagellus bellottii* Moroccan white seabream (*Diplodus sargus cadenati*), zebra seabream (*Diplodus cervinus cervinus*), spiny gurnard (*Lepidotrigla dieuzeidei*), longfin gurnard (*Chelidonichthys obscurus*), small red scorpionfish (*Scorpaena notata*), saddled seabream (*Oblada melanura*), and narrowhead grey mullet (*Mugil capurrii*) as well as some Mugilidae (grey mullets), Mullidae (mulletts) and Soleidae (soles). Of these, the Sparidae have traditionally constituted the most significant proportion of the catch.

The estimate of fishing mortality (1.219 year<sup>-1</sup>) published in Mennes (1985) and based on length structure estimated for *Boops boops*, *Dentex maroccanus*, *Diplodus vulgaris*, *Diplodus bellotti*, *Pagellus erythrinus*, *Pagellus acarne* and *Pagellus bellottii* was considered an overestimate. Instead, we assumed an F value of 0.6 year<sup>-1</sup>, roughly equal to natural mortality (M=0.66 year<sup>-1</sup>). Landings of 1.1149 t·km<sup>-2</sup> divided by fishing mortality result in a biomass of 1.858 t·km<sup>-2</sup>. Q/B was estimated at 7.924 year<sup>-1</sup>.

Although many of the fish in this group are common commercial species, few studies on diet composition has been found for the region (Table 1). Diet composition was very diverse in this group as 19 of the models' functional groups were represented. Other benthos, crabs, shrimps and worms composed 68% of the diet, the remainder being mostly fish (see Table 3). Upon balancing the model, cannibalism had to be reduced from 6.3% to 0.8% and the remainder redistributed to other groups (Table 3).

### **Large demersal (Group 17)**

The non-commercial large demersal group was composed of fish from 60 to 120 cm total length. Although present in catch statistics, these species are not common in Morocco. The group included parrot seaperch (*Callanthias ruber*), brill (*Scophthalmus rhombus*), common guitarfish (*Rhinobatos rhinobatos*), forkbeard (*Phycis phycis*) and red bandfish (*Cepola macrophthalmia*). Much is known about species such as orange roughy (*Hoplostethus atlanticus*) for other areas, however, since Morocco is at the extreme end of this species' North Eastern Atlantic range (Nakamura *et al.*, 1986). Few data relevant to Morocco were available.

No biomass estimate was available for this group. Natural mortality was calculated for four species yielding an averaged value of  $0.494 \text{ year}^{-1}$ . A value of  $Q/P = 7.450 \text{ year}^{-1}$  was obtained based on orange roughy, brill, red bandfish and forkbeard.

Large demersals fed primarily on shrimps and other benthos although smaller fish were also consumed. The diet information came from a wide geographical range (Table 1) and the result is that many of the species in the diet information were not indigenous to Morocco. The qualitative diet data of *Scophthalmus rhombus* was allocated as 40 % to shrimp, 20 % to crab, 20 % to other benthos and the final 20 % was split between the two medium demersal groups. *Alepocephalus bairdii* ate other benthos (60 %), zooplankton (20 %) and the 20% fish were split between medium demersal groups. *Cepola macrophthalma* diet was distributed between zooplankton (small 45 %, large 45 %), worms (5%) and other benthos (5%). Large demersals were thus assumed to consume 5% and 7.2% small and large zooplankton, 0.6% worms, 12% other benthos, 47% shrimps, 1.3% cephalopods, 10% very large demersals, and small amounts of 5 other fish groups. To balance the model, the amount of demersal fish consumed was decreased and the proportion of large invertebrates and small pelagic fish increased (Table 3).

### **Large demersal – commercial (Group 18)**

Large demersal (commercial) fish are generally caught by trawling and include canary drum (*Umbrina canariensis*), grey gurnard (*Chelidonichthys gurnardus*), false scad (*Caranx rhonchus*), common dentex (*Dentex dentex*), large-eye dentex (*Dentex macrophthalmus*), brown meagre (*Sciaena umbra*), splendid alfonso (*Beryx splendens*), blackspot seabream (*Pagellus bogaraveo*), gilthead seabream (*Sparus aurata*), bluespotted seabream (*Pagrus caeruleostictus*), John dory (*Zeus faber*), red porgy (*Pagrus pagrus*), European seabass (*Dicentrarchus labrax*), longneck croaker (*Pseudotolithus typus*), greater forkbeard (*Phycis phycis*) and European eel (*Anguilla anguilla*). The majority of the species in this group remain at the bottom in water depths greater than 10 m for their entire lives but some such as gilthead and European seabasses live in the surf zone, lagoons or up rivers, while *Caranx rhonchus* is mainly pelagic.

The value of fishing mortality ( $1.77 \text{ year}^{-1}$ ) published in Mennes (1985) and based on length structure estimated for only two species, *Dentex macrophthalmus* and *Spondyliosoma cantharus*

was considered an overestimate. Instead we assumed an F value of  $0.4 \text{ year}^{-1}$  that is, roughly equal to natural mortality ( $M=0.422 \text{ year}^{-1}$ ). Landings of  $0.8952 \text{ t}\cdot\text{km}^{-2}$  divided by fishing mortality result in a biomass of  $2.236 \text{ t}\cdot\text{km}^{-2}$ . Q/B was estimated at  $5.987 \text{ year}^{-1}$ .

Of the 26 species in this group, there were diet data for 17 fish and only 5 of these were qualitative studies (Table 1). Many of these data sets were from the coast off Spain and there can be some confidence in the diet values for this group. Diet items listed are very diverse with representatives of 17 functional groups. Shrimps (31%) dominated the diet, while sardine, small demersal and medium demersal commercial dominated the fish portion with 5-7% of the weight each. To balance the model, two prey items had to be reduced: the medium demersal commercial and small demersal sharks (group 30) to one tenth of their original proportion of the diet (Table 3).

### **Very large demersal (Group 19)**

Very large demersal were distinguished from large demersal by their extremely large size. This small group in term of biomass consists of blue ling (*Molva dypterygia*), oilfish (*Ruvettus pretiosus*), smalltooth sawfish (*Pristis pectinata*) and Mediterranean moray (*Muraena helena*).

None of these species were reported as being caught commercially and no biomass estimate was available for this group. A natural mortality estimate of  $0.157 \text{ year}^{-1}$  ( $=P/B$ ) for blue ling was used to represent the entire group. An averaged value for Q/B of  $3.881 \text{ year}^{-1}$  was calculated based on blue ling and smalltooth sawfish.

Diet information for very large demersals was qualitative and expressed in general terms. However, the work of Cohen *et al.* (1990) on blue ling and Sierra *et al.* (1994) on oilfish were sufficient to determine the importance of fish in the diets. Qualitative values were equally allocated to small demersal, medium demersal and medium demersal commercial groups (22% each), the remaining was apportioned equally between cephalopods and other benthos (16.7% each). To balance the model, the proportion of medium demersal commercial (group 16) was subsequently reduced to one tenth of the original value (Table 3).

### **Very large demersal – commercial (Group 20)**

Very large demersal commercial fish generate significant revenue, although they are not landed in vast quantities (Abdelali, 1995). Senegalese and European hakes, *Merluccius senegalensis* and *M. merluccius*, are also members of this group along with bluefish (*Pomatomus saltatrix*), dusky grouper (*Epinephelus marginatus*), goldblotch grouper (*Epinephelus costae*), silver scabbardfish (*Lepidopus caudatus*), meagre (*Argyrosomus regius*), largehead hairtail (*Trichiurus lepturus*) and greater amberjack (*Seriola dumerili*). *Merluccius senegalensis* undergoes latitudinal migration, but was here assumed to be in this area for the whole year.

Natural mortality, estimated at 0.316, plus fishing mortality yields a P/B value of 0.716 year<sup>-1</sup>. Q/B was estimated at 4.89 year<sup>-1</sup>. The fishing mortality for European hake has been estimated at 0.4 year<sup>-1</sup> (Anon., 1986). Assuming that all the species of this group are exploited at the same rate and landings of 0.716 t·km<sup>-2</sup>, biomass was estimated at 0.3937 t·km<sup>-2</sup>. This estimate was increased to 0.5 t·km<sup>-2</sup> in an attempt to account for the other species in the group.

Diet data were available for each of the five species in the group. It is notable that cannibalism within the group was caused by European hake (Guichet, 1995) and that large pelagics were consumed by the largehead hairtail (Meyer and Smale, 1991), which migrate vertically so that during the day they feed at the surface (Nakamura and Parin, 1993). Silver scabbardfish also migrate to the surface but do so during the night to feed on sardines (Meyer and Smale, 1991).

Fish of this group are assumed to consume shrimps (11.2%), cephalopods (4.4%), medium demersal commercial (13.2%) and non-commercial (10%), sardines (12%). The remaining is divided in seven other fish groups. Predation on commercial demersal fish was later reduced by about half. (Table 3).

### **Small bathypelagic (Group 21)**

Small bathypelagic fish range in length from the 2.9 cm for humpback anglerfish (*Melanocetus johnsoni*) to the 30 cm black slimehead. The group inhabits oceanic water between 200 and 1000 m and is dominated by lanternfishes (Myctophidae), but also include highlight hatchetfish (*Sternoptyx pseudobscura*), Warming's lanternfish (*Ceratoscopelus*

*warmingii*), humpback anglerfish (*Argyroteleus olfersi*), brownsnout spookfish (*Dolichopteryx longipes*) and black slimehead (*Hoplostethus cadenati*). Small bathypelagics migrate vertically, feeding on zooplankton during the night. Although they are widely distributed, little has been recorded on the precise diet or biomass for this group and the results from this group are a combination of pieces of information from many species.

Natural mortality data from FishBase were only available for three species. The value for humpback anglerfish was 3.9 year<sup>-1</sup>, which seemed high but was included in the average of 1.768 year<sup>-1</sup>. Q/B was estimated at 12.648 year<sup>-1</sup>.

There were precise diet composition data for only 2 of the 10 species in this group. Hopkins and Baird (1985) showed the stomachs of the highlight hatchetfish to contain worms, other benthos, zooplankton, bathypelagic fish and mesopelagic fish in the Gulf of Mexico. The qualitative description found for the Warming's lanternfish was similar to the latter species (Duka, 1986). Thus, 27 % was assigned to other benthos, 25 % to large zooplankton, 13 % to small zooplankton, 4% to small deep-water benthic fish, 7 % to small bathypelagic fish, 11 % to mesopelagic prey species and 3 % to phytoplankton. During the balancing process, the predation on other benthos and small deepwater (group 12) were reduced by half or more and the resulting surplus redistributed among other groups (Table 3).

### **Medium bathypelagic (Group 22)**

This group was distinguished from the small bathypelagic by generally being larger (39 cm mean length) and consuming more fish and less zooplankton. It is composed primarily of Stomiidae (viperfish and dragonfish) and Paralepididae (barracudina), but also includes hammerjaw (*Omosudis lowei*), black snake mackerel (*Nealotus tripes*), rosy dory (*Cyttopsis rosea*), longnose tapirfish (*Polyacanthonotus challengerii*), ribbon barracudina (*Arctozenus risso*), rosy dory (*Cyttopsis rosea*), Dana viperfish (*Chauliodus danae*), and Atlantic pomfret (*Brama brama*). Although Atlantic pomfret grow to 1 m total length, it was placed in this group because most pomfret caught in Morocco tend to be very small, much smaller than their maximum length (K. Erzini, University of Algarves, Portugal, pers. comm. 2000). No biomass estimate was available for this group. P/B and Q/B were estimated at 0.525 year<sup>-1</sup> and 7.482 year<sup>-1</sup>.

Of the 11 species in this group, diet data were only available for 5 of them. The stomachs of Dana viperfish (Sierra *et al.*, 1994) and the ribbon barracudina (Post, 1984) contained unidentified benthic crustaceans and fish. Black snake mackerel fed mainly on anchovies (Grove and Lavenberg, 1997). The longnose tapirfish consumed benthic and planktonic invertebrates. Atlantic pomfret consumed cephalopods, euphausiids and “bony fish” (Sierra *et al.*, 1994). The diet data for medium bathypelagic is dubious because most of them are qualitative and general (unknown locality). This group was assumed to consume 22% other benthos, 10% shrimps, 13.3% large zooplankton, 6.7% worms and 11.6% cephalopods. Unidentified fish were evenly split between small bathypelagic, small demersals and sardines. In order to balance the model, predation on other benthos and sharks was reduced by half or more and the surplus redistributed among other groups, especially small bathypelagics (Table 3).

### **Large bathypelagic (Group 23)**

Large bathypelagic fish contained roughsnout grenadier (*Trachyearincus scabrus*), common mora (*Mora moro*), slender snipe eel (*Nemichthys scolopaceus*), pelican eel (*Eurypharynx pelecanooides*) and escolar (*Lepidocybium flavobrunneum*). These species, and particularly the pelican eel, are widely distributed although none are commercially fished. Only escolar migrates vertically at night.

The biomass of large bathypelagics was not available, but was necessary to start balancing the Ecopath model. Consequently a value of 0.02 year<sup>-1</sup> was initially used, before being increased to 0.24 year<sup>-1</sup> when balancing. Natural mortality was calculated from mean generic value from FishBase, yielding a value of 0.435 year<sup>-1</sup>. Q/B was estimated at 4.34 year<sup>-1</sup>.

Qualitative stomach contents information was located for 4 of the 5 species in the group and were obtained from a wide geographical range (see Table 1). Benthic invertebrates, including cephalopods dominated the diet composition and more precisely 6% worms, 27% other benthos, and 24% cephalopods. Fish were represented by small bathypelagics (17%), medium pelagic commercial and large pelagic (7% each), and cannibalism was estimated at 14%. In order to balance the model, cannibalism had to be reduced to 2% and the remainder redistributed mostly to medium pelagic commercial and large pelagic (Table 3).

### **Mesopelagic prey species (Group 24)**

Mesopelagic prey species are very small (3-20 cm total length), numerically significant fish inhabiting high oceanic water. They are not caught commercially but are an important prey item for pelagic species. This group of 15 species is dominated by Myctophidae and Sternoptychidae, but also includes garrick (*Cyclothone braueri*), silvery cod (*Gadiculus argenteus argenteus*), veiled anglemouth (*Cyclothone microdon*), oceanic lightfish (*Vinciguerria nimbaria*) and sand smelt (*Atherina presbyter*). There are similarities between this group and small bathypelagics, but members of the latter group seem located slightly higher in the water column; more importantly, the mesopelagics are preyed upon by small bathypelagics. Myctophidae and oceanic lightfish undertake daily vertical migrations and feed at night in surface layers, hiding at depth during the daylight hours.

There was no biomass estimate available. P/B was estimated at 2.377 year<sup>-1</sup> while a Q/B value of 13.04 year<sup>-1</sup> was based on two species, silvery cod and sand smelt.

Diet data were only available for 7 of the 15 species in this group from various regions (Table 1). The qualitative diet information of *Benthosema glaciale* was equally split between large and small zooplankton and for *Atherina presbyter* went entirely to large zooplankton. The group primarily ate zooplankton (small 47%, large 26%), worms 1% and other benthos 26%. When balancing the model, this last item has been reduced to 10% and the remainder redistributed into the other groups.

### **Medium pelagic (Group 25)**

Medium pelagic fish range in size from 40-110 cm and are not commercially caught. The group is composed of derbio (*Trachinotus ovatus*), pilotfish (*Naucrates doctor*), African threadfish (*Alectis alexandrinus*), the Atlantic saury (*Scorpaenopsis saurus saurus*), the Mediterranean flyingfish (*Cheilopogon heterurus*), the Cornish blackfish (*Schedophilus medusophagus*), the slender sunfish (*Ranzania laevis*) and the driftfish (*Cubiceps gracilis*). The pilotfish has a semi-obligate commensal relationship with sharks, rays, other bony fishes and turtles (Cervigón *et al.*, 1992).

No estimate of biomass was available for this group. Using the generic values from FishBase,

P/B and Q/B were estimated at 1.31 year<sup>-1</sup> and 8.47 year<sup>-1</sup> respectively.

Diet composition data were available for the Mediterranean flyingfish from the Eastern Pacific (Lipskaya, 1987) and for the driftfish (Gorelova *et al.*, 1994) from an unknown location, both indicating that feeding was almost entirely on zooplankton. Similarly, qualitative information for saury identified their diet to consist entirely of zooplankton (Frimodt, 1995). Derby consumed unknown proportions of crab, shrimp and small bathypelagics in Senegal (Diouf, 1996) so diet values were allocated evenly between these preys. Thus, this group was assumed to consume 57% large zooplankton, 16% small zooplankton, 8% each crabs and shrimps, and 10% mesopelagics.

### **Medium pelagic - commercial (Group 26)**

This valuable commercial group consisted of Atlantic and Mediterranean horse mackerels (*Trachurus trachurus* and *T. mediterraneus*), chub mackerel (*Scomber colias*) crevalle jack (*Caranx hippos*), allis and twaite shads (*Alosa alosa* and *A. fallax*) and spotted seabass (*Dicentrarchus punctatus*), West African Spanish mackerel (*Scomberomorus tritor*) and Atlantic mackerel (*Scomber scombrus*). Mediterranean horse mackerels do spend some time amongst demersal fish but, because the majority of their biomass is in pelagic shoals (Smith-Vaniz, 1986), they have been included in this group. The Scombridae and Carangidae in this group form large shoals close to the shore (Collette and Aadland, 1996). The shads and spotted seabass remain close to the shore and are even caught in rivers (Whitehead, 1985).

No estimate of biomass was available for this group. An averaged natural mortality of 0.627 year<sup>-1</sup> was obtained from almost all species. The fishing mortality was estimated as one third of natural mortality yielding a P/B of 0.941 year<sup>-1</sup>. Q/B was estimated at 6.314 year<sup>-1</sup>.

Data on food items were available for 8 of the 9 species in the group, but comprehensive diet composition data for only 2 species, Atlantic mackerel (Wosnitza, 1975) and chub mackerel (*Scomber colias*). Both scombrids were shown to primarily consume zooplankton (Peru; Mendo, 1984). *Scomberomorus tritor* consumed only sardines (Cayré *et al.*, 1993).

Mediterranean horse mackerels feed on worms, sardines and plants (Smith-Vaniz, 1986) but worms were limited at 20% of the diet to favor pelagic species. Twaite shad consumed shrimps,

plankton and sardines (Moreira *et al.*, 1992), which we assumed had equal weight in the diet. Allis shad ate unspecified finfish, insects and benthic invertebrates (Billard, 1997). Finfish were equally apportioned to mesopelagic prey species and sardines. Atlantic horse mackerels consume zooplankton, benthic invertebrates and unspecified finfish (Frimodt, 1995). We assumed that the diet of this group was dominated by sardines (26%), and invertebrates (25%), the remaining being distributed among 6 groups of fish (see Table 3). The modifications to the diet were minor and involved decreasing the proportion of lobster in favor of zooplankton.

### **Large pelagic (Group 27)**

Large pelagic fish are restricted to the agujon needlefish (*Tylosurus acus acus*), leerfish (*Lichia amia*) and common dolphinfish (*Coryphaena hippurus*). Tunas, the other large pelagics in the model, consume both agujon needlefish and the common dolphinfish.

No estimate of biomass was available for this group and none of these fish are harvested commercially. Using generic values from FishBase yielded an average natural mortality (M) of 0.467 year<sup>-1</sup>. In absence of data, fishing mortality was assumed to equal 2/3 of M or 0.31 year<sup>-1</sup>. Thus P/B was estimated at 0.777 year<sup>-1</sup>. Q/B (=3.206 year<sup>-1</sup>) was based on common dolphinfish and leerfish.

Leerfish feed uniquely on fish (unspecified) (Bennett, 1989). The diet composition of common dolphinfishes were used as representative for the whole group (Palko *et al.*, 1982). Their diet is dominated by medium pelagic, commercial (22.6%) and non-commercial (40%), and tunas (11%). The remainder of the diet is composed of 4% large pelagics, 5% sardines, small demersal (5.6%), medium demersal (2%). The tuna had to be removed from the diet composition in favor of sardines (Table 3).

### **Sardines (Group 28)**

There are four species of Clupeidae along the coast of Morocco, the European sprat (*Sprattus sprattus*), the European pilchard (*Sardina pilchardus*), the round sardinella (*Sardinella aurita*), the Madeiran sardinella (*Sardinella maderensis*), and the European anchovy (*Engraulis encrasicolus*). The grouping of sardines in the catch data meant that all have been classified as commercially fished although the European pilchard is by far the most important pelagic species caught off Morocco. All

of the Clupeidae in this group rise to the surface at night.

The biomass of pilchard (15.53 t·km<sup>-2</sup>) was taken from Lamboeuf (1997). As sardines constitute only 88% of the group landings, the pilchard estimate was augmented proportionally to 17.647 t·km<sup>-2</sup>. A P/B value of 1.1 year<sup>-1</sup> was obtained by summing natural (0.6 year<sup>-1</sup>) and fishing mortality (0.5 year<sup>-1</sup>; García Santamaría, 1995). Q/B was estimated at 11.081 year<sup>-1</sup>.

Quantitative diet composition data for the European sprat off the Atlantic coast of England showed 100% of its diet were zooplankton (Last, 1987). Qualitative information showed that European pilchards and European anchovies consumed only zooplankton (Whitehead, 1985). Round sardinella consumed phytoplankton, zooplankton, shrimp and other benthos (Venezuela; Rincon *et al.*, 1988) while Madeiran sardinellas (Senegal; Diouf, 1996) fed on zooplankton, phytoplankton and detritus. Thus we assumed that this group consumed 44% small zooplankton, 35% large zooplankton, 7.5% other benthos, 2.5% shrimps, and 5% detritus.

### **Tunas (Group 29)**

The tunas group included yellowfin (*Thunnus albacares*), bluefin (*Thunnus thynnus*), bigeye (*Thunnus obesus*), albacore (*Thunnus alalunga*), frigate tuna (*Auxis thazard*), little tunny (*Euthynnus alletteratus*), skipjack (*Katsuwonus pelamis*), Atlantic bonito (*Sarda sarda*) as well as related species, longbill spearfish (*Tetrapturus pfluegeri*), Atlantic white marlin (*Tetrapturus albidus*), Atlantic blue marlin (*Makaira nigricans*) and swordfish (*Xiphias gladius*).

Although the majority of the species in this group are highly migratory, it was unknown how long they spend on the coast of Morocco. They were assumed to be present only 4 months. All species aside from longbill spearfish were commercially caught off the coast of Morocco. To accommodate the catches, tuna migration was set at 0.06 t·km<sup>-2</sup>·year<sup>-1</sup> for immigration and 0.06 t·km<sup>-2</sup>·year<sup>-1</sup> for emigration.

Natural mortality of 0.533 year<sup>-1</sup>, added to fishing mortality of 0.109 year<sup>-1</sup> (assessment reports, [www.iccat.es](http://www.iccat.es)) yielded a P/B value of 0.642 year<sup>-1</sup>. Q/B was estimated at 3.774 year<sup>-1</sup>. Using the catch (0.006 t·km<sup>-2</sup>·year<sup>-1</sup>) and fishing mortality, the biomass was estimated at 0.058 t·km<sup>-2</sup>.

Diet information from various oceans and localities was available for 11 of the species in this

group of 14 (see Table 1). The resulting diet for this group is quite diverse, including 21 functional groups. The most important prey items are medium pelagic commercial (14.4%), sardines (19.3%) and cephalopods (15%) (see Table 3). To balance the model, the proportion of small demersal and very large demersal commercial were decreased in favor of medium demersal commercial species (Table 3).

### **Small demersal sharks and rays-commercial (Group 30)**

Small deep dwelling sharks and rays included elasmobranchs from 40 cm to 150 cm in length living on, or close to, the sea bottom. Although some species are caught commercially their identity is uncertain which ones as most landings are not reported by species. Dogfishes (Dalatiidae) and rays (Rajidae) compose the majority of this large group, which includes catsharks (Scyliorhinidae), common crampfish (*Torpedo torpedo*), longnose spurdog (*Squalus blainville*), birddeak dogfish (*Deania calcea*), sharpnose sevengill shark (*Heptranchias perlo*), starry smooth-hound (*Mustelus asterias*), African sawtail catshark (*Galeus polli*), smooth lanternshark (*Etmopterus pusillus*), great lanternshark (*Etmopterus princeps*), cuckoo ray (*Leucoraja naevus*), spotted ray (*Raja montagui*), small-eyed ray (*R. microocellata*), smallspotted catshark (*Scyliorhinus canicula*), thornback ray (*R. clavata*) shagreen ray (*Leucoraja fullonica*), and undulate ray (*Raja undulata*).

Biomass data was not available but to initiate the balancing process, an estimated value of 0.07 t·km<sup>-2</sup> (based on other groups) was entered into Ecopath. Fishing mortality was assumed to equal natural mortality (0.329 year<sup>-1</sup>), resulting in a P/B of 0.658 year<sup>-1</sup>. A Q/B value of 5.707 year<sup>-1</sup> was calculated based on 14 of the 25 species of this group.

Diets were available for 20 fish with different level of details and in various localities (Table 1). Fish of this group consumed 20.3% shrimps, 13.2% cephalopods and 14.6% other benthic invertebrates and various other fish.

### **Large demersal sharks and rays-commercial (Group 31)**

The 20 species of this group, ranging from 150 cm to 850 cm in length, belong to 15 different families (Rajidae, Squalidae, Centrophoridae, Triakidae, Myliobatidae, Torpedinidae, Hexanchidae, Dalatiidae, Scyliorhinidae,



Squatinae, Chlamydoselachidae, Echinorhinidae, Odontaspidae, Carcharhinidae, Sphyrnidae). These were assumed to be commercially fished although there was no information to determine which members of the group were actually caught.

Using generic values from FishBase, natural mortality was estimated at  $0.157 \text{ year}^{-1}$  and fishing mortality was given a value equal to natural mortality, resulting in a P/B of  $0.32 \text{ year}^{-1}$ . The averaged Q/B value of  $3.196 \text{ year}^{-1}$  was based on 10 species. Biomass information for this group was not available but was necessary to start balancing the model using Ecopath; an estimate based on  $B = \text{Catch}/F$  was used as an initial value ( $= 0.06 \text{ t}\cdot\text{km}^{-2}$ ). Upon balancing, this was raised to  $0.2 \text{ t}\cdot\text{km}^{-2}$  to balance the model (Table 6).

The diet information for this group was based on a larger proportion of quantitative information than the preceding group (see Table 1). The diet items were distributed in 29 of the model's groups, mainly on cephalopods (23%) and other benthos (12.3%) and a combination of demersal fish (22.3%). Modifications of the diet composition were minor and consisted in decreasing predation on small sharks (group 30) to a fourth of its original value, and decreasing predation on whales (Table 3).

### ***Pelagic sharks – commercial (Group 32)***

This group included 12 species among which are sandbar shark (*Carcharhinus plumbeus*), blue shark (*Prionace glauca*), porbeagle (*Lamna nasus*), shortfin mako (*Isurus oxyrinchus*), hammerhead (*Sphyrna lewini*), dusky shark (*Carcharhinus obscurus*), oceanic whitetip shark (*Carcharhinus longimanus*), thintail thresher (*Alopias vulpinus*) and basking shark (*Cetorhinus maximus*). Their body lengths range from 250 cm to 980 cm. They inhabit the pelagic to mesopelagic zone although the sandbar shark and the oceanic whitetip shark can go to very deep water. The sharks are highly migratory but little information was known concerning their migratory patterns around Morocco or their biomass. They are fished commercially off the coast of Morocco. The sharks in this group have a high trophic level of 4.0-4.5 except for the basking shark which feeds more like a baleen whale but cannot be placed in the 'whale' group because its Q/B and P/B ratios are considerably different. It was kept in this group because it was not deemed significant enough either to be placed in a group of its own.

Because sharks were thought to be strongly exploited, fishing mortality was estimated to be equal to natural mortality ( $0.182 \text{ year}^{-1}$ ) for a total mortality of  $0.36 \text{ year}^{-1}$  ( $=P/B$ ). A biomass estimate was not available for this group so a value of  $0.05 \text{ t}\cdot\text{km}^{-2}$  (based on the ratio  $\text{Catch}/F$ ) was used. The value was increased to  $0.2 \text{ t}\cdot\text{km}^{-2}$  to balance the model. Q/B was estimated at  $2.574 \text{ year}^{-1}$ .

Quantitative diet composition data were available for *Carcharhinus plumbeus* (Northeast Atlantic Stillwell and Kohler, 1993), *Carcharhinus brachyurus* and *Carcharhinus obscurus* (South Africa Smale, 1991) and *Isurus oxyrinchus* (Northwest Atlantic Stillwell and Kohler, 1982). These data indicated quite a range of prey types for *Carcharhinus plumbeus*, which consumes both benthic and pelagic prey. Cephalopods were abundant in the stomachs of *Carcharhinus* and *Isurus* species, along with sardines, and it is noteworthy that although these sharks are pelagic, they do not remain at the surface all of the time like the medium pelagic group. The remainder of the diet information was largely qualitative (Cortés, 1999) and the unidentified fish were equally allocated to the medium deep-water benthic, large deep-water benthic, medium demersal, very large demersal commercial, medium pelagic commercial and sardines. This reflected the lack of information concerning the position in the water column these sharks were feeding at. The basking shark consumed 100% large zooplankton (Cortés, 1999). The final diet composition for this group was cephalopods (26.4%), sardines (12.1%) and very large demersal commercial (13%) as the main dietary components. Modifications of the diet composition upon model balancing were minor and consisted in decreasing predation on small sharks (group 30) to a fourth of its original value, and decreasing predation on whales (Table 3).

### ***Cephalopods (Group 33)***

Cephalopods are commercially important off the coast of Morocco and catches of octopus (*Octopus vulgaris*), cuttlefish (*Sepia officinalis hierredda*) and squid (*Loligo vulgaris*) significantly increased after the 1960s (Balguerías *et al.*, 2000). Also included in this group is the broadtail short-fin squid (*Illex coindetii*).

Estimates of biomass were not available for this group. P/B was assumed to 3.1 based on a similar group in a Caribbean model (Opitz, 1993). This value is similar to the value estimated for *Octopus vulgaris* in the Azores (Gonçalves, 1991). Q/B ( $11.7 \text{ year}^{-1}$ ) was also taken from Opitz (1993).

The diet information was exclusively qualitative for this group. *Illex coindetii* consumed other benthos, worms, shrimps, large and small zooplankton, small demersal fish, medium demersal commercial fish, small and large bathypelagic fish, medium pelagic commercial fish, sardines and other cephalopods (Sánchez *et al.*, 1998). *Octopus vulgaris* preyed on other benthos, crabs, shrimps, very large demersal commercial fish, small and medium bathypelagic fish and cephalopods (Guerra, 1978). *Loligo vulgaris* consume other benthos, shrimps, crabs, medium pelagic commercial fish and cephalopods were eaten (Baddy, 1989). *Sepia officinalis* ate other benthos, worms, shrimps, small zooplankton, detrital feeding fish, medium demersal commercial fish and cephalopods. Only *Sepia officinalis heirredda* was not cannibalistic (Boletzky and Hanlon, 1981). Cephalopods were assumed to consume 16% each of shrimps, crabs and other benthos, 13% of cephalopods (cannibalism). The remaining was distributed among zooplankton and 10 groups of fish. Cannibalism had to be reduced to 3.3% during the process of balancing the model.

### **Turtles (Group 34)**

There was a large degree of uncertainty about the distribution of turtles off Morocco. General information was obtained from the Azores model (Guénette and Gomez, this volume) and [www.exeter.ac.uk/telematics/EuroTurtle](http://www.exeter.ac.uk/telematics/EuroTurtle). The website suggested that the loggerhead sea turtle (*Caretta caretta*), the green turtle (*Chelonia mydas*), the leatherback turtle (*Lepidochelys kempii*) and Kemp's Ridley turtle (*Dermochelys coriacea*) should be seasonally present, although there was no information indicating the length of time spent off Morocco. The loggerhead is known to spend their juvenile stage (8 years) in the Northeast Atlantic, transported by the Gulf Stream from Florida (Bolten *et al.*, 1998; Riewald *et al.*, 1999). They are included in the model but nothing specific to Morocco is known about them.

A very low 'guesstimate' of biomass, 0.005 t·km<sup>-2</sup> was used. P/B and Q/B values of 0.15 year<sup>-1</sup> and 3.5 year<sup>-1</sup> were taken from the Azores model for the loggerhead turtle (Guénette and Gomez, this volume). Turtles, represented by the loggerheads, were assumed to feed entirely on large zooplankton, i.e., jellyfish (H. Martins, Dept. of Fisheries and Oceanography, University of the Azores, Portugal, pers. comm.).

### **Seabirds (Group 35)**

The following species are known to inhabit the coast of Morocco (E. Balguerías, Institute of

Oceanography, Canaries, pers. comm.) and were thus included in this model: great shearwater (*Puffinus gravis*), Leach's storm-petrel (*Oceanodroma leucorhoa*), gannet (*Morus bassanus*), pomarine skua (*Stercorarius pomarinus*), Arctic skua (*Stercorarius parasiticus*), long-tailed skua (*Stercorarius longicaudus*), great skua (*Catharacta skua*), common tern (*Sterna hirundo*), great cormorant (*Phalacrocorax carbo*), little gull (*Larus minutus*), black-headed gull (*Larus ridibundus*) and shag (*Phalacrocorax aristotelis*). Only the two *Phalacrocorax* species were thought to be permanent residents in the area; the others were either known, or assumed, to be non-breeding visitors. There are almost certainly other seabird species in our study area, but either there was too little information available about them to be considered, or they were only found in the area for a very short time each year.

As a first estimate, the biomass was assumed equal to 25% of the bird biomass in a similar upwelling area off Peru (Jarre-Teichmann and Pauly, 1993). Assuming that our study area would be similar to that of Mauritania, we used the same biomass estimate of 0.015 t·km<sup>-2</sup> for our seabird functional group. P/B (=0.04 year<sup>-1</sup>) was taken from the Azores model (Guénette and Gomez, this volume).

Seabird consumption was derived from the equation

$$\log R = -0.293 + 0.85 \log W \quad \dots 1)$$

where R is the daily ration and W is the bird weight, both in grams (Nilsson and Nilsson, 1976, in Wada, 1996). This value was divided by the mass of the bird and multiplied by 365 days to calculate an annual Q/B value. The Q/B value of 52.143 year<sup>-1</sup> was based on great cormorant and common tern.

The diet information is based on great shearwater (Prince and Morgan, 1987) and great cormorant (Gremillet *et al.*, 1999). For great cormorant, unidentified fish were assumed to be sardines. It was assumed that for great shearwater, the "major" dietary component accounted for 40 %, the "moderates" for 25 % and the "minor" for 10 %. Of the 25 % of fish, 10 % were allocated to sardines and 15 % to small demersals. The diet of this group was dominated by mesopelagic prey species, small demersals and cephalopods, which altogether accounted for more than 60 % of the diet.

### Baleen whales (Group 36)

Based on distribution maps provided in Carwardine (1995), we included the following species in our baleen whale group: sei whale (*Balaenoptera borealis*), fin whale (*B. physalus*), humpback whale (*Megaptera novaeangliae*), and Bryde's whale (*B. edeni*). Minke whales (*Balaenoptera acutorostrata*) were added to match records from the data base constructed within the *Sea Around Us* project (Kaschner *et al.*, 2001).

Relative biomasses were taken from the data base constructed within the *Sea Around Us* project (Kaschner *et al.*, 2001). All biomasses were adjusted with the fraction of the year they were thought to be present in the area based on their habitat preferences and their migration patterns (Table 4). Natural mortality was estimated at 0.02 year<sup>-1</sup> (Trites and Heise, 1996). The daily consumption per animal (R) was calculated using the formula of Innes *et al.* (1987):

$$R = 0.1 * W^{0.8} \quad \dots 2)$$

where W is mean body weight in kg; R is the ration in kg/day. The daily rate was multiplied by 365 days to obtain the annual consumption rate and divided by the body weight (Trites and Pauly, 1998) to obtain a Q/B of 4.652 year<sup>-1</sup>.

Baleen whales feed primarily on large zooplankton like euphausiids and pelagic crustaceans (Pauly *et al.*, 1998). Their diet is dominated by large zooplankton (71%). General diet items from this source have been attributed to relevant functional groups in the following manner: small pelagics (9%) were apportioned into groups 25, 26, and 28; mesopelagics (6%) into groups 21 and 24; and miscellaneous fish to demersal fish of the groups 14 to 16. Small squids constitute only 2% of the diet.

**Table 4.** Estimated biomass and residence time off Morocco for baleen whales

Species	Biomass (t·km <sup>-2</sup> ) <sup>a</sup>	Residence time (days)
Minke	0.0012	20
Bryde's	0.0001	90
Sei	0.0003	90
Blue	0.0002	90
Humpback	0.0012	60
Fin	0.0270	90
<b>Total</b>	<b>0.0309</b>	<b>-</b>

<sup>a</sup>Adjusted for period spent in the area.

### Toothed whales and dolphins (Group 37)

Distribution maps in Carwardine (1995) showed the following toothed whale and dolphin species spending at least part of the year in Morocco: sperm whale (*Physeter macrocephalus*), short-finned pilot whale (*Globicephala macrorhynchus*), common dolphin (*Delphinus delphis*), striped dolphin (*Stenella coeruleoalba*), Cuvier's beaked whale (*Ziphius cavirostris*), Risso's dolphin (*Grampus griseus*), bottlenose dolphin (*Tursiops truncatus*), harbour porpoise (*Phocoena phocoena*), false killer whale (*Pseudorca crassidens*), and killer whale (*Orcinus orca*).

The biomass of each species in Morocco was estimated based on the distribution maps given in Carwardine (1995) and Kaschner *et al.* (2001). The estimated number of whales was multiplied by the average body mass (Trites and Pauly, 1998) and weighted according to the number of days these species were thought to reside in the area (Table 5). This led to a total biomass estimate of 0.0536 t·km<sup>-2</sup>. P/B was assumed to be 0.07 year<sup>-1</sup> (Trites and Heise, 1996). Q/B was estimated at 12.116 year<sup>-1</sup> following the same procedure as for the previous group.

**Table 5.** Estimated biomass and residence time off Morocco for toothed whales

Species	Biomass (t·km <sup>-2</sup> )	Residence (days)
Sperm whales	0.0176	60
Long-finned pilot whale	0.0406	182
Short-finned pilot whale	0.0007	90
Common dolphin	0.0005	182
Striped dolphins	0.0001	7
Cuvier's beaked whale	0.0007	180
Pantropical spotted dolphin	0.0001	90
Northern bottlenose whale	0.0005	180
Risso's dolphin	0.0011	365
Bottlenose dolphin	0.0005	180
Harbour porpoise	0.00006	180
False killer whale	0.00002	90
Killer whale	0.00007	90
<b>Sum</b>	<b>0.062</b>	<b>-</b>

Diet data were available for four species of dolphin: common, striped, Risso's and bottlenose, and for Cuvier's beaked whale, false killer whale, and sperm whale (Trites and Pauly, 1998). Cephalopods were the primary diet item (51 %). General diet items from this source have been attributed to relevant functional groups in the following manner: small pelagics (6%) were

apportioned into groups 25, 26, and 28; mesopelagics (13%) into groups 21, 22 and 24; miscellaneous fish (24%) to demersal fish of the groups 14 to 16 and small portion to group 17; and benthic invertebrates into groups 5, 7 and 8. Marine mammals contributed 2.9% to the initial

diet, which was considered too high and prevented us from balancing the model. Thus, the percentage of marine mammals in the diets had to be reduced to 0.5% apportioned to the two groups of whales and the remainder divided among the groups of fish (Table 2).

**Table 6.** Matrix of parameters after balancing. Parameters estimated by the model are in **bold**.

Group name	Trophic level	Biomass (t·km <sup>-2</sup> )	P/B (yr <sup>-1</sup> )	Q/B (yr <sup>-1</sup> )	EE	P/Q
1 Primary producers	1.0	102.459	84.551	-	<b>0.32</b>	-
2 Sm. zooplankton	2.0	20.2	25	90.4	<b>0.59</b>	<b>0.277</b>
3 Lg. zooplankton	2.2	<b>56.304</b>	6	25	0.95	<b>0.24</b>
4 Worms	2.0	<b>21.963</b>	2	22.2	0.95	<b>0.09</b>
5 Other benthos	2.0	<b>155.756</b>	1.55	9.4	0.95	<b>0.165</b>
6 Predatory echinoderms	2.8	<b>2.510</b>	1.1	4.44	0.95	0.248
7 Crabs	2.5	<b>12.414</b>	1.8	10	0.95	<b>0.18</b>
8 Shrimp	2.5	<b>28.369</b>	1.7	<b>11.333</b>	0.95	0.15
9 Lobsters	3.2	<b>1.876</b>	0.282	5.85	0.95	<b>0.048</b>
10 Detrital feeders	2.1	<b>0.326</b>	0.552	7.161	0.95	<b>0.077</b>
11 Sm. deep water benthic	3.4	<b>3.054</b>	0.352	6.167	0.95	<b>0.057</b>
12 Lg. deep water benthic	3.6	<b>0.225</b>	0.27	2.985	0.95	<b>0.09</b>
13 Lg. deep water comm.	4.0	<b>0.109</b>	0.533	4.47	0.95	<b>0.119</b>
14 Sm. demersal	2.8	<b>12.302</b>	1.445	10.957	0.95	<b>0.132</b>
15 Med. demersal	3.1	<b>5.591</b>	0.69	8.558	0.95	<b>0.081</b>
16 Med. demersal comm.	3.2	1.858	1.26	7.921	<b>0.96</b>	<b>0.159</b>
17 Lg. demersal	3.4	<b>1.900</b>	0.494	7.45	0.95	<b>0.066</b>
18 Lg. demersal comm.	3.4	2.236	0.822	5.987	<b>0.64</b>	<b>0.137</b>
19 V. lg. demersal	3.9	<b>0.395</b>	0.157	3.881	0.95	<b>0.04</b>
20 V. lg. demersal comm.	4.1	0.5	2.305	4.887	<b>0.93</b>	<b>0.147</b>
21 Sm. bathypelagic	3.3	<b>3.632</b>	1.768	12.648	0.95	<b>0.14</b>
22 Med. bathypelagic	3.8	<b>0.290</b>	0.525	7.482	0.95	<b>0.07</b>
23 Lg. bathypelagic	4.0	0.240	0.435	4.34	<b>0.86</b>	<b>0.1</b>
24 Mesopelagic prey	3.1	<b>5.719</b>	2.377	13.036	0.95	<b>0.182</b>
25 Med. pelagic	3.3	<b>3.025</b>	1.131	8.471	0.95	<b>0.134</b>
26 Med. pelagic comm.	3.5	<b>6.396</b>	0.941	6.314	0.95	<b>0.149</b>
27 Lg. pelagic	4.2	<b>2.321</b>	0.777	3.206	0.95	<b>0.242</b>
28 Sardines	2.9	17.647	1.1	11.081	<b>0.99</b>	<b>0.099</b>
29 Tunas	4.3	0.058	0.642	3.774	<b>0.66</b>	<b>0.17</b>
30 Sm. demersal sharks/rays	3.8	0.329	0.658	5.707	<b>0.89</b>	<b>0.115</b>
31 Lg. demersal sharks/rays	4.1	0.20	0.32	3.196	<b>0.84</b>	<b>0.1</b>
32 Pelagic sharks	4.3	0.20	0.36	2.574	<b>0.72</b>	<b>0.14</b>
33 Cephalopods	3.5	<b>2.112</b>	3.1	11.7	0.95	<b>0.265</b>
34 Turtles	3.2	0.005	0.15	3.5	<b>0.09</b>	<b>0.043</b>
35 Seabirds	4.0	0.015	0.04	52.143	<b>0.09</b>	<b>0.001</b>
36 Baleen whales	3.5	0.031	0.176	4.652	<b>0.20</b>	<b>0.004</b>
37 Toothed whales/dolphins	4.4	0.062	0.02	12.116	<b>0.23</b>	<b>0.006</b>
38 Detritus	1.0	-	-	-	<b>0.35</b>	-

## THE FISHERY

This section gives a brief description of the fisheries occurring along the coast of Morocco. Baddy and Guénette (2001) provide more details on the fishery and its catch.

The Moroccan fishery, previously a purely small scale affair, began to expand in the 1920s, under French influence. Nowadays, the fishing industry is economically significant for Morocco, providing 60,000 jobs and accounting for 45 % of agricultural exports in 1994 (Abdelali, 1995). The small-scale fishery relies on small wood dories, now motorized, which use a broad range of gear and catch various species depending on stock availability. Their catches are landed fresh or preserved on ice. The coastal fleet consists of wooden boats that usually stay out less than three days because they often lack refrigeration and storage facilities. Their main target species are small pelagics (sardines, mackerel, anchovies and horse mackerel) and some trawlers are equipped to catch demersal fish and cephalopods (Abdelali, 1995) The industrial fleet started in the 1970s and increased rapidly in size until 1998. The fleet consists of large bottom trawlers mainly targeting demersal fish and cephalopods.

Spanish vessels, based in the Canaries as well as continental Spain, have been fishing the Moroccan coast since the fifteenth century

(Balguerías *et al.*, 2000). In addition to the Spanish, Asian, west African and eastern European (mainly Russian) vessels were very active along the coast. The foreign fleet target both pelagic and demersal species. Since 1975, when Morocco annexed the former Spanish Sahara, fishing activities of the foreign fleet became increasingly confined to the southern part of the Sahara and have since been almost totally displaced by the growing Moroccan fishing industry.

## Allocating catches to functional groups

The raw landing data obtained from Baddy and Guénette (2001) were allocated in each functional group according to the procedure outlined in Tables 7 to 9. First, the catch data (Table 9) that could obviously be assigned to a single functional group in the model are listed in Table 7. The other groups were apportioned to functional groups according to the rules described in Table 8. Generally, the landings of a given group was allocated to the pertinent functional groups proportionally to their importance, defined by the landings allocated to them as described in Table 8. In absence of data, 60% of unspecified shark catches were attributed to small demersal sharks and rays (Group 30) and the remainder was equally divided between the large demersal sharks and rays (Group 31) and the Pelagic sharks (Group 32).

**Table 7.** List of the functional groups to which the landing is directly attributable. The line number referred to the raw landing data in table 9.

Code	Functional group	Origin of catch data (in table 9)
A	Primary production	Line 7.
B	Other benthos	Line 111.
C	Crabs	Line 17.
D	Shrimps	Line 134.
E	Lobsters	Line 57.
F	Detrital feeders ( <i>Det. /herb</i> )	Line 23.
G	Large deep-water benthic commercial ( <i>LdeepbenthC</i> )	Line 27.
H	Medium demersal commercial ( <i>MdemC</i> )	Line 91.
I	Large demersal commercial ( <i>LdemC</i> )	Line 53.
J	Very large demersal commercial ( <i>VLdemC</i> )	Line 53.
K	Medium bathypelagic ( <i>Mbathypel</i> )	Line 65.
L	Medium pelagic commercial ( <i>MpelC</i> )	Line 109.
M	Large pelagic commercial ( <i>LpelC</i> )	Line 61.
N	Sardines	Line 121.
O	Tunas	Line 143.
P	Small demersal sharks and rays ( <i>Sdeepsharkray</i> )	Line 127.
Q	Pelagic sharks ( <i>Pelsharkray</i> )	Line 115.
R	Cephalopods	Line 14.

**Table 8.** Rules for allocating the catch to functional groups.

Catch group	Line <sup>a</sup>	Allocation to functional groups <sup>b</sup>	Comments
Crustacea	19	= Line 19 * C/(C+D+E)	Catch split proportionally to the reported catch between crabs, shrimps and lobsters.
Marine animals	4	= Line 4 * D/(D+E+H+I+J+R)	Catch split proportionally on the basis of the coastal catch of shrimp, lobsters, demersal fish and cephalopods.
Mugilidae	23	75 % to detrital feeders (F) 25% to medium demersal commercial (H)	The majority of the Mugilidae are in the detrital feeders group so a high percentage of the catch was allocated there.
Beryx	51	= Line 51 * G/(G+I)	The catch was split proportionally between large deep-water benthic commercial and large demersal commercial because there was one species in each.
A mixed demersal group	96	= Line 96 * H/(H+I)	<i>Dentex</i> spp., Sparidae, Soleidae and Pleuronectiformes were present in two functional groups so the catch was split proportionately
Gadiformes	98	= Line 98 * H/(H+I+J)	'Gadiformes' includes species in medium, large and very large demersal commercial groups so the catch is split proportionally between these.
Demersal fish	4	= Line 4 * H/(H+I+J)	The catch was split proportionally
Marine fish	3	= Line 63 * H/(F+G+H+I+J+K+L+M+N+O+P+Q)	The catch was split proportionally between all fin-fish functional groups.
Elasmobranchii	123	= 60% of Line 123 to small demersal sharks and rays. = 20% to large demersal sharks and rays. = 20% to pelagic sharks.	'Elasmobranchii' could not be split proportionately because there were no catch data for large demersal sharks. Hence it was assumed that 60 % of the catch would be small demersal sharks and rays and both large demersal sharks and pelagic sharks would receive 20%.
Total sharks	129	= 60% of Line 126 to small demersal sharks and rays. = 20% to large demersal sharks and rays. = 20% to pelagic sharks.	"Total sharks" were allocated identically as the "Elasmobranchii" above.
Total Rays	125	same as the preceding	

<sup>a</sup>Line identification from table 9;<sup>b</sup>letters refers to codes in table 7.

**Table 9.** Original landing data by functional group from Baddy and Guénette (2001). Abbreviations follow the same system as in Table 7.

Line	Groups	Species	Artisanal	Coastal	Industrial	Foreign
1	Plants	Marine animals nei	5119.9			
<b>2</b>		<b>Total plants</b>	<b>5119.9</b>			
3	Unidentified fish	Demersal fishes nei			5210	
<b>4</b>		<b>Total unident.</b>			<b>5210</b>	
5	Benthic plants	<i>Celidium graciliaris</i>	4590			
6		<i>Laminaria</i> spp	600			
<b>7</b>		<b>Total Benthic plants</b>	<b>5190</b>			
8	Cephalopods	<i>L.vulgaris, S.officinalis, O.vulgaris</i>		3316		
9		Loliginidae, Ommastrephidae			3316	700
10		<i>Loligo</i> spp				32
11		Octopodidae			31082	2876
12		<i>Octopus vulgaris</i>				37818
13		Sepiidae, Sepiolidae			11306	8605
<b>14</b>		<b>Total cephalopods</b>		<b>3316</b>	<b>45704</b>	<b>50031</b>
15	Crabs	<i>Brachyura</i>				50
16		<i>Maja squinado</i>		12		
<b>17</b>		<b>Total crabs</b>		<b>12</b>		<b>50</b>
18	Crustaceans	crabs; shrimp; lobsters				1366.2
<b>19</b>		<b>Total crustaceans</b>				<b>1366.2</b>
20	Detrit/ herb	<i>Mugil cephalus</i>				12
<b>21</b>		<b>Total Detrit/ herb</b>				<b>12</b>
22	Detrit/ herb; MdemC	Mugilidae		339		643
<b>23</b>		<b>Total Detrit/ herb; MdemC Total</b>		<b>339</b>		<b>643</b>
24	LdeepwbottC	<i>Conger conger</i>		1975		130
25		Lophiidae		192		417
26		<i>Polyprion americanus</i>	293.2			
<b>27</b>		<b>Total LdeepwbenthC</b>	<b>293.2</b>	<b>2167</b>		<b>547</b>
28	LdemC	<i>Anguilla anguilla</i>		2		
29		<i>Argyrosomus regius</i>		2498		
30		Ariidae				1185
31		<i>Campogramma glaycos</i>	0.6			
32		<i>Caranx rhonchus</i>				2075
33		<i>Dentex dentex</i>			4591	45
34		<i>Dentex gibbosus</i>	554			
35		<i>Dentex macrophthalmus</i>	0			5814
36		<i>Lepidorhombus whiffiagonis</i>				326
37		<i>Pagrus caeruleostictus</i>	1.6			
38		<i>Pagrus pagrus</i>	5		4473	376
39		<i>Pagrus</i> spp		14		34
40		<i>Phycis blennoides</i>				165
41		<i>Pseudolithus senegalensis</i>				5
42		<i>Pseudolithus</i> spp				2166
43		Sciaenidae				471
44		<i>Solea solea</i>			1648	6899.2
45		<i>Sparus aurata</i>	0	217		64
46		<i>Spondyliosoma cantharus</i>	219.7	78		
47		<i>Umbrina cirrosa</i>				1
48		<i>Zeus faber</i>	0.1	172		9
<b>49</b>		<b>Total LdemC</b>	<b>781</b>	<b>2981</b>	<b>10712</b>	<b>19635.2</b>
50	LdemC LdeepbottC	Beryx				90
<b>51</b>		<b>Total LdemC LdeepbenthC Total Ldeep</b>				<b>90</b>
52	LdemC	<i>Pseudocaranx dentex</i>	0			

<b>53</b>		<b>Total LdemC</b>	<b>0</b>		
54	Lobsters	<i>Homarus gammarus</i>		23	
55		<i>Nephrops norvegicus</i>		15	117
56		<i>Palinurus spp</i>		68	192
<b>57</b>		<b>Total Lobsters</b>		<b>106</b>	
58	Lpel	<i>Lichia amia</i>			1087
59		<i>Rachycentron canadum</i>			64
60		<i>Sphyræna spp</i>	0		237
<b>61</b>		<b>Total Lpel</b>	<b>0</b>		<b>1388</b>
62	Marine fishes nei	Marine fishes nei		57615	50261.2
<b>63</b>		<b>Total Marine fishes nei Total</b>		<b>57615</b>	<b>50261.2</b>
64	Mbathypel	<i>Brama brama</i>	0		201
<b>65</b>		<b>Total Mbathypel</b>	<b>0</b>		<b>201</b>
66	MdemC	<i>Boops boops</i>		717	1860
67		<i>Brachydeuterus auritus</i>			88
68		<i>Cynoglossidae</i>			412
69		<i>Dentex angolensis</i>			0.2
70		<i>Diplodus sargus</i>			1177
71		<i>Diplodus spp</i>	4.9	650	1
72		<i>Diplodus vulgaris</i>	18.8		
73		<i>Haemulidae (=Pomadasyidae)</i>		371	235.2
74		<i>Lutjanidae</i>			48
75		<i>Macroramphosus scolopax</i>			12398
76		<i>Mullus spp</i>		123	54
77		<i>Pagellus acarne</i>	1.6		50
78		<i>Pagellus bellottii</i>			493
79		<i>Pagellus erythrinus</i>			267
80		<i>Pagellus spp</i>		3023	510
81		<i>Perciformes</i>			3637
82		<i>Plectorhinchus mediterraneus</i>	211.8		
83		<i>Pomadasys incisus</i>	0		
84		<i>Pseudolithus elongatus</i>			425
85		<i>Scorpaena scrofa</i>	0.3		
86		<i>Scorpaenidae</i>		171	20
87		<i>Stromateus fiatola</i>			4
88		<i>Trachurus trecae</i>			3142
89		<i>Triglidae</i>	1	912	381
90		<i>Trisopterus luscus</i>		1660	
<b>91</b>		<b>Total MdemC</b>	<b>238.4</b>	<b>7627</b>	<b>1589</b>
92	MdemC LdemC	<i>Dentex spp</i>			882
93		<i>Pleuronectiformes</i>		980	687
94		<i>Soleidae</i>		529	1145
95		<i>Sparidae</i>	3.2		1531
<b>96</b>		<b>Total MdemC LdemC</b>	<b>3.2</b>	<b>1509</b>	<b>2218</b>
97	MdemC LdemC	<i>Gadiformes</i>			800
<b>98</b>		<b>Total MdemC LdemC VLdemC</b>			<b>800</b>
99	MdemC	<i>Polynemidae</i>			76
<b>100</b>		<b>Total MdemC</b>			<b>76</b>
101	MpelC	<i>Alosa spp</i>		17	
102		<i>Caranx hippos</i>			0.2
103		<i>Caranx spp</i>			2
104		<i>Perciformes</i>			55
105		<i>Scomber japonicus</i>	20	127348	77722
106		<i>Scombroidei</i>	0.1		501
107		<i>Trachurus spp</i>		8996	180598
108		<i>Trachurus trachurus</i>			2193



<b>109</b>		<b>Total MpelC</b>	<b>20.1</b>	<b>136361</b>		<b>261071.2</b>
110	Other benthos	Mollusca	24			73.4
<b>111</b>		<b>Total other benthos</b>	<b>24</b>			<b>73.4</b>
112	pelagic	<i>Selene dorsalis</i>				1
<b>113</b>		<b>Total pelagic</b>				<b>1</b>
114	Pelsharkray	<i>Isurus oxyrinchus</i>	0			
<b>115</b>		<b>Total Pelsharkray</b>	<b>0</b>			
116	Sardines	<i>Engraulis encrasicolus</i>		10676	58	22640
117		<i>Sardina pilchardus</i>		150766	5742	371047
118		<i>Sardinella aurita</i>				30888
119		<i>Sardinella maderensis</i>				676
120		<i>Sardinella spp</i>				3549
<b>121</b>		<b>Total Sardines</b>		<b>161442</b>	<b>5800</b>	<b>428800</b>
122	Sdeepdwshark	Elasmobranchii	16.9	824		1628
<b>123</b>		<b>Total Sdeepdwshark Ldeepdwshark Pels</b>	<b>16.9</b>	<b>824</b>		<b>1628</b>
124	Sdeepdwsharkray	Rajiformes		1092		
<b>125</b>		<b>Total Sdeepdwsharkray</b>		<b>1092</b>		
126	Sdeepsharkray	<i>Mustelus spp</i>	0.2			
<b>127</b>		<b>Total Sdeepsharkray</b>	<b>0.2</b>			
128	Sharks	Selachimorpha(Pleurotremata)				490
<b>129</b>		<b>Total Sharks</b>				<b>490</b>
130	Shrimp	Natantia				334
131		<i>Parapenaeopsis atlantica</i>				430
132		<i>Parapenaeus longirostris</i>		1376		5152
133		<i>Penaeus kerathurus</i>				175
<b>134</b>		<b>Total shrimp</b>		<b>1376</b>		<b>6091</b>
135	Tunas	<i>Auxis thazard</i>		198		
136		<i>Euthynnus alletteratus</i>		15		
137		<i>Katsuwonus pelamis</i>	2	885		
138		<i>Sarda sarda</i>		310		
139		<i>Thunnus albacares</i>	6.5	614		
140		<i>Thunnus obesus</i>		120		
141		<i>Thunnus thynnus</i>		171		
142		<i>Xiphias gladius</i>		81		
<b>143</b>		<b>Total Tunas</b>	<b>8.5</b>	<b>2394</b>		
144	VLdemC	<i>Epinephelus aeneus</i>				120
145		<i>Epinephelus spp</i>				5
146		<i>Merluccius merluccius</i>		2124		8920
147		<i>Merluccius polli + M. senegalensis</i>				4872
148		<i>Merluccius senegalensis</i>			5121	9107
149		<i>Merluccius spp</i>				154
150		<i>Muraena helena</i>	8.1			
151		<i>Pomatomus saltatrix</i>	0	130		1862
152		Serranidae				1
153		<i>Trichiurus lepturus</i>		153		20021
		<b>Total VLdemC</b>	<b>8.1</b>	<b>2407</b>	<b>5121</b>	<b>45062</b>

Unreported landings in the 1980s represented 23% of the total landings (Baddy and Guénette, 2001), as based on estimates from each functional group. Discard rates, given as the percentage of the total catch, were taken from Baddy and Guénette (2001). The artisanal fishery was assumed to have no discards, as all its catch is used (Baddy and Guénette, 2001). A discard rate of 3 % of the total catch was applied to small pelagics (sardines) caught by the coastal fleet. The coastal demersal fishery was assigned a rate of 12%, while foreign and industrial demersal fleets were assigned discard rates of 30%. In absence of detailed studies on the specific composition of discards that could be extrapolated to the entire demersal fishery, we assumed that half the discards were non-commercial functional groups including benthos, in equal quantities. The other half was allocated to the commercial functional groups in proportion of their catch.

### **BALANCING THE MODEL**

Before beginning to balance the model, guesstimates of biomass were entered for the following functional groups: very large demersal ( $0.02 \text{ t}\cdot\text{km}^{-2}$ ), large bathypelagic ( $0.02 \text{ t}\cdot\text{km}^{-2}$ ), tunas ( $0.04 \text{ t}\cdot\text{km}^{-2}$ ), small demersal sharks and rays ( $0.03 \text{ t}\cdot\text{km}^{-2}$ ), large demersal sharks ( $0.01 \text{ t}\cdot\text{km}^{-2}$ ) and pelagic sharks ( $0.04 \text{ t}\cdot\text{km}^{-2}$ ). They were all subsequently adjusted.

When attempting to balance the model, many of the Ecotrophic Efficiencies were greater than 1 meaning that more of the group was being consumed than produced, and thus had to be reduced. The main source of that problem reside in the allocation of prey items based on qualitative diets or to the species chosen to represent the functional groups. Also some estimates of biomass based on guesses or dubious data were modified (e.g. Mesopelagic prey species). In this sense, the balancing process leaves much to the discretion of the modeler. The resulting parameters are presented in Table 6.

### **DISCUSSION**

The Ecopath model presented here summarizes much of the information that is available on the Moroccan marine ecosystem. It gives an indication of the relationships between 38 functional groups and of the influence that fishing has on the ecosystem. It is by no means a finished model and there are a number of recommendations made below that should result in a future model reflecting the ecosystem more accurately.

Biomass data were very scarce and only the estimates for primary producers, small zooplankton, large demersal commercial, sardines and seabirds could be entered into the model and left unchanged. During balancing, it was necessary to guess biomasses for many groups and this meant there was little anchorage to the model. A data deficiency in this area leaves the model open to take a wide range of shapes and a priority would be to get biomass data for more groups. Biomass time series would also be important if the model was to be used for policy analysis.

The functional groups could be designed differently depending on the modeler, but it would be useful to segregate the juveniles of the commercial fish species. Generally, there was a degree of confidence in the fish groups because even though data specific to Morocco was lacking, the species list and groupings have been verified (K. Erzini, University of Algarve, Portugal, pers. comm.) while P/B and Q/B values could be calculated from empirical relationships. The same was not true for non-fish groups. Many assumptions were made based on other models for the lower trophic level groups, for seabirds and turtles. Furthermore, there was no information readily available on the migration of tuna and cetaceans.

The allocation of unidentified fish in the diets of many species is a classic example of a case for which there was no single correct option. These decisions have been documented above and the pedigree component of the Ecopath model testifies to these gaps in knowledge.

This model presents a snapshot for the mid 1980s. A more informative approach would be to build an Ecosim model which would include time series of catch and biomass estimates as well as indices of upwellings strength. To this end, it is recommended that, since permanent upwellings occur mainly in the Western Sahara region, the model be divided into two components, a strictly Moroccan model and another one for the region that was formerly known as the Western Sahara.

### **ACKNOWLEDGEMENTS**

We would like to thank the Pew Charitable Trusts, Philadelphia, USA, for funding the *Sea Around Us* project at the University of British Columbia, Canada. We would like to take this opportunity to thank Karim Erzini (University of the Algarves, Portugal) for assistance when creating the functional groups and Eduardo Balguerías (Institute of Oceanography, Canaries) for the birds list.

## REFERENCES

- Abdelali, A., 1995. Morocco Seafood Annual Report. Rabat, Morocco, <http://ag.ansc.purdue.edu/aquanic/publicat/govagen/fas/mo5019.htm>.
- Adams, S. M. 1976. Feeding ecology of eelgrass fish communities. *Transactions of the American Fisheries Society*, 4:514-519.
- Anonymous, 1986. Rapport du 1er groupe de travail spécial sur les pêcheries de merlus et de crevettes profondes dans la zone nord du COPACE. Organisation des Nations Unies pour l'Alimentation et l'Agriculture (FAO), Instituto Espanol de Oceanografia, Santa-Cruz de Tenerife, Canary Islands, Spain, COPACE/PACE Series, 86/33. 295 pp
- Arai, M., 1996. Carnivorous zooplankton, jellies and *Veella*. pp. 18-19. In: Mass-balance models of North-eastern Pacific ecosystems. Ed. by D. Pauly and V. Christensen. Fisheries Centre Research Report 4(1).
- Armstrong, M. J. 1982. The predator-prey relationships of Irish Sea poor-cod (*Trisopterus minutus* L.), pouting (*Trisopterus luscus* L), and cod (*Gadus morhua* L.). *Journal du Conseil International pour l'Exploration de la Mer*, 40:135-152.
- Baddy, M., 1989. The biology of the squid *Loligo vulgaris* in relation to the artisanal fishing site of Tifnit, Morocco. PhD thesis, University of Michigan, 113 pp.
- Baddy, M., and Guénette, S., 2001. The fisheries of the Atlantic coast of Morocco 1950-1997. pp191-205. In: Fisheries impacts on North Atlantic Ecosystems: Catch, Effort and National/Regional Data Sets. Ed. by S. Guénette, V. Christensen and D. Pauly, Fisheries Centre Research Report 9(3).
- Bauchot, M.-L., 1987. Raies et autres batoides. In: Fiches FAO d'identification pour les besoins de la pêche. (rev. 1). Méditerranée et mer Noire. Zone de pêche 37. pp. 845-886, Ed. by W. Fischer, M. L. Bauchot, and M. Schneider, Commission des Communautés Européennes and FAO, Rome, Vol. 2.
- Bauchot, M.-L., and Hureau, J. C., 1990. Sparidae. In: Check-list of the fishes of the eastern tropical Atlantic (CLOFETA). pp. 790-812, Ed. by J. C. Quero, J. C. Hureau, C. Karrer, A. Post, and L. Saldanha, UNESCO, Lisbon, Vol. 2.
- Belvèze, H., and Bravo de Laguna, J., 1980. Les ressources halieutiques de l'Atlantique centre-est deuxième partie: les ressources de la côte ouest-africaine entre 24°N et le Détroit de Gibraltar. Organisation des Nations Unies pour l'Alimentation et l'Agriculture (FAO), Rome, FAO Technical Report, 186.2. 64 pp
- Bennett, B. A. 1989. The diets of fish in three south-western Cape estuarine systems. *South African Journal of Zoology*, 24(3):163-177.
- Ben-Tuvia, A., and McKay, R., 1986. Haemulidae. In: Fishes of the north-eastern Atlantic and the Mediterranean. pp. 858-864, Ed. by P. J. P. Whitehead, M.-L. Bauchot, J.-C. Hureau, J. Nielsen, and E. Tortonesi, UNESCO, Paris, Vol. 2.
- Billard, R., 1997. Les poissons d'eau douce des rivières de France. Identification, inventaire et répartition des 83 espèces. Laboratoire d'Ichthyologie Générale et Appliquée et le Service du Patrimoine Naturel de L'Institute d'Écologie et de Gestion de la Biodiversité, Museum National d'Histoire Naturelle, 192 pp.
- Blaber, S. J. M., Milton, D. A., Rawlinson, N. J. F., Tiroba, G., and Nichols, P. V. 1990. Diets of lagoon fishes of the Solomon Islands: Predators of tuna baitfish and trophic effects of baitfishing on the subsistence fishery. *Fisheries Research*, 8:263-286.
- Boletzky, S. V., and Hanlon, R. T., 1981. A Review of the Laboratory Maintenance, Rearing and Culture of Cephalopod Molluscs, *Memoirs of the National Museum of Victoria*. In: Workshop on the Biology and Resource Potential of Cephalopods, pp. 147-187, Ed. by C. F. E. Roper, C. C. Lu, and F. G. Hochberg, Melbourne, Australia. Vol. 44.
- Bolten, A. B., Bjørndal, K. A., Martins, H. R., Dellinger, T., Biscoito, M. J., Encalada, S. E., and Bowen, B. W. 1998. Transatlantic developmental migrations of loggerhead sea turtles demonstrated by mtDNA sequence analysis. *Ecological Applications*, 8:1-7.
- Bundy, A., Lilly, G. R., and Shelton, P. A., 2000. A mass balance model of the Newfoundland-Labrador shelf. *Canadian Technical Report of Fisheries and Aquatic Sciences*, 2310. 157 pp
- Carrasson, M., and Matallanas, J. 1998. Feeding habits of *Alepocephalus rostratus* (Pisces: Alepocephalidae) in the Western Mediterranean Sea. *Journal of Marine Biology Association U.K.*, 78:1295-1306.
- Carwardine, M., 1995. Whales, dolphins, and porpoises. Dorling Kindersley Ltd., London, UK. 256 pp.
- Cohen, D. M., 1990. Argentinidae. In: Check-list of the fishes of the Eastern Tropical Atlantic (CLOFETA). pp. 235-238, Ed. by J. C. Hureau, C. Karrer, A. Post, and L. Saldanha, UNESCO, Lisbon, Vol. 1.
- Cohen, D. M., Inada, T., Iwamoto, T., and Scialabba, N., 1990. Gadiform fishes of the world (Order Gadiformes). An annotated and illustrated catalogue of cods, hakes, grenadiers and other gadiform fishes known to date. *FAO Fisheries Synopsis*, Vol. 10, 442 pp.
- Coleman, N., and Mobley, M. 1984. Diets of commercially exploited fish from Bass Strait and adjacent Victorian waters, southeastern Australia. *Australian Journal of Marine and Freshwater Research*, 35(5):549-560.
- Collette, B. B., and Aadland, C. R. 1996. Revision of the frigate tunas (Scombridae, *Auxis*), with descriptions of two new subspecies from the eastern Pacific. *Fishery Bulletin*, 94:423-441. [as cited in *Fishbase*].
- Collette, B. B., and Nauen, C. E. 1983. FAO species catalogue. Vol. 2. Scombrids of the world. An annotated and illustrated catalogue of tunas, mackerels, bonitos and related species known to date. *FAO Fisheries Synopsis*, 125(2):137.
- Conway, D. V. P. 1980. The food of larval blue whiting, *Micromesistius poutassou* (Risso), in the Rockall area. *Journal of Fish Biology*, 16:709-723.
- Costa, J. L., Assis, C. A., Almeida, P. R., Moreira, F. M., and Costa, M. J. 1992. On the food of the European eel, *Anguilla anguilla* (L.), in the the upper zone of the Tagus estuary, Portugal. *Journal of Fish Biology*, 41:841-850.
- Cristo. 1998. Feeding ecology of *Nephrops norvegicus*. *Journal of Natural History*, 32:1493-1498.
- Diouf, P. S., 1996. Les peuplements de poissons des milieux estuariens de l'Afrique de l'Ouest: L'exemple de l'estuaire hyperhalin du Sine-Saloum. Doctorat thesis, Université de Montpellier II, Paris.
- Domanevskaya, M. V., and Patokina, F. A. 1984. Feeding of the large-eyed dogtooth, *Dentex macrophthalmus*, and Spanish bream, *Pagellus acarne*, from the entral-Eastern Atlantic Ocean. *Journal of Ichthyology*, 24(5):107-112.
- Dubochkin, A. S., and Kotlyar, A. N. 1989. On the feeding of Alfonsino (*Beryx splendens*). *Journal of Ichthyology*, 29(5):1-8.
- Duka, L. A. 1986. Feeding of *Ceratoscopelus warmingii* (Myctophidae) in the tropical Atlantic. *Journal of Ichthyology*, 26(5):89-95.
- Edwards, A., 1990. Fish and fisheries of Saint Helena Island. Centre for Tropical Coastal Management Studies, University of Newcastle upon Tyne, Newcastle, England.
- Eschmeyer, W. N., Herald, E. S., and Hammann, H., 1983. A field guide to Pacific coast fishes of North America. Houghton Mifflin Company, Boston, USA. 336 pp.

- Fischer, W., Schneider, M., and Bauchot, M.-L., 1987. Fiches FAO d'identification des espèces pour les besoins de la pêche. (Révision 1). Méditerranée et mer Noire. Zone de Pêche 37. Vol. II. Vertébrés. FAO, Rome. Vol. 2, 761-1530 pp.
- Fricke, R., 1986. Callionymidae. In: Fishes of the North-eastern Atlantic and the Mediterranean. pp. 1086-1093. Ed. by P. J. P. Whitehead, M.-L. Bauchot, J.-C. Hureau, J. Nielsen, and E. Tortonese, UNESCO, Paris, Vol. 3.
- Frimodt, C., 1995. Multilingual illustrated guide to the world's commercial warmwater fish. Fishing News Books, Osney Mead, Oxford. 215 pp.
- Froese, R., and Pauly, D., eds., 2000. FishBase 2000: concepts, design and data sources. ICLARM, Los Baños, Laguna, Philippines, Vol. 76, 344 pp. [updates in [www.fishbase.org](http://www.fishbase.org)].
- Fuentes, H., Antonietti, E., and Alano, A. 1988. Espectro alimentario del patudo (*Thunnus obesus*) en la primavera austral de 1986 en el Pacífico sur oriental. Ed. by H. Salzwedel and A. Landa, Boletín del Instituto del Mar del Perú, Volumen Extraordinario.
- Gibson, R. N., and Ezzi, I. A. 1987. Feeding relationships of a demersal fish assemblage on the west coast of Scotland. *Journal of Fish Biology*, 31:55-69.
- Gibson, R. N., and Robb. 1996. Piscine predation on juvenile fishes on a Scottish sandy beach. *Journal of Fish Biology*, 49:120-138.
- Gonzalez-Gurriaran, E., J.Freire, and Fernandez, L. 1995. Feeding activity and the contribution of mussel raft culture in the diet of crabs in the Ria de Arousa (Galicia, NW Spain). *ICES Marine Science Symposia*, 199:99-107.
- Gordon, J. D. M., and Mauchline, J. 1996. The distribution and diet of the dominant, slope-dwelling eel, *Synphobranchius kaupi*, of the Rockall Trough. *Journal of Marine Biology Association U.K.*, 76:493-503.
- Gorelova, T. A., Agafonova, T. B., and Lipskaya, N. J. 1994. Feeding of cigarfishes (Genus *Cubiceps*, Stromateiidae). *Journal of Ichthyology*, 34(7):70-82.
- Gorelova, T. A., and Krasil'nikova, N. A. 1990. On the diet of *Maurolicus muelleri* in the vicinity of Seamounts Discovery, Nasca, and Mt. Africana. *Journal of Ichthyology*, 30(7):42-52.
- Gremillet, D., Wilson, R. P., and Storeh, S. 1999. Three dimensional space utilization by a marine predator. *Marine Ecology Progress Series*, 183:263-273.
- Grove, J. S., and Lavenberg, R. J., 1997. The fishes of the Galápagos Islands. Stanford University Press, Stanford. 863 pp.
- Guerra, A. 1978. Sobre la alimentación y el comportamiento. *Investigacion Pesquera*, 42(2):351-364.
- Guichet, R. 1995. The diet of European hake (*Merluccius merluccius*) in the northern part of the Bay of Biscay. *ICES Journal of Marine Science*, 52:21-31.
- Harmelin-Vivien, M.L., K.-M., R.A., L., and Jacob-Abraham, M. 1989. Food partitioning among scorpaenid fishes in Mediterranean seagrass beds. *Journal of Fish Biology*, 34:715-734.
- Hopkins, T. L., and Baird, R. C. 1985. Feeding ecology of four hatchetfishes (Sternoptychidae) in the eastern Gulf of Mexico. *Bulletin of Marine Science*, 36(2):260-277.
- Hulley, P. A., 1990. Myctophidae. In: Check-list of the fishes of the eastern tropical Atlantic (CLOFETA). pp. 398-467, Ed. by Quero, J. C. Hureau, C. Karrer, A. Post, and L. Saldanha, UNESCO, Lisbon, Vol. 1.
- Innes, S., Lavigne, D. M., Earle, W. M., and Kovacs, K. M. 1987. Feeding rates of seals and whales. *Journal of Animal Ecology*, 56:115-130.
- Jarre-Teichmann, A., and Guénette, S., 1996. Invertebrate benthos. pp. 38-39. In: Mass-Balance models of North-eastern Pacific Ecosystems. Ed. by D. Pauly and V. Christensen. Fisheries Centre Research Report 4(1).
- Jarre-Teichmann, A., and Pauly, D., 1993. Seasonal changes in the Peruvian upwelling ecosystem. In: Trophic models of aquatic ecosystems, pp. 307-314, Ed. by V. Christensen and D. Pauly, ICLARM Conference Proceedings. Vol. 26.
- Kaschner, K., Watson, R., Christensen, V., Trites, A. W., and Pauly, D., 2001. Modeling and mapping trophic overlap between marine mammals and commercial fisheries in the North Atlantic. pp35-45. In: Fisheries impacts on North Atlantic Ecosystems: Catch, effort and national/regional data sets. Ed. by D. Zeller, R. Watson and D. Pauly. Fisheries Centre Research Report 9(3).
- Kotlyar, A. N., 1980. Age and growth speed of the bigheads, *Hoplostethus atlanticus* and *H. mediterraneus* (Trachichthyidae, Beryciformes). In: Fishes of the open ocean. pp. 68-88, Ed. by P. V. Shirston, Institute of Oceanography, Moscow.
- Kumaran, M. 1964. Studies on the food of *Euthynnus affinis affinis* (Cantor), *Auxis thazard* (Lacepède), *Auxis thynnoides* (Bleeker) and *Sarda orientalis* (Temminck and Schlegel). In: Proceedings of the Symposium on Scombroid Fishes, Part II., Marine Biology Association of India, Symposium Series, 1:599-606.
- Labropoulou, M., and Eleftheriou, A. 1997. The foraging ecology of two pairs of congeneric demersal fish species: importance of morphological characteristics in prey selection. *Journal of Fish Biology*, 50:324-340.
- Lamboeuf, M., ed. 1997. Groupe de travail *ad hoc* sur les sardines et atelier COPACE sur les méthodes avancées pour l'évaluation des stocks. FAO, Rome, Casablanca, Vol. COPACE/PACE/Ser. No. 97/61, 164 pp.
- Langton, R. W., and Bowman, R. E. 1980. Food of fifteen northwest Atlantic Gadiform fishes. NOAA Technical Report NMFS SSRF-740, U.S. Department of Commerce,
- Last, J. M. 1987. The food of immature sprat [*Sprattus sprattus* (L.)] and herring (*Clupea harengus*) in coastal waters of the North Sea. *Journal du Conseil International pour l'Exploration de la Mer*, 44:73-79.
- Lenfant, P., and Olive, C. 1998. Changements graduels du régime alimentaire des juvéniles d'oblade (*Oblada melanura*, Sparidae) lors du recrutement. *Cybiurn*, 22(3):203-210.
- Li, W. K. 1994. Phytoplankton biomass and chlorophyll concentration across the North Atlantic. *Scientia Marina*, 58(1-2):67-79.
- Lipskaya, N. Y. 1987. Feeding of flyingfish (Exocoetidae) larvae and fingerlings in the region of the Peruvian upwelling. *Journal of Ichthyology*, 27(3):108-116.
- Mackinson, S., 1996. System Definition and Oceanographic Conditions. pp. 63-64. In: Mass-Balance Models of North-eastern Pacific ecosystems. Ed. by D. Pauly and V. Christensen. Fisheries Centre Research Report 4(1).
- MacPherson, E. 1980. Food and feeding of *Chimaera monstrosa*, (Linnaeus 1758), in the western Mediterranean. *Journal du Conseil International pour l'Exploration de la Mer*, 39(1):26-29.
- MacPherson, E., and Roel, B. A. 1987. Trophic relationships in the demersal fish community off Namibia. *South African Journal of Marine Sciences*, 5:585-596.
- Mannini, P., Reale, B., and Righini, P. 1990. Osservazioni sulla biologia e la pesca di *Lepidorhombus boschii* (Risso) (Osteichthyes, Scopthalmidae) nel tirreno settentrionale. *Oebelia*, 16(1):245-255.
- Markle, D. F., and Quéro, J.-C., 1984. Alepocephalidae (including Bathylaconidae, Bathypriionidae). In: Fishes of the North-eastern Atlantic and the

- Mediterranean. pp. 228-253, Ed. by P. J. P. Whitehead, M.-L. Bauchot, J.-C. Hureau, J. Nielsen, and E. Tortonese, UNESCO, Paris, Vol. 1.
- Mauchline, J., and Fisher, L. R. 1980. The biology of euphausiids. *Advances in Marine Biology*:373-623.
- Mauchline, J., and Gordon, J. D. M. 1984. Occurrence and feeding of berycomorphid and percomorphid teleost fish in the Rockall Trough. *Journal du Conseil International pour l'Exploration de la Mer*, 41:239-247.
- Mendo, J. A. 1984. Edad, crecimiento y algunos aspectos reproductivos y alimentarios de la caballa (*Scomber japonicus peruanus*). *Boletín del Instituto del Mar del Perú*, 8(101-156)
- Mennes, F. 1985. Multispecies assessment of fish stocks off the Western Sahara region with emphasis on the family Sparidae. *Fishbyte*, November 1985:5-10.
- Meyer, M., and Smale, M. J. 1991. Predation patterns of demersal teleosts from the Cape south and west coasts of South Africa.1. Pelagic predators. *South African Journal of Marine Sciences*, 11:173-191.
- Morales-Nin, B., and Moranta, J. 1997. Life history and fishery of the common dentex (*Dentex dentex*) in Mallorca (Balearic Islands, western Mediterranean). *Fisheries Research*, 30:67-76.
- Moreira, F., Assis, C. A., Almeida, P. R., Costa, J. L., and M.J. Costa. 1992. Trophic relationships in the community of the Upper Tagus Estuary (Portugal: a preliminary approach). *Shelf-Sciences*, 34:617-623.
- Moreno-Amich, R. 1994. Feeding habits of grey gurnard, *Eutrigla gurnardus* (L. 1758), along the Catalan coast (northwestern Mediterranean). *Hydrobiologia*, 273(1):57-66.
- Nakamura, I., Inada, T., Takeda, M., and H. Hatanaka, 1986. Important fishes trawled off Patagonia. Japan Marine Fishery Resource Research Center, Tokyo.369 pp.
- Nakamura, I., and Parin, N. V., 1993. FAO species catalogue. Snake mackerels and cutlassfishes of the world (Families Gempylidae and Trichiuridae). FAO Fisheries Synopsis, Vol. 15, 136 pp.
- Nash, R. D. M., Geffen, A. J., and Santos, R. S. 1991. The wide-eyed flounder, *Bothus podas* Delaroche, a singular flatfish in varied shallow-water habitats of the Azores. *Netherlands Journal of Sea Research*, 27(3/4):367-373.
- Nehring, D., and Holzlohner, S. 1982. Investigations on the relationship between environmental conditions and distribution of *Sardina pilchardus* in the shelf area off Northwest Africa. *Rapports et Procès-Verbaux des Réunions du Conseil International pour l'Exploration de la Mer*, 180:342-344.
- Nesis, K. I. 1965. Bioeceneses and biomass of benthos of the Newfoundland-Labrador region. *Journal of the Fisheries Research Board of Canada*, 13:57-75.
- Neto, A. I. d. M. A., 1997. Studies on algal communities of São Miguel, Azores. PhD thesis, Universidade dos Açores, Ponta Delgada, Portugal. 309 pp.
- Olaso, I., and Rodriguez-Marin, E., 1995. Alimentación de veinte especies de peces demersales pertenecientes a la división VIIIc del ICES. Otoño 1991. Informes Técnicos, Centro Oceanográfico de Santander, Instituto Español de Oceanografía, 56 pp.
- Opitz, S., 1993. A quantitative model of the trophic interactions in a Caribbean coral reef ecosystem. In: *Trophic Models of Aquatic Ecosystems*. pp. 268-233, Ed. by V. Christensen and D. Pauly, ICLARM, Manila, Philippines.
- Ortiz de Zarate, V., and Cort, J. L. 1986. Stomach contents study of immature bluefin tuna in the Bay of Biscay (Region 3 of EEC). Collective volume of scientific papers. International Commission for the Conservation of Atlantic Tunas, SCRS/86/33:243-247.
- Palko, B. J., Beardsley, G. L., and Richards, W. 1982. Synopsis of the biological data on dolphin-fishes, *Coryphaena hippurus* (Linnaeus, 1758) and *Coryphaena equiselis* (Linnaeus, 1758). FAO Fisheries Synopsis, 130.
- Palomares, M. L., and Pauly, D. 1989. A multiple regression model for predicting the food consumption of marine fish populations. *Australian Journal of Marine and Freshwater Research*, 40:259-273.
- Papaconstantinou, C., and Caragitsou, E. 1989. Feeding interactions between two sympatric species *Pagrus pagrus* and *Phycis phycis* around Kastellorizo island (Dodecanese, Greece). *Fisheries Research*, 7:329-342.
- Pauly, D. 1980. On the interrelationships between natural mortality, growth parameters, and mean environmental temperature in 175 fish stocks. *Journal du Conseil International pour l'Exploration de la Mer*, 39:175-192.
- Pauly, D., Trites, A. W., Capuli, E., and Christensen, V. 1998. Diet composition and trophic levels of marine mammals. *ICES Journal of Marine Science*, 55:467-481.
- Pihl, L. 1985. Food selection and consumption of mobile epibenthic fauna in shallow marine areas. *Marine Ecology - Progress Series*, 22:169-179.
- Polovina, J., 1996. The marine ecosystem of the Gulf of Alaska. p. 16. In: *Mass-balance models of North-eastern Pacific ecosystems*. Ed. by D. Pauly and V. Christensen. Fisheries Centre Research Report 4(1).
- Post, A., 1984. Omosudidae. In: *Fishes of the north-eastern Atlantic and the Mediterranean*. pp. 496-497, Ed. by P. J. P. Whitehead, M.-L. Bauchot, J.-C. Hureau, J. Nielsen, and E. Tortonese, UNESCO, Paris, Vol. 1.
- Prince, P. A., and Morgan, R. A., 1987. Diet and feeding ecology of Procellariiforms. In: *Seabirds - Feeding ecology and Role in the Marine Ecosystem*. Ed. by J. P. Croxal, Cambridge University Press,
- Purcell, J., 1996. Lower trophic levels in the Alaska Gyre. pp. 16-18. In: *Mass-balance models of North-eastern Pacific ecosystems*. Ed. by D. Pauly and V. Christensen. Fisheries Centre Research Report 4(1).
- Randall, J. E. 1967. Food habits of reef fishes of the West Indies. *Stud. Trop. Ocean*. Miami, 5:665-847.
- Richards, W. J., and Saksena, V. P., 1990. Triglidae. In: *Check-list of the fishes of the eastern tropical Atlantic (CLOFETA)*. pp. 680-684, Ed. by J. C. Quéro, J. C. Hureau, C. Karrer, A. Post, and L. Saldanha, UNESCO, Paris, Vol. 2.
- Riewald, B., Bolten, A., Bjørndal, K., and Martins, H., 1999. Movement and habitat use of pelagic loggerhead sea turtles *Caretta caretta*. In: *34th European Marine Biology Symposium*, pp. 103, Poster, Ponta Delgada. Vol. Program and Abstracts.
- Rincon, M. C., Huq, M. F., and Ramirez-Arredondo, I. 1988. Aspectos alimenticios de la sardina, *Sardinella aurita* Valenciennes, 1847 (Pisces: Clupeidae) de los alrededores de la region noroccidental de la Peninsula de Araya y alrededores de las Islas de Coche y Cubagua, Venezuela. *Boletín del Instituto Oceanográfico de Venezuela, Universidad Oriente*, 27(1&2):129-143.
- Rodriguez, A. 1996. Régime alimentaire de deux Soleidae, *Solea lascaris* et *Solea impar* de la côte ouest de Bretagne. *Cybiurn*, 20(3):261-277.
- Roger, C. 1993. Relationships among yellowfin and skipjack tuna, their prey-fish and plankton in the tropical western Indian Ocean. *Fisheries Oceanography*, 3(1):1-9.
- Sala, E., and Ballesteros, E. 1997. Partitioning of space and food resources by three fish genus *Diplodus* (Sparidae) in a Mediterranean rocky infralittoral ecosystem. *Marine Ecology Progress Series*, 152:273-283.

- Scott, W. B., and Tibbo, S. N. 1968. Food and feeding habits of swordfish, *Xiphias gladius*, in the western north Atlantic. *Journal of the Fisheries Research Board of Canada*, 25(5):903-919.
- Shevchenko, N. F. 1986. Feeding of *Vinciguerria nimbaria* (Gonostomatidae) in the tropical zone of the Atlantic Ocean. *Journal of Ichthyology*, 26(4):50-56.
- Shimizu, T., 1984. Berycidae. In: FAO species identification sheets for fishery purposes. Western Indian Ocean fishing area 51. Ed. by W. Fischer and G. Bianchi, Vol. 1.
- Sierra, L. M., Claro, R., and Popova, O. A., 1994. Alimentación y relaciones tróficas. In: *Ecología de los Peces Marinos de Cuba*. pp. 263-284, Ed. by R. Claro, Instituto de Oceanología Academia de Ciencias de Cuba and Centro de Investigaciones de Quintana Roo, Mexico.
- Sloan, N. A. 1980. Aspects of the feeding biology of asteroids. *Oceanographical Marine Biological Annual Review*, 18:57-124.
- Smale, M. J. 1991. Occurrence and feeding of three shark species, *Carcharinus brachyurus*, *C. obscurus* and *Sphyrna zygaena*, on the eastern Cape coast of South Africa. *South African Journal of Marine Sciences*, 11:31-42.
- Smith-Vaniz, W. F., 1986. Carangidae. In: *Fishes of the north-eastern Atlantic and the Mediterranean*. pp. 815-844, Ed. by P. J. P. Whitehead, M.-L. Bauchot, J.-C. Hureau, J. Nielsen, and E. Tortonese, UNESCO, Paris, Vol. 2.
- Stergiou, K. I. 1993. Abundance-depth relationship, condition factor and adaptive value of zooplanktophagy for red bandfish, *Cepola macrophthalma*. *Journal of Fish Biology*, 42:645-660.
- Stergiou, K. I., and Fourtouni, H. 1991. Food habits, ontogenetic diet shift and selectivity in *Zeus faber* Linnaeus, 1758. *Journal of Fish Biology*, 39:589-603.
- Stillwell, C. E., and Kohler, N. E. 1982. Food, feeding habits, and estimates of daily ration of the shortfin mako (*Isurus oxyrinchus*) in the Northwest Atlantic. *Canadian Journal of Fisheries and Aquatic Sciences*, 39:407-414.
- Stillwell, C. E., and Kohler, N. E. 1993. Food habits of the sandbar shark *Carcharhinus plumbeus* off the U.S. northeast coast, with estimates of daily ration. *Fishery Bulletin*, 91:138-150.
- Trites, A., and Heise, K., 1996. Marine mammals. pp. 25-30. In: *Mass-Balance Models of North-eastern Pacific ecosystems* Ed. by D. Pauly and V. Christensen. Fisheries Centre Research Report 4(1).
- Trites, A., and Pauly, D. 1998. Estimating mean body masses of marine mammals from maximum body lengths. *Canadian Journal of Zoology*, 76:886-896.
- van der Elst, R. P., and Adkin, F. 1991. Marine linefish: priority species and research objectives in southern Africa. *Oceanographic Research Institute (Durban), Special Publication*, 1:132.
- Velasco, F., Olaso, I., and Gándara, F. d. I., 1996. Alimentación de veintidós especies de peces demersales de la División VIIIc de la ICES. Otoños de 1992 y 1993. *Informes Técnicos, Instituto Español de Oceanografía* 164, 62 pp.
- Venier, J. M., and Pauly, D., 1997. Trophic dynamics of a Florida Keys coral reef ecosystem. In: *Proceedings of the 8th International Coral Reef Symposium*, pp. 915-920. Vol. 1.
- Wada, Y., 1996. Marine mammals and birds. p. 71. In: *Mass-Balance Models of North-eastern Pacific Ecosystems*. Ed. by D. Pauly and V. Christensen. Fisheries Centre Research Report 4(1).
- Weikert, H. 1982. Some features of zooplankton distribution in the upper 200 m in the upwelling region off northwest Africa. In: *The Canary Current: Studies of an Upwelling System, Las Palmas, Rapports et Procès-Verbaux des Réunions du Conseil International pour l'Exploration de la Mer*, 180:280-288.
- Whitehead, P. J. P., 1985. FAO species catalogue. Vol. 7. Clupeoid fishes of the world. An annotated and illustrated catalogue of the herrings, sardines, pilchards, sprats, shads, anchovies and wolf-herrings. Part 1 - Chirocentridae, Clupeidae and Pristigasteridae. FAO, Vol. 7, 303 pp.
- Winstanley, R. H., 1983. The food of snapper *Chrysophrys auratus* in Port Phillip Bay, Victoria. 14 pp.
- Wosnitza, C. V. 1975. Die Nahrung von Fischbrut in der westlichen Ostsee. *Ber. dt. wiss. Kommn. Meeresforsch.*, 24:79-92.
- Yoshida, H. O., 1980. Synopsis of biological data on bonitos of the genus *Sarda*. NOAA, Technical Report NMFS Circular 432, FAO Fisheries Synopsis, 118. 50 pp
- Zander, C. D., 1986. Blenniidae. In: *Fishes of the North-eastern Atlantic and the Mediterranean*, pp. 1096-1112, Ed. by P. J. P. Whitehead, M.-L. Bauchot, J.-C. Hureau, J. Nielsen, and E. Tortonese, UNESCO, Paris, Vol. 3.