

A review of machine learning and deep learning applications in wave energy forecasting and WEC optimization

Alireza Shadmani^{a,b}, Mohammad Reza Nikoo^{c,1,**}, Amir H. Gandomi^{d,e,*}, Ruo-Qian Wang^f, Behzad Golparvar^f

^a Department of Maritime Engineering, Amirkabir University of Technology, Tehran, Iran

^b Faculty of Engineering and Architecture, Department of Electromechanical, Systems, And Metal Engineering, Technoligipark-Zwijnaarde 46, Ghent University, Ghent, Belgium

^c College of Engineering, Department of Civil and Architectural Engineering, Sultan Qaboos University, Muscat, Oman

^d Faculty of Engineering & Information Technology, University of Technology Sydney, Ultimo, Australia

^e University Research and Innovation Center (EKIK), Óbuda University, 1034, Budapest, Hungary

^f Department of Civil and Environmental Engineering, Rutgers University, New Brunswick, USA

ARTICLE INFO

Handling Editor: Xi Lu

Keywords:

Wave energy conversions
Wave characteristics
Optimization algorithms
Machine learning
Deep learning

ABSTRACT

Ocean energy technologies are in their developmental stages, like other renewable energy sources. To be useable in the energy market, most components of wave energy devices require further improvement. Additionally, wave resource characteristics must be evaluated and estimated correctly to assess the wave energy potential in various coastal areas. Multiple algorithms integrated with numerical models have recently been developed and utilized to estimate, predict, and forecast wave characteristics and wave energy resources. Each algorithm is vital in designing wave energy converters (WECs) to harvest more energy. Although several algorithms based on optimization approaches have been developed for efficiently designing WECs, they are unreliable and suffer from high computational costs. To this end, novel algorithms incorporating machine learning and deep learning have been presented to forecast wave energy resources and optimize WEC design. This review aims to classify and discuss the key characteristics of machine learning and deep learning algorithms that apply to wave energy forecast and optimal configuration of WECs. Consequently, in terms of convergence rate, combining optimization methods, machine learning, and deep learning algorithms can improve the WECs configuration and wave characteristic forecasting and optimization. In addition, the high capability of learning algorithms for forecasting wave resource and energy characteristics was emphasized. Moreover, a review of power take-off (PTO) coefficients and the control of WECs demonstrated the indispensable ability of learning algorithms to optimize PTO parameters and the design of WECs.

1. Introduction

Energy systems, particularly renewable sources, play a substantial and vital role in all facets of modern society, notably the residential sector, industry, and transportation, resulting from the evolution of human civilization and its critical need for energy [1]. The capacity of energy systems to adapt to supply and demand while providing maximum performance and having low environmental effects is generally considered one of the most fundamental concerns in this field.

Particular emphasis should be given to these challenges due to the growing population, the need to meet the energy demand to offer better welfare and comfort, the growing usage of fossil fuels, and their negative environmental consequences [2,3].

In 2018, 376 TWh of renewable energy was produced throughout the world, an increase of 3% from the previous year (2017) [4], whereas wind and solar energy production increased by 11% and 28%, respectively. With an increased output of 219 TWh in 2018, Asia was primarily responsible for the growth of renewable energy production. The amount of renewable energy generated globally has also increased, reaching

* Corresponding author. Faculty of Engineering & Information Technology, University of Technology Sydney, Ultimo, Australia.

** Corresponding author. College of Engineering, Department of Civil and Architectural Engineering, Sultan Qaboos University, Muscat, Oman.

E-mail addresses: alireza.shadmani@aut.ac.ir (A. Shadmani), m.reza@squ.edu.om (M.R. Nikoo), gandomi@uts.edu.au (A.H. Gandomi), rq.wang@rutgers.edu (R.-Q. Wang), behzad.golparvar@rutgers.edu (B. Golparvar).

¹ The two authors have the same contribution to this study.

Abbreviations

AELM	Advanced extreme learning machines	ML	Machine learning
AR	Autoregression	MPC	Model predictive control
ARX	Autoregressive with exogenous	MAPE	Mean absolute percentage error
ARMA	Autoregressive moving average	MLP	Multi-layer perceptron
ARMAX	Autoregressive moving average with exogenous	MOEA	Multi-objective evolutionary algorithm
AI	Artificial intelligence	MFO	Moth-flame optimization
ANN	Artificial neural network	MVO	Multi-Verse optimizer
CEEMD-ELM	Comprehensive ensemble empirical mode decomposition-empirical learning model	NPV	Net present value
CM-MLR	Conditional maximization-based multiple linear regression	NCEP	National Centers for Environmental Predictions
CNN	Convolutional neural network	NARX	Nonlinear autoregressive exogenous
DL	Deep learning	OWC	Oscillating water column
DNN	Deep neural network	OWSC	Oscillating wave surge converter
EOF-NN	Empirical orthogonal function-neural network	OPF	Optimum power flow
EMD-LSTM	Empirical modal decomposition-long short-term memory	PA	Point absorber
ECMWF	European Center for Medium-Range Weather Forecasts	PE	Positional encoding
FFNN	Feed-forward neural network	P-LSTM	Parallel long short-term memory
GPU	Graphic processing unit	ROI	Return of investment
GBDT	Gradient boosting decision tree	RL	Reinforcement learning
GAP-RBF	Growing and pruning radial basis function	RNN	Recurrent neural network
HPTO	Hydraulic power take-off	RF	Random forest
LCoE	Levelized cost of energy	RMSE	Root mean squared error
LSTM	Long short-term memory	SVM	Support vector machine
LPA	Low-pressure gas accumulator	Seq2Seq	Sequence-to-sequence
		SWH	Significant wave height
		SOS	Symbiotic organisms search
		SQP	Sequential quadratic programming
		WEC	Wave energy converter

40% in Asia [4,5]. The US clean energy strategy is gaining traction as more organizations aim to enlarge renewable sources utilization and reduce carbon emissions [6]. Recently, a growing number of businesses have expressed a desire to expand their commitment to renewable legacy requirements to demand that all their energy be derived from renewable sources [7–9]. Companies in the power industry are currently making significant commitments to lessen their carbon footprint and enhance renewable sources utilization [10,11]. Eleven publicly listed utility companies have committed to fully decarbonizing their operations. More than 80% of 2005 levels of carbon emissions will be cut by these utilities by 2050, as stated in their respective 2050 climate change action plans [8].

Fig. 1 depicts the percentage of renewable energy sources in worldwide final energy consumption in 2023 based on the REN21 report [8]. This percentage is expected to increase because of the opportunities provided by the renewable energy map (REmap) [8]. Bioenergy, the primary form of renewable energy, can be converted into thermal energy, electrical power, and transportation fuel. Based on REmap, 20% of the targeted renewable energy consumption, several different types of biomass—liquid, solid, and gaseous—contribute to this total (61%) [8]. As previously indicated, the majority of the change involves switching from traditional to modern technologies and fuels [12]. The percentage of available renewable energy is also shown in Fig. 2, where the most active renewable sources are wind, solar, wave, and tidal energy. Among these sources, waves have higher predictability than others, and have been the focus of much recent research.

The ocean contains a substantial amount of energy that can be harnessed from waves. According to the U.S. Electric Power Research Institute [15], the United States has an estimated yearly harvestable resource of 255 TWh, or roughly 6% of the national consumption. In 2009, the United Kingdom's feasible offshore resources were estimated to produce 55 TWh annually, accounting for approximately 14% of the country's total consumption [16]. Compared with conventional power sources that rely on fossil fuels, ocean wave energy has a far less negative

effect on the environment [17]. Life-cycle analysis can estimate emissions from nearshore wave energy devices [18]. These numbers demonstrate that, compared to fossil fuel alternatives, gaseous pollution emissions from wave energy are much lower. This trend breaks down only when comparing SO₂ emissions from conventional power plants with those from zero-emission combined-cycle gas turbines [18].

Waves and wind unquestionably have the most significant potential among the other sources of renewable energy. Since the immense potential energy from the ocean may facilitate the shift to sustainable energy sources, wave energy has attracted academics' interest for years. By 2025, the worldwide wave energy market will grow from its current level of \$47 million to \$107 million [19]. Wave energy behaviors are the most intermittent, unstable, and unpredictable; thus, a comprehensive understanding and knowledge of these characteristics are necessary for design, building, and planning applications. Domestic wave behaviors are indeterminate in an interval of short-term and long-term. The wave height and period, which vary in both time and space, are the most dynamic and crucial characteristics. Because the efficiency of wave energy converters (WECs) depends on the wave characteristics, the wave height and period play a significant role in forecasting wave energy. Several models have been developed to replicate and study these conversion processes and improve the reliability of harvesting, forecasting, and optimization of wave energy. A precise forecast is crucial to ensure the dependability and effectiveness of the entire system and evaluate the performance regarding the cost [20].

In commercial-scale wave farm applications, capturing and forecasting wave energy present extreme difficulties [21]. Moreover, the challenge of managing and storing energy increases with its intermittent use. The expansion of wave energy use on a broad scale and other applications of ocean engineering depends critically on resilience and stability [22]. Considering previous studies and methodologies, it is essential to refocus research on wave energy behavior and improve the development of wave energy applications [23,24]. Wave energy has not been considered a viable solution, with great promise in previous

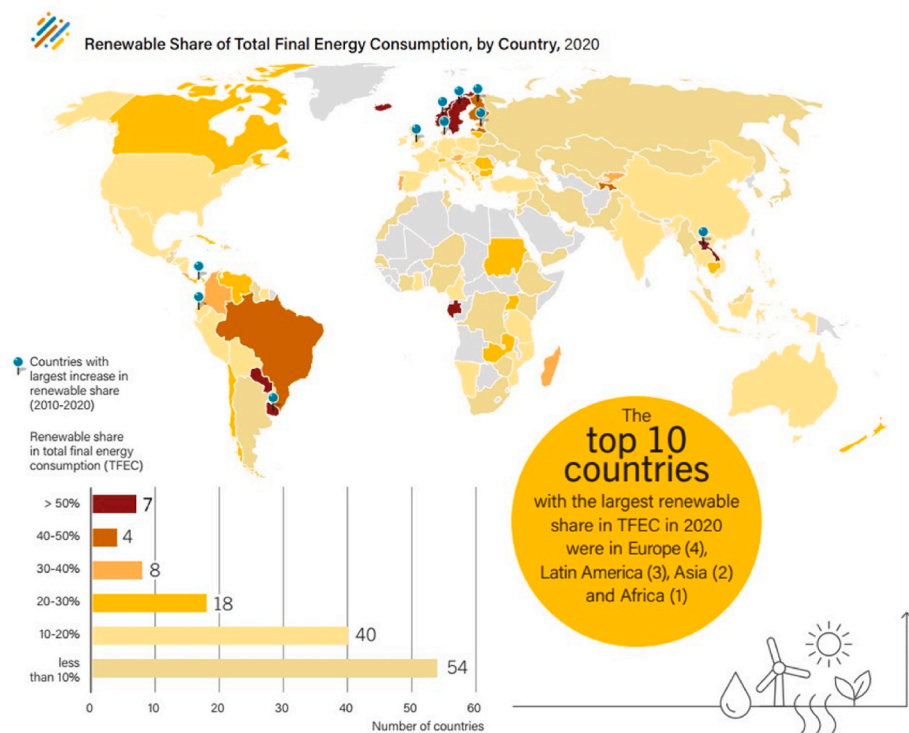

Fig. 1. Renewable energy percentage in different countries, adopted from REN-21 global status report [8,13].

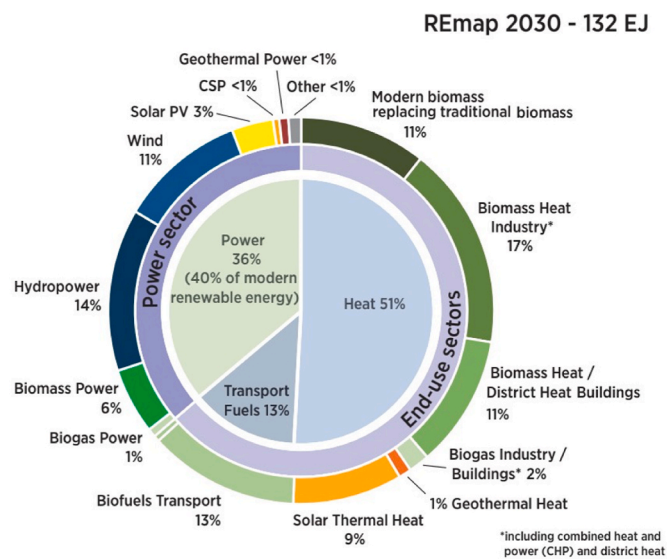

Fig. 2. Percentage of renewable energy sources, adopted from REmap 2030 report [8,14].

studies.

The energy from ocean waves is reliable and consistent, unlike that from the sun or wind. Waves having the potential for power generation will fluctuate despite daily changes in amplitude and velocity due to changing tide regimes and storm systems. By contrast, for wind and solar power, which only produce energy between 20% and 30% of the time, wave power generators may be able to generate electricity for as much as 90% of the time; therefore, ocean energy is more reliable [25]. Weather conditions have little impact on the wave and tidal patterns, which may be accurately anticipated for many years [26], which would assist in selecting the ideal location for WECs. Additionally, reliable wave information is available for up to four days in advance [27]. This

simplifies power dispatching, makes it easier for grid operators to satisfy baseload demands, and provides the potential to integrate wave energy with wind or solar energy. Perez-Collazo et al. [28] studied many techniques and substructures for merging wave and wind energy. The researchers observed the wave and wind patterns in each season, rather than an odd seasonal pattern with the highest wave energy potential occurring in winter. This is likely due to the fact that waves are generally more active in the winter because of increased wind, which is due to colder temperatures. Wave power is much more predictable than wind power and it increases during the winter when electricity demand is at its highest. This seasonality of wave energy resource has been observed in other studies as well. For example, a study on offshore wind and wave energy and climate change impacts found a strong seasonality of wave energy resource, with the mean wave power density being greater than 1.5 kW/m during winter and less than 0.2 kW/m during summer. This seasonal variation in wave energy potential can have important implications for the design and operation of WECs. By taking into account the seasonal variation in wave energy potential, engineers and researchers can optimize the performance of WECs and maximize their energy output [29]. The growing wind and wave energy in temperate climates during this season makes wave energy attractive in certain places, as seen by the heating loads [30].

Zheng et al. [31] studied wind and wave energy sources in the China Sea for over 22 years, focusing on factors like energy density stability. They found that waves with longer periods are beneficial for conversion because energy is distributed more quickly as the wavelength increases. These waves also have the benefit of generating less adverse environmental impact energy, which increases device usability. From offshore to nearshore sites, waves seem more prone to losing energy and breaking if they have large amplitudes and short wavelengths. Longer wavelengths are produced because of longer periods, extending the possibility of energy harvesting. This property of deep-sea swells, in particular, and wave action, in general, support the advantage of continuous wave energy.

If the aforementioned potential benefits of wave energy are to be attained, several obstacles must be eliminated, which means that the

conversion of wave energy into clean electricity is significantly difficult. Even though waves may create electricity 90% of the time, there is considerable variation in wave power levels [17]. The highest and lowest mean ocean wave energies at a given site are relative to each other by a factor of two [32]. In order to maintain this level of production, a mechanism for storing energy must be developed [25,33].

The creation of a power generation device is additionally complicated by variations in wave directionality. The power production from different types of wave energy devices varies with the direction of the wave, which calls into question their long-term viability, as indicated by Wolgamot et al. [34], Cruz et al. [35], and Clemente et al. [36]. Therefore, wave energy conversion technologies should be capable of positioning themselves suitably on flexible mooring lines which allow these devices to absorb energy from almost any angle. The most significant challenge for nonaxisymmetric devices and deep sea is the orientation of nearshore waves caused by natural refraction, reflection, and diffraction [25]. It is vital to remember that, apart from wave orientations, offshore waves are less changeable than coastal swells. Waves create local high-energy “hot spots” concentrated on headlands, whereas other areas, including bays, have low energy content as a result of defocusing. Falnes [37] outlined other coastal wave phenomena, such as wave reflection, diffraction, bottom friction, and depth-induced breaking effects that might affect energy fluctuations.

Device durability in harsh weather conditions is another issue [17]. During a storm, the strength of the waves may increase by as much as five times to 2000 kW/m [25,37]. Consequently, there is a dual difficulty because these devices must be structurally strong enough to survive the high impact pressures caused by storm waves, and must be certified for the most typical wave power levels. In addition to these concerns about the design of the underlying structure, the increased robustness of devices presents a financial difficulty in the form of higher capital expenses in order to for the device to withstand extreme conditions. Most technological solutions to these problems are intended to adopt a survival mode during extreme weather [38,39]. For example, the technology may be briefly submerged to shield it from the force of breaking surface waves, or the mooring lines or connections can be loosened to allow the device the most freedom of motion so that it can “surf” the waves [30].

Levelized cost of energy (LCoE) and net present value (NPV) analyses of offshore wind and wave energy show that offshore wind turbines are the most cost-effective option [40,41]. However, waves may become a competitive energy source if financial incentives and lower production, installation, and maintenance costs are neglected. Although many different technologies are already available and tested in laboratories, there is still a mismatch between these implementations and those tested in the ocean. There have only been a few studies and practical applications of array configurations. For ocean wave energy, technical innovators do not agree on any particular design. Therefore, certain technical standards and norms must be defined to test the prototypes and actual project implementation. In light of the unique properties of WECs, such as their high efficiency, this standardization process can be applied in the wind industry [42].

Traditional techniques also have difficulties in predicting extremely large waves. Numerous methods for predicting wave characteristics have been developed because of the complicated and sometimes inconsistent data availability of wave buoy observations, such as those reported by Gomez et al. [43]. Overall, WECs are still in the developmental stage. Due to its multidisciplinary character, the superiority of WEC over existing competitors is still distant in terms of performance, technological viability, and economic viability. Consequently, all sites for wave farms must be allocated, chosen, designed, and evaluated using systematic and comprehensive methods [36,44]. Without limiting the criteria, WEC devices must overcome the abovementioned challenges and compete with other renewable energies at a competitive cost, enhanced reliability, and higher survival [45].

An extensive range of device types can be found in the databases

owing to the location-dependent diversity of wave patterns [46–49], which were developed by 123 businesses [44]. These technologies fall into four main categories: attenuators [50], terminators [51], point absorbers (PAs) [52], and oscillating water columns (OWCs) [53]. Attenuators are positioned in line with the wave direction, such as the Pelamis created by Pelamis Wave Power [54]. Among large-scale technologies, the Pelamis device comprises five circular sections joined by connecting rods that allow the converters to twist in both orientations as they “surf” over the incoming swells. Systems for hydraulic power take-off (HPTO) convert the flexing motion into electricity. The central part of the terminator system is perpendicular to the axis of the incident wave to block the waves [55]. Additionally, PAs are substantially smaller than the typical wavelength of incoming waves. They function as oceanic nodes that can collect wave energy from all directions due to their reduced size, and can be located in shallow water [56]. An OWC is an open structure with an open entrance that captures air above the inner free surface and water level. Two significant types of OWCs are fixed and floating, which are being increasingly used [57].

Previously reported and published algorithms and models for wave energy applications can be divided into three distinct categories: (1) equipment-level algorithms and models including low-level control and monitoring; (2) function-level algorithms and models including wave height and power generation forecasting [58,59] and instability prediction [60,61]; and (3) energy plant-level algorithms and models. Commonly, these applications fall into three main categories: forecasting, optimization, and power management. Wave energy is one of many sectors where machine learning (ML) and deep learning (DL) have been successfully used. A DL framework handles large datasets that account for wave energy characteristics better than other ML approaches. Unlike many other ML techniques, the learnable parameters in DL algorithms can be taught on a graphics processing unit (GPU) and can easily handle pattern recognition. The structure of DL requires more time for training; however, it possesses properties analogous to wave energy.

Using renewable resources and systems to lower harmful environmental consequences, improve economic prospects, and ensure safe operation is one strategy to address the abovementioned issues. An accurate understanding of the deciding characteristics and crucial output parameters of these systems is necessary for their best and most valuable utilization. It is pertinent to test various techniques and models to predict the factors contributing to system productivity and energy management, as renewable systems are significantly affected by their surroundings and environment. In other words, a particular tool is necessary to properly use these data and grasp the links between various characteristics. For instance, in addition to predicting wind speed and direction in coastal locations, it is vital to anticipate wave parameters, such as significant wave height, wave period, and wave direction, to determine the power production of a wave system [62]. Additionally, when electric utilities disperse their extra power, they produce too much carbon dioxide emissions [24]. This adds to the difficulty in correctly predicting the state of health of an industry’s energy distribution infrastructure. Maintenance of the energy supply and demand balance will become a perpetual operational and technical challenge. This brings us to the promise of ML and its potentially substantial influence on the whole energy spectrum [5,24,63,64]. Although ML is still in its early phases of application, its impact on the distribution of renewable energy, projections, and the adoption of smart grids might be significant [65].

In light of the growing body of literature on wave energy based on DL, it would be useful to prepare a review article that summarizes the most up-to-date studies in the field and provides a comparative analysis of the current methods. Therefore, this study provides an overview of the DL-based models currently used for wave energy applications. In this paper, an introduction to various learning algorithms and their classifications is first presented. Then, the application of these algorithms in ocean wave resource prediction, estimation, and optimization is

thoroughly discussed. Datasets, pre-processing approach, model topologies, computation time, and accuracy were compared among the presented models for comparable applications. The models utilized in deterministic forecasting include convolutional neural networks, recurrent neural networks, long short-term memory, deep brief networks, deep neural networks, gated recurrent networks, and deep hybrid models. Data fusion, processing time, contrasting decomposition methods, and statistical testing were measured against a variety of criteria. This study attempts to understand the fundamental variables while summarizing necessary information, such as the potential impact of datasets with varying volumes, locations, resolutions, weather conditions, and periods on the comparison. The learning algorithms pertaining to setting optimization and estimation of the PTO system are also briefly discussed with regard to the most active learning algorithms.

2. Recent advancements of ML and DL in ocean wave energy

2.1. Introduction to machine learning and deep learning techniques

ML is currently the fastest-growing technology and a “hot focus” in several academic disciplines. Even for engineers, data processing and interpretation are becoming more dependent on energy digitization, with a focus on industrialization and smart grid development. The novel data-based services for sourcing, selling, storing, and using renewable energy are called “smart grids.” Energy distribution, the last step of energy supply, benefits from ML’s quick and effective processing of data. ML is beneficial for consumers, infrastructure, energy systems, big data, and transmission systems [62]. This study outlines problems ML can address, current developments, and how it impacts the energy industry. Several ML classes have been introduced to address these issues, with five specific applications in energy distribution discussed. The study emphasizes the role of ML in energy distribution, challenges, future prospects, and recent advancements, enhancing the overall study theme.

Fig. 3 shows the distribution of studies on ocean wave energy and energy systems using ML and DL. Fig. 4 represents the document percentages in ML, engineering, and energy fields. Research primarily focuses on energy and engineering (29% each), with most published as conference papers or journal articles. However, the low percentage of review papers underscores the need for more, a focus of this study.

With the help of ML, power companies and investors can implement

more reliable and profitable processes that boost the return on investment (ROI) and aid in energy transition [67]. Lowering carbon emissions, which is now receiving more attention, may hasten the positive shift in the business and energy sector by utilizing different ML techniques. In this regard, the United States Department of Energy (DoE) and IBM worked together to develop the Watt-Sun program, which monitors enormous amounts of meteorological data from a wide variety of data sources and websites [8]. The main emphasis of ML are on the applications that draw on prior knowledge to enhance prediction and decision-making over time. There are typically four phases of building an ML program: preparing the dataset, technique selection, building the model by determining the objective function, and model training [68]. In addition, as shown in Fig. 5, there are four main types of ML models: supervised, unsupervised, semi-supervised, and reinforcement ML. For better understanding, key classifications, subclassifications, and code implementations are accessible in Ref. [68].

Smart energy systems employ a variety of ML models extensively. Each model is described succinctly in the following sections.

Supervised learning: ML, particularly in image classification and voice recognition, is increasingly important. It plays a significant role in smart power systems by predicting data and loads. This involves mapping input-output pairs with algorithms like regression. A key example is the use of Support Vector Machine (SVM) models to evaluate electrical data from generators and distributed production [69].

Unsupervised learning: ML algorithms in this model function solely on inputs without needing outputs. Data is clustered into related groups to reveal hidden patterns, improving power distribution in grid-based energy systems. This efficient handling of vast unsupervised electrical data is known as energy clustering [70]. The list of these algorithms along with supervised learning methods is demonstrated in Fig. 6.

Reinforcement learning (RL): RL is popular in the energy field due to its independence from predefined datasets. Fig. 7 outlines how RL, much like the Model Predictive Control (MPC) method, can handle uncertainty and generate smart energy predictions. Despite the complexity added to the power grid by renewable energy, RL’s ability to sequentially make decisions amidst thresholds and uncertainties has effectively addressed related challenges [71–73].

Optimization algorithms: Power systems use a range of tools to optimize complex, unpredictable issues. Modern grids employ techniques like stochastic gradient descent and constraint optimization to address

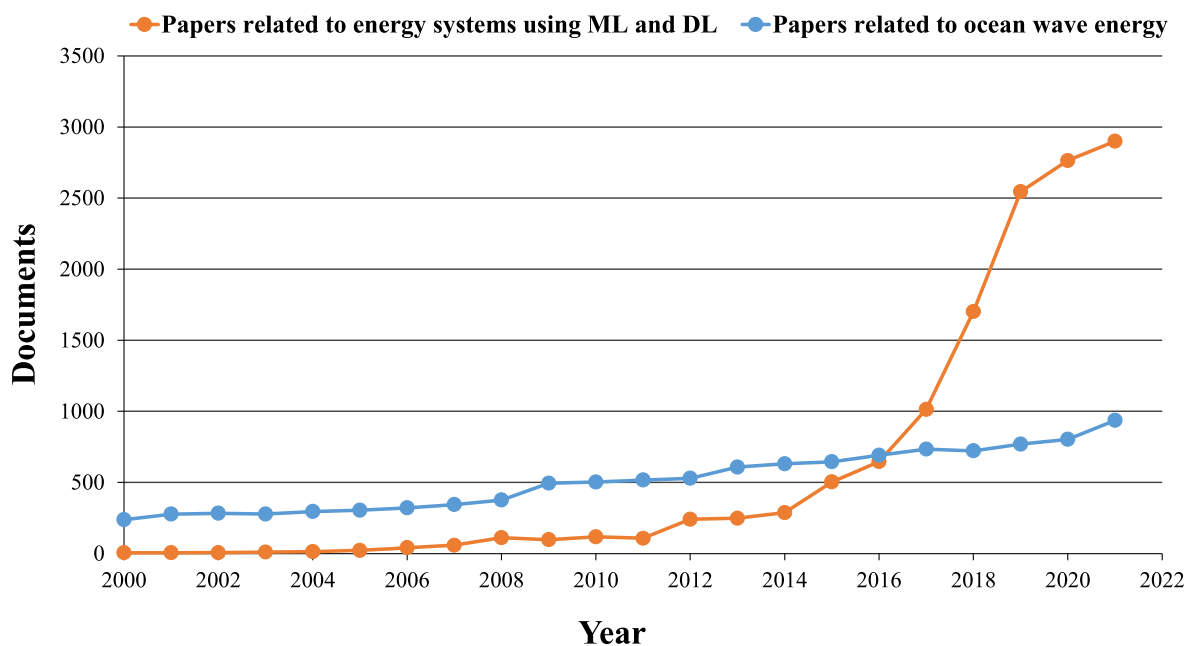

Fig. 3. The number of published papers that used ML and DL to investigate ocean wave energy and energy systems was gathered from the Scopus database [66].

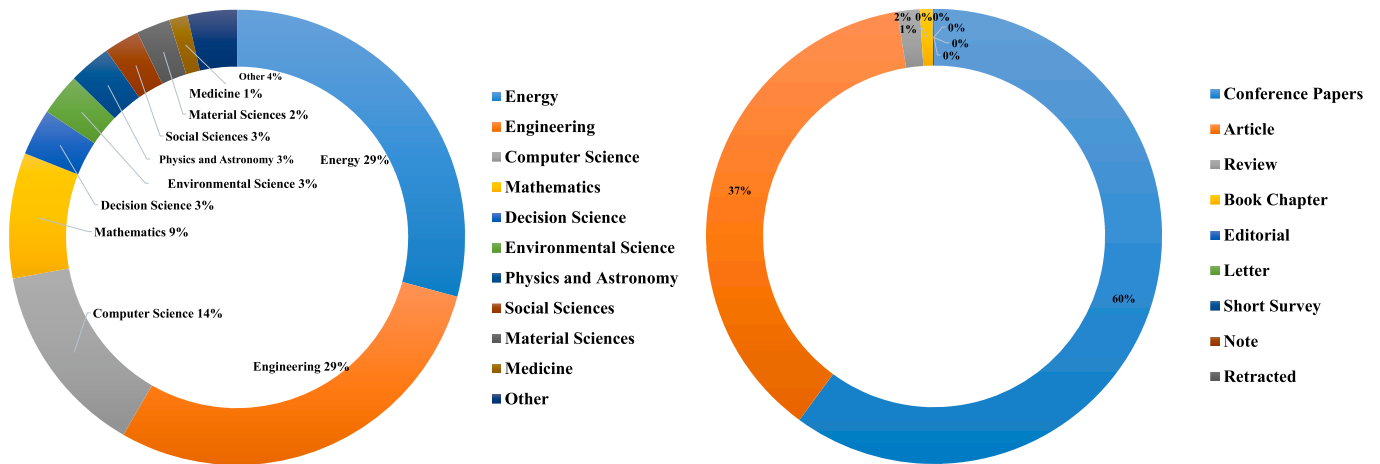

Fig. 4. Document by subject percentage in the field of ML, engineering, and energy (left) and published research percentage classified by their types (right), based on the Scopus database [66].

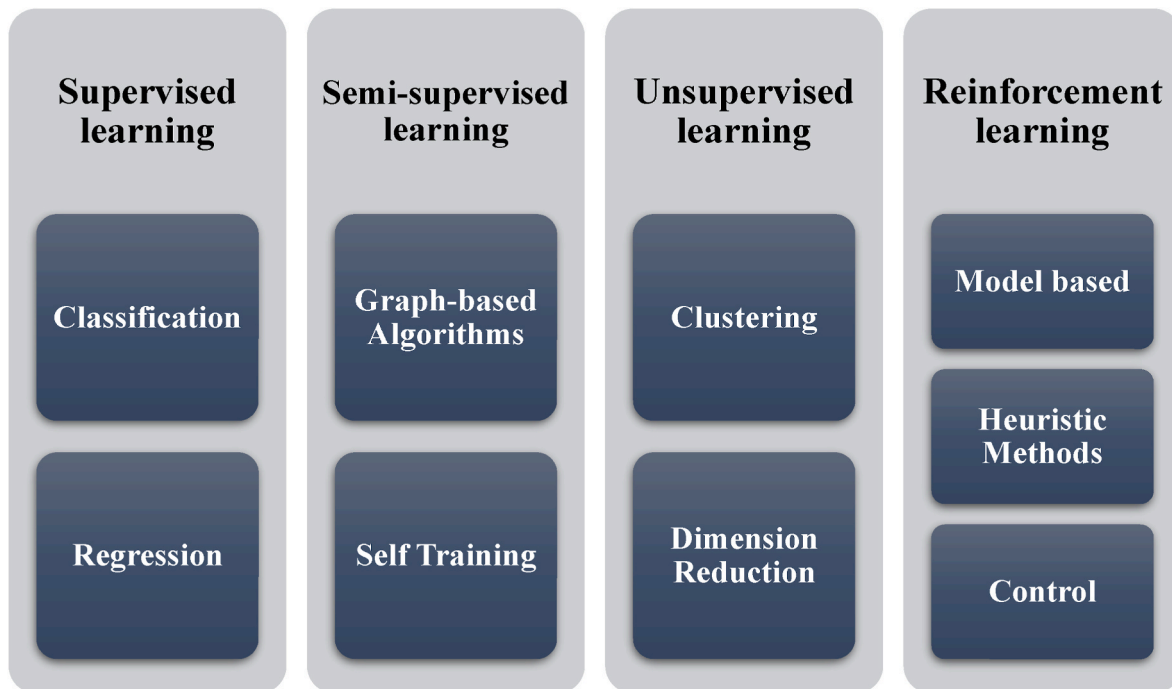

Fig. 5. ML techniques classification.

Optimum Power Flow (OPF) challenges, crucial for energy management and optimization. Tools like linear programming and quadratic programming are used to improve energy and grid infrastructure. These algorithms plan production, operate power systems, model OPF, meet customer demands, and mitigate risks [59,74–77]. Other aspects of optimization algorithms are depicted in Fig. 8.

Deep neural networks: Uncertainty in energy demand forecasting, especially with dispersed generation, is a key research area in smart grids and energy systems. Deep Neural Networks (DNNs), including Convolutional Neural Networks (CNNs), Recurrent Neural Networks (RNNs), and Artificial Neural Networks (ANNs), effectively tackle the dual challenge of high energy consumption and uncertainty [78,79]. Fig. 9 displays the architecture of DNNs.

2.2. Application of ML and DL in ocean wave energy

An assessment of energy strategy, market business plans, storage

systems and transmission, and energy reliability is necessary to improve wave energy technology [80]. Understanding the government’s plans for renewable energy and the construction and operation of forecasting systems is facilitated by this assessment.

Integrating optimization algorithms with ML techniques can provide more accurate results and reduce computational costs when applied to WEC design. ML techniques, such as neural networks, can be used to develop predictive models that can accurately simulate the performance of WECs under different conditions. These models can be trained on large datasets of historical data to learn the complex relationships between various design parameters and the performance of the WEC.

Once the ML model has been developed, it can be integrated with an optimization algorithm to quickly and accurately evaluate different design configurations. One example of this approach is a study by Li et al. [81] They used a deep RL algorithm to optimize the electricity generation of a WEC. The algorithm outperformed traditional model-based control techniques and showed robust performance under

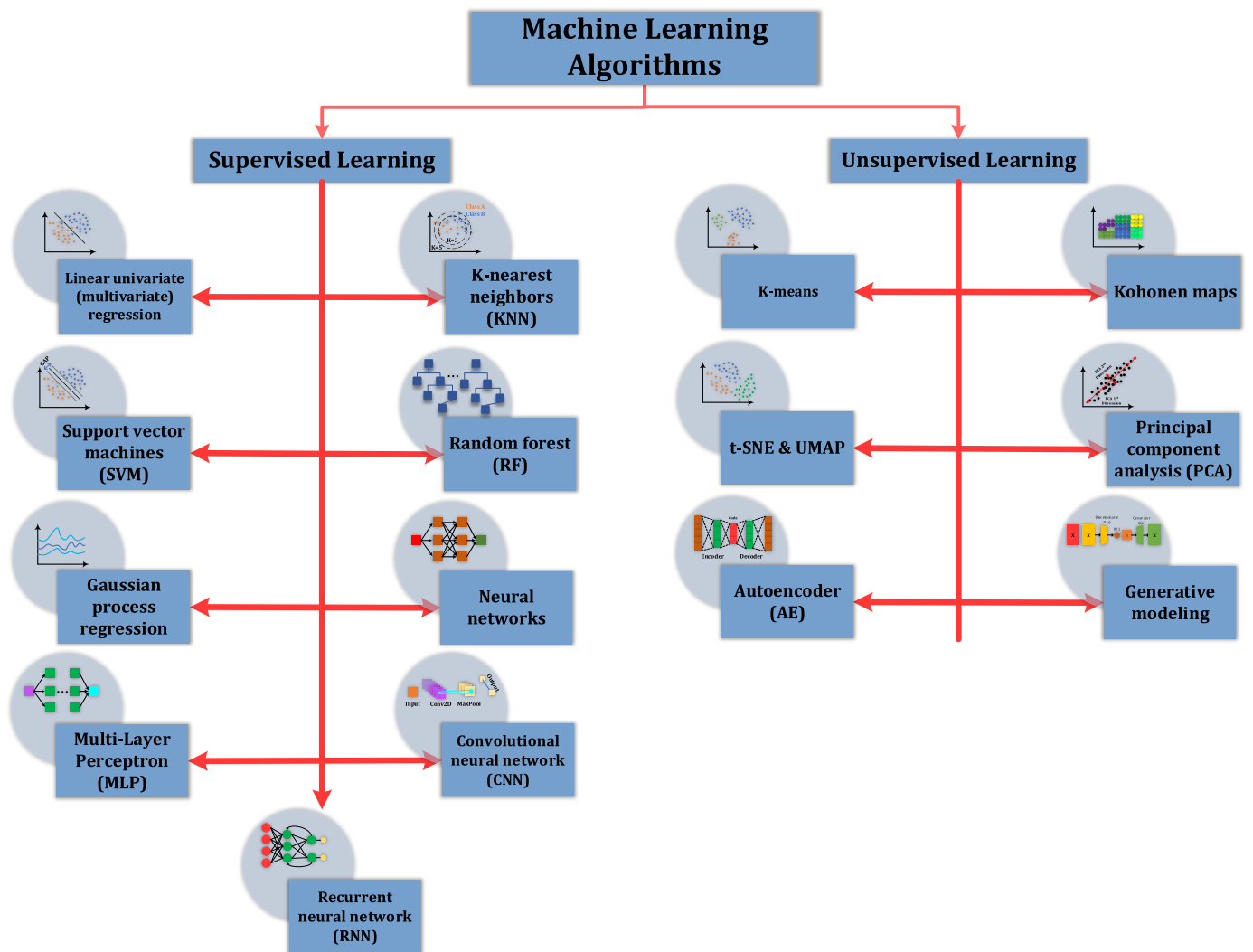

Fig. 6. Supervised learning vs. unsupervised learning.

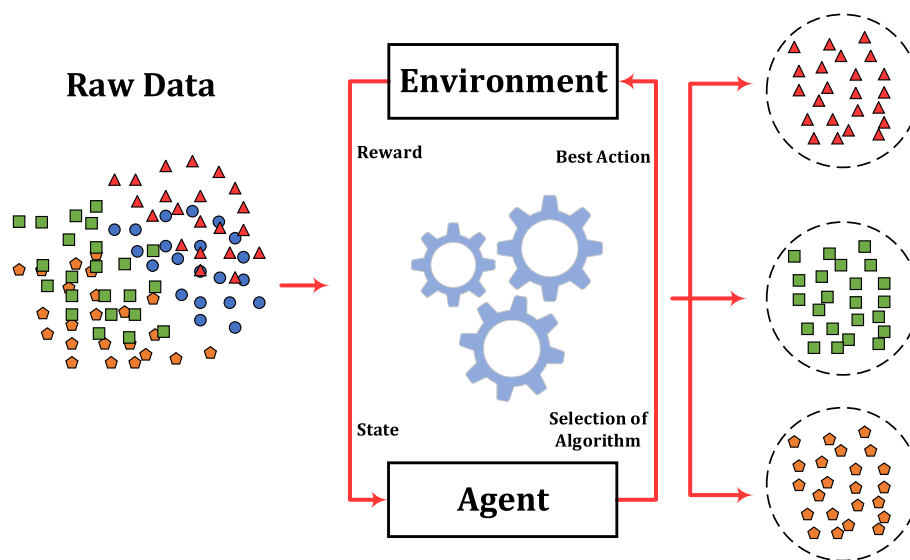

Fig. 7. General overview of reinforcement learning.

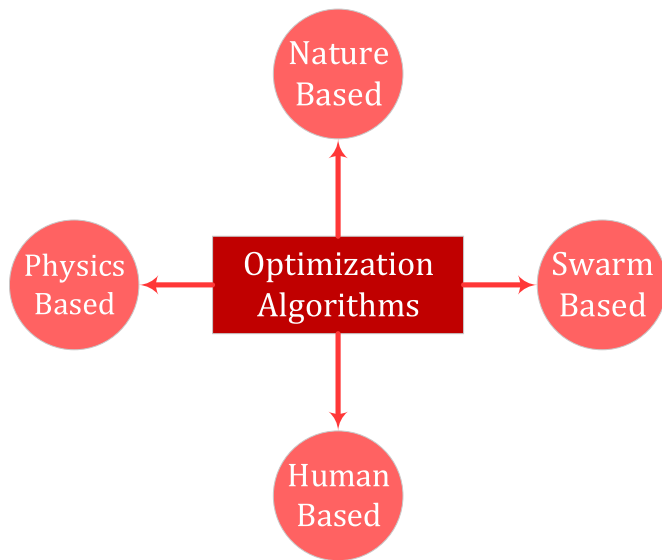

Fig. 8. Optimization algorithms.

ocean conditions. Zou et al. [82] also used a radial basis function neural network-based prediction model and a genetic algorithm-based optimization model to optimize an oscillating wave surge converter (OWSC). This approach was not only capable of optimizing the OWSC, but also had the potential to address other scientific and technical optimization issues. Manawadu et al. [83] numerically investigated the performance of a flap-type OWSC in irregular wave conditions. They used DualSPPhysics to predict the energy conversion efficiency and survivability of an OWSC at a chosen coastal location in Sri Lanka. Their findings highlighted that the PTO damping coefficient, the density of the oscillating flap, and the flap’s shape greatly impact both the energy conversion efficiency and the hydrodynamic forces acting on the WEC, thereby determining its survivability. He et al. [84] established a method for optimizing parameters for oscillating buoy-type WEC, specifically focusing on the volume of the submerged buoy which impacts both power generation and associated costs. They combined the differential evolution algorithm with linear potential flow theory to analyze the influence of submerged buoy volume on optimal power capture.

Their findings revealed that WECs with large PTO damping adapt well to various wave frequencies. However, the ideal submerged buoy volume was found to be not cost-effective due to the relatively high cost indicators. Moreover, Harms et al. [85] addresses the challenge of harnessing low-frequency waves in WEC. They introduced a compact WEC designed for small autonomous sensor platforms. The converter, optimized through simulations and experiments, includes a two-body self-reacting point-absorber and a flux-switching permanent magnet linear machine for PTO. With careful design and optimization, the power output increased from under 10 MW to over 100 MW in simulations. The system’s effectiveness was tested in different wave conditions for a realistic power output estimation. Marques Silva et al. [86] illustrates how an inverse fuzzy model, optimized with a genetic algorithm, can enhance OWC control and performance. The case study, the Mutriku power plant, showed no significant turbine power increase with genetic algorithm fuzzy control, but over 9% improvement in yearly generator power, offering implications for future wave power plant control strategies. In addition, several recent investigations also pointed out the significance of integrating optimization algorithms with ML techniques to provide more accurate results and reduce computational costs [87–90]. To this end, the application of ML techniques in forecasting and optimizing wave energy resources is discussed in the following.

Model application and classification in energy systems were the main topics of the study by Mousavi et al. [1]. When dealing with energy systems, hybrid approaches perform better than classic ML models. Specifically, the Comprehensive Ensemble Empirical Mode Decomposition-Empirical Learning Model (CEEMD-ELM) was developed for forecasting wave heights in order to subsequently estimate wave production [91].

For several reasons, it is crucial to estimate the wave characteristics (height, period, and direction) in both port regions and the ocean. Estimation of open water enables the prediction of hazardous occurrences or events brought on by natural disasters [92,93]. These estimates allow the optimization of vessel paths in terms of logistics, boosting safety, and reducing costs [94,95]. ML-based models may be used to reduce these errors regardless of the complexity of the input data because of their ability to find correlations in the input data. Estimating oceanographic variables using ML techniques has been the subject of several recent studies, thanks to the resurrection of AI models based on “learning by data.” A number of approaches have been proposed, each with its own set of advantages and disadvantages, based on the dataset

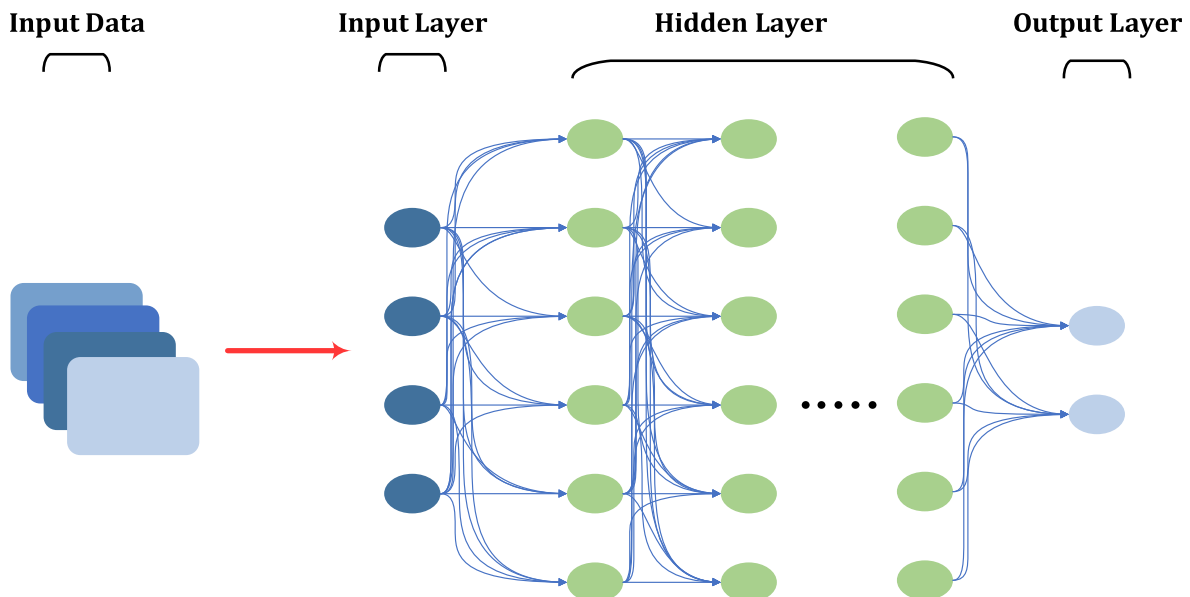

Fig. 9. Architecture of deep neural networks.

from which the prediction model was constructed. Utilizing information from nearby deep-water buoys to approximate a target buoy's measurements is a common practice [96–100].

In situ measurements or remote sensing data are often used to evaluate and calibrate physics-based models. Global-scale modeling currently incorporates data from satellite-based remote sensing, such as the GDAS system [101]. Buoy measurements of waves in real-time have been used to validate physics-based models for shoreline conditions [102]. There are ways to derive spatio-temporal wave data using measurable time-series data and numerical models. ML techniques have been shown to be accurate in predicting numerous environmental factors over the last ten years [103–111]. Moreover, ML algorithms have been used in research to estimate wave energy transfer based on in-situ measurements. In various forecast horizons, ML models have achieved higher precision than physics-based models. In particular, an ANN was employed by Sanchez et al. [112] to predict the height of waves at a buoy station, with a mean absolute percentage error (MAPE) of 5.27%. Sequence-to-sequence (Seq2Seq) and long short-term memory (LSTM) networks were utilized by Pirhooshayan and Snyder [113] to predict significant wave height (SWH) (H_s) and wave energy at several buoy locations. Their suggested methodology surpassed both competing networks and the ML alternative, namely random forest (RF), in predicting H_s with an MAPE of 18.2%.

ML methods can also be applied to map the spatial relationships between environmental elements. Oh and Suh [114] suggested a method that combines wavelet analysis, empirical orthogonal function analysis, and a neural network (EOF-NN) to estimate SWH for the subsequent 24 h at various sites with normalized root mean squared error (RMSE). The term “grey-box” refers to the attempts of researchers to create models based on a data-driven numerical model approach [115]. To train an ML model, these systems include the results of a physical model (like the National Centers for Environmental Predictions (NCEPs)) as features. Nencioli and Quartly [116] established a multimodal method for locating a zone of wave characteristics, which was then validated using a universal wave model. Ibarra-Berastegi et al. [117] used an RF and a numerical model to provide short-term estimates of wave energy transfer from 1 to 24 h at five buoys, with mean absolute log differences

of less than 20–60%. As opposed to traditional numerical model products, relevant ML methods have been shown to be more accurate and need less processing power, providing a chance to enhance the quality and availability of wave data for a wide range of applications. With the use of an RF technique, as shown in Fig. 10, Chen et al. [118] developed a surrogate model that implements an ML strategy on numerical outputs to comprehend the spatial relation among input buoy data at specific locations inside the domain and the whole geographically scattered wave conditions across the domain. Using this strategy, the time required for the calculations was halved. This study demonstrates that the RF model can quickly and precisely estimate wave conditions across a region, and effectively assimilate measured data. This provides additional benefits to existing physics-based wave models, especially in cases where computational power and transmission are restricted, such as with autonomous marine vehicles or during coastal and offshore operations in remote locations.

To better estimate wave height parameters using numerical models at various points along the Spanish coast, Gracia et al. [119] investigated several ML approaches before settling on a pair of models that include both the multi-layer perceptron (MLP) and gradient boosting decision tree (GBDT) methodologies. Their approach, as shown in Fig. 11, illustrates the potential benefits of merging ML and numerical models by decreasing the variance of the numerical model estimations by an average of 36%. Additionally, they mentioned that accurate estimation of wave agitation is crucial for predicting natural disasters, path optimization, and secure harbor operation, and the proposed ML models can help improve the safety and efficiency of port operations. Although this study used numerical models as inputs for the ML models, the accuracy of the ML models depends on the accuracy of the numerical models. Additionally, this paper does not provide a detailed analysis of the patterns used by the ML models to improve the accuracy of the predictions, which could limit the interpretability and generalizability of the results. In another study, Demetriou et al. [120] examined how to train supervised ML models to forecast significant wave heights by combining meteorological and structural data. In the ensemble classifier scenario presented in Fig. 12, they applied ANN and decision tree and found that combining meteorological and structural variables may

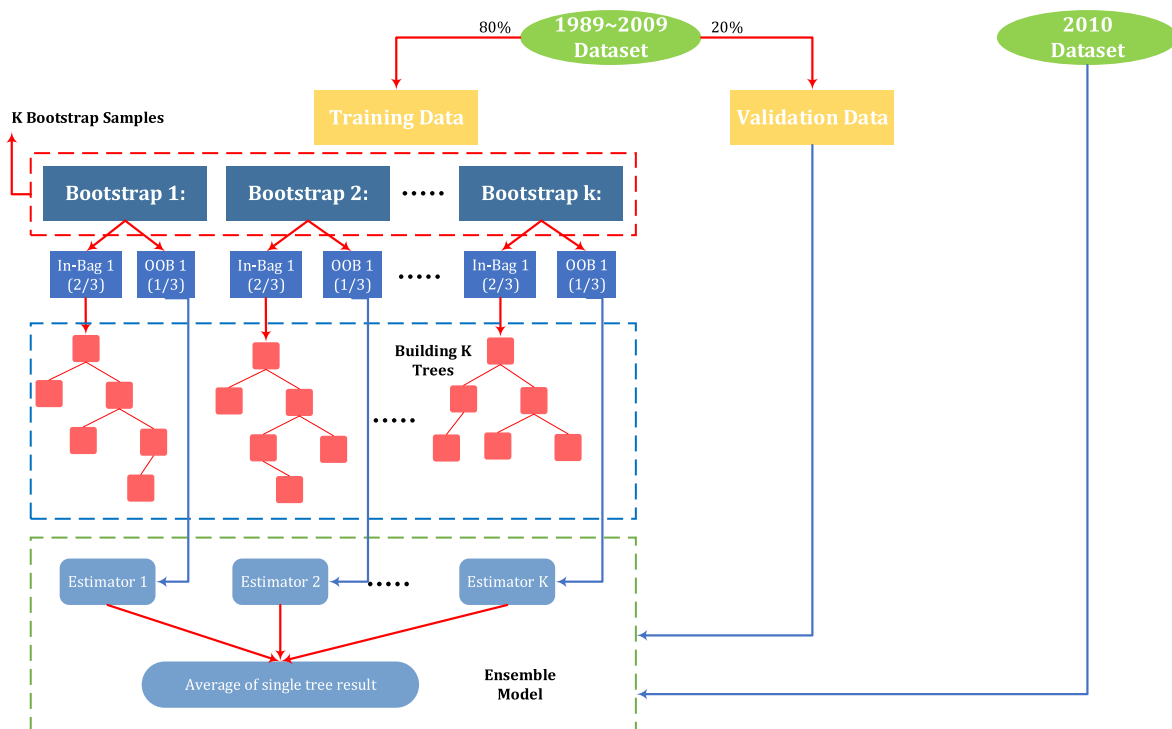

Fig. 10. Random forest regression with in-bag and out-of-bag data for training and not for training, adopted from Chen et al. [118].

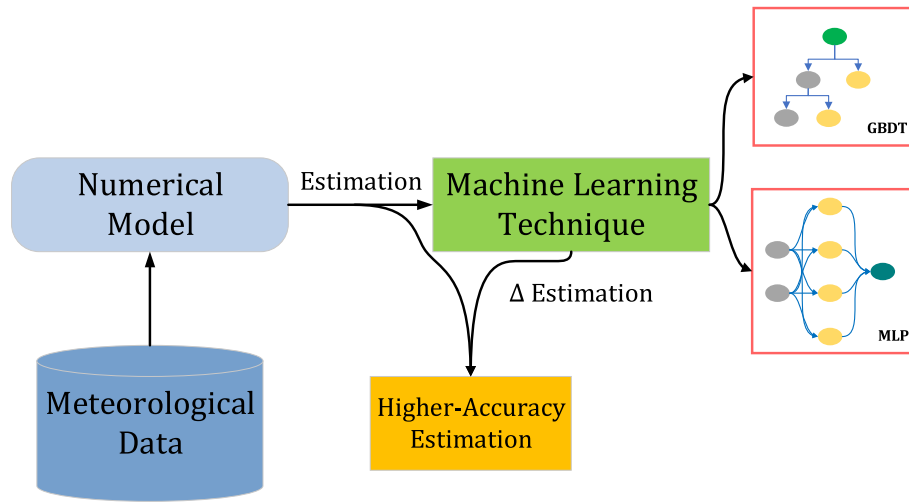

Fig. 11. Increased numerical model accuracy using the ML techniques, MLP, and GBDT, as indicated by Gracia et al. [119].

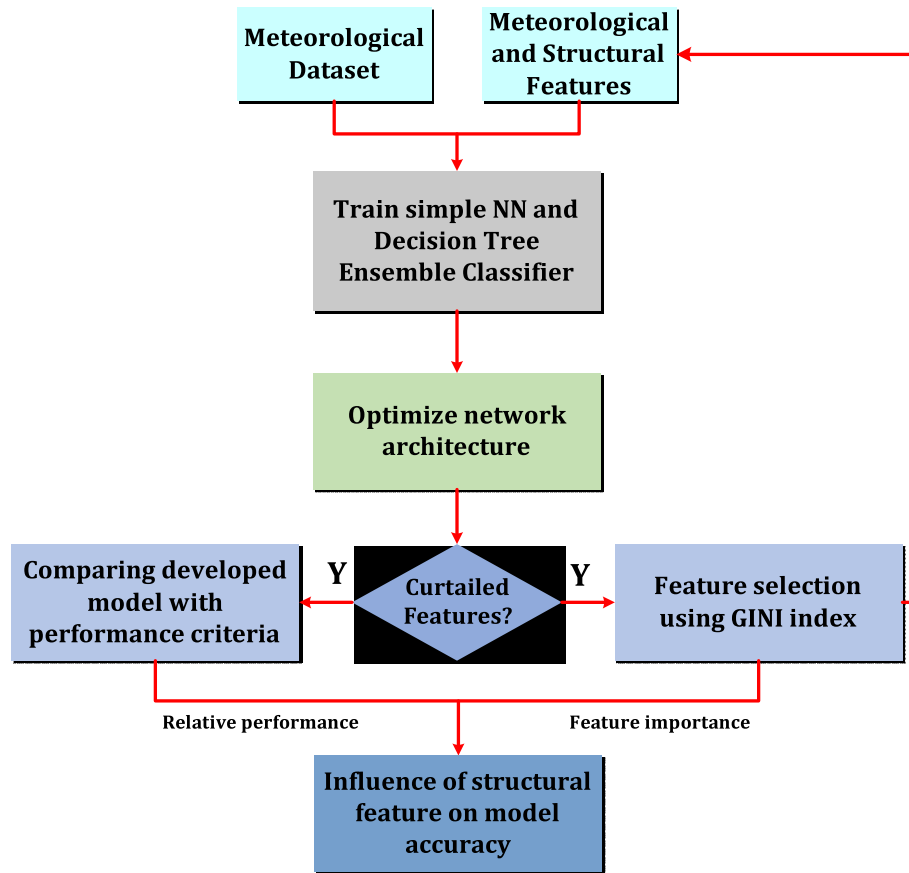

Fig. 12. Significant wave height prediction method proposed by Demetriou et al. [120].

enhance classification performance depending on the network choice. However, it has been suggested that the augmentation of training parameters may introduce undesirable overfitting, thereby lowering model generalization. Using the features of decision tree methods and Gini impurity index, a technique for assessing feature relevance has been put forward to alleviate this disadvantage, reiterating the advantage of structural features for model classification. However, the proposed method may not be suitable for extreme wave events or rare events that are not well represented in the training data. Moreover, this investigation suggests two potential directions for future work: (i) testing the

hypothesis on structures with a more pronounced dynamic footprint, such as surface buoys, which will likely result in higher classification accuracy due to the increased signal-to-noise ratio, and (ii) exploring deeper network techniques that are capable of extracting their own features.

Huang and Dong [112] performed SWH estimation for the short-term forecasting by combining a decomposition technique with an LSTM network. An improved version of the robust ensemble empirical mode decomposition technique and recurrence quantification analysis were used to separate the underlying time-series dataset into deterministic

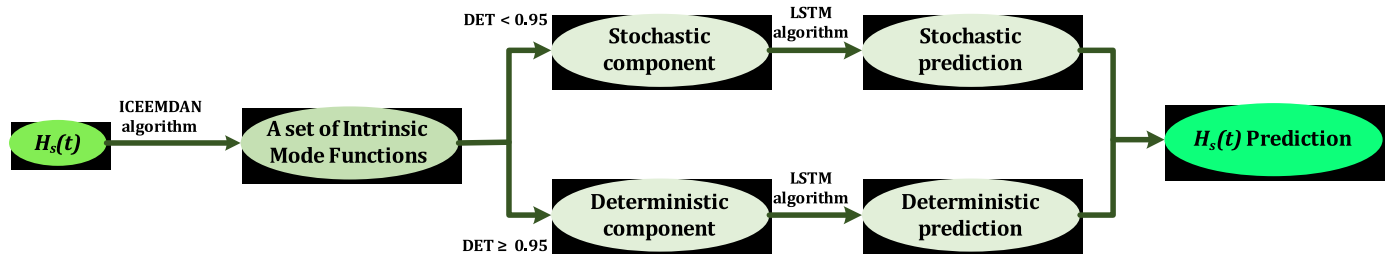

Fig. 13. Short-term prediction of significant wave height enhancement performed by Huang and Huang and Dong [121].

and stochastic components, as illustrated in Fig. 13. In this method, the LSTM network estimates each decomposed series and the combined deterministic and stochastic estimations were applied to obtain the final forecasted SWH. According to their findings, the hybrid model performed better than the standalone LSTM network modified for the un-spliced signal. However, they did not compare the proposed hybrid model with other existing models for SWH prediction, so the generalizability of the findings is unknown. Furthermore, the computational requirements and feasibility of implementing the proposed hybrid model in real-time applications were not discussed. Despite these limitations, they suggested that future work should focus on reasonably

selecting their input climatic factors to improve the proposed hybrid model's performance. Specifically, their investigation recommends investigating the impact of wind speed and direction, air pressure, and water temperature on SWH predictions.

The SWH was highlighted by Yang et al. [122] as the most crucial parameter in determining wave energy. However, accurate forecasting is difficult due to the complexity of the world's oceans and the omnipresent instability of natural ocean waves. As a result, they suggested a hybrid model termed STL - CNN - PE that combines a one-dimensional convolutional neural network (CNN) and positional encoding (PE) with a seasonal-trend decomposition approach based on loess (STL) to

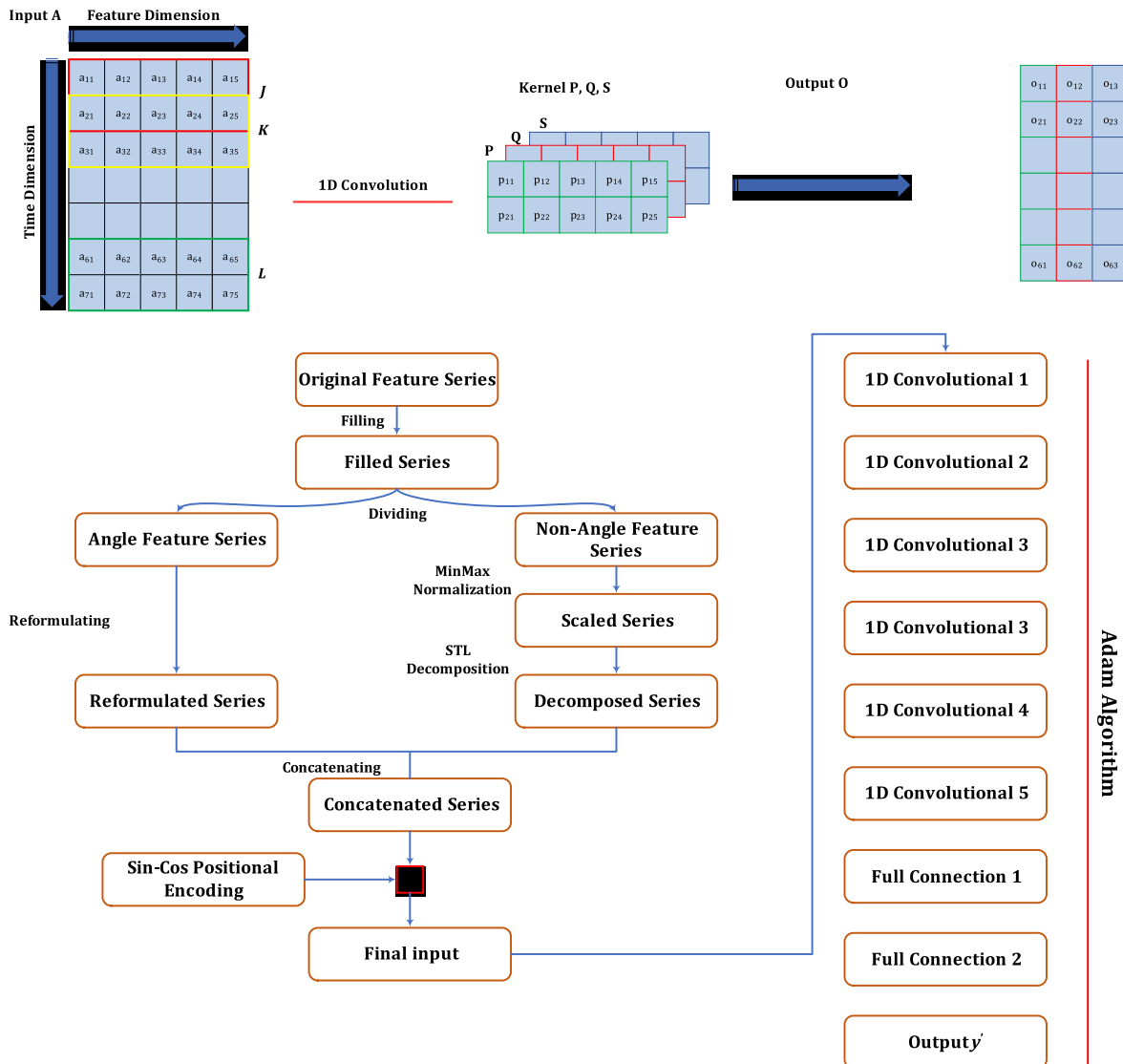

Fig. 14. 1D CNN with the model proposed by Yang et al. [122].

effectively and correctly predict SWH. The suggested technique, shown in Fig. 14, produced more accurate prediction results than the single model. Compared to EMD-LSTM, STL-CNN-PE exhibited a considerable speed advantage and equivalent accuracy. The primary limitation of this study is that the linear interpolation method used to fill in the missing data is oversimplified. In contrast, other advanced data imputation methods handle missing values.

Regressive SVM and MLP were both proposed by Mahjoobi [99] and Etemad-Shahidi [100] for predicting wave height. Krishna-Kumar et al. [98] were able to forecast the daily wave heights in various places using the growing and pruning radial basis function (GAP-RBF) network. The practical side, i.e., when dealing with the proper WEC structural component and working mechanism, and the economic side, i.e. determining the viability of an ocean renewable energy project, depend on an accurate mapping and quantification of the wave energy at certain sites. This is sometimes done by examining data from buoys and, at other times, by employing numerical models of the deep ocean.

Many researchers have been searching for appropriate ways to precisely anticipate the oceanographic parameters, focusing on wave energy production and wave height. Analogous to several time-series datasets, the published works on this topic includes soft computing, conventional statistical approaches, physics-based (numerical) models, and hybrid methods. Physics-based (numerical) models outperform others over long periods and across broader horizons [123]. The

capacity of numerical models for forecasting the sea-state parameters has significantly improved due to the rise in sea-state parameter data and the ongoing breakthroughs in simulating the ocean waves dynamically [124].

Regarding statistical and soft-computing methods, neural networks (NN) with tailored input selection models have proven to be effective [125]. The European Center for Medium-Range Weather Forecasts (ECMWF) wave model was evaluated by employing MLP for 13 datasets [126]. Both ECMWF and the physics-based models were effective; however, the physics-based model had a smaller margin of error for forecasts with lead periods greater than 5 h. In addition, RNNs are among the best methods for predicting time series. Desouky and Abdelkhalik [127] and Sadeghifar et al. [128] used a network incorporating a nonlinear autoregressive exogenous (NARX) model to forecast waves in the Caspian Sea and two locations along the Hawaiian Peninsula. Exposing various time-series properties through wavelet processing or wavelet NN is a popular technique to enhance the estimation precision [129,130].

Additionally, current methodologies have been kept up with soft computing techniques like SVM, ELM, sequential learning NN, fuzzy genetic algorithms, and ML applications [131,132]. When attempting to estimate the wave height in the Caspian Sea, the symbiotic organisms search (SOS) was proposed by Akbarifard and Radmanesh [133] to tune the factors of the forecasting systems. In addition, Duran-Rosal et al.

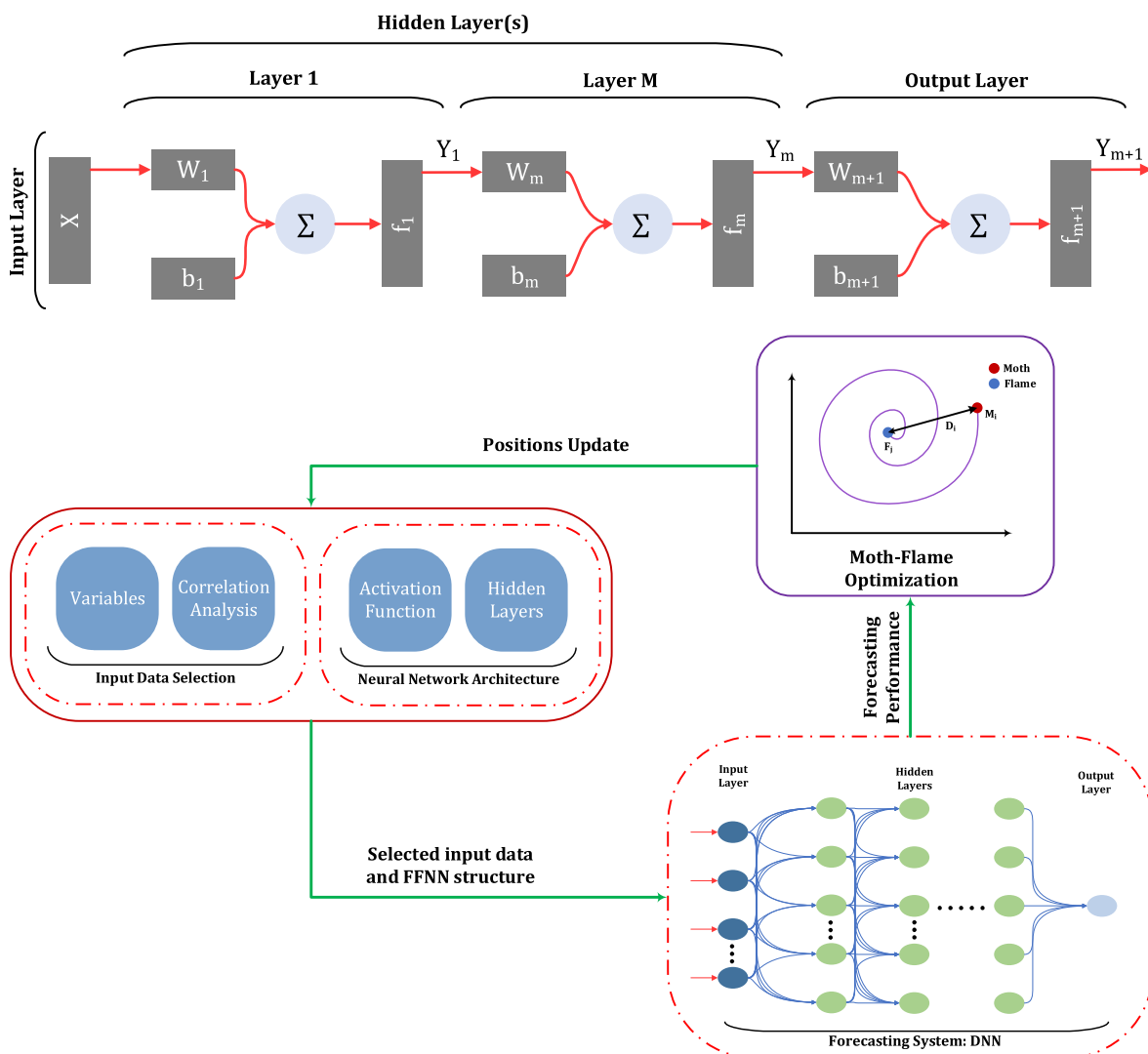

Fig. 15. A standard multi-layer feedforward neural network architecture and DL technique with an MFO algorithm, adopted from Bento et al. [135].

[134] used a multi-objective evolutionary algorithm (MOEA) to train a NN classifier using hybrid basis functions to forecast imperative wave height segments. As a result of these studies, Bento et al. [135] developed a novel strategy using a Deep NN as the optimal prediction engine. An advanced moth-flame optimization (MFO) technique was developed to optimize the system automatically. As shown in Fig. 15, their proposed approach applies forecasting skills to assess 13 datasets from sites across the Gulf of Mexico. Their network worked well at each location, over short-term views, surpassing statistical and numerical techniques. The proposed methodology can be used to forecast wave energy flux and other wave parameters, which is crucial for integrating wave energy into power grids. However, forecasting accuracy may be affected by external factors such as extreme weather events, which are difficult to predict. This paper also does not provide a detailed analysis of the economic feasibility of wave energy forecasting using the proposed methodology. Estimating the power production of an economical WEC named “Searaser” using a DNN and an LSTM layer, as depicted in Fig. 16, was investigated by Mousavi et al. [136]. They established a scatter plot for power production by wind speed and used intermediate values to predict power production at different wind speeds. Their findings showed that the LSTM network is more accurate and faster at predicting power in terms of height than numerical solutions. Their results provided a significant relation between wind speed and output power, which was a main limitation in the previous studies. They also offered future work plans, including, investigating the effect of different wave conditions on the power output, comparing the proposed LSTM with other ML techniques, developing a control system for the Searaser WEC, and conducting experimental studies to validate the results of the proposed LSTM method. Similarly, Jorge et al. [137] integrated bathymetric data with LSTM neural networks to forecast and recreate shoreline SWH. Specifically, they utilized bathymetric data from 2004 to 2017 with respect to the ETD sandbanks and the sea state time series and meteorological data from nearby buoys. The network was adjusted using Bayesian hyperparameter optimization. The quality of LSTM for significant wave height recreation, short-term forecasts, and long-term forecasts increased with the inclusion of the bathymetries by 16.7%, 7.4–11.7%, and 8.8–9.1%, respectively, in terms of RMSE. Deep FFNN and other cutting-edge ML techniques were far behind LSTM. The suggested technique for SWH reconstruction employs a parallel LSTM structure (P-LSTM), which has an RMSE of 0.069 m.

Liu et al. [138] proposed a prediction model using genetic algorithms and ML techniques in the simulation of ocean waves. The main aim of this study is to demonstrate converters in various wave periods, wave heights, and water depths. Their investigation resulted that additional technological issues in this sector could be solved by improving

converters. Gomez-Orellana et al. [139] developed a new software tool with a user-friendly guidance interface to estimate outcomes by combining meteorological data from two sources, in which they utilized the most up-to-date ML techniques. Butt et al. [140] offered a brand-new approach to forecasting systems using artificial intelligence and found that the impact on the systems during the following 24 h would be practical in terms of enhanced maintenance procedures. Cheng et al. [141] employed a long short-term memory (LSTM) approach to estimate electricity consumption. After testing three different AI techniques, the results showed that the prediction errors of the LSTM, that is, the MAPE, decreased by 21.8%. Lin et al. [142] investigated and improved the energy prediction of systems using LSTM error. They concluded that the output findings of the LSTM algorithm are more reliable and precise than those of preceding techniques.

The duration of a wave’s strength may vary greatly from a few seconds to several decades. The need to consider WEC optimization, PTO control, survivability, and power forecast and management partly arises from this high temporal variability. Temporal variations can be divided into three distinct time frames: short-, medium-, and long-term. The height, timing, and direction of the short-term fluctuation are randomly altered and may range from seconds to minutes. Since the issue of controlling WEC is usually not causal, Fusco and Ringwood [143] investigated the need for short-term prediction in real-time control. Several prediction techniques are described in Refs. [143–147], including the Bayesian learning approach and the autoregression model (AR), autoregressive with exogenous input (ARX), autoregressive moving average model (ARMA), autoregressive moving average with exogenous inputs (ARMAX), and NARX techniques. Additionally, short-term volatility causes a high peak-to-average energy ratio and highly variable instantaneous wave power, necessitating additional design work to stabilize the WEC collected energy, for instance, PTO technology with accumulators for smoothing high-frequency power. An hourly and/or daily shift in the wave spectrum is an example of a medium-range alteration. Precise wave estimation over 1–72 h is needed for energy projection and WEC maintenance since such variance may cause issues with the energy treatment system of WEC farms [148]. Wave power is more predictable than other renewable energy sources [149], and the significant wave height can be correctly estimated for up to two days in advance [150,151]. Additionally, connecting WECs with wind turbines or constructing WEC arrays helps to smooth power production around medium-range fluctuations. Long-term variability refers to monthly, seasonal, and inter-annual variability as well as intra-annual and inter-annual variability. Inter-annual variability also includes wave energy changes over decades. The wave strength is typically highest in winter and lowest in summer. Determining deployment locations and

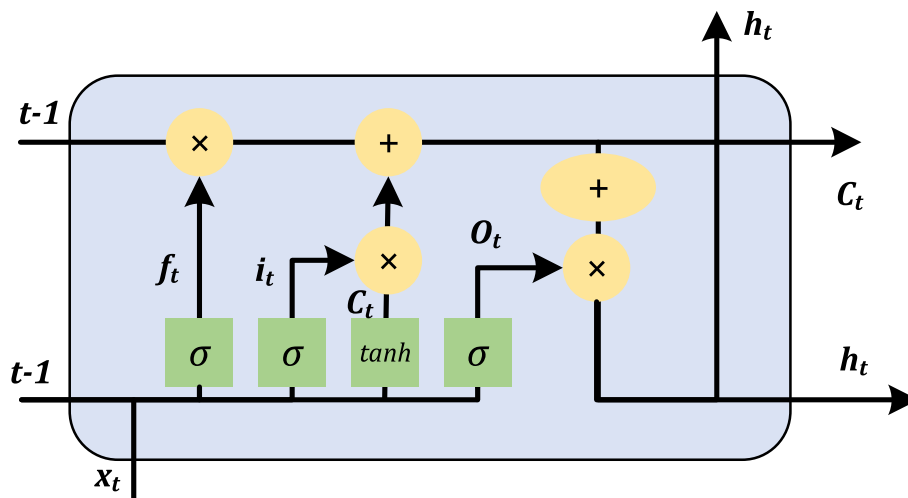

Fig. 16. Architecture of an LSTM layer in a recurrent neural network, adopted from Mousavi et al. [136].

design capacity ratings should consider inter-annual variability because it significantly affects the lifespan performance of WEC farms [152–155]. To construct renewable energy technologies, Penalba et al. [156] researched data-driven long-term met ocean data forecasting, which includes the study of wave, wind, current, and tidal conditions. Short-, medium-, and long-term assembled ocean data were used to establish the forecasting horizons. To make predictions, they used three distinct ML methods, including RF, SVM, and ANN, as illustrated in Fig. 17. The historical resource is characterized in the Bay of Biscay, including the different long-term trends identified based upon the dataset obtained via the SIMAR model ensemble. An alternative interval prediction approach is presented for three other wave height discretization levels, showing more significant potential for long-term met ocean data forecasting. The study concluded that the three ML models successfully reproduced the dataset’s general trend but had trouble duplicating specific peak values. This investigation also suggested that a more thorough study of the alternative classification approach will significantly improve the results. Another alternative for future studies could be a hybrid model that integrates a statistical prediction model with a long-term data-driven correction model.

To forecast the output of a WEC, Ni et al. [157] employed DL techniques. When comparing various DL approaches, they found experimental evidence that high-frequency waves could immediately impact modeling efficiency. In the simulations presented in the latest studies, a strong relation between wind speed and output power was proposed, which realized two crucial issues in WEC enhancements and electrical power output, including the development of a precise estimation for optimizing efficiency and predicting energy output directly from wind speed. Another study by Ali et al. [158] compared DL models with advanced extreme learning machines (AELM) for forecasting peak wave energy periods. They designed an ELM model using the partial auto-correlation coefficient-based lagged inputs to generate a half-hourly peak wave power period (T_p). M5tree, conditional maximization-based multiple linear regression (CM-MLR), MLR, and DL models, such as CNN and RNN, were compared to demonstrate their predictive potential. Their findings revealed that the ELM model could produce considerably precise estimations of the half-hourly T_p in a selected coastal study zone, compared to the DL method. However, the study only considered the T_p as the forecasting parameter, and other parameters that affect wave energy generation, such as wave height and direction, were not considered. Fig. 18 presents a graphical flowchart of the proposed approach [158]. Other recent investigations focusing on wave characteristics and wind speed prediction and estimation utilizing ML and DL techniques are presented in Table 1. As can be seen, most studies used DL approaches, such as CNNs and RNNs, with different preprocessing techniques to accurately predict several vital

meteorological parameters in WEC power production.

Although several different WECs have been developed and deployed over the years, the high levelized cost of energy (LCoE) of converting waves into useable electricity means they are not yet commercially feasible [169]. To this end, several control techniques have been presented in the scientific literature [170]. In light of this, Zou et al. [171] designed a control system for advanced WECs that boosts the efficiency of wave-to-wire power transmission (global point of view). Their goals included creating a dynamic modeling of the wave-to-wire behavior of a WEC and an accompanying numerical scheme, for the performance validation of the proposed control scheme using RL in natural ocean conditions. The recommended model is shown graphically in Fig. 19. The results revealed that RL improved the power quality from 23% to 84% regarding operating efficiency and power variation.

Li et al. [172] created an AI-based constraint non-causal wave energy control technique, addressing non-causality by employing AI to predict future wave forces online. Using the previous free-surface elevation, they made an FFNN to estimate the forthcoming wave load. In their study, a real-time discrete control method was devised and applied in a bi-oscillator WEC while considering the response amplitude restrictions. A state-space hydrodynamic model was used to simulate the dynamic response and the wave power extraction. The decrease in power extraction is mainly due to phase error, while amplitude error has a minimal effect. The WEC oscillation is amplified as the resistance load of the PTO system is offloaded occasionally. The PTO system converts the relative motion between the two oscillators into energy. In this study, the PTO system is represented by a linear damper. After the PTO is reloaded, the WEC oscillation is amplified, thus increasing the efficiency of wave power capture. A link between the power capture efficiency and the constraint on control was also identified. Finally, their findings showed that the devised real-time control method improved the power collection significantly at the cost of increasing the system’s motion. Fig. 20 illustrates the proposed model.

Amini et al. [173] aimed to optimize the HPTO system parameters for a point absorber WEC in the wave dataset in Perth, on the Western Australian coasts. The study used ten optimization approaches, including the Nelder-Mead search method, Active-set method, Sequential quadratic Programming method (SQP), Multi-Verse Optimizer (MVO), and six modified combinations of genetic, surrogate, and fminsearch techniques, to solve the nonlinear problem and identify the HPTO system parameters that yield the greatest power output. Their investigation also examines the effect of HPTO parameters, namely the piston area, volume, and pre-charged pressure of the low-pressure gas accumulator (LPA) and the volume of the high-pressure gas accumulator. The main finding of this study was that power output appears to be a function of wave height. The combination of modified genetic and

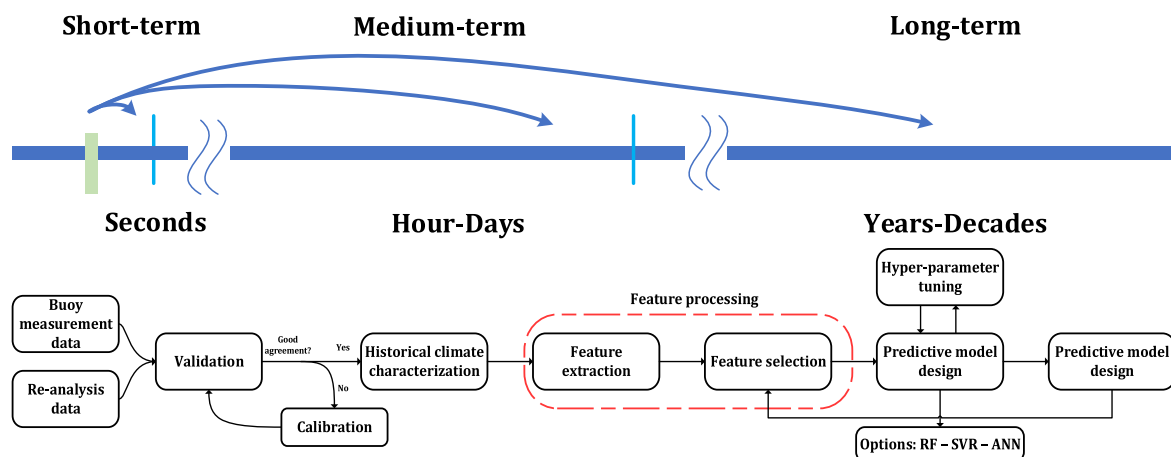

Fig. 17. Forecasting ranges and methodology proposed by Penalba et al. [156].

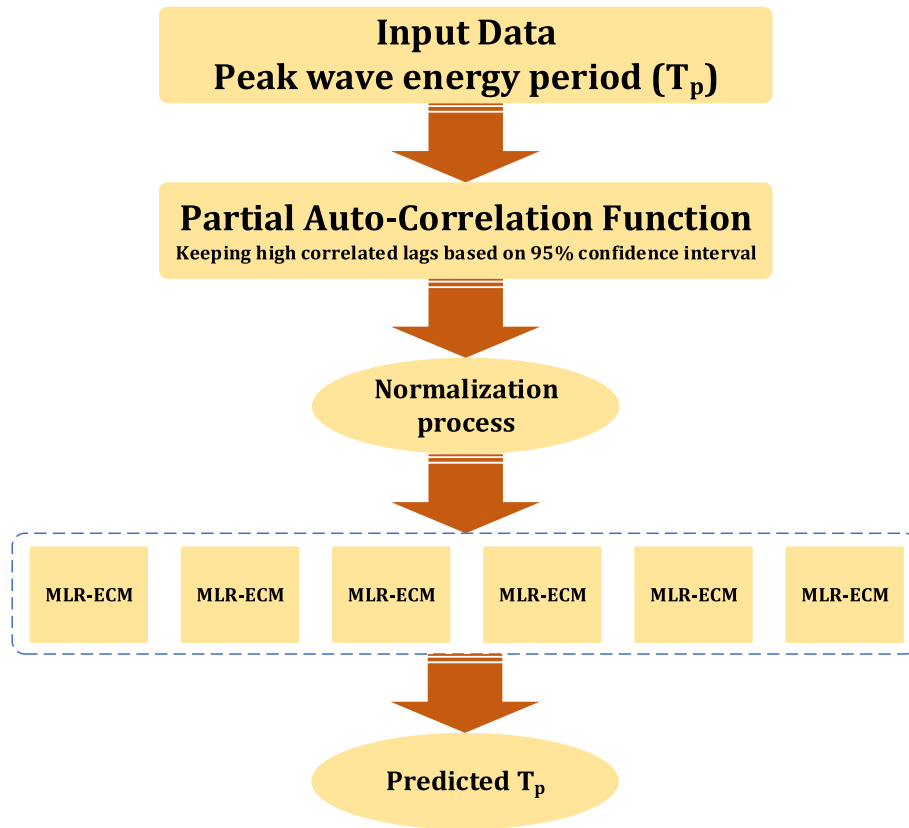

Fig. 18. Peak wave energy period forecasting method presented by Ali et al. [158].

Table 1
Recently published papers for predicting wave characteristics and wind speed using DL techniques.

Author(s)	Predicted parameter(s)	Method	Pre-processing technique	Refs.
Meng et al.	Wave height, wind speed	BiGRU	–	[159]
Wang et al.	Mean wave period	DNN	Standard deviation	[160]
Wei et al.	Wave conditions	LSTM	Standard	[161]
Saxena et al.	Offshore wind speed	CNN; LSTM; Bidirectional LSTM	EEMD	[91]
Chen et al.	Wind speed	CNN + LSTM	ELM	[162]
Hu et al.		LSTM-DE + HELM	DE	[163]
Wei et al.		CNN + GRU		[164]
Yan et al.		Hybrid LSTM + DBN	Singular spectrum decomposition	[165]
Zhang et al.		Casual convolutional gated recurrent unit	Multiple decompositions	[166]
He et al.		MLP, LSTM, ARIMA	EMD	[167]
Golparvar et al.		Gaussian Process Regression	–	[168]

surrogate models and fminsearch function were found to be the most effective in the studied wave scenario in terms of the interaction between the variables of the PTO system.

Bruzzone et al. [174] suggested the application of a RL algorithm with the Q-learning technique to manage an onshore wave energy converter to optimize electric power production in the sea state. The proposed OWC WEC had a straightforward and economical design featuring a floating rocker arm that oscillates and moves a 4-bar linkage

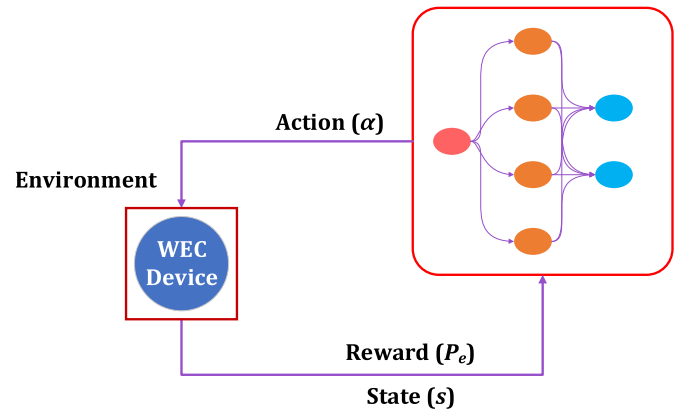

Fig. 19. Block diagram of the DRL control, adopted from Zou et al. [171].

in the vertical plane, as well as a mechanical rectifier composed of two one-way clutches and a multiplier gearbox, which define the PTO system. They also used the RL algorithm to adjust the generator speed-torque ratio dynamically. In their study, the hyperparameters of the RL algorithm were modified to improve the speed of convergence and the quality of the generated power. Furthermore, using off-the-shelf transmission elements and avoiding linear electrical generators lead to a lower cost.

Another studies by Anderlini et al. [175] and Anderlini et al. [176] focused on the control of point absorber WEC using the RL algorithm. A HPTO unit is selected due to its robustness, capacity for energy storage, and speed control. They suggested using RL for the real-time, model-free optimal control of WECs. The aim was to create an RL-based passive control system utilizing the Q-learning algorithm, focusing on a single, axisymmetric device for simplicity and examining only heaving

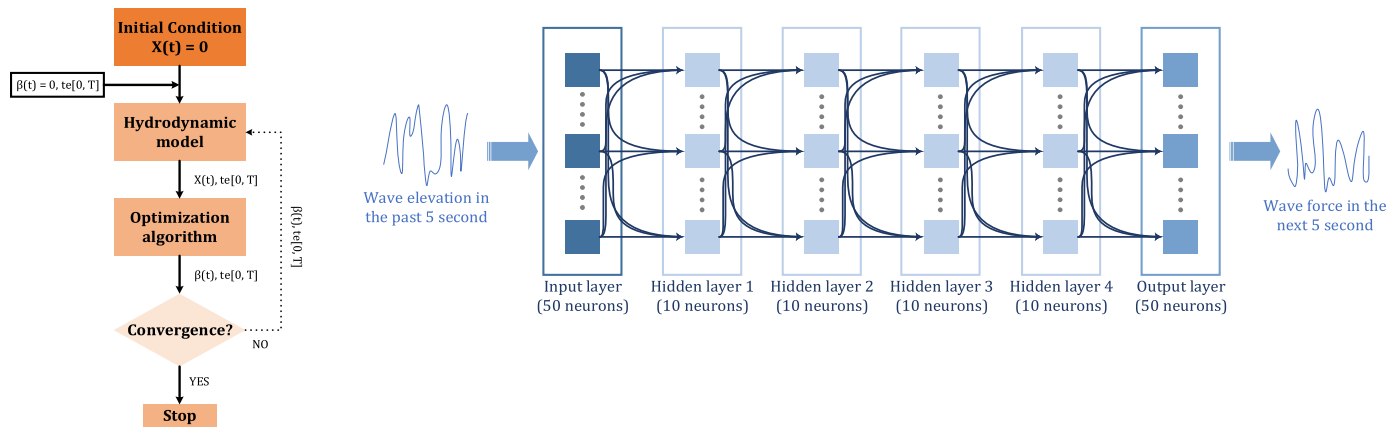

Fig. 20. Process of optimal declutching control algorithm and feedforward backpropagation ANN for wave force forecasting presented by Li et al. [172].

motions. The primary purpose of using RL was to find the optimal control policy for the WEC by maximizing the expected cumulative reward. Thus, the study only concentrated on developing RL-based passive control, and other control strategies, such as latching or predictive control, were not compared. In addition, they only assumed that the force and displacement constraints are not reached to a threshold values in all cases; therefore, the performance of the proposed algorithm under extreme conditions was not evaluated.

3. Conclusion

With rapid population growth over the past few decades, the rising energy demand and energy usage in different areas are apparent. Thus, there is a pressing need to fulfill this demand with renewable energy sources due to the scarcity of fossil fuels and the rapid development of new technologies in recent years. Variability and unpredictability in utilizing renewable energy are directly attributable to the effects of climate change. Therefore, it is pertinent to forecast the power output of systems that employ these resources to strike a balance between the supply and demand of energy. Because of this, there are now fascinating new opportunities and threats to energy infrastructure. The introduction of sophisticated new devices like “smart” grids, “smart” sensors, and so on has also resulted in the discovery of a wealth of formerly untapped statistical data. In recent years, it has become crucial for wave energy converters to use historical data to achieve their primary objectives. Consequently, data-driven models based on AI have contributed to accelerating the process and enhancing approaches to satisfy this requirement and energy consumption. In recent years, significant progress has been made in the latest and practically relevant AI models, namely, ML and DL.

Nowadays, numerous industries and applications employ ML and DL techniques, including the wave energy sector. This discipline particularly focuses on short-, medium-, and long-term forecasting, as well as optimization-related subjects. This research demonstrates that ML and DL architectures provide satisfactory performance for such applications. However, every model has advantages and disadvantages and should be used only when certain conditions are met. Because of the superior performance of each model in a distinct setting, it is challenging to employ a single model.

This study highlights current ML and DL experiments for substantial wave energy converters and wave characteristic prediction applications. This study suggests that various algorithms should be used more often in particular sectors. For instance, the ANN method has been utilized in most of the published optimization studies. The SVM, ANN, MLP, and Random Forest techniques are primarily trained to determine wave features, especially in terms of ensemble learning. In addition, the ocean wave energy industry may extensively use several recent DL algorithms due to their various characteristics and advantages. Some of these

algorithms, including CNN and RNN with LSTM and GRU layers, may be utilized in this industry to solve issues that are sometimes quite complicated and have a data shortage. We anticipate that more publications and research will employ these methods as DL develops, and this subject advances. It should be emphasized that the majority of research done in the area of predicting wave features is concerned with short-term time horizons. These investigations aim to produce an expanded model that increases prediction accuracy, decreases error, and shortens computation time and expense.

In this paper, we have made an effort to review all the algorithms, from the most recent and least discussed to the most widely used. This study indicates that additional research is needed on various subjects, such as long-term predictions of wave features and wave energy generation. The real-time control of WEC devices has enabled the latest developments. To achieve this, many methods using ML and DL models, including ANN and deep RL, have been developed. These methods strive to enhance the latching and declutching control of PTO systems. However, there are not enough studies for estimating energy production employing AI-based algorithms in optimized PTO systems. Despite projecting the yearly energy output using AI-based algorithms, some research concentrated on optimizing PTO settings without anticipating the power production changes created by these devices. Therefore, it is essential to focus on these subjects in future research. Moreover, future researchers are advised to make efforts, document the outcomes of their work reports, and couple mathematical and empirical models with ML and DL algorithms to further enhance this study area.

Declaration of competing interest

The authors declare that they have no known competing financial interests or personal relationships that could have appeared to influence the work reported in this paper.

Data availability

Data will be made available on request.

References

- [1] A. Mosavi, M. Salimi, S. Faizollahzadeh Ardabili, T. Rabczuk, S. Shamshirband, A. R. Varkonyi-Koczy, State of the art of machine learning models in energy systems, a systematic review, *Energies* 12 (7) (2019) 1301.
- [2] K. Shivam, J.-C. Tzou, S.-C. Wu, A multi-objective predictive energy management strategy for residential grid-connected PV-battery hybrid systems based on machine learning technique, *Energy Convers. Manag.* 237 (2021), 114103.
- [3] N. Somu, G.R. Mr, K. Ramamritham, A deep learning framework for building energy consumption forecast, *Renew. Sustain. Energy Rev.* 137 (2021), 110591.
- [4] T. Ahmad, R. Madonski, D. Zhang, C. Huang, A. Mujeeb, Data-driven probabilistic machine learning in sustainable smart energy/smart energy systems: key

- developments, challenges, and future research opportunities in the context of smart grid paradigm, *Renew. Sustain. Energy Rev.* 160 (2022), 112128.
- [5] M.M. Forootan, I. Larki, R. Zahedi, A. Ahmadi, Machine learning and deep learning in energy systems: a review, *Sustainability* 14 (8) (2022) 4832.
- [6] M. Li, et al., State-of-the-art review of the flexibility and feasibility of emerging offshore and coastal ocean energy technologies in East and Southeast Asia, *Renew. Sustain. Energy Rev.* 162 (2022), 112404.
- [7] B. Yang, et al., Wave energy converter array layout optimization: a critical and comprehensive overview, *Renew. Sustain. Energy Rev.* 167 (2022), 112668.
- [8] Irena, Innovation Landscape for a Renewable-Powered Future: Solutions to Integrate Variable Renewables, International Renewable Energy Agency Abu Dhabi, United Arab Emirates, 2019.
- [9] T. Mai, et al., Renewable electricity futures for the United States, *IEEE Trans. Sustain. Energy* 5 (2) (2013) 372–378.
- [10] C. Dsire, Database of State Incentives for Renewables & Efficiency, NC State University, 2020.
- [11] S. Undated, "Utility Carbon Reduction Tracker," *Smart Electr. Power Alliance* [Httpstinyurl.com/Comp8kxy69](http://stinyurl.com/Comp8kxy69).
- [12] G. Mutezo, J. Mulopo, A review of Africa's transition from fossil fuels to renewable energy using circular economy principles, *Renew. Sustain. Energy Rev.* 137 (2021), 110609.
- [13] Global Overview." [https://www.ren21.net/gsr-2023/..](https://www.ren21.net/gsr-2023/)
- [14] REmap 2030 Full Report, Jun. 01, 2014. <https://www.irena.org/publications/2014/Jun/REmap-2030-Full-Report>.
- [15] K. Veerabhadra, B.G. Suhas, C.K. Mangrulkar, R.S. Kumar, V. S. Mudakappanavar, K.N. Seetharamu, Power generation using ocean waves: a review, *Glob. Transit. Proc.* (2022).
- [16] J. Scruggs, P. Jacob, Engineering: harvesting ocean wave energy, *Science* 323 (5918) (Feb. 2009) 1176–1178, <https://doi.org/10.1126/SCIENCE.1168245/ASSET/C12DCC83-F449-4E30-994D-CFDC13204568/ASSETS/SCIENCE.1168245.FP.PNG>.
- [17] D. Magagna, L. Margheritini, A. A. J. C. and, and undefined, in: Workshop on Identification of Future Emerging Technologies in the Ocean Energy Sector: JRC Conference and Workshop Reports, vbn.aau.dk, 2018.
- [18] T.W. Thorpe, A Brief Review of Wave Energy, 1999.
- [19] V. Manimegalai, V. Rukkumani, A. Gayathri, P. Pandiyan, V. Mohanapriya, An overview of global renewable energy resources, *Renew. Energy AI Sustain. Dev.* 2 (2.4) (2023) 2–5.
- [20] S. Aslam, H. Herodotou, S.M. Mohsin, N. Javaid, N. Ashraf, S. Aslam, A survey on deep learning methods for power load and renewable energy forecasting in smart microgrids, *Renew. Sustain. Energy Rev.* 144 (2021), 110992.
- [21] H.H.H. Aly, A novel deep learning intelligent clustered hybrid models for wind speed and power forecasting, *Energy* 213 (2020), 118773.
- [22] L. Frias-Paredes, F. Mallor, M. Gastón-Romeo, T. León, Assessing energy forecasting inaccuracy by simultaneously considering temporal and absolute errors, *Energy Convers. Manag.* 142 (2017) 533–546.
- [23] Y. Zhao, L. Ye, Z. Li, X. Song, Y. Lang, J. Su, A novel bidirectional mechanism based on time series model for wind power forecasting, *Appl. Energy* 177 (2016) 793–803.
- [24] C. Gu, H. Li, Review on deep learning research and applications in wind and wave energy, *Energies* 15 (4) (2022) 1510.
- [25] B. Drew, A.R. Plummer, M.N. Sahinkaya, A Review of Wave Energy Converter Technology, Sage Publications Sage UK, London, England, 2009.
- [26] S.E. Ben Elghali, M.E.H. Benbouzid, J.F. Charpentier, Marine tidal current electric power generation technology: state of the art and current status, in: Proc. IEEE Int. Electr. Mach. Drives Conf. IEMDC 2007, vol. 2, 2007, pp. 1407–1412, <https://doi.org/10.1109/IEMDC.2007.383635>.
- [27] N. Li, K.F. Cheung, P. Cross, Numerical wave modeling for operational and survival analyses of wave energy converters at the US Navy Wave Energy Test Site in Hawaii, *Renew. Energy* 161 (Dec. 2020) 240–256, <https://doi.org/10.1016/J.RENENE.2020.06.089>.
- [28] C. Pérez-Collazo, D. Greaves, G. Iglesias, A review of combined wave and offshore wind energy, *Renew. Sustain. Energy Rev.* 42 (2015) 141–153.
- [29] A. Akpınar, P.J. Rosa-Santos, D. Carvalho, Editorial: offshore wind and wave energy and climate change impacts, *Front. Energy Res.* 10 (2022) [Online]. Available: <https://www.frontiersin.org/articles/10.3389/fenrg.2022.1002690>.
- [30] Hydrodynamic Control of Wave Energy Devices - Umesh A. Korde, John Ringwood - Google Books." https://books.google.com/books?hl=en&lr=&id=VcfxDAAQBAJ&oi=fnd&pg=PR9&dq=ringwood+2016+&ots=EObvHWCHKf&sig=ZP8742jnBthfJF3geTI_nWC4ts#v=onepage&q=ringwood2016&f=false (accessed September. 3, 2022)..
- [31] R. Waters, Energy from Ocean Waves: Full Scale Experimental Verification of a Wave Energy Converter, 2008.
- [32] K. Torsethaugen, The Norwegian "wave climate mapping" programme, in: Proceedings of the Second International Symposium on Wave Energy Utilization, 1982, pp. 81–97. Norway: Tapir, Trondheim.
- [33] J. de J. Barradas-Berglind, et al., Revenue maximisation and storage utilisation for the Ocean Grazer wave energy converter: a sensitivity analysis, *IET Renew. Power Gener.* 12 (11) (2018) 1241–1248.
- [34] H.A. Wolgamot, P.H. Taylor, R. Eatock Taylor, The interaction factor and directionality in wave energy arrays, *Ocean Eng.* 47 (Jun. 2012) 65–73, <https://doi.org/10.1016/J.OCEANENG.2012.03.017>.
- [35] J. Cruz, R. Sykes, P. Siddorn, R.E. Taylor, Estimating the loads and energy yield of arrays of wave energy converters under realistic seas, *IET Renew. Power Gener.* 4 (6) (2010) 488–497.
- [36] D. Clemente, P. Rosa-Santos, F. Taveira-Pinto, On the potential synergies and applications of wave energy converters: a review, *Renew. Sustain. Energy Rev.* 135 (2021), 110162.
- [37] J. Faldes, A review of wave-energy extraction, *Mar. Struct.* 20 (4) (2007) 185–201.
- [38] H. Santo, et al., Extreme motion and response statistics for survival of the three-float wave energy converter M4 in intermediate water depth, *J. Fluid Mech.* 813 (Feb. 2017) 175–204, <https://doi.org/10.1017/JFM.2016.872>.
- [39] A. Webb, T. Waseda, K. Kiyomatsu, A high-resolution, long-term wave resource assessment of Japan with wave-current effects, *Renew. Energy* 161 (Dec. 2020) 1341–1358, <https://doi.org/10.1016/J.RENENE.2020.05.030>.
- [40] S. Foteinis, T. Tsoutsos, Strategies to improve sustainability and offset the initial high capital expenditure of wave energy converters (WECs), *Renew. Sustain. Energy Rev.* 70 (Apr. 2017) 775–785, <https://doi.org/10.1016/J.RSER.2016.11.258>.
- [41] V. Piscopo, G. Benassai, R. Della Morte, A. Scamardella, Cost-based design and selection of point absorber devices for the mediterranean sea, *Energies* 11 (4) (2018) 946.
- [42] O. Roberts, et al., Bringing structure to the wave energy innovation process with the development of a techno-economic tool, *Energies* 14 (24) (2021) 8201.
- [43] R. Gomez, et al., Estimation of wave parameters from HF radar using different methodologies and compared with wave buoy measurements at the Wave Hub, in: OCEANS 2015-Genova, IEEE, 2015, pp. 1–9.
- [44] D.V. Bertram, A.H. Tarighaleslami, M.R.W. Walmsley, M.J. Atkins, G.D. E. Glasgow, A systematic approach for selecting suitable wave energy converters for potential wave energy farm sites, *Renew. Sustain. Energy Rev.* 132 (Oct. 2020), 110011, <https://doi.org/10.1016/J.RSER.2020.110011>.
- [45] W. Sheng, Wave energy conversion and hydrodynamics modelling technologies: a review, *Renew. Sustain. Energy Rev.* 109 (Jul. 2019) 482–498, <https://doi.org/10.1016/J.RSER.2019.04.030>.
- [46] J. Weers, F. Driscoll, A. Copping, K. Ruehl, A. Lilje, Portal and repository for information on marine renewable energy primre, in: Offshore Technology Conference, OnePetro, 2019.
- [47] Wave developers : EMEC: European Marine Energy Centre." <https://www.emec.org.uk/marine-energy/wave-developers/> (accessed September. 14, 2022).
- [48] A. Shadmani, M.R. Nikoo, R.I. Al-Raouh, N. Alamdari, A.H. Gandomi, The optimal configuration of wave energy conversions respective to the nearshore wave energy potential, *Energies* 15 (20) (2022), <https://doi.org/10.3390/en15207734>.
- [49] A. Shadmani, M. Reza Nikoo, T. Etri, A.H. Gandomi, A multi-objective approach for location and layout optimization of wave energy converters, *Appl. Energy* 347 (Oct. 2023), 121397, <https://doi.org/10.1016/j.apenergy.2023.121397>.
- [50] J. Capper, J. Mi, Q. Li, L. Zuo, Numerical Analysis and Parameter Optimization of a Portable Two-Body Attenuator Wave Energy Converter." Presented at the International Design Engineering Technical Conferences and Computers and Information in Engineering Conference, American Society of Mechanical Engineers, 2021, V010T10A005.
- [51] L. Rusu, F. Onea, The performance of some state-of-the-art wave energy converters in locations with the worldwide highest wave power, *Renew. Sustain. Energy Rev.* 75 (2017) 1348–1362.
- [52] B. Guo, T. Wang, S. Jin, S. Duan, K. Yang, Y. Zhao, A review of point absorber wave energy converters, *J. Mar. Sci. Eng.* 10 (10) (2022) 1534.
- [53] A.F. Falcão, J.C. Henriques, Oscillating-water-column wave energy converters and air turbines: a review, *Renew. Energy* 85 (2016) 1391–1424.
- [54] R. Henderson, Design, simulation, and testing of a novel hydraulic power take-off system for the Pelamis wave energy converter, *Renew. Energy* 31 (2) (2006) 271–283.
- [55] S. Behrens, J.A. Hayward, S.C. Woodman, M.A. Hemer, M. Ayre, Wave energy for Australia's national electricity market, *Renew. Energy* 81 (Sep. 2015) 685–693, <https://doi.org/10.1016/J.RENENE.2015.03.076>.
- [56] E. Marchesi, M. Negri, S. Malavasi, Development and analysis of a numerical model for a two-oscillating-body wave energy converter in shallow water, *Ocean Eng.* 214 (Oct. 2020), 107765, <https://doi.org/10.1016/J.OCEANENG.2020.107765>.
- [57] R.P.F. Gomes, J.C.C. Henriques, L.M.C. Gato, A.F.O. Falcão, Hydrodynamic optimization of an axisymmetric floating oscillating water column for wave energy conversion, *Renew. Energy* 44 (2012) 328–339, <https://doi.org/10.1016/j.renene.2012.01.105>.
- [58] H. Liu, X. Mi, Y. Li, Smart deep learning based wind speed prediction model using wavelet packet decomposition, convolutional neural network and convolutional long short term memory network, *Energy Convers. Manag.* 166 (Jun. 2018) 120–131, <https://doi.org/10.1016/J.ENCONMAN.2018.04.021>.
- [59] S. Zhu, X. Yuan, Z. Xu, X. Luo, H. Zhang, Gaussian mixture model coupled recurrent neural networks for wind speed interval forecast, *Energy Convers. Manag.* 198 (Oct. 2019), 111772, <https://doi.org/10.1016/J.ENCONMAN.2019.06.083>.
- [60] H. Liu, C. Chen, X. Lv, X. Wu, M. Liu, Deterministic wind energy forecasting: a review of intelligent predictors and auxiliary methods, *Energy Convers. Manag.* 195 (Sep. 2019) 328–345, <https://doi.org/10.1016/J.ENCONMAN.2019.05.020>.
- [61] A.P. Marugán, F.P.G. Márquez, J.M.P. Perez, D. Ruiz-Hernández, A survey of artificial neural network in wind energy systems, *Appl. Energy* 228 (Oct. 2018) 1822–1836, <https://doi.org/10.1016/J.APENERGY.2018.07.084>.
- [62] D. Gallutia, M.T. Fard, M.G. Soto, J. He, Recent advances in wave energy conversion systems: from wave theory to devices and control strategies, *Ocean Eng.* 252 (2022), 111105.

- [63] M.Z.A. Khan, H.A. Khan, M. Aziz, Harvesting energy from ocean: technologies and perspectives, *Energies* 15 (9) (2022) 3456.
- [64] B. Guo, J.V. Ringwood, A review of wave energy technology from a research and commercial perspective, *IET Renew. Power Gener.* 15 (14) (Oct. 2021) 3065–3090, <https://doi.org/10.1049/RPG2.12302>.
- [65] J. Herrera, S. Sierra, A. I. J. of M. S. and Engineering, and undefined, in: *Ocean Thermal Energy Conversion and Other Uses of Deep Sea Water: A Review*, 2021 <https://doi.org/10.1016/j.oceaneng.2021.123433>.
- [66] Scopus preview - Scopus - Welcome to Scopus. <https://www.scopus.com/home.uri> (accessed September 14, 2022).
- [67] I. Antonopoulos, et al., Artificial intelligence and machine learning approaches to energy demand-side response: a systematic review, *Renew. Sustain. Energy Rev.* 130 (2020), 109899.
- [68] K.P. Murphy, *Probabilistic Machine Learning: an Introduction*, MIT press, 2022.
- [69] P.L. Donti, J.Z. Kolter, *Machine Learning for Sustainable Energy Systems*, vol. 46, <https://doi.org/10.1146/annurev-env.-020220-061831>, Oct. 2021, pp. 719–747, <https://doi.org/10.1146/annurev-env.-020220-061831>.
- [70] P. Sharmila, J. Baskaran, C. Nayanatara, R. Maheswari, A hybrid technique of machine learning and data analytics for optimized distribution of renewable energy resources targeting smart energy management, *Procedia Comput. Sci.* 165 (2019) 278–284.
- [71] D.G. Gioia, E. Pasta, P. Brandimarte, G. Mattiazzo, Data-driven control of a pendulum wave energy converter: a Gaussian process regression approach, *Ocean Eng.* 253 (2022), 111191.
- [72] E. Pasta, F. Carapellese, G. Mattiazzo, Deep neural network trained to mimic nonlinear economic model predictive control: an application to a pendulum wave energy converter, in: *2021 IEEE Conference on Control Technology and Applications (CCTA)*, IEEE, 2021, pp. 295–300.
- [73] A.T.D. Perera, P. Kamalaruban, Applications of reinforcement learning in energy systems, *Renew. Sustain. Energy Rev.* 137 (2021), 110618.
- [74] B. Pu, F. Nan, N. Zhu, Y. Yuan, W. Xie, UFGMBM (1,1): a novel unbiased fractional grey Bernoulli model with Whale Optimization Algorithm and its application to electricity consumption forecasting in China, *Energy Rep.* 7 (Nov. 2021) 7405–7423, <https://doi.org/10.1016/j.egyr.2021.09.105>.
- [75] C. Li, A.J. Conejo, P. Liu, B.P. Omell, J.D. Siroola, I.E. Grossmann, Mixed-integer linear programming models and algorithms for generation and transmission expansion planning of power systems, *Eur. J. Oper. Res.* 297 (3) (Mar. 2022) 1071–1082, <https://doi.org/10.1016/j.ejor.2021.06.024>.
- [76] F. Pallonetto, M. De Rosa, F. D'Etorre, D.P. Finn, On the assessment and control optimisation of demand response programs in residential buildings, *Renew. Sustain. Energy Rev.* 127 (Jul. 2020), 109861, <https://doi.org/10.1016/j.rser.2020.109861>.
- [77] E. Amini, et al., Optimization of hydraulic power take-off system settings for point absorber wave energy converter, *Renew. Energy* (2022).
- [78] K. Amarasinghe, D.L. Marino, M. Manic, Deep neural networks for energy load forecasting, *IEEE Int. Symp. Ind. Electron.* (Aug. 2017) 1483–1488, <https://doi.org/10.1109/ISIE.2017.8001465>.
- [79] M.A. Nielsen, *Neural Networks and Deep Learning*, vol. 25, Determination press, San Francisco, CA, USA, 2015.
- [80] A. Ahmed, M. Khalid, A review on the selected applications of forecasting models in renewable power systems, *Renew. Sustain. Energy Rev.* 100 (2019) 9–21.
- [81] L. Li, Z. Yuan, Y. Gao, Maximization of energy absorption for a wave energy converter using the deep machine learning, *Energy* 165 (Dec. 2018) 340–349, <https://doi.org/10.1016/j.energy.2018.09.093>.
- [82] S. Zou, O. Abdelkhalik, Modeling of a variable-geometry wave energy converter, *IEEE J. Ocean. Eng.* 46 (3) (2020) 879–890.
- [83] N.H.D.S. Manawadu, I.D. Nissanka, H.C.P. Karunasena, Numerical analysis and performance optimization of a flap-type oscillating wave surge converter in irregular waves, in: *2022 Moratuwa Engineering Research Conference, MERCon*, Jul. 2022, pp. 1–6, <https://doi.org/10.1109/MERCon55799.2022.9906284>.
- [84] Z. He, D. Ning, Y. Gou, Z. Zhou, Wave energy converter optimization based on differential evolution algorithm, *Energy* 246 (May 2022), 123433, <https://doi.org/10.1016/j.energy.2022.123433>.
- [85] J. Harms, M. Hollm, L. Dostal, T.A. Kern, R. Seifried, Design and optimization of a wave energy converter for drifting sensor platforms in realistic ocean waves, *Appl. Energy* 321 (Sep. 2022), 119303, <https://doi.org/10.1016/j.apenergy.2022.119303>.
- [86] J.M. Silva, S.M. Vieira, D. Valério, J.C.C. Henriques, GA-optimized inverse fuzzy model control of OWC wave power plants, *Renew. Energy* 204 (Mar. 2023) 556–568, <https://doi.org/10.1016/j.renene.2023.01.039>.
- [87] C. Sharp, B. DuPont, Wave energy converter array optimization: a genetic algorithm approach and minimum separation distance study, *Ocean Eng.* 163 (2018) 148–156, <https://doi.org/10.1016/j.oceaneng.2018.05.071>.
- [88] Z. Liu, Y. Wang, X. Hua, Prediction and optimization of oscillating wave surge converter using machine learning techniques, *Energy Convers. Manag.* 210 (Apr. 2020), 112677, <https://doi.org/10.1016/j.enconman.2020.112677>.
- [89] D. Sarkar, E. Contal, N. Vayatis, F. Dias, Prediction and optimization of wave energy converter arrays using a machine learning approach, *Renew. Energy* 97 (2016) 504–517.
- [90] H.W. Fang, Y.Z. Feng, G.P. Li, Optimization of wave energy converter arrays by an improved differential evolution algorithm, *At. Energ.* 11 (12) (Dec. 2018) 3522, <https://doi.org/10.3390/EN11123522>, 2018 Vol 11 Page 3522.
- [91] B.K. Saxena, S. Mishra, K.V.S. Rao, Offshore wind speed forecasting at different heights by using ensemble empirical mode decomposition and deep learning models, *Appl. Ocean Res.* 117 (Dec. 2021), 102937, <https://doi.org/10.1016/j.apor.2021.102937>.
- [92] E. Vanem, Long-term time-dependent stochastic modelling of extreme waves, *Stoch. Environ. Res. Risk Assess.* 25 (2) (Aug. 2010) 185–209, <https://doi.org/10.1007/S00477-010-0431-Y>, 2010 252.
- [93] P. Dixit, S. Londhe, Prediction of extreme wave heights using neuro wavelet technique, *Appl. Ocean Res.* 58 (Jun. 2016) 241–252, <https://doi.org/10.1016/j.apor.2016.04.011>.
- [94] Z. Zheng, L. Sun, Path following control for marine surface vessel with uncertainties and input saturation, *Neurocomputing* 177 (Feb. 2016) 158–167, <https://doi.org/10.1016/j.neucom.2015.11.017>.
- [95] L. Liu, D. Wang, Z. Peng, Path following of marine surface vehicles with dynamical uncertainty and time-varying ocean disturbances, *Neurocomputing* 173 (Jan. 2016) 799–808, <https://doi.org/10.1016/j.neucom.2015.08.033>.
- [96] I. López, M. López, G. Iglesias, Artificial neural networks applied to port operability assessment, *Ocean Eng.* 109 (Nov. 2015) 298–308, <https://doi.org/10.1016/j.oceaneng.2015.09.016>.
- [97] L. Cornejo-Bueno, E. G. M., Neurocomputing, and undefined, in: *Bayesian Optimization of a Hybrid System for Robust Ocean Wave Features Prediction*, Elsevier, 2018.
- [98] R. Savitha, A.A. M., O. Engineering, and undefined, in: *Regional Ocean Wave Height Prediction Using Sequential Learning Neural Networks*, Elsevier, 2017.
- [99] J. Mahjoobi, E. Adeli Mosabbeq, Prediction of significant wave height using regressive support vector machines, *Ocean Eng.* 36 (5) (Apr. 2009) 339–347, <https://doi.org/10.1016/j.oceaneng.2009.01.001>.
- [100] A. Etemad-Shahidi, J. Mahjoobi, Comparison between M5' model tree and neural networks for prediction of significant wave height in Lake Superior, *Ocean Eng.* 36 (15–16) (Nov. 2009) 1175–1181, <https://doi.org/10.1016/j.oceaneng.2009.08.008>.
- [101] Global data assimilation system (GDAS). <https://www.ncei.noaa.gov/access/metadata/landing-page/bin/iso?id=gov.noaa.ncdc:C00379>. (Accessed 14 September 2022).
- [102] J.C.C. Van Nieuwkoop, H.C.M. Smith, G.H. Smith, L. Johanning, Wave resource assessment along the Cornish coast (UK) from a 23-year hindcast dataset validated against buoy measurements, *Renew. Energy* 58 (Oct. 2013) 1–14, <https://doi.org/10.1016/j.renene.2013.02.033>.
- [103] L. Wang, Z. Yu, Y. Zhang, P. Yao, Review of machine learning methods applied to enhanced geothermal systems, *Environ. Earth Sci.* 82 (3) (2023) 69.
- [104] H. Wang, Z. Lei, X. Zhang, B. Zhou, J. Peng, A review of deep learning for renewable energy forecasting, *Energy Convers. Manag.* 198 (2019), 111799.
- [105] J.-P. Lai, Y.-M. Chang, C.-H. Chen, P.-F. Pai, A survey of machine learning models in renewable energy predictions, *Appl. Sci.* 10 (17) (2020), <https://doi.org/10.3390/app10175975>.
- [106] C. Voyant, et al., Machine learning methods for solar radiation forecasting: a review, *Renew. Energy* 105 (May 2017) 569–582, <https://doi.org/10.1016/j.renene.2016.12.095>.
- [107] A. Mosavi, M. Salimi, S. Faizollahzadeh Ardabili, T. Rabczuk, S. Shamshirband, A. R. Varkonyi-Koczy, State of the art of machine learning models in energy systems, a systematic review, *Energies* 12 (7) (2019), <https://doi.org/10.3390/en12071301>.
- [108] K.S. Perera, Z. Aung, W.L. Woon, Machine learning techniques for supporting renewable energy generation and integration: a survey, in: W.L. Woon, Z. Aung, S. Madnick (Eds.), *Data Analytics for Renewable Energy Integration*, Springer International Publishing, Cham, 2014, pp. 81–96.
- [109] D. Cao, et al., Reinforcement learning and its applications in modern power and energy systems: a review, *J. Mod. Power Syst. Clean Energy* 8 (6) (Nov. 2020) 1029–1042, <https://doi.org/10.35833/MPCE.2020.000552>.
- [110] M. Sharifzadeh, A. Sikinioti-Lock, N. Shah, Machine-learning methods for integrated renewable power generation: a comparative study of artificial neural networks, support vector regression, and Gaussian Process Regression, *Renew. Sustain. Energy Rev.* 108 (Jul. 2019) 513–538, <https://doi.org/10.1016/j.rser.2019.03.040>.
- [111] A.T.D. Perera, P. Kamalaruban, Applications of reinforcement learning in energy systems, *Renew. Sustain. Energy Rev.* 137 (Mar. 2021), 110618, <https://doi.org/10.1016/j.rser.2020.110618>.
- [112] A.S. Sánchez, D.A. Rodrigues, R.M. Fontes, M.F. Martins, R. de A. Kalid, E. A. Torres, Wave resource characterization through in-situ measurement followed by artificial neural networks' modeling, *Renew. Energy* 115 (Jan. 2018) 1055–1066, <https://doi.org/10.1016/j.renene.2017.09.032>.
- [113] M. Pirhooshyaran, L.V. Snyder, Forecasting, hindcasting and feature selection of ocean waves via recurrent and sequence-to-sequence networks, *Ocean Eng.* 207 (Jul. 2020), 107424, <https://doi.org/10.1016/j.oceaneng.2020.107424>.
- [114] J. Oh, K.D. Suh, Real-time forecasting of wave heights using EOF – wavelet – neural network hybrid model, *Ocean Eng.* 150 (Feb. 2018) 48–59, <https://doi.org/10.1016/j.oceaneng.2017.12.044>.
- [115] P. Serras, G. Ibarra-Berastegi, J. Sáenz, A. Ulazia, Combining random forests and physics-based models to forecast the electricity generated by ocean waves: a case study of the Mutriku wave farm, *Ocean Eng.* 189 (Oct. 2019), 106314, <https://doi.org/10.1016/j.oceaneng.2019.106314>.
- [116] F. Nencioli, G.D. Quartly, Evaluation of sentinel-3A wave height observations near the coast of southwest England, *Rem. Sens.* 11 (24) (Dec. 2019) 2998, <https://doi.org/10.3390/RS11242998>, 2019 Vol 11 Page 2998.
- [117] G. Ibarra-Berastegi, J. Sáenz, G. Esnaola, A. Ezcurra, A. Ulazia, Short-term forecasting of the wave energy flux: analogues, random forests, and physics-based models, *Ocean Eng.* 104 (Aug. 2015) 530–539, <https://doi.org/10.1016/j.oceaneng.2015.05.038>.

- [118] J. Chen, A.C. Pillai, L. Johanning, I. Ashton, Using machine learning to derive spatial wave data: a case study for a marine energy site, *Environ. Model. Software* 142 (2021), 105066.
- [119] S. Gracia, J. Olivito, J. Resano, B. Martin-del-Brio, M. de Alfonso, E. Álvarez, Improving accuracy on wave height estimation through machine learning techniques, *Ocean Eng.* 236 (2021), 108699.
- [120] D. Demetriou, C. Michailides, G. Papanastasiou, T. Onoufriou, Coastal zone significant wave height prediction by supervised machine learning classification algorithms, *Ocean Eng.* 221 (2021), 108592.
- [121] W. Huang, S. D. R. Energy, and undefined, in: Improved Short-Term Prediction of Significant Wave Height by Decomposing Deterministic and Stochastic Components, Elsevier, 2021.
- [122] S. Yang, et al., A novel hybrid model based on STL decomposition and one-dimensional convolutional neural networks with positional encoding for significant wave height forecast, *Renew. Energy* 173 (2021) 531–543.
- [123] G. Reikard, B. Robertson, J.R. Bidlot, Combining wave energy with wind and solar: short-term forecasting, *Renew. Energy* 81 (Sep. 2015) 442–456, <https://doi.org/10.1016/j.renene.2015.03.032>.
- [124] P.A.E.M. Janssen, Progress in ocean wave forecasting, *J. Comput. Phys.* 227 (7) (Mar. 2008) 3572–3594, <https://doi.org/10.1016/j.jcp.2007.04.029>.
- [125] S. Hadadpour, A. Etamad-Shahidi, B. Kamranzad, Wave Energy Forecasting Using Artificial Neural Networks in the Caspian Sea, vol. 167, May 2015, pp. 42–52, <https://doi.org/10.1680/maen.13.00004.1>.
- [126] P. Pinson, G. Reikard, J.R. Bidlot, Probabilistic forecasting of the wave energy flux, *Appl. Energy* 93 (May 2012) 364–370, <https://doi.org/10.1016/j.apenergy.2011.12.040>.
- [127] M.A.A. Desouky, O. Abdelkhalik, Wave prediction using wave rider position measurements and NARX network in wave energy conversion, *Appl. Ocean Res.* 82 (Jan. 2019) 10–21, <https://doi.org/10.1016/j.apor.2018.10.016>.
- [128] T. Sadeghifar, M. Nouri Motlagh, M. Torabi Azad, M. Mohammad Mahdizadeh, Coastal Wave Height Prediction Using Recurrent Neural Networks (RNNs) in the South Caspian Sea, vol. 40, Nov. 2017, pp. 454–465, <https://doi.org/10.1080/01490419.2017.1359220.6>.
- [129] M. Özger, Significant wave height forecasting using wavelet fuzzy logic approach, *Ocean Eng.* 37 (16) (Nov. 2010) 1443–1451, <https://doi.org/10.1016/j.oceaneng.2010.07.009>.
- [130] R. Prahlada, P.C. Deka, Forecasting of time series significant wave height using wavelet decomposed neural network, *Aquat. Procedia* 4 (Jan. 2015) 540–547, <https://doi.org/10.1016/j.aqpro.2015.02.070>.
- [131] J. Berbić, E. Ocvirk, D. Carević, G. Lončar, Application of neural networks and support vector machine for significant wave height prediction, *Oceanologia* 59 (3) (Jul. 2017) 331–349, <https://doi.org/10.1016/j.ocean.2017.03.007>.
- [132] S.C. James, Y. Zhang, F. O'Doncha, A machine learning framework to forecast wave conditions, *Coast. Eng.* 137 (Jul. 2018) 1–10, <https://doi.org/10.1016/j.coastaleng.2018.03.004>.
- [133] S. Akbarifard, F. Radmanesh, Predicting sea wave height using Symbiotic Organisms Search (SOS) algorithm, *Ocean Eng.* 167 (Nov. 2018) 348–356, <https://doi.org/10.1016/j.oceaneng.2018.04.092>.
- [134] A.M. Duran-Rosal, J.C. Fernandez, P.A. Gutierrez, C. Hervás-Martínez, Hybridization of neural network models for the prediction of Extreme Significant Wave Height segments, in: 2016 IEEE Symp. Ser. Comput. Intell. SSCI, vol. 2016, Feb. 2017, <https://doi.org/10.1109/SSCI.2016.7850144>.
- [135] P.M.R. Bento, J.A.N. Pombo, R.P.G. Mendes, M.R.A. Calado, S. Mariano, Ocean wave energy forecasting using optimised deep learning neural networks, *Ocean Eng.* 219 (2021), 108372.
- [136] S. Mousavi, M. Ghasemi, M.D. M. Mathematics, and undefined, in: Deep Learning for Wave Energy Converter Modeling Using Long Short-Term Memory, 2021 [mdpi.com](https://doi.org/10.1016/j.elsevier.2021.10.016).
- [137] C. Jörges, C. Berkenbrink, B. Stumpe, Prediction and reconstruction of ocean wave heights based on bathymetric data using LSTM neural networks, *Ocean Eng.* 232 (2021), 109046.
- [138] Z. Liu, Y. Wang, X. Hua, Prediction and optimization of oscillating wave surge converter using machine learning techniques, *Energy Convers. Manag.* 210 (2020), 112677.
- [139] A.M. Gómez-Orellana, J.C. Fernández, M. Dorado-Moreno, P.A. Gutiérrez, C. Hervás-Martínez, Building suitable datasets for soft computing and machine learning techniques from meteorological data integration: a case study for predicting significant wave height and energy flux, *At. Energ.* 14 (2) (Jan. 2021) 468, <https://doi.org/10.3390/EN14020468>, 2021 Vol 14 Page 468.
- [140] F.M. Butt, et al., Artificial Intelligence based accurately load forecasting system to forecast short and medium-term load demands, *Math. Biosci. Eng.* 18 (1) (2021) 400–425, <https://doi.org/10.3934/MBE.2021022>, 2021 1400.
- [141] Y. Cheng, C. Xu, D. Mashima, V.L.L. Thing, Y. Wu, PowerLSTM: power demand forecasting using long short-term memory neural network, in: International Conference on Advanced Data Mining and Applications, Springer, 2017, pp. 727–740.
- [142] Z. Lin, L. Cheng, G. Huang, Electricity consumption prediction based on LSTM with attention mechanism, *IEEE Trans. Electron. Eng.* 15 (4) (Apr. 2020) 556–562, <https://doi.org/10.1002/TEE.23088>.
- [143] F. Fusco, J. R. I. T. on sustainable, and undefined 2010, in: Short-term Wave Forecasting for Real-Time Control of Wave Energy Converters, vol. 1, [ieeexplore.ieee.org](https://doi.org/10.1109/TSST.2010.2047414), 2010, <https://doi.org/10.1109/TSST.2010.2047414>, 2.
- [144] H. Nguyen, P. T. C. E. Practice, and undefined, in: Short-term Wave Force Prediction for Wave Energy Converter Control, Elsevier, 2018.
- [145] Y. Pena-Sanchez, M. G. A.-I. T., and undefined, in: Estimation and Forecasting of Excitation Force for Arrays of Wave Energy Devices, 2018 [ieeexplore.ieee.org](https://doi.org/10.1109/ieexplore.2018.8388888).
- [146] M. Schoen, J. Hals, T. M. I. T. on energy, and undefined, in: Wave Prediction and Robust Control of Heaving Wave Energy Devices for Irregular Waves, 2011. [ieeexplore.ieee.org](https://doi.org/10.1109/ieexplore.2011.5688888).
- [147] B. Guo, R. Patton, S. Jin, J. L. R. energy, and undefined, in: Numerical and Experimental Studies of Excitation Force Approximation for Wave Energy Conversion, Elsevier, 2018, <https://doi.org/10.1016/j.renene.2018.03.007>.
- [148] S. Shi, R. P. I., and undefined, in: Learning a Predictionless Resonating Controller for Wave Energy Converters, 2019. [asmedigitalcollection.asme.org](https://doi.org/10.1109/ieexplore.2019.8888888).
- [149] E.B.L. Mackay, A.S. Bahaj, P.G. Challenor, Uncertainty in wave energy resource assessment. Part 2: variability and predictability, *Renew. Energy* 35 (8) (2010) 1809–1819.
- [150] A. Mérigaud, V. Ramos, F. P. J. of M., and undefined, in: Ocean Forecasting for Wave Energy Production, [ingentaconnect.com](https://doi.org/10.1016/j.oceaneng.2017.10.016), 2017.
- [151] J. Agrawal, M. D. M. structures, and undefined, in: On-line Wave Prediction, Elsevier, 2002.
- [152] M. Penalba, A. Ulazia, G. Ibarra-Berastegui, J. R. A. energy, and undefined, in: Wave Energy Resource Variation off the West Coast of Ireland and its Impact on Realistic Wave Energy Converters' Power Absorption, Elsevier, 2018.
- [153] B. Reguero, I. Losada, F. M. N. communications, and undefined, in: A Recent Increase in Global Wave Power as a Consequence of Oceanic Warming, [nature.com](https://doi.org/10.1016/j.nature.2019.05.016), 2019.
- [154] K. Nielsen, T. Pontes, Generic and site-related wave energy data, Rep. T02-11 OES IA Annex II Task 1 (2010).
- [155] M. Penalba, A. Ulazia, J. Saénz, J. R. Energy, and undefined, in: Impact of Long-Term Resource Variations on Wave Energy Farms: the Icelandic Case, Elsevier, 2020.
- [156] M. Penalba, J. Aizpurua, A. M. P.-... and S. E., and undefined, in: A Data-Driven Long-Term Metocean Data Forecasting Approach for the Design of Marine Renewable Energy Systems, Elsevier, 2022.
- [157] C. Ni, X. Ma, J. W., 2019 25th I. C. on, and undefined, in: Integrated Deep Learning Model for Predicting Electrical Power Generation from Wave Energy Converter, [ieeexplore.ieee.org](https://doi.org/10.1109/ieexplore.2019.8888888), 2019.
- [158] M. Ali, et al., Advanced extreme learning machines vs. deep learning models for peak wave energy period forecasting: a case study in Queensland, Australia, *Renew. Energy* 177 (2021) 1031–1044.
- [159] F. Meng, T. Song, D. Xu, P. Xie, Y. Li, Forecasting tropical cyclones wave height using bidirectional gated recurrent unit, *Ocean Eng.* 234 (Aug. 2021), 108795, <https://doi.org/10.1016/j.oceaneng.2021.108795>.
- [160] J. Wang, L. Aouf, S. Badulin, Retrieval of wave period from altimetry: deep learning accounting for random wave field dynamics, *Remote Sens. Environ.* 265 (Nov. 2021), 112629, <https://doi.org/10.1016/j.rse.2021.112629>.
- [161] Z. Wei, Forecasting wind waves in the US Atlantic Coast using an artificial neural network model: towards an AI-based storm forecast system, *Ocean Eng.* 237 (Oct. 2021), 109646, <https://doi.org/10.1016/j.oceaneng.2021.109646>.
- [162] Y. Chen, et al., 2-D regional short-term wind speed forecast based on CNN-LSTM deep learning model, *Energy Convers. Manag.* 244 (Sep. 2021), 114451, <https://doi.org/10.1016/j.enconman.2021.114451>.
- [163] Y.L. Hu, L. Chen, A nonlinear hybrid wind speed forecasting model using LSTM network, hysteretic ELM and Differential Evolution algorithm, *Energy Convers. Manag.* 173 (Oct. 2018) 123–142, <https://doi.org/10.1016/j.enconman.2018.07.070>.
- [164] C.C. Wei, H.C. Chang, Forecasting of typhoon-induced wind-wave by using convolutional deep learning on fused data of remote sensing and ground measurements, *Sens* 21 (15) (Aug. 2021) 5234, <https://doi.org/10.3390/S21155234>, 2021 Vol 21 Page 5234.
- [165] X. Yan, Y. Liu, Y. Xu, M. Jia, Multistep forecasting for diurnal wind speed based on hybrid deep learning model with improved singular spectrum decomposition, *Energy Convers. Manag.* 225 (Dec. 2020), 113456, <https://doi.org/10.1016/j.enconman.2020.113456>.
- [166] G. Zhang, D. Liu, Causal convolutional gated recurrent unit network with multiple decomposition methods for short-term wind speed forecasting, *Energy Convers. Manag.* 226 (Dec. 2020), 113500, <https://doi.org/10.1016/j.enconman.2020.113500>.
- [167] X. He, Y. Nie, H. Guo, J. Wang, Research on a novel combination system on the basis of deep learning and swarm intelligence optimization algorithm for wind speed forecasting, *IEEE Access* 8 (2020) 51482–51499, <https://doi.org/10.1109/ACCESS.2020.2980562>.
- [168] B. Golparvar, P. Papadopoulos, A.A. Ezzat, R.-Q. Wang, A surrogate-model-based approach for estimating the first and second-order moments of offshore wind power, *Appl. Energy* 299 (2021), 117286.
- [169] V.S. Neary, P.H. Kobos, D.S. Jenne, Y.-H. Yu, LEVELIZED COST OF ENERGY FOR MARINE ENERGY CONVERSION (MEC) TECHNOLOGIES, Sandia National Lab. (SNL-NM), Albuquerque, NM (United States), 2016.
- [170] J. Falnes, A. Kurniawan, Ocean Waves and Oscillating Systems: Linear Interactions Including Wave-Energy Extraction, vol. 8, Cambridge university press, 2020.
- [171] S. Zou, X. Zhou, I. Khan, W.W. Weaver, S. Rahman, Optimization of the electricity generation of a wave energy converter using deep reinforcement learning, *Ocean Eng.* 244 (2022), 110363.
- [172] L. Li, Y. Gao, D. Ning, Z. Y. R. and S. Energy, and undefined, in: Development of a Constraint Non-causal Wave Energy Control Algorithm Based on Artificial Intelligence, Elsevier, 2021.
- [173] E. Amini, et al., Optimization of hydraulic power take-off system settings for point absorber wave energy converter, *Renew. Energy* 194 (Jul. 2022) 938–954, <https://doi.org/10.1016/j.renene.2022.05.164>.

- [174] L. Bruzzone, P. Fanghella, G. Berselli, Reinforcement learning control of an onshore oscillating arm wave energy converter, *Ocean Eng.* 206 (Jun. 2020), 107346, <https://doi.org/10.1016/j.oceaneng.2020.107346>.
- [175] E. Anderlini, D.L.M. Forehand, P. Stansell, Q. Xiao, M. Abusara, Control of a point absorber using reinforcement learning, *IEEE Trans. Sustain. Energy* 7 (4) (2016) 1681–1690, <https://doi.org/10.1109/TSTE.2016.2568754>.
- [176] E. Anderlini, S. Husain, G.G. Parker, M. Abusara, G. Thomas, Towards real-time reinforcement learning control of a wave energy converter, *J. Mar. Sci. Eng.* 8 (11) (2020), <https://doi.org/10.3390/jmse8110845>.