

Design plan Oosterschelde Storm-surge barrier

Overall design
and
design philosophy



A. A. BALKEMA / ROTTERDAM / BROOKFIELD / 1994

All colour plates are photographic impressions of the project and its environment

Acknowledgement for the photographs is made to:

W.Riemens, Delta Instituut, J.Wolterbeek, J.van Bodegom, Delta Phot, Aerocamera/Bart Hofmeester, Delft Hydraulics,
D. Lemcke and Rijkswaterstaat

RWS and those associated with this publication have exercised all possible care in compiling and presenting the information contained in it. This information reflects the state of the art at the time of publication! Nevertheless the possibility that inaccuracies may occur in this publication cannot be ruled out. Any one wishing to use the information in it will be deemed to do so at his or her own risk. RWS declines – also on behalf of all persons associated with this publication – any liability whatsoever in respect of loss or damage that may arise in consequence of such use.

Authorization to photocopy items for internal or personal use, or the internal or personal use of specific clients, is granted by A.A.Balkema, Rotterdam, provided that the base fee of US\$1.50 per copy, plus US\$0.10 per page is paid directly to Copyright Clearance Center, 222 Rosewood Drive, Danvers, MA 01923, USA. For those organizations that have been granted a photocopy license by CCC, a separate system of payment has been arranged. The fee code for users of the Transactional Reporting Service is: 90 5410 107 5/94 US\$1.50 + US\$0.10.

Original title:

Ontwerpnota stormvloedkering Oosterschelde; boek 1, totaal ontwerp

English version published and distributed by

A.A.Balkema, P.O.Box 1675, 3000 BR Rotterdam, Netherlands. (Fax: +31.10.4135947)
A.A.Balkema Publishers, Old Post Road, Brookfield, VT 05036, USA. (Fax: +1.802.276.3837)

By order of

Rijkswaterstaat (RWS)
Ministry of Transport, Public Works and Water Management
Road and Hydraulic Engineering Division
P.O.Box 5044, 2600 GA Delft, Netherlands
Tel: +31.15.699111
Fax: +31.15.611361

ISBN 90 5410 107 5

© 1994 A.A.Balkema, Rotterdam
Printed in the Netherlands

Contents

Foreword IX

Preface to the English version XI

Part 1: Overall design 1

Part 2: Design philosophy 47

Part 3: Environmental boundary conditions 83

Part 4: Description of the design 127

Part 5: Management, monitoring and maintenance 177

Additional Bibliography 207

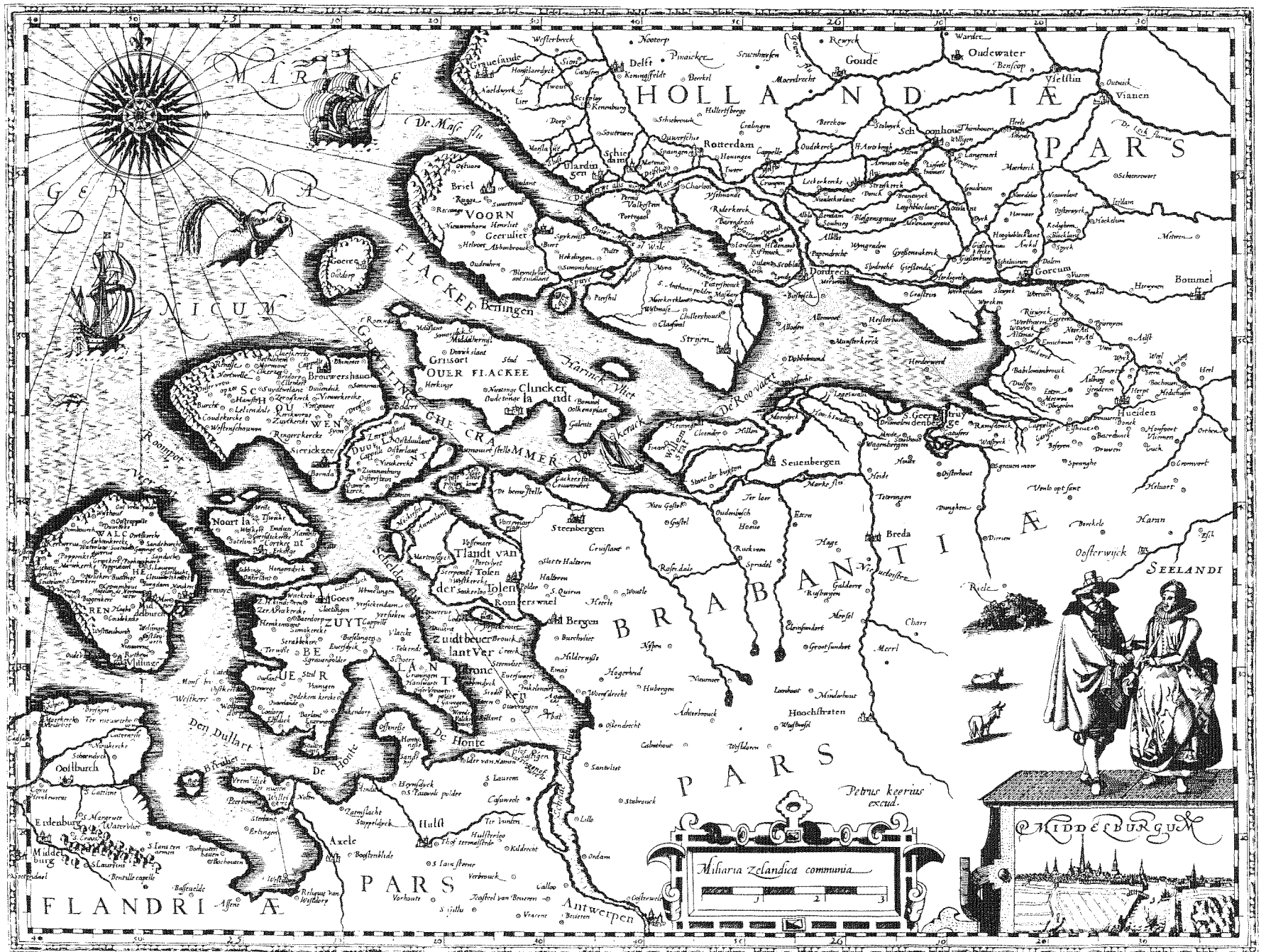





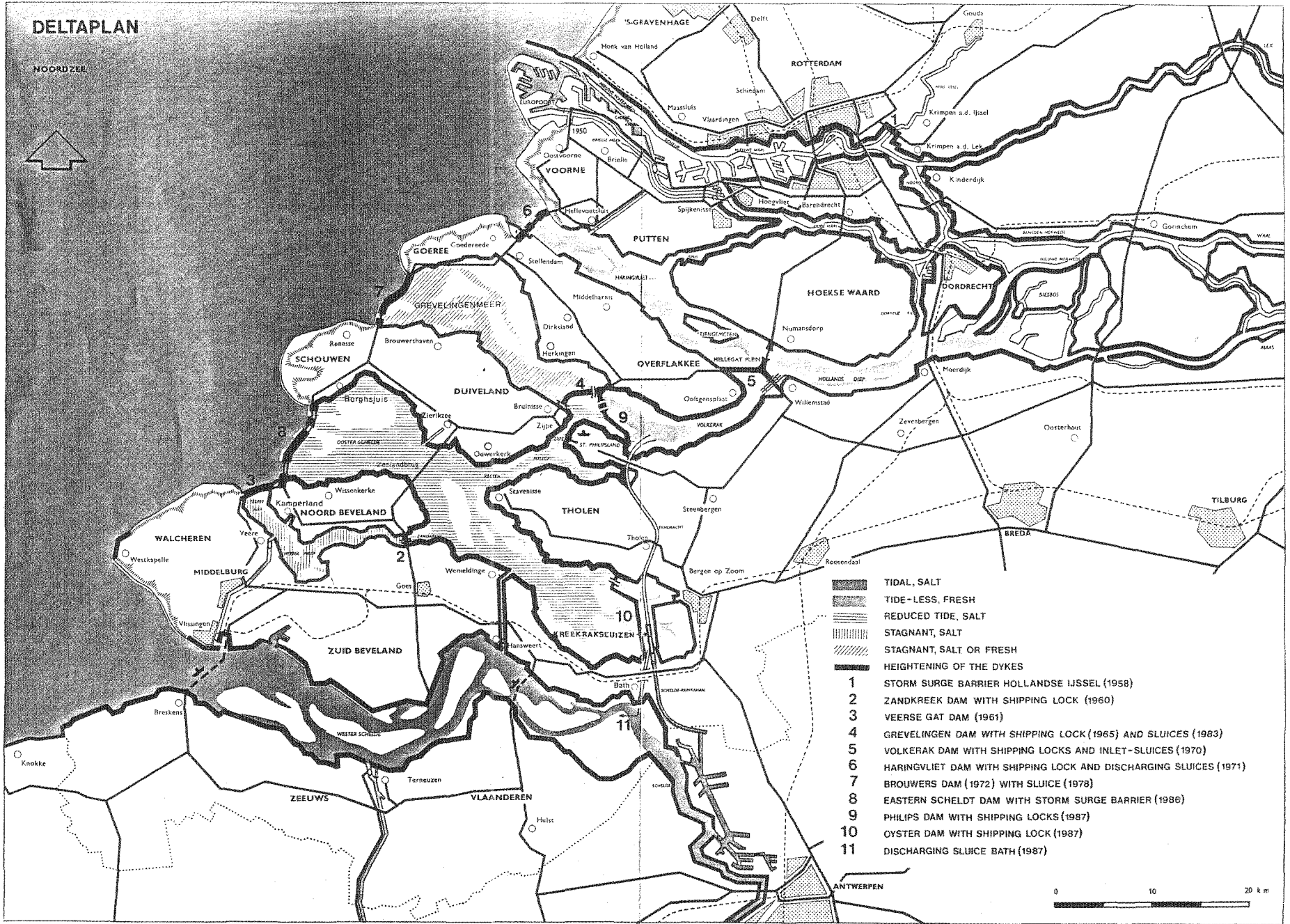

Delta area about 1500

DELTAPLAN

NOORDZEE



-  TIDAL, SALT
-  TIDE-LESS, FRESH
-  REDUCED TIDE, SALT
-  STAGNANT, SALT
-  STAGNANT, SALT OR FRESH
-  HEIGHTENING OF THE DYKES
- 1** STORM SURGE BARRIER HOLLANDSE IJSSEL (1958)
- 2** ZANDKREEK DAM WITH SHIPPING LOCK (1960)
- 3** VEERSE GAT DAM (1961)
- 4** GREVELINGEN DAM WITH SHIPPING LOCK (1965) AND SLUICES (1983)
- 5** VOLKERAK DAM WITH SHIPPING LOCKS AND INLET-SLUICES (1970)
- 6** HARINGVLIEET DAM WITH SHIPPING LOCK AND DISCHARGING SLUICES (1971)
- 7** BROUWERS DAM (1972) WITH SLUICE (1978)
- 8** EASTERN SCHELDT DAM WITH STORM SURGE BARRIER (1986)
- 9** PHILIPS DAM WITH SHIPPING LOCKS (1987)
- 10** OYSTER DAM WITH SHIPPING LOCK (1987)
- 11** DISCHARGING SLUICE BATH (1987)

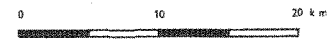

'For the whole of the country, Zeeland serves as a bulwark against the ocean. Without government grants it would have been ruined, which would have led to the destruction of us all'

Andries Schaver
first Director of the Rijkswaterstaat Zeeland,
1754–1827

Foreword

For the successful completion of a construction project it is necessary, before starting it, to write down in what way quality, costs, time-schedule and organization will be controlled. Such a document is called a project plan. Part of the project plan is the description of what will be built, the design report. The project plan of the Delta Plan is recorded in the Final Report of the Delta Committee.

The decision to dam up the Oosterschelde in a different way from what was described in the project plan led to some problems in the normal procedure.

The construction of the storm-surge barrier was to start on the basis of a preliminary design, described in the Final Report 'Storm-surge Barrier' and the Delta Plan was adjusted with a time extension of seven years, a partial improvement for the safety of side embankments along the Oosterschelde and the addition of compartmentalization dams. This list with adjustments is recorded in 'Analysis of Alternatives for the Oosterschelde'.

The 10 year struggle of the Rijkswaterstaat (State Department of Public Works) and contractors with the task to build a permeable sea defence structure in the Oosterschelde, has been registered in sixteen successive project reports which contain thousands of documents. These documents are sometimes complete part-project papers and sometimes not more than minutes of a meeting or time-scaled diagrams. This documentation contains all elements which belong to a design report and a project plan. That in this way a successful construction project did come about, does not lessen the need of the PGS (Management Team Oosterschelde Project) for an

integrated design plan. In this design plan, the consistency of the design is visible and can be tested, even for those who were not participants in the project.

Because of the fact that the construction was designed while it was being built, the design plan was ready only when work was finished. And since writing of it had to take place during construction, often priority was given to construction instead of writing. Therefore writing of the design plan was more difficult than if it had been done before construction started. In the knowledge that this reversed procedure should not be repeated, the PGS is satisfied that a design plan did come about at all.

The report will provide the manager of the storm-surge barrier, and those who are interested, with an insight into the chosen starting-points. It is hoped that the report will also be an encouragement and a comfort to all those who may be involved with similar constructions in the future. Encouragement to make a design plan and a project plan before construction starts, and the comfort that when necessary it can also be done without these. But then it becomes crucial to have the commitment of all participants in the project to work closely together with mutual trust.

That commitment was the basis of successful completion of the Storm-surge Barrier Project. Its success depended on that commitment.

On behalf of the PGS, the chairman

Tj. Visser

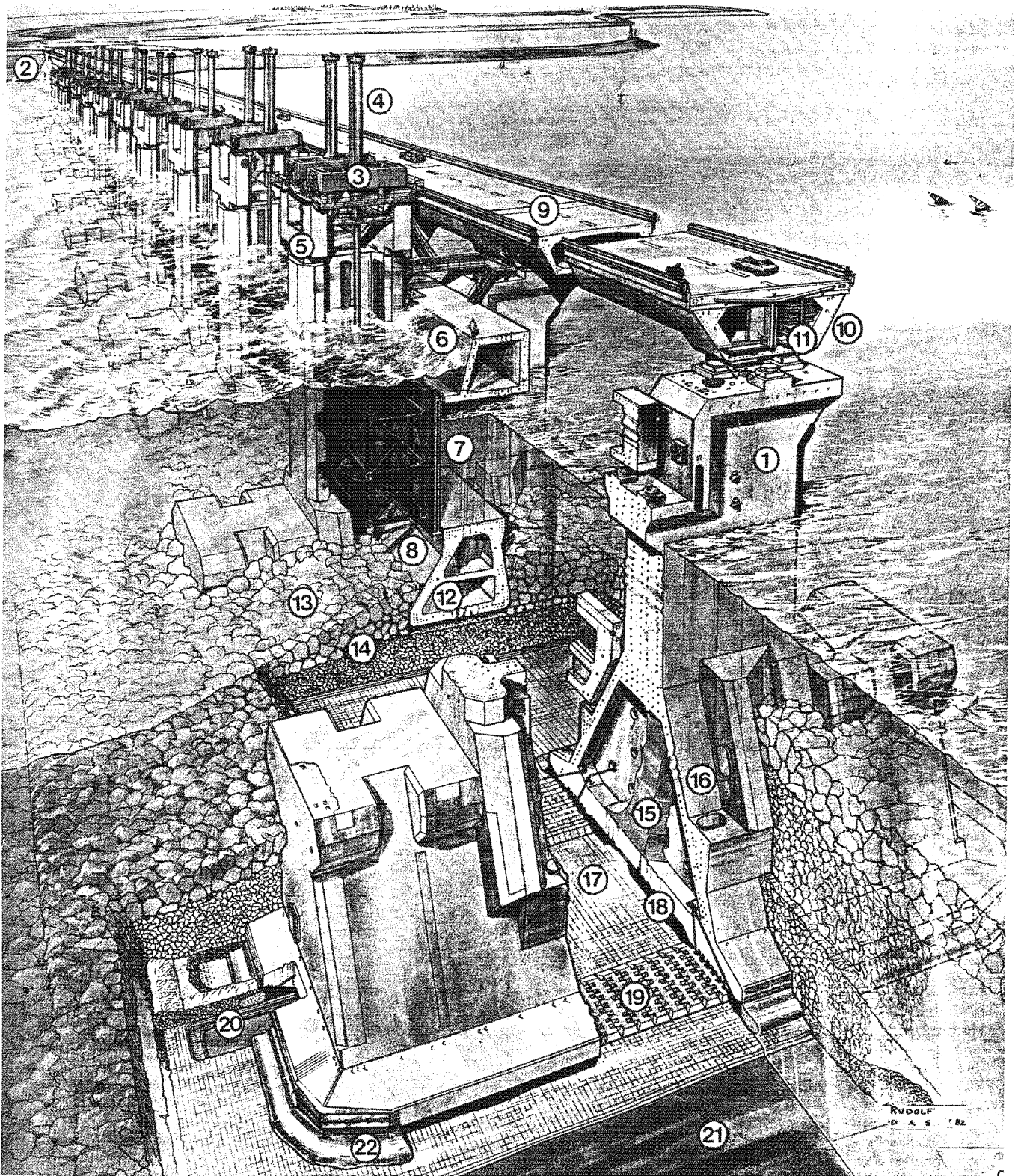

The storm surge barrier in detail

- 1 pier
- 2 quarry stone dam for land abutment construction
- 3 beam supporting operating equipment
- 4 hydraulic cylinders
- 5 capping unit
- 6 upper beam

- 7 gate
- 8 sill beam
- 9 road
- 10 road box girder and machinery for gate operation
- 11 power supply duct
- 12 sand filling of sill beam
- 13 top layer of sill
- 14 core of sill
- 15 sand filling of pier base slab

- 16 sill beam stops/bearings
- 17 upper mattress
- 18 grout filling
- 19 block mattress
- 20 bottom mattress
- 21 compacted sand under the bed of the Eastern Scheldt
- 22 gravel bag

Preface to the English version

To place this book in the proper context it is necessary to highlight some typical Dutch problems concerning the battle against the sea and some background information on the Eastern Scheldt project.

The vulnerability of the Netherlands

Over half of the Netherlands lies below sea level. Just how vulnerable the country is to flooding was demonstrated on the night of 1 February 1953. The combination of a spring tide and a persistent, violent northwesterly storm recreated, on a particularly large scale, an event which happened many times over the centuries. Waves destroyed the dykes and the sea rushed into the polders. The results were catastrophic: 1835 people drowned and many thousands of cows, horses, pigs and chickens were killed. The floods destroyed 47,000 homes, as well as schools, churches and other buildings. Approximately 500 kilometres of dykes were completely or partially destroyed and 200,000 hectares of land was flooded. The hardest hit areas were the province of Zeeland, the southern part of South Holland and the western part of North Brabant.

The bewilderment and shock felt by people in the rest of the Netherlands when they learnt of the extent of the flooding soon gave way to determination, and great efforts were made to reseal the breached dykes. The last breach, near Ouwkerk on Schouwen-Duiveland, was resealed at the beginning of November 1953. Rarely have the people of the Netherlands been so united as when they decided that such a catastrophe should never happen again.

The Delta Project

The outcome of this determination was the Delta Project. The Project's principal goal was to improve the safety of the southwest Netherlands by considerably shortening and reinforcing the coastline. It was decided that dams should be constructed across inlets and estuaries, considerably reducing the possibility of the sea surging into the land once more. Freshwater lakes would form behind them. Roads along the dams would improve access to the islands of Zeeland and South Holland. Dams could not be constructed across the New Waterway or the Western Scheldt, as these important shipping routes to the seaports of Rotterdam and Antwerp had to be kept open. The safety of these areas was to be guaranteed by substantially reinforcing the dykes.

The Delta Project is one of the largest hydraulic engineering projects that has ever been carried out anywhere in the world. New hydraulic engineering techniques were gradually developed for the construction of the eleven dams and barriers of various sizes which were built over a period of thirty years.

In the early 1970s the realization grew that it was important to preserve as much of the natural environment as possible, and this point of view has left its mark on the Delta Project. As a

result the original plans were changed: not all of the inlets, distributaries and estuaries between the Western Scheldt and the New Waterway have been transformed into freshwater lakes as we initially intended; there are now very distinct water systems, each with its own characteristic function.

You can now drive along the roads constructed on top of the dams and visit all the major Delta works and water systems in a single day. It does not matter where your journey begins or which direction you take. There is no systematic route one could follow to visit the dams and barriers in the same sequence in which the project was carried out. Yet the Delta Project was carried out in anything but a random order. Work began on the relatively simpler parts, so that the experience gained could be used during the construction of larger, more difficult dams across inlets and estuaries with strong tidal currents. That was how the Delta works progressed: new hydraulic engineering techniques were first applied on a small scale and then used in the larger projects.

The Eastern Scheldt (Oosterschelde)

While the Haringvliet dam and the Brouwers dam were nearing completion (1971), preparations had already begun for the construction of the dam across the mouth of the Eastern Scheldt, the last, largest and also most complex part of the Delta Project. Three islands were constructed: Roggenplaat, Neeltje Jans and Noordland. A pumped sand dam was built between the latter two. In the remaining channels the first steel towers were built for the cableway, as it was planned to dam the Eastern Scheldt using this well-tried method. Its completion date was set for 1978.

At the end of the 1960s however protests were voiced about the project. Scientists became aware of the special significance of the flora and fauna in and around the Eastern Scheldt. The Sandbars and mud flats exposed at low tide are important feeding grounds for birds, and the estuary is a nursery for fish from the North Sea. Fishermen and action groups made sure that the scientific findings were heard by the government and parliament. A heated debate flared up. Opponents of the dam believed that the safety of the region could be guaranteed by raising the height of the dykes along the Eastern Scheldt. The inlet would then remain open and saline. The equally vigorous supporters of the solid dam, for example agricultural and water boards, appealed to the emotions of the Zeelanders, asking whether the consequences of the flood disaster of 1953 had already been forgotten.

The Storm Surge Barrier

A compromise was reached in 1976: a storm surge barrier, which would stay open under normal conditions but which could be closed at very high tides. The construction of the storm surge barrier meant a break with the policy that the

Public Works Department and the hydraulic engineering contractors in the Netherlands had pursued in working from small to large and from relatively simple to complex. The storm surge barrier needed expertise that had yet to be developed and experience that had yet to be gained. Extensive research was carried out to determine the feasibility of building the storm surge barrier, taking full account of the interests of the environment, flood protection, and the fishing and shipping industries. The actual construction of the storm surge barrier also had to be thoroughly studied. The solution was a barrier consisting of pre-fabricated concrete and steel components that were assembled in the three channels at the mouth of the Eastern Scheldt. 65 colossal concrete piers form the barrier's backbone. A stone sill and a concrete sill beam were placed between each of the piers, and the openings could be closed with steel gates. Concrete box girders were placed on top of the piers to form a road deck.

The seabed also needed special consideration. A new technique was required to prevent the strong current in the mouth of the river from washing away the sand on which the piers were to stand. The solution was to place the piers on mattresses filled with graded layers of sand and gravel which would allow water to flow through but trap the sand.

The construction of the storm surge barrier also required the development of special equipment. The 'Mytilus' made its appearance in the estuary to compact the seabed, followed by the 'Jan Heijmans' which laid asphalt and dumped stones, the 'Cardium' to position the mattresses, the 'Ostrea' to lift, transport and position the piers and the mooring and cleaning pontoon 'Macoma'. These are very special ships designed for just one purpose: to construct the storm surge barrier. New measuring instruments and computer programs were also developed, so that engineers working 30 to 40 metres below the surface could position components with such precision that the maximum error would be just one centimetre.

The Cardium laid the first mattress in November 1982 and the Ostrea placed the first pier in August 1983. Work progressed quickly. There were virtually no technical setbacks; only the cost turned out to be higher than expected. The storm surge barrier was 30% more expensive than estimated. On 4 October 1986 Her Majesty Queen Beatrix officially opened the storm-surge barrier. The Eastern Scheldt has remained open and flood protection has been achieved. On average the barrier has to be closed once a year because of storms.

Eastern Scheldt Project

The Eastern Scheldt Project comprises more than the construction of a storm-surge barrier in the mouth of the estuary. In the eastern part the Oesterdam and the Philipsdam have been constructed along with shipping locks.

The Zoommeer forms a fresh water lake behind these dams. To prevent the salty Eastern Scheldt water from mixing with the fresh Zoommeer water, the locks are fitted with a special fresh-salt water separation system. From the Zoommeer a discharge channel carries fresh water into the Western Scheldt. The Eastern Scheldt Project also involved far-reaching adaptations of the South-Beveland canal.

The storm-surge barrier in the Eastern Scheldt has been commissioned by Rijkswaterstaat (Public Works Department), and was built by the Oosterschelde Stormvloedkering Bouwcombinatie (Dosbouw/Ostem), a joint venture by a number of contractors.

FACTS AND FIGURES

Tidal channels

Hammen: 1800 m wide, maximum depth 30 m
Schaar van Roggenplaat: 1200 m wide, maximum depth 25 m
Roompot: 2500 m wide, maximum depth 45 m

Piers

total number: 65
maximum height of pier after completion in tidal channel: 53 m
measurements of pier base: 25 × 50 m
weight: 18000 tons maximum
upward pressure on piers during transport: ± 9000 tons

Steel gates

total number: 62 (Hammen 15, Schaar 16, Roompot 31)
length: 43 m
thickness: 5.40 m
height: between 5.90 and 11.90 m
weight: between 300 and 535 tons

Safety

After completion of the Delta Project absolute safety is not guaranteed, but the chance that there will be another flood is very small indeed. With the dykes and the dams having the required Delta Project height the chance of a flood has been reduced to one in every 4000 years.

Duration

The storm-surge barrier has been designed to last 200 years:

Planning

placing of mattresses: from November 1982 until May 1984
placing of piers: from August 1983 until September 1984
Storm-surge barrier operation: October 1986
Completion of road on barrier: 5th November 1987

Cost

The original estimate for the entire Eastern Scheldt Project was dfl 5.0 billion at 1976 prices.
Costs until 1-1-1985: dfl 7.8 billion (the storm-surge barrier alone accounting for dfl 5.5 billion).

The difference is not only due to inflation, but also to increased costs. Per 1-1-1987 the extra expenditure amounts to 13% of the original estimate.

Closure remarks

Many people have contributed to the realization of this project. This book is backed up by the experiences of a great number of engineers and other professionals involved in the Eastern Scheldt Storm Surge Barrier Project. In the course of the project, a wealth of knowledge and experience has been acquired. This book has been written to make this knowledge available for future use.

The total design documentation consists of five books. This book is a translation of Book 1: Total design and design philosophy. The other books are only available in Dutch.

Krystian W. Pilarczyk
Former 'Delta worker'
(editor of the English version)
Delft, 1993

Part 1: Overall design

Contents

Introduction 4

- 1.1 Aim of the design document 4
- 1.2 Division of the design document 4
- 1.3 Completion of the design plan 4
- 1.4 Archiving of documentation 4

2 The project in a wider context 6

- 2.1 Brief historical survey 6
- 2.2 The impact of the project on the South-West of the Netherlands 12

3 Boundary conditions for the storm-surge barrier 15

- 3.1 Effective cross section 15
- 3.2 Safety (retaining height/crest elevation) 18
- 3.3 Remaining boundary conditions 18

4 Development of the design 20

- 4.1 Introduction 20
- 4.2 From a provisional permeable boulder-dam to a permanent pier-dam 20
- 4.3 From 'piers on caissons' to 'piers on sill' 22
- 4.4 Development of the design for sill and foundation bed 26

5 Organization of the project 32

- 5.1 Introduction 32
- 5.2 Project organization for Storm-Surge Barrier 34
 - 5.2.1 The overall structure 34
 - 5.2.2 Further elaboration on the project organization 35
- 5.3 Contractual aspects 38
- 5.4 Relationship aspects 40
- 5.5 Planning aspects 41

1 Introduction

1.1 Aim of the design document

Already at an early stage of design it was recognized that collection and careful filing of the important data contributing to completion of the design, was crucial, because the storm-surge barrier like the one realised in the mouth of the Oosterschelde is the end product of a process started in 1974, in which study, research, consultation and practical experience was invested, and to which a large number of people inside and outside the Rijkswaterstaat (State Department for Public Works) have contributed. People who, eventually, will be no longer available to explain the details of the storm-surge barrier. Beside the actual design plan itself, the design process has produced a large amount of documents such as memos, studies, research reports, calculations, etc. which together reflect the construction process. Tenders and construction drawings usually provide an accurate description of the work done. The need for background information on the used design will always exist:

- With the manager of the project on behalf of business operation, maintenance and the possible adjustments and changes;
- With the future designer of other constructions who might find answers in this design for specific problems he comes across in his own design;
- From a techno-scientific and/or a techno-historical point of view.

In brief, this design document has two aims:

1. To give a cohesive and balanced description of the storm-surge barrier design as it was constructed, with the appropriate starting points and boundary conditions; to be used independently by those interested inside and outside the Rijkswaterstaat.
2. As an access guide into the extensive documentation like studies, research reports, calculations, designs and tenders which were produced during design completion.

With this in mind, the design plan also has its limitations:

- Comprehensive indications on possibilities for system operations and desired maintenance, are not included.
- Neither does it provide an evaluation of design execution, although important alterations in design, which came about during execution, are mentioned. Also mentioned are a few expedients, expressly developed for and crucial to design development and execution.

Extensive attention will be paid to the above mentioned subjects in separate documents.

As already mentioned, this design report is restricted to the design as it has been executed. Attention is paid to alternatives

which were worked out for the various parts of the project only when necessary, to illustrate the choices made.

1.2 Division of the design document

The total document is divided into five books, each of them subdivided into several parts. These parts deal with a separate subject or part of a subject.

Book 1: Overall design and design philosophy, gives a project survey that can be used on its own by the reader who requires less detailed information.

Book 2-4 deal with the design more comprehensively, divided into:

- Hydraulic engineering (Book 2),
- Concrete structures (Book 3) and
- Gates (Book 4) dealing with subjects like steel constructions, operating mechanisms, and electric installations.

Book 5: Auxiliary systems and auxiliary tools, deals with expedients developed on behalf of design execution. (see also Part 4, Section 4.4)

Note: This book is a translation of Book 1. The other books are only available in Dutch.

1.3 Completion of the design plan

The Storm-surge Barrier Project Organisation (see Chapter 5) was responsible for completion of the design plan and for project management. The plan was written with the cooperation of the four Rijkswaterstaat organizations involved in the project: Delta Division, Locks and Weirs Division, Bridge Division and Zeeland Management.

Several government organizations, businesses, contractors, engineering companies and research institutes contributed to the design of the barrier.

1.4 Archiving of documentation

The archives of the no longer existing Delta Division (of the State department for Public Works) and of the project organizations are stored in the State Record-Office in Middelburg. In the archives of Locks and Weirs Division and Bridge Division, there are quite a number of documents relating to the contributions of these organizations to the Storm-surge Barrier Project.

As this design report was written, it was not yet clear if these

documents would also be handed over to the State Record-Office in Middelburg, or whether they would remain in the archives of these organizations.

Finally, it is the aim to store all the documents referred to, in a documentation centre located at the ir. J.W. Topshuis (Tops-House) of the Storm-surge Barrier.

2 The project in a wider context

2.1 Brief historical survey

This storm-surge barrier is the jewel in the crown of the primary flood control system in the South-West of the Netherlands. This is in correspondence with art. 1, lid 1a of the Delta-law of 8 May 1958, *Government Courant* 246, 1958 (see lit. 1).

The storm catastrophe of 1 February 1953 initiated the execution of the Delta Plan. In this catastrophe 1835 people were killed, 136512 hectares of land were flooded, about 72,000 people had to be evacuated and the material damage amounted to some 1.5 billion guilders (see lit. 2).

Safety improvement in the South-West of the Netherlands already was a topic of discussion before 1953. In 1939 the so-called Storm-surge Barrier Committee was established. Its task was to advise on possible future storm surge levels in a more scientific way than just on the basis of experience with past storm surges. Then the so-called Four- and Five-Island Plans (Figs 1 and 2) were developed for the isles with a number of variations. As a concrete result of these plans, the rivers the Brielse Maas and the Botlek were dammed up in 1950 (see lit. 6, 7 and 8).

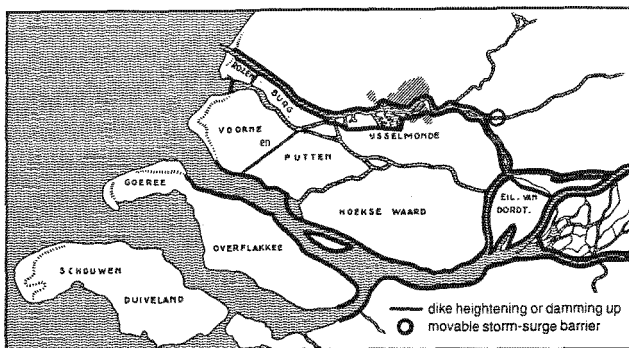

Fig. 1 Four-island plan.

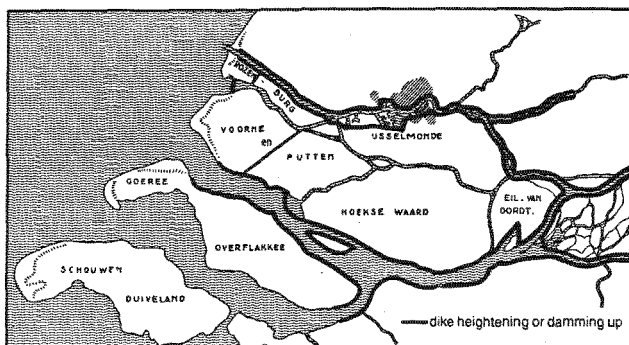

Fig. 2 Five-island plan.

In Zeeland there were discussions about the execution of the so-called Three-Isle Plan in which the isles of Walcheren, North and South-Beveland would be joined by damming up Het Veerse Gat and De Zandkreek. It was also suggested to dam up the large coastal inlets: Het Haringvliet, De Grevelingen and De Oosterschelde.

All these plans aimed at:

- An improved protection of those areas threatened by storm surges.

With as important secondary object:

- An improvement of water management, particularly the fight against rising salinity and a consequent sound fresh water supply.

These aims were also valid for the Delta Plan.

With the benefit of the above mentioned studies, the Delta Committee was able to make concrete proposals quite quickly:

- The enclosure of the Hollandse IJssel by storm-surge barrier (1953);
- The damming up of Het Veerse Gat and De Zandkreek (Three-Isle Plan, 1955);
- The damming up of the Coastal Inlets (1954 and 1955).

With these last proposals, in fact the Delta plan was born (Fig. 3).

It provided for total damming up of the coastal inlets at the sea side, with only a large discharging in Het Haringvliet for discharge of surplus Rhine water which can not flow to sea via the Nieuwe Waterweg (through Rotterdam's harbour) when discharges are high, and construction of secondary embankments further inland, which were necessary to execute the plan in phases.

As indicated earlier, the most important aims of the plan were:

- Improvement of safety against storm surges, and
- The fight against the increasing salinity level of the islands.

It was therefore agreed in the plan that all enclosed coastal inlets would be transformed into fresh water basins. This would also serve the interests of water and land transport, regional development and recreation.

The plan also led to the destruction of local fishing interests in the coastal inlets that were to be closed. This was wittingly accepted. A compensation settlement was provided for (art. 8 of the Delta-law). The destruction of nature areas outside the dikes (the so-called salt tidal environment) was taken for granted.

Increasing environmental consciousness in the second half of the 1960's brought about increasing opposition to the sacrifice of these areas.

The opposition wanted to keep open the Oosterschelde, the coastal inlet that was to be closed last, which of course was supported by the fishery that would otherwise disappear. The importance of safety was often minimalised or even ignored.

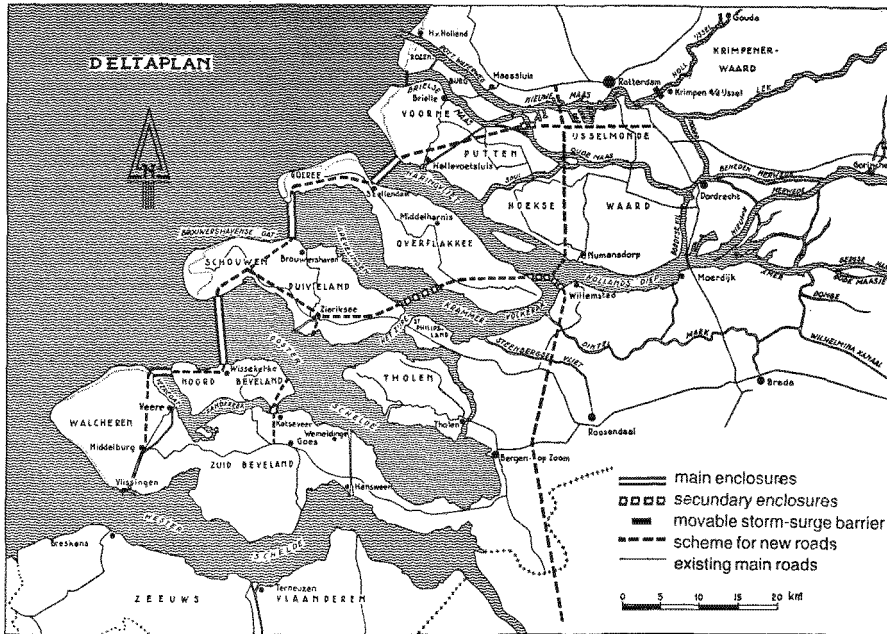

Fig. 3 The Delta plan according to the original concept.

The awareness of environmental issues also penetrated the political field. To appease opposition, the Ministry of Transport and Public Works established an independent Committee Oosterschelde (also called Klaasesz Committee) in 1973.

This Committee had the task to inform the minister about all aspects of safety and environment with regards to the works at the Oosterschelde. After studying the existing possibilities, they had to choose a solution which would serve the best interests of both safety and environment.

The Committee advised in its Spring 1974 report (lit. 9) to execute a compromising solution, in which in the most important part of the Oosterschelde a certain limited tide would remain.

This plan, variant C5 (Fig. 4) would result in an embankment with an movable storm-surge barrier in the mouth of the Oosterschelde, without interrupting the tidal motion of the Oosterschelde. Preferably this would be supplemented by two secondary embankments with ship locks: One in Het Keten and one in the Eastern part of the Oosterschelde between the oysterbanks at Yerseke and the new Schelde-Rijn-connection (Oysterdam). The plan would have to be executed in such a way that the tidal movements would still exist, but would be reduced to an average tide difference of 1.8 meters off the mussel banks at Yerseke, while stormsurge levels behind the Oosterschelde basin would be lowered by about 80 centimeters.

According to the Committee, the main advantages of this plan were:

- Enough guarantees for the safety of the areas bordering on the Oosterschelde without dike heightening.
- Keeping the very valuable tidal environment in most of the Oosterschelde;
- Maintaining the oyster and mussel culture in the Oosterschelde;
- Optimum conditions for the development of recreation fishing.

The disadvantages of the plan were:

- Execution would take 10 to 15 years, against just 5 years for the original plan;

- Important cost escalations estimated at Hfl. 1.6 billion and
- An extra obstacle for navigation caused by an extra lock in the Ketendam.

This proposal meant an important turning point in opinions, particularly with regard to the execution of the Delta plan, and more generally in respect to execution of big infra-structural constructions.

More importance was given to maintaining natural values, as opposed to a more economic policy of developing optimum circumstances for human society. In practical terms this meant high cost escalations in order to preserve nature and fishery interests and it was to the detriment of developing optimum circumstances, especially for agriculture. No concessions were made on safety improvement, the main aim of the Delta plan.

Although everything had been estimated as reasonably as possible, the plan was uncertain on the technical realities, cost escalation and execution time. Uncertainties which had to be diminished by study. However, essentially it was a political choice. The framework of this design book does not allow for space to elaborate on the pro's and con's of this choice.

The minister decided to ask for opinions on the report of the Klaasesz Committee from the three provinces around the islands, from the polder districts around the Oosterschelde, and from the Board of the State Department for Public Works. In the meantime, technicians from the State Department for Public Works and the Combination Dike Building Oosterschelde*, were asked to examine the technical aspects of the plan at short notice. This started a significant expansion of technical creativity which would last until the realisation of the present design.

Also on account of given advice (such as by the Board of the State Department for Public Works on managerial and technical points, Fig. 5), the government decided on 12 July 1974 to enclose the Oosterschelde with pervious caissons, on the condition that this system would meet the required standards

* The contractor combination who were to execute the enclosure work. See also Section 5.3.

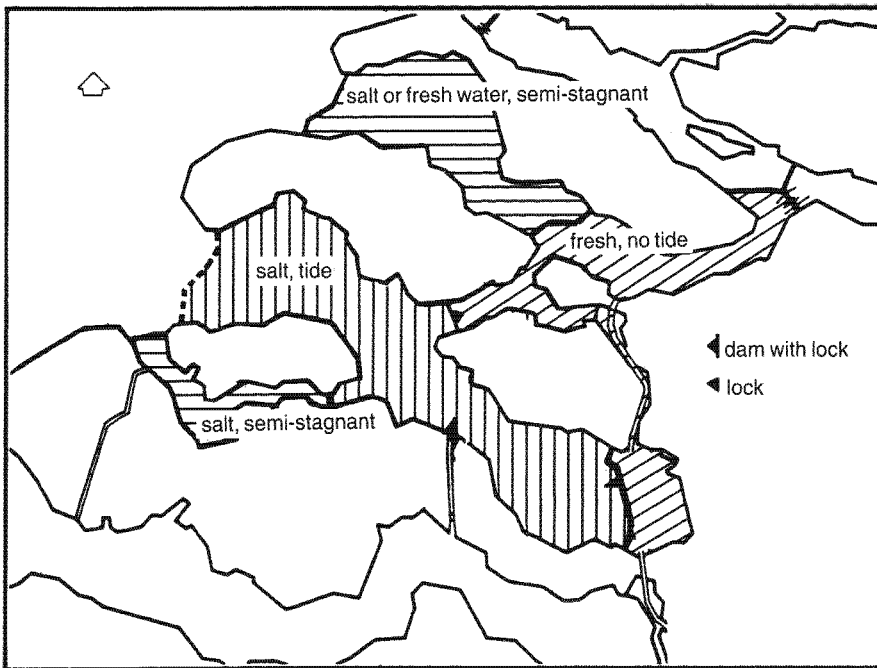

Fig. 4 Completion of the Delta plan according to model C5 from the Klaasesz Committee report, the Committee preference.

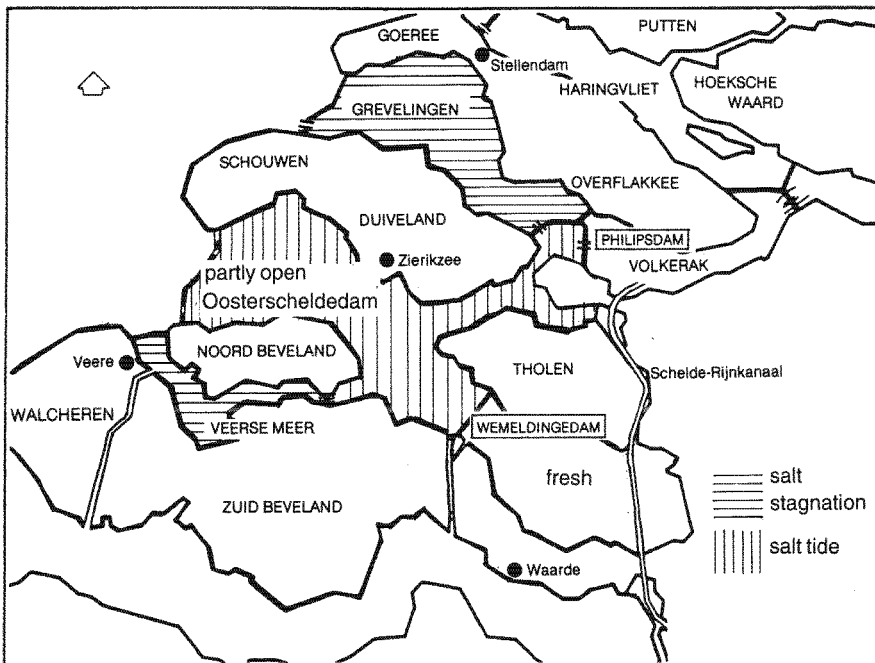

Fig. 5 Completion of the Delta plan according to the advice of the Board of the State Department for Public Works.

and would technically be possible. The State Planning Committee (SPC) was asked to further advise the government on this decision. An inter-departmental ad-hoc study group was formed to study the problems (Doc.1).

On October 1st, 1974, the SPC advised that the Oosterschelde be enclosed with a movable pervious caissons, a so-called stormearth-caisson-dam with compartmentalization, after model C3 (Fig. 8) from the Klaasesz Committee report, which features an Oysterdam and a Philipsdam with supplementary navigation channel through Zuid-Beveland at Waarde (Fig. 6). This advice with the proviso that further study should be done on compartmentalization, was submitted to Parliament as a government decision in November 1974.

It was accepted by Parliament with a small majority (75 in favour, 67 against) on three conditions:

- Construction would be technically feasible;
- The work should be finished in 1985;
- The extra costs should not be higher than Hfl. 1750 million plus a 20% margin.

If from further studies it would appear that one or more of these condition could not be met, then the Oosterschelde should be totally enclosed.

The minister gave the State Department for Public Works a year and a half to further elaborate on the project before a definite decision would be taken. In this period two further studies were done with the help of industry (contractors and

engineering companies), and a number of domestic and foreign institutes:

- Policy analysis on management of the three alternatives for the Oosterschelde (open, storm-surge barrier, enclosed; Figs 7-9);
- Technical feasibility studies of a storm-surge barrier.

In December 1974, the minister established the Committee Compartmentalization Oosterschelde, which was given the task to look further into the problem of compartmentalization. In its report of April 1975, this committee also preferred compartmentalization after model C3 of the Klaasesz Committee. With regards to navigation, one of the possibilities studied was enlargement of the channel through Zuid-Beveland. This

possibility later became a definite choice. On basis of an existing plan for construction of a still caisson-dam, it was decided in 1975 to build two construction docks at the Damvak Geul (see Part 4, Sections 3.2 and 4.3). Further delay of this decision, awaiting results of further studies, would have endangered the deadline of 1985.

In May 1976, the above mentioned studies of the State Department for Public Works, in co-operation with many others, such as the Oosterschelde Study Committee (Stucos) and the Randcorporation, were finalised with two reports (the so-called white and blue papers, Doc.2 and 3) and were given to Parliament via the minister. In the analytical policy study (white paper) all pros and cons of the three alternatives studied were

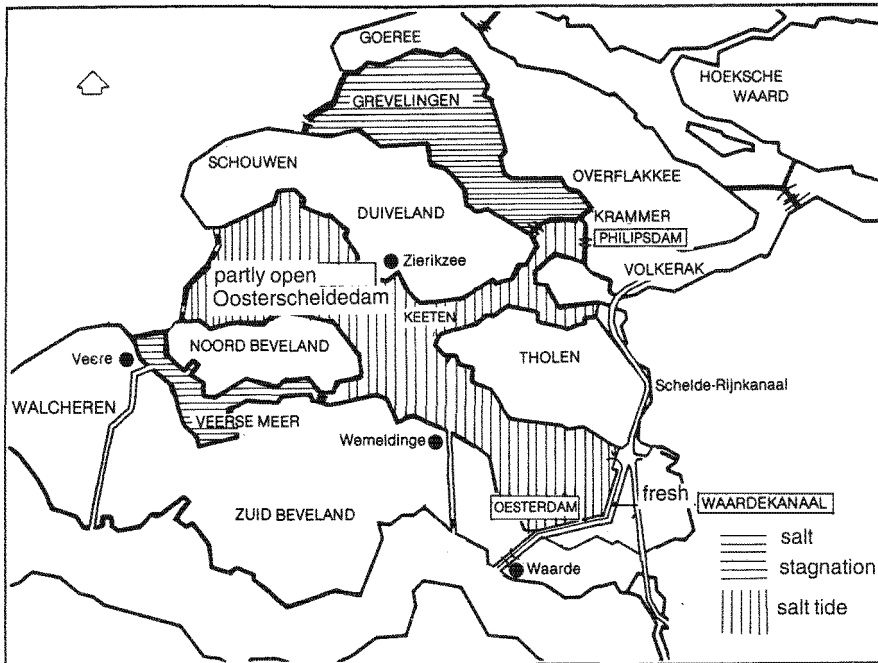

Fig. 6 Completion of the Delta plan according to the advice of the State Planning Committee.

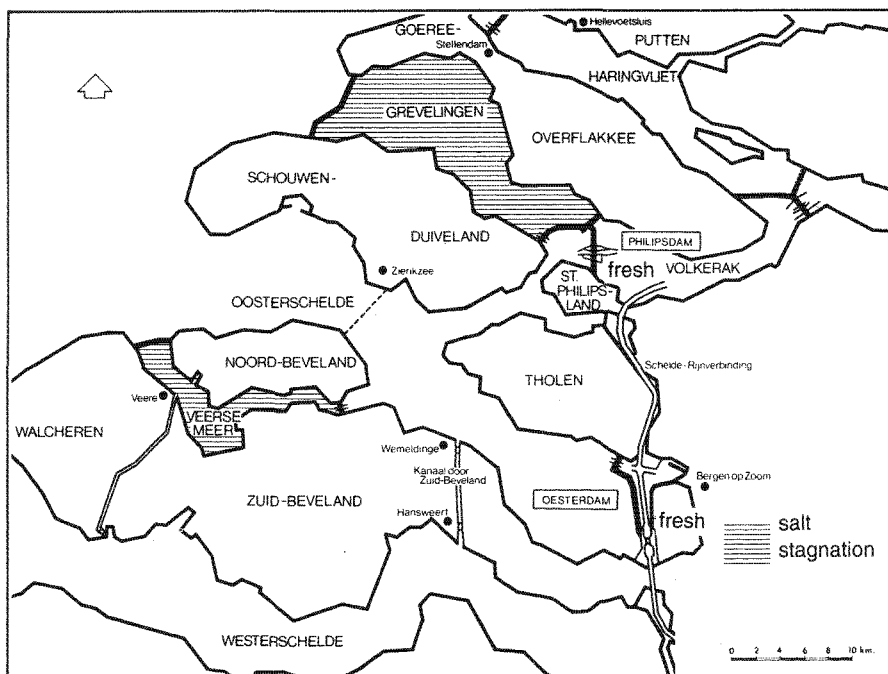

Fig. 7 Analytical policy study, alternative A3, an open Oosterschelde.

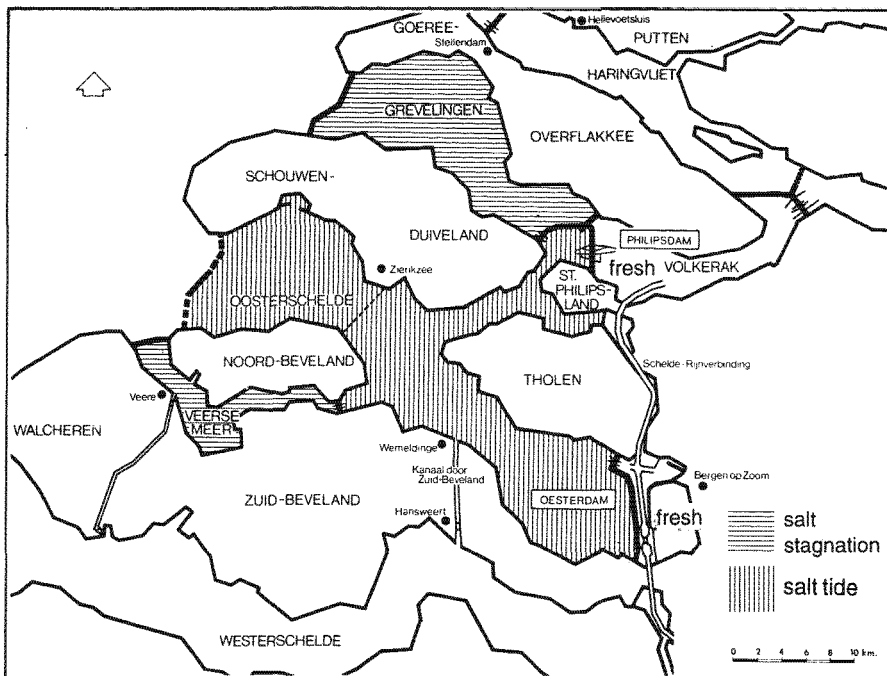

Fig. 8 Analytical policy study, alternative C3, storm-surge barrier.

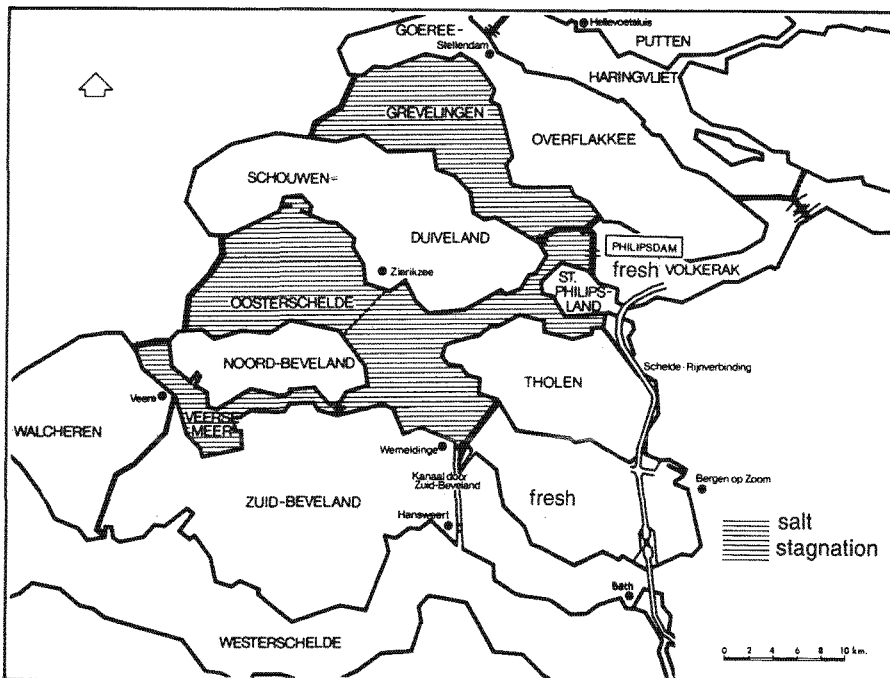

Fig. 9 Analytical policy study, alternative D4, an enclosed Oosterschelde.

again looked at and commented on.

The alternative for the storm-surge barrier (C3) especially had disadvantages with regard to costs. Other aspects of the alternative were favourable (Table 1). The report did not make a choice however, as that was a political matter.

The study of the technical possibilities for execution (blue paper), in which three alternatives were looked at:

- Caissons founded 'on sill',
- Caissons founded on foundation caissons,
- Piers founded on caissons,

resulted in a preference for preliminary design of a storm-surge barrier with 'piers on caissons'. This plan appeared to be cheapest, according to the estimate, and would give the best probability for completion before the deadline.

Total costs of the pierdam and compartmentalization were estimated at Hfl. 4315 million with only a small reserve (5%) for the unforeseen, with 1976 as price index.

This exceeded costs of an enclosed dam by Hfl. 2585 million (at the same price index) and also the limit set in 1974, which was also calculated at the same price index. The design started with a net cross section of 11,500 m² below N.A.P. (mean sea level M.S.L. = N.A.P. (in Dutch) = A.O.D., Amsterdam Ordnance Datum) which allowed for an average tide difference at Yerseke of 2.30 m, which is 60% of the present tide in the Oosterschelde. It appeared that with higher surplus-costs it was possible to create a larger wet cross-section and through that a larger tidal difference on the Oosterschelde.

On the condition that costs were not allowed to rise any further,

Table 1 Results of analytical policy study.

Summary of the scores	C3	D4	A3
<i>Safety</i>			
Year in which final safety goal is reached	1985	1980	1994
Length of primary barrier (km)	9	9	145
Quality of primary barrier	+	+	-
Optimum barrier	yes	yes	no
Probability of flooding in transition period (%)	3.5	2.5	9
<i>Environment</i>			
Richness of species in salt water	<i>h</i>	-	<i>h</i>
Richness of species on banks	+	++	h
Richness of species in Delta area	+	-	+
Bio mass in saline area	+	--	-
Effects on intersections, nature areas and dike landscapes	-	<i>h</i>	--
<i>Professional fishery</i>			
Annual loss of employment in fishery (in man-years)	7	160	0
Cap. nation-econ. loss (in million guilders)	10	187	0
<i>Water management</i>			
Max. salinity in Zoommeer 9CL-/l at extra flushing of 100m ³ /s	0.5	0.35	0.6
Appeal to national water management at a max. salinity of Zoommeer (m ³ /s) 0.5 g CL/l in dry periods	150	60	>155
<i>Inland navigation</i>			
Capital costs of inland navigation (in million guilders)	172	166	174
<i>Recreation</i>			
Increasing recreation in Oosterschelde area (%)	0	25	0
<i>Procedures and costs</i>			
In accordance with Delta-law	yes	yes	no
Surface of land to be expropriated (ha)	430	300	750
Total of construction costs starting from 1.1.1976 (in million guilders)	4635	2135	3620
Capital construction costs (in million guilders)	3180	1485	2025
Cap. costs for maintainance (in million guilders)	110	70	30
<i>Employment</i>			
Total effect on employment (in man-years)	34600	15500	23500

* No change from the present situation is marked with an *h*

Key: **Relatively unfavourable**

Centre position

Relatively favourable

Parliament accepted the government's decision in June 1976. A definite decision on the size of the wet cross-section would be made after a supplementary study. In fact this gave the go-ahead for construction of the storm-surge barrier.

In July 1977 the preliminary design of the storm-surge barrier was altered again. The piers-on-caissons construction was replaced by a monolithic pier which could be pre-fabricated and would be founded relatively high, 'on sill' and on a to be compacted subsoil (see Chapter 4).

In respect to the wet cross section, the government and Parliament decided in August 1977 on the second of the three variations studied, namely 14,000 m³ net with estimated surplus costs of Hfl. 100 million (see also Section 3.1).

This also gave way to the design of the storm-surge barrier as it is described in this design plan.

Finally it should be stated that in 1980 it appeared the cost limit permitted by Parliament would be exceeded, and in 1981 it appeared the storm-surge barrier would only be operational by 1986.

By that time work had progressed so much, that changing decisions taken earlier would not make sense.

Literature

- 1 Delta-law
Driemaandelijks Bericht Deltawerken nr. 3 Febr. 1958, pag. 3-8
- 2 Report on storm-surge of 1953
Composed by State Department of Public Works and K. N. M. I.
The Hague 1961, Staatsdrukkerij en Uitgeversbedrijf
- 3 Report Committee Delta part 1: 'Final report and advice', part II-V: Bijdragen, Staatsdrukkerij en Uitgeversbedrijf. The Hague 1961
- 4 Final report of Delta Committee (a.o. with an index of design-standards along the Dutch coast) Driemaandelijks Bericht Deltawerken, nr. 15, Febr. 1961., Pag. 3-4
- 5 Work and conclusions of Delta Committee

- Driemaandelijks Bericht Deltawerken nr. 19, Febr. 1962, Pag. 3-11
- 6 Stuvell H.J.: Het Deltaplan, de geboorte Amsterdam 1956, Scheltema en Holkema N.V.
- 7 Pre-history of Delta Plan
- Driemaandelijks Bericht Deltawerken, nr. 1, August 1957. Pag. 5-11
- 8 Sources of Delta Plan
- Driemaandelijks Bericht Deltawerken, nr. 83, Febr. 1978, Pag. 115-123
- 9 Report of Oosterschelde Committee (Klaasesz Committee) The Hague, March 1974, Staatsuitgeverij, ISBN 9012003881
- 10 The government's decision on enclosure of the Oosterschelde
- Driemaandelijks Bericht Deltawerken nr. 71, Febr. 1975, Pag. 3-5
- 11 Policy analysis for enclosure of the Oosterschelde
- Driemaandelijks Bericht Deltawerken, nr. 74, Nov. 1975, Pag. 167-174
- 12 Open, enclosed or open/enclosed
- A summary of the report: Analyse Oosterschelde Alternatieven (white paper)
- Driemaandelijks Bericht Deltawerken nr. 78, Nov. 1976, Pag. 412-440 and Pag. 465-476
- 13 The choice of a storm-surge barrier for the Oosterschelde
- A summary of the report: Stormvloedkering Oosterschelde eindrapport (blue paper)
- Driemaandelijks Bericht Deltawerken, nr. 78, Nov. 1976, Pag. 441-452
- 14 The opening in the Storm-Surge Barrier
- A summary of the studygroup's report, choice of opening.
- Driemaandelijks Bericht Deltawerken, nr. 81, August 1977, Pag. 41-45
- 15 Maas, Kees v.d., Oosterschelde: From conflict to compromise,
- Driemaandelijks Bericht Deltawerken, nr. 83, Febr. 1978. Pag. 126-141

Documentation

- 1 Report of Study group Oosterschelde (red paper) September 1974
- 2 State Department of Public Works
- Analyse Oosterschelde Alternatieven, The Hague, 21 May 1976 (white paper)
- 3 State Department of Public Works
- Final Report Storm-Surge Barrier 'Onderzoek naar de mogelijkheid van de afsluiting van de Oosterschelde met een gedeeltelijk geprefabriceerde Stormvloedkering' The Hague, May 1976 (blue paper)
- 4 State Department of Public Works
- Report of Study group for an opening, March 1977
- 5 Advice of the Board of department for Public Works to the Minister of Transport and Public Works regarding the Oosterschelde Committee's report, June 1974
- 6 Advice of the State Plannings Committee, October 1974
- 7 Report of the Committee Compartmentalization Oosterschelde, April 1975
- 8 Advice of the Board of the Department for Public Works to the Minister of Transport and Public Work regarding the Committee Compartmentalization Oosterschelde's report, 23 October 1975

2.2 The impact of the project on the South-West of the Netherlands

The Storm Surge-Barrier is a part of the Delta Plan's completion (i.e. the Southern Part), according to the C3-alternative of the Klaasesz Committee's report and as it has been elaborated over the years in various reports and studies. This entire complex of work to be carried out and the already finished structures show strong cohesion (Fig. 10).

This paragraph briefly describes the engineering of these works and, when possible, the future trend of developments that can be expected.

In essence the plan combines enclosure of the Oosterschelde, necessary for protection from storm-surges, and preservation of the salt tidal environment in this same Oosterschelde. A compromise between two seemingly contradictory issues, made possible by the design of a movable storm-surge barrier.

During storm-surges the closed storm-surge barrier becomes a primary barrier; by no means, however, to the same degree of retention achieved with a closed dam. Even when the structure is closed, construction will allow a certain water volume to pass, which can be received by the basin capacity of the Oosterschelde with a limited increase in water level.

The existing dikes which border the tidal water and the to be constructed compartment-dams, function as secondary retaining structures.

Under 'normal' circumstances the barrier will be kept open and a limited tide maintained in the Oosterschelde and its connecting waters. For high water levels under these conditions, the existing dikes maintain their function as primary barrier.

By manipulating the storm-surge barrier in the correct manner, set safety standards can be met. In the BARCON project (Barrier Control) desired and feasible strategies were studied (Part 5, Chapter 1). Besides the already partially executed dike heightenings to improve safety during the non completion period of the storm-surge barrier, further heightenings of existing dikes could be omitted. It will be necessary however to check if the revetments the outer slopes of the existing dikes give sufficient all round protection against particular circumstances that could arise when the storm-surge barrier is closed. There is a real possibility that during storm conditions, when the Oosterschelde is temporarily stagnated with a relatively high water level, a concentrated wave attack could occur at a certain height on the slope; a situation which would not appear in tidal circumstances.

With this variation of the original Delta Plan, the second main aim, i.e. the improvement of the fresh water management in the South Western part of the Netherlands, especially for the Zeeuwse islands, was omitted in favour of a new aim: to maintain, as much as possible, the natural values/areas (the salt tidal environment), particularly in the Oosterschelde. The bulk of the Zeeuwse islands will remain surrounded by salt water.

In this respect, it should also be noticed that in case of a definite enclosure of the Oosterschelde (according to the original plan), managing the water like a stagnant salt water basin was considered. This, because to successfully freshen the water was seen as problematic (Fig. 9). In this alternative, Veerse Meer and Grevelingen Meer would become stagnant salt water basins. If necessary, it still remains possible to freshen the water in the Grevelingen Meer.

Only along the mainland of West-Brabant, will a long narrow

fresh water basin (the Zoommeer) be formed by means of the Philipsdam (between St. Philipsland and the Grevelingendam) in the Krammer and in Volkerak, and in the Oosterschelde by means of the Oysterdam.

This semi-stagnant fresh water basin is necessary because:

- According to the Treaty with Belgium, the Schelde-Rhine connection should be a canal free of tides and the area north of the Kreekrak locks has already been built on the basis of the normal sea level standards, with fixed Rhine navigational height bridges;
- The present salt (saline)-load on the Haringvliet via the Volkerak locks is undesirable for water management of the northern Delta area;
- Limiting the tide on the Oosterschelde makes drainage of rivers and polders in West-Brabant more difficult and in some cases it will no longer be possible to drain by gravity flow;
- This fresh Zoommeer can make an important contribution to the fresh water supply to the southern part of the Delta area, e.g. for a possible freshening of the Grevelingenmeer.

The Zoommeer can be fed with water from the Rhine/Meuse via the Volkerak locks. Drainage to the eastern part of the Oosterschelde is not desired, because it would cause too high a drop in the salinity of that area. It was decided to have drainage to the Westerschelde via the Bath canal. The Bath canal will be built alongside the Schelde-Rhine channel, across the neck of Zuid-Beveland with a discharge which will flow into the Westerschelde at Bath.

The submerged Land of the Marquisate van Bergen op Zoom will become a sub-compartment within the Zoommeer by construction of the Marquisate's-embankment. This makes it possible to have separate management for water quality and to protect the area against the polluting influences of navigation on the Schelde-Rhine connection.

For the benefit of navigation to the Oosterschelde basin and to the Westerschelde the Philipsdam will have two push-tow navigation locks and a yachts lock, all with a salt-fresh water separation system.

The canal through Zuid-Beveland will be enlarged and new push-tow navigation locks will only be built at Hansweert. The lock complex at Wemeldinge will become inoperative, and the limited tide of the Oosterschelde will be permitted in this canal in the future. In this way, the present number of locks will remain the same for through traffic to the Westerschelde. For the benefit of the, in the future restricted, navigation from the Oosterschelde basin to Bergen op Zoom a lock (Bergse-Diep Lock) will also be constructed in the Oysterdam. This lock will not be supplied with a salt/fresh water separation system.

Also, for navigational purposes, the Oosterschelde basin will have a direct connection with the North Sea via a shipping lock, (Roompot Lock) which will be constructed in the storm-surge barrier.

The completed Delta Plan described herein also contains improvements for road traffic.

The road-connection across the storm-surge barrier between Schouwen and Noord-Beveland forms the final piece in the dam road (RW 57), the aim of which is to make the islands more accessible for tourist traffic, rather than to facilitate a fast traffic connection between Rotterdam and Vlissingen.

The road constructed across the Philipsdam will provide the islands of Schouwen-Duivenland and Goeree-Overflakkee with a direct link to West-Brabant whereby the car ferry be-

tween Zijpe and the Anna Jacobapolder can be discontinued. The Oysterdam will make it possible to construct a shorter route between Tholen and Zuid-Beveland.

The execution of the whole plan will have severe consequences for the landscape. In the Zoommeer area its consequences will be radical, because the saltings and the vegetated mud-flats situated above normal sea level, will run dry and the environment will become a fresh water eco-system.

In spite of the plan's original intention to maintain, as much as possible, the natural value of the rest of the tidal region, here too changes will take place, though less radical.

From a visual point of view, in particular the western part of, the Oosterschelde will lose some of its openness. In the east, there is the Zeelandbridge, whereas in the west the horizon will be screened by the dominating silhouette of the storm-surge barrier.

The Neeltje Jans/Damvak Geul/Noordland complex, and to a lesser extent the Roggenplaat island and its nearby construction harbours, allow for new developments (see Part 5, Chapter 2). The construction harbours Schelphoek and Sophiapolder will become available for new destinations.

With the reduced difference in tide, the surface of the so-called intertidal region will decrease. The saltings outside the compartmentalization will probably grow at the expense of the higher situated shallows. Vegetation on the highest situated parts of the saltings can change because of the lower flood frequency, through which it can become desalinated.

The current velocity in the Oosterschelde will generally decrease, through which the possibility of silt deposit will increase which will endanger the existing mussel and oyster-beds. On the other hand the supply of silt from the North Sea will be reduced.

The fresh water supply to the tidal region of the Oosterschelde is reduced by compartmentalization and measures for water management of the fresh water basins, which allows for better maintenance of a relatively high salinity level. This is beneficial to the development of sea life in general and to the mussel and oyster culture in particular.

The future development of the Oosterschelde area is an integrated process in which natural and social elements play a part and which needs preparation and guidance to safeguard the desired balance.

For this purpose a guidance group was set up in 1977, the 'Stuurgroep Oosterschelde', in which State, provinces, city councils and polder districts worked together. This guidance group made a policy plan in which the entire Oosterschelde area is regarded as a functioning entity, and which gives the opportunity to guide occurring developments.

By the use of compartmentalization, the changes in the environment of the future Zoommeer and Markiezaatmeer have been radical.

The salty tidal environment is replaced by a semi-stagnant fresh water environment. All land beyond the dikes (saltings and shallows), above MSL, will permanently run dry. During and after this process, new vegetation will develop.

With good management, these developments can be guided and will have important effects on the landscape.

Good management and planning should envision the new possibilities coming up for these lands and the waters bordering it. On the initiative of the Compartmentalization Committee Oosterschelde policy-plans concerning organization and management of this area have been and will be drafted.

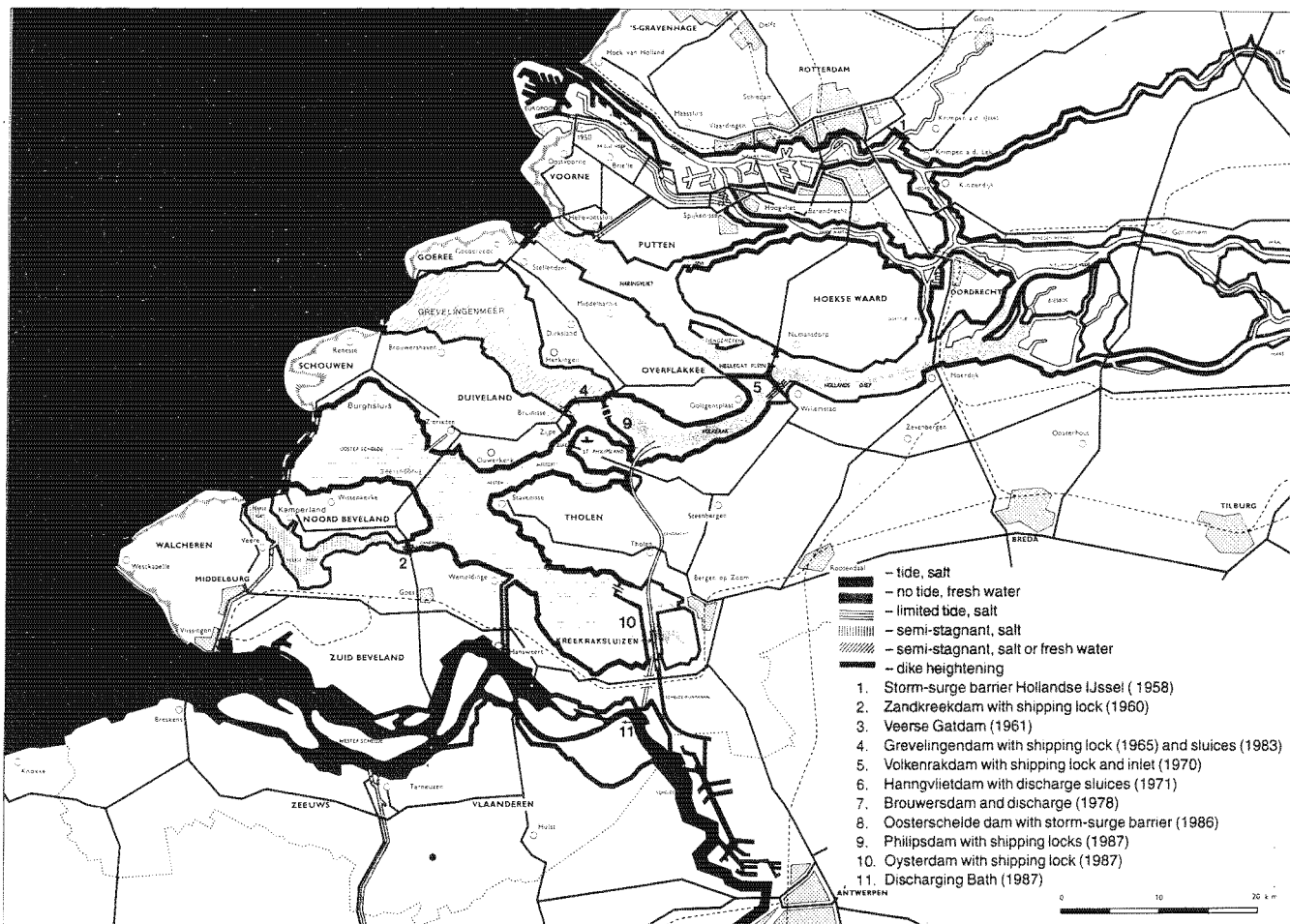

Fig. 10 The Delta Plan in its present form.

Literature

- 1 'Partial dike heightening'
A. Driemaandelijks Bericht Deltawerken nr 74, Nov. 1975, Page 223-234
- B. ditto nr 77, August 1976, Page 406-408
- C. ditto nr 80, May 1977, Page 577-579
- D. ditto nr 84, May 1978, Page 190-200
- E. ditto nr 88, May 1979, Page 416-421
- 2 'Water management relations in the Delta area'
Driemaandelijks Bericht Deltawerken nr 87, February 1979, Page 357-375
- 3 'The salinity in the Oosterschelde after 1985'
Driemaandelijks Bericht Deltawerken nr 92, May 1980, Page 80-84
- 4 'Silt movement in the Oosterschelde'
Driemaandelijks Bericht Deltawerken nr 101, August 1982, Page 39-48
- 5 'Organization and management of the Oosterschelde area'
Driemaandelijks Bericht Deltawerken nr 95, February 1981, Page 248-253
- 6 'The Zoommeer water management'
Driemaandelijks Bericht Deltawerken nr 80, May 1977, Page 549-553
- 7 'The Zoommeer water level'
Driemaandelijks Bericht Deltawerken nr 87, February 1979,

Page 376-379

- 8 'Organization and management of the Marquitate'
Driemaandelijks Bericht Deltawerken nr 95, February 1981, Page 272-279
 - 9 'Organization and management of the Marquitate'
Driemaandelijks Bericht Deltawerken nr 106, November 1983, Page 331-353
 - 10 'The future development of the Krammer-Volkerak'
Driemaandelijks Bericht Deltawerken nr 107, February 1984, Page 337-383
 - 11 'Possibilities for the organization of 'de Plaat van de Vliet' (Volkerak)'
Driemaandelijks Bericht Deltawerken nr 107, February 1984, Page 384-388
- See documentation reference in Part 5, Section 2.2

Documentation

- 1 Policy-plan for the Oosterschelde,
Report of the Oosterschelde guidance group.
See documentation reference in Part 5, Section 2.2.

3 Boundary conditions for storm-surge barrier

3.1 Effective cross section

The main motive for deciding to construct a storm-surge barrier instead of a closed dam to protect the Oosterschelde basin against storm-surges, was the political desire to maintain the tide in the Oosterschelde, which protects the present natural values and fishery interests.

The ideal situation, to completely maintain the tidal pattern, was technically impossible. A certain limitation of the tide had to be accepted.

To maintain the existing natural values, a certain minimum salinity level will be required. This level depends on the tidal volume and the maximum area of the inter-tidal region, in turn dependent on the size of the difference in the vertical tide. On the basis of the mathematical one-dimensional tide model IMPLIC (Fig. 11), verified with practical data, and proceeding from an average offshore tide, a connection could be established between the net cross-sectional area in the storm-surge barrier and the tidal volume and the vertical tide at some points in the Oosterschelde (Fig. 12). The average tide at Yerseke was kept as a yardstick, because of the existing oysterbanks and mussel waters. In the Klaasesz Committee's report, an average tidal difference of 1.8 m at Yerseke was thought acceptable. In previous decisions in 1974, the State Planning Committee advised an average tidal difference of 2.3 m as a boundary condition for the design. As a result, three alternatives for the average tidal difference, 2.3 m, 2.7 m, and 3.1 m (Table 2) respectively were re-evaluated. Aspects of environment, water management, fishery, and financial-economic aspects were involved in the study. The safety aspect appeared to be fairly consistent within these variations. From this analysis (see Table 3), it appeared that at an increasing tidal difference, the financial-economic aspects became more unfavourable, and the other aspects became generally more favourable.

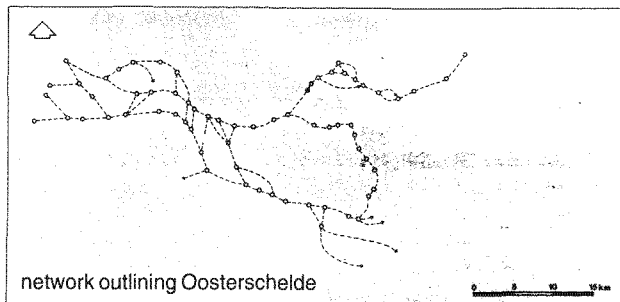

Fig. 11 Outline of the one-dimensional IMPLIC-model for the Oosterschelde.

The political decision was to have an 'average minimum' tidal difference of 2.7 m at Yerseke, which would correspond with a net cross section of 14,000 m² below normal sea level as a boundary condition in the design of the storm-surge barrier. The notion 'average minimum' was not elaborated on and in fact this does not exist.

The Project-group interpreted the notion in such a way that maximum possibility should be provided for the realisation of an average tidal difference of 2.7 m at Yerseke.

Starting with a discharge coefficient of 0.90, which was thought to be realistic, a net cross section of 14,000 m² will translate into a gross cross section of about 15,500 m².

To be on the safe side, the gross outlet was enlarged by a gross reserve of 2,500 m²:

- Loss of wet cross section by maintenance work when the gates are closed (1,000 m²)
- Loss of wet cross section by eventual permanent closure of a number of gates to correct the divisions of resistance graduation over the closure gaps (750 m²)
- Uncertainties in determination of discharge coefficient (750 m²)
- Uncertainties in reproduction of the vertical tide in mathematical models used (1,000 m²).

The last three components were seen as standard deviations from an average value. Their total influence was calculated by keeping to the root of the sum of the squares (about 1,500 m²).

In this way a cross section of 15,500 m² + 2,500 m² = 18,000 m² below normal sea level was taken as the starting-point for the appropriate design.

It was expected that the average tidal difference at Yerseke would be 2.80 m. If all mentioned uncertainties did not meet expectations, the tidal difference would become 2.70 m, and were they to exceed expectations, then the difference would become 2.90 m (Doc. 1).

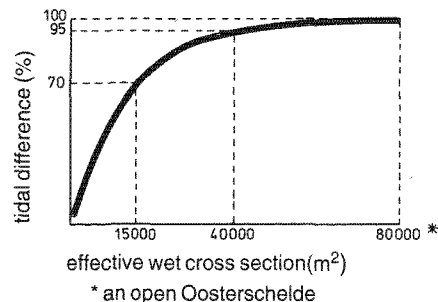

Fig. 12 Reduction of the vertical tide (Yerseke) as function of the wet cross section.

Table 2 Some data of the analysed alternatives.

Parameter of the tide	Alternative 2.30	Alternative 2.70	Alternative 3.10	An open Oosterschelde
Average tidal difference at Yerseke	2.30 m	2.70 m	3.10 m	3.50 m
Reduction of tide	35%	25%	10%	–
Average volume of tide	675.10 ⁶ m ³	800.10 ⁶ m ³	925.10 ⁶ m ³	1250.10 ⁶ m ³
Reduction of tidal volume	45%	35%	25%	–
Maximum velocity through structure at an average tide	5 m/sec	4.5 m/sec	4 m/sec	1.3 à 1.5 m/sec
Effective cross section	11,500 m ²	14,000 m ²	20,000 m ²	80,000 m ²

Table 3 Result of policy analysis with regard to the effective cross section Survey.

Aspects	Sub-aspects	Variations		
		2.30	2.70	3.10
Environment	Surface under tidal influence	U	O	F
	<i>Siltings</i>			
	– probability of keeping salt strength	U	O	F
	– probability of expanding	U	O	F
	– probability of erosion	U	O	F
	– probability of increase in the diversity of sorts	F	O	U
	<i>Inter-tidal region</i>			
	– surface	U	O	F
	<i>Water</i>			
	– probability that the salinity level of the Oosterschelde is lower than the set standards	U	O	F
	– probability of good water-quality	U	O	F
– probability of a decrease in the diversity of sorts	U	O	F	
Water management	<i>Salinity management</i>			
	– mixing of polder and lock water	U	O	F
	– water exchange with the North Sea	U	O	F
	– freedom of choice between salt water Grevelingen/fresh water Grevelingen	U	O	F
Fishery	<i>Oyster cultivation</i>			
	– risk of a decrease in production	U	O	F
	<i>Mussel cultivation</i>			
	– risk of a decrease in production	U	O	F
	– possibilities of natural dilution of water	U	O	F
	<i>Shrimps</i>			
– risk of a decrease in production	U	F	F	
Financial-economic aspects and employment	<i>Storm-surge barrier</i>			
	– extra investment	F	O	U
	– extra maintenance	F	O	U
	– extra employment	U	O	F

Key: U = relatively unfavourable
 O = centre position
 F = relatively favourable
 } in comparison with each other

In 1982, with the help of adjusted data, a revised calculation of the future average tidal difference at Yerseke was made.

- In earlier calculations the notion 'tidal difference of the average tide' was used, while in these calculations the notion 'average tidal difference' was used, which is not exactly the same.
- The increasing trend in the tidal differences along the coast of South-West Holland in the last ten years was taken into account. New tidal data from a certain point on the sea-side of the storm-surge barrier was introduced.
- The shape of the storm-surge barrier in the mathematical

model used (IMPLIC), was adjusted to the latest data available.

- When calculating the average tidal difference at Yerseke, the influence of possible wind effects on the vertical tide in the Oosterschelde was not taken into consideration.

On the basis of this data it could be calculated that a net cross section of 14,000 m² would create an average tidal difference of 2.86 m at Yerseke, and an average tidal difference of 2.70 m would need a net cross section of 12,500 m².

From the storm-surge barrier design, it was expected that:

- The gross cross section would be 17,913 m² below normal sea level, and
- The average of the different discharge coefficients per closure gap (total of 3 closure gaps) for low tide and high tide, would become 0.92 (standard deviation $\sigma = 0,05$).

Further study of maintenance work on the water barrier showed that the sliding gates had only to close briefly, or not at all. It was thought that this would hardly influence the average tidal difference at Yerseke and so the reserve held for these purposes (1000 m²) could be omitted.

Furthermore, the correction reserve for resistance distribution over the closure gaps (gross 750 m²), was no longer considered a factor in the standard deviation of net cross section calculations. It would become a permanent closure if this correction was to be used.

In the new calculations, two separate cases were distinguished:

- without this so-called 'morphological' closure, and
- with the 'morphological' closure, which means a permanent closure of four gates (gross 750 m²) close to the shore.

The rest of the uncertainties, i.e. that of the drainage coefficient and the mathematical model itself, were introduced as a standard deviation of the calculated net cross section.

Case a: The expected average tidal difference at Yerseke without applying corrections to the resistance distribution over the closure gaps and a computation of odds for realization of a smaller net cross section. The gross cross section of 17,913 m², with an average discharge coefficient of 0.92 results in a net cross section of 16,480 m² (standard deviation $\sigma = 1,350$ m²). This net cross section was expected to create an average tidal difference of 3.10 m at Yerseke (standard deviation $\sigma = 0.42$ m). The probabilities that a net cross section of 16,480 m² is not realised, but instead a net cross section of 14,000 m² or 12,500 m² respectively, and based on this uncertainty (standard deviation) the net cross section was estimated at 3.4% and 0.16%.

Table 4 summarizes this data, and it also indicates the expected probabilities of not exceeding the three tidal differences at Yerseke (2.70 m, 2.30 m, 1.80 m) for the abovementioned net cross sections.

Table 4 *Case a:* The chance of not realization of a certain tidal range in the Oosterschelde (Yerseke) for given openings of the barrier when the correction on flow distribution is not applied (all gates open).

Net cross section	Chance of not realization	Average tidal rang at Yerseke +(σ)	Expected number of exceedance per year (%) of a given tidal range		
			2.70 m	2.30 m	1.80 m
80,000 m ²		3.53 m (0.51 m)	35 (5%)	6 (0.8%)	- (0.03%)
16,480 m ²	50%	3.10 m (0.42 m)	120 (17%)	20 (3%)	1 (0.1%)
14,000 m ²	3.4%	2.87 m (0.35 m)	221 (31%)	36 (5%)	1 (0.1%)
12,500 m ²	0.16%	2.70 m (0.32 m)	353 (50%)	75 (11%)	2 (0.25%)

Table 5 *Case b:* The chance of not realization of a certain tidal range in the Oosterschelde (Yerseke) for given openings of the barrier when the correction on flow distribution is applied (750 m² brutto, equal to 4 gate-sections closed at the bank side).

Net cross section	Chance of not realization	Average tidal rang at Yerseke +(σ)	Expected number of exceedance per year (%) of a given tidal range		
			2.70 m	2.30 m	1.80 m
15,790 m ²	50%	3.04 m (0.39 m)	134 (19%)	20 (3%)	- (0.07%)
14,000 m ²	8.7 %	2.87 m (0.35 m)	221 (31%)	36 (5%)	1 (0.1%)
12,500 m ²	0.64%	2.70 m (0.32 m)	353 (50%)	75 (11%)	2 (0.25%)

Case b: The expected tidal difference at Yerseke, with application of the corrections on the resistance distribution over the closure gaps (gross 750 m²) and computation of probability of realization of a smaller net cross section.

The gross cross section of 17,913 m² - 750 m² = 17,163 m² with an average discharge coefficient of 0.92 results in a net cross section of 15,790 m² (standard deviation $\sigma = 1,320$ m²). It was expected that this net cross section would give an average tidal difference at Yerseke of 3.04 m (standard deviation $\sigma = 0.39$ m).

The probability that a net cross section of 15,790 m² was not realized, but instead a net cross section of 14,000 m² or 12,500 m², was estimated at 8.7% and 0.64% based on the uncertainty (standard deviation) of the net cross section. This data is summarized in Table 5.

This approach also defines the notion 'minimum average tidal difference'. The probability that an average tidal difference at Yerseke of 2.70 m is not being realized, is smaller than 0.16% (Case a) or 0.64% (Case b) (Doc. 2).

In 1984 an estimate was made again of the gross cross section according to the design. The results of a few alterations were introduced.

The situation was then as follows:

- December 1981 design, 32 outlets in the 'Roompot', gross cross section: 18,043 m²
- Measures regarding the possible use of the 'Universally Useable Insert Pier' (UIP, Part 1.4, Section 2.5), 3 piers will be constructed 1 meter higher and therefore 3 sill-beams will also be positioned 1 meter higher (1982): - 118 m²
- The UIP will not be placed, one outlet in the 'Roompot' will be dropped (1983) - 178 m²
- Lowering the retaining height of the 'Hammen' and consequently lowering the level of the sill beams by about 0.2 m: ± 130 m².

Expected gross wet cross section 17,877 m².

This number differs by 36 m² or 0.2% from the number upon which earlier prognosis were based; a difference that only has a marginal influence on the expectations regarding the average tidal difference at Yerseke.

The real gross cross section can only be determined after completion of the storm-surge barrier. The actual influence of the storm-surge barrier on the average tidal difference at Yerseke can only be assessed after years of in situ measurements.

3.2 Safety (retaining height/crest elevation)

The storm-surge barrier, together with the main water retaining structures positioned behind it, forms a system around the Oosterschelde that is to give the surrounding area its so-called 'Delta safety'.

The Delta Committee comments in its report (Page 37): 'The estimated costs are in reference to plans which begin with the demand that the most vital parts of our country should be made safe against storm floods, with an exceedance frequency of 1% per century, while for the other parts of the country a higher exceedance frequency is taken as starting-point. As it is impossible to determine the highest possible storm-surge level, there will always be the risk of a disaster, whatever height of storm-surges one takes as a basis for improvement of the main water retaining structures'.

The water level of the storm-surge in the context of the above-mentioned quote, will be indicated by the term 'basic level'. For the 'other parts of the country', the acceptably higher exceedance frequency is realized by lowering the basic level for those areas (among which Zeeland) with 0.3 m, which gives an estimated exceedance frequency of 2.5×10^4 per year, which is 2.5% per century.

The term 'design level' indicates the water level used in the design of the dikes. In some cases it corresponds with the basis level, in other cases it corresponds with the above-mentioned lowered level.

It can be derived from the above mentioned quote that it was the Delta Committee's intention particularly to protect Zeeland against storm surges with an apparent probability of 1 in 4000 years (exceedance frequency 2.5×10^4 per year).

In view of the storm-surge barrier's protective function for the Oosterschelde basin, the following can be concluded:

- a. The retaining height (crest elevation) of the storm-surge barrier needs to be adjusted to the advised design level for main water retaining structures in the south-west of the country.
- b. For the storm-surge barrier itself, a design-load should be taken into account as a result of the potential threat with an exceedance possibility of 1% per century (for the south-west of the country a 2.5 times larger probability) (Doc. 4 and 5)

For the retaining height of the storm-surge barrier, the advised design level for the northern dam abutment in Schouwen is mean sea level + 5.3 m, and for the southern dam abutment in Noord-Beveland it is mean sea level + 5.5 m.

Taking into account the settlements of the barrier and the relative rise in sea level during the life-span of the barrier, retaining height was established at mean sea level + 5.8 m.

At first this size was to be valid for the whole movable part of the storm-surge barrier. During construction however, it appeared sensible to increase the foundation depth of the piers in the closure gap 'Hammen' by 0.2 m, which the design level for that area allows for.

Consequently, the retaining height for the closure gap 'Hammen' was established at normal sea level + 5.60 m (Doc. 6).

With respect to the design-load on the storm-surge barrier as a

preventive entity against a potential threat, this potential threat can be divided into two parts:

- First, a potential threat from outside, summarized in a head difference and wave load, and
- Second, a potential threat from within, in the sense of failure of part of the barrier (for instance a gate that will not move) causing a collapse of the barrier, meaning that the barrier is not able to keep the violence of the storm flood out of the Oosterschelde.

Concerning the reserves with which these potential threats should be resisted, the Delta Committee did not have any definite answers. Only for the potential threat from the outside, a standard was set for the retaining height of dikes as indication of their strength.

Because the storm-surge barrier is for the most part a construction of concrete, steel, and brick materials, the above mentioned standard could not be used and another had to be looked for. A further elaboration of this problem is given in Part 2: Design philosophy.

3.3 Remaining boundary conditions

Besides the already mentioned more serious boundary conditions, there are some other boundary conditions which were used as starting points for the design.

These boundary conditions are:

Life-span of the barrier

Similar to the design of the discharging in the Haringvliet, in this design it was also determined that the irreplaceable parts of the barrier should have a life-span of 200 years.

Although the distinction replaceable/irreplaceable is relative because of the possible technical innovation, it especially concerns the foundation bed, piers, sill beams and upper beams, and the entire sill construction. The other parts of the barrier can be replaced or repaired and so a shorter life-span becomes acceptable for those parts.

Environmental boundary conditions

The physical, chemical, geological and biological conditions at the location where the storm-surge barrier has to be built, create certain limitations or demands for design. These environmental boundary conditions are further mentioned in Part 3.

Freedom of Management

It appears from provisional studies that different moments can be chosen to close the barrier against a sudden or expected storm-surge. The choice of a particular moment has serious consequences for the Oosterschelde basin, which lies behind the barrier and for that reason is subject to very careful consideration. It also bears consequences on the choice of the design-load for the barrier.

Further details on these aspects can be found in Part 2 and Part 5. The starting-point of design is that the manager should hold maximum freedom in his closing-strategy.

Boundary conditions following political decisions

The boundary conditions referred to have already been discussed in Section 2.1. They are the conditions set by the government and Parliament; costs should not exceed a certain level and the barrier should be ready by 1985.

Although these conditions were a focus-point of design, it has not been possible to meet them.

Documentation

Section 3.1

1 Wet cross section

PGO-Memo nr 6, May 1978, PEGEOO-N-78157

Section 3.4.3

2 Wet cross section and tidal difference

PGS-Memo nr 13, February 1984, PEGESS-N-84053

Section 3.2

4 Interpretation of directions given by the Delta Committee

PGO-Memo nr 2, February 1977, PGO 214, Section 2.1

5 Interpretation of the Delta-law and the Retaining Heights of Construction

PGO-Memo nr 2, February 1977, PGO 214, Appendix 1, Chapter III

6 Retaining Height

PGS-Memo nr 13, February 1984, PEGESS-N-84053, Section 2.4.1, Section 3.3

7 Supplementary starting-points

PGO-Memo nr 2, February 1977, PGO 214, Section 3

Literature

Section 3.1

1 Analysis of cross section variations in the storm-surge barrier, summary report of the study group 'choice of cross section'

Driemaandelijks Bericht Deltawerken nr 81, August 1977, Page 41-45

2 Future changes in tidal movements in the Oosterschelde basin

Driemaandelijks Bericht Deltawerken nr 86, November 1978, Page 284-290

3 Tidal difference at Yerseke after completion of the Oosterschelde construction

Driemaandelijks Bericht Deltawerken nr 105, August 1983, Page 247-250

Section 3.2

Delta Committee:

4 Delta Committee Report Part I:

'Final Report and interim advice'

Staatsdrukkerij- en Uitgeversbedrijf, The Hague 1961

5 Final report of the Delta Committee, with index of design levels along the Dutch coast

Driemaandelijks Bericht Deltawerken nr 15, February 1961, Page 3-4

6 Work and conclusions of the Delta Committee

Driemaandelijks Bericht Deltawerken nr 19, February 1962, Page 3-11

4 Development of the design

4.1 Introduction

During the period 1974-1977, the preliminary designs of a storm-surge barrier in the Oosterschelde showed extensive creativity. Many original ideas were brought forward.

After 1977, this creativity was especially directed at solving a large amount of detailing problems in the chosen design.

Original solutions were thought out and a new way of thinking began within hydraulic engineering and its construction techniques. Some have already been mentioned in the historical survey (Chapter 2). This chapter will try to give an idea of the developments in the design of the storm-surge barrier.

Developments during the study period 1974-1976 are only generally mentioned since extensive attention has been paid to this subject in a separate report ('Oosterschelde storm-surge barrier': Final report and interim reports, Doc. 2). Developments after that period can be found in the 'progress reports', published in December 1976 by the Project-group Storm-Surge Barrier Oosterschelde (the so-called PGO- and the later PGS-plans, Doc. 3-9).

These developments are discussed following the design for the pier, the sill and the foundation bed, being the most peculiar sections of the design.

4.2 From a provisional permeable boulder-dam to a permanent pier-dam

The idea of the Klaasesz Committee to build a storm-surge barrier in the mouth of the Oosterschelde was a revolutionary idea in Dutch hydraulic engineering, especially because of the project size.

Construction of a permeable and tide reducing boulder-dam, albeit provisional, was a revolutionary proposal.

The later construction of a permanent storm-surge barrier in a construction pit (near Damvak Geul) on the other hand was quite traditional (in conformity with the discharging 'Haringvliet').

This would also mean radical morphological changes in the mouth of the Oosterschelde, which would be contradictory to the aim of maintaining, as much as possible, the existing environment in the Oosterschelde.

In a period of about 6 weeks, the Combination Dike Building Oosterschelde studied several proposals for a provisional permeable dam (Fig. 13) at the request of the State Department of Public Works (Rijkswaterstaat). They preferred the culvert caissons alternative (Doc. 1).

The proposal for construction of a permanent storm-surge barrier in the already existing closure gaps, on the basis of movable culvert caissons, quickly followed.

The advantages were:

- No double work (first provisional, then permanent) so total construction time would be shorter and probably cheaper,
- Less radical impact on the morphology in the mouth of the Oosterschelde,
- The already constructed work would fit better in the new design.

The disadvantage was:

- It would take longer to meet the set standard of 'Delta safety' (1985 instead of 1979), given the longer preparation and construction time for the definite character of the construction.

This introduced the idea of prefabricating large parts of the construction in the design of the storm-surge barrier for the first time.

The caissons could be built in the construction pits at 'Damvak Geul' (decision taken in 1975).

On the basis of this proposal, the Government's provisional decision was taken in November 1974. In a next study period of about 1.5 year, the design was further studied.

Concerning the shape of the cross sections, a small and deep cross section (window) was compared with a broad and shallow cross section ('letterbox') (Fig. 14).

The 'letterbox' solution was given preference because of the better flowpattern in the gullies.

Three alternatives were further elaborated on, studied and compared.

The alternatives were; (Fig. 15 to 18)

- Caissons on sill
- Piers on caissons
- Caissons on foundation caissons

In comparing these alternatives, preference was given to the 'piers on caissons' because this solution:

- Was the cheapest with only a marginal difference in comparison with 'caissons on sill',
- Would give the best probability to stay within the estimated costs,
- Gave the best probability to be ready in 1985.

A detailed analysis of these alternatives can be found in the final report of the study period, published by the State Department of Public Works (Doc. 2a).

A few points are mentioned here:

- With the 'caissons on sill', the not very stable holocene sedimentations had to be artificially compacted to be sure of good foundation ground. On the basis of research results, this was thought to be possible. Silting problems were expected at the sill-construction, which would endanger the stability of the sill as a foundation for the caissons. These

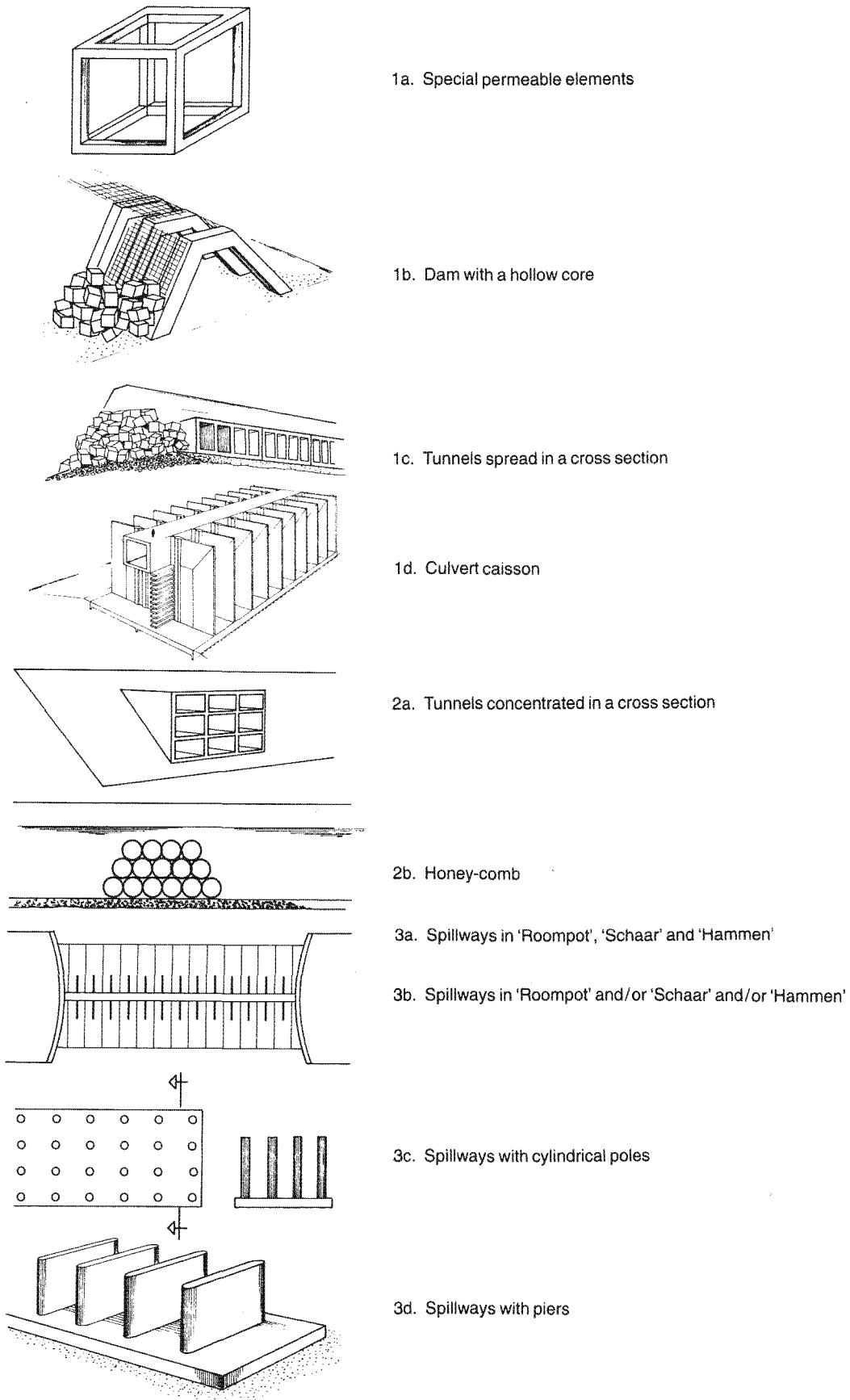
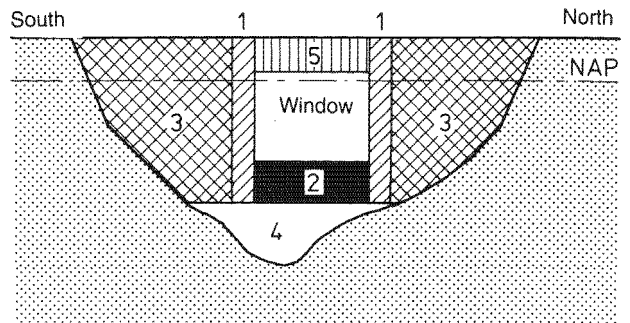
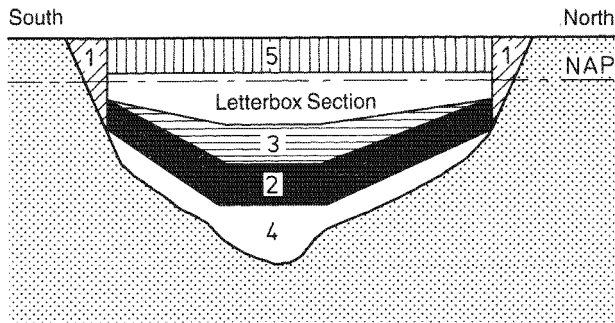

Fig. 13 Alternatives of a provisional permeable dam.



Letterbox Section, brievenbus:

1. Abutment construction
2. Barrier construction
3. Sill beams
4. Sill
5. Barrier superstructure

Window Section (spleet):

1. Transitional construction
2. Barrier construction
3. Connecting dams
4. Sill
5. Barrier superstructure

Fig. 14 Alternatives for restricting the flow sections.

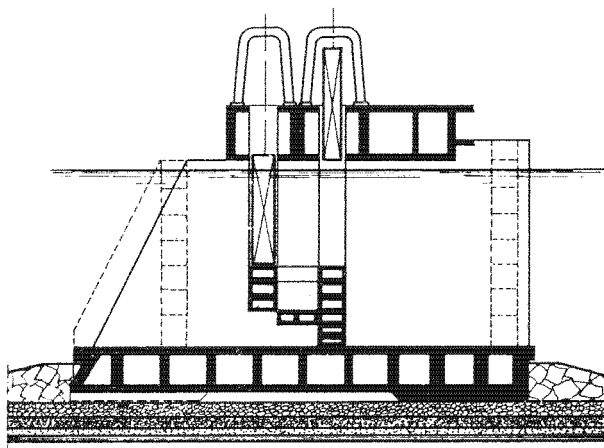

Fig. 15 Caissons on sill.

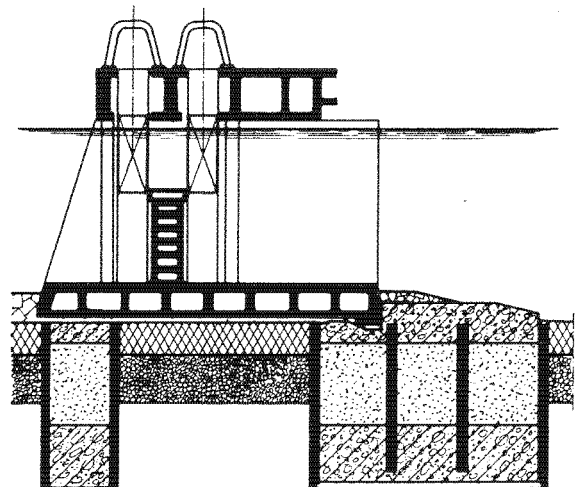

Fig. 17 Caissons on foundation caissons.

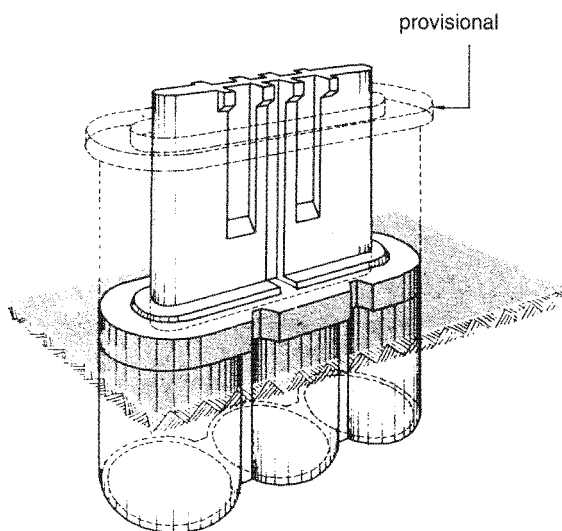

Fig. 16 Piers on caissons.

problems could lead to a considerable rise in costs and construction time.

- With the 'caisson' foundation, the bearing force is particularly taken from the deep set pleistocene sedimentations; the above mentioned foundation problems would not appear in this case. The uncertain element with the caisson foundation was that it was necessary to work for a long time in open water in open circular cofferdams at a depth of about 25 m. There was a lack of experience with this method. The problems and risks however were thought to be solveable and acceptable.
- With the 'caisson' solution, the velocities, when positioning the last caissons in the closure gaps, were critical for manoeuvring. To keep the flow velocity within acceptable limits, the initial gross opening of the caissons had to be larger than was eventually necessary for the desired tidal difference in the Oosterschelde. This would cause a rise in costs.
- With the 'pier solution', the reduction of the wet cross section in the construction phase of the pier was less radical. Con-

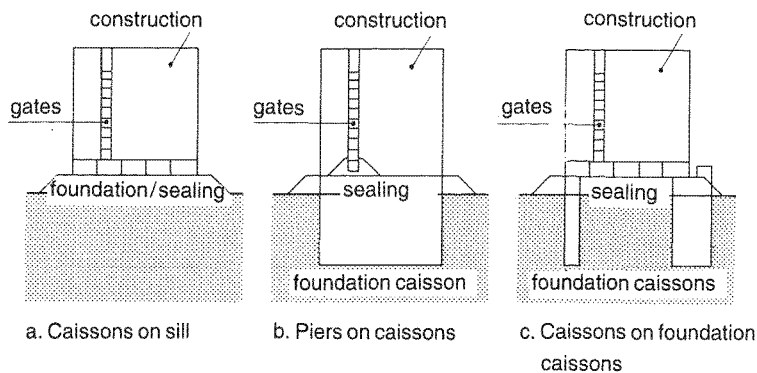

Fig. 18 Basic alternatives.

struction of the sill could be performed after this phase.

4.3 From 'piers on caissons' to 'piers on sill'

On the basis of the preliminary design for a pier-dam on caissons, the Government took the definite decision in 1976 to build the storm-surge barrier.

In this design (Fig. 19), piers were founded in pleistocene sedimentations on caissons at a depth of 30 to 40 m below mean sea level. The foundation caissons had to go through bottom-protection, which gives protection against scour. The necessary reduction of the wet cross-section was mainly achieved through piling up prefabricated sill beams, while the sill construction, which has to be built between these sill beams and the bottom, had the main function of controlling the seepage flow underneath the sill beams when the barrier is closed. The prefabricated foundation caissons with a temporal cofferdam would be placed on the bottom with a specially built lift-ship and be brought to the appropriate depth with a cutter installation (Fig. 20). In the pumped dry tub, the prefabricated pier would be connected to the caisson with help of concrete dumped at that point.

The design problems to be solved were:

- Stability of the cofferdam, pumped dry, in bad weather conditions (wave-load);
- The safety of the workers making the connection between the pier and the caisson on the bottom of the dry cofferdam (about 25 m below water level);
- The influence of bad weather conditions on the stability of the lift ship that had to stay at the pier-location for some time (several weeks), to position the caisson at the required depth;
- The problem of maintaining the proper soil density at the junction with the bed protection during intersection and lowering of the caisson.

The solutions found for these and other problems are not mentioned here.

They can be found in Project-group reports, nr 1-4, December 1976-May 1977 (Doc. 3-6).

Optimalisation studies of the foundation on caissons showed quickly enough that the foundation depth in the pleistocene not only had advantages regarding the stability of the pier-caisson combinations, but also disadvantages.

With the increasing foundation depth the tilting moment at the base becomes greater, and leads to greater horizontal move-

ments at ground level height (Fig. 21).

The tilting moments should be caught up by the unstable layers situated at a higher point.

These layers should then be compressed to increase their resistance.

On the other hand, the horizontal movements decrease as a result of shifting with an increased foundation depth (Fig. 22). It appears that with a foundation depth of 10-12 m below ground level a certain optimum exists in the resulting ground level movements. The driving capacity of the cofferdam-caisson in combination with a dry pumped cofferdam caused, depending on the depth position of the caisson, a lower limit of 11-16 m at caisson height. Subsequently, the increasing caisson width proved to have an advantageous influence on stability and ground load.

In this way, the relatively slender/deep foundation caisson evolved to become a wider/shallower founded caisson which, however, often ended up with its base in the weaker holocene deposits (Fig. 23).

To be able to offer sufficient capacity, compression of the weaker layers both below and beside the caisson was necessary.

Where compression was not possible (i.e. a too high silt-content of the sand or the presence of clay-lenses), the substrate had to be replaced, past a certain depth, by a better compressible material.

Based on the optimized design for the pier-caisson combination, the possibility of designing a monolythic construction which could combine the performance of both elements arose. Through a, now made possible, further decrease of the foundation depth, and by making use of the increased capacity of the hollow space in the base, no high demands were put on the placement vessel during installation of the prefabricated structure. A large number of the previously mentioned problems connected to the pier-caisson combination were resolved at the same time:

- The building phase loads on the monolythic pier were approx. 25% of the loads on the cofferdam-caisson combination;
- The site operations, directly connected with the pier construction, were decreased from a few months to a single day per pier installation;
- The risk of working at great depth in an open cofferdam in

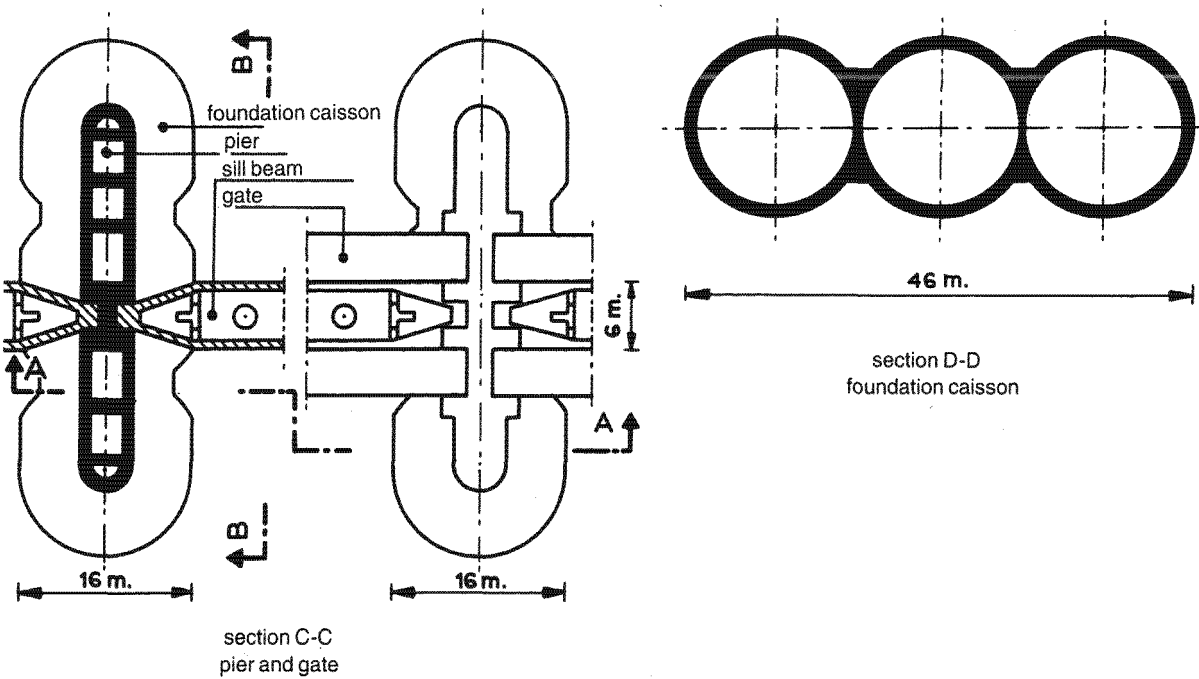
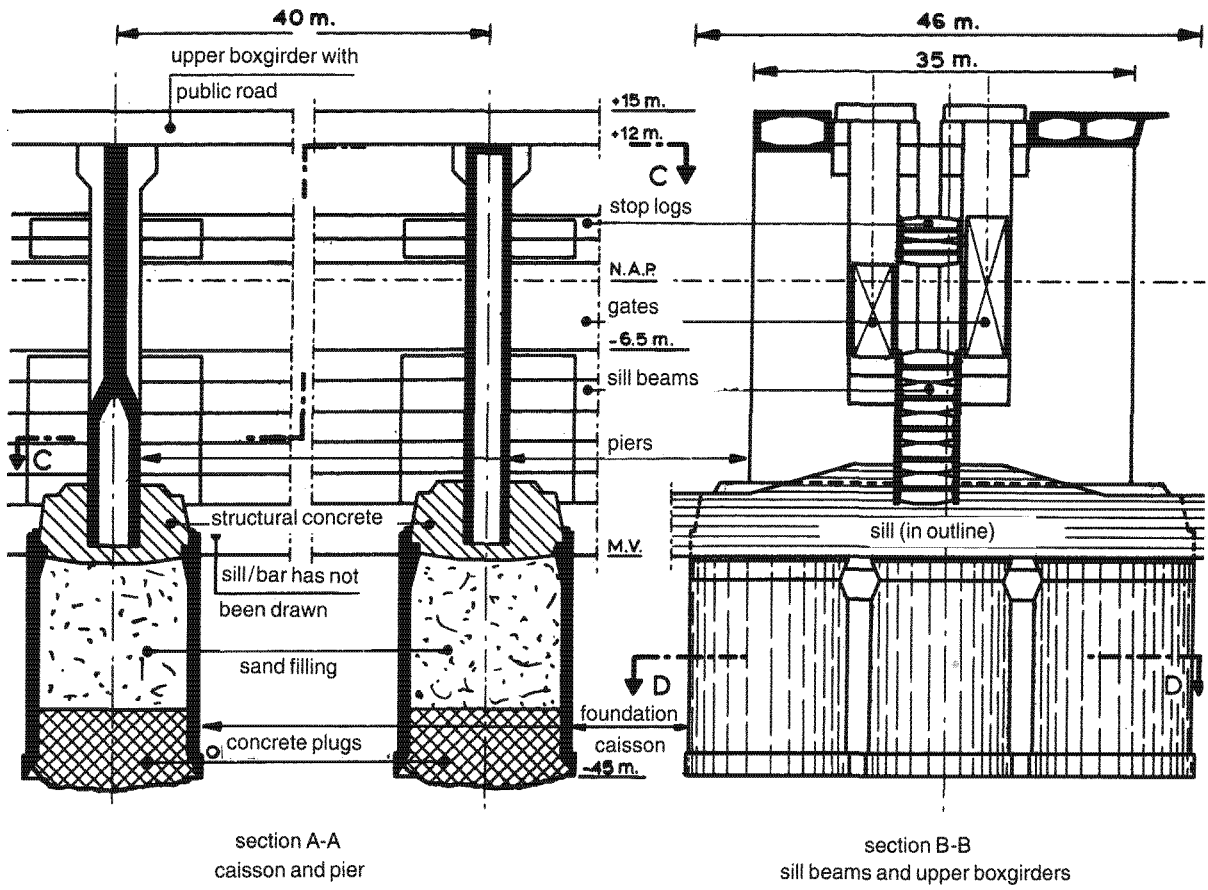

Fig. 19 Construction of piers on caissons.

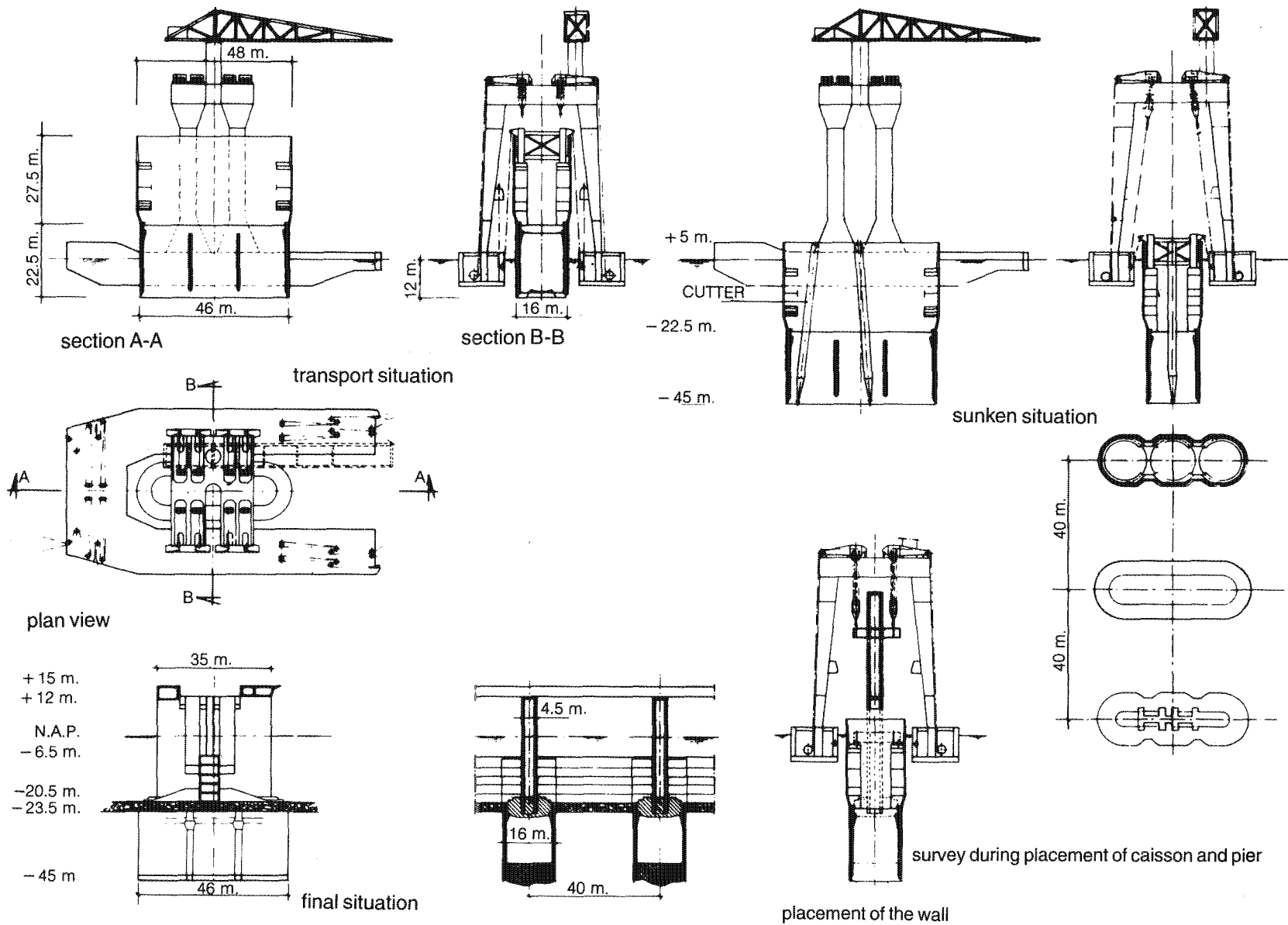

Fig. 20 Placement of caisson and pier with help of a lifting vessel.

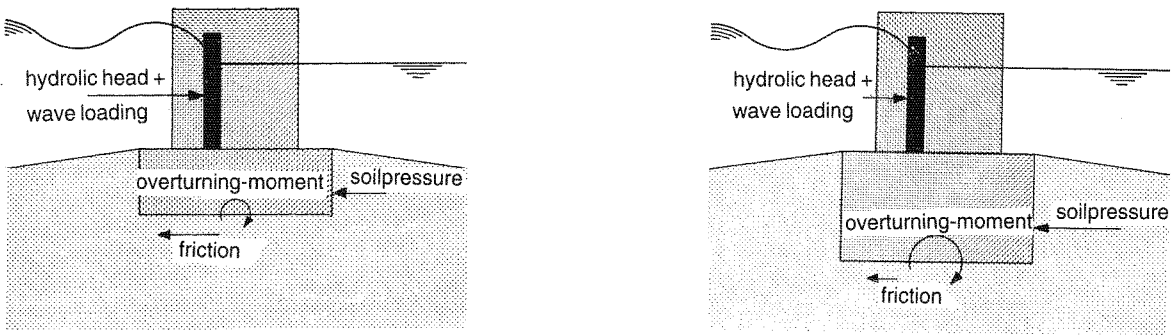

Fig. 21 Overturning-moment increases at a deeper foundation.

relatively open water disappeared.

A further enlargement of the base sheet led to an increase in the stability of the pier and to a decrease of foundation load.

A better understanding was also obtained, from laboratory and full scale tests, of the expected friction caused between the base plate and the bed. Because of this, it was possible to react to the horizontal working forces on the piers almost entirely through friction. Considering the envisaged ground improvement and the compaction of the subsoil, the foundation depth of the piers was further specified by the horizontal height of the sill beam in connection with the definite cross section, and the design of the pier base as far as the minimum depth and the possibility of raising the channel bed with sand in the deepest parts of the channel is concerned, i.e. the maximum depth.

As a result of this, the pier design was further developed in a number of stages (Fig. 24) to the present design. This development was also influenced by:

- The design of the sill and the bed compaction against erosion in the barrier alignment;
- The canceling of the allocated space for a second movable barrier, and
- The lowering of the horizontal height of the motorway from N.A.P. +18 to N.A.P. + 12 m and the combination of the construction road and motorway over the barrier on one box girder.

The pier distance is increased from 40 to 45 m centre to centre, on the basis of new insights in connection with the magnitude of the loads.

4.4 Development of the design for sill and foundation bed

In the design for 'pier-on-caissons' the necessary cross section reduction was achieved, particularly in the early stages, mainly by piling up stop logs (Fig. 19). Initially the sill was a transition construction of these stop logs down to the subsoil and its main function was to control the seepage flow underneath the barrier and thus prevent erosion. A closed barrier under storm-surge conditions causes a large hydraulic gradient.

To prevent this gradient from occurring in the subsoil, which could result in soil movement, it was decided to use a waterproof mat of stone asphalt in order to spread the gradient horizontally. This stone asphalt mat was intersected by caissons with the risk of leakage alongside the intersection

caused by the inevitable pier movements and construction tolerances (Fig. 25 top). Because of these leakage problems this idea was discarded. The sill was built with a filter construction that makes grain movement physically impossible and accepts significant gradients without serious consequences (Fig. 26).

The first layers of filters up to and including a coarse gravel layer, had to be constructed before installation, downward dredging and the construction of the piers, to prevent erosion during this process. After removal of the tub, the filter layers were covered with a sand tight 'sandwich' construction, consisting of two block-mats with a layer of gravel in between.

The aim of the 'sandwich' construction was to prevent sand, which might have been absorbed in the underlying filter layer, being washed out again and causing unfavourable settlement. To prevent continuing vertical spaces due to pier movements, the sandwich construction was extended to cover the top of the foundation caisson (Fig. 25).

At this stage of the plan, the lifting vessel for installation of the caissons and piers, was still equipped with 'legs' to ensure stability during operations.

It was necessary that these 'legs' should not penetrate the coarse gravel layer and this determined the minimum thickness of the gravel layer.

With the introduction of the design for a monolithic pier, the foundation level of the pier was significantly raised and the sill

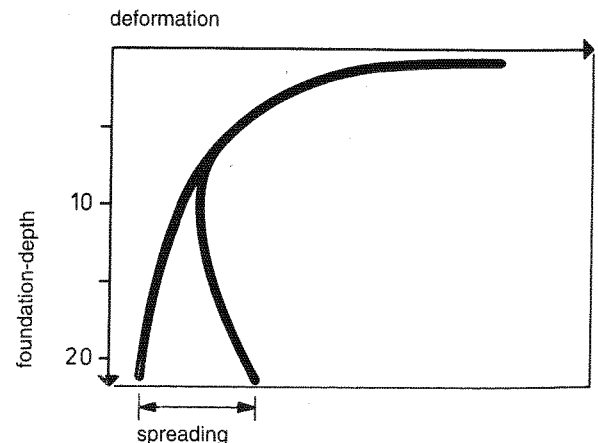

Fig. 22 Horizontal displacement as function of foundation-depth (shifting and tilting).

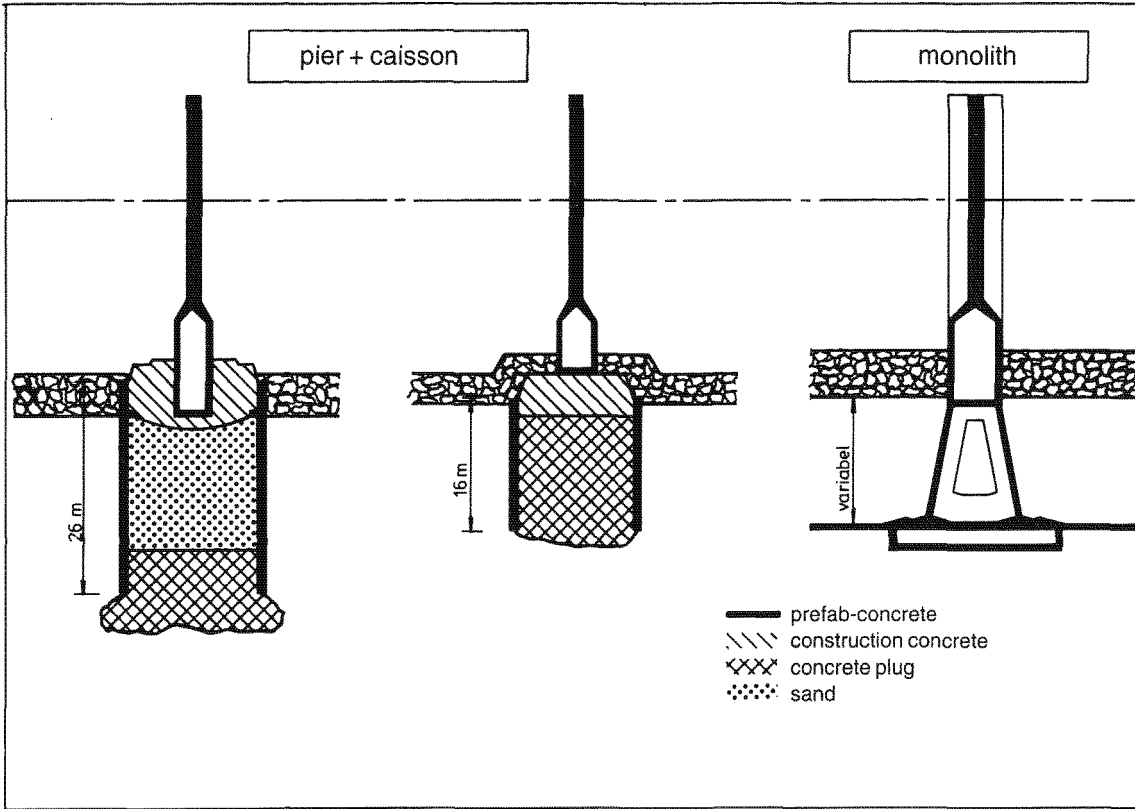

Fig. 23 Development of the foundation.

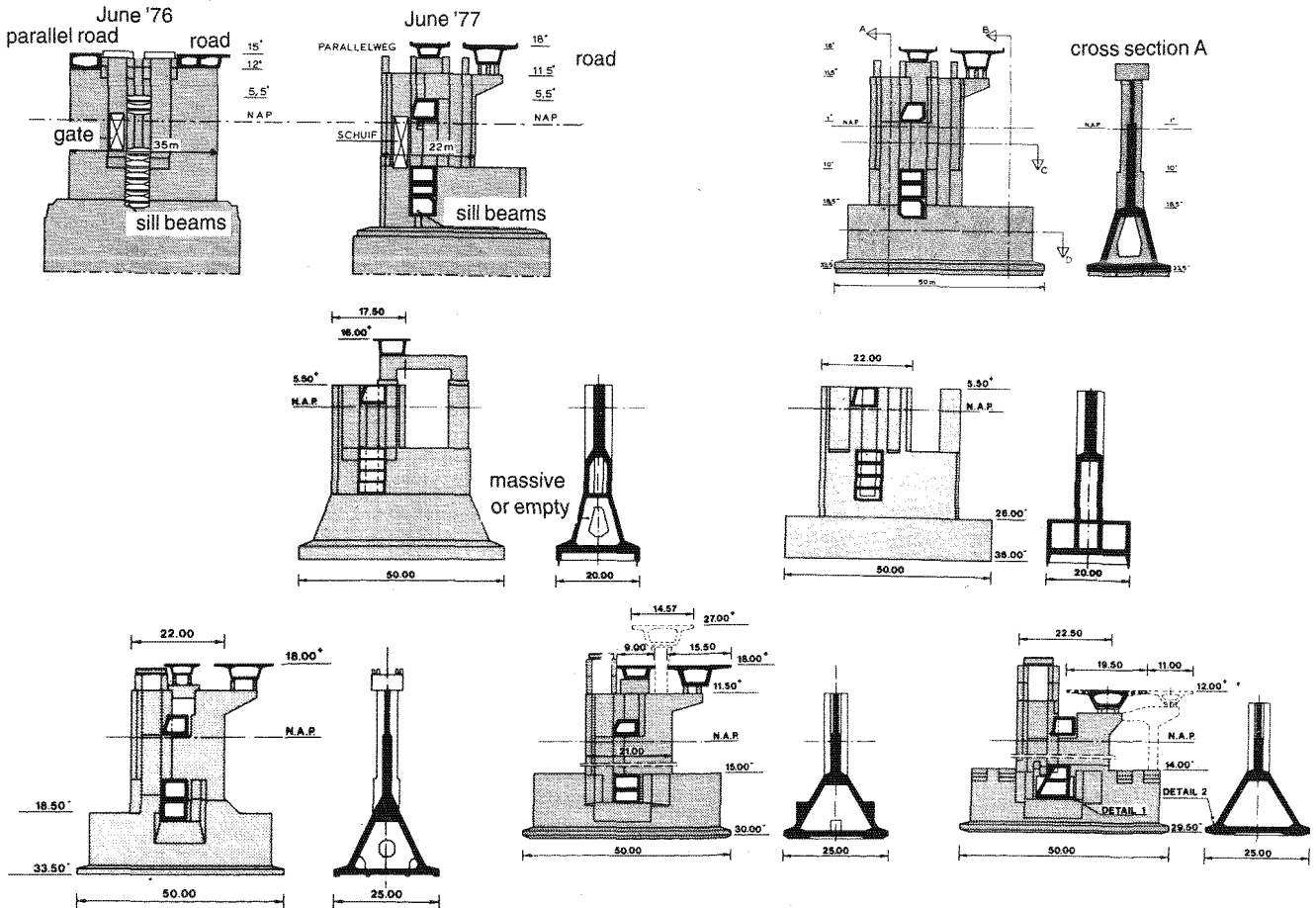

Fig. 24 Various stages of the pier design.

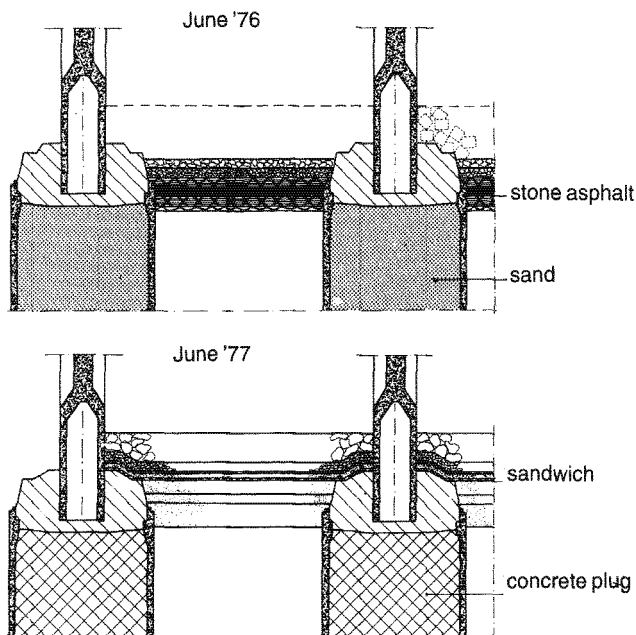

Fig. 25 Development of the sill between June 1976 and May 1977; the connection with the top of the foundation caisson.

lowered to level with the bottom of the foot. For the transitory construction to the subsoil (situated below this level) the term, 'foundation bed' was introduced for the first time.

In this stage of the plan (May 1977, Fig. 27), the foundation bed consisted of an approx. 1.5 m thick filter layer of phosphorus slag ($D_{90} = 10$ to 20 mm) to be constructed on a yet to be compressed subsoil by a similar yet to be compressed filling layer of sea gravel.

This foundation bed was covered by a filter mat, which could seal gravel to protect it against flushing out during the location of the piers.

The sill construction above this was provided between the piers with an impervious mat (as a distributor of hydrolic head), overlapping the footing, to reduce the gradient in the foundation bed as further protection against soil movements. Outside the piers, in the direction of the distributor of hydrolic head, a soil tight sandwich construction was placed. The sill profile was mainly determined by what was then considered to be the necessary embedding (8 to 12 m depending on the depth) of the pier in the sill construction, to absorb the horizontal loads on the pier. As a result of this the Oosterschelde side was much wider. Because of the greater depth of embedding, the number of beam sills necessary for the determination of the definite opening was reduced from 3 to 2. Because of all of this, the sill became more important for the cross section reduction than before.

During the following period (May 1977 – December 1978) there were a number of developments which significantly influenced the design for the foundation bed and sill:

- The installation of the pier could be carried out by using a floating ship. Thus, it was no longer necessary for the foundation bed to stand up to the loads of the legs of the installation ship and the filter layer thickness could therefore be significantly reduced.
- On review it was found that a physically impenetrable filter for the Oosterschelde-sand ($D_{50} = \text{approx. } 0.15 \text{ mm}$) would

have to consist of four layers of up to 10/60 kg of stone in the sill; these were:

- coarse sand $D_{50} = \text{approx. } 1 \text{ mm}$
- fine broken stone $D_{50} = \text{approx. } 5 \text{ mm}$
- gravel $D_{50} = \text{approx. } 20 \text{ mm}$
- rock or slag $D_{50} = \text{approx. } 80 \text{ mm}$

The two layers consisting of the finest material (dumped in bulk) caused particular flow resistance problems during construction.

Simultaneous construction of the first three layers would be desirable.

- The problem with the filter material (dumped in bulk) led to the proposal of enclosing the first three layers in a prefabricated filter mat, which would be installed by a special craft. This would mean that the sill had to be further designed as an open construction for dumped material.
- Research showed that the loads on the beam sill by the rapid flow under storm-surge conditions during a failure of one of the gates were so strong that further measures were necessary:
 - * The two beam sills were combined as one heavy beam sill with a slantwise front;
 - * The beam sill had to be partially embedded in the top layer of the sill, a measure which also favoured the discharge coefficient.

These developments resulted in a similar design for the foundation bed and sill, corresponding to the present design (Fig. 28 and 29, to be compared with Part 4, Fig. 26 and 27).

Literature

Section 4.2

- 1 Design for the storm-surge barrier in the Oosterschelde
Driemaandelijks Bericht Deltawerken nr 73, August 1975, Page 115-125
- 2 The enclosing structures of the storm-surge barrier
Driemaandelijks Bericht Deltawerken nr 73, August 1975, Page 127-135
- 3 Further developments in the design of caissons and their enclosing structures
Driemaandelijks Bericht Deltawerken nr 74, November 1975, Page 181-187
- 4 The choice of a storm-surge barrier for the Oosterschelde (a summary of the Blue Paper)
Driemaandelijks Bericht Deltawerken nr 78, November 1976, Page 441-451

Section 4.3

- 5 New developments in the design for the storm-surge barrier
Driemaandelijks Bericht Deltawerken nr 81, August 1977, Page 9-15
- 6 Progress in the design of the storm-surge barrier in the Oosterschelde
Driemaandelijks Bericht Deltawerken nr 83, February 1978, Page 142-165
- 7 Design update of the storm-surge barrier
Driemaandelijks Bericht Deltawerken nr 87, February 1979, Page 341-344
- 8 Interaction of the piers of the storm-surge barrier with sill and subsoil

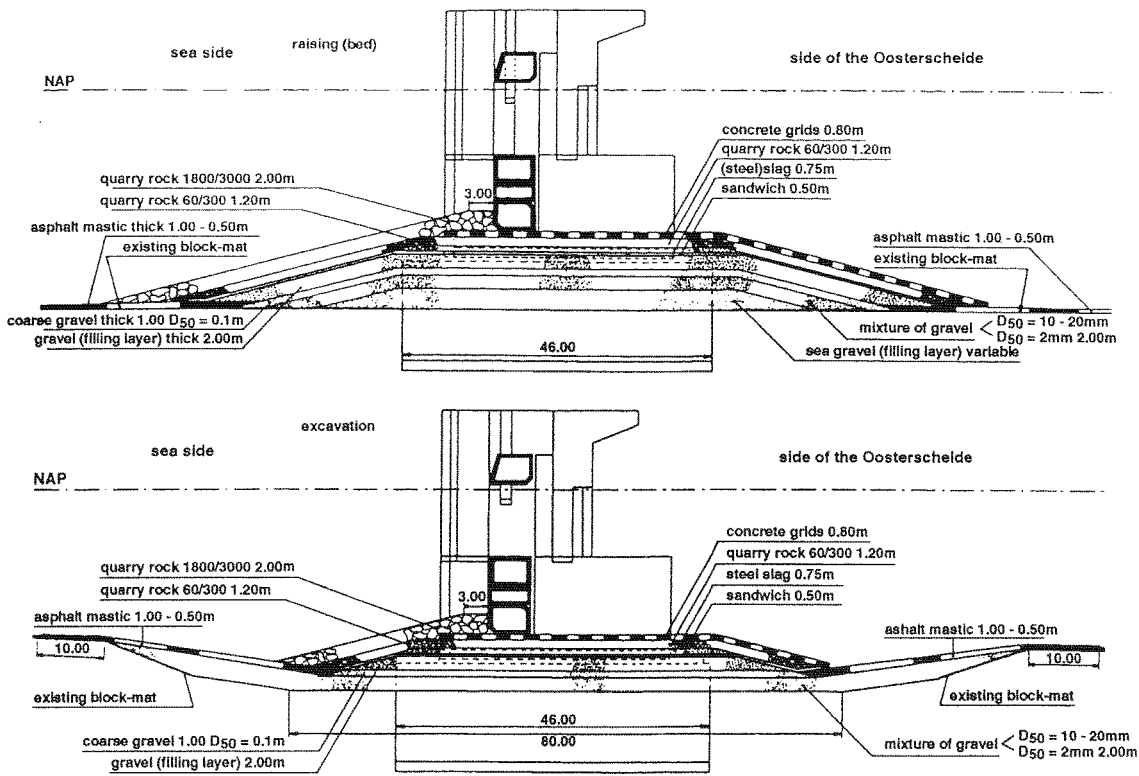

Fig. 26 Sill design with filter construction for pier-on-caisson.

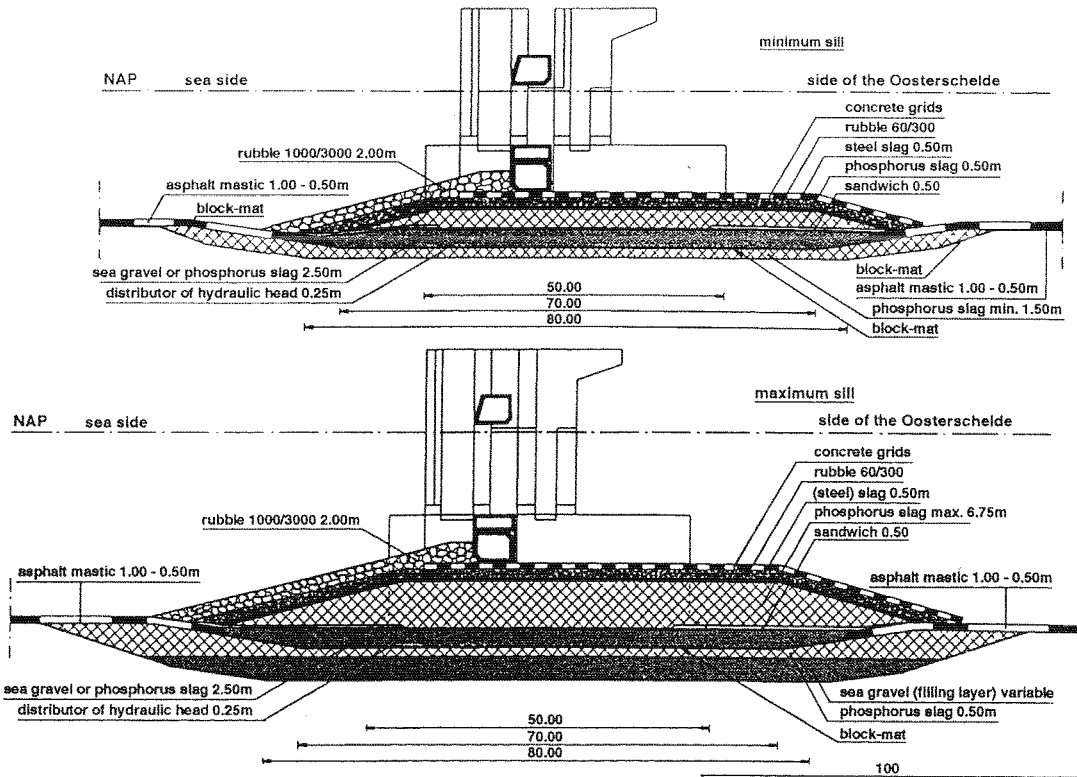

Fig. 27 Sill design with range of head for monolithic piers.

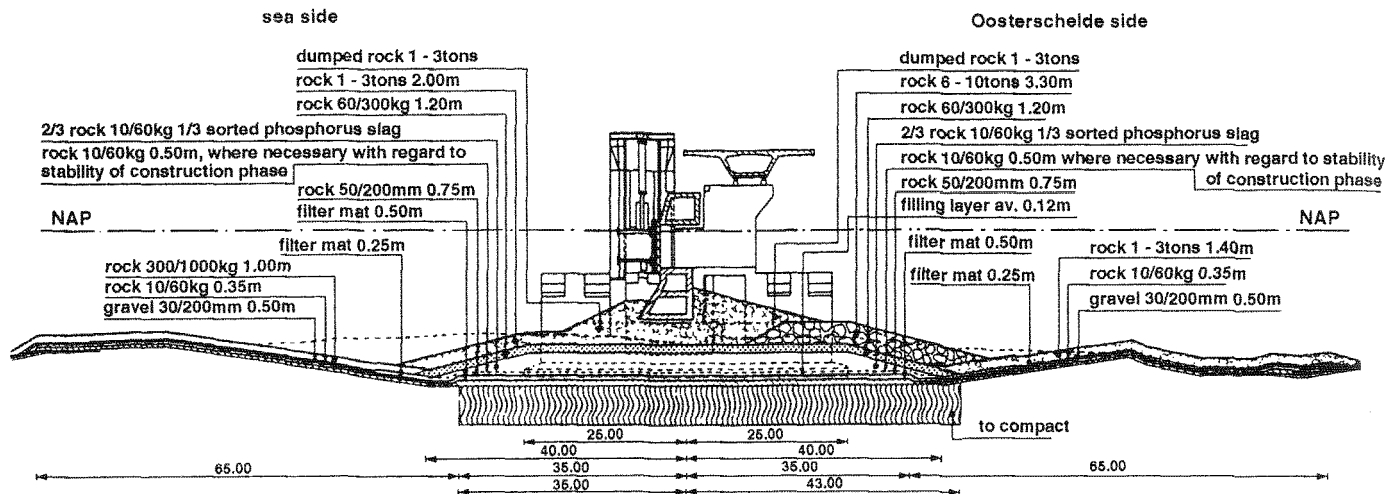

Fig. 28 Sill design with filter mats in foundation bed (excavation case).

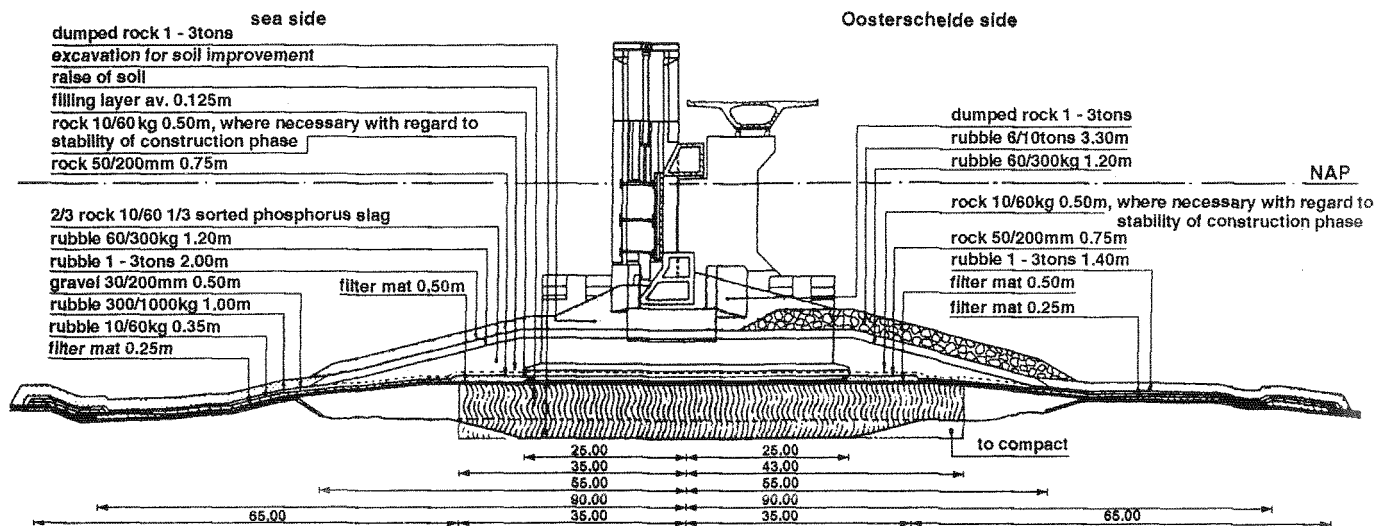

Fig. 29 Sill design with filter mats in foundation bed (raising bed and soil improvement).

Driemaandelijks Bericht Deltawerken nr 87, February 1979, Page 345-347

9 The pier design

Driemaandelijks Bericht Deltawerken nr 89, August 1979, Page 433-440

Section 4.4

10 Design and work aspects of the sill

Driemaandelijks Bericht Deltawerken nr 83, February 1978, Page 150-153

11 Further study of the sill design for the storm-surge barrier

Driemaandelijks Bericht Deltawerken 1985, August 1978, Page 261-263

12 A. Siltation at the sill construction

B. The wet cross section

C. Filter research in relation to sill design

Driemaandelijks Bericht Deltawerken nr 86, November 1978, Page 291-304

13 The foundation bed

Driemaandelijks Bericht Deltawerken nr 93, August 1980, Page 125-129

Documentation

Section 4.2

1 The porous dam in the Oosterschelde

Rapport Combinatie Dijkbouw Oosterschelde, Rijswijk, April 1974

2 A. Storm-Surge Barrier Oosterschelde, the final report Rijkswaterstaat May 1976 (so called 'Blue Paper') The Hague, May 1976

B. Sub-reports to A:

1 Aspects of environment and morphological developments (in preparation);

2 Hydraulic aspects (1984);

3 Aspects of soil mechanics (1984);

4 Caissons on sill;

5 Piers on caissons;

- 6 Caissons on foundation caissons;
- 7 Enclosing structures (1979);
- 8 Planning, budgeting and literature survey.

Section 4.3 and 4.4

Progress papers of the Storm-Surge Barrier Oosterschelde
Project group:

- 3 Paper nr 1, December 1976, PGO 137
- 4 Paper nr 2, February 1977, PGO 214, with 10 appendix in two separate parts
- 5 Paper nr 3, March 1977, PGO 247

- 6 Paper nr 4, May 1977, PGO 278, with 14 appendix (drawings) in a separate bundle
- 7 Paper nr 5, December 1977, PEGEOO-N-77122 with an appendix
- 8 Paper nr 6, May 1978, PEGEOO-N-78157
- 9 Paper nr 7, December 1978, PEGEOO-N-78293
 - Fewer layers in the organization;
 - Clearer management;
 - Shorter lines of decision-making;
 - Design and construction directly linked.
- 1 Project Storm-Surge Barrier Oosterschelde, organization

5 Organization of the project

5.1 Introduction

Pursuing the Government's decision of 17 June 1976 to construct a storm-surge barrier in the Oosterschelde and construct compartmentalization works according to model C3 with an improved canal through Zuid-Beveland, the preparation and execution of this work was delegated by the Director-General of the Public Works Department (Rijkswaterstaat) to the Delta Department (Deltadienst), in cooperation with the specialist Bridges, Lock and Weirs (Bruggen, Sluizen en Stuwen) Division, and the future managers (Division Zeeland).

The main elements of the Oosterschelde project are the following:

- The construction of the storm-surge barrier
- The construction of the compartmentalization works
- The enlargement of the canal through Zuid-Beveland
- To study the closure policy of the storm-surge barrier (project BARCON = BARrier CONTROL)

In addition there are a number of secondary points which need a coordinated approach, these include:

- Research on and around the Oosterschelde
- Construction of modification works of the existing infrastructure
- Informing the public on the entire project

To deal with these areas, project organizations and consulting groups were established under the overall management of the Oosterschelde Guidance Group (Begeleidingsgroep Oosterschelde) BGO (see Fig. 30).

The design and construction of the storm-surge barrier was the most extensive element of the Oosterschelde works and could only be realized by the joint effort of the State Department for Public Works and Water Management, private industry and research institutions.

This necessitated a comprehensive, and at times a quite com-

plex arrangement between the State Department for Public Works on the one hand, and the participating industries and research institutions on the other. The State Department and the construction company DOSBOUW directed a large number of functions (see Fig. 31).

Because of the magnitude of the project, the multi-disciplinary character of it, the vast relations with outside bodies, and the large number of activities that had to be undertaken and directed by the State Department and the four companies directly involved, it became clear that an extensive and complicated project management structure would be required. This was recognized by the Director-General of the State Department for Public Works who assigned the Deltadienst to prepare and construct the Oosterschelde works for the storm-surge barrier.

In his instructions, the Director-General expressed his preference that a strong integrated form of cooperation be developed between the companies involved and the services of the State Department.

Thereby the normal procedural policies between the companies and the State Department in multi-disciplinary projects would not be adhered to (see Appendix 1 of Doc. 1). This integrated cooperation model manifested itself in the overall organizational structure for the Oosterschelde project, which has been mentioned earlier. Its matrix structure differed from the normal procedures of the State Department (Fig. 32).

The final responsibility regarding management, supervision and coordination of the construction work lay in the hands of the BGO. The BGO consisted of the senior engineers of the participating companies, a representative of the senior management of the State Department and a management representative of the Financial and Economic Affairs branch for the Ministry of Transport and Public Works.

The final administrative contract for construction was conducted via the normal existing procedures. The companies

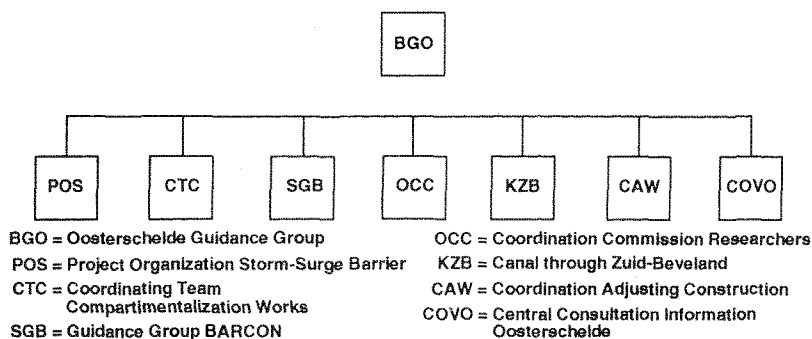

Fig. 30 Project organization under the Oosterschelde Guidance Group (BGO).

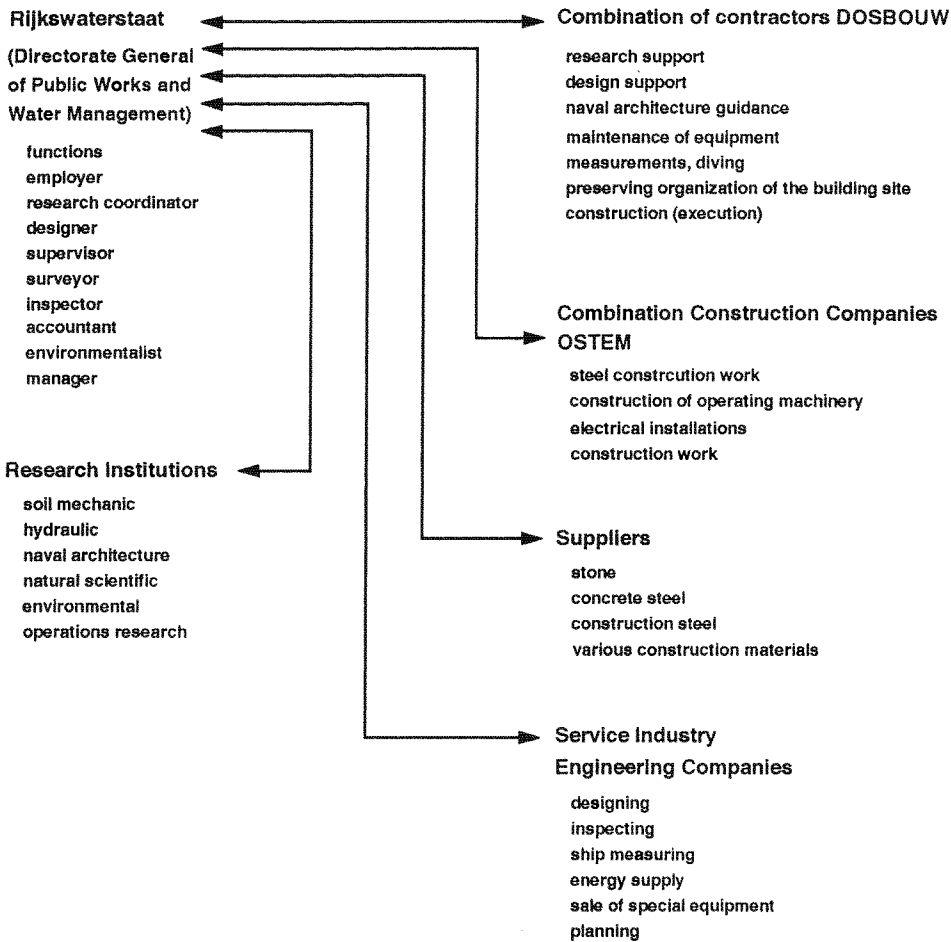

Fig. 31 Project Storm-Surge Barrier, tasks of State Department of Public Works – others.

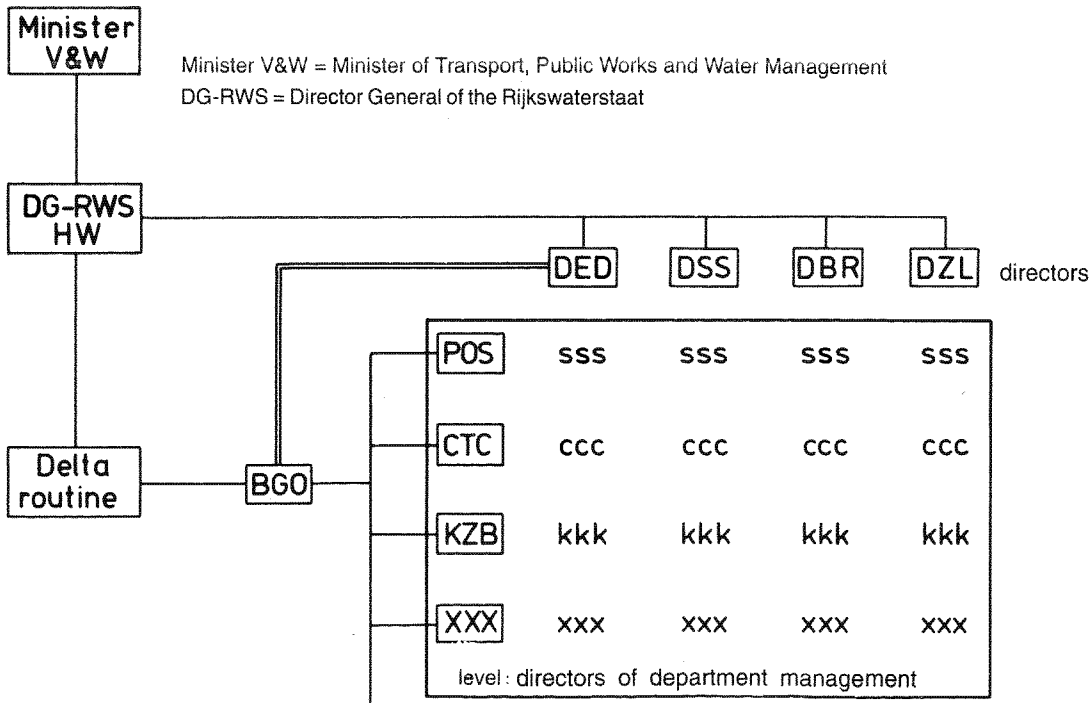

Fig. 32 Structure of the Project Organization Oosterschelde works.

involved were represented in the various project management bodies and consulting groups and integration was most successful in the project management body for the storm-surge barrier.

5.2 Project organization for the Storm-Surge Barrier at the State Department for Public Works

5.2.1 The overall structure

In general, the division of tasks for the participating companies was as follows:

Deltadienst in general

- The overall design
- The overall planning
- Cost limitation

Specific

- Earth works
- 'Wet' works
- Hydraulic and morphologic research

Locks and Weirs Division

- Concrete work in general
- 'Roompot'
- Central control building

Bridge Division

- Gates etc. (steel constructions)
- Operating mechanisms
- Electrical and control installations

Zeeland Division

- Public road over the barrier and its connection with existing infra-structure
- Issues relating to future management of the barrier
- Future allocation of the lands becoming available

The three Divisions mentioned first, acted as the 'Construction Division of the Rijkswaterstaat'.

Besides a collective responsibility for the overall project, the participating Divisions had an individual responsibility for their own input.

Project organization was designed with the aim of delegating as many tasks and as much authority as possible to the lower levels, in order to enable the higher levels to concentrate on general management, overall coordination and ethical issues. On a working level, the aim was to have groups as small as possible with specific tasks. This was particularly so for design organization (see Section 5.2.2).

This system ensured that all business affairs could be surveyed.

Although the principle form of the structure did not change, project organization varied during the construction period (Doc. 1-7).

Changes were made because of the dead-line: the proceeding stages of design and the gradual change in emphasis from design to construction. Smaller but more fundamental changes were made through evaluation of the project organization's functioning itself.

From the start of the project organization, two distinct lines developed, which were fundamentally different from each other.

The first line was aimed at design achievement: the organization of design.

Here integration of the participating companies was closest,

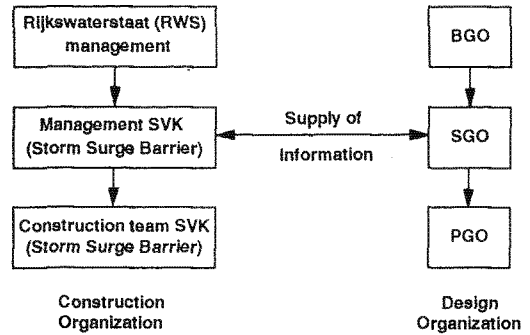

Fig. 33 Main structure of the Project organization Storm-Surge Barrier (before 1982).

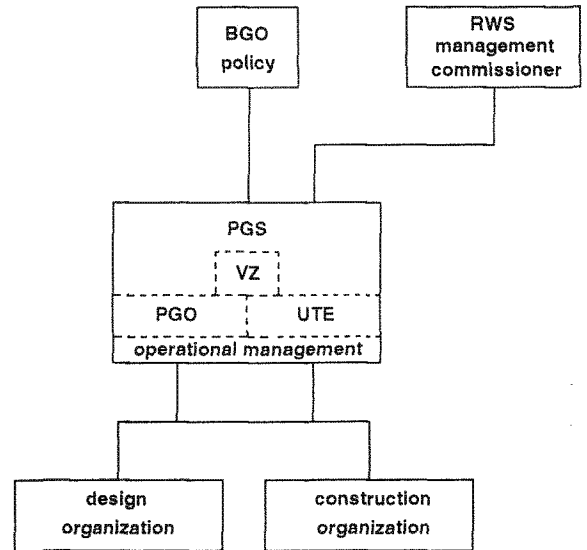

Fig. 34 Main structure of the Project Organization Storm-Surge Barrier after 1982.

creating collective responsibility for achievement of a coordinated design, the overall planning and the total cost of the project.

In brief, the design organization consisted of:

- Oosterschelde Guidance Group (BGO) – management level
- Oosterschelde Steering Group (SGO) – director's level
- Oosterschelde Project Group (PGO)

The primary task of the first two groups was to advise on policy, while the actual work was carried out by the Project group with its project department and staff groups.

The main tasks for the PGO were coordination and management.

The second line, the construction organization, was aimed at actual realization of the project: briefing the constructors and the management of construction work.

Because of the 1968 AVW law for builders rights in relation to contractors, and for administrative reasons, it was necessary to retain the individual identity of the participating companies as employers and managers. For these reasons integration was only internal.

In brief, the construction organization consisted of:

- Rijkswaterstaat (RWS) management (Deltadienst, Bridges, Locks and Weirs)
 - Management Storm-Surge Barrier (SVK)
 - Construction team SVK (UTE)
- Of these, RWS management acted as employer/commissioner.

The internal cooperation for directing future construction work was achieved by SVK at policy making level and the Construction team at management level.

Within these cooperation structures, the decision making authority of individual management representatives was limited (mutual consultation duty and agreement).

In addition to the existing line-organization of the participating companies, the Design organization and the Construction organization were joined to SGO and management SVK levels by mutual duties of consultation and information (Fig. 33). In practice, these teams often consisted of the same people.

An organizational evaluation study was conducted in 1982 (Doc. 5). As a result the target groups at the lowest policy making level of the Design and Construction organization as well as those at the highest management levels of both organizations, were combined to form a new project group, Project Group Storm-Surge Barrier (PGS). The new project group had recognizable core elements for daily management in both the design (PGO) and execution (UTE) line (Doc. 6 and 7), and came directly under BGO.

The structure of the new organization developed is indicated in Figure 34.

The most significant differences between this and the 'old' organization were:

- Fewer layers in the organization;
- Clearer management;
- Shorter lines of decision-making;
- Design and construction directly linked.

5.2.2 Further elaboration on project organization

The Design organization

Under the coordinated guidance of the PGO, both before and after the 1982 reorganization, the actual design work was delegated to a number of project branches, each of which were assigned a distinct part of the project: component projects.

At the height of the designing stage, 8 project branches were involved (see Table 6).

Regarding the component projects, project branches 1, 2, 3, 5 and 6 were more involved with the actual design of the barrier and project branches 4, 7 and 8 had a more supportive character (see Table 9). The starting point of the task assignments of the various project branches was that final responsibility for the technical implications lay, as far as possible, with one of the three construction companies.

During the design process, changes were made in the number of project branches (Tables 6-8, 9-12) and task assignments amongst them.

Towards the end of the project, 4 project branches remained (Fig. 35).

Every project branch had to coordinate their own component project from preparation to contracts, as well as fitting of the component projects into the overall project, including planning and cost aspects.

This had to be accomplished within the limits set by the PGS (formerly known as PGO) (Doc. 7).

Under responsibility of the project branch, work was further sub-divided and delegated to work groups which were technically supported by the participating companies.

At most times, the contractors' representatives (especially DOSBOUW), the advising institutions (such as the Hydraulic Laboratory and the Laboratory for Soil Mechanics) and the consultants from the engineering companies participated in the work of the Project branches and subsequent working

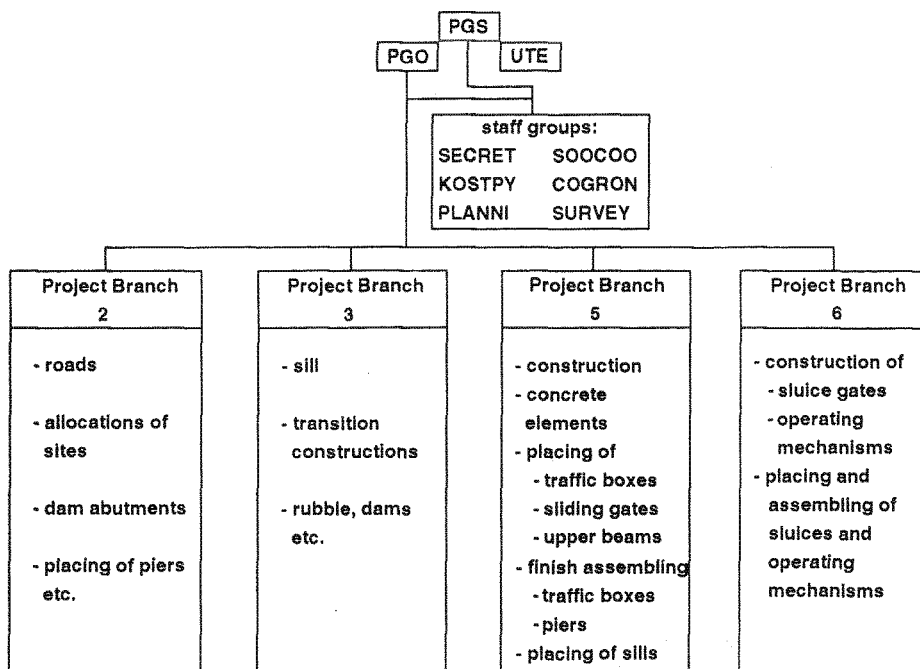

Fig. 35 Outline of operational management committed to the design (organized in 1984).

Table 6 Task description of project branches. Survey of specific tasks (organized in 1978).

Tasks		Design	Construct.	Equipment						
			methods							
Project division		Phases								
		1	2	3	4	5	6	7	8	9
Project branch I	Dam abutments	x	x	x	x	x	x	x	-	-
	Noordland complex	x	x	x	x	x	x	-	-	-
	Complex N. Jans	x	x	x	x	x	x	-	-	-
	Complex Roompot	x	x	x	x	x	x	-	-	-
	Connecting roads	x	x	x	x	x	x	-	-	-
Project branch II	Bed protection	x	x	x	x	x	x	x	-	-
	Aprons	x	x	x	x	x	x	x	-	-
	Manoeuvring plateaus	-	-	x	x	x	x	x	-	-
Project branch III	Cunette	-	-	x	-	-	-	-	-	-
	Foundation bed	x	x	-	x	x	x	x	-	-
	Sill	x	x	x	x	x	x	x	-	-
	Dumping	x	x	x	x	x	x	x	-	-
Project branch IV	Dam abutments	-	-	-	-	-	-	-	x	x
	Aprons	-	-	-	-	-	-	-	-	-
	Manoeuvring plateaus	-	-	-	-	-	-	-	x	x
	Cunette	-	-	-	-	-	-	-	x	x
	Foundation bed	-	-	-	-	-	-	-	x	x
	Sill	-	-	-	-	-	-	-	x	x
	Dumping	-	-	-	-	-	-	-	x	x
	Positioning piers	-	-	-	x	x	x	x	x	x
	Anchor stakes	x	x	x	x	x	x	-	-	-
	Sill beams	-	-	-	-	-	-	-	x	x
Project branch V	Construction of piers	x	x	x	x	x	x	-	-	-
	Sill beams	x	x	x	x	x	x	-	-	-
	Superstructure	x	x	x	x	x	x	x	x	x
Project branch VI	Gates	x	x	x	x	x	x	-	-	-
	Operational works	x	x	x	x	x	x	-	-	-
	Electricity	x	x	x	x	x	x	-	-	-
	Control building	x	x	x	x	x	x	-	-	-
	Sliding track	x	x	x	x	x	x	-	-	-
	Energy supply	x	x	x	x	x	x	-	-	-
Project branch VII	Operational works	x	x	x	x	x	x	-	-	-
	Construction pit 'Schaar'	x	x	x	x	x	x	-	-	-
	Building site 'Schaar'	x	x	x	x	x	x	-	-	-
	Support bridge	x	x	x	x	x	x	-	-	-
Project branch VIII	Harbour provisions	x	x	x	x	x	x	-	-	-
	Survey	x	x	x	x	x	x	-	-	-
	Working conditions	x	x	x	x	x	x	-	-	-
	Safety	x	x	x	x	x	x	-	-	-
	Communication	x	x	x	x	x	x	-	-	-
Corridor	x	x	x	x	x	x	-	-	-	

- 1 Study
- 2 Predesign
- 3 Def. design + specifications
- 4 Study
- 5 Development
- 6 Preparation performance
- 7 Study
- 8 Development
- 9 Preparation + construction

groups. In this way, their knowledge could be fully utilized in the development of the project. Because of staff shortages within the participating Divisions of the State Department for Public Works, it was necessary to hire extra personnel from companies such as DOSBOUW.

The Construction organization

The work was divided into a large number of component

Table 7 Task description of project branches. Survey of specific tasks (organized in 1980).

Tasks		Design	Construct.	Equipment						
			methods							
Project division		Phases								
		1	2	3	4	5	6	7	8	9
Project branch I	Dam abutments 'Schouwen'	x	x	x	x	x	x	x	-	-
	Noordland harbours	x	x	x	x	x	x	-	-	-
	Roompot	x	x	x	x	x	x	-	-	-
	Neeltje-Jans harbours	x	x	x	x	x	x	-	-	-
	Connecting roads	x	x	x	x	x	x	-	-	-
	Bank protection	x	x	x	x	x	x	x	-	-
	Project branch II	Bottom protection	x	x	x	x	x	x	x	-
Aprons		x	x	x	x	x	x	x	-	-
Dam abutments excl. Schouwen		-	-	-	x	x	x	x	-	-
Manoeuvring plateaus		-	x	x	x	x	x	x	-	-
Soil improvement		x	x	x	x	x	x	x	-	-
Compacting		x	x	x	x	x	x	-	-	-
Shortening/curtailing		x	x	x	x	x	x	-	-	-
Project branch III	Neeltje-Jans	-	-	-	-	-	-	-	-	-
	Roggen island	x	x	x	x	x	x	-	-	-
	Foundation bed	x	x	x	x	x	x	x	-	-
Project branch IV	Sill	x	x	x	x	x	x	x	-	-
	Dumping	x	x	x	x	x	x	x	-	-
	Anchor piles	x	x	x	x	x	x	x	x	x
Project branch V	Manoeuvring plateaus	x	-	-	-	-	-	-	x	x
	Soil improvement	-	-	-	-	-	-	-	x	x
	Compacting	-	-	-	-	-	-	-	x	x
	Foundation bed	-	-	-	-	-	-	-	x	x
	Sill	-	-	-	-	-	-	-	x	x
	Dumping	-	-	-	-	-	-	-	x	x
	Positioning of piers	-	-	-	x	x	x	x	x	x
	Positioning of gates	-	-	-	-	-	-	-	x	-
	Position of elements	-	-	-	-	-	-	-	x	-
	Project branch VI	Construction of piers	x	x	x	x	x	x	-	-
Construction of sill beams		x	x	x	x	x	x	-	-	-
Construction of traffic box		x	x	x	x	x	x	-	-	-
Construction of upper beams		x	x	x	x	x	x	-	-	-
Construction of sliding gates		x	x	x	x	x	x	-	-	-
Positioning of elements		-	-	-	x	x	x	-	-	x
Project branch VII	Construction of gates	x	x	x	x	x	x	-	-	-
	Operating mechanisms	x	x	x	x	x	x	-	-	-
	Electricity	x	x	x	x	x	x	-	-	-
	Energy supply	x	x	x	x	x	x	-	-	-
	Control building	x	x	x	x	x	x	-	-	-
	Sliding track	x	x	x	x	x	x	-	-	-
Project branch VIII	Positioning of gates	-	-	-	x	x	x	-	-	x
	Site allocation	x	x	x	-	-	-	-	-	-
	Site management	x	x	x	-	-	-	-	-	-
	Construction pit 'Schaar'	x	x	x	x	x	x	-	-	-
Project branch IX	Building sites	x	x	x	x	x	x	-	-	-
	Harbour allocation	x	x	x	x	x	x	-	-	-

projects which were directed by one of the Divisions of the Public Works Department (see Section 5.3).

According to the AVW Law of 1968, the representative of the directing company within the Construction Team (UTE), was to be regarded as manager by the constructor of a component project. For a number of specific activities a joint management structure was employed to achieve proper integration of the work.

This meant that within UTE, there had to be a consensus on decisions concerning management of the component projects and that the liaison-personnel of the companies, other than the directing one, could be designated as additional managers. In relation to the rest of the work, it held a coordinating duty.

For each component project, a project leader and at times a supervisor were appointed to the management team. These project leaders were accountable to the UTE.

Table 8 Task description of project branches. Survey of specific tasks (organized in 1982).

Tasks	Design	Construct. Equipment methods								
		Phases								
Project division		1	2	3	4	5	6	7	8	9
Project branch II	Construction pit 'Schaar'	x	x	x	x	x	x	-	-	-
	Noordland harbours	x	x	x	x	x	x	-	-	-
	Roompot	x	x	x	x	x	x	-	-	-
	Definite roads	x	x	x	x	x	x	-	-	-
	Site allocation	x	x	x	x	x	x	-	-	-
	Sand balance	x	x	x	x	x	x	-	-	-
	Bed protection	x	x	x	x	x	x	x	-	-
	Aprons	x	x	x	x	x	x	x	-	-
	Dam abutments, sub-structure of abutments	x	x	x	x	x	x	x	-	-
	Manoeuvring plateaus	-	x	x	x	x	x	x	-	-
	Soil improvement	x	x	x	x	x	x	x	-	-
	Compaction	x	x	x	x	x	x	x	-	-
	Roggen island	x	x	x	x	x	x	x	-	-
Bank protection	x	x	x	x	x	x	x	-	-	
Project branch III	Foundation bed	x	x	x	x	x	x	x	-	-
	Sill	x	x	x	x	x	x	x	-	-
	Dumping rock	x	x	x	x	x	x	x	-	-
	Levelling	x	x	x	x	x	x	x	-	-
Project branch IV	Anchor piles	x	x	x	x	x	x	x	x	x
	Manoeuvring plateaus	-	-	-	-	-	-	-	x	x
	Soil improvement	-	-	-	-	-	-	-	x	x
	Compaction	-	-	-	-	-	-	-	x	x
	Foundation bed	-	-	-	-	-	-	-	x	x
	Sill	-	-	-	-	-	-	-	x	x
	Dumping	-	-	-	-	-	-	-	x	x
	Positioning of piers	-	-	-	x	x	x	x	x	x
	Position of gates	-	-	-	-	-	-	-	x	-
	Positioning of elements	-	-	-	-	-	-	-	x	-
Levelling	-	-	-	-	-	-	-	x	x	
Project branch V	Construction of piers	x	x	x	x	x	x	-	-	-
	Construction of sill beams	x	x	x	x	x	x	-	-	-
	Construction of traffic boxes	x	x	x	x	x	x	-	-	-
	Construction of upper beams	x	x	x	x	x	x	-	-	-
	Construction of sliding gates	x	x	x	x	x	x	-	-	-
	Position of elements	-	-	-	-	-	-	-	x	x
	Superstructure abutments	x	x	x	x	x	x	x	-	-
Project branch VI	Construction of gates	x	x	x	x	x	x	-	-	-
	Operating mechanisms	x	x	x	x	x	x	-	-	-
	Electricity	x	x	x	x	x	x	-	-	-
	Electricity supply	x	x	x	x	x	x	-	-	-
	Control building	x	x	x	x	x	x	-	-	-
	Sliding track	x	x	x	x	x	x	-	-	-
	Positioning of gates	-	-	-	x	x	x	-	x	x

For each component project, the project branch concerned included a design expert in construction organization to ensure proper linkage of design and construction. This design expert's responsibility was to interpret correctly the design data during construction.

Staff groups

To support the project organization itself, a number of staff groups were established to deal with issues relating to the overall project (both design and construction).

Besides providing direct support for senior management of the project organization (PGS, PGO, UTE), these staff groups also supported project branches and project leaders.

In a number of cases these staff groups guided the work groups on particular side issues. The main staff groups were:

- The secretariat (SECRET): general secretarial work, particularly on behalf of PGS, PGO and UTE, providing general information and internal communication.

Table 9 Project branches. Survey of task divisions per component project (organized in 1978).

Tasks	Design	Construct. Equipment methods								
		Phases								
Project division		1	2	3	4	5	6	7	8	9
<i>Approximate Dam abutments</i>										
Dam abutments		1	1	1	1	1	1	1	4	4
Noordland complex		1	1	1	1	1	1	-	-	-
Neeltje-Jans complex		1	1	1	1	1	1	-	-	-
Roggenplaat complex		1	1	1	1	1	1	-	-	-
Connecting roads		1	1	1	1	1	1	-	-	-
<i>Bed provisions</i>										
Bed protection		2	2	2	2	2	2	-	-	-
Aprons		2	2	2	2	2	2	-	-	-
Bank protection		2	2	2	2	2	2	-	-	-
Manoeuvring plateaus		2	2	2	2	2	2	2	4	4
Cunette		3	3	2	3	3	3	3	4	4
<i>Sill</i>										
Foundation bed		3	3	3	3	3	3	3	4	4
Sill		3	3	3	3	3	3	3	4	4
Dumpings		3	3	3	3	3	3	3	4	4
<i>Concrete</i>										
Construction of piers		5	5	5	5	5	5	-	-	-
Positioning of piers		-	-	-	4	4	4	4	4	4
Sill beams		5	5	5	5	5	5	4	4	4
Superstructure		5	5	5	5	5	5	5	5	5
<i>Means of enclosure</i>										
Gates		6	6	6	6	6	6	-	-	-
Operating mechanisms		6	6	6	6	6	6	-	-	-
Electricity		6	6	6	6	6	6	-	-	-
Energy supply		6	6	6	6	6	6	-	-	-
Control building		6	6	6	6	6	6	-	-	-
Sliding track		6	6	6	6	6	6	-	-	-
<i>Supporting works</i>										
Schaar construction pit		7	7	7	7	7	7	-	-	-
Schaar building site		7	7	7	7	7	7	-	-	-
Construction energy		7	7	7	7	7	7	-	-	-
Anchor piles		4	4	4	4	4	4	-	-	-
Supporting bridge		7	7	7	7	7	7	-	-	-
Harbour provisions		7	7	7	7	7	7	-	-	-
Construction support		8	8	8	8	8	8	-	-	-

- Cost price (KOSTPY): cost of overviews, cost of price analysis, cost estimates.
- Planning and risk analysis (PLANNI): complete project planning and coordination; progress controls; risk analysis in relation to time and costs and providing alternatives when necessary.
- Research coordination (SOOCOO): analyzing research proposals from the design and construction organizations, systematic organization of research approach and managing research budget, research on and assessment of relevant conditions in terms of construction loadings (in both construction phase and final phase) and equipment; developing a hydrometeo-information system for construction, analysis and advice on accident prevention.
- Coordination preparation maintenance (COGRON): maintenance scenarios; costs, equipment and materials necessary for maintenance.
- Measuring systems (SURVEY): development and/or purchase of measuring equipment; determination of construction capacity; analysis of measurements; providing positioning information; development of a storing system for measurement data; instruction; maintenance of measuring equipment.
- Aesthetics, allocation of landscape (STOVIL): to advise on

Table 10 Project branches. Survey of task divisions per component project (organized in 1980).

Tasks	Design			Construct. methods			Equipment		
	1	2	3	4	5	6	7	8	9
Project division	Phases								
<i>Dam abutments</i>									
Schouwen dam abutment	1	1	1	1	1	1	1	1	1
Construction of Noordland harbours	1	1	1	1	1	1	-	-	-
Roompot gate	1	1	1	1	1	1	-	-	-
Construction of Neeltje-Jans harbours	1	1	1	1	1	1	-	-	-
Shortening of Neeltje-Jans harbours	2	2	2	2	2	2	-	-	-
Roggenplaat	2	2	2	2	2	2	-	-	-
Connecting roads	1	1	1	1	1	1	-	-	-
Dam abutments excl. Schouwen	1	1	1	1	1	1	2	-	-
<i>Bed provisions</i>									
Bed protection	2	2	2	2	2	2	2	-	-
Aprons	2	2	2	2	2	2	2	-	-
Bank protection	2	2	2	2	2	2	2	-	-
Manoeuvring plateaus	4	2	2	2	2	2	2	4	4
Soil improvement	2	2	2	2	2	2	2	4	4
Compaction	2	2	2	2	2	2	4	4	4
<i>Sill</i>									
Foundation bed	3	3	3	3	3	3	3	4	4
Sill	3	3	3	3	3	3	3	4	4
Dumpings	3	3	3	3	3	3	3	4	4
<i>Concrete</i>									
Construction of piers	5	5	5	5	5	5	-	-	-
Positioning of piers	-	-	-	4	4	4	4	4	4
Construction of sill beams	5	5	5	5	5	5	-	-	-
Construction of traffic boxes	5	5	5	5	5	5	-	-	-
Construction of upper beams	5	5	5	5	5	5	-	-	-
Construction of sliding gates	5	5	5	5	5	5	-	-	-
Positioning of elements	-	-	-	5	5	5	4	5	5
<i>Means of enclosure</i>									
Construction of gates	6	6	6	6	6	6	-	-	-
Positioning of gates	-	-	-	6	6	6	4	6	6
Operating mechanisms	6	6	6	6	6	6	-	-	-
Electricity	6	6	6	6	6	6	-	-	-
Energy supply	6	6	6	6	6	6	-	-	-
Control building	6	6	6	6	6	6	-	-	-
Sliding track	6	6	6	6	6	6	-	-	-
<i>Supporting works</i>									
Schaar building pit	7	7	7	7	7	7	-	-	-
Building sites	7	7	7	7	7	7	-	-	-
Anchor piles	4	4	4	4	4	4	4	4	4
Harbour allocation	7	7	7	7	7	7	-	-	-

Table 11 Project branches. Survey of task divisions per component project (organized in 1981).

Tasks	Design			Construct. methods			Equipment		
	1	2	3	4	5	6	7	8	9
Project division	Phases								
<i>Dam abutments</i>									
Noordland harbours	2	2	2	2	2	2	-	-	-
Roompot	2	2	2	2	2	2	-	-	-
Shortening of Neeltje-Jans	2	2	2	2	2	2	-	-	-
Roggenplaat island	2	2	2	2	2	2	-	-	-
Definite roads	2	2	2	2	2	2	-	-	-
Dam abutments	2	2	2	2	2	2	2	-	-
<i>Bed provisions</i>									
Bed protection	2	2	2	2	2	2	2	-	-
Aprons	2	2	2	2	2	2	2	-	-
Bank protection	2	2	2	2	2	2	2	-	-
Manoeuvring plateaus	4	2	2	2	2	2	2	4	4
Soil improvement	2	2	2	2	2	2	2	4	4
Compaction	2	2	2	2	2	2	4	4	4
<i>Sill</i>									
Foundation bed	3	3	3	3	3	3	3	4	4
Levelling	3	3	3	3	3	3	3	4	4
Sill	3	3	3	3	3	3	3	4	4
Dumpings	3	3	3	3	3	3	3	4	4
<i>Concrete</i>									
Construction of piers	5	5	5	5	5	5	-	-	-
Positioning of piers	-	-	-	4	4	4	4	4	4
Construction of beam sills	5	5	5	5	5	5	-	-	-
Construction of traffic boxes	5	5	5	5	5	5	-	-	-
Construction of upper beams	5	5	5	5	5	5	-	-	-
Construction of sliding gates	5	5	5	5	5	5	-	-	-
Positioning of elements	-	-	-	5	5	5	4	5	5
<i>Means of enclosure</i>									
Construction of gates	6	6	6	6	6	6	-	-	-
Positioning of gates	-	-	-	6	6	6	4	6	6
Operating mechanisms	6	6	6	6	6	6	-	-	-
Electricity	6	6	6	6	6	6	-	-	-
Energy supply	6	6	6	6	6	6	-	-	-
Control building	6	6	6	6	6	6	-	-	-
Sliding track	6	6	6	6	6	6	-	-	-
<i>Supporting works</i>									
Schaar construction pit	2	2	2	2	2	2	-	-	-
Allocation of site	2	2	2	2	2	2	-	-	-
Anchor piles	4	4	4	4	4	4	4	4	4
Sand balance	2	2	2	2	2	2	-	-	-

aesthetic aspects, lay-out and integration of the various visible parts of the storm-surge barrier and its structures.

- Construction philosophy (UF): to give advice on the major organizational, planning, design and construction problems.

An advisory group of the chairperson of the PGS and not, in the usual sense, a staff group.

The other staff groups which came into existence are referred to in documents 1-4 and 6.

Just as within the project branches, the staff and among them the outside working groups also included representatives of the contractor DOSBOUW, or outside advisors and, on a personal basis, hired experts.

5.3 Contractual aspects

The extensive and at times complicated arrangements between the State Department and the companies and institutions involved in the storm-surge barrier project, has already been referred to (see Fig. 31). This arrangement was worked

out through contractual agreements between the State and the various companies and institutions. According to the character and contents of these agreements, one of the three Rijkswaterstaat Divisions (DD, Br, or S&S) acted as representative for the State. It is not possible at this time to go into these agreements in detail. In general, however, they were not very different from the usual contracts formed by the State Department for Public Works.

There were:

- Contracts with laboratories and research institutions on research for design, construction and management of the storm-surge barrier;
- Contracts with institutions and engineering companies for supportive and service rendering work;
- Contracts for the delivery of construction materials such as stone and construction steel.

More attention should be given to the relationship with the two main contractors 'DOSBOUW' and 'OSTEM'. Both acted as main contractors for both wet- and concrete-works on the one hand, and enclosure methods, operational mechanisms and electrical installations on the other. The relationship with these

Table 12 Task description of project branches (organized in 1982).

Tasks	Design			Construct. methods			Equipment		
	1	2	3	4	5	6	7	8	9
Project division	Phases								
<i>Dam abutments</i>									
Noordland harbours	2	2	2	2	2	2	-	-	-
Roompot	2	2	2	2	2	2	-	-	-
Shortening of Neeltje-Jans	2	2	2	2	2	2	-	-	-
Roggenplaat island	2	2	2	2	2	2	-	-	-
Definite roads	2	2	2	2	2	2	-	-	-
Dam abutments	2	2	2	2	2	2	2	-	-
<i>Bed provisions</i>									
Bed protection	2	2	2	2	2	2	2	-	-
Aprons	2	2	2	2	2	2	2	-	-
Bank protection	2	2	2	2	2	2	2	-	-
Manoeuvring plateaus	4	2	2	2	2	2	-	-	-
Soil improvement	2	2	2	2	2	2	2	-	-
Compaction	2	2	2	2	2	2	4	4	4
<i>Sill</i>									
Foundation bed	3	3	3	3	3	3	3	4	4
Levelling	3	3	3	3	3	3	3	4	4
Sill	3	3	3	3	3	3	3	3	3
Dumpings	3	3	3	3	3	3	3	3	3
<i>Concrete</i>									
Construction of piers	5	5	5	5	5	5	-	-	-
Positioning of piers	-	-	-	4	2	2	4	4	4
Construction of beam sills	5	5	5	5	5	5	-	-	-
Construction of traffic boxes	5	5	5	5	5	5	-	-	-
Construction of upper beams	5	5	5	5	5	5	-	-	-
Construction of sliding gates	5	5	5	5	5	5	-	-	-
Position of elements	-	-	-	5	5	5	4	5	5
<i>Means of enclosure</i>									
Construction of sluices	6	6	6	6	6	6	-	-	-
Positioning of sluices	-	-	-	6	6	6	4	6	6
Operating mechanisms	6	6	6	6	6	6	-	-	-
Electricity	6	6	6	6	6	6	-	-	-
Energy supply	6	6	6	6	6	6	-	-	-
Control building	6	6	6	6	6	6	-	-	-
Sliding track	6	6	6	6	6	6	-	-	-
<i>Supporting works</i>									
Schaar construction pit	2	2	2	2	2	2	-	-	-
Allocation of sites	2	2	2	2	2	2	-	-	-
Anchor piles	4	4	4	4	4	4	4	4	4
Sand balance	2	2	2	2	2	2	-	-	-

two main contractors was agreed to in principle in two so-called frame contracts, namely DED-1750 (Doc. 8) and Br/8795 (Doc. 9). Before examining these frame contracts and their resulting relations in greater depth, a short history of the past is required.

In 1973 in Rijswijk, the Dutch State and the contractor Dijkbouw Oosterschelde (List 1) finalized a frame contract (DED-1452) concerning the construction which would complete the enclosure dam in the mouth of the Oosterschelde. The construction, carried out under the terms of this frame contract, had already commenced, when in 1974 the decision was taken to reconsider closure of the Oosterschelde and, as a result thereof, construction as described in the contract was stopped.

In 1975 the Dutch State finalized a contract (DED-1606) with Combinatie Dijkbouw Oosterschelde, Ballast-Nedam Group B.V. and the Bos-Kalis Westminster Group N.V. concerning supportive feasibility-studies for the realisation of a storm-surge barrier. In this contract it was stated (art. 5, lid 1) that if the project proceeded, part of the construction work, which

was not included in the contract (DED-1452) with Combinatie Dijkbouw Oosterschelde, would be given to a combination of contractors:

- Ballast-Nedam Group B.V.
- Bos-Kalis Westminster Group N.V.
- Hollandse Beton Group N.V.
- Koninklijke Adriaan Volker Group N.V.
- Stevin Group N.V.

These contractors and Dijkbouw Oosterschelde established the main contractor combination 'DOSBOUW v.o.f.'.

To meet the specifications stated in the contract DED-1606 and to replace the frame contract DED-1452, which was still in force, the earlier mentioned frame contract DED-1750 was finalized with the main contractor 'DOSBOUW v.o.f.'. The companies mentioned in List 2 were the participants in this partnership. The full or partial subsidiary companies of these companies were to be participants in this partnership. Therefore these subsidiary companies could not claim the status of sub-contractors (see also Doc.8 and the AVW Law 1968).

The following considerations led to the finalization of the frame contract:

- There was not as yet a fully worked out design.
- It was expected that new construction and work methods and special equipment had to be developed for construction of the final design. For this, the contractor's knowledge and experience were necessary and on the other hand the contractor was also responsible for same.
- Considering the tight deadline for the whole project, parts of the construction could and had to be made without a completed total design. It became obvious that sub-contracts had to be issued.
- Considering the lack of competition and the special character of the work that had to be done, it was necessary to agree

List 1

Participants in Dijkbouw Oosterschelde in Rijswijk were: Aannemers Combinatie Zinkwerken B.V. in Gorinchem; Baggermaatschappij Breejnhout B.V. in Iverveen; Van Hattum and Blankevoort Baggeren B.V. in Beverwijk; Hollandsche Aanneming Maatschappij B.V. in Rijswijk; B.V. Aannemings- and Wegenbouwbedrijf P.H. Offringa in 't Harde; Aannemingsmaatschappij van Oord-Utrecht N.V. in Odijk; Adriaan Volker Baggermaatschappij B.V. in Rotterdam.

List 2

Participants of the partnership under company BOSBOUW in Burghsluis, District of Westenschouwen were:

- 1 Ballast-Nedam Group N.V. in Amstelveen;
- 2 Bos-Kalis Westminster Group N.V. in Papendrecht;
- 3 Baggermaatschappij Breejnhout B.V. in Overveen;
- 4a Hollandsche Aanneming Maatschappij B.V. in Rijswijk;
- 4b Hollandsche Beton Maatschappij in Rijswijk;
- 5 van Oord-Utrecht N.V. in Odijk;
- 6a Stevin Baggeren B.V. in Beverwijk
- 6b Stevin Beton en Waterbouw B.V. in Beverwijk;
- 7a Adriaan Volker Bagger Maatschappij b.v. in Rotterdam;
- 7b Adriaan Volker Beton en Waterbouw B.V. in Rotterdam;
- 8 Aannemers Combinatie Zinkwerken B.V. in Gorinchem.

on rules and procedures and to determine an acceptable payment for the sub-contracts of the frame contract, which would satisfy both parties involved.

These considerations were all included in the frame contract, as well as:

- The range of the contract (for instance the means for enclosure, and the Roompot were not included);
- The mutual rights to constructions and unusual materials which would be totally or partially written off during work to be made available to the State, as well as the mutual concern given to techniques and specially developed equipment thereof;
- The choice of possible sub-contractors.

Under this frame contract, both Deltadienst and Locks and Weirs Division could, on behalf of the Dutch State, act as employers for sub-contracts.

For the construction of the enclosure works, Bridge Division, on behalf of the Dutch State, preferred to deal with one main contractor.

The main reason for this was the fact that construction of this part of the work would involve a large number of specialized companies who would have to work closely together. In particular, they would have to work together with the contractor in charge of concrete constructions on the building-site (see also Section 5.4).

The main contractor could take over an important part of the coordination from the employer, the mutual relationship between the companies would become clearer and the number of independent parties on the building-site would be limited.

To do justice to the coordinating role of the main contractor it was important to involve him in the work from an early stage. This could be done by recording such a relationship with the main contractor in a frame contract, which meant that it was not necessary to set out all the minute details of design before commencing work and that not all companies participating in the construction work had to be named.

In addition to the business of the main contractor other matters were set out in the frame contract, such as:

- Procedures to choose companies who would participate in construction or sub-contracting.
- Procedures for the finalization of the sub-contracts formed within the frame contract and the accompanying payment arrangements thereof (see Doc. 9).

The choice of main contractor was made on the basis of existing relationships with the industry. As it happened, there was already an arrangement, dating back to the nineteen-thirties, between Bridge Division and a group of construction sites for dividing up, according to a particular distributive code, heavy steel construction orders (mainly steel bridges) for factory work and under agreed fixed payment arrangements (the so called 'cost price') between the participants of this group. The composition of the group and the arrangements for dividing up orders have, of course, been adjusted to developments over the years. Hollandia-Kloos B.V. in Krimpen aan de IJssel and Grootint B.V. in Rotterdam were the main representatives of this group. On the basis of their experience and the already existing relationships, these companies were considered for the position of main contractor.

As partners, these two companies had established the partnership 'OSTEM' so that they could act as contractant for the other side in the frame contract. The necessary management for the organization and preparation of the work was encompassed in

this new partnership. Because of the juridical status of 'OSTEM', it was stated in the frame contract that companies belonging to the partnership could not become sub-contractors.

Within the framework of this frame contract a combination of the Rotterdam Droogdok Mij. and Stork-Werkspoor was designated to be the main sub-contractor supplying operational mechanisms.

5.4 Relationship aspects

When one actually looks at the parties concerned (Fig. 31) with the realization of the storm-surge barrier, it can be observed that (Section 5.2 and 5.3) there are five main bodies, i.e. the three construction Divisions of the Rijkswaterstaat, the two main contractors.

The mutual relationship between these main bodies was founded in the above-mentioned 'agreement of cooperation' (Doc. 1) and the frame agreements mentioned in Section 5.3. (Doc. 8 and Doc. 9). These relationships are summarized in Figure 36.

The work constructed by this cooperation-structure between the five main bodies, resulted in five main production lines, which finally met at the building-site of the storm-surge barrier, although before this they had established mutual contacts concerning:

- Exchange of technical information and design limitations
- Verbal planning
- Mutual supply of parts

Within these main lines several sub-lines were recognised which, in general, showed a strong mutual dependency and which had frequently met with each other before.

In the Design organization, horizontal contacts were kept on an 'ad-hoc basis' between the project branch (with its working groups), the staff groups and their working groups.

To confirm these contacts, senior management held regular PGS-management meetings which were, besides the PGS, also attended by the chairpersons of the project branch and the staff groups. These meetings also discussed problems of general interest. Members of the 'core groups' of the PGS formed the daily management (chairperson, PGO and UTE; Fig. 34). Mutual relationships were formed between the project organizations and the (main-)contractors on various horizontal levels.

On BGO-level there were occasional contacts with the boards of DOSBOUW and OSTEM.

Within the coordinating-structure, especially at senior management level, contacts were more structural. This is outlined in Figure 37.

From this outline it appears that the design organization (in practice mainly through the design-experts, Section 5.2.) was also involved in these contacts.

Only the construction meetings were held centrally: the other work-meetings were held locally per (main)production-line or per several production-lines, depending on the level and nature of the subject.

When comparing the two main contractors, DOSBOUW and OSTEM (see Fig. 36 and Section 5.3.) a difference of character appears: DOSBOUW was an actual building association on location with activities such as: management, design and construction. OSTEM on the other hand was more of a management organization, with actual construction being performed

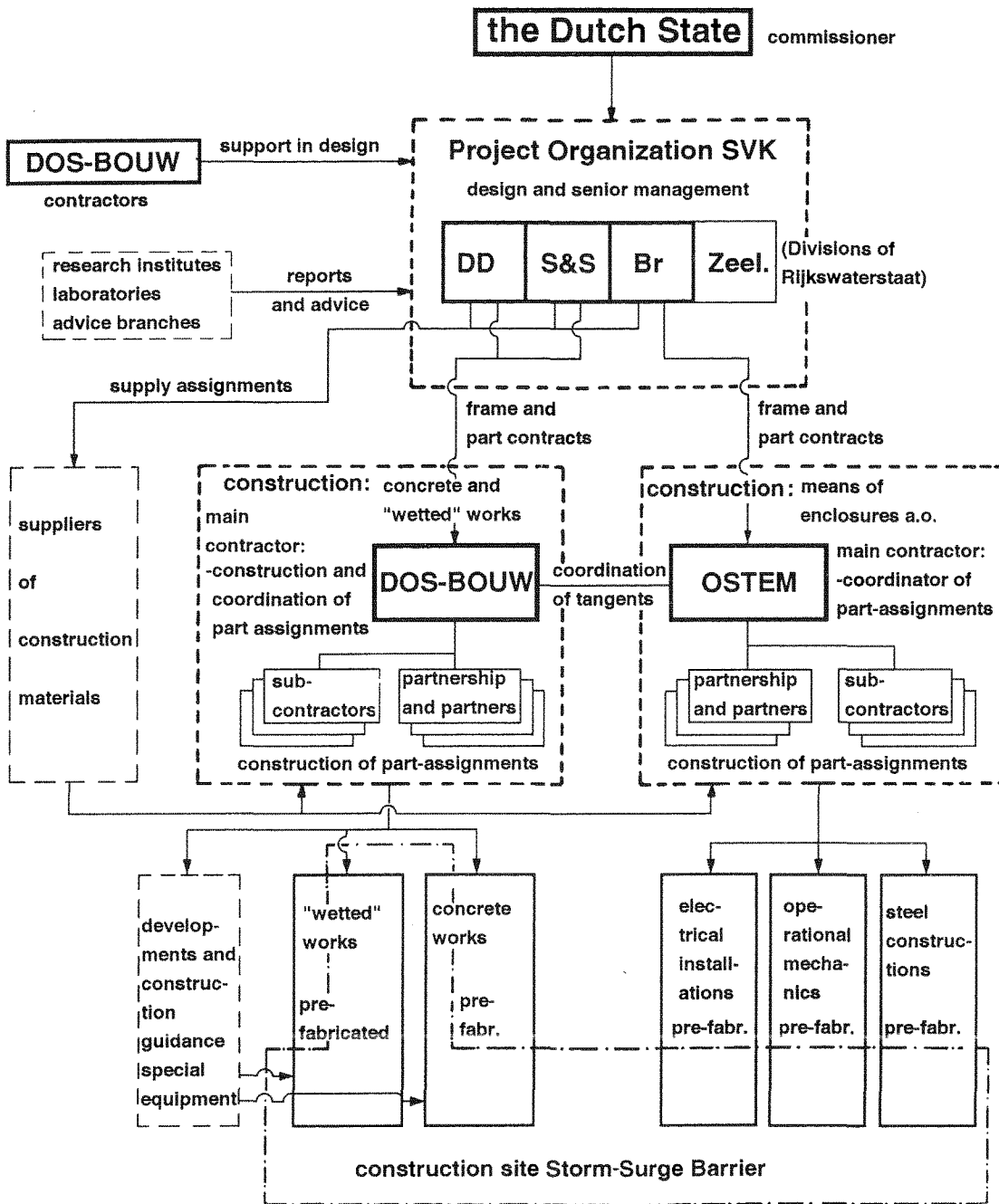

Fig. 36 Relationships between the main bodies involved.

by its partners or sub-contractors. This meant that representatives of these companies (of OSTEM) were generally more involved at the lowest level of work-consultation than in the case of DOSBOUW. OSTEM's significance also influenced the intensity of work-consultations in its (main) production-lines, because construction was spread over a large number of places at home and abroad.

Contacts between the project organization and others involved was generally made through the line-organization of the employing/commissioning Division (Principal). The results of these contacts were brought to the project organization through representatives of the employing/commissioning Division of the Rijkswaterstaat.

In a number of cases (see Section 5.2.2.) representatives of research institutions, engineering and advice bureaus were part of one of the groups of the project organization.

5.5 Planning aspects

For a complex project such as the storm-surge barrier, which is also committed to a limited deadline and costs, good management of the realization process is crucial.

As mentioned earlier, the limits were based on estimates made during the preliminary study period of the original design for piers-on-cuttings.

Costs were limited as much as possible by giving the project

branches a particular budget for a particular part-design, which could only be exceeded with the permission of senior management of the project organization. Necessary budget excesses were compensated for with cut-backs in other areas as much as possible. This limited the excess of the original estimate (inflation is not accounted for) to 30%, although quite frequently complete new techniques had to be applied in design and construction, whereby much research, pushing up costs, had to be carried out (see Part 2, Chapter 7). The time scale also had to be constantly checked because the time given for carrying out the project was very limited. Time planning was concerned with planning the main lines of the entire project and with an even more detailed planning for component-projects and parts thereof.

New ideas on design and construction, outside influences, results of procedure-controls and the consequences of measures taken by management were constantly dealt with in the planning. Senior management of the project organization (PGO later PGS) reviewed proceedings every month, although this does not mean that total planning of the project was controlled every month. This happened on a lower frequency, only when serious changes had to be made. Important resources for time planning were:

Network analysis

An analysis of relationships and dependencies between construction activities, reflected in network planning. Network analysis is applied to the planning of more complicated component projects and not for the entire project.

The time relationship diagram (Fig. 38)

Presentation of planning in the form of a bar-chart, in which the time necessary for activities and the mutual relationships are indicated. The time relationship diagram is also used to present the results of network planning in a easier to read form. This form of planning presentation is widely used by the planning of the entire project and parts thereof. From here one could simply read which series of activities were necessary (critical paths) at that time in order to realize the entire project, or part of it.

Time-placediagram (Fig. 39)

A two-dimensional (time and place) presentation of activity-planning in which the space they occupy is also determining their mutual dependence.

This was made for construction activities in the enclosure gaps.

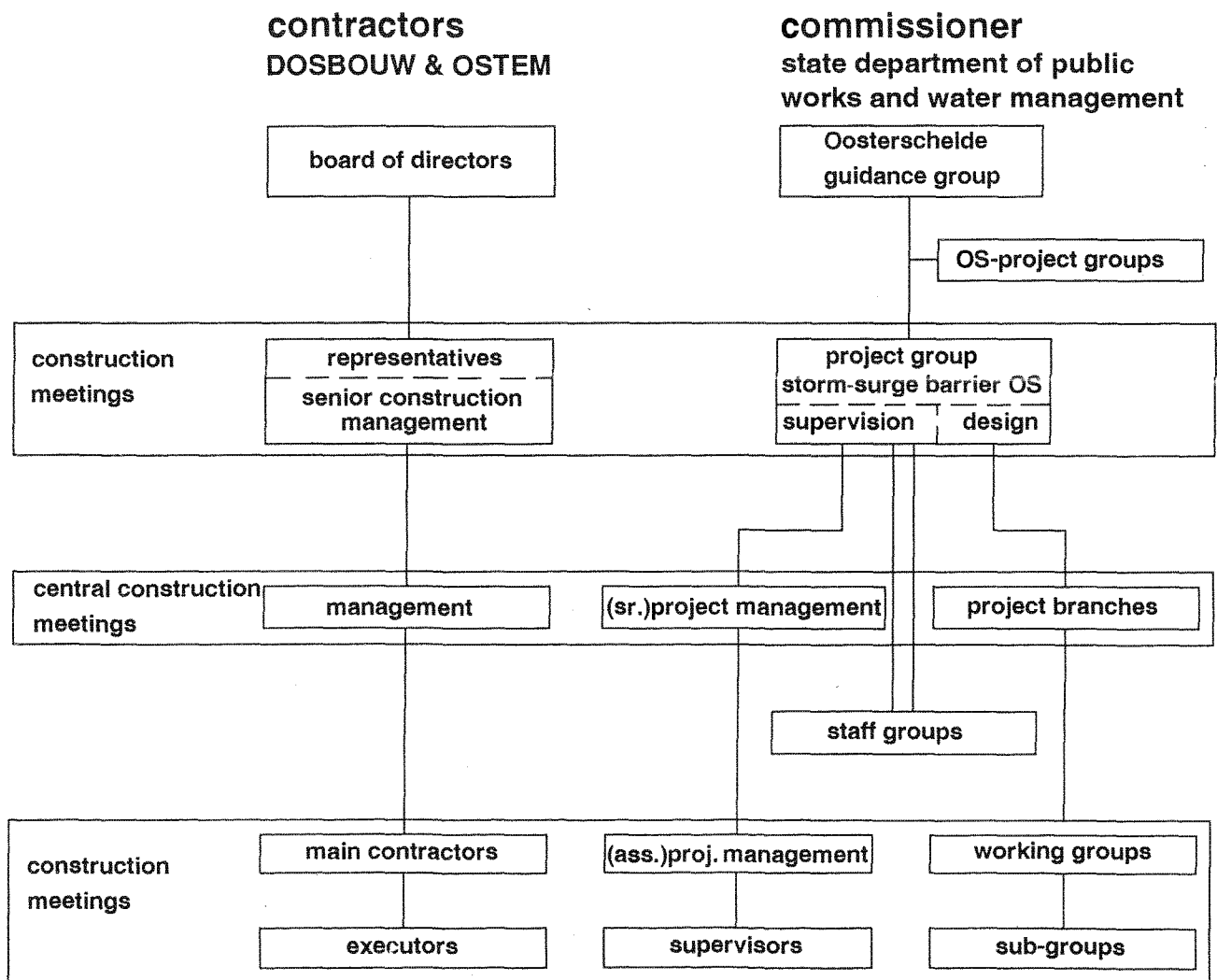

Fig. 37 Consultation on various levels between project management and contractors.

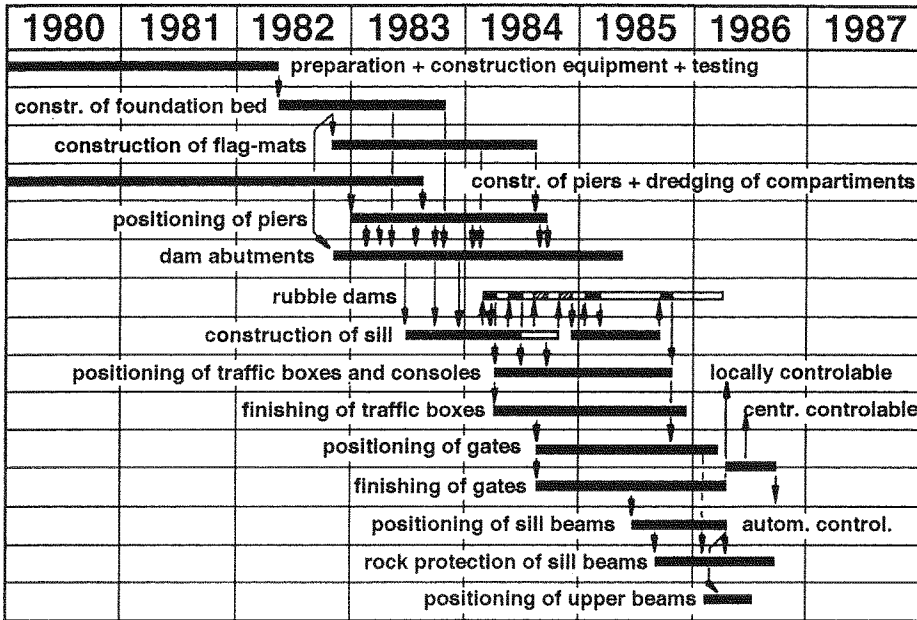

Fig. 38 Simple example of a time relationship diagram.

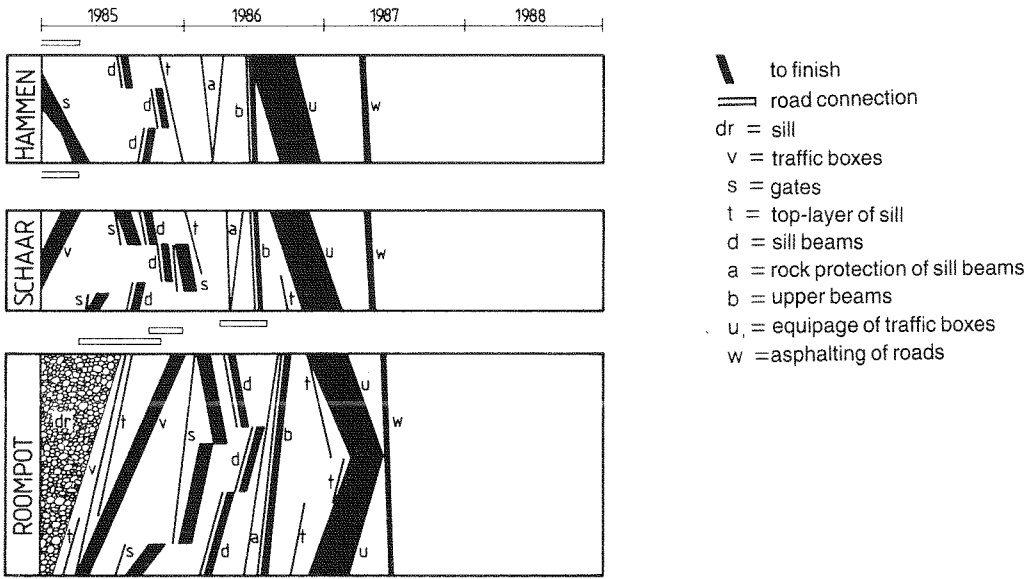

Fig. 39 Time diagram.

Especially the very large anchor systems of the construction boats used for these type of activities, often hindered other activities in a fairly large area around the actual building-site. For safety reasons, anchor wires were not permitted to cross each other (Fig. 40). Particularly in the later phases of the project, when activities in the enclosure gaps increased, planning of these activities with the help of the time-placediagram, was decisive in planning the whole project.

Risk-analysis

Analysis of the factors which could influence the time a certain activity would take an estimate of the probability of their occurrence. With the help of probability analysis methods, it can be calculated how reliable the given time-period reflects an activ-

ity or a number of activities. In addition an estimate can be made of the most probable margin in which the real completion date of an activity or a number of activities will come about. In general, it can give an idea of the reliability of a certain plan method and its most critical points. The importance of this analysis, especially for the activities which are on a critical path in the total planning, should be clear.

These resources were used to draft the working-documents used by management in guiding the realization process.

These working-documents (plans) were a.o.:

The overall construction plan

A time-diagram of the overall project, detailing main activities and months of the year. This was the basic plan, established by

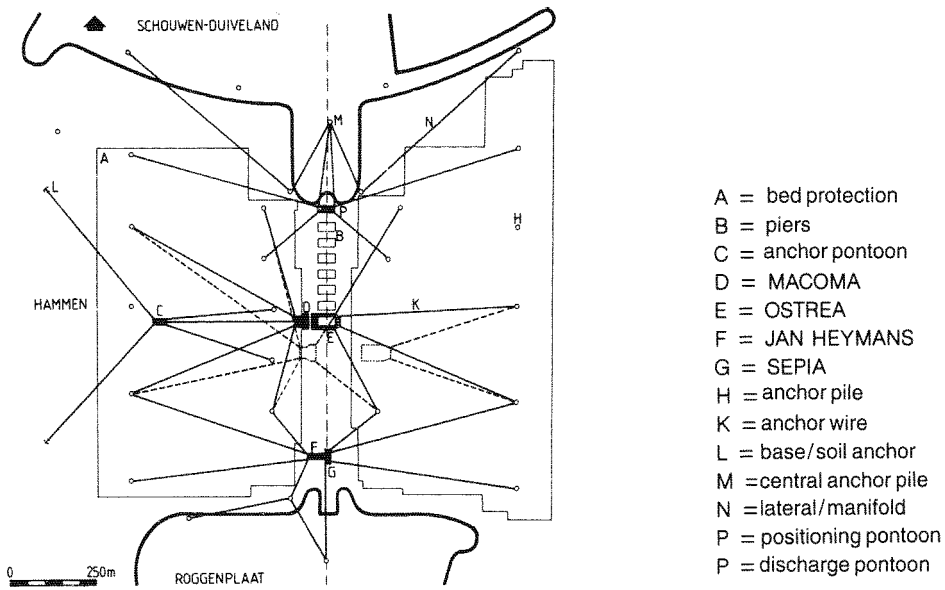

Fig. 40 Anchor-pattern foundation-mats.

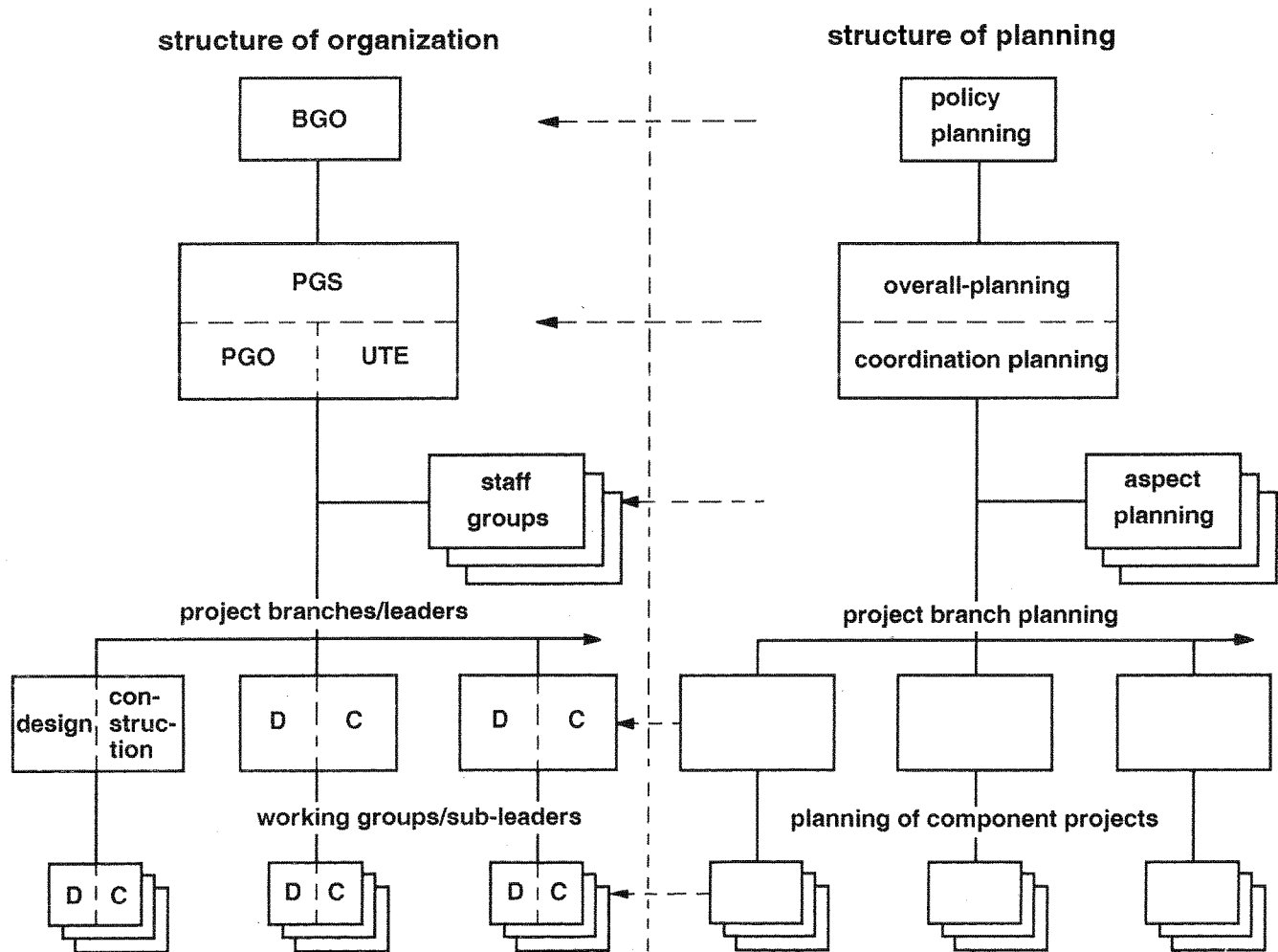

Fig. 41 Structure of organization and planning.

PGS and used as the starting-point for all other plans. The time-placediagram mentioned earlier for the enclosure-activities, was one of the main reasons for drafting this plan.

The policy-plan

A schematic bar-chart, without relation lines, outlining the main points and the quarters of the year, focussed on elements relevant for drafting of the policy. It was established by PGS and approved by BGO. Eventually linked with a progress report, its main purpose was to inform senior policy levels.

The coordination plan

A bar-chart including the entire project in main activities per calendar month (grouped per project branch or staff group), in which the time periods were established, which in turn were gathered from the overall plan and agreed on by PGS. This coordination plan was the starting-point for the more detailed planning of the project branch and staff groups. A summary of the coordination plan, covering a two year period, was used for the monthly progress reports of the work.

Project branch plans, work-group plans, component project plans

Detailed bar-charts for activities of each level of project organization, only for internal use in these groups or in component projects.

Briefly, it can be said that the hierarchy in project organization was mirrored by the hierarchy of the planning documents (Fig. 41).

The planning documents used by a particular level, which also included information on lower or equal levels, had to be included in the planning documents used by the next level up and were also approved by that higher level.

Therefore, on every level the plans of the adjacent levels were

known, which guaranteed a maximum of mutual exchange of information.

Documentation

1 Project Storm-Surge Barrier Oosterschelde, organization and cooperation between Deltadienst, de Directie Bruggen and de Directie Sluizen en Stuwen, SGO-26-H, not dated, with 10 appendices

Also called: Contract of Cooperation

2 Plan Organization and Task-description, PEGEEO-N-78213, 21 August 1978

3 Plan Organization and Task-description, PEGEEO-N-80083, 1 March 1980, second edition 16 April 1980

4 Project organization Storm-Surge Barrier Oosterschelde, Organization and Task-description, PEGEEO-N-82016, December 1981

5 Research and construction organization Oosterschelde water-retaining structure, PEGESS-M-82040

6 Project organization Storm-Surge Barrier Oosterschelde -- Organization and Task-description, PEGESS-N-82241, November 1982

7 Project organization for the realization of the Storm-Surge Barrier Oosterschelde -- Organization and Task-description PEGESS-N-84309, 1 November 1984

8 Frame-contract concerning construction for realization of the storm-surge barrier in the mouth of the Oosterschelde, between the isles of Schouwen-Duiveland and Noord-Beveland, nr. DED-1750, 29 September 1977

9 Frame-contract concerning the construction, supplying and establishment of means of enclosure pertaining to the storm-surge barrier in the mouth of the Oosterschelde, in between the isles of Schouwen-Duiveland and Noord-Beveland.

Nr. Br./8795, 24 March 1980

Part 2: Design philosophy

Contents

1	Basic philosophy and concept of the design	50
1.1	Development of the basic philosophy	50
1.2	The basic concept of the design	50
1.3	The remaining aspects of design philosophy	51
2	Functional analysis	52
2.1	Basic functions and general functional classification	52
2.2	Closure (solid) dam	52
2.2.1	Further analysis	52
2.2.2	Functional requirements	53
2.3	Storm-surge (movable) barrier	53
2.3.1	Further analysis	53
2.3.2	Functional requirements derived from the basic functions	54
2.3.3	Functional requirements derived from the demanded life-span	54
2.3.4	Functional requirements derived from the mutual relationships between systems and components	54
2.3.5	Problems during the construction phase	55
3	Safety analysis	56
3.1	Acceptable probability of failure	56
3.2	Definition of failure of the Storm-Surge Barrier	57
3.3	General analysis of unfavourable events	57
3.3.1	Events at the solid dam	57
3.3.2	Events at the movable barrier	58
3.4	Analysis of the total probability of failure	59
3.5	The probability of failure of the Storm-Surge Barrier with a lower admissible water level in the Oosterschelde	61
3.6	The influence of leakage through the barrier on safety	64
4	Important choices for the design	66
4.1	Foundation subsoil	66
4.2	Prefabrication	66
4.3	Choice of materials	66
4.4	Single or double barrier	66
4.5	Choice of operating machinery for the gates	67
5	Prefabrication and problems of deformation	68
6	The probability in design	72
6.1	General overview	72
6.2	Applications of probabilism in the design of the Storm-Surge Barrier	72
6.3	Further elaboration of strategies	73
6.3.1	Limit states	73
6.3.2	Strategy line A	73
6.3.3	Strategy line B	74
6.3.4	Strategy line C	75
7	Interaction between research and project realization	76
8	The landscaping of the Oosterschelde and surroundings	78
8.1	Introduction	78
8.2	Starting-points and considerations	78
8.3	Configuration 'Neeltje-Jans' construction island	79
8.4	Configuration of dam abutments	80
8.5	Conclusions	81

1 Basic philosophy and concept of the design

1.1 Development of the basic philosophy

The design philosophy answers the question: 'How, in a practical way, can the government's request be answered to build a construction in the mouth of the Oosterschelde in such a way, that during storm-surge conditions it can offer sufficient safety to the area around the Oosterschelde and at the same time under normal conditions, can allow for tidal movement in this basin so that the existing environmental values and other interests will be maintained as much as possible?'

The interpretation given of the assignment was in the description of the design of the storm-surge barrier, which was the result of a process of brain-storming, which started after the publication of the Klaasesz report (see Part 1, Chapter 2 and 4) and which took a large number of possible solutions into consideration.

During this process, the philosophy behind the chosen design became clearer.

The design philosophy indicates a number of starting-points and directives for the actual design and the approach of problems with the aim of:

- Striving for an optimum and well-balanced design of the entire storm-surge barrier, starting from the available time period, labour force, knowledge, environmental- and material data.
- Striving to build a construction in which the probability of failure would be below a certain value.

This probability of failure has to be related to the standards for dam height, formulated by the Delta Committee.

An 'optimum' design in this context means a design that meets the functional demands with the lowest possible costs.

These costs are costs of construction and maintenance.

'Well-balanced', in this context, means that the components of the barrier contribute equally (in principle) to the strength (safety) of the structure, so that there will not be any links too strong or too weak.

The limited realization time and budget available for the project were important data.

From this data the following starting-points were derived:

- To include the work already completed for total enclosure of the Oosterschelde in the storm-surge barrier design as best as possible.
- To strive at a design that is as flexible as possible.
This means that the design of components for the barrier should be such that its influence on the design of other components would be limited as much as possible.
This would make it possible to:
- Construct linking components of design before the design linked components is finalised;
- Divide the design process into various process-lines running parallel to each other;

- Design those components first which have to be constructed first;
- Absorb possible new ideas in the design of not yet constructed components, and to make adjustments to components already under construction without too serious consequences.

In the first phase of the brain-storming process, known as the 'preliminary study period' (Doc. 1), and the following more detailed results of the then operative 'piers on caissons' plan, a certain amount of knowledge and insight into the expected problems was achieved and, a more detailed outlook of the design can be summarized as follows:

- Strive for minimum disturbance of the existing morphology in the channels;
- Strive for a gradual and well-balanced profile reduction in the flow channels in an as late as possible phase of the work so that particularly the flow load on the incomplete work in the construction phase is kept as low as possible and also, taking into consideration the progress of the compartment, keeping an eye on the tide differences of the Oosterschelde as much as possible during the construction;
- Strive to, especially in view of the tide, limit 'vulnerable' activities yet to be performed in the flow channels; which led to
- Striving for further pre-fabrication of components, especially those which were labour intensive or vulnerable and had to be positioned underwater; and also
- To strive for the construction of the underwater components of the movable barrier of granular materials (which were relatively simple to place).

1.2 The basic concept for the design

Using the above mentioned philosophy as a starting-point, the design could be characterized as follows:

- The foundations for the planned enclosure, constructed on the flats in the Oosterschelde and alongside the embankments, are included in the new design as fixed components of the storm-surge barrier.
- The movable components of the barrier are constructed in the three remaining flow channels with broad and relatively shallow cross sections (further subdivided by piers) and maintain the existing volume of discharge in the flow channels.
- The foundation subsoil for constructions in the enclosure gaps, will be improved (both in form and soil mechanical quality) in such a way that a foundation on steel (of the piers) will become possible.
- To stabilize the bed and to form a transition to the constructions to be placed, the foundation base is covered up with a

largely prefabricated filter construction of granular materials.

- The concrete constructions in the movable barrier are limited to what is necessary for the surrounding and supporting of the gates and for realization of the bank connections for traffic (piers, lower- and upper beams, traffic bridges) and are brought to the construction site as prefabricated components.
- Steel lift-gates are used as enclosure devices which, together with their operating machinery, are also prefabricated.
- The necessary permanent closure of the flow channels is realized by building dams of granular materials (mainly rubble).

1.3 The remaining aspects of design philosophy

Beside the already mentioned basic design philosophy (Chapter 1), the actual design process entails a number of other aspects which also belong to design philosophy. They are briefly mentioned here and will be further elaborated on in the following chapters.

In striving for an optimum design, a very precise definition of the demands made on the entire storm-surge barrier and its components, is necessary.

These so-called functional demands will have to be linked to an acceptable probability of failure, because it is not known how great the heaviest storm-surge over a period of 200 years will be. Therefore absolute guarantees that safety-demands will always be met cannot be given.

A precise definition of the functional demands can be achieved with the help of a functional analysis of the object and its components.

The acceptable probability of failure would have to be related

to the standard dam heights set by the Delta Committee, in which a certain probability of failure is included. These standards, in which the probability of failure is not numerically indicated, cannot be transferred to other water-retaining structures such as the movable component of the storm-surge barrier. The movable barrier has to meet different demands and other failure modes apply. A new preferably numerical formula had to be found for an acceptable probability of failure of the storm-surge barrier in which the required life-span (in particular for the functioning of the irreplaceable parts) also plays an important role.

The probability of failure of the storm-surge barrier, in particular for the movable component, is on the one hand determined by the probability of occurrence of certain loads related to the probability of sufficient strength of the structure to resist those loads and on the other hand by the probability of a reliable performance of the gates.

The acceptable probability of failure, 10^{-7} per year, is derived from the social aim of the water-retaining structure (protection) and the average risk of accidental deaths in the Netherlands (Section 3.1).

An optimum design will be obtained when all factors influencing these probabilities, such as the occurrence of other events are linked to each other and the probability of these factors occurring is transferred. Moreover, in this way, a better insight in the potential weak spots of the overall construction will be obtained. Simply, the design according to this method is called the 'Probability approach', which, however, is not always applicable in its most ideal form.

Within the framework of the above mentioned problems, a number of important choices relating to design had to be made.

Finally, a maximum adjustment of the storm-surge barrier to the landscape of the Oosterschelde and its environment is needed.

2 Functional analysis

2.1 Basic functions and general functional classification

In brief, two main objectives followed from the political decision to build a storm-surge barrier in the mouth of the Oosterschelde:

- To secure the water-retaining structures around the Oosterschelde and thus to protect the areas behind it against high storm-surges in accordance with the standards of the Delta Committee.
- To maintain the existing environment of the Oosterschelde basin in the best possible manner.

A secondary objective was:

- To provide a road connection between Schouwen and Noord-Beveland, fitting into the Structure Outline for Traffic and Transport.

Further, as a derived objective, it can be stated that:

- In regard to navigation, a limited, direct connection between the Oosterschelde and the North Sea was maintained.
- The created infra-structure was also used for other purposes such as recreation and industrial development (the so-called secondary functions of the water-retaining structure, see Part 5).

Two basic functions of the storm-surge barrier can be derived from these two main objectives:

- To safely retain storm-surges up to a certain height, limited by a probability of exceedance of 2.5×10^{-4} per year.
- To allow tidal movements in the Oosterschelde during normal conditions, while accepting a limited reduction of the original tidal difference (minimum tidal difference of 2.7 m at Yerseke).

Because of the conflicting nature of these basic functions a movable barrier was chosen. This created a third basic function:

- To be able to close and open the barrier (the transformation function).

One can further analyze these basic functions of the storm-surge barrier.

A survey of the entire barrier shows that there is a difference between:

- Components which are only important to one basic function (the water-retaining function); these are mainly the fixed components of the structure, constructed from sand, and
- Components which, relating to the first two basic functions, play a double role, such as the movable components of the barrier.

In the latter group, the transformation function is performed by the system of the closure device.

In further analysis, the two above mentioned groups will be considered separately. The functional requirements will only

be indicated qualitatively here.

The numerical assignment of the functional demands has to be done according to the environmental boundary conditions with due observation of the conclusions derived from the safety analysis.

2.2 Closure (solid) dam

2.2.1 Further analysis

Components of the solid dam are:

- The foundation works on the embankment of Noord-Beveland and Schouwen, connected to the already existing water-retaining structures there;
- The water-retaining earth structures on the island complex of 'Neeltje-Jans' (Noordland, Damvak Geul, Neeltje-Jans) and 'Roggenplaat';
- The 'Roompot' ship lock (navigation);
- The transitional constructions at the embankments of the three discharge channels, between the above mentioned earth bodies and the movable barrier; these transitional constructions consist of a dam abutment and a dam made of rubble.

All these components have to meet the basic function: to retain storm surges. However, there are differences between these components because:

- Beside the basic function, they also have to fulfil secondary functions, such as:
 - * To let navigation through ('Roompot' ship lock);
 - * To support roads for traffic (earth structures)
 - * To use the existing infra-structure for other purposes ('Neeltje-Jans', 'Roggenplaat').
 - * Functions which stem from the relationship with adjoining components (dam abutments, rubble dams).
- The location of the entire project, in particular the presence of a wet or dry hinterland immediately behind the water-retaining structure, can motivate different interpretations of the basic function.

In general, it can be stated that in relation to the water retaining function, the components of the solid dam operate fairly independently from each other. This means that collapse of one component does not necessarily lead to the collapse of the adjacent component. Exceptions to this are:

- The rubble dams: their collapse can result (in a most extreme case) in the undermining of the adjacent pier or affect the dam abutment constructions, and
- The 'Roompot' ship lock: its collapse, in particular because of the washing out of the lock-site, can lead to (also in a most extreme case) undermining of the adjacent earth structures.

2.2.2 Functional requirements

With regard to the starting point of the retaining height of the water-retaining structures, the design level recommended by the Delta Committee had a probability of exceedance of 2.5×10^{-4} per year (see Part 1, Section 3.2). For the Noord-Beveland-side of the Oosterschelde it was Mean Sea Level (MSL) plus 5.5 m and for the Schouwen-side it was Mean Sea Level plus 5.3 m. Note: MSL = NAP (in Dutch).

The crest height of dikes is also an indication of its strength, because collapse normally starts with soaking of the inner slope, caused by water-overflows. Therefore it is assumed that the outer slope is sufficiently protected.

The Delta Committee demanded that no more than 2% of the wave run-up which is to be expected during storm-surges should cause water-overtopping.

This demand also applied to the crest heights of the earth structures in the storm-surge barrier (Mean Sea Level plus 11.50 m) which would then give sufficient protection to the hinterland ('Neeltje-Jans' and 'Roggenplaat').

Constructions on the sea-side of the barrier could have a supporting function. These constructions are the harbour dams (breakwaters) of Outer Harbour 'Neeltje-Jans' and Outer Harbour 'Noordland', with the beach and the formation of dunes on the island complex 'Neeltje-Jans' and the western ring dike of the 'Roggenplaat' island in between. These constructions 'break' the waves to a certain extent, which can be used in the design of the actual barrier (for the crest height of coupures).

The size of the water retaining earth structures was determined by its supportive function for the road over the barrier of which, especially, the height was indicated by the height of the movable barrier in the discharge channels (Mean Sea Level (MSL) plus 12 m) and the intersection with the 'Roompot' ship lock (with a headroom of MSL plus 20 m).

The mentioned design level was also the starting-point for the crest height of the rubble dams.

Because there was no danger here of saturation by water overtopping and the overflowing water could be absorbed directly into the Oosterschelde basin, the permitted overtopping and the required extra height above the design level was mainly determined by the stability of the outer-layer of rubble in relation to the expected wave attack.

For the same reasons, the rubble dam did not have to be absolutely water-proof.

The support function for the road was not important for the functional demands of the rubble dam, this function was taken over by the abutment traffic boxes, which were positioned parallel to the rubble dams and connected with the traffic boxes over the movable barrier.

The main functions of the dam abutments are:

- To finish the sand bodies of the solid dam in transition to the movable barrier;
- To form a foundation subsoil for the concrete abutment constructions situated above. These concrete abutments form a point of support for the abutment traffic boxes, for the transition to the road and the entrance to the inside of the traffic boxes.

With regard to these functions, the following demands were required:

- Under influence of hydraulic gradients, no sand should be washed away from the sand bodies to the open rubble dams and adjacent waters;

- There should be no significant settlement differences under the abutment.

The construction had to be able to resist the wave attack expected from the theoretically calculated storm.

Both the rubble dams and the dam abutments had to be constructed from a substantial depth, in subcritical flow. Their foundation is also the end of the foundation bed for the movable barrier. This meant that in both design and construction, the following had to be taken into account:

- Design and construction phases of the movable barrier (such as harmonization of the construction phases);
- The probability of damage through storm and erosion (caused by currents) during construction;
- The probability of sand deposits at locations where they, in a later stage, could be washed away by hydraulic gradients and thus could cause unfavourable settlement, in particular for the foundation subsoil of the abutments.

The functional demand for the 'Roompot' ship lock was that it should be able to lock through, materials of contractors needed to finish construction of the barrier, materials for maintenance, recreation boats, fishing boats and coasters at every normal water level difference. The design level was used as starting-point for its retaining height. If the lock-site and the slopes of the adjacent earth bodies had a sufficient erosion-proof layer, water overflow by waves was acceptable because this water could be directly discharged into the Oosterschelde via the Inner Harbour Noordland, in spite of the fact that the lock-site would be difficult or inaccessible under those conditions.

2.3 The storm-surge (movable) barrier

2.3.1 Further analysis

The movable component of the barrier mainly consists of the foundation bed, the sill, a composition of piers, sill beams, upper beams, traffic boxes and the gates with their operating machinery as enclosure devices. The bearing capacity of the subsoil plays an essential role in the entire function fulfilment. The adjacent aprons and bed protection have a supportive function which is to prevent undermining of the foundation subsoil by erosion.

Characteristic of the components of the movable barrier is that they form one system (inter-dependency) that has to carry out the assigned functions. This system can be subdivided into:

- A system of passive components, that, by its presence only, fulfill the assigned role. Demands are primarily made related to strength, shape and lifetime.
- A system of active components that performs and undergoes an act which fulfills the assigned role. In addition to demands relating to shape and strength, demands are also made relating to reliability and ability to control.

As mentioned in Section 2.1, the movable barrier has three basic functions:

- Discharge function;
- Retaining function;
- Transformation function.

Secondary functions would be:

- The supportive function for a road connection over the barrier.

The passive system mainly plays a part in the first two basic functions and the secondary function.

The active system carries out the transformation function and

performs a role (i.e. the sliding gates) in the retaining function. The functional demands which have to be met by design for the movable barrier, can be indicated with the help of the three basic functions.

Furthermore it would appear that additional matters, such as:

- The requirement for the barrier to hold a life-span of at least 200 years,
- The mutual relationships between the active and the passive systems and the relationships between components within these systems, and
- The problems created by construction in subcritical flow, have led to additional requirements which became decisive in parts of the design process.

2.3.2 Functional requirements, derived from the basic functions

The discharge function

The following functional requirements can be linked to the discharge function:

- To offer such a large cross sectional area (A) with such a form (yielding μ), that [to maintain a minimal desired tidal difference in the surface of the Oosterschelde, after compartment dams have been constructed, sufficient discharges can be effectively let through (sufficient μA) (see Part 1, Section 3.1);
- To yield sufficient flow resistance of the appropriate components under the actual conditions at which the discharge function (whether or not desired) is working;
- To have such a wetted cross sectional area that the morphological disturbance of the existing environment is minimal.

The retaining function

The following function requirements can be linked to the retaining function:

- To retain storm-surges which do not exceed the design level (MSL plus 5.50 m, or 5.30 m, see Part 1, Section 3.2) taking into account the low basin water level (positive head); a certain discharge volume penetrating the barrier (through leakage or wave overflow) is acceptable because of the Oosterschelde basin storage capacity;
- To resist against the load of wave attack during a storm-surge.

The transformation function

The following requirements can be linked to the transformation function:

- A dependable performance of the desired transformation function;
- To be able to centralize and decentralize control of the active system, since the entire complex is very comprehensive;
- The manager has to hold an extensive liberty in choosing the most desired strategy for operating the transformation function.

In more detail, the latter function requirement means that:

- The gates should be able to be closed during positive head conditions;
- The gates have to be able to be opened during both positive and negative head conditions and
- The gates have to be able to remain in a partially closed position during various head conditions (the so-called reductor strategy, see Part 5, Chapter 1).

Besides influencing design of the active system, this function

requirement also influenced further interpretation of the discharge function, particularly with regard to flow resistancy requirements.

2.3.3 Functional requirements, derived from the demanded life-span

The passive system consists of a large number of components which cannot be replaced or are very difficult to replace. The already mentioned general requirement for the entire complex to have a life-span of at least 200 years (see Part 1, Chapter 3), is particularly valid for these components.

This requirement can be subdivided into the need for:

- A durable construction (choice of material etc.),
- A reliable construction, which means that the whole system will not be irreparably affected when there is a failure of components or functions (internal safety).

The latter requirement is particularly directed towards failure of the transformation system during or after storm-surge conditions. This can be caused by a disturbance in the active system, which would cause one or more gates not to function, or by a failure of management, central control, or electricity supply causing a delay in, or failure of, activation of the transformation function.

The requirement for internal safety measures to cope with the consequences of a (partial) failure of the transformation function, creates additional requirements for:

- Flow resistancy when the barrier is opened under storm-surge conditions;
- Flow resistancy when one or more gates are open under storm-surge conditions (gate's position jammed);
- Flow resistancy when one or more gates will not open, especially when there is a negative head.

For the retaining function the internal safety requirement against failure consequences of the transformation function leads to the additional requirement that:

- There is the ability of retaining a negative head, which means the basin's water level is higher than the sea level.

2.3.4 Functional requirements derived from the mutual relationships between systems and components

As stated in Part 2, Section 3.1 the components of the movable barrier function interdependently within a system. Every component performs a specific role which can be further analysed and for which specific functional requirements can be formulated. These specific functional requirements are mentioned in the more detailed discussion of the design in the books 2-4. It would take too long to deal with these now.

An exception is made for the deformation of the composition of the concrete components in the movable barrier. These components were prefabricated and fairly loosely joined during construction, allowing for a possible limited deformation of the system without significant secondary stresses. On the other hand these deformations must be confined to certain limits, given the system's guiding function, for movement of the gates, and the possible occurrence of too significant secondary stresses in the mutual connections of the components.

Positioning and fabrication tolerances also play a role here (see Chapter 5). During the construction and life-span of the barrier, deformations in the chosen construction are, for an important part, determined by deformations in the foundation bed and in particular in the foundation subsoil underneath it,

and are therefore also bound to acceptable limits. More accurately formulated, this leads to the following functional requirement for the foundation bed and foundation subsoil underneath the piers:

'The temporary or permanent deformations in the foundation which cause tilting of the piers and/or differences in positions between the piers (caused by stresses on the piers or by other processes), are bound to certain acceptability limits during the entire life-span of the barrier'.

Considering the required life-span of 200 years for the barrier, meeting this requirement is of decisive importance for the effectiveness of the barrier, especially since it is almost impossible to repair or compensate significant deformations.

2.3.5 Problems during the construction phase

The movable barrier had to be constructed on a 'moving' base, in an environment dominated by currents and waves. The gradually reducing wetted cross sectional area of the barrier during construction would increase the flow, on the completed work and the bed in the nearby vicinity.

Therefore the general requirement for both the design and construction sequence had to be that: a stable situation was

created during every stage of construction, taking into account the expected currents and wave attacks. Vulnerable situations were only to be allowed for a short duration and had to be limited in size.

In the design, this requirement was translated in so-called construction phase loads, which the constructed works had to resist in the relevant construction phase.

In a number of cases, for example for the bed protection in certain places, these construction phase loads were decisive in determining the appropriate dimensions.

Otherwise, this general requirement translated into an additional requirement of current-resistancy for components that would not be subjected to it in the final situation.

The decision to prefabricate the bulk of the filter constructions of the foundation bed was made because of the necessity to quickly fix the fitted surface (consisting of sand) of the foundation subsoil and to make the first fine fractions of the filter constructions, positioned on top, resistant to direct currents. To meet the temporary current resistancy requirements, it was wrapped in filter cloth.

During construction of the sill core and rubble dam, the size of the used rubble was, to a large extent, determined by the current resistancy requirements during that construction phase.

3 Safety analysis

3.1 Acceptable probability of failure

One of the construction aims of the storm-surge barrier was: 'To protect parts of Zeeland against flooding of the Oosterschelde caused by storm-surges'.

To meet this aim, the storm-surge barrier operates in one system together with the water-retaining structures positioned around the Oosterschelde.

In general, failure of the storm-surge barrier may cause the failure of the entire system and because of that, the need to describe unfavourable events arose.

In reverse, the failure of the entire system does not always have to be caused by failure of the storm-surge barrier (see Part 5, Chapter 1).

It follows from this, that the probability of failure of the storm-surge barrier can, to a certain extent, be considered independently.

This is in line with the Delta Committee's report which indicates the design levels for the main water retaining structures, without taking into account the eventual systems which the main water retaining structures could play a part. For the storm-surge barrier the independent considerations of the probability of failure is limited, insofar, that when defining the probability of failure (see Section 3.2) the workings of the entire system is involved.

In the discussion about the safety limits (see Part 1, Chapter 3), it was indicated that the height of the barrier had to be in accordance with the design level advised for the south-west of the country, which has a 2.5×10^{-4} probability of exceedance per year.

From this it could be concluded that there is an acceptable probability of failure, which is less than 2.5×10^{-4} per year. Exceedance of this level will cause flooding, at a given moment, of the barrier. That is not considered to be an actual failure by definition, because flooding of the barrier does not necessarily mean that parts of Zeeland will be flooded too.

Depending on a number of other factors, the entire system has a certain margin available.

It was indicated that the structural strength would have to be resistant against a potential threat from outside, also with a probability of exceedance of 2.5×10^{-4} per year.

It was further recognized that the barrier could fail caused by a potential threat from within, i.e. through a chain reaction of unfavourable events in the object itself, although not in connection with the potential threat from outside.

Finally, it can be derived from the functional analysis that operation of the barrier and also its failure, is dependent on human action, i.e. closing the barrier in time.

All these elements appear to contribute to the barrier's total probability of failure (see Section 3.4). Due to the diverse character of these elements, it is impossible to test the design

by technical standards only.

Because, in the already above mentioned objective, the storm surge-barrier has a social aim, efforts were made to produce an acceptable probability of failure as seen from a social background, which could be used to test the barrier's probability of failure.

The idea behind this was such that the group of Zeeland inhabitants which could possibly be threatened by failure of the storm-surge barrier should not have a greater risk of death than the average risk of death by accident in the Netherlands as a whole (approx. 10^{-4} per year per individual).

The event indicating this risk has been defined as: 'Because of failure of the storm-surge barrier, parts of Zeeland will be flooded'. In this event, the number of deaths was estimated at 1000, of a potentially threatened group of 100,000 people.

When the average risk of death by accident in the Netherlands is related to a group of 1000 potential victims, it creates a maximum acceptable probability of failure of the storm-surge barrier of 10^{-7} per year ($10^{-4}/1000$). For a group of 100,000 people this would mean an individual risk of 10^{-9} per year. This can be evaluated using Figure 1. This idea is further detailed in Doc. 1.

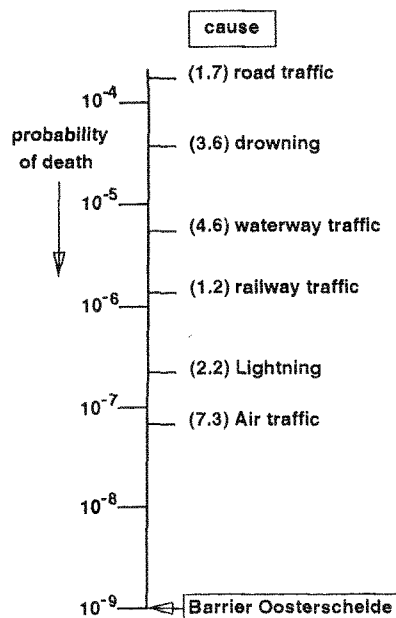

Fig. 1 Probability of dying per individual per year in Dutch society.

3.2 Definition of failure of the Storm-Surge Barrier

The failure (collapse) of the storm-surge barrier may, in two ways, lead to the worst possible event: 'the flooding of parts of Zeeland':

- Because of a discharge through the barrier, the water level in the Oosterschelde rises to such a level, that it causes the collapse or flooding of the surrounding retaining structures.
- The collapse of the retaining structures bordering the banks of Schouwen and/or Noord-Beveland.

It is thereby then assumed that the adjacent water retaining structures of these islands are also affected and will collapse, more or less independent of the water level in the Oosterschelde.

As already indicated, the first cause is important for defining the failure of the entire barrier and especially for the movable part, on which the probability of failure analysis will be mainly concentrated. For the probability of failure analysis of the storm-surge barrier, the maximum admissible water level in the Oosterschelde was the average design level (Mean Sea Level + 4.30 m) of the provisional dike reinforcements around the Oosterschelde (exceedance frequency 1/500 per year, with an open Oosterschelde).

It was expected from this that eventually all relevant water retaining structures would be able to retain this water level.

With the above mentioned information, the failure of the storm-surge barrier can be defined as:

'the passing of such a discharge that the maximum admissible water level in the Oosterschelde (an average of Mean Sea Level + 4.30 m) is exceeded'.

The possibility of the occurrence of a so defined maximum unfavourable event will, considering the probability of the occurrence of an unfavourable event according to the second mentioned way, be tested against the accepted probability of failure.

The discharge that could be allowed through the barrier during storm-surges can be subdivided into:

- 1 A discharge originating from:
 - Wave overflow over the lower parts of the barrier (retaining height Mean Sea Level + 5.80 m or + 5.60 m)
 - Leakage through the sill and rubble dams
 - Leakage through incompletely closed gates.
- 2 An extra discharge, originating along the lines of 1 above, caused by exceeding the design level.
- 3 An extra discharge caused by an unfavourable event related to the barrier itself.

Regarding the discharge mentioned in 1 above it can be stated that this, even though conditions in the area differ, always exists.

Using the storage basin of the closed Oosterschelde and on the basis of the functional analysis, this discharge can be accepted.

When selecting safe closing strategies, the existence of this volume of discharge should be taken into account.

The discharge mentioned in 2 above will also be accepted because it resulted in the exceedance of a boundary condition, set by the designers of the barrier. Anyway, the probability of occurrence of this extra discharge per definition is smaller than 2.5×10^{-4} per year and would not necessarily lead to a direct exceedance of the maximum acceptable water level in the Oosterschelde. Some things are, amongst other things, dependent on the extent and length of exceedance and the chosen closing strategy.

Only the discharge mentioned in 3 above would, in principle, not be acceptable.

However, according to the definition given, all three discharges mentioned above contribute to the barrier's probability of failure. Particular attention is paid to the safety considerations regarding the probability of events which could cause the discharge mentioned in 3 above. For so far as these events can give cause to the defined fatal discharge, the probability of its occurrence, in connection with the probability of occurrence of the contributory boundary conditions of nature, will be tested on the accepted probability of failure.

Assuming the above mentioned is not the case, a greater probability of occurrence is in principle acceptable, as long as these events do not cause permanent damage to the barrier which would hamper its future operation (see Chapter 2, functional analysis).

3.3 Global analysis of unfavourable events

Considering the entire barrier complex, events which could lead to failure of the barrier can be divided into two groups:

- Events relating to fixed components of the barrier, and
- Events relating to the movable components of the barrier.

3.3.1 Events at the solid dam

The fixed barrier essentially consists of:

- Water retaining earth structures, mainly built from sand (dam sections on the construction islands and dam abutments);
- Rubble dams;
- The 'Roompot' ship lock.

Failure of the barrier may be caused by the collapse of on of these water retaining constructions.

Generally, the water retaining earth structures are, because of their road supporting function (see Chapter 2), over-estimated with regard to their retaining function. With a retaining height of MSL + 12 m and a wave overflow of 2%, the probability of this collapse was estimated at less than 10^{-9} per year (see Doc. 2).

With the calculation of the retaining height coupures, situated at various locations, pessimistic estimates were also made (Doc. 3) on the basis of which it can be assumed that they will not harm the above mentioned probability estimate.

The collapse of the dam abutments can still occur through the collapse of the rubble dams.

After the initial event (collapse of the rubble dam's surface, or a serious subsidence of the connecting boundary pier), a slow process of erosion begins which may cause the dam abutments to collapse. A risk analysis of the occurrence of this process and the possible consequences is made in Doc. 4. For the dam abutments in Schouwen and Noord-Beveland further progression of this process may lead to the collapse of the adjacent water retaining structures of the mentioned islands (failure no. 2, Section 3.2); for all the dam abutments a collapse means a rise in the Oosterschelde water level (failure no. 1). From this analysis it further appears that for the surface layer of the rubble dam at Schouwen and Noord-Beveland a 10^{-7} probability of failure per year is required, and for those near the construction islands a higher probability of failure (finally fixed at 10^{-6} per year) is permissible.

In view of the fairly pessimistic design estimate, the probability

of failure for the 'Roompot' ship lock with regard to a breakthrough was estimated to be 10^{-7} per year.

3.3.2 Events at the movable barrier

Principally the events at the movable barrier, which (whether through a chain reaction or not) lead to a large discharge through the barrier and with that perhaps a water level too high for the Oosterschelde, can be divided into two groups:

- Events which may be generally described as the collapse of components participating within the retaining function, and
- Events which could lead to the inability to close the gates in time.

This fundamental difference is of importance because the approach of these problems is different in the design.

Firstly, it concerns a design process which is generally characterized by:

- Load estimates;
- Strength calculations (modelling of drift forces);
- Estimations of the material quality.

This process has to be sufficiently accurate (coefficients of safety) in order to achieve the required probability of failure (see Chapter 6).

Secondly, it especially concerns the reliability aspects of the operating system of the gate design and of the human organization operating this system.

Without going into details (see Book 4), it can be said that principally a large number of initial events (disturbances), may lead to a malfunctioning of the operating system.

As far as organization is concerned, this system consists of central and decentralised components. Disturbances in the

centrally organized part may influence the operation of a large number of gates, or even the entire movable barrier, while disturbances in the decentralised part often only relate to the operation of a single gate.

By building in safeguards into the vital parts of design, the consequences of occurring disturbances can be countered (although not automatically) as much as possible.

But the probability of fatal disturbances is ever present.

The human organization which has to operate the entire system is also subjected to the probability of failure.

Although organization is the responsibility of the manager, the design of the storm-surge barrier provides an automatically working emergency closure system as a back up for eventual human error.

This emergency closure system will also be subjected to a certain probability of failure.

Quantitatively, all globally treated unfavourable events can be divided into:

- Events in which only a few gates are not closed, or will collapse, and
- Events in which a large number of gates are not closed, or will collapse.

Given the storage capacity of the Oosterschelde basin, a single unclosed gate does not necessarily have to lead to an exceedance of the admissible water level and thus, according to the definition given, to the failure of the barrier.

In Doc. 5, amongst other things, model calculations are reported which gave a prognosis on the probability of exceedance of the water levels of the Oosterschelde by different closing strategies and by a different number of faulty gates. The latter as standard for a partial failure of the barrier.

Table 1 Calculated probability of exceedance of the water levels in the Oosterschelde with various closure strategies and various numbers of faulty gates. Time: end of the storm.

Closing strategie					Computed model	Failing gates Number	Oosterschelde water level		
LWK	AI	AII	AIII	AIV			Pr = 2.5×10^{-4} /year	MSL + 3.5 m	NS: + 4.3 m
						MSL + m	Pr per year	Pr per year	
	X				BARCON	0	2.65	$< 10^{-9}$	$< 10^{-9}$
			X		BARCON	0	3.0	1.6×10^{-7}	$< 10^{-9}$
		X			BARCON	0	3.4	8×10^{-5}	2.4×10^{-9}
				X	BARCON	0	4.0	$\times 10^{-2}$	2×10^{-5}
X					OOSWAT	0	2.25	2×10^{-7}	2.2×10^{-9}
	X				OOSWAT	0	2.9	4.5×10^{-6}	1.2×10^{-8}
		X			OOSWAT	0	3.2	3.4×10^{-5}	1.3×10^{-7}
	X				OOSWAT	1	3.0	1.2×10^{-5}	8×10^{-8}
	X				OOSWAT	5	3.5	2.5×10^{-4}	7×10^{-6}
	X				OOSWAT	10	3.9	1.6×10^{-3}	5×10^{-5}
		X			OOSWAT	1	3.3	8×10^{-5}	6×10^{-7}
		X			OOSWAT	5	3.7	6×10^{-4}	1.4×10^{-5}
		X			OOSWAT	10	4.0	2.1×10^{-3}	7×10^{-5}
-	-	-	-	-	-	62	5.3*	$6 \times 10^{-2*}$	$3 \times 10^{-3*}$

Closing strategy: closing at: LWK = slack water on the ebb; AI = alarm level I, MSL + 2.75 m; AII = alarm level II, MSL + 3.25 m; AIII = alarm level III, MSL + 3.0 m; AIV = alarm level IV, MSL + 3.5 m. Data derived from doc. 5.

*According to statistical data from the report of the Delta Committee for Burghsluis and an open Oosterschelde.

When gates are failing, the probability of occurrence has to be multiplied by the probability of occurrence of a number of failing gates, this probability is less then: 10^{-2} per closure of 1 gate; 6.3×10^{-5} per closure of 5 gates; 2×10^{-4} per closure of 10 gates, with unmanned control (Pr = 0.1); 5×10^{-5} per closure of 62 gates, with manned control (Pr = 0.9); 8×10^{-5} per closure of 62 gates, with unmanned control (Pr = 0.1), according to Doc. 8.

The data in Table 1 was derived from Doc. 5. It appears from this that the influence of one single faulty gate is not larger than the choice between two different alarm-level closures. Only if there is an opening which compares with 5 or more faulty gates does an actual increased risk of inadmissibly high water levels in the Oosterschelde exist.

3.4 Analysis of the total probability of failure

All unfavourable events conceivable leading to the maximum unfavourable event: i.e. 'parts of Zeeland are under water', may be brought together by a logical tree of events, and with the concluding event. Such a tree of events is called a fault tree.

Whenever, as best one can, a rational estimate of the probability of occurrence of all initial events and also a rational estimate of the possible continuation to a logical follow up of events, such as the data in this fault tree, are worked out, the probability of occurrence of the concluding event can, in simple terms of arithmetic, be calculated.

By following this method, an analysis of the total probability of failure of the storm-surge barrier was carried out in Doc. 2.

Figure 2 shows the main fault tree which is supported at the input locations by a large number of sub-trees and differently derived methods of the probabilities of occurrence.

In this analysis a difference is made between a (unfavourable) discharge through four or less openings and a discharge through five or more openings.

In the first place, it is assumed that the barrier functioned despite the fact that a probability of exceedance of the maximum permissible water level in the Oosterschelde still remained (see Section 3.2.2). Anyway, this probability was included in the calculations of the probability of the event.

Figure 3 shows the top of the fault tree in a slightly different form, with Figures 4 and 5 showing a quantitative interpretation thereof for two different closing strategies: closure at low tide (Fig. 4), and closure at an alarm level of MSL + 3.25 m (Fig. 5). From this probability of failure analysis the following conclusions were drawn:

a) If the probability of failure of the storm-surge barrier is considered to be the average probability whereby a too high water level of the Oosterschelde occurs, then this probability amounts to roughly 3×10^{-8} per year, with a closure at low tide (LWK) and 1.5×10^{-8} per year, and with an alarm level II closure (AP II).

If, for all the initial events, the most unfavourable estimates are applicable, which is a pessimistic point of view, then the previously mentioned probabilities become 4×10^{-7} and 10^{-6} per year respectively.

b) The most delicate events, that is to say the committed probabilities of events contributing practically 100% to the concluding results, are:

- 'Input 1c', management fails with regard to five or more gates;
- 'Input 2c', gate mechanism fails with regard to five or more gates; and
- 'Input 4', wave overflow etc..

c) The 'parts of Zeeland are flooded' event is a consequence of both 'water level in the Oosterschelde is higher than MSL + 4.30 m' (to which the probabilities mentioned in a) are related) and 'Schouwen and /or Noord-Beveland are flooded/being flooded'.

For the 'parts of Zeeland are flooded' event, together they amount to an average probability of approx. 10^{-7} per year, both at a LWK-closure as at an AP II-closure. These values meet the 10^{-7} criterion set by the Deltadienst of the Department for Hydraulic Engineering. The unfavourable (pessimistic) estimate for this event (1 to 2) is 10^{-6} per year, which exceeds the criterion.

d) The events, mentioned in (a) and (c) above, which mainly contribute to the probabilities of failure are:

- 'Input' 18a, dam abutment collapses because of collapsing surface layer at LWK closure; and,
- 'Input' 4, wave overflow etc. at an AP II closure.

e) The closing strategies mentioned have no real influence on the probabilities of failure for the total system.

f) If it is desired to alter the design of a component, whereby the accompanying failure and collapse probabilities will also be altered, then one must realize what the consequences will be, both for the probability of failure of the entire system as for the allowance for the probabilities of failure of other components.

However, it should be commented that:

- 'Input 1c' was based on a rough estimate since organization of management was unknown. Now that this organization, particularly the entire system for operational activation (see Part 5, Section 1.7) is better known, improved estimates can be made. According to Doc. 9 this input should be estimated at 2.8×10^{-5} per necessary closure, which will practically come to 2.8×10^{-5} per year. In this input consideration is made for:

- Failure to man the barrier;
- Failure of the emergency closing system; and/or
- Failure of electricity supply (centralised) by automatic operation of the barrier.

Because in this case the barrier remains completely open, the transfer-coefficient for the exceedance of the maximum admissible water level in the Oosterschelde becomes (MSL + 4.30 m) 3×10^{-3} per year.

- The 'input 2a, 2b and 2c' are, according to Doc. 7, based on the probability of failure analysis for the temporary design of the operating system.

On the basis of the final design for the operating system a new probability of failure analysis was carried out later (Doc. 8). In view of this, the probability of failure of a gate (input 2a) had to be estimated at 10^{-2} per request.

Based on this analysis, 'input 2c' had to be revised as well. This input is mainly determined by failure of the energy supply, which causes an insufficient start-up of the diesel powered station.

For a manned closure, the probability of failure for the diesel powered station is estimated at 5×10^{-5} per application, and for an unmanned (automatic) closure this would be 8×10^{-5} per application. With an 0.9 probability per closing action, using a manned closure, 'input 2c' becomes 4.5×10^{-5} per application.

The assumption that the barrier does not close in its entirety applies here too, so that the transfer coefficient would then also be 3×10^{-3} per year.

- 'Input 18' is based on Doc. 4. The rubble dams at the construction island are, however, designed with a probability of failure of 10^{-6} per year instead of 10^{-5} per year (see Section 2.9).

- Both 'input 4' and the estimates for the transfer-coefficients of the various unfavourable events relating to the probability

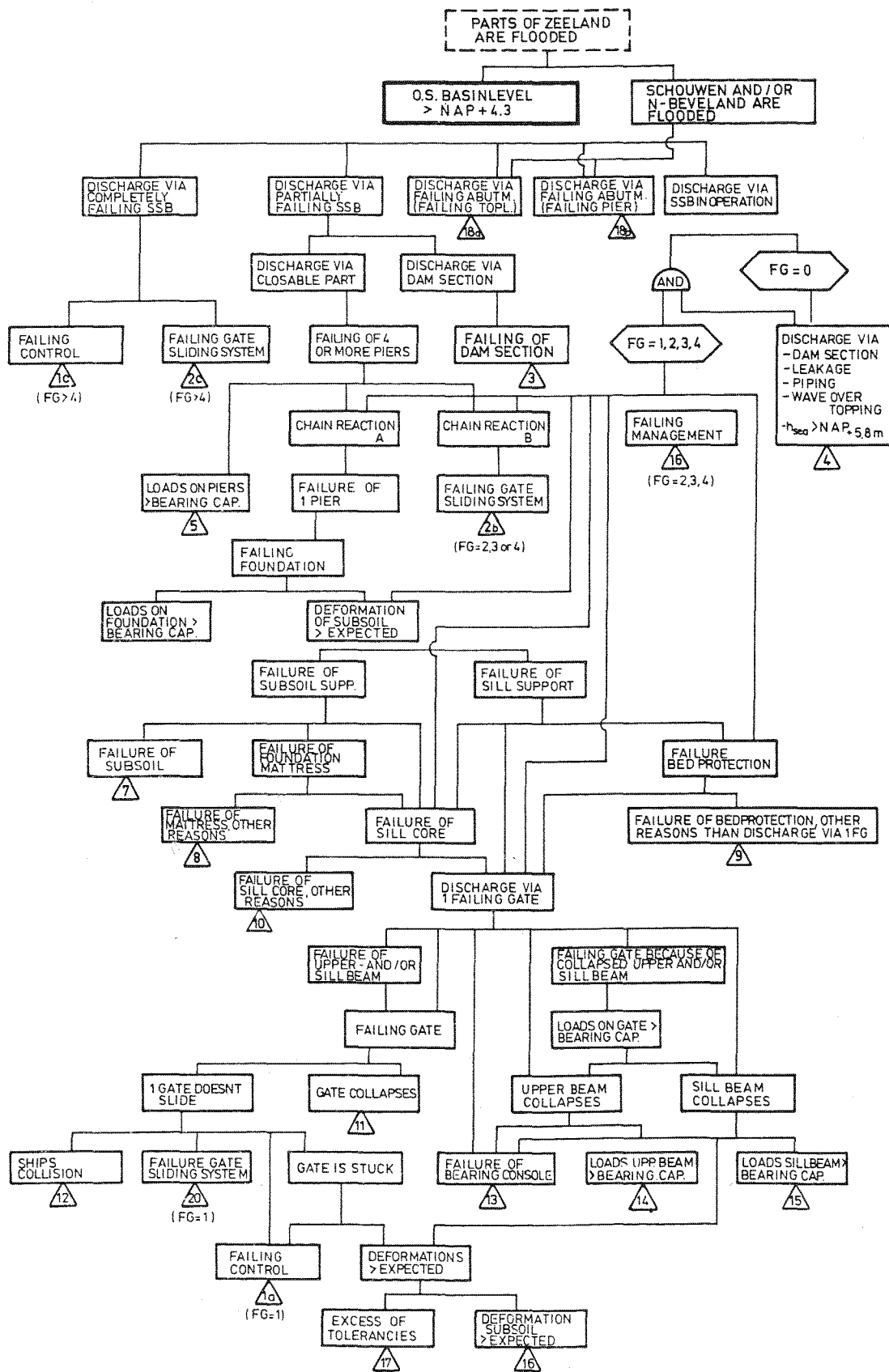

Fig. 2 The main fault tree of failure.

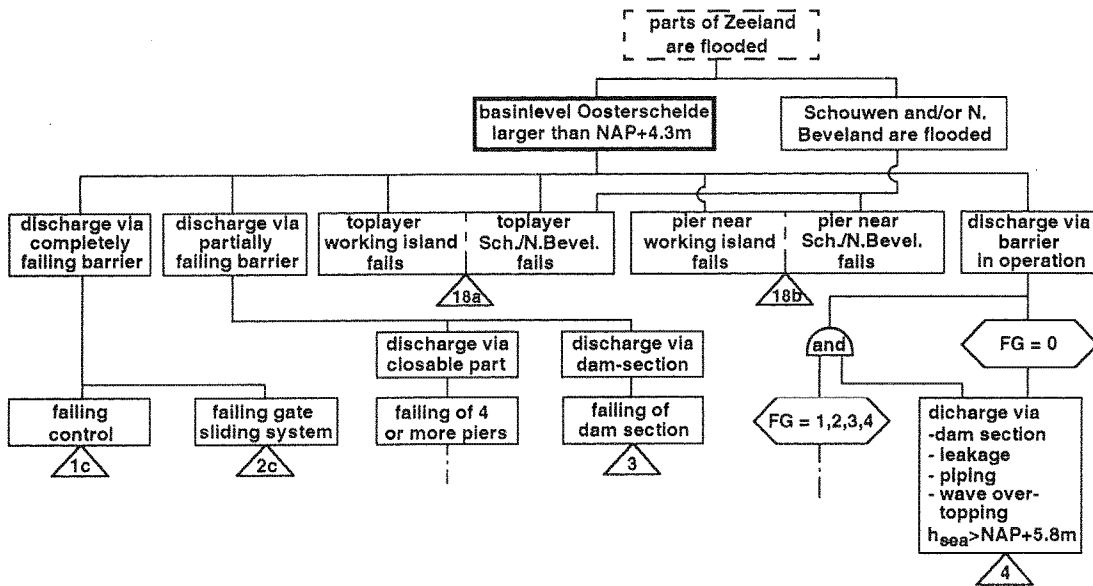

Fig. 3 Top of the 'tree of errors'.

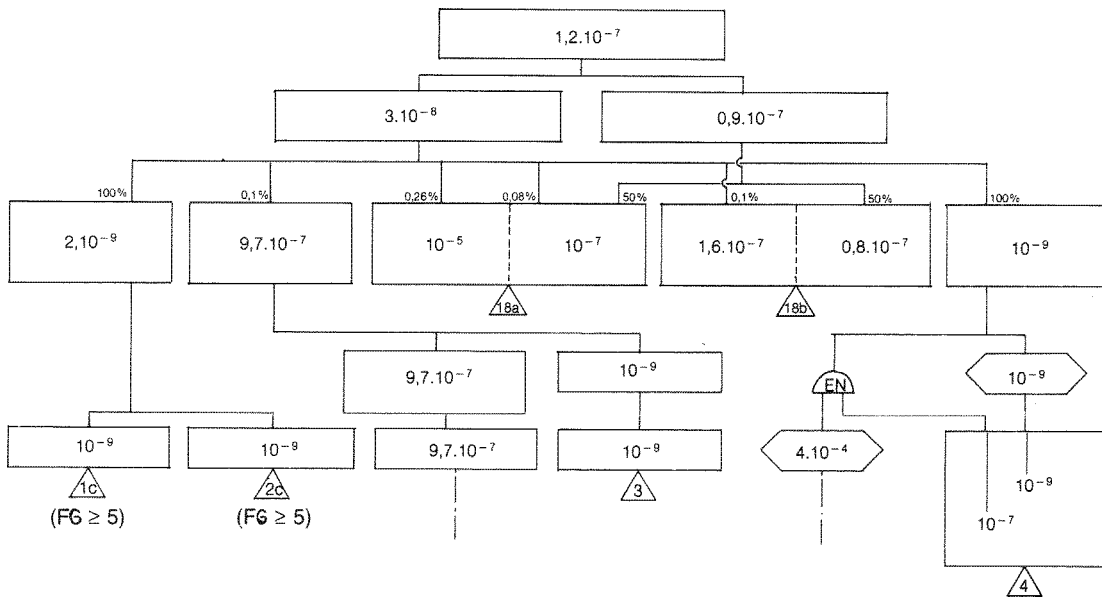

Fig. 4 Estimated probability of failure based on the average probabilities per initial event, according to Doc. 2, strategy: LWK closure; condition of failure: OS > MSL + 4.3 m. Note: MSL = NAP (in Dutch).

of exceedance of the maximum admissible Oosterschelde water level, are derived from, or also based on, Doc. 5 (see Table 1).

When the above mentioned changes in input are introduced in the top of the fault tree (see Figs. 6 and 7), it appears then that the total probability of failure becomes about 3×10^{-6} per year, almost independent of the closing strategy.

To this probability of failure, about 2/3 will be contributed by a combination of control failure, including automatic closure, and the supply of energy by the diesel power station and for about 1/3 through collapse of the dam abutments on the banks of Noord-Beveland and/or the Schouwen.

In view of the extremely low value the defect is, in relation to the

failure criterion (1×10^{-7} per year), too small to mention.

3.5 Probality of failure of the storm-surge barrier with a lower admissible water level in the Oosterschelde

In 1985, the BARCON study (see Part 5, Chapter 1) researched the safety of the entire system of the storm-surge barrier and the water retaining structures around the Oosterschelde, in connection with the choice of closure strategies. From this it already appeared that by an exceedance of the average water level in the Oosterschelde of MSL + 3.5 m certain water retaining structures could be flooded, and so following BAR-

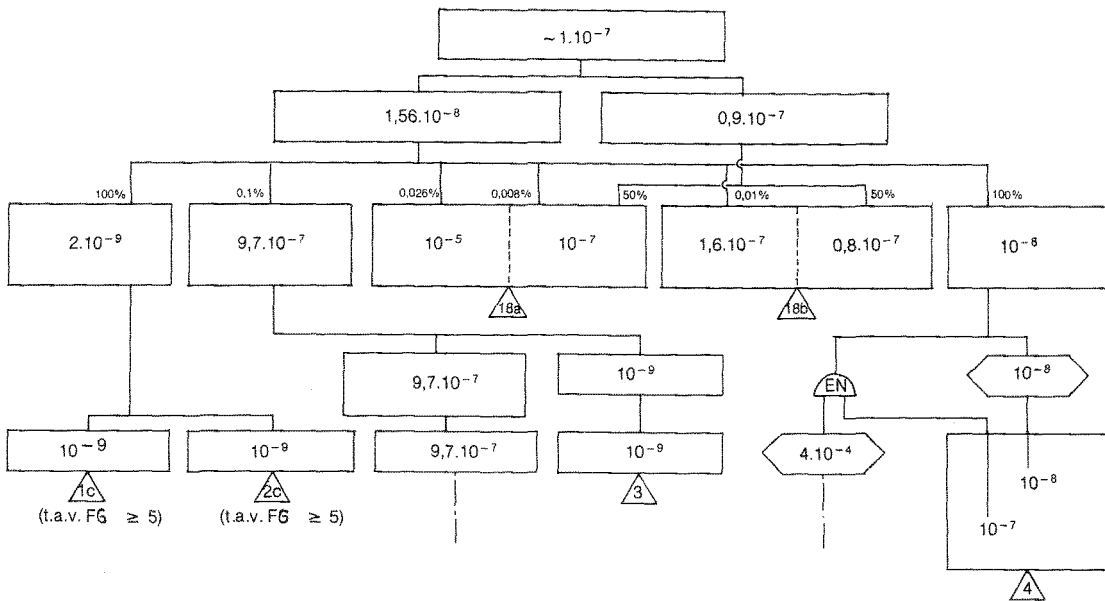

Fig. 5 Estimated probability of failure based on the average probabilities per initial event, according to Doc. 2, strategy: AP II closure (MSL + 3.25 m); condition of failure: OS > MSL + 4.3 m.

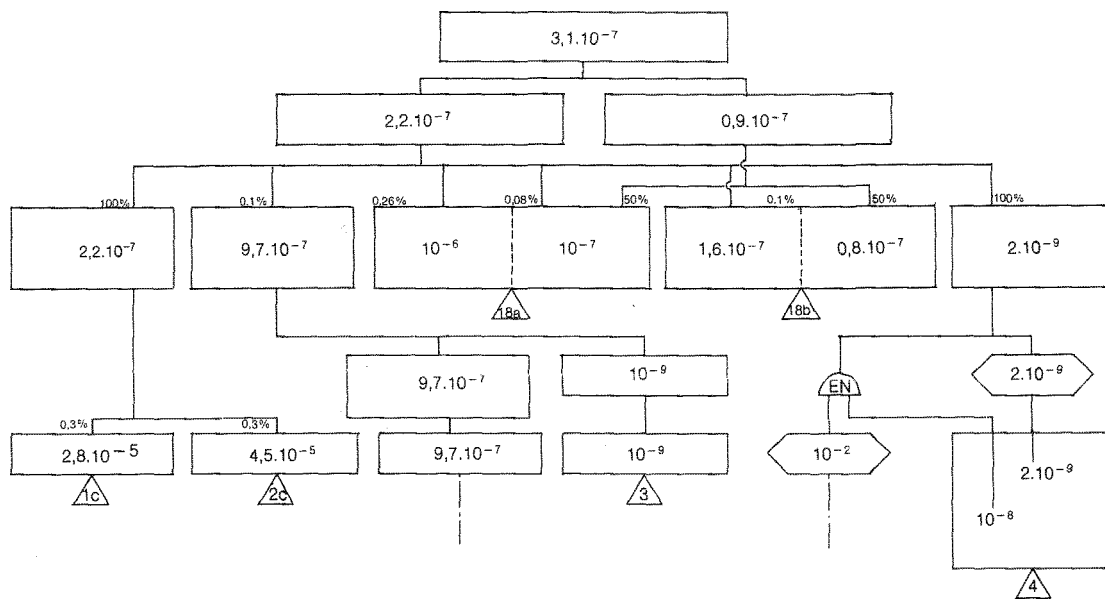

Fig. 6 Estimated probability of failure based on the average probabilities per initial event, adjusted input, closure: LWK; condition of failure: OS > MSL + 4.3 m.

CON's safety philosophy, a maximum admissible water level of MSL + 3.50 m was secured for the entire system. In this philosophy, which also considers collapse mechanisms for water retaining structures other than those relating to a maximum water level, a probability of occurrence of the most unfavourable event 'flooding of parts of Zeeland', smaller than $2,5 \times 10^{-5}$ per year was thought to be acceptable. This is in accordance with the safety philosophy for main water retaining structures in general, developed by the Technical Advisory Committee for Water Defenses (see Part 5, Section 1.2.1). As mentioned this data only became available in 1985, while the safety philosophy discussed in this Chapter on the barrier

itself (for the most part only) was developed in 1979. With this new data, the safety analysis of the barrier will have to be viewed differently. On the one hand, the criterion for the maximum admissible water levels in the Oosterschelde is increased, and on the other, the possible acceptable probability of failure for the barrier could be set higher than 10^{-7} per year, which means a lower criterion. In relation to this, it is important to check on how large the probability of failure of the storm-surge barrier becomes, when for the failure criterion 'by a discharge through the barrier the maximum admissible water level in the Oosterschelde is exceeded', instead of the previously used level of MSL + 4.30 m,

the level of MSL + 3.50 m is used for a standard operation. The lower admissible water level in the Oosterschelde has a big influence on the value of the operational transmission coefficients in the top of the fault tree. These were estimated once again on the basis of Doc. 5 (Table 1).

For the input 1c and 2c, the transmission coefficient becomes 6×10^{-2} or 6%.

For the input 18a and 18b, the transmission coefficients relating to the water level increase by a factor of 20 (with an AP II closure) to 100 (with an LWK closure), when, for that matter, the reasoning of Doc. 4 is followed.

Also, the influence of input 4 (leakage through barrier) increases.

In Figures 8, 9 and 10, the top of the tree of error has been quantitatively filled in for various conditions of closures.

The calculated change of failure then becomes:

LWK closure: 5×10^{-6} per year

AP I closure: 1×10^{-5} per year

AP II closure: 4×10^{-4} per year

With an LWK closure, the probability of failure will be almost

totally determined by the combined probability of control failure and a failure in the diesel power station, while with an AP I or AP II closure the probability of failure is increasingly determined by leakage through the barrier.

Regarding their contribution to the total probability of failure, the remaining possible causes for the failure of the barrier are, in comparison with the above mentioned possible causes, to be neglected.

This opinion leads to the conclusion that in spite of the unforeseen enhancement of the requirement for the admissible water levels in the Oosterschelde, the technical probability of failure of the barrier linked to this, is sufficiently low with regard to the safety criterion mentioned in the BARCON-philosophy, but that the choice of closure timing had a real influence on the probability of failure of the entire system.

Finally, it should be mentioned that the given data in this Section have to be seen as an indication, because the original probability of failure analysis (see Section 3.4) already indicated an accuracy margin of a factor of 10, and because 'quick' interpolations and extrapolations of data were applied here.

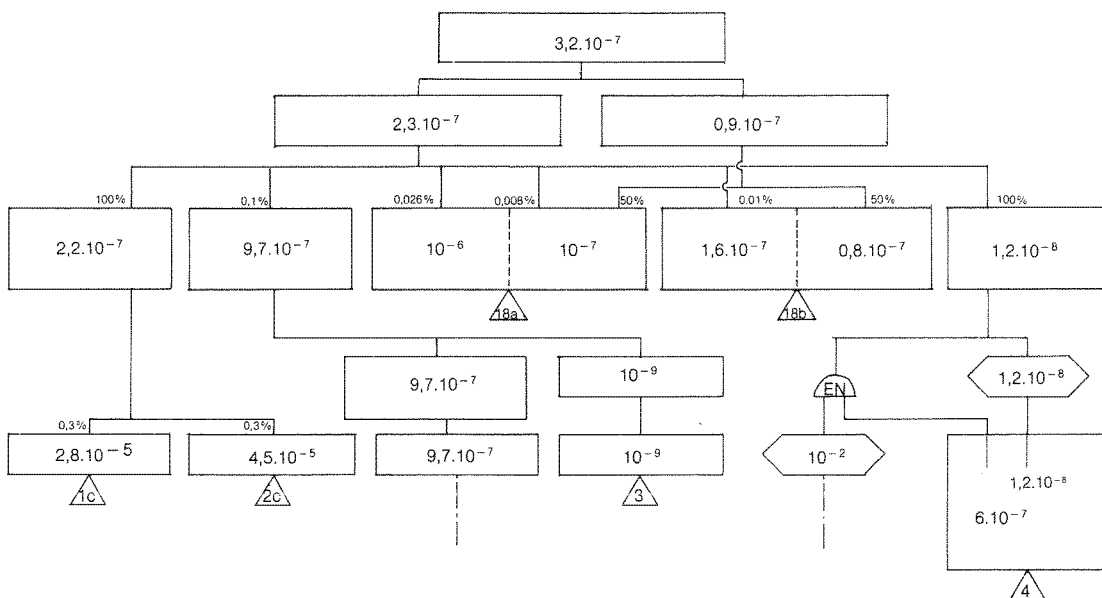

Fig. 7 Estimated probability of failure based on the average probabilities per initial event, adjusted input, closure: AP II (MSL + 3.25 m); condition of failure: OS > MSL + 4.3 m.

Table 2 Margins for the most important component processes in mm and mm/m.

	ΔX	ΔY	ΔZ	$\Delta\phi_x$	$\Delta\phi_y$	$\Delta\phi_z$
<i>Construction phase:</i>						
Pier fabrication	± 25	± 25	± 25	± 0.6	± 0.3	-
Gate fabrication	-	± 20	± 20	± 0.4	-	-
Laying of upper mat	± 1000	± 1000	± 95	± 9.3	± 3.7	± 20
Laying flagstones	± 1000	± 650	± 200	± 2.5	± 2.6	± 14
Placing piers	± 300	± 300	-	-	-	± 4.2
<i>End phase:</i>						
Soil deformations	0	± 45	+ 58	± 1.2	± 2.9	± 0.3
	+ 92		+ 95			
Washing out sand layers	-	-	± 50	± 2.8	± 1.4	-
Unbalanced operation	-	-	-	± 3.7	-	-

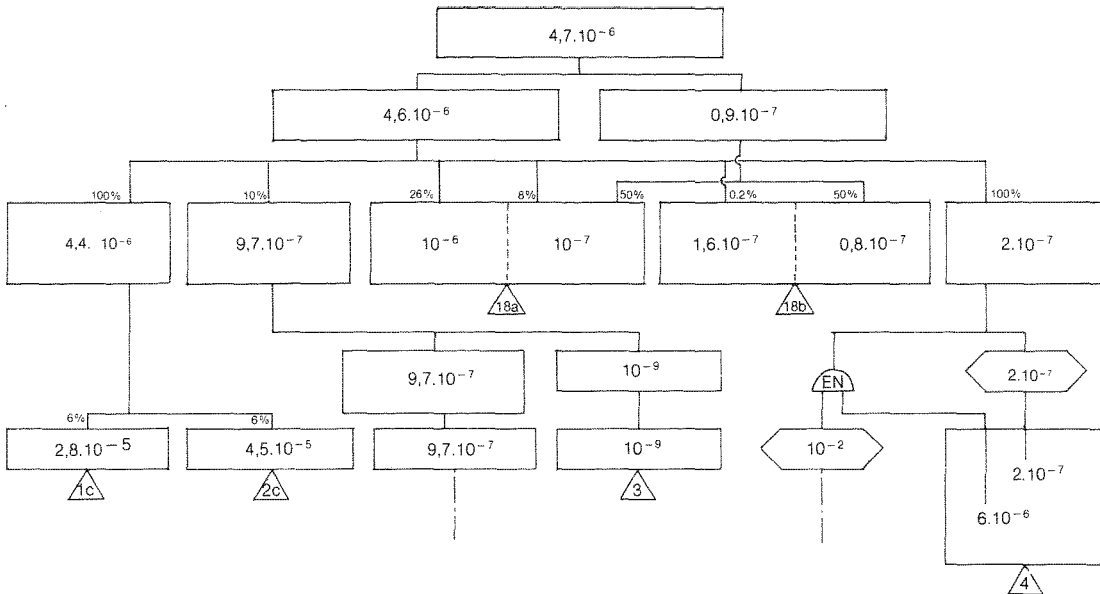

Fig. 8 Probability of failure of the storm-surge barrier, condition of failure: OS MSL + 3.5 m, closure: LWK.

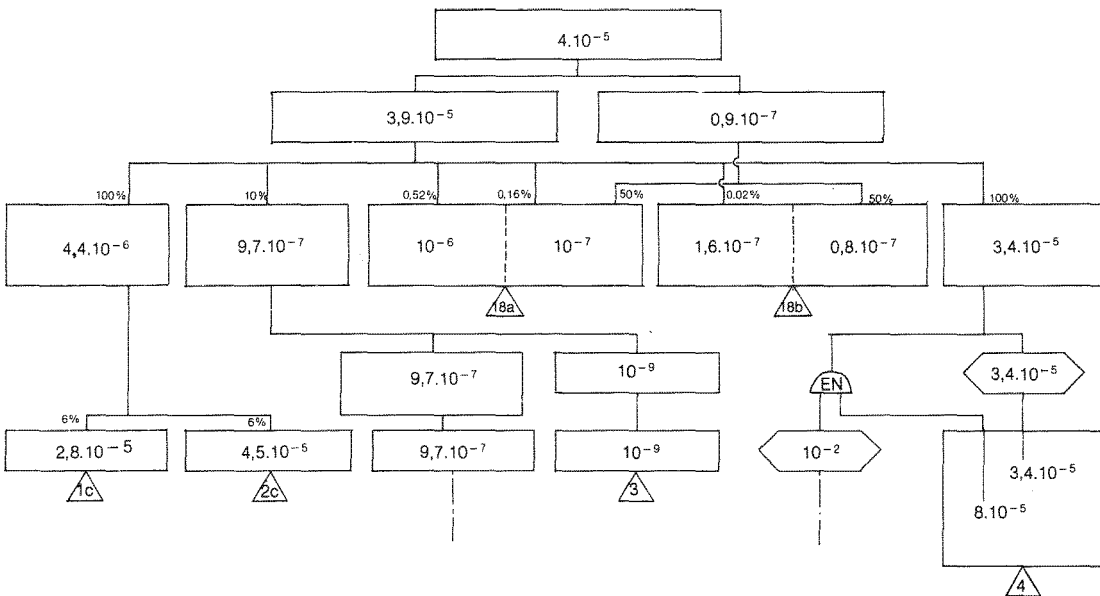

Fig. 9 Probability of failure of the storm-surge barrier, condition of failure: OS MSL + 3.5 m, closure: AP II (MSL + 3.25m).

3.6 The influence of leakage through the barrier on safety

The influence of leakage through the barrier together with the wave overflow of the water level in the Oosterschelde with a closed barrier should not be neglected.

It appeared in Section 3.5 that also in certain situations the leakage through the functional barrier is normal for the probability of exceedance level of MSL + 3.5 m.

These insights are based on calculations reported in Doc. 5. These calculations took into account discharge through wave overflow and discharge by leakage through the barrier.

In the 1978-1979 design, leakage was accounted for using a fictitious cross section of approximately 1200 m² (1345 m² without fouling, 1055 m² with fouling). From this cross section

950 m² consists of slits between the gates, on the one hand, and sill and upper beams, on the other hand.

The remainder (about 400 m² without fouling and 100 m² with fouling), was determined by leakage through the sill, wherein the slit between the bed side of the sill-beam and the upper side of the sill played a large part. This permeability of the sill is influenced in a significant way by the development over the years of the mussel fouling in its existing hollow spaces (see Part 1, Section 5.4).

Because of a certain amount of adjustments in the fictitious opening of the sill, this opening is, in the present design, estimated at 1350 m² without fouling and 320 m² with fouling. In the first case, the increase of the fictitious opening is about 1000 m², which is similar to two failing gates.

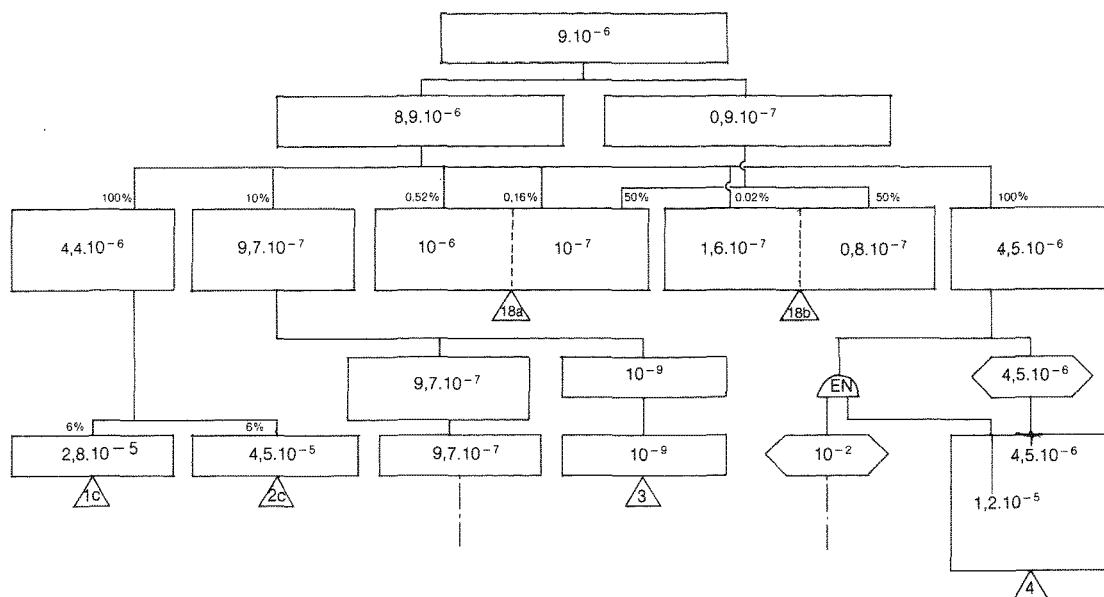

Fig. 10 Probability of failure of the storm-surge barrier, condition of failure: OS MSL + 3.5 m, closure: AP I (MSL 2.75 m).

The initial life span of the barrier, when the expected fouling has not yet developed, and also at a later stage when the expected fouling has unexpectedly not developed, or has developed to a lesser extent than expected, this larger leakage has an increasing effect on the probability of expected exceedance of the maximum admissible water level in the Oosterschelde.

For the level of MSL + 3.50 m the probability of exceedance, using an AP I closure, becomes 4×10^{-5} and 2×10^{-4} per year using an AP II closure at a working barrier. In accordance with the conditions made in Section 3.5, an indicative value has to be given to these numbers.

When fouling develops according to the expectations, then in a few years time, the increasing effect of the larger leakage opening will have almost disappeared.

Documentation

- 1 Kooman, D.: The acceptable probability of failure of the SVKO, Risks accumulation; notitie deltadienst DDWT-79.251 of PEGEOO-M-79205, 15.3.1979
- 2 Breukel, A. van den; Kooman, D.: Chance of failure analysis of the storm-surge barrier in the Oosterschelde, TNO-IBBC, report nr: B-80-62/62.3.2002
- 3 Anonymous: Retaining heights at Damvak Geul and at outer harbour Neeltje Jans, Rijkswaterstaat Deltadienst Project or-

ganisatie Stormvloedkering, 2 PROBU-M-84080, 12.9.1984, with appendix

4 Klopper, J.W.: Risk analysis of dam abutments, Deltadienst, DDWT-80.125, 10.1.1980

5 Kooman, D.: Probabilities of exceedance of hydraulic heads and water levels at the storm-surge barrier in the Oosterschelde; Rijkswaterstaat Deltadienst, DDWT-79.016, July 1979 with appendix

6 BARCON project, part report: Safety aspects of management of the storm-surge barrier in the Oosterschelde (concept); Rijkswaterstaat Directie Zeeland, Middelburg, May 1985

7 Horst, J. van der: Chance of failure analysis of the operational system of the storm-surge barrier in the Oosterschelde; TNO, Hoofdafdeling Maatschappelijke Technologie, Werkgroep Industriële Veiligheid, afd. Systeemanalyse en Technologie, ref. nr: 78-04891, 17 March 1979, also known as Deltadienst Project organisatie Stormvloedkering, SOCCOO-N-79272

8 Otterloo, R. van; Hortensius, J.: Analysis of the operational system for gates in the storm-surge barrier of the Oosterschelde (2) KEMA report nr: WSK/30125-1, May 1984 Partial review by Directie Bruggen, Rijkswaterstaat.

9 Houben, R.: Probability of failure analysis of storm-surge barrier, mechanism 'discharge through open gates'. Rijkswaterstaat, Project organisatie Stormvloedkering, 13 November 1985, UMGEFO-M-85021

4 Important choices for the design

During the design process, a significant number of choices had to be made from possible alternatives.

Most of the choices were related to the shape of various details of the design.

Some of the choices, however, were of such a nature that they were decisive for the conception of, in particular the movable part of, the barrier.

This chapter discusses these choices. Choices made in the preliminary study will not be discussed, because these have been extensively reported on in Doc. 1. Some of the to be dealt with choices in this chapter have been mentioned earlier in this design plan (Part 1, Chapter 4, Part 2, Chapter 1). For the sake of completeness they are mentioned here again.

4.1 Foundation subsoil

One of the most important choices in the design process was the choice of adjusting, as well as possible, the mechanical qualities of the foundation subsoil to fit the demands made on it by the construction components which had to be placed on top of the soil. Because of this, foundation structures for the piers which penetrated into the firm layers became superfluous and the piers could be founded directly. This choice was made possible because of the development of a technique for compression of the soil at depth. Bed material which could not or hardly be compressed could be replaced by material (sand) that could be compressed more easily.

A further improvement was achieved by adapting the geometry of the foundation subsoil to the design (embankments in the deepest parts of the flow channels). On the one hand, the maximum height of the piers could be limited and on the other, the pier design could become more uniform.

4.2 Prefabrication

Because of the discussed improvement of the foundation subsoil, complete prefabrication of the pier, in principle, became possible. Also the pre-fabrication of the components as one of the starting-points for design and construction was introduced.

The philosophy behind this was to take away as much activity as possible from the influence of circumstances on the construction-site (currents, waves, wind) so that various risks could be limited. Aspects of prefabrication are further discussed in Chapter 5.

4.3 Choice of materials

The requirement that the storm-surge barrier has to have a

life-span of 200 years has been an important guide in the choice of materials.

Where possible, natural materials with a long durability (sand, gravel, rubble) were applied. The rubble (basalt and granite) is selected on its specific gravity and durability.

Prestressed concrete was chosen as construction material for the construction elements which, to a greater extent, are very difficult to replace (such as piers, sill beams etc.).

Although approximately 60 years of experience exists with this material, results from specific concrete-technological research showed that these constructions could be designed and constructed in such a way that the quality thus achieved gives enough guarantees for a long life-span (see Book 3 Concrete Constructions).

Steel was chosen as the material for the gates. The low dead load of constructions made of steel settled the matter. And besides, these components are in principle replaceable and can be reached for maintenance.

The utilization of artificial fibres with a continuing function in the construction has been avoided as much as possible, because of the uncertain life-span of these materials. An exception to this is the utilization of the so-called geotextile from polypropylene material for the bed protection. The reason for this was that large parts of the bed protection had already been placed (with a then provisional function) in the frame-work of the original plan of a total closure of the Oosterschelde. For the remaining part, measures were taken to improve the durability, but it is not yet known if they will be sufficient. For further elaboration on these problems see Book 2, Chapter 10. Anyway, the bed protection is replaceable.

4.4 Single or double barrier

Although a double barrier is not unusual for such a construction (Spuisluis Haringvliet, Stormvloedkering Hollandse IJssel) in this design a single barrier was chosen.

A more detailed analysis of the possible causes and consequences of a failing gate (see Doc. 1) showed that on the one hand a double construction would give a relatively small increase of reliability and on the other that a failing gate would only slightly affect the retaining function (see Chapter 3).

Besides the investment of an extra set of gates and operating machinery, a double barrier would also require a significant increase of investment in the piers.

The final conclusion was that the significant extra costs for a double barrier would not result in more reliability. It appeared to be more profitable to direct all efforts towards the maximum dependable construction of a single barrier.

4.5 Choice of operating machinery for the gates

In principle, two systems were possible for the operating machinery of the gates:

- An electro-hydraulic system based on the possibility of hydraulic cylinders;
- An electro-mechanical system in which gear racks and pinions are used.

Neither of these systems used counterweights, so the full weight of the gate had to be carried by the operational machinery.

The moment the choice was made, a basic design was completed for both systems. A further elaboration was necessary because, amongst other things, not all the loads on the gates were known. In connection with the available preparation time a definite choice between the systems could not be further postponed.

The following aspects of both systems were looked at:

- Progress of the design;
- Reliability;
- Constructability;
- Maintenance;
- Planning;
- Costs;
- Aesthetics.

In the total examination both systems were practically the same. Differences in estimates, which were alternatively to the advantage of both systems, were differences in nuances.

Finally the hydraulic system was chosen.

Important arguments for this choice were given:

- That the probability of problems and the consequences of costs estimated would be smaller for the hydraulic design;
- That the better possibility for constant guarding of the situation from a distance with the hydraulic design would improve management of the barrier, which would have repercussions on reliability and maintenance;
- That the hydraulic system would fit aesthetically better in the entire system of the storm-surge barrier and it is anticipated that it would cause less wind hindrance for the adjacent car and maintenance roads than the mechanical system, because the latter would lead to more mass units on the piers.

Documentation

Section 4.4

1 Spek, H.: Influence of a failing gate of the storm-surge barrier on the water level in the Oosterschelde basin. Rijkswaterstaat Deltadienst, nota DDWT-78.005 or PEGEOO-N-78200, February 1978

Section 4.5

2 Remery, F.J.: Choice of type of operational machinery, Projectorganisatie Stormvloedkering, 64 BEWO-N-80023, 23 September 1980

3 Anonymus: Choice of type of operating machinery SVKO. Projectorganisatie Stormvloedkering, PB VI, 6 PROBU-M-80213, 10 October 1980

5 Prefabrication and problems of deformation

The idea of prefabrication has been mentioned before in Part 1. An important part of the argument in favour of prefabrication of the components for the storm-surge barrier, is mentioned in Chapter 1 of this Part plan. In this chapter, these arguments will be listed again, the chosen classification of (concrete) elements which are to be prefabricated will be further illustrated and attention will be given to the problems of deformation connected with prefabrication.

In general prefabrication means that:

- The production of components is removed from the construction site to a place where better control of the circumstances and/or better production facilities are available. Because of this a qualitatively better product can be made and costs can be cut, especially when there is mass production;
- The production of components will be decentralized and therefore can take place in parallel without difficulties, which significantly shortens the construction time on the construction site;
- Within certain limits every component can be independently designed.

With fabrication, clear agreements need to be made regarding the adjustment of the boundary conditions, whereby the measurements of the components is an important element because the components on the construction site need to fit each other literally like a box of bricks and the possibilities for correction of measurement defects in general is very limited.

When constructing the storm-surge barrier, in particular the circumstances relating to the three flow channels, where the movable barrier had to be placed, it was extremely difficult to construct a structure with such large dimensions. In the constructions that had to be made the repetition element was ever

present. A relatively short realization time was one of the most important boundary conditions of the entire project. Because of this, especially for the construction work on the movable barrier it was decided, in principle, to prefabricate labour intensive components on which qualitatively high demands were made. This particularly applies to the concrete components, in spite of their heavy weight. With regard to steel, mechanical and electro-technical components, it was almost self-evident that these would be prefabricated in other factories. The components for the movable barrier which were to be prefabricated, were: the piers, the sill beams, the upper beams, the traffic boxes, the hammer parts and the gates with their operating machinery (see Fig. 11). The granular filter constructions which were necessary to stabilize the easily eroded subsoil were also prefabricated in the form of filter-mats because they were too vulnerable for construction on the construction site.

Characteristic of this arrangement is the fact that the components predominantly fit each other loosely; which means that the connections can mainly transport shear forces with almost no bending moments. As a consequence of this, the internal resistance of the construction against deformations forced from the outside (settlements in the subsoil), is small or the reverse: the entire formation is mainly derived from the formation of the foundation subsoil.

The choice of the classification mentioned of the (concrete) elements to be prefabricated, was not self-evident. In principle there were two alternative possibilities, the following explanation will make that clear.

The movable part of the storm-surge barrier is constructed with a large number of sections with a fixed and a movable component. Upper beam, sill beam and pier form the fixed component (schematically outlined in Fig. 12).

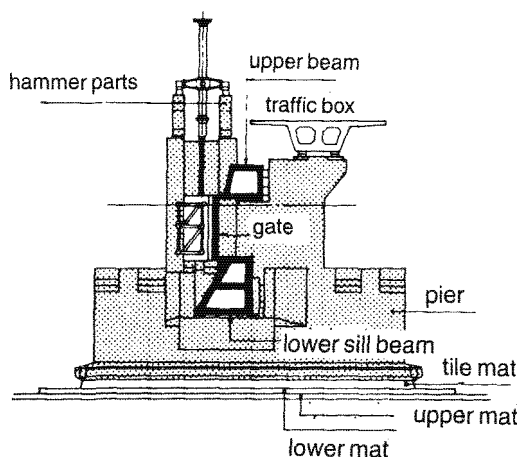
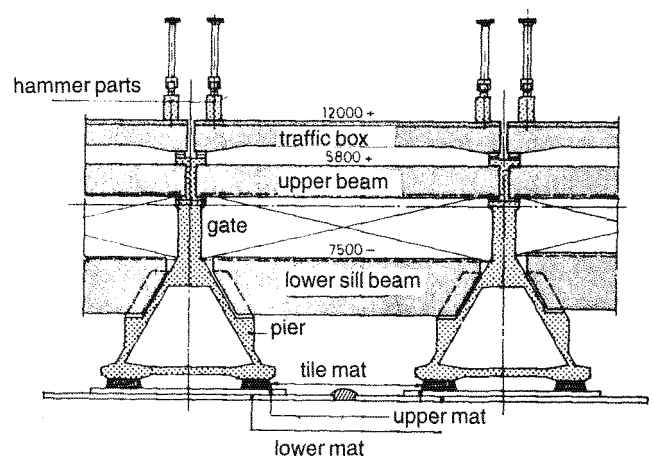

Fig. 11.



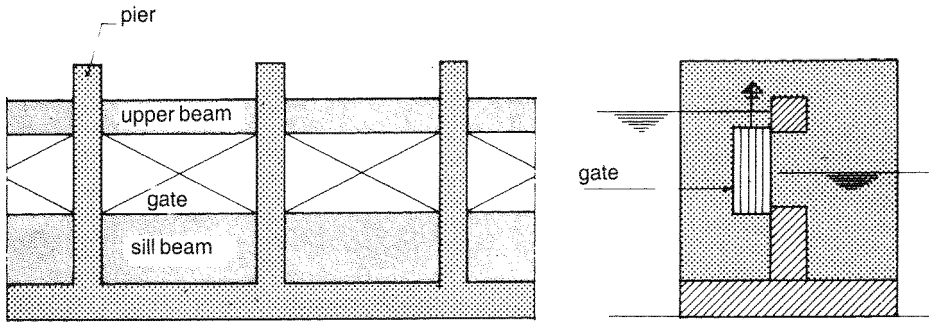

Fig. 12.

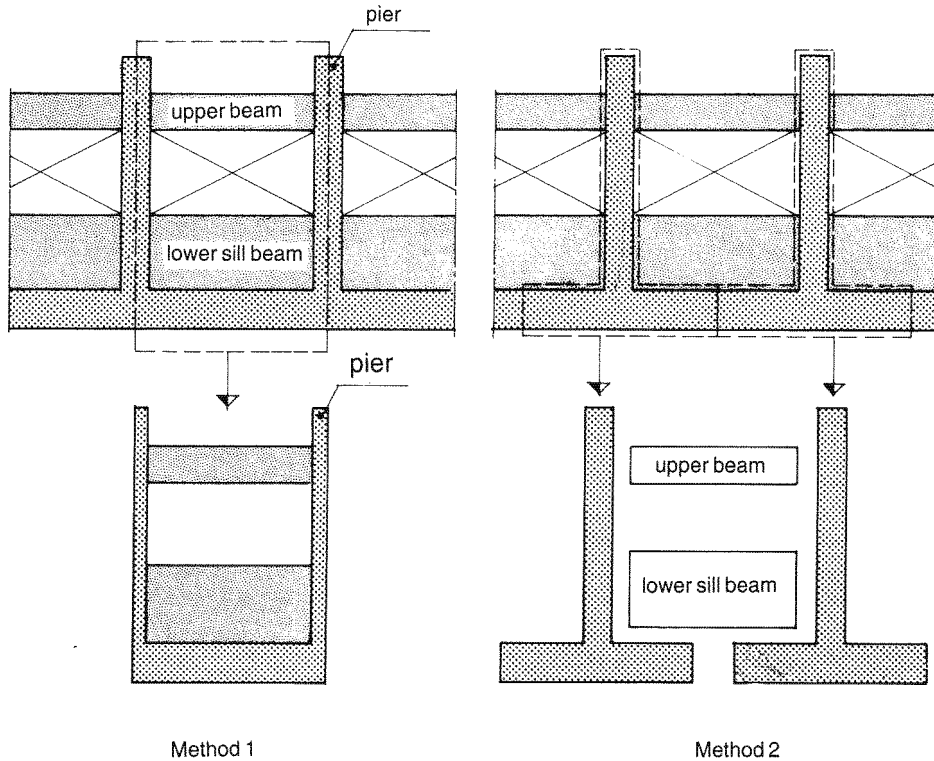

Fig. 13.

When subdividing into prefabricated construction components, roughly two methods can be used (see Fig. 13).

Method 1 takes the view that the fixed component of every section is prefabricated in a fixed frame form and will be placed in the closure gap as a unit.

Method 2 takes the view that the fixed components of every section will be prefabricated as separate posts (piers) and lines (upper beam, sill beam), and will be fixed together in the closure gap.

It will be clear that Method 1 is preferred, if attention is only given to fixing and measurements relating to the movable components. A dimensional variation in the placing of the frame and the unevenness of the foundation will not influence play between the gate and the pier and therefore will also not influence the operating possibility of the gate. The contrary happens in the case of Method 2 (see Fig. 14), where play between the upper beam, sill beam and pier will also be influenced.

In the preliminary design stage, Method 1 was one of the alternatives. This method, however, requires large units (caissons). The foundation problems and the costs connected with this method were the most important reasons for dismissing it. In Part 1, Chapter 4, the development leading to the concept according to Method 2, has already been outlined. The choice of Method 2 means that the composition and the functioning of the barrier is strongly dependent on the measurement deviations set and precisely detailed connecting points.

Besides all the advantages of prefabrication, it appears from this that form-fixation is an important problem and can be subdivided into:

- During assembly reproduction of the desired precision of the designed measurements, and
- The possibility of deformations occurring during the life-span.

It appears from Figure 14 that deviations in the position of the

piers are critical to the entire shape. On the other hand, the allowance for deviations is limited by the fact that the gate must be able to slide in the guiders, which are situated in the piers, and the constructive possibilities of gates stops and guides. Besides all the other possible measurement deviations these two elements mostly determine the entire problem.

In a further analysis of the form-fixation problem, this can be subdivided into:

- Tracing the causes which influence the fitting of components;
- Establishing the initial points in the composition and examination of measurement deviations;
- Establishing the tolerance limits;
- Determining the influence of measurement procedures and sequence of construction;
- Establishing test procedures during construction;
- Make an inventory of measures to counter unforeseen setbacks.

These points will not be dealt with extensively. A few remarks will be sufficient.

Measurement deviations can be caused by:

- Deformations in the foundation subsoil, during the construction as well as during the lifespan of the barrier; which can be further subdivided into:
 - * Deformations of the subsoil, depending on the composition of the soil and the extent of compression in relation to the occurring loads;
 - * Deformations of the foundation bed (filtering mats) caused by possible washing out of eventual sand deposits trapped between the mats and/or between the upper mat and pier during construction;
- Measurement deviations resulting from limited accuracy of the applied operation and manufacturing techniques. Especially the accuracy of the surface dredging of the supporting surface of the foundation mats underneath the pier and the technique used to place the piers was important here;
- Limitations in the accuracy of the applied measurement techniques, particularly in locating positions above and below water;

- Limitations in the control of the gates principally by the independently operating mechanisms on both sides of a lock.

The possible performance of all deformations and measurement deviations is extensively analysed and quantitatively estimated as well as possible.

It was assumed that the actual deviations performed would normally be around a certain average, of which the differential (tolerance capacity) would have a reliability limit of 95%.

The measurement deviations were composed according to the rules of probability and passed on to the critical points in the composition of the components.

The above mentioned critical points were:

- The position of the foundation mats in relation to the desired position of the pier;
- The connection of the beam sill, upper beam and traffic box to the pier;
- The stops of the gates and the gate guides on the pier.

To limit the necessary tolerance capacity, the possibilities of improving the applied operations and measurement techniques were looked into. This particularly applied to the surface dredging of the foundation subsoil underneath the pier and for measuring and placing of the piers.

To further decrease the tolerance range, arising from production possibilities of the critical points mentioned earlier, the possibility of applying measurement corrections during construction were looked for in the design.

In this way the so called 'tile mat' was designed, to compensate for possible irregularities of the foundation bed. In the design and production of the beam sills, upper beams, traffic boxes and gates, the possibility was created, after the placing of the piers phase, of adjusting mainly the length to the realised position of the piers where they had to come between.

All the brief analyses, considerations and measures taken, mentioned above resulted in the composition of extensive tables with tolerance ranges to which components and certain phases of construction had to comply. Also mentioned in the tables were the available tolerance measurements for deformation of the whole construction during its lifespan.

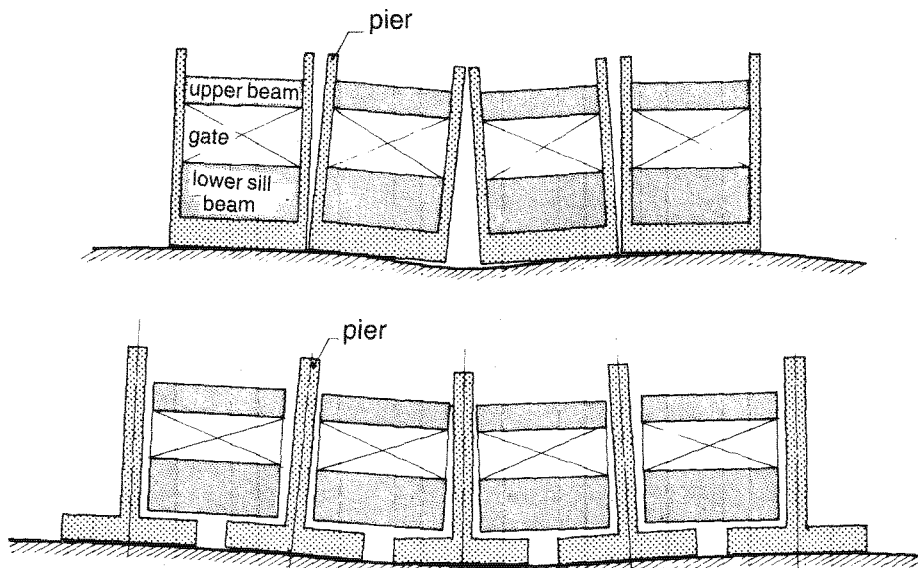

Fig. 14.

Table 2 indicates the most important tolerance capacity. It refers to coordinate axes per pier, of which the z-axis is the vertical and the y-axis is the longitudinal axis of the gate. In addition to the testing-norm for production and construction, tolerance data were also used as conditions for the detailed

design of various mutually connecting points of the prefabricated components.

In this way all measurement uncertainties were divided as equally as possible over the entire construction, and the risk of unacceptable measurement deviations in the final result was kept to a minimum.

6 The probability in the design

6.1 General overview

Designing a civil construction means, for an important part, dimensioning of components in such a way that they can resist maximum future loads. By means of static (or even dynamical) calculations the loads on a construction are determined.

To be able to achieve a safe construction four calculation methods are known.

The pure determining method was used in the past. With this method, loads which could not be determined exactly were introduced as estimated standard loads.

Dimensioning of the design occurred on the basis of a fixed admissible load.

With this method, the safety of the design was determined by the extent to which the loads were pessimistically estimated and the margin between the admitted loads and the real strength of the applied material. A real insight into the failure probability was not given.

This method is no longer in use, because it was recognized that in relation to the safety of a construction, it is more important to consider the margin of failure. This margin is usually bridged by a 'safety-coefficient'.

The so-called quasi-probabilistic method introduces unfavourable characteristic values of loads and qualities of material, which have a limited change (mostly 5%) to stay below or exceed the limit. A set requisite value is used for the safety coefficient. Currently this is the accepted consideration of safety for civil constructions (see construction standards NEN 3850, NEN 3851, NEN 3861). Although a better account is taken herein of the various loads and material qualities this method is nevertheless mainly deterministic and only gives a limited insight into the real failure probability. With a constant safety coefficient, the variation coefficients of loads and strength influence the failure probability (see Doc. 1).

A better insight into the failure probability is given by the semi-probabilistic method, which leads to an acceptable probability of failure of the future construction. Taking into account the variation coefficients of the loads, the schematization necessary for the design (calculations, models, etc.) and the material qualities, a separate safety coefficient is fixed for these three groups. Usually a coefficient for overloading is added. For the rest, this method is the same as the quasi-probability method.

The fourth method is the pure probabilistic method. In this method, the density of the probability functions relating to the loads and strength qualities of every relevant component of the construction, according to the rules of the theory of probability, are combined into a failure probability for that component. The whole construction is systematically checked, with the help of a logical tree of events to see which initial events (component failure) could lead to the collapse of the entire construction.

These initial events are related (with the help of a tree of errors) to the final event (the collapse of the whole construction). Then again, according to the rules of the theory of probability, the combined probability of occurrence of the initial events is transferred to the probability of occurrence of the final event. This last probability can then be checked against an accepted norm (see Chapter 3).

The probability density functions (p.d.f.) relating to the loads on the component are determined by the p.d.f. of the environmental boundary conditions which determine the load and the p.d.f. of the correct transfer functions which relate these boundary conditions to actual loads.

The p.d.f. relating to the strength of the quality of materials, the quality of models used to determine the strength of the components, and the quality of construction are of importance to the strength of the entire construction. This method assumes that all relevant data is known and proceeds from an actual design. This last method has a retrospective character contrary to the three methods mentioned above which could be called constructive.

It is almost impossible to apply the fourth method on its own, but it gives the most realistic insight into the real probability of collapse.

In civil engineering, the four above mentioned methods are mainly developed for use when designing concrete and steel constructions.

They are rarely used in soil mechanical or hydraulical designs (for example bed protection). Those types of designs have a different design procedure and a much more empirical approach. The safety philosophies normally used for those designs are totally different from the ones normally used for concrete and steel constructions.

6.2 Applications of probabilism in the design of the storm-surge barrier

As a whole, the storm-surge barrier is a hybrid construction; which means that its components belong in various disciplines of civil engineering, namely; typical hydraulic, soil mechanical, concrete and steel constructions. This applies especially for the movable part of the barrier in the three channels which received special attention.

In the overall construction, the components function more or less independently from each other, but in the movable barrier, the components are correlated and form one working system (see Chapter 2). Because the components were designed from different disciplines, there was the danger, in particular for the movable barrier, that different safety philosophies would be employed in one system which would be inconsistent with an attempt for a balanced design.

The working group Design and Methodology (DM) was established to study the problem and to find a solution (see Part 1, Section 5.2.2).

A solution was found in approaching the design problem, for the most part, by following two strategies to which a third one was added for a few components (Doc. 2-5).

The first strategy (called 'line A' by the Project group) is the semi probability approach, applied as much as possible in the various design disciplines. This approach led to an actual design for the relevant component.

The second strategy (line B) is the pure probabilistic analysis derived from the designs of line A. In a fault tree the probabilities of collapse were quantitatively filled in and combined with the quantitative probability of other possible causes of failure of the entire barrier, combined towards a total probability of failure. This formed the analysis of the total probability of failure of the entire barrier already dealt with in Chapter 3. The third strategy (line C) was an economical optimization of the design. This method included, besides elements from line B, also the provision for the economical optimum between initial investments and the capitalized expected damage during the life expectancy. With the help of these calculations, one could consider if a small amount of extra investment would produce relatively more safety.

6.3 Further elaboration of strategies

6.3.1 Limit states

A central starting point for the design of the barrier and its components, according to the strategies A and B, was to determine the critical limits standard for the various components. An extensive inventory and description of limit states was created for the storm-surge barrier (see Doc. 6).

The limit state of a component can generally be defined as: 'The acceptable limit of a component's behaviour (predicted by the design process) in certain situations (load condition)'.

The description of the acceptable limit state includes the functional demands made on the component.

In terms of load and strength, the limit state can be defined as: 'The condition of a component in which strength and load are balanced'.

The failure probability of a construction component is the probability of exceeding the critical condition by more load or less strength.

The first definition is more general than the second one, though not all the acceptable limit states are linked to failure. For example, the concrete constructions were, except for strength (= failure), also designed for the required life span of 200 years.

Acceptable behaviour was noted as: Such a form of cracking that does not yet cause danger of corrosion of the reinforced steel (see also Book 3).

With regard to the design, the description of the relation between load and strength is decisive in the second definition.

Elements of this description can be represented in scheme I if, on the basis of theoretical and practical knowledge, this relationship can be completely and analytically described. This is usually the case with concrete, steel and soil mechanical constructions.

Regarding the strength aspect of the erosion-resistancy of hydraulic constructions made of granular materials, (bed protection, top of the sill and a rubble dam), an analytical description of the relationship between load and strength is not possible and has to be established using (scale-)model experiments. The elements of the description of this relationship can then be represented in accordance with scheme II.

6.3.2 Strategy line A

In this strategy the limit state of the design was, according to scheme I or II, defined in a deterministic way.

The possible spreading of the probabilities of failure (uncertainty) in the various elements (especially relating to the bearing capacity) was taken into account by means of partial safety

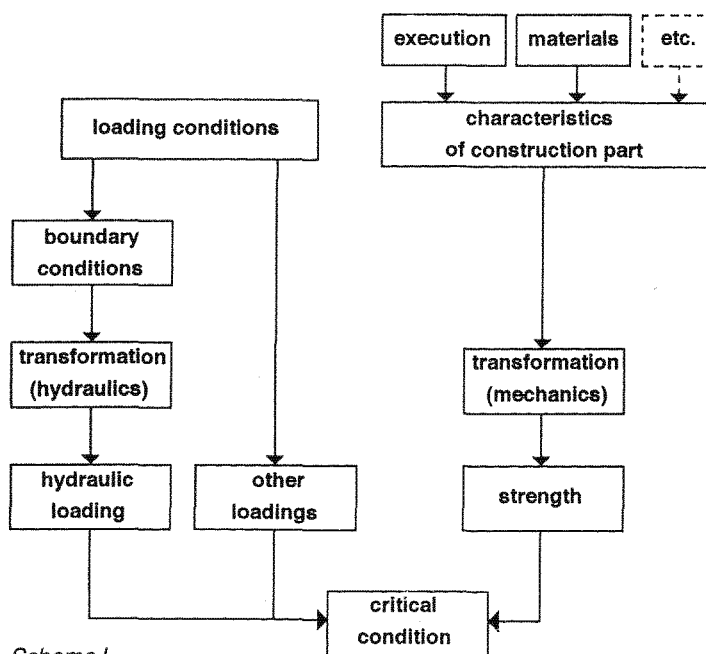

Scheme I

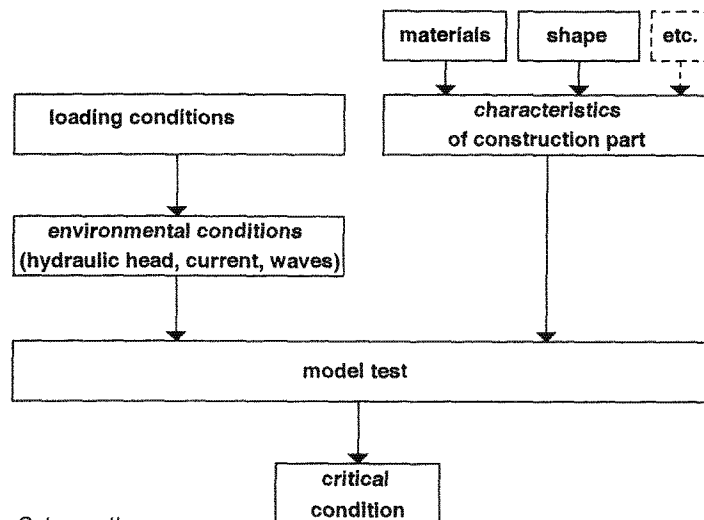

factors, adjusted to the acceptable probability of failure. Establishing the partial safety coefficients was the subject of extensive research, concentrated on the concrete conditions of design and construction of the storm-surge barrier, observing the directives in ISO 2394 (Doc. 7).

Although the Dutch construction regulations relating to design and construction of the storm-surge barrier mention safety coefficients, there were no directives available for soil mechanics and hydraulic engineering. Research was also necessary to guarantee that the safety concepts in the various fields would be managed in a similar way. From this research, the following characteristic safety coefficients were established for the various design fields:

Concrete – 1.4

Steel – 1.2

Hydraulic structures – 1.5

Soil – 1.4.

With regard to loads, the given data of the environmental conditions were transformed probabilistically for ruling combinations of the various components (see Part 3).

For vital components, relating to the failure of the entire barrier, these combinations had a probability of exceedance of $2,5 \times 10^{-4}$ per year, and the loads resulting from this were regarded as extreme loads (Q_e) to which no overload safety coefficient was applied.

For non-vital components and for the estimate of the life span of concrete constructions, combinations with a probability of exceedance of 10^{-2} per year were used as starting points. Loads resulting from this were considered to be characteristic loads (Q_k) to which generally a safety coefficient was applied for an overload of 1.2.

For the construction-phase loads, decisive for the design (see also Chapter 2 and Part 1.3), higher probabilities of exceedance were estimated for the characteristic loads (depending on the duration of the construction phase).

6.3.3 Strategy line B

As mentioned in Section 6.2, the total probability of failure analysis, dealt with in Chapter 3, is an important part of the line B strategy. One could even say that this is an essential part of the strategy, because it includes all causes of failure considered possible, and from this it can be derived to what extent the probability of a certain trigger-event influences the proba-

bility of the worst possible event and the balance of the design can be judged.

The failure of components of the barrier are, amongst others, the initial event entered into the fault tree which serves as a basis for the probability of failure analysis.

The probability of failure was quantitatively entered into the fault tree with the probability of influencing the logical sequence of events.

First of all a tree of events was set up relating to an exceedance of the limit state in which all possible logical sequences of events were collected. From this tree of events components were taken which led to the worst possible event, and were put into the fault tree of the total probability of failure analysis.

The probability of exceedance of the critical situation calculated per component, originated from a design made according to the line A strategy.

The probability density functions of the elements from the description of the limit state were combined (Scheme I and II of Section 6.3.1) according to the theory of probability and the probability of failure.

The pure probabilistic probability of failure was only calculated for the most important components of the barrier, because for scheme I it meant a large number of calculations, and for scheme II it meant a large number of model experiments.

At first instance probability density functions relating to the quality of the construction were calculated with the help of estimates. At a later stage these probability density functions were checked using construction experience.

These probabilistic calculations were carried out for:

- The main section of the pier;
- The stability of the pier;
- The sill beams;
- The upper beams;
- The main girder of the gates.

Also on the basis of (scale) model experiments these calculations were carried out for:

- The surface layer of the sill and the rubble dams;
- The transition construction between sill and apron;
- The bed protection, particularly in the vicinity of the barrier on the side of the Oosterschelde.

For the remaining components an estimate of the probability of failure was made, where necessary, on the basis of the design made according to the line A strategy.

6.3.4 Strategy line C

Using an economical approach, the probability of failure is translated into an annual insurance premium for the financial damage as a result of a failure of the barrier. The present value of this insurance premium is added to the costs of investment in the design variant for which the probability of damage is calculated. With an optimum design the investment sum and present value of the insurance premium for probability of damage is minimal. This method was particularly used for the design of the storm-surge barrier to see if a certain extra strengthening of a component (= a decrease of the probability of failure) would be worthwhile with regard to the limitation of the expected maximum damage to the barrier. In addition to this, the continued economical damage to Zeeland was not considered because the decision to construct the storm-surge barrier was not based on economical motives (see Part 1, Chapter 2).

This economical optimization per component had two limitations:

The first restriction was that the optimal probability of failure would become larger than was acceptable, according to the (derived) standards of Delta safety.

The second restriction was that the strengthening effect of a certain component would be dominated by the probability of failure of a component in another part of the fault tree.

The final result of these restrictions was that the line C strategy was most effectively applied to components of which the probable failure played an inferior role in the fault tree for the maximum probability of failure of the barrier, or did not occur at all in that fault tree, such as for example, the bed protection on the seaside of the barrier.

Documentation

1 Anoniem, Stormvloedkering in de Oosterschelde, Onder-

zoek naar geavanceerde methoden ten behoeve van een harmonisatie van het ontwerp; d.d. 20 april 1976 TNO, Groep Bijzondere studies, Bureau risico-analyse. Ref. nr 76-20-04, opdracht nr 014012

2 Projectgroep Stormvloedkering Oosterschelde, Nota nr 2, d.d. februari 1977, PGO 214 met Bijlage 1

3 Projectgroep Stormvloedkering Oosterschelde, Nota nr 6, d.d. mei 1978, PEGEOO-N-78157

4 Projectgroep Stormvloedkering Oosterschelde, PGO-nota nr 7, d.d. december 1978 PEGEOO-N-78293

5 Projectgroep Stormvloedkering Oosterschelde, PGO-nota nr 8, d.d. juli 1979, PEGEOO-N-79100

6 Mulder, Th., e.a.: Grenstoestandnota (concept en onvolledig), Werkgroep Ontwerpmethodiek, d.d. 1 juni 1976, SOOCOO-N-79364

7 Mulder, Th., e.a.: Nota onderbouwing veiligheidscoëfficiënten (onvolledig), d.d. 1 oktober 1979, Werkgroep Ontwerpmethodiek, SOOCOO-N-79364

Literature

1 Kooman, D.; Mulder, T.; Quelerij, L. de; Vrijling, J.K.: Probabilistic approach to determine loads and safety factors, Symposium on foundation aspects of coastal structures, Delft, 9-12 october 1978, Proceedings vol. 1, paper III. 1

2 Kooman, D.; Schaik, H. H. van: Probabilistische ontwerpmethodie, Cement XXXI (1979) nr 12

3 Kooman, D.; Stuip, J.; Scope and programming of hydraulic research in relation to the realization process, in: Hydraulic Aspects of Coastal Structures, part 1, II Design philosophy and Strategy in the project related research, 1980 Delft University Press, ISBN 90 6275 0540

4 Mulder, Th.; Vrijling, J.K.: Probabilistic load determination, also see nr 3

5 Vrijlings, J.K.: Probabilistische methoden in het ontwerp van de stormvloedkering, Cement XXXIV (1982) nr 11

7 Interaction between research and project realization

Research played an important part in the design and the construction of the Storm-surge Barrier. The importance given to research is shown by the fact that a staff group, SOOCOO, was established for coordination and budget control of research work and to advise management of the project organization concerning the necessary research. The total research costs were approximately 5% of the total costs of the barrier (design and research costs totalled 20%). This percentage is significantly higher than is usual for a large hydraulic construction.

The combination of specific problems relating to this type of construction were:

- Construction on an insufficiently sheltered location, open to wind, waves and currents;
- On an erosion sensitive foundation bed with little bearing capacity;

Linked to high demands relating to:

- Safety;
- Reliability;
- Stability;
- Life-span of the construction to be built;

Further limitations were caused by boundary conditions such as:

- A minimum disruption of the existing morphological situation;
- A limited available budget;
- A relatively short construction period;

ensured that traditional solutions were not applicable.

A breakthrough for new constructions and working methods was necessary. That these breakthroughs did not come suddenly but occurred gradually, in view of the numerous questions posed, can be seen in Part 1, Chapter 4. Besides this, a large number of questions had to relate to:

- Pressures on the barrier or its components;
 - A maximum life span of the barrier;
 - The reliability of movable parts;
- were resolved on the basis of research.

To detail all research carried out would be impossible. In general, a difference can be made between:

- Site research into geological, soil mechanical and hydraulic data to determine the environmental boundary conditions for the project, both during construction as well as in the final state;
- Research using hydraulic models to determine the form and to predict occurring load from currents and waves as well as morphological symptoms (siltation/scour), both during the construction phase and for the final phase;
- Research using soil mechanical models to determine the values for load transition of the concrete construction to the subsoil and the expected deformations;
- Research using hydraulic and dynamic models to determine

dynamical load on – and as a result thereof the dynamical behaviour of – the gates;

- Practical research to optimise future concrete constructions with a view to the required life span and to maximise conservation of piston rods of the hydraulic operating mechanism;
- Research into the qualities and/or usefulness of the designed constructions and equipment or details thereof;
- Research into the possibility of applying techniques, developed elsewhere, to the project especially for surface dredging and clearance of the foundation bed, the location under and above the water-level, as well as to further development of these techniques;
- Research to develop new working methods or constructions;
- The development of stochastically calculated models to extrapolate prototype measurements and scale model research results;
- The development of new and advanced design methods based on stochastic qualities of both the loads on and the strength of the future constructions and its components.

The first two methods of research mentioned (on site and using hydraulic models) are quite usual for hydraulic constructions of some size and therefore not so special. The scale of the research was, however, so large, that special equipment was developed to produce large amounts of data in a quick and reliable way.

In general, the remaining methods do not emerge much, and almost certainly not in a size and intensity of the likes which have taken place in this project. These investigations had, for the most part, an innovating character.

They often related to:

- Research into the usefulness of new ideas and further development of same;
- More fundamental research into specific problems to see if useful solutions could be found.

Certain solutions sometimes caused a chain-reaction of new developments. So has the development of the underwater compression method for making loose layers of sand more compact, combined with the method of preventing erosion through large cyclic pendulums in the porous water, by means of filter layers consisting of different grain sizes, led to:

- The possibility of prefabricating all concrete components of the barrier and, if necessary, positioning them directly on the sand bed;
- The development of the filter mats for the foundation beds required for that purpose;
- The development of a very precise dredging technique with the help of the dustpan suction nozzle;
- The further development of very refined location techniques both under and above water relating to unusual high require-

ments in connection with the accuracy of the positioning of the elements.

From the comments made earlier, it could already be derived that the realised design innovations and construction methods were not lined up for the sake of the construction itself, but because they offered the perspective for a better solution of the posed problems.

The lack of knowledge and/or experience had to be supplemented by research.

The results of research have led to changes in design, data for yet to be designed equipment and the setting up of new working methods.

Also during construction, results of completed work were regularly taken, analysed and evaluated which led to quite a

number of cases wherein the design and the resulting method of work had to be adjusted.

The results of the hydraulic scale model research were checked on the basis of actual measurements. By means of these prototype observations the predicted models of water levels and current velocity could be improved so that the increasingly becoming intricate construction phase, with regard to the expected hydraulic situation, could be completed so that the reliability could at least stay the same or increase compared to the previous construction phase. These interim recordings can be seen as part of the research.

In this way, right from the beginning of the design to the practical completion of the realisation, constant interaction has taken place between the research on one side and the design and execution on the other.

8 The landscaping of the Oosterschelde and surroundings

8.1 Introduction

The Oosterschelde barrier forms an emphatic element in the landscape of the Oosterschelde environment. The way in which such a large hydraulic construction manifests itself is primarily determined by the technical design based on the function of the construction and its resulting design. This design can be further influenced by taking into account various secondary functions which are offered by the project.

Examples of the latter are the traffic function, the recreational function, and the environmental function. Each function dictates its own requirements to the design and form.

Starting with the design based on the primary function and taking into account the possibilities of the secondary functions, a landscape form can be looked for which will do justice to the landscape as a whole and to the special character of the barrier. From the above it proved that a responsible landscaping was desirable. On behalf of the Oosterschelde barrier and by order of the State Department for Public Works, landscape studies were made by the Foundation for Landscape Planning and Design (STILO) in Wageningen. The result of these studies can be found in the document: 'Landschapsvormgeving van de Oosterscheldedekering en de werklocaties langs de kusten van Schouwen en Noord-Beveland'. The studies mainly relate to the elements which can be influenced by the landscape, such as the dam compartments with the construction sites, construction pits and construction harbours.

The studies are supervised by the staff group STOVIL in which the departments of Hydraulic Engineering, Environment and Allocation of Deltadienst, the Division of Sluizen, Stuwen en Bruggen (Locks, Weirs and Bridges), the State Forestry Department and the architect bureau 'Quist B.V.', who looked after the formation of the concrete constructions, all participated.

8.2 Starting-points and considerations

To enable a clear perception in connection with the landscape design an analysis was made of the specific features of the Oosterschelde landscape, especially the western part and of the landscape features of adjacent areas such as Schouwen-Duivenland and Noord-Beveland, of which the landscape cannot be separated from that of the Oosterschelde itself.

Important features of the Oosterschelde landscape are:

- The spaciousness;
- The vitality of the tidal environment with deep channels, shallow, shelves and, especially in the east, vegetated mudflats.

The following are characteristic features of Schouwen:

- The difference between the dune landscape in the west and

- The polder landscape;
- The large size of the Schouwen polder;
- The pattern of creeks and pools, created in the past;
- An almost united range of intersections behind the dikes.

The special features of Noord-Beveland are:

- The small size of the polders;
- The fanciful coast line;
- The scattered intersections, small beaches and small low dunes.

More detailed landscape descriptions can be found in the STILO Plan mentioned in Section 8.1.

Within the framework of this landscape analysis the technical appearance of the Oosterschelde barrier, which forms a new element in the existing landscape, is further described. This Section will not pursue this further.

By the selection of the starting-points, which could be employed by the landscape design, it was considered that the Oosterschelde barrier would be constructed with a dual aim, namely to guarantee safety demands against overflowing and to maintain a valuable tidal environment.

For landscaping this means that the technical pattern of the barrier will literally cover the natural landscape pattern which has to be maintained. These patterns are contradictory which reflects the dual character of the barrier. On the basis of the previous consideration, the main initial issues for landscaping were chosen to make so much visible as possible and to accentuate this dual character. In order to achieve this, the following considerations were important. Between the Oosterschelde and the North Sea the ecological connection is maintained. As a result of the construction of the barrier a visual barrier nevertheless exists. Only from the highest point of the barrier (12 meters above Normal Sea Level) can both sides be surveyed. The strengthening of this visual relationship, as an expression of the permanent ecological connection, is deemed of great importance. The shelf Neeltje-Jans, with an important environmental function, is adjacent to the barrier and within easy reach. By means of this adjusted landscape design the accessibility from the barrier could be restricted as much as possible.

Through the presence of, from a functional point of view, secondary diagonal elements, such as construction docks and harbours, the view across the water from the coasts of Schouwen and Noord-Beveland is limited. Locally this damages the characteristic spaciousness of the Oosterschelde area.

On the Oosterschelde side of the dam compartment, the view is dominated by outstretched construction sites and construction docks. By means of the landscape design an attempt could be made to show the specific features of the tidal environment in contrast to the technical pattern of the barrier.

Because of the presence of extensive secondary elements, the functional structure of the hydraulic construction is often

difficult to recognize. In particular on the side of the Oosterschelde, the linear principal form of the barrier in the landscape is dominated by secondary elements. In relation to this, one wanted to make a clear distinction in the design between essentials and non-essentials of the barrier. To remedy this, it was thought to lower the crown height of the dikes diagonally positioned on the barrier, to lower the construction sites and to establish a spatial division between the barrier and the construction pit-dikes or remnants alongside the barrier.

Furthermore, it was considered that the components of the auxiliary works, such as construction docks and harbours, could give permanent expression of the activities during the construction phase of a unique hydraulic construction.

Also, the landscape study recognized the desirability of having maximum freedom with regard to the final choice of secondary destinations. The reason for this being that parallel to the landscape study, the Oosterschelde Guidance Group drafted a plan for the allocation and management of the Oosterschelde area. This resulted in the Policy Plan Oosterschelde 1982.

At the time of the landscape study no decisions could be made on concrete ideas about the use of the present construction sites, work harbours etc.. Meanwhile, in the Policy Plan framework, further research is to be carried out into these application possibilities. See Part 5, Chapter 2.

8.3 Configuration 'Neeltje-Jans' construction island

The landscape study resulted in four detailed alternatives which differ in the way and to the extent in which the technical pattern and the natural pattern are related to each other. The alternatives also show differences in the relation between the functional primary elements (the linear principal form) and the functional secondary elements. Further concretized, the differences between the alternatives are mainly related to the way in which the secondary elements, such as the construction pits and construction sites, are handled. This varies from complete maintenance to the almost entire removal of the aforementioned elements. In the two intermediate alternatives there is talk of a partial removal.

The alternatives are reflected in Figures 15, 16, 17 and 18. These show some common features among which are, the through road over the barrier and the location of the control and service building, the ir. J.W. Topshuis (Tops-House). With regard to the through road, it is proposed to also visually express the permanent ecological relation between the North Sea and the Oosterschelde by constructing the road at such a level, about 12 meters above Mean Sea Level, so as to maintain a free view across the water to both sides. By comparison, it can be stated that such a situation does not exist at the Veerse dam and the Brouwers dam.

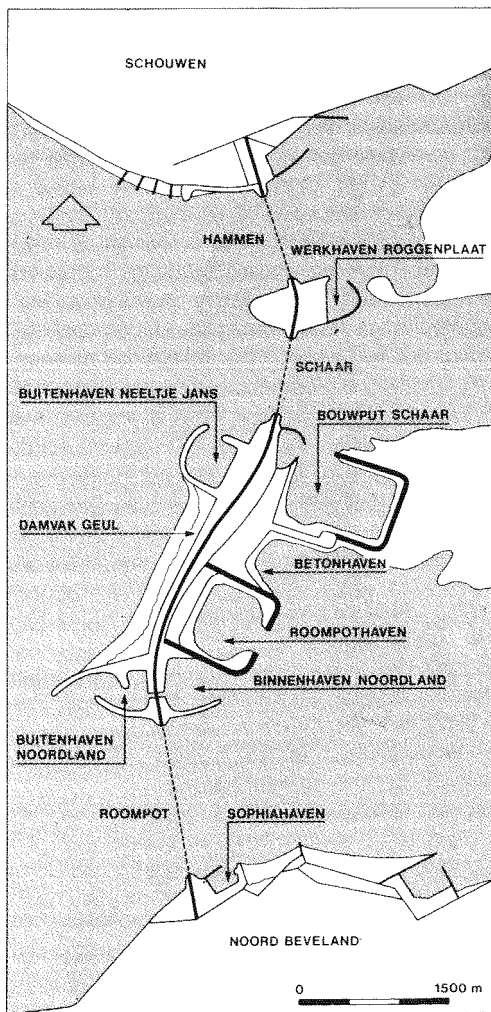

Fig. 15.

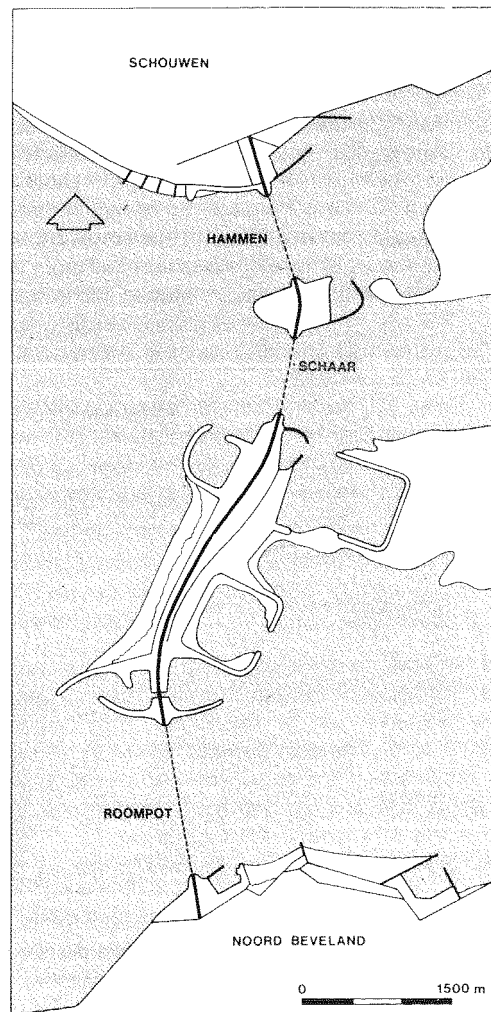

Fig. 16.

The basins behind the dams do not have an open connection with the North Sea as a result of which there is a weaker ecological relationship than by the Oosterschelde.

For the location of the ir. J.W. Topshuis (Tops-House), various possibilities have been investigated. The choice was made to locate it on the outside of the barrier, near the outer harbour Neeltje-Jans. It was considered that in this way the building could be situated in a bend of the barrier and would not damage the linear principal form of the barrier which could be seen from the building. Because of the formation of the building and its location on the outside, emphasis is also made on the tension between safety on the one hand and the dynamics of the sea on the other.

In the first instance, from the previously mentioned alternatives, no choice was made. In view of the relationship along with the possibilities for future new functions of the Neeltje-Jans area, the Guidance Group Oosterschelde was asked its opinion on the finishing touch of the landscape.

With regard to the possibilities of the future allocation of the Neeltje-Jans area, they made an indicative choice for the so called 'integration' alternative in which possibilities for the use of construction sites, -pits, -harbours etc. are taken into account. Actually, they chose to maintain the secondary elements (Fig. 15). With that, it was stated that the intention was to

maintain, as much as possible, the landscape view described earlier.

The Guidance Group asked the State Department of Public Works to take into account, during construction within the framework of completion, the indicative allocation choice and further details thereof.

8.4 Configuration of dam abutments

The configuration proposals for the coasts of Schouwen-Duivenland and Noord-Beveland relate to the following locations: both of the dam abutments, the harbour platform in Burghsluis, the construction harbour region Schelphoek and the construction harbour Sophia.

It was considered that that there are regions along the coasts with an important environmental function. In particular, the intersections are significant elements in the landscape of the western part of the Oosterschelde region, which form an essential component of the ecosystem. This important environmental function is a primary starting-point. Further, it is considered that the coasts of Schouwen and Noord-Beveland have a different character.

The coast of Schouwen is characterised by:

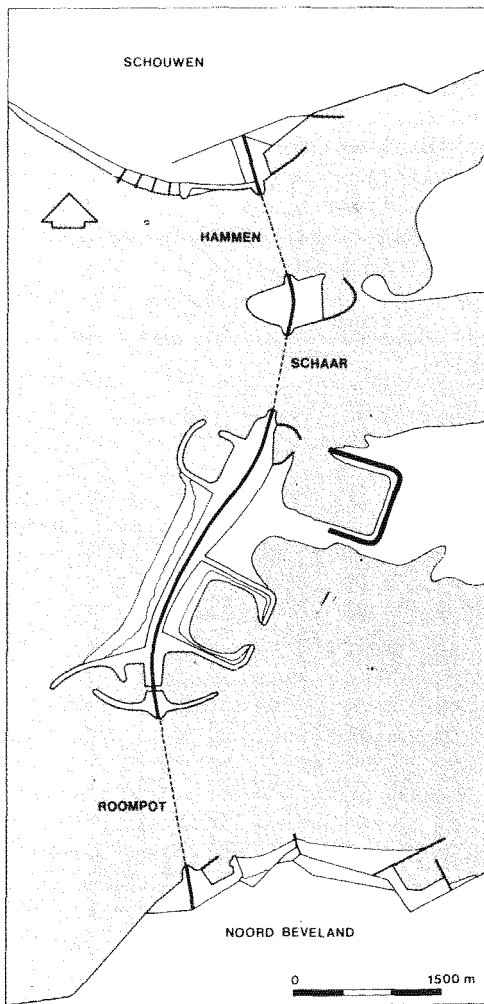

Fig. 17.

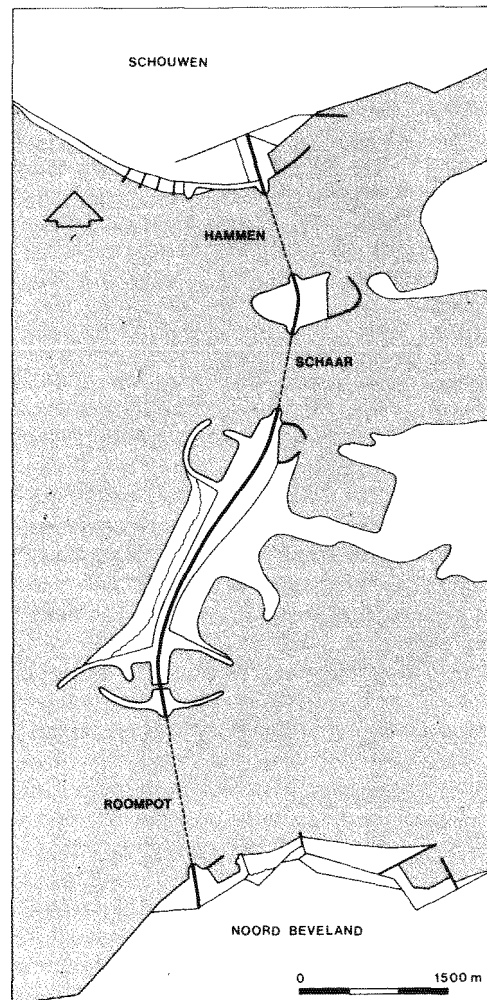

Fig. 18.

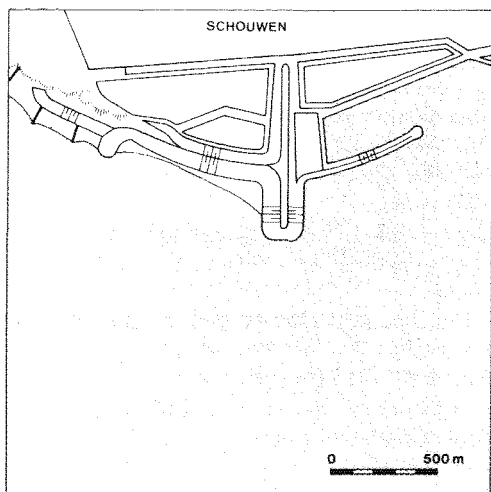

Fig. 19.

- An almost straight coastal line, bending inwards;
- An almost unified intersection zone;
- The lack of a beach;
- A large depth of water, in front of the coast;
- The presence of large shoals running dry during the ebb tide, relatively close to the coast;

The coast of Noord-Beveland is characterised by:

- A spacious, jagged formation;
- Mostly smaller, scattered intersections;
- The presence of larger and smaller beaches, spread about in inlets along the coasts;
- A shallow zone close to the coast, the channels and shoals which run dry are situated at a greater distance.

It was proposed to maintain and, where possible, to strengthen the significant character of the two coastal zones during landscaping of the various regions.

The following formation proposals are developed for dam abutments at Schouwen and Noord-Beveland.

At the location of the dam abutment Schouwen, there are two intersections, the western intersection bisected by the dam abutment (see Fig. 19). It was proposed to maintain the two intersections as much as possible, or even to restore them to their original state. This can be achieved by giving the dam abutment a so small as possible form. This would emphasize the overlapping of the two different landscaping patterns, analogous to the proposed landscaping ideas for the Oosterschelde barrier. This proposal can be varied by the removal or not of the construction harbour on the location and its harbour site. For the moment these are maintained.

The dam abutment Noord-Beveland intersects an area with small beaches and dunes. It is proposed to, in connection with the earth body for the access roads, construct an artificial dune and when possible to strengthen the beaches in the area with superfluous sand. This would strengthen the environmental pattern in contrast to the technical pattern of the barrier.

In the future, the construction harbour will only have the function of store-room for the guard gate of the 'Roompot' ship lock. It is proposed to fill the remainder of the harbour (the western part) with sand to make it part of the dune formation (see Fig. 20).

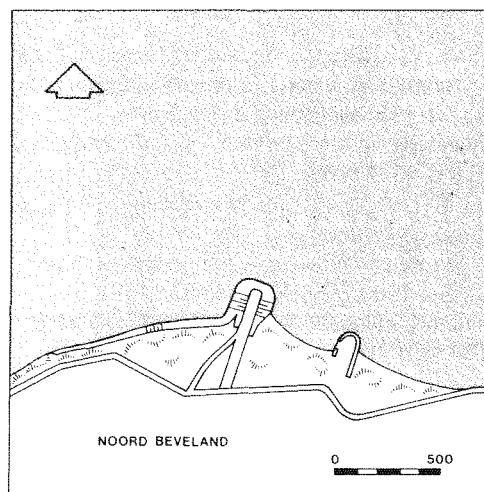

Fig. 20.

8.5 Conclusion

In the foregoing an overview was given of the results of research into the landscaping of the Oosterschelde barrier and the construction locations along the adjacent coastal regions of the Oosterschelde.

As mentioned, there is a new connection between landscaping and future (secondary) functions of the various locations, part of which is still being researched. The results of the landscape research can form the scenic framework. The final formation of the construction sites, construction pits, harbours etc. is mainly dependent on developments desired by management and the means available. After, with respect to this, more final decisions have been made, it can be considered whether within the budget for the final completion of the sites, future functions and forms can be taken into account. This is not within the framework of this Design Plan.

Documentation

- SV-34 Notitie 'architectonische overwegingen stormvloedkering Oosterschelde'
- SV-44 concept-notitie 'Inrichting en vormgeving Oosterschelde dam en omgeving' van werkgroep LH
- SV-48 tweede concept-notitie 'werkgroep LH'
- SV-62 notities m.b.t. de aanleg van een 5e bouwput, van LH, d.d.31-1-1979
- SV-79 tekening voorstel locaties bedrijfsgebouwen, van arch. bureau Quist, d.d. 5-6-1979
- SV-81 concept landschapsstructuurschets voor SVK in de OS; van LH
- SV-82 notitie 'Verticaal alignment overbrugging sluis Noordland', d.d. 22-8-1979, van LH
- SV-87 concept landschapsstructuurschets voor de SVK in de OS bestemmingsmodellen, van LH
- SV-88 brief van arch. bureau Quist aan van Houweninge, met bijlagen, betreft dienstgebouw, d.d. 1-10-1979
- SV-94 notitie SVK OS, mogelijke bestemmingen, d.d. oktober 1979, van LH
- SV-102 notitie 'landschappelijke aspecten m.b.t. keuze locatie bedieningsgebouw', van LH, d.d. 30-10-1979

- SV-110 tekening Alternatief voor de vormgeving van de landhoofden van de SVK, van SBB, d.d. december 1979
- SV-115 notitie 'Alternatief locatie dienstengebouw SVK' STOVIL-M-80.002 van Schellekens, d.d. 1-2-1980
- SV-121 notitie 'Vormgeving landhoofden', STOVIL-M-80.007 van Schellekens, d.d. 10-3-1980
- SV-132 notitie nr STOVIL-M-80.008 'Vormgeving landhoofden', van WWW, d.d. 12-4-1980
- SV-135 notitie bij de Keus van het bewegingswerk, van arch. bureau Quist d.d. 28-4-1980, (nr STOVIL-M-80.015)
- SV-143 concept-nota 'Landschappelijke vormgeving OSK' van projectgroep STOVIL. d.d. juni 1980 (nr STOVIL-M-80.016)
- SV-145 notitie 'Inrichting van werkhavens en opslagterreinen' (nr 7 PROBU-M-80.026), van WWW, d.d. 14-5-1980 nr DDMMI-80.531, (STOVIL-N-80.017)
- SV-150 notitie 'Meteo-post in dienstengebouw', d.d. 4-7-1980 van Schellekens
- SV-161 notitie 'Landschappelijke aspecten ENERGO-project', van LH, d.d. 800829
- SV-163 notitie 'Landschappelijke aspecten ENERGO-project', van STOVIL aan werkgroep ENERGO, d.d. 800908, nr. DDMMI-80.531, (STOVIL-N- 80.017)
- SV-179 notitie 'Naar een alternatief landschappelijk ontwerp, eerste verkenning', van LH, d.d. 801011
- SV-187 notitie 'Alternatieven voor de landschapsvormgeving van de Oosterscheldekering' (interim rapport t.b.v. bespreking in de PGO), van LH, d.d. november 1980
- SV-189 notitie 'Landschappelijke vormgeving van de stormvloedkering over de Roggenplaat', van LH, d.d. 801111
- SV-192 notitie 'Roggenplaat, vormgeving Noordzezijde', van LH, d.d. 801125
- SV-201 notitie 'Standpunt STOVIL over kunstwerk' van Schellekens aan voorz. PGO, d.d. 12-12-1980 (STOVIL-M-80.021)
- SV-211 tekening 'Essentie landschappelijke vormgeving, plaats en vorm dienstengebouw Oosterscheldekering' van het bureau Quist
- SV-222 situatie-tekening dienstengebouw Oosterscheldekering, nr 80153, van arch. bureau Quist, d.d. 18-12-1980
- SV-226 concept-notitie 'Plaatskeuze experimentele windmolen', d.d. 14-3-1981, van LH
- SV-236 notitie DDMI-81.344 'Vervolg landschappelijke studies stafgroep STOVIL', d.d. 228-4-1981 aan voorz. PGO (STOVIL-M-81.009)
- SV-245 notitie landschappelijke aspecten van het ENERGO-project, van LH, d.d. 810619
- SV-258 notitie DDMI-81.581 'Landschappelijke aspecten van het ENERGO-project', d.d. 25-9-198, nr. STOVIL-M-81.008
- SV-259 notitie 'Landschapsontwikkeling van de Oosterscheldeoevers op Schouwen en Noord-Beveland, van STILO d.d. 29-9-1981
- SV-262 nota STOVIL-M-81.011 d.d. september 1981
- SV-266 notitie DDMI-M-81.628 Plaatskeuze reservedeur Roompotsluis aan projectbureau 1. STOVIL-M-81.012
- SV-288 notitie inzake vormgeving bewegingswerken op hamerstukken (PEGEOO-M-82061)
- SV-290 tekening betr. situering reservedeur Roompotsluis.
- SV-303 notitie DDMI-82.477 inz. berging overtollig zand aan zuidzijde bouwdok Schaar (STOVIL-M-82.003)
- SV-314 notitie DDMI-82.555 inz. kunstmatige duinvorming langs de werkeilanden van de Oosterscheldekering
- SV-316 inrichtingsplan voor de terreinen rondom het bedienings- en dienstengebouw
- SV-317 herziene situatie van het inrichtingsplan
- SV-318 STILO-nota 'Landschapsvormgeving van de Oosterscheldekering en de werklocaties langs de kusten van Schouwen en Noord-Beveland'

Part 3: Environmental boundary conditions

Contents

- 1 General introduction 86**
- 2 Aspects of soil mechanics 87**
 - 2.1 Geological condition 87
 - 2.2 Soil mechanical consequences 88
 - 2.3 Chosen solutions 88
- 3 Morphological aspects 89**
 - 3.1 Morphological characteristics of the Oosterschelde before the construction of the Oosterschelde works 89
 - 3.2 The influence of the storm-surge barrier on the macro-morphology 91
 - 3.3 The influence of the storm-surge barrier on the morphology in the immediate area 92
 - 3.4 Morphological research for the design and construction of the storm-surge barrier 93
 - 3.5 Morphological boundary conditions for design and construction 95
- 4 Hydraulic aspects 100**
 - 4.1 Introduction 100
 - 4.2 Data elaboration for the closed barrier 101
 - 4.2.1 General overview 101
 - 4.2.2 Storm surge levels 101
 - 4.2.3 Basin water level 102
 - 4.2.4 Wave energy 102
 - 4.2.5 The three-dimensional probability density functions of storm-surge level, wave energy and basin water level 103
 - 4.3 Data elaboration for the open barrier 103
 - 4.3.1 General overview 103
 - 4.3.2 Models used for the Oosterschelde barrier 104
 - 4.3.3 The tidal boundary conditions: the vertical tide 106
 - 4.3.4 Discharges and current velocities at the barrier during the construction phase 106
 - 4.3.5 Water levels and hydraulic head over the open barrier 106
 - 4.3.6 The hydraulic head over the closed barrier 108
 - 4.3.7 Monitoring and control 111
 - 4.4 Translation of the boundary conditions to hydraulic loads 112
 - 4.4.1 Methodology 112
 - 4.4.2 Specific situations 114
 - 4.5 Boundary conditions of the construction phase 115
 - 4.5.1 Introduction 115
 - 4.5.2 Wave models for the construction phase 116
 - 4.5.3 Determining the boundary conditions with regard to the design 117
 - 4.5.4 Determining the boundary conditions with regard to the workability 118
 - 4.5.5 Hydraulic loads in the construction phase 120
- 5 Ecological aspects 122**
 - 5.1 Short characterization and overall design input 122
 - 5.2 Migration of fish and bed animals in relation to the sill design 123
 - 5.3 The influence of construction materials on the environment 123
 - 5.4 Problems of fouling 123
 - 5.5 Problems relating to 'closed gates' 124

1 General introduction

The storm-surge barrier, meaning the abutments, the dam compartments, the concrete constructions with the means of enclosure, the foundation underneath, the subsoil and the adjacent bed protection together forms one hydraulic functioning and reacting whole.

That whole has to meet many different and often contradicting functional requirements (wet cross-section, retaining heights, durability, manageability; see Part 2).

In addition to this, the environment makes certain demands which cannot easily be ignored, and which put limits on the possibilities of design and construction.

Also the exchange between a completed storm-surge barrier and its surroundings can, in the long run, lead to undesired changes in the surroundings. This has to be taken into account during design and construction.

In this plan the various aspects of the exchange between the storm-surge barrier and its surroundings were looked at from four different angles, namely geotechnology, morphology, hydraulics and environmental knowledge.

This method of approach connects well with the research carried out at the request of the State Department of Public Works, in particular, by the Delft Hydraulics Laboratory and the Delft Soil Mechanics Laboratory to collect data relating to the character and the intensity of the exchange between the storm-surge barrier and its surroundings.

The geotechnological research (Chapter 2) concerns the acquired insight into the bearing capacity of the subsoil underneath the piers and the sill, and the prevention of loss of stability on the edge of the bed protection to an admissible level. The morfological research (Chapter 3) gives an insight into the problems of siltation and erosion near the structure, and the long term consequences for the mouth and the basin of the Oosterschelde.

The hydraulic research (Chapter 4) gives information on the extent and influence of the expected forces of waves, hydraulic head and currents. The environmental research (Chapter 5) concerns the many aspects of the environment in and along the Oosterschelde water and the possible consequences of the planned changes.

2 Aspects of soil mechanics

2.1 Geological condition

The soil investigation carried out in the closure gaps provided, on the whole, the following picture of the soil condition:

The upper part of the Pleistocene is situated at:

- The 'Roompot' between MSL - 30 m and MSL - 35 m;
- The 'Schaar' of the 'Roggenplaat' around MSL - 30 m;
- The 'Hammen' between MSL - 32 m and MSL - 38 m.

Continuous solid layers (layers thicker than 10 m with a conic resistance of more than 20-30 MN/m²) however, appear on deeper levels than the upper part of the Pleistocene, namely situated at:

- The 'Roompot' from MSL - 34 m to MSL - 43 m;

- The 'Schaar van Roggenplaat' from about MSL - 42 m;
- The 'Hammen' from about MSL - 52 m.

Above the pleistocene sediments (Tegelen and Maasluis formations), Holocene sediments are found which mainly consist of young sea sand and old mud-flat sand.

These Holocene sediments generally contain a separate grain layer with a high porosity (42-44%).

The conic resistance is generally in the range of 4-10 MN/m². In the northern part of the alignment in the 'Hammen', the young Holocene sediments contain many clay and silt layers through which the mechanical qualities of these sediments are clearly less than in the rest of the alignment of the storm-surge barrier. As a result of channel formation, the Holocene sed-

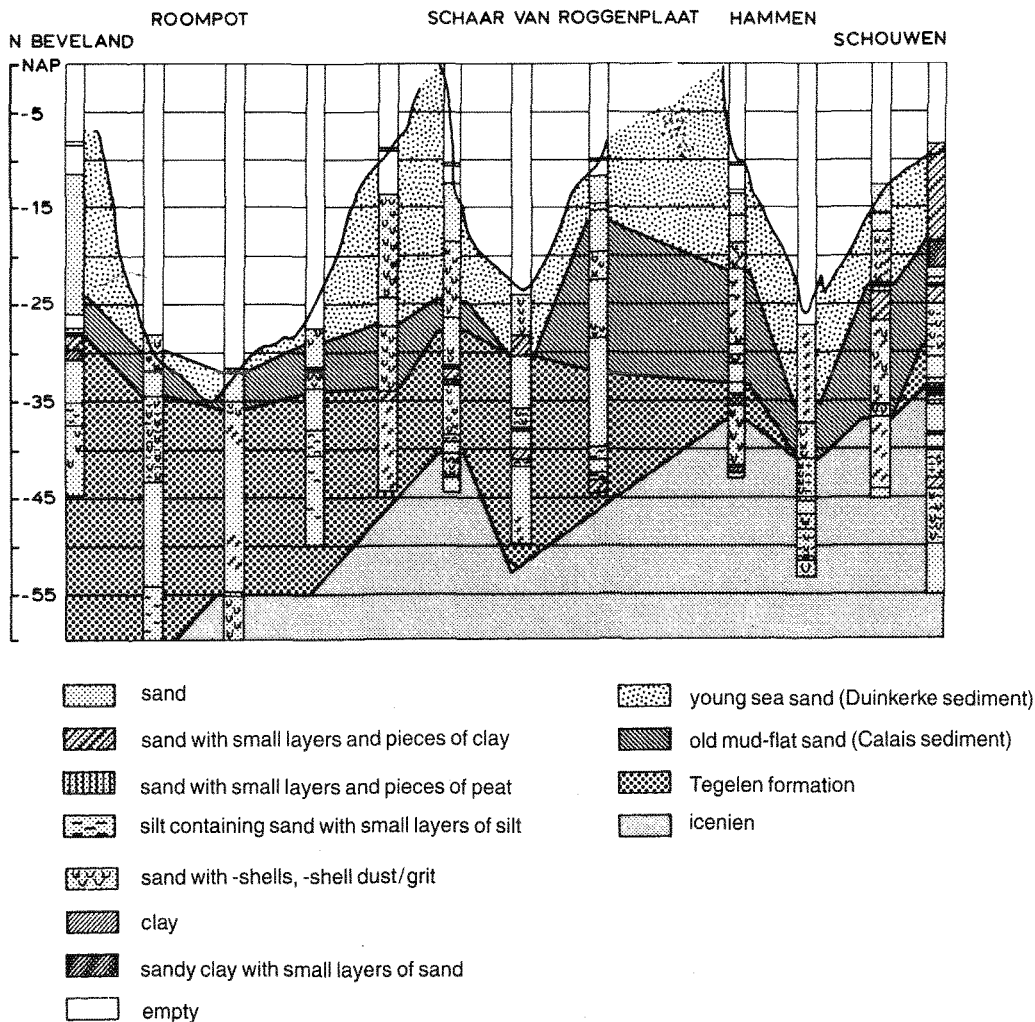

Fig. 1 Geographic section of the Oosterschelde mouth, 100 m east of the enclosure alignment.

iment layers in the deeper parts of the three closure gaps are significantly thinner than the ones on the edges. The soil investigation in the Pleistocene layer was limited to about 20 borings and 12 cone penetration tests to a depth of MSL – 50 m to MSL – 60 m.

From this, it appeared that the composition and the quality of the Pleistocene differed significantly.

In the 'Hammen' the formation of Tegelen, in which very high cone resistance appear, is a few meters thick. Underneath this, to the depth surveyed, is the formation of Maassluis in which mainly silt containing sand appears with cone resistances of 10 to 16 MN/m². In this area in-between layers are found of one to a few meters thick clay containing sand with low cone resistances of 5 to 7 MN/m².

From a depth of about MSL – 52 m very high cone resistances are measured.

In the 'Schaar van Roggenplaat', the Tegelen formation is found at a surveyed depth of approximately MSL – 32 m in which, over almost the entire closure gap, strong to weak clay containing layers of a few meters thick are found at a level of MSL – 40 m. Above and under this level there is sand with a very high cone resistance.

Also in the 'Roompot' the Tegelen formation is found in which, in general, very high cone resistances are measured.

Exceptions are the edges of the closure gap where at a level of MSL – 40 m clay containing layers can be found.

Figure 1 shows the schematic geological section.

2.2 Soil mechanical consequences

The geotechnical design problems, with regard to the geological condition of the subsoil, can be subdivided into two groups. The first group concerns the deformations of the construction (pier and sill). During storm conditions hydraulic head and waves put load on the construction and therefore also on the subsoil underneath and near the construction. These loads lead to changes in stress and so to deformations in the subsoil, with a probability of unacceptable deformations and even instability of the constructions. The phenomenon of softening should be mentioned here. When there is a loosely packed subsoil and sufficient high waves, water load in the subsoil can rise to such an extent that the subsoil softens as a consequence of this cyclical load. The construction can lose its stability. Furthermore, as a consequence of hydraulic head and waves, a ground water flow is created through the sill and the subsoil which can cause an undesirable erosion of the subsoil and settlement of the constructions.

A second group of problems relate to the instability of the scour holes at the end of the bed protection (at approx. 500 to 600 m from the axis of the barrier). Scouring holes with a depth of 25 m can reach the storm-surge barrier through flow slides or loss of stability and so cause damage to the foundation of the barrier.

The above mentioned problems can be seen as the main problems. However, inherent to the chosen solution of pier, sill and bed protection, a significant amount of secondary problems can be formulated, such as the filter function of the foundation bed and sill, seepage (piping) which necessitates compaction of the foundation bed, sill beam forces which impose demands on the cross sectional design of the sill

beams etc. These problems are dealt with more fully in Book 2 and Book 3.

2.3 Chosen solutions

Taking as a starting-point the external forces (hydraulic head and waves) and the chosen construction (pier, sill and bed protection), the loads on the subsoil which are transferred via the construction, can be determined. These forces, linked to the geological condition of the subsoil, result in settling, a danger of softening and erosion of the subsoil under the pier, sill and flows slides, and/or sliding at the edge of the bed protection.

Because the displacement of the piers and the differences between the displacement of two neighbouring piers cannot be too great with regard to the fitting of the gates, admissible settlements are established which are determined by the size of pier footing and the stiffness of the subsoil.

The qualities of the loosely structured layers of the subsoil with, in general, too little stiffness and too much risk of softening can, in principle, be improved by the application of mechanical compaction through vibration. In some places a too high silt content in these layers made effective compaction impossible. Also the clay layers which were not stiff enough could not be improved by mechanical compaction.

As a result, the loosely structured sand, clay and sand containing clay were dredged away around the pier and the axis of the barrier and replaced by an improved soil consisting of clean sand which was compacted at depth by vibration and was thus provided with the required stiffness qualities (cone resistance at soundings minimal 13 MN/m² and a porosity less than 40%).

Because the ground water flows can become that strong under and beside the pier causing erosion of the sand, it was decided to install a filter construction (foundation bed) on the sub soil under and beside the pier. This consists of successive layers of materials (sand, gravelsand, gravel) with such a grain size that the underlying finer material cannot penetrate the pores. To ensure that this prefabricated filter construction fits properly on the subsoil and to give it the required packing stiffness, it had to be compacted as well (see Book 2).

During the construction and after the finalisation of the storm-surge barrier, as a consequence of the narrowing of the wet cross section, turbulent flows can occur which make it necessary to protect the channel bed around the barrier.

The calculated equilibrium depths of the scour hole on the edge of the bed protection were a starting-point in the design of the length of the bed protection (see Chapter 3).

The slopes of the scour hole should not become too steep, because otherwise the danger exists of local loss of stability of the slope which can create, in loosely structured sand, a flow slide whereby the sand more or less starts behaving as a liquid. The conditions in which flows slides occur are not sufficiently known; the same applies to its possible dimensions. Therefore, for safety reasons, when designing the edge of the bed protection it was attempted to create a situation in which no flows slides could occur.

By compacting the bed near the edge of the scour hole and/or by an adequate protection layer on the slope, the probability of a flow slide has significantly decreased.

3 Morphological Aspects

3.1 Morphological description of the Oosterschelde before the construction of the Oosterschelde works

The present morphology of the Oosterschelde is the result partly of a natural development, namely a complex system of estuaries, and partly an artificial development, namely the construction of dikes and dams and dredging projects (Fig. 2). In particular, the construction of the various dams (Hellegatdam, 1931; Grevelingendam, 1962-1964; Volkerakdam, 1969) and dredging projects such as the construction of the Amer-Bergsche Maas in 1904 and the enlargement of the Nieuwe Merwede between 1920 and 1930, have influenced the morphological development of the Oosterschelde in the last century. As a result of these constructions, the tidal volume has significantly increased. This led to an increase in current velocity and consequently to an enlargement of the wet cross section.

During the last century, the entire Oosterschelde has increased in depth by about 1.2 m. This deepening arose mainly from the channels.

The mouth of the Oosterschelde consists of a moving pattern of channels and plates, like most of the coastal inlets along the Dutch coast. The combination of water and sand has led to a dynamic equilibrium. Natural changes relating to the pattern of channels and plates are relatively slow. Because of an increased tidal volume, the channels have not only moved but also enlarged during the last century. In the course of time the main channels have strengthened alongside the estuary embankment. When the channels reached the embankment, further horizontal movement and enlargement became impossible (Fig. 3). At the same time, the shallow area increased in width.

Simultaneously with the closure of the Volkerak in 1969, which increased the tidal volume by nearly 10%, the first construction island 'Roggenplaat' in the mouth of the Oosterschelde was built. In the following years, the construction islands Neeltje-Jans and Noordland were built, while construction of the dam abutment at Noord-Beveland began and the Geul was closed by connecting the construction islands Noordland and Neeltje Jans with each other. As a result of these constructions a narrowing of the wet cross section occurred, which would be compensated by further scouring of the three main channels Hammen, Schaar van Roggenplaat and Roompot. A complication arose from this because the channels Hammen and the Schaar van Roggenplaat moved towards the construction islands. As a result of these channel movements the channels mainly deepened on the south side (Figs 4 and 5).

Another recent development was the short-circuiting between the flood channel of the Roompot and the Schaar van Vuilbaard south of the area of Roggenplaat. At the same time, seawards of the dam alignment, a breakthrough appeared in

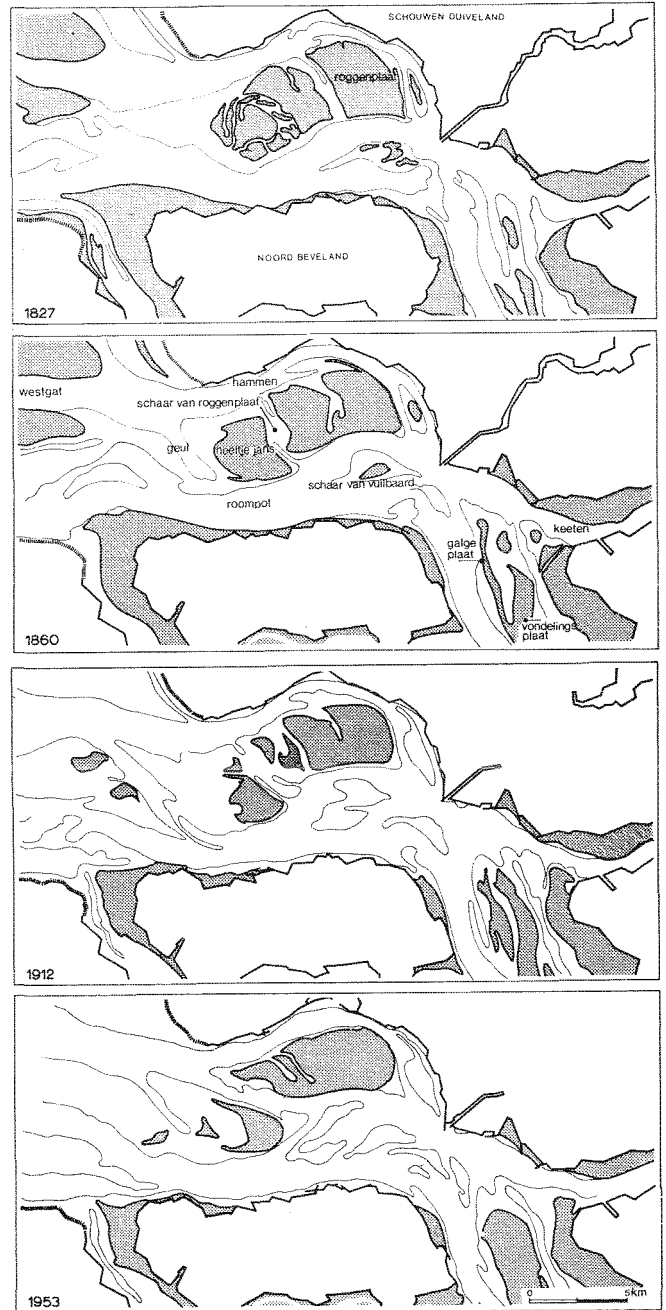

Fig. 2 Development of the shoals in the Oosterschelde 1827 – 1953.

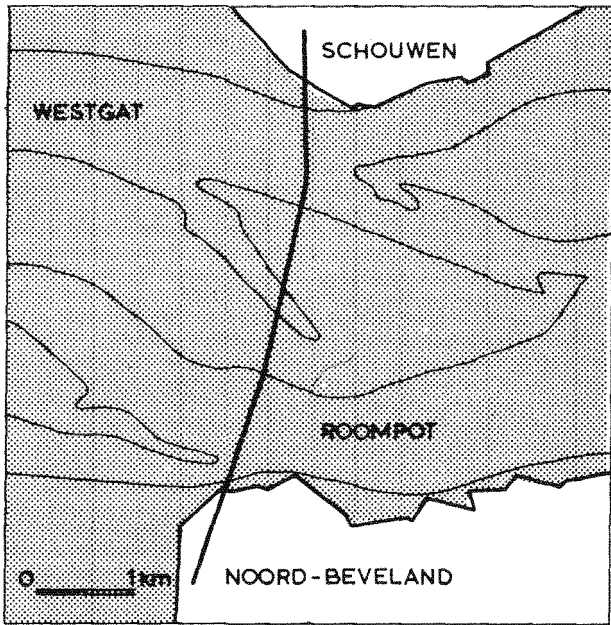

Fig. 3 Development of the bed profile in a line in the mouth of the Oosterschelde 1827 - 1953.

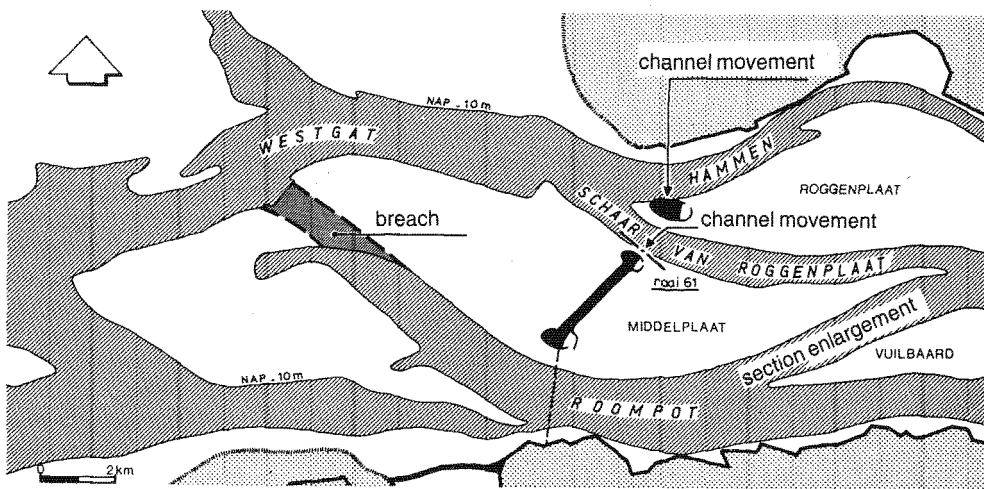
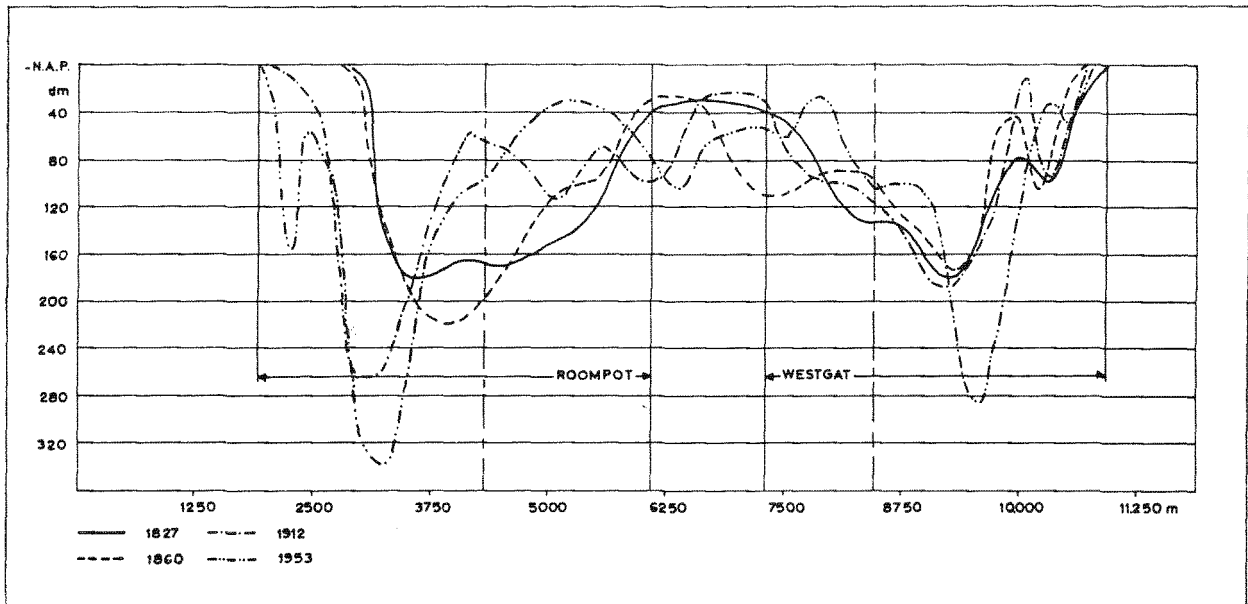

Fig. 4 Channel development in the mouth of the Oosterschelde between 1969 and 1975.

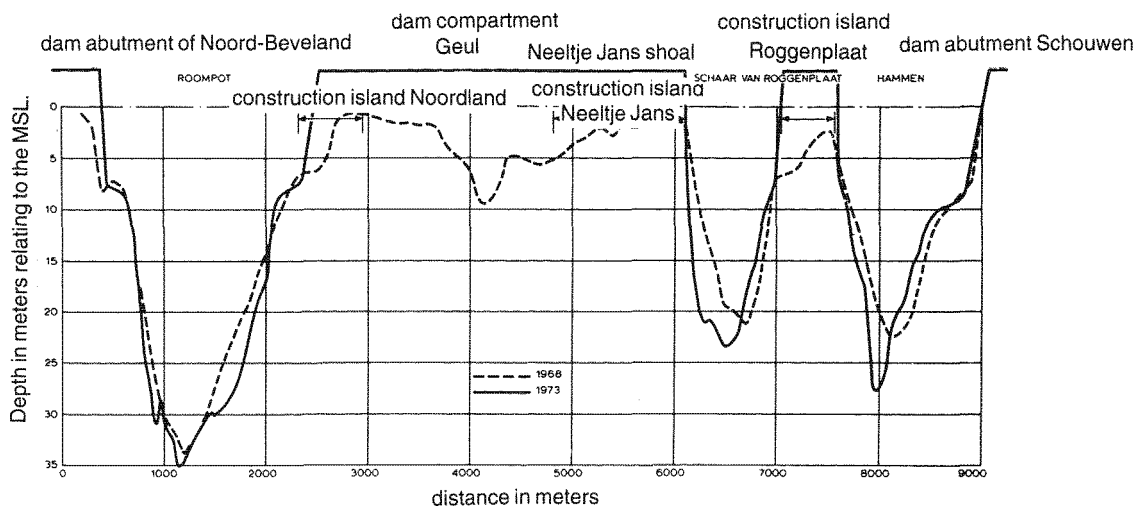

Fig. 5 Profile change in the alignment of the storm-surge barrier between 1968 and 1973.

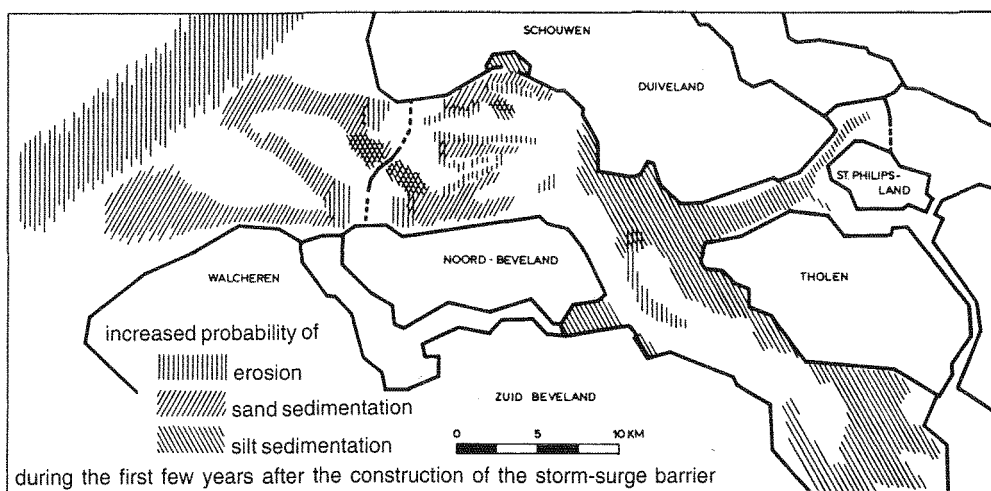

Fig. 6 Areas with a probability of increased sedimentation and erosion during the first few years after the construction of the storm-surge barrier.

the ebb channel of the Roompot to the Westgat (Fig. 4). The developments can partly be attributed to the fact that the ebb volume has increased by almost 10% after the closure of the Volkerak in 1969, and partly because of the closure of the Geul in 1972. Apparently these causes merely hastened the breakthroughs because the tendency of the ebb channel of the Roompot to bend to the north in the direction of the latter breakthrough, had been noticed earlier.

3.2 Influence of the storm-surge barrier on the macro-morphology

The Oosterschelde

It is mentioned in Section 3.1 that during the last century the wet cross section of the channels adjusted to the increase of the tidal volume.

The pursuit of a certain equilibrium of the basin can be ex-

pressed in a relation between tidal volume and wet cross section. In all the inlets of the Delta area, the quotient of the tidal volume and the wet cross section is more or less constant. This means that by reducing the tidal volume, by construction of the storm-surge barrier, the wet cross section of the channels becomes too large and the basin will tend to become shallow.

The expected shallowing of the bed is caused by two processes, namely the sedimentation of sand and silt (Fig. 6).

The sand and silt percentages in the water which enters the Oosterschelde during high tide determines, to a large extent, the speed of the shallowing process. Also, shallowing can be caused by erosion of the existing bank areas and shoals. Sand and silt brought in by flood currents end up in an area with significantly lower velocities, when compared to the past. The sand in particular will quickly settle; sand sedimentation is therefore expected in the area between Tholen and the storm-surge barrier. This will happen initially in the western part of this area, but the more the equilibrium state is achieved, the more

the sand sedimentation will extend itself eastwards. Contrary to the situation years ago when ebb flows brought a lot of sand outwards, in the new situation the settled sand will mainly remain in the Oosterschelde. The process is almost the same for silt sedimentation. However, silt settles slower and it is therefore expected to penetrate deeper into the Oosterschelde region. Besides which, there will always be a certain percentage of silt in the Oosterschelde water. For these fine components it does not mean that all the silt brought in by the flood currents will settle in the basin. But it does mean that the ebb flow carries less silt outwards than it used to do when the velocity was higher.

As a consequence of the construction of the compartment dams phase differences will appear in the tidal propagation in the main channels. It is possible that new channels will be created or that channel movement will occur.

The morphological development of the channels will be significantly determined by a decrease in the horizontal tide, while the development of shoals, saltings and shallows will also be dependent on wave action. The reduction of the tidal differences causes the wave action to concentrate on a smaller section of the coast. Through this erosion of certain bank sections can occur, whereby the surface area of the shoals, shallows and siltings is reduced.

Because of the construction of the Oosterschelde works, the time in which the maximum tidal flow occurs, in relation to the turn of the tide, will change. The maximum flow velocity will occur earlier in the tide.

The consequence of this could be that, next to the general decrease of the sand transport, also the concentrations of sand above the shoals and shallows would be especially low during flood tide, because the moment maximum concentration occurs (= about 0-30 minutes after the maximum flow velocities) there is still no water above large sections of the shoals and shallows. This would negatively influence the sedimentation on shoals and shallows.

The 'Fore delta'

To predict the influence that the construction of the storm-surge barrier in the mouth of the Oosterschelde has on the outer delta and the adjacent coastal area, experiences with earlier closures can be used. Although the intervention through the construction of the storm-surge barrier is different from when a complete closure takes place, there are similarities in the processes, which could be used for prognoses.

The bed of the sea outlets and of the adjacent coastal area consists mainly of fine sand which can be easily moved or shifted by tidal currents. Moreover, in these open waters the influence of the wave movements is very strong.

The formation of the flow channels and of the shoals in between the flow channels is determined by the effects of tidal currents and wave forces. The influence of the current is therefore clearly dominant, which appears from the linear set of channels and shoals in which the flow pattern is distinctly shown.

Through the closure of the large sea outlets, in the framework of the Delta works, the tidal movement is drastically changed. The current, perpendicular to the coast, changes into one that is more parallel to the coast, while the wave influence hardly changes. As a consequence of this, parallel sand banks can arise, where wave action supplies material from the submerged foreshore. Because of this the latter probably becomes steeper.

Through the construction of the storm-surge barrier, with regard to the coastal area in front of the Oosterschelde, a similar development must be taken into account (Fig. 7). Since the outlet is not entirely closed, the effect will be less emphatic.

3.3 The influence of the storm-surge barrier on the morphology in the immediate area

Sedimentation during construction of the storm-surge barrier
Sedimentation can negatively influence the various actions during construction of the storm-surge barrier. In addition to the sedimentation which occurs in the trench that is dredged for the improvement of the ground in the alignment of the storm-surge barrier, one has to take into account the formation of the sand scud between the different construction layers during construction of the structural components. This is further discussed in Section 3.4.

Erosion during construction of the storm-surge barrier
Water which passes through the storm-surge barrier in the Oosterschelde will, within the structure, accelerate and decelerate once it has passed through. This is accompanied by eddy formation where the sand transportation capacity of the water flow is larger than that in the upstream of the structure. After the water has passed the bed protection the sand transportation capacity of the turbulent flow becomes active, enough sand will be absorbed by the flow until there is a balance between the maximum possible and the actual sand transportation. This means that the flow takes away more bed

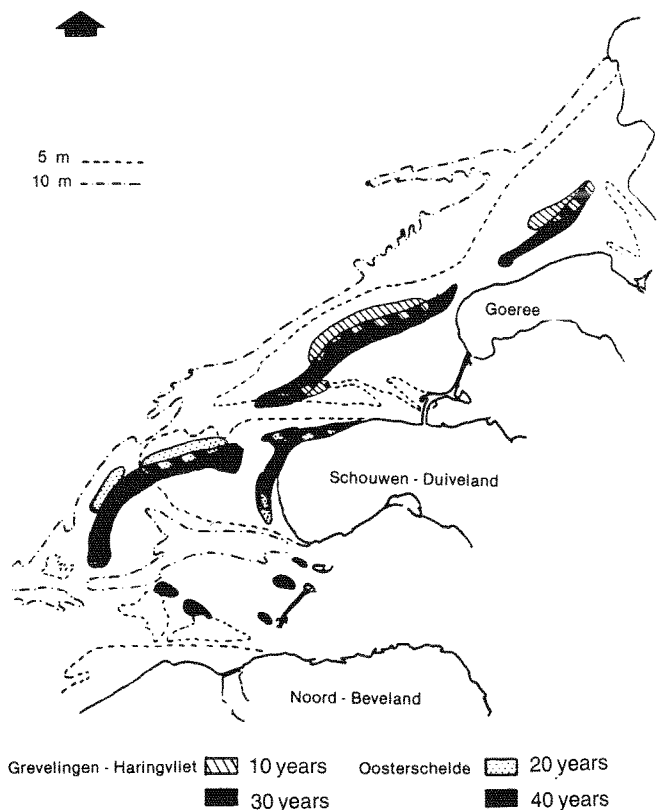

Fig. 7 Hypothetical developments of shoals in the 'Voordelta' area.

material than it supplies and so causes erosion. With an increasing scour depth this process gradually progresses until finally a state of equilibrium in the scour hole is reached.

During the construction of the storm-surge barrier two phases relating to the morphology of the surroundings of the storm-surge barrier were of importance:

- 1 The positioning of the sill beams;
- 2 The complete or partial closure of closing gaps with the aid of gates for the benefit of upper beam placement and rock dumping.

In this phase the extent and division of the discharges through the closure gaps was influenced.

The amount of the closure gap's discharge determined, among other things, the speed of erosion, the attack on the bed protection and the possible changes in the flow channels. The degree in which the discharge distribution between the two closure gaps varied gave an indication of possible morphological changes of the shoals between the two flow channels.

Erosion after completion of the storm-surge barrier

Short-circuit channels

After completion of the storm-surge barrier, the discharge distribution over the three closure gaps is similar to the discharge situation before the construction. This means that the cross connection between the main channels (the short-circuit channels) will not develop further.

Scour holes

During the placement of the sill beams, and because of the irregular division of resistance over the cross profile of the closure gaps, strong turbulence and therefore strong erosion will occur. After placing the last sill, the erosion will slow down. Also important is the influence of the upstream supply of sand and the influence of small clay layers in the bed which reduces the scour depth. Taking these aspects into account, the maximum scour depth is expected to be approx. 15 meters. By stabilising the upstream scour slope of the erosion hole through dumping of rock, this erosion will not endanger the barrier. After the completion of the compartmentalization dams the discharge through the barrier will somewhat decrease, whereby the development of the scour decreases further.

3.4 Morphological research for design and construction of the storm-surge barrier

Sedimentation problems

The appearance of sand transports is of importance for the design and construction of the storm-surge barrier. Sedimentations can have a negative influence on the various actions during the construction of the storm-surge barrier and can result in construction sections failing to meet set requirements. Sedimentation during the building up of components of the construction sections can stimulate the formation of so called sand lenses between the various construction layers. As a result of this or later, because of washing out of the sand lenses, the stability of the relevant component can be negatively influenced.

Besides sedimentation, which occurs in the dredged trench for the placing of ground improvement in the alignment of the storm-surge barrier, there are a number of boundary layers at

every pier which are, during construction, exposed to sedimentation:

- Between the compacted bed and the lower filter mat;
- Between the lower and upper filter mat;
- Between the upper mats and eventual slab mats;
- Between the upper mat, slab mat and the pier foot respectively.

Because prefabricated filter constructions were chosen, sedimentation during the construction of the foundation was limited to the above mentioned layers.

To remove sand that settled on the various layers a suction system is used during positioning of the mats and piers which cleans the contact surfaces.

For the benefit of the design of equipment and construction methods, model measurements and in-situ measurements were taken. Mathematical models were also developed to predict the future sedimentations.

To measure sand transportation an extensive measurement plan was developed which had as its aim:

- The development of a method which could predict sand transportation at any place and time during construction of the barrier;
- To make a description of the developments of material transportation outside the area of the barrier, such as in the fairways of the large construction ships and the prediction of changes in the position of the bed at the front and behind the barrier, which again have consequences for certain hydraulic conditions such as currents and waves;
- The prediction of eventual transport of suspended material, such as silt, during construction.

Firstly, an investigation was carried of the entire Oosterschelde by means of aerial photographs. This showed sediment and turbidity channels. The nature of these channels was then investigated with acoustic sand meters and turbidimeters.

The investigation into the relationship between the transport and other variables, such as velocity and temperature of the water and wave movement, involved 13 hours of measurements in a number of gauging stations in lines perpendicular to the Hammen and Schaar gaps.

The drawback of the conventional methods of measurement is that:

- An average sand concentration over a certain period of time is measured;
- Current velocities are measured separately and not at the same location;
- Measurements take place in a discontinuous way.

To partly drawbacks, an Acoustic Sand Transport Meter (the ASTM) was developed, in cooperation with the Hydraulic Laboratory in Delft. Figure 8 presents the principles of this system.

The scattered and absorbed acoustical energy in the sand is measured. With help of the 'doppler' effect the velocity of the sand components is determined, and the absorption is a measurement of the sand concentration. No information about the grain size is provided.

Along with the available data the classical sand transportation formula is verified and a predicted model was developed for the three flow channels Hammen, Schaar and Roompot.

The sand concentration appeared at a certain point not only dependent on the course of the flow velocity and on the spot wave action but also, for example, the turbulence and the water temperature and of the grain size of the material which is whirled up upstream. Also of importance is the extent to which

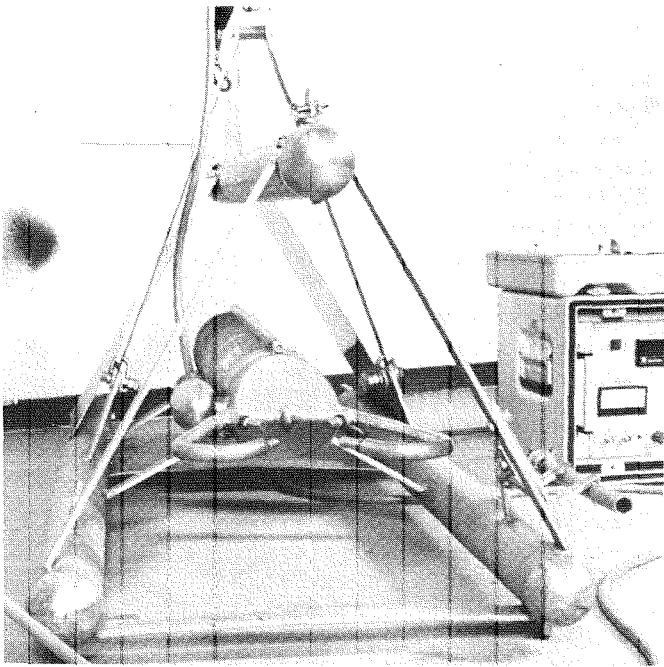

Fig. 8 The acoustic sand transport meter.

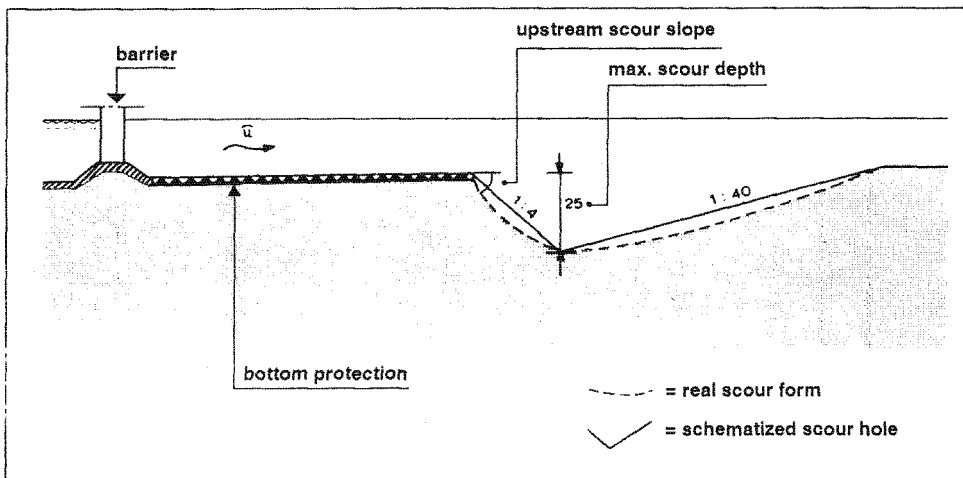
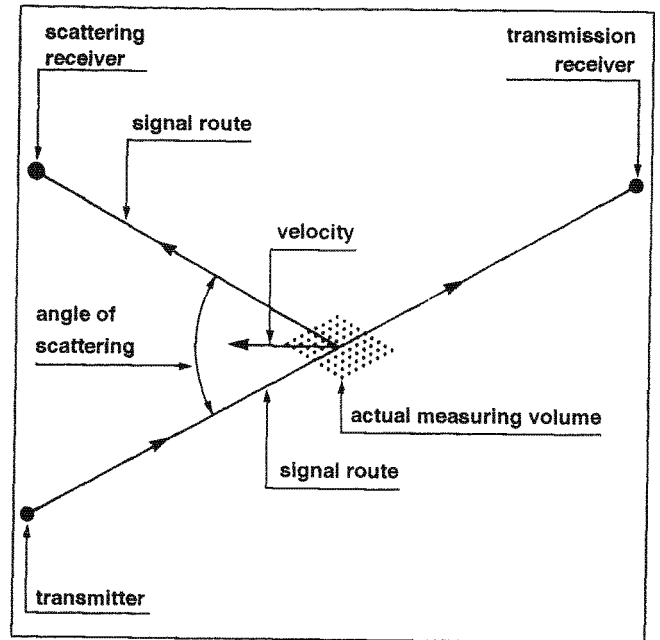

Fig. 9 Expected scour hole at the downstream part of the storm-surge barrier.

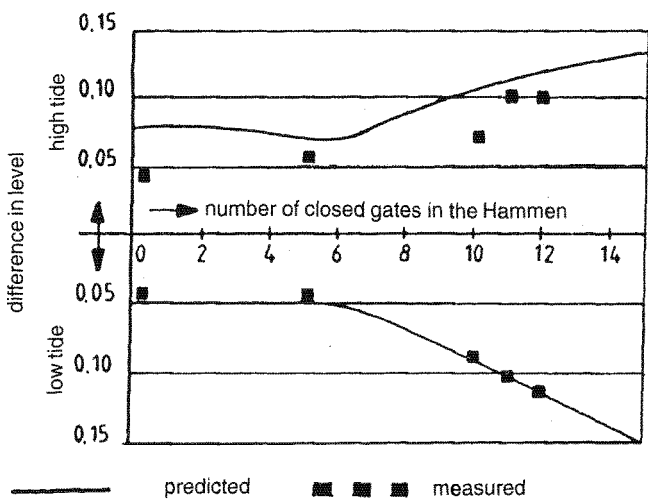

Fig. 10 Maximum differences in water levels between Hammen and Schaar with an increasing number of closed gates in the Hammen, predicted by IMPLIC.

upstream material can be absorbed by the flow. For this purpose wide strips of bed protection have been constructed, in the form of block mats and asphalt mats.

Scour problems

After the choice of a vertical narrowing in the design of the storm-surge barrier a large number of possibilities remain for the form of the outlet profile. An important aspect to this is the flow pattern on both sides of the storm-surge barrier.

Going out from flow pattern research in the detailed model of the closure gaps M 1001 in the Delft Hydraulic Laboratory in De Voorst, the distribution of the height of the sill along the axis of the closure gap was designed in the final position. The result was judged on basis of the flow velocity distribution along the edge of the bed protection measured in the model.

Also for the design of the bed protection the extent of the scour on the edge is a determining factor.

The slopes of the scour hole should not become too steep for this would create the danger of local sliding of the slope which, in loosely packed sand, can cause a flow slide, whereby the bed sand more or less behaves as a liquid. The circumstances which cause flow slide and the extent of it are not sufficiently known; the same applies to possible measurements thereof. For safety reasons the design strived for a situation in which no flow slide could occur.

By compacting the bed near the edge of the scour hole and/or through adequate dumping of rock on top of the slope, the probability of flow slide decreases significantly. In accordance with the erosion research a maximum scour depth of 25 m is used for the design of the length of the bed protection (Fig. 9). The length of the bed protection was determined by an experimental-analytical method in the model M1001.

This model has a movable bottom for the section outside the bed protection which consists of loosely structured material, and with the help of this model the process of erosion can be studied. The boundary conditions which determine the movement of water in this model were given by model M 1000 which gives an overview of the tides in the entire area of the Oosterschelde and the fore delta.

Through repetition of experiments by using different lengths of bed protection, it was possible to relate the length of the bed protection to an extent wherein the erosion decreased. After input of the necessary data, the computer calculated the necessary length of the bed protection to keep the scour hole within acceptable limits.

For a more detailed description of the different scour investigations see Chapter 5 in Doc. 1. The results of the scour research were used for predictions relating to the development of scour holes during the oblique construction phases at the completion of the storm-surge barrier. With help of the scour parameters resulting from this research, and the calculations with the computer model DOOS, developments during these phases could be predicted.

Short-circuit channels (connections)

For research into the development of short-circuit channels between the three closure gaps during the oblique construction phase at the completion of the storm-surge barrier, various means of research, such as mathematical flow models and mathematical morphological models, were applied.

Firstly, it is worked out which different water levels could occur between the main channels, as a function of the extent of narrowing of the closure gaps.

The results were based on calculations with the one-dimensional model IMPLIC. Figure 10 shows the result of such a calculation for the difference in water level between the Hammen and the Schaar along with an illustration of an increasing number of closed gates in the Hammen.

With the two-dimensional model DOOS flow velocities and discharges were calculated in the various short-circuit channels for the different construction phases. Figure 11 shows the flow pattern in the case of complete closure of the closure gap Schaar (for present bottom position and for a bottom position with a channel depth of 10 m and 500 m width). From this it appears that an increase in depth causes an increase in flow velocity leading to an increase in scour (see also Fig. 12).

Erosion calculations have been carried out for different characteristic situations. The sand transportation models used are ZANDTY (linked behind IMPLIC), WAMOR and SLUITZAK (both linked behind DOOS). Figure 13 shows the result using the most advanced quasi-three dimensional model SLUITZAK for a striking construction phase (a closed Schaar and an open Hammen and Roompot).

With the help of the results of this research advice could be given, during the final period of construction of the storm-surge barrier on, amongst other things, the construction layout and a properly specified surveillance system of the critical areas, and a proper monitoring system for the critical areas could be established.

3.5 Morphological boundary conditions for design and construction

Discharge distribution in the main channels

The main criterion used for determining the openings of the storm-surge barrier in the Hammen, Schaar and Roompot, is a division in such a way that the morphological pattern in the Oosterschelde is maintained as much as possible. This means that the discharge distribution in the three main channels should remain the same.

In the present state, the surfaces of the cross section are below Mean Sea Level for Hammen, Schaar and Roompot 25%-20%-55%. However, the maximum discharges relate to each other as 20%-20%-60%.

For the situation after the completion of the storm-surge barrier the maximum discharges will be more or less in relation to the effective wet cross section in the three closure gaps. The distribution of the complete cross section above the closure gaps is then, also in the design, in relation to the present distribution of the maximum chosen discharges (average tide) 20%-20%-60%.

Closing gap profiles

Because of the fact that in the final construction phase of the storm-surge barrier only a limited section of the original flow channels will be used, there are a number of possibilities in the design for the location and form of the final wet cross section. The most important hydraulic aspect is a proper distribution of the flow over the channel section, especially because of erosion.

Using the so-called 'window' solution, a relatively small but deep gap in the middle of the channels, bed protection on both sides of the barrier with a length of about 1500 meters is necessary, whereas the 'letterbox' solution, whereby the total width of the closure gap is used and a decrease of profile

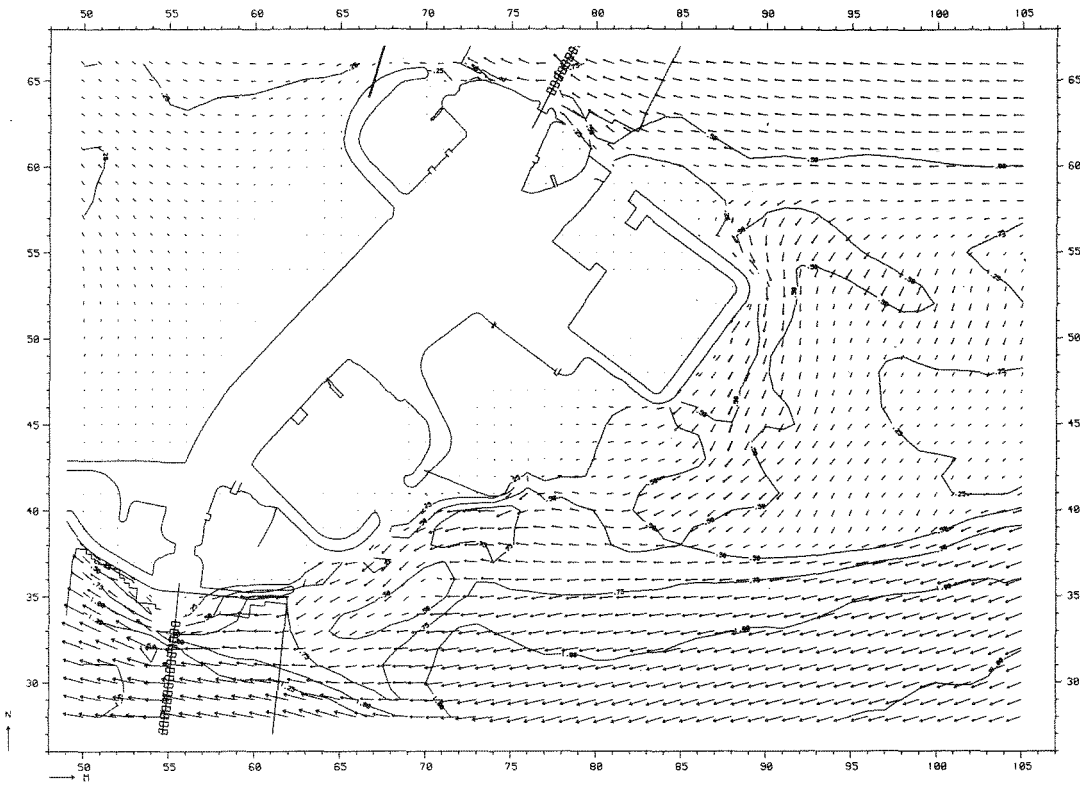

a. Schematic bottom position equal to real position.

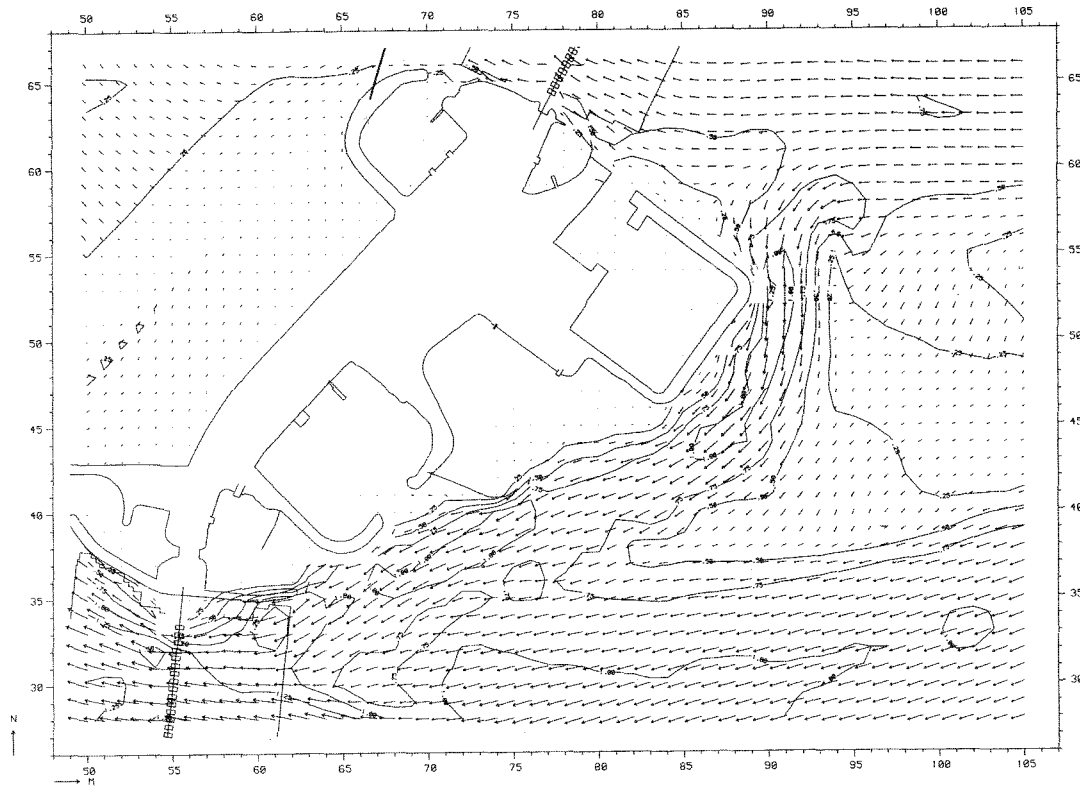

b. Schematic bottom position with a channel of 10 meters length and 500 meters wide.

Fig. 11 Result of 'DOOS'-calculation of flow pattern of the short-circuit connection Schaar-Roompot when the closure gap Schaar is closed.

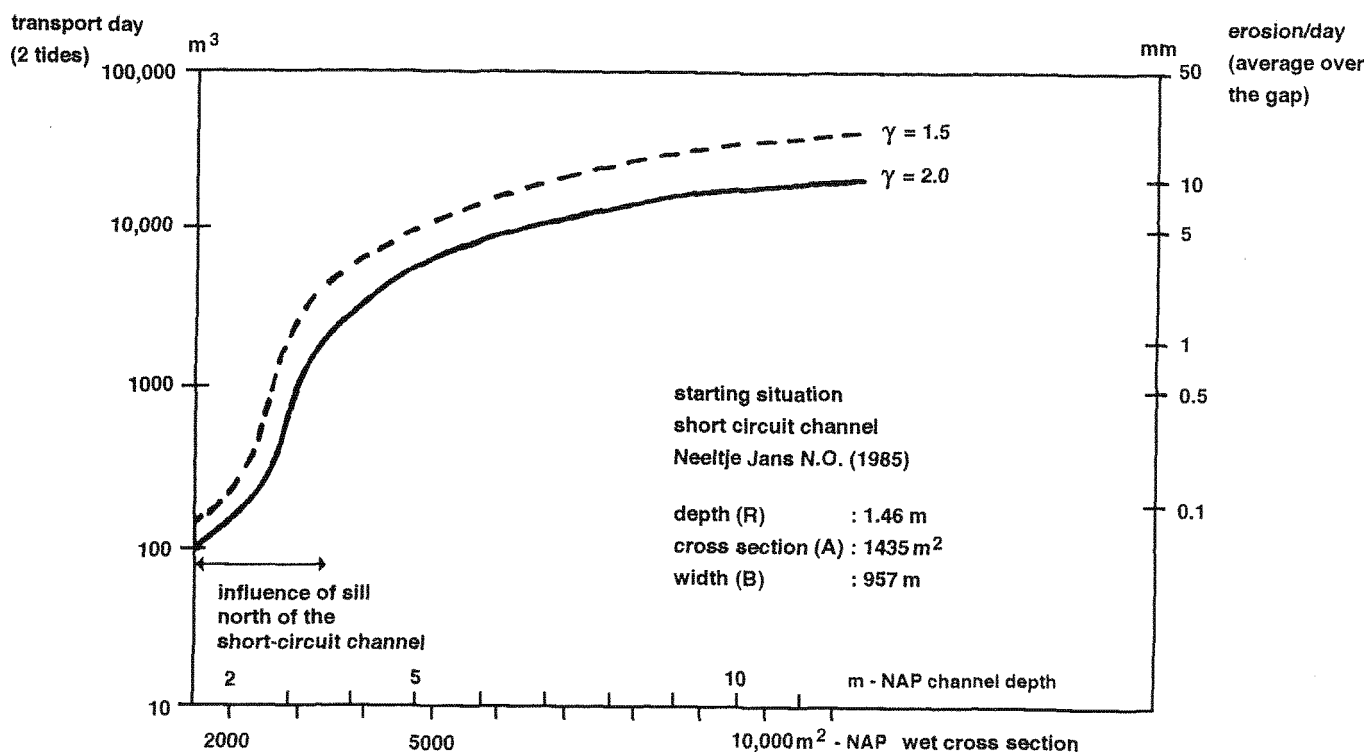

Fig. 12 Relation between the cross section of the Schaar-Roompot channel and the erosion per day in the situation that Schaar and Hammen have sill beams and Roompot only a sill.

mainly by vertical narrowing is reached, bed protection with an average length of 500 m is sufficient (Fig. 14).

This together with other arguments led to the choice of the so called 'letterbox' solution.

Sedimentation

To remove settled sand, equipment for laying mats and placing piers was supplied with a carefully designed suction system which cleaned the surfaces in the intervening periods.

In spite of all the provisions made to limit the amount of sand between the various layers, further research showed that the construction method and construction activities had to be carefully planned in order to avoid undesirable amounts of sedimentation.

During construction the mat or pier which has to be laid or placed, and also the suction mouth during the cleaning process, temporarily block the wet cross-section of the closure gap.

Research showed that all essential activities should be carried out during the turn of the tide, when the flow velocity would be low. The lay- and suction direction should be such that eroded material from the bed could not settle on the working surface cleared before.

Scour

When a flow slide takes place, instigated by a slide caused by a steep slope of the scour hole, the sand under the bed protection will flow away. This damages the bed protection locally, a.o. by development of open seams between the bed protection strips, which exposes the sand underneath to the erosion effects of the current, which results in receding erosion, that could eventually undermine the storm-surge barrier itself.

From this, and in view of the other uncertainties mentioned concerning occurrence and behaviour of flow slides, made the avoiding of flow slides along the edges of the bed protection a criterion. According to present knowledge, flow slides can only be prevented by compacting a strip on the bed along the edge of the bed protection.

The maximum depth of the soil that can be compacted with the available techniques is about 25 m. A true criterion for the design of the bed protection is created from this; namely, that the final maximum scour depth (h_{max}) is never allowed to exceed the limit of 25 m.

As a result of the construction phases (the placing of sill beams, closed gates) a strong increase in erosion can occur because of the temporary increase in local discharges. Besides erosion on the edges of the bed protection, this aspect is especially of importance in areas such as the Noord-Beveland bank. During the planning of the final construction the scour predictions were of importance because of the requirement that necessary future dumping could not exceed the dumping capacity. Anyway, extensive monitoring during the construction phases could be sufficient to take timely measures, such as rock dumping.

The rock dumping criterion in these areas was an erosion depth of 5 m at a slope of 1:3 or 1:4.

Short-circuit channels

Placing of sill beams

Model calculations showed that during the placing of sill beams there was hardly an increase of discharges in the short-circuit channel between Hammen and Schaar when Hammen had a maximum of 6 sills more than Schaar or when Schaar had a

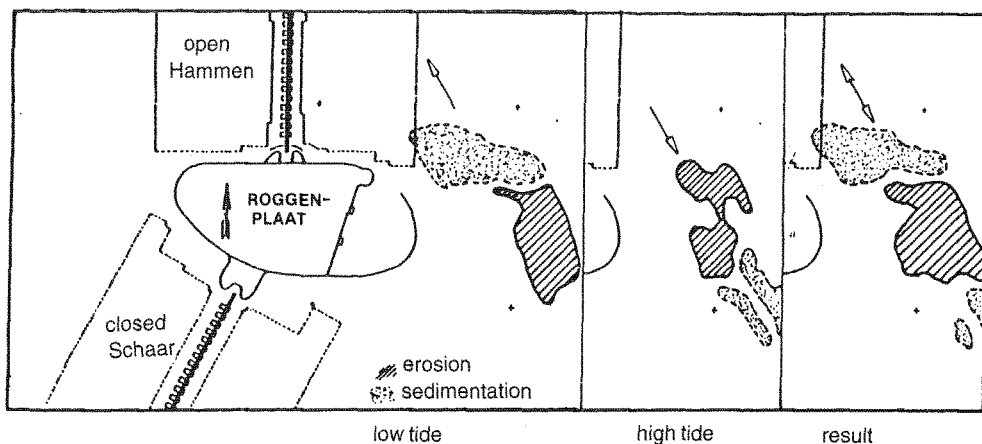

Fig. 13 Result of the SLUITZAK calculations on erosion/sedimentation in the short-circuit channel between Hammen and Schaar when the Schaar is closed.

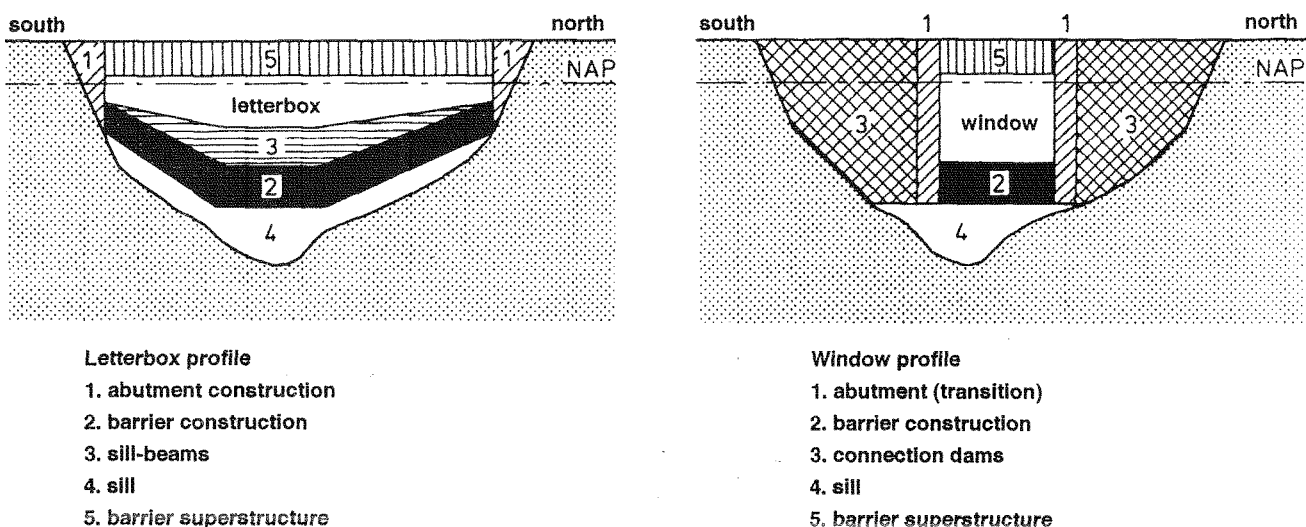

Fig. 14 Alternatives for restricting the flow profile: 'Letterbox'- and 'Window' profile.

maximum of 2 sills more than Hammen.

During the placing there was little or no erosion expected at the seaward side between Schaar and Hammen. On the Oosterschelde side this short-circuit connection was exposed to increasing flow velocities over the entire route because of high resistance of the shoals (very shallow). If, for what ever reason, a deepening occurred in the shoals area erosion would significantly increase. For this reason, it was decided to take preventive measures on the top of the ring dike of the Schaar construction pit by placing a gravel-blanket across the plate covering a length of several hundred meters. Because of this a spreading of hydraulic head occurred through which a sudden breakthrough would probably be smaller. Moreover, an obvious marked monitoring criterion was created.

The limits, which were put on the placing of sill beams by the formation of short-circuit channels were wide, certainly in the case that some erosion in the short-circuit channels was acceptable. With the exception of the connection between Schaar and East-Roompot, an extensive monitoring programme relating to occurring deepenings was sufficient. Besides

the construction of the above mentioned gravel blanket the connection between Schaar and East-Roompot needed extra monitoring. In the case of unacceptable deepening of the short-circuit channels, it is necessary to change over to, either the removal of the slanting closure gap situation or introduction of rock dumpings.

Closed gate situations

Closed gate situations, for the benefit of placing upper beams or for rock dumpings at the barrier, were limited. When situations get out of hand, the gates could be opened quickly (or the gates in the adjacent closure gap could be closed). The margin with regard to hydraulic head differences in the various short-circuit connections was then more flexible than during the placing of the sills.

Documentation

1 Anonymous, Onderzoek naar de mogelijkheid van afsluiting

van de Oosterschelde met een gedeeltelijke geprefabriceerde stormvloedkering, Deelnota 2, Hydraulische aspecten, Rijkswaterstaat, Den Haag december 1984

2 Anonymous, Onderzoek naar de mogelijkheid van de afsluiting van de Oosterschelde met een gedeeltelijk geprefabriceerde stormvloedkering, Eindrapport, Rijkswaterstaat, Den Haag mei 1976

3 Konter, J. e.a., Stormvloedkering Oosterschelde, Hydraulische aspecten, planning 700D, Burghsluis november 1984, nota 2PROBU-N-84129; 29VORM-N-84055

Literature

1 Blik A.J. e.a., Short-circuit channels in tidal estuaries, Uit S.Y. Wanga: Proceedings of the Third International Symposium on River Sedimentation, Vol III, Estuarine and Coastal Sedimentation. 1986 School of Engineering, University of Mississippi USA. Printed by McNaughton and Gunn, Inc. pp 300-309

2 Speekenbrink, H., Blik, A.J., Boon, T.J., Svasek, J.N., Van Wijngaarden, N.J.: Sedimentation in dredged trenches, uit: Paape A., e.a., Hydraulic aspects of Coastal structures, Part 2. Developments in Hydraulic Engineering, related to the design of the Oosterschelde Storm-Surge Barrier in the Netherlands, Delft University Press, 1980, pp 215-233

3 Driemaandelijks Bericht Deltawerken, Deltadienst Rijkswaterstaat, Den Haag:

- 71, febr '75 Bodemveranderingen in de monding van de Oosterschelde pp 15-19
- 72, mei '75 Hydrografisch onderzoek naar de invloed van de SVK op de omgeving pp 84-92
- 74, nov '75 De voortgang van het waterloopkundig en morfologisch onderzoek pp 206-212
- 76, mei '76 Waterloopkundige en hydrografische gevolgen voor het Oosterscheldebekken pp 312-323
- 76, mei '76 De waterloopkundige, hydrografische en ecologische gevolgen van de stormvloedkering voor de buitendelta en het aangrenzende kustgebied pp 332-350
- 86, nov '78 Hydraulisch onderzoek naar de lengte van de bodembescherming pp 305-308
- 86, nov '78 Aanzanding bij de drempelbouw pp 291-297
- 88, mei '79 De morfologie van de Oosterschelde pp 407-409
- 94, nov '80 Prognose van de bodemligging in de omgeving van de Oosterscheldekering tijdens de bouw pp 180-183
- 96, mei '81 Bodemfluctuaties in de Oosterschelde pp 305-308
- 99, febr '82 Aanzanding bij de bouw van de Oosterscheldekering pp 467-472
- 106, nov '83 Problematiek rond de randen van de bodembescherming pp 359-363
- 107, febr '84 De beheersing van de ontgrondingskuilen pp 294-298
- 108, mei '84 Een akoestische zandtransportmeter pp 430-437
- 110, nov '84 Zandconcentratievoorspellingen pp 541-545

4 Hydraulic aspects

4.1 Introduction

The most important requirements which the design for the storm-surge barrier in the Oosterschelde had to meet were to guarantee a tidal difference of 2.70 m in Yerseke (formation aspect open barrier) and to retain a storm-surge (strength aspect closed barrier).

According to the norms formulated by the Delta Committee a water barrier has to be designed at a decisive storm-surge level (water level with a probability of exceedance of 2.5×10^{-4} per year), in combination with a criterion for wave run-up.

For a conventional sea defence, such as a dike, an extreme water level can be used as a design criterion because overflowing forms one of the major threats.

However, as a result of an overflow, the storm-surge barrier in the Oosterschelde will not succumb. But on the other hand, a combination of a hydraulic head and a wave can be sufficient to seriously damage the barrier.

It is therefore necessary to interpret the 'Delta norm' in relation to the design of the storm-surge barrier. This is done by defining an extreme load combination which has a probability of exceedance of 2.5×10^{-4} per year (equal to the Delta norm).

This extreme load is the starting point for the entire design in relation to the final situation. After that, from a hydraulic point of view, two very different situations appear, namely the closed barrier (incidental event) and the open barrier (normal event). It

will be clear that the boundary conditions and also the design load for both situations are very different.

For most of the components, the design of a closed barrier is dominant (contribution to the total probability of failure) wherein the main boundary conditions are formed by the hydraulic head across the barrier and the wave condition.

In case of an open barrier the design boundary conditions are made up of a combination of waves and current.

During construction the hydraulic boundary conditions are also of importance. On the one hand for design aims (equipment, construction) and on the other as boundary conditions for the construction (workability). Important differences with the boundary conditions of the final phase exist, because the period of construction is limited, and because the acceptable probability of failure is higher. Because of this, the design boundary conditions for the construction phase are often lower than those for the final phase. However, on the other hand the construction does not possess full power during some of the building phases.

This chapter deals firstly, in Section 4.2, with the hydraulic boundary conditions for the closed barrier in the final phase. In this Section the probabilistic manipulation of data on water levels and waves is dealt with.

In connection with the boundary conditions for the open barrier (current and waves), Section 4.3 deals with the physical and mathematical models which are used for describing, in general, the water movement on the Oosterschelde basin, and in

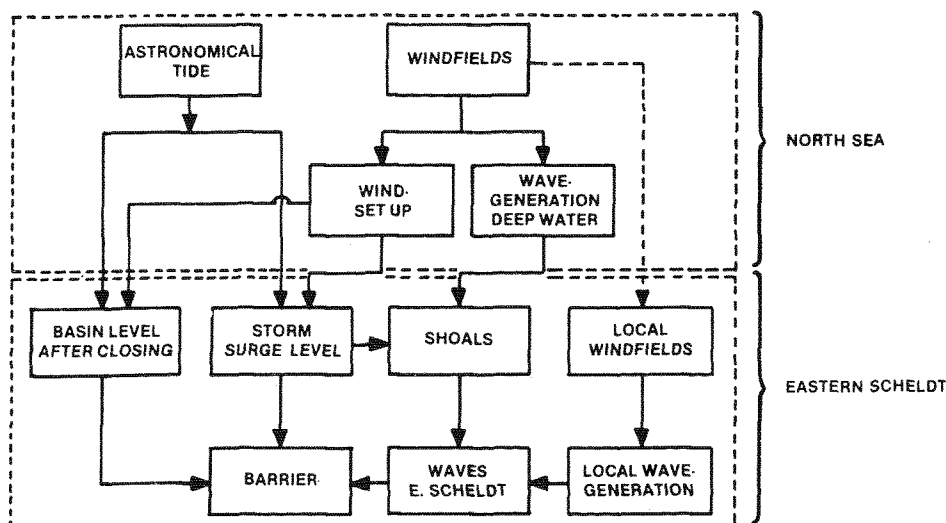

Fig. 15 A schematic diagram of the physical relations used for the derivation of the three-dimensional probability density function of storm-surge level, wave energy and basin water level.

more detail around the barrier. These models were used, amongst others, to convert water level data on the sea side of the barrier into current data for determining the current boundary conditions for the open barrier.

In Section 4.4 the transformation of the boundary conditions, into loads on the various construction components, is dealt with.

Finally, in Section 4.5 the boundary conditions in the construction phase, for the design of the barrier components and construction equipment and the workability on the construction site, is dealt with, after which a brief mention is made on the resulting building phase loads.

4.2 Data elaboration for the closed barrier

4.2.1 General overview

To make a probabilistic design of the storm-surge barrier, a statistical description of loads by means of probability density functions (p.d.f) is required. This means that, to begin with, the more-dimensional p.d.f. of the hydraulic boundary conditions (storm-surge level, inland water level and wave energy) has to be determined.

In principle, two methods are available to extrapolate the observations of the hydraulic boundary conditions and their mutual correlations, as far as available, to values with a low probability of occurrence (necessary for the design), where measurements are lacking:

- 1 A pure statistical extrapolation;
- 2 A statistical extrapolation supported by mathematical models based on physical laws. The mathematical models can be checked against observations.

A combination of these methods is applied to the calculation of the three-dimensional p.d.f. of storm-surge levels, wave energy and basin levels.

A schematic reproduction of the mathematical model which is used for this development is shown in Figure 15.

The p.d.f. of the high water levels is based on the statistical extrapolation of data from a 50 year long period of observations near Burghsluis. The physical knowledge of the storm-surge phenomenon which is caused by a combination of wind build-up in the North Sea and the astronomical high water, is only used by research if the extreme conditions predicted by statistical extrapolation are physically possible.

The opinion that a storm-surge is formed by a random combination of a wind build-up and the astronomical tide was utilized during the calculation of the conditional p.d.f. of basin water levels. The strategies, which were followed when closing the barrier during storm-surges, could simply be absorbed in the model. With the help of the model the conditional p.d.f. of basin water levels for a number of closure strategies was determined.

In addition to this a simple model has been developed which can describe the wave pattern on the Oosterschelde (right part of Figure 15). It is assumed that this wave pattern is made up of, on the one hand, a penetrating low frequency energy over the shoals and, on the other, of high frequency waves created by local wind fields. This model is used to determine the conditional two-dimensional p.d.f. of storm-surge levels and wave energy.

After it was proved that the wave energy and the basin water levels were statistically independent, the three-dimensional

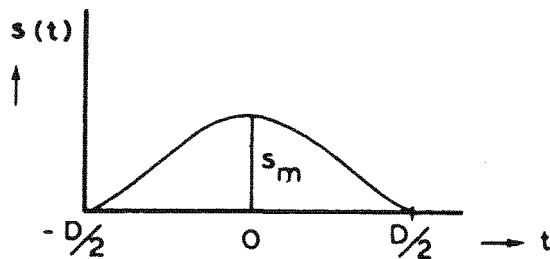

$$\underline{s}(t) = \underline{s}_m \cos^2\left(\frac{\pi t}{D}\right) \quad \text{voor } 0 \leq t \leq D$$

Fig. 16 The wind set up as a function of time.

p.d.f. of storm-surge levels, wave energy and basin water levels was derived as the product of the above mentioned conditional p.d.f.'s and the p.d.f. of the storm-surge levels. The result formed the starting-point of the calculation of the probability density function of the hydraulic load on the barrier (Section 4.4).

In the next Sections the models used to calculate the probability density function will be explained briefly. Document 1 contains more detailed information on this subject.

An abridged summary will be given consecutively on the way the models were used to derive at the three-dimensional probability density function of storm-surge levels, wave energy and basin water levels. This p.d.f. is used to obtain the p.d.f. of the boundary conditions for the closed barrier.

4.2.2 Storm surge levels

It is accepted that the storm-surge level consists of two statistically independent phenomena, namely:

- Wind set up;
- Astronomical tide.

The maximum wind set up is related to the wind field on the North Sea (via 9 hours of continuously exceeding wind velocity W9), while the course of the wind set up, as function of time, has been derived from 38 selected storms (Fig. 16)

$$s(t) = s_m \cos^2\left(\frac{\pi t}{D}\right)$$

in which s_m = maximum wind set up during the storm (= function of W9); D = the total duration of the wind set up.

Also, from measurements a formulation is determined of the probability of exceedance of the maximum wind set up during a storm:

$$\Pr(s_m > s) = \exp\left(\frac{1.53 - s}{0.3026}\right)$$

just as the p.d.f. of the storm duration p(D). The storm duration (D) is assumed to be independent of the wind velocity (W9). From this, the probability distribution of the wind set up as a function of time and the storm (W9) can be determined.

The astronomical tide is modelled as a harmonic variation of water levels (period $T_o = 12.4$ hours), with a 'Gaussian' distributed high water amplitude h_{HW} with an average M_{HW} and a

standard deviation δ while the low water amplitude is assumed to be dependently linear on the high water amplitude:

$$h_{LW} = 0.897 h_{HW} - 0.22$$

The astronomical tide is now determined by:

$$h(t) = \frac{h_{HW} - h_{LW}}{2} \sin \frac{2\pi}{T_o} (t + \Phi) + \frac{h_{HW} + h_{LW}}{2}$$

It is now assumed to be possible that a storm-surge level can be described via a linear super-position of a random astronomical tide and a random wind set up:

$$z(t) = h(t) + s(t)$$

from which the maximum occurs with a shifting phase Φ in relation to the astronomical tide (Fig. 17).

Because the probability distributions of the variables are known (Φ is assumed to be uniformly distributed), the distribution of the storm-surge levels can be calculated, assuming that the storm duration D and the wind set up are independent. When comparing the cumulative p.d.f derived from this with the exceedance curve, published by the Delta Committee, a good similarity can be seen (Fig. 18).

4.2.3 Basin water level

The models mentioned in the above Sections are also used to determine the probability distribution of the basin water levels when the barrier is closed.

The closing strategy for the barrier was: 'closing at low tide', which meant that the barrier is closed during the low tide preceding the high tide (storm-surge level) which is expected to exceed a certain sill level.

Using the model the two-dimensional p.d.f. is determined for the basin water level and the maximum sea water level by calculating the storm-surge level for the known values of Φ , h_{HW} , s_m and D , and then to determine the moment of closure and with that the basin water level (see Fig. 19).

$$z_{LW}(t_{closed}, h_{LW}, D, s_m) = h_{LW} + s(t_{closed})$$

By calculating the probability of occurrence of each combination of h_{HW} , s_m and D , just like the matching storm-surge level z_m and the basin water level z_{LW} (Fig. 20), the two-dimensional p.d.f. for the maximum storm-surge level and the basin water level can be calculated ($p(z_m, z_{LW})$).

In the afore mentioned, the two dimensional p.d.f. for basin water levels and storm-surge levels is explained, such as derived from the available measurement data. The influence of the barrier itself on the boundary conditions is not recorded. To include the influences of the closed barrier on the Oosterschelde basin (such as variations of the water level due to wind action, translatory waves, fluctuations and leakage), a correction of the calculated probability distribution function took place, which will not be further explained here.

4.2.4 Wave energy

In this Section the second part of the final three-dimensional p.d.f. of the environmental boundary conditions is explained, namely the two-dimensional p.d.f. of storm-surge levels and wave energy.

From wave observations carried out by the AOS IV measuring pole, in the mouth of the Oosterschelde, it was shown that there is a moderate correlation between the storm-surge level and the wave energy, and that the wave spectra are generally double topped during storm conditions.

However, the lack of sufficient wave observations prevented an extrapolation from the measurement data of the two-dimensional p.d.f. of storm-surge levels and wave energy with statistical techniques.

That is why a mathematical model was developed which is reproduced in diagram form in the right hand section of Figure 15. The model is based on the hypothesis that the typical double topped form of the wave spectrum is caused by the fact that wave energy is supplied by two sources. On the one hand low frequency energy penetrates from the North Sea via the bank area of the mouth of the Oosterschelde into the barrier. The amount of wave energy which remains in the bank, after breaking, bed dispersion and refraction caused by depth and

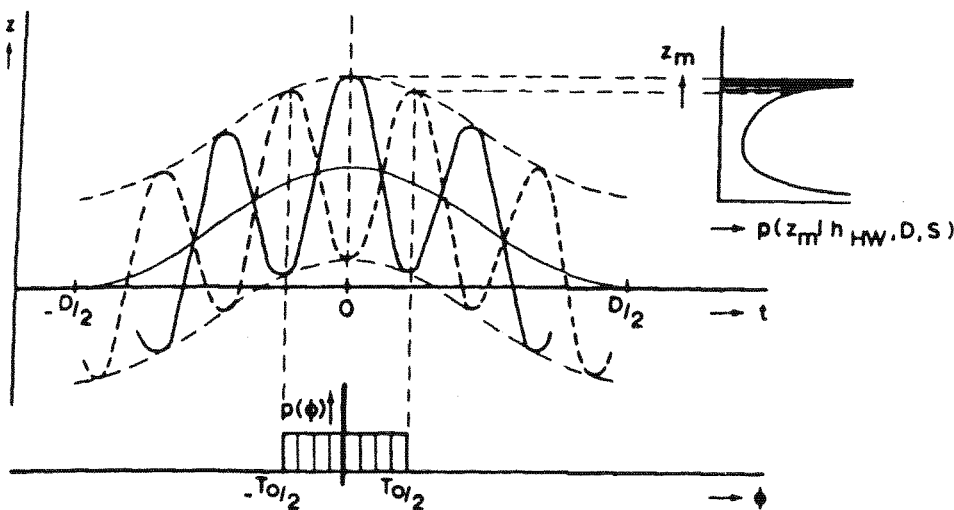

Fig. 17 Storm-surge level as a linear super-position of wind set up and astronomical tide.

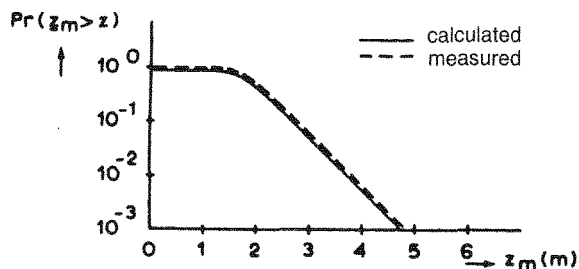

Fig. 18 Comparison between the calculated and measured exceedance line of maximum storm-surge levels.

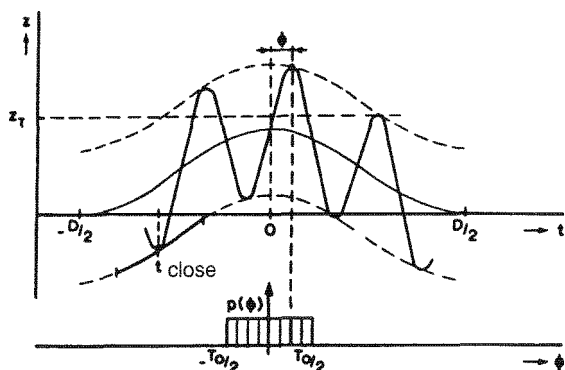

Fig. 19 The relationship between the maximum storm-surge level and the low tide level during closure.

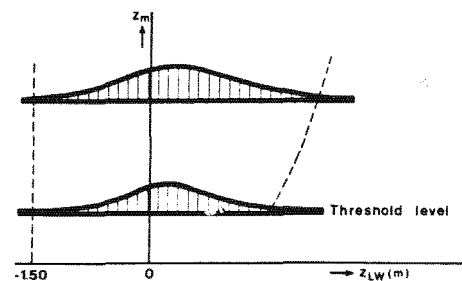

Fig. 20 The two-dimensional probability density function of the maximum storm-surge level and the low tide level during closure of the barrier.

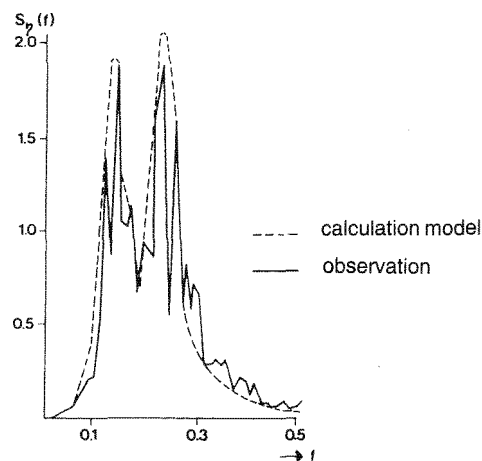

Fig. 21 Significant wave spectrum for the Oosterschelde.

current have taken their toll, is a function of the storm-surge level.

On the other hand, high frequency waves are caused in the mouth of the Oosterschelde by local wind fields which are somewhat similar to the general storm intensity. The low and high frequency wave energy together form the wave pattern close to the barrier which therefore causes a double peak spectrum (Fig. 21).

The calculation model which simulates the above mentioned effects has been tested in a simulation of a number of historical storms. Since the similarity between model and observation was satisfactory, the model was used for extrapolation of the provisional two-dimensional p.d.f. of storm-surge levels and wave energy. This was derived at as follows:

- The wave spectrum at the place of the barrier is mainly determined by the storm-surge level z and the local wind velocity v_w ;
- Storm-surge level z is determined by the astrological tide h and the wind set up s , whereby s is directly linked to the wind velocity on the southern part of the North Sea;
- The local wind velocity v_w can be linked to wind velocity on the North Sea. By taking into consideration a phase difference τ between the moment of occurrence of the maximum wind velocity and the maximum wind set up (approx. 6 hours) and the course of the wind velocity as a function of time, the provisional p.d.f. of an extreme storm-surge level and the local wind velocity can be calculated;
- Because of the fact that the final wave spectrum is determined both by the local wind field and the storm-surge level, with this model a significant wave height H_s and its probability of occurrence can be calculated for every combination of z and v_w . This finally determines the conditional probability density function of storm-surge levels and wave energy ($p(wz/z_m)$) (see Fig. 22).

4.2.5 The three-dimensional probability density function of storm-surge level, wave energy and basin water level

In the preceding Section the two-dimensional p.d.f. of the storm-surge level and the basin water level were described as $p(z_m, z_{LW})$ and the conditional p.d.f. of the storm-surge level and the local wind velocity (where at every point the wave spectrum is known ($p(w/z_m)$)) were determined.

The two p.d.f.'s can be combined to construct the required three-dimensional p.d.f. for the environmental boundary conditions, if the basin water level (z_{LW}) and the local wind velocity are independent. Seeing that the models used have shown that the basin water level is only slightly correlated with the maximum storm-surge level and that from historical data of significant wave heights and low waters no correlation is shown, the assumption of statistical independence is justified and the required after p.d.f. can finally be calculated via:

$$P(z_m, z_{LW}, w) = P(z_m, z_{LW}) \cdot P(w/z_m)$$

4.3 Data elaboration for the open barrier

4.3.1 General overview

In the operational phase with an open barrier, the boundary conditions for the hydraulic design are given by a combination of flow velocities and wave conditions, which are limited by the closure criterion of the barrier (Section 4.2.3).

The wave conditions can be calculated by using the model outlined in Section 4.2.4.

To determine the flow conditions, an extensive physical and mathematical model research was carried out, from which both for the operational phase (on behalf of the design) and for the construction phase (on behalf of design planning and workability), predictions of flow velocity are arrived at as a function of the vertical tide at sea (see Section 4.3.3).

Since both the line of exceedance for the vertical tide and the one for the parameters of the wave model are known, curves of equal probabilities of exceedance (combination of waves and current) can be determined.

The calibration of the physical and mathematical models used came about on the basis of prototype observations in the T0 situation (the initial situation), but also in later construction phases.

Flow experiments, or calculations with these models produced results for every construction phase, such as:

- The discharges through the closure gaps of the barrier;
- The flow velocity in and near the axis of the barrier;
- The hydraulic head in the barrier;
- Flow patterns around the construction;
- The water levels in the Oosterschelde basin;
- The wave climate and the wave load near to the barrier.

In 1982-83 a few of the calculation models and model data were combined into a numerical forecast system which, in principle, could be used operationally for long-, medium- and short term predictions.

The main difference between the areas of application was formed by the input data of the system.

For the long term predictions the input data consisted of the statistics of the vertical tide at sea, for the medium term it consisted of the expected astronomical vertical tide, and for the short term expectation the expected weather influences on the vertical tide were also taken into account. A division of the predictions of the named terms is given in Table 1.

After a short description of the available models, application and quality of the results will be considered in the framework of the hydraulic aspects. The aspects relating to the wave models will be discussed later.

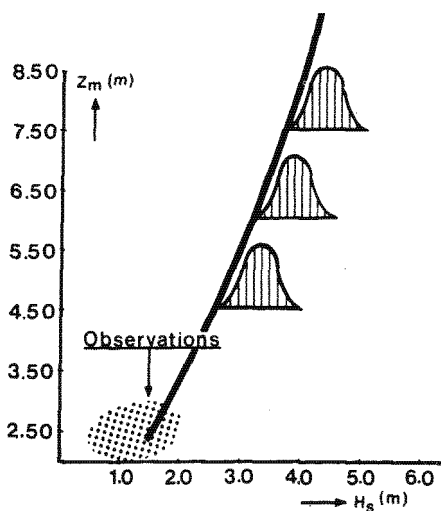

Fig. 22 The relation between the storm-surge level and the significant wave height; in the figure the conditional probability density function of H_s for a number of storm-surge levels has been given.

4.3.2 Models used for the Oosterschelde barrier

In order to determine the hydraulic boundary conditions in the design phase of the Delta Plan, the physical models M600 and M822 were constructed in 1959 and 1963 respectively.

In these models, research was particularly directed towards the alternatives for the definite closure in the south west of the Netherlands, including the Oosterschelde.

In 1968 Delft Hydraulics built the tidal model M1000 and the more detailed permanency model M1001.

Model M1000 shows the entire Oosterschelde basin on scale with the model boundary in the sea which lies outside the influence zone of the dam/barrier construction (Fig. 23).

These last mentioned models were used intensively in the seventies for both research for a complete closure and for a movable barrier, after the political decision in 1975.

The M1000 model was operated using boundary conditions which were based on prototype observations of astronomical predictions. The research focussed on all kinds of so called construction phase researches, of which discharge distribution, flow velocity and flow patterns were important results.

Model M1000 was replaced in 1984 by a numerical model and removed in 1986.

The M1001 models of the three closure gaps Hammen, Schaar and Roompot were operated with a pre-adjusted discharge (low tide/high tide) which resulted in a stationary flow pattern. The results gave information on the development of scour holes, damage patterns of the bed protection, flow patterns and the flow velocity distribution in the closure gap. They have also been used for load measurements on the construction equipment.

Besides the larger and smaller physical models, 'calculation models' have also been developed in which the time scale was often a fraction of the time scale of the M1000 model and the setting up of a certain building phase became more simple.

Therefore, in the 1950's, the Deltar (Delta-time-analogue-calculation machine) was built. Using imposed water levels, with this electrical analogue, water levels, discharges and velocities could be calculated (time scale 1:100), for different places in the basin.

Round 1970, a detailed Oosterschelde basin was schematised which was calibrated using prototype measurements.

In 1973, with the help of the Deltar schematisation and the results, the one-dimensional IMPLIC-calculation model was developed in which the time scale varied from 1:500-1000, depending on the computer used.

The schematisation used is reproduced in Figure 24.

After 1982 this calculation model, which was quick and reliable, became operational, which made it possible to carry out calculations for the short-, middle length- and long term. Sensitivity researches were also carried out with this calculation model.

The development of the 2-dimensional models (WAQUA models), which were dated 1968 has, relating to the Oosterschelde, directed itself on survey models (OOST models) and detail models for both the closure gaps of the barrier and the compartment works (DOOS models).

The results of the 2-dimensional models are particularly used for flow patterns, erosion calculations and for the calculation of discharge coefficients.

To be able to develop and to test all these models, measurement campaigns and permanent measurement set ups were

Table 1 Division of model predictions.

	Short term	Middle term	Long term
Vertical tide	Astronomical tide and wind set up	Astronomical tide	Statistics of tide and wind set up or specific tide
Construction phase of the barrier	Present construction phase	Present or future construction phase	Future construction phase
Aim of the prediction	Operational management	Work preparation	Design boundary conditions, strength demands, survival conditions and workability, time cycle considerations
Results of the predictions	Velocity curve	Velocity curve	Extreme velocity or standard velocity curve
Term	12-36 hours	week - 1-2 months	½ year - years

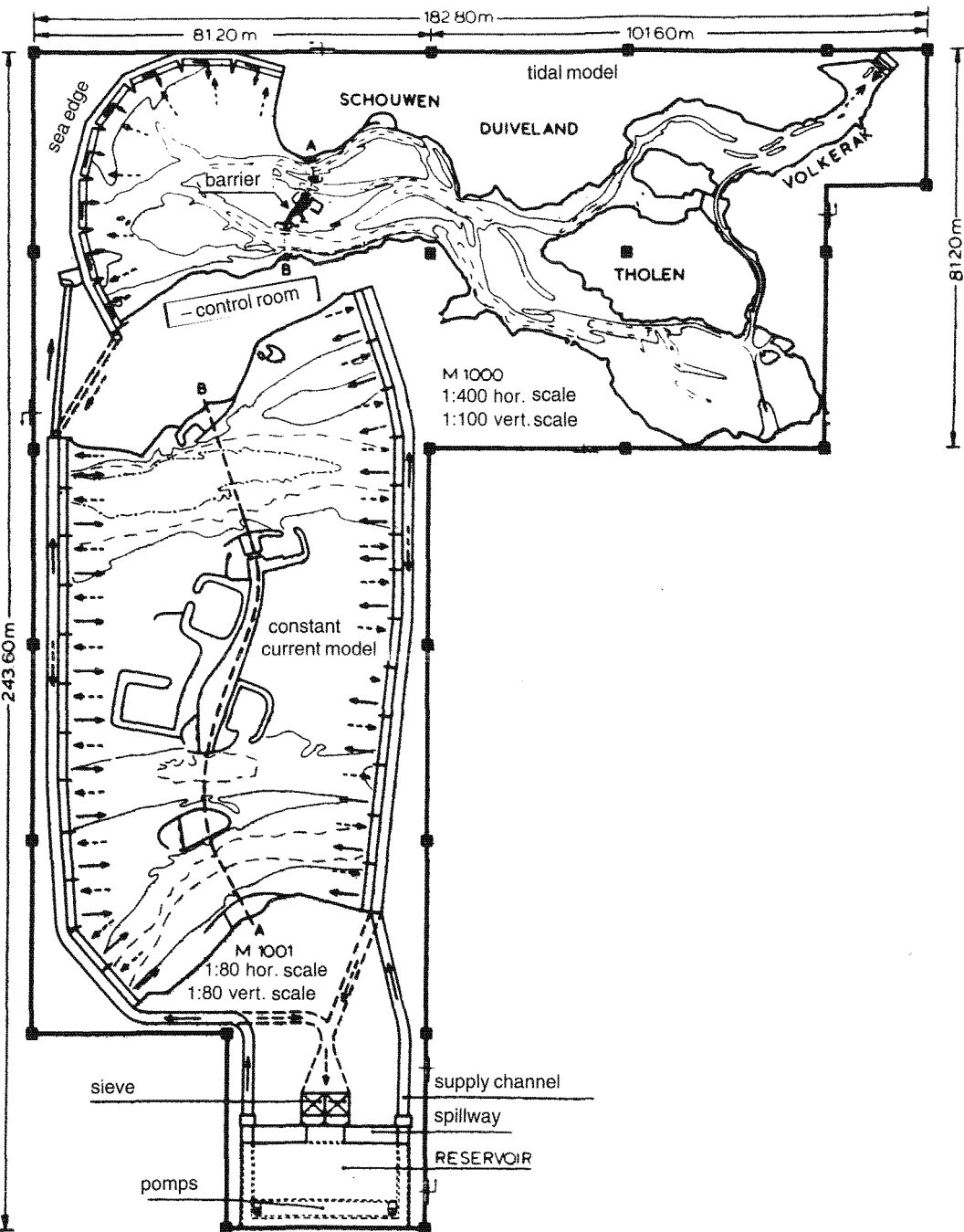

Fig. 23 Overview of the flow models M1000 and M1001 at Delft Hydraulics.

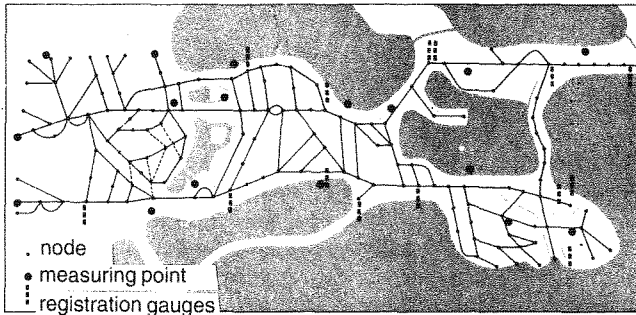

Fig. 24 IMPLIC-Scheme of the Oosterschelde, including measurement gauges of the HISTOS measurement net.

necessary. Especially, the measurement campaigns (velocity/discharge) were carried out by the Zierikzee Measurement Department where the data, which were gathered via the measurement gauges and buoys of the so called HISTOS measurement net, were also permanently monitored (Fig. 24). The following Sections will go into the hydraulic boundary conditions which were taken from prototype observations and model results.

In Table 2 these boundary conditions are schematically shown.

4.3.3 The tidal boundary conditions: The vertical tide

The water level on the boundary of the Oosterschelde basin is determined by the twice daily tide of the North Sea. Apart from the tide, meteorological effects play an important role in the occurring water level, especially during high tide.

On the basis of 50 years of observations close to Burghsluis, a probability distribution of the high tide level is made which is extrapolated in the frequency area where there were no observations. This distribution is especially important in connection with the design of the height of the various constructions (Fig. 25).

The hydraulic head at sea, however, is the driving force for the low- and high tide current in the mouth of the Oosterschelde. In addition to the discharges and velocities in the closure gaps, the hydraulic head at the boundary gauges of the HISTOS measurement net is for the different construction phases the main input for the hydraulic head and the related flow velocity in the basin.

The series of water level observations by OSIV between 1973 and 1983 provided results, which are used in general for the long term predictions for the construction of the barrier and the compartmenting works.

The probability distribution for average tidal conditions and extreme distribution values are shown in Table 3.

From boundary condition statistics (for the model), the probability distribution of discharges, velocities and water level differences can be calculated using the calculation models.

4.3.4 Discharges and current velocities at the barrier during the construction phase

Because of the construction of the Oosterschelde barrier the original closure gap cross section area decreases by approximately 77.500 m² to approximately 17.600 m². With this gap a hydraulic head of 2.73 m by Yerseke, during average tidal

conditions, is guaranteed (design requirement).

Because of increased resistance the discharges through the Hammen, Schaar and Roompot decrease. The velocities in the mouth and in the Oosterschelde basin will decrease. But, because the discharges through the closure gap do not decrease to the same extent as the closure gap cross section area, the flow velocity in the pier sections increase. On the basis of calculations with the IMPLIC 1-d model the closure gap discharges are calculated for a large number of construction phases. The gap velocities are calculated from the discharges with the R1495 model. This calculation model divides the closure gap discharges across the pier sections and is calibrated, using scale model tests in the M1000 and M1001 models.

The gap velocities were calculated as average for the entire pier section. The maximum velocity between two piers can, however, lie locally as much as 20-30% higher and runs up to 5 to 6 m/s in the final construction phase.

In Figure 26, for the closure gap Schaar, the relation between closure gap discharge, closure gap cross section and pier section velocity S08 is shown as a function of the construction phase.

In connection with the execution of the works in the closure gaps the long term predictions have been calculated for all construction phases, on which, among other things the workability percentages, are based. The predictions of the flow velocity are also used as boundary conditions for the design of tools during construction.

In so called oblique construction phases, with an asymmetrical reduction of the cross section area in a closure gap, oblique flow velocity components were created in the flow on both sides of the axis of the barrier. This could delay construction because the anchor forces on the construction vessels were difficult to predict. In the M1001 model visual current researches are carried out to obtain a better insight into these situations (see Fig. 27). The oblique construction phases especially arose when not all the sill beams in a closure gap were placed. The turbulence, a measurement for the variation in the flow velocity at a certain depth, is a parameter which describes the dynamic character of a flow.

Especially as a result of, the increased turbulence intensity in the area downstream of the construction the sand transport capacity of the flow increases locally, extensive research is carried out after this in the closure gaps of the M1001 model.

The research focussed mainly on the development of scour holes on both sides of the bed protection.

Because the maximum final depth of 25 m was not allowed to be exceeded anywhere, the scour hole length of the bed protection became 500-600 m.

4.3.5 Water levels and hydraulic head over the open barrier

During the design of the closure gap area, the preservation of a certain hydraulic head in the Oosterschelde basin during average tidal conditions is taken into account (design requirement, see Part 1, Section 3.1).

Principally, for the protection of the environmental values and fishery concerns on the Oosterschelde, also during the construction of the barrier and compartmenting dams, a minimum hydraulic head of 2.30 m during average conditions, was not allowed to be exceeded (see also Section 5.5).

For this reason, the hydraulic head at Yerseke is included and monitored in a lot of research and in calculations. As a result of

Table 2 Observation survey for determining hydraulic boundary conditions.

	Model					Prototype	
	M1000	M1001	Deltar	Implic	Waqua	Histos	Measurement service
Waterlevels	X	X	X	X	X	X	-
Hydraulic head	X	X	X	X	X	X	-
Discharges	X	-	X	X	X	-	X
Current velocity	X	X	X	X	X	X	X
Current pattern	X	X	-	-	X	-	X
Turbulence	-	X	-	-	-	-	X
Erosion, sediment transport	-	X	-	-	-	-	X

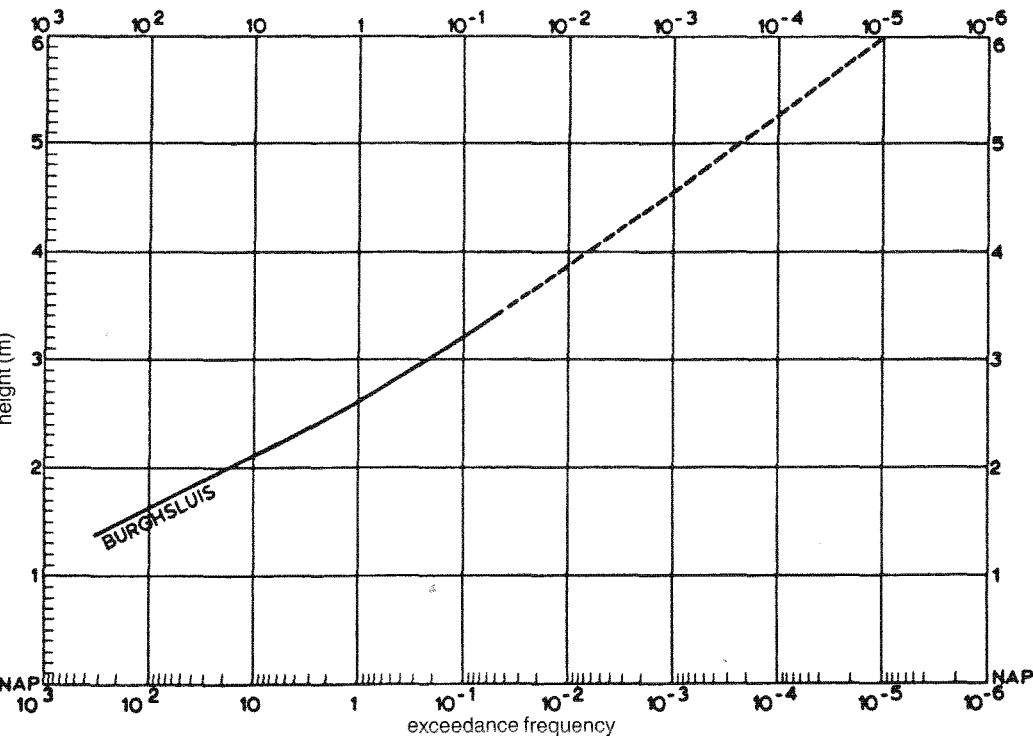

Fig. 25 Exceedance frequency for high tide at Burghsluis, based on observations from the period 1901-1950.

the increased resistance in the mouth of the Oosterschelde during the construction of the barrier, the tidal amplitude in the basin decreased.

This calculated hydraulic head at Yerseke is set out in Figure 28 for the period July 1986 to July 1987, wherein the last phases of the construction of the barrier occurred, with the most significant resistance, and the building of the compartmenting dams.

A few phases were planned up to the realization of the compartmenting dams, whereby the hydraulic head could be much reduced by manipulations with the gates. As a result of the leakage through the barrier, along the gates and through the sill, a minimal hydraulic head of 0.50 m was expected.

Extreme hydraulic head distributions across the closure gaps for an open barrier are given in Table 4, with and without the effect of the compartmenting works.

From this it was also shown that in the final phase, after the realization of the compartmenting works, the head losses across the open barrier have become, on average, lower than before.

The flow velocities in the pier sections of the barrier can be

determined, in general, by the hydraulic head across the open barrier that can be monitored by the water level measurement gauges of the HISTOS measurement net. An exception to this forms the case of a failing (open) gate in an otherwise closed barrier (see Section 4.3.6).

The previously mentioned gate manipulations were carried out to create favourable hydraulic conditions, that means to say lower flow velocities for the execution, both for the barrier and for the closure of the compartment dams.

However, by allowing a closure gap to be closed partially or completely, a redistribution of the discharge across the remaining closure gaps takes place. As a result of this, the hydraulic head increases, such as can be derived from the relation:

$$Q = \mu A \sqrt{2g\Delta h}$$

where Q = closure gap discharge; μ = contraction coefficient; A = closure gap area; g = gravitational constant; Δh = hydraulic head across the barrier.

This hydraulic head increase can rise to more than 50% across the closure gap which is being closed.

This is specially the case during ebb because then, to a much

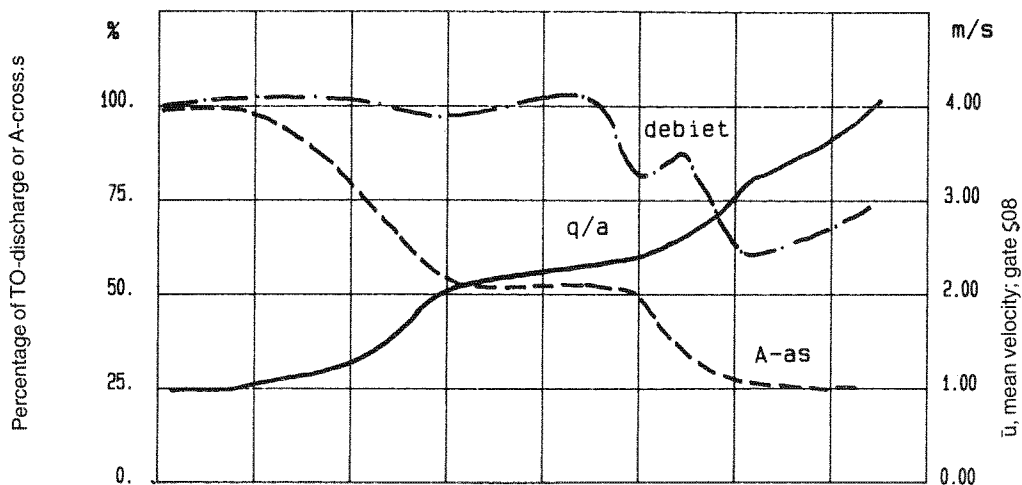

Construction stages in closure gaps

Hammen	piers	sill			beams			
Schaar		piers	sill		beams			
Roopot			piers	sill			beams	

Fig. 26 Predicted behaviour of discharge Schaar (PL700H).

Table 3 Extreme value distribution: hydraulic head at OS IV.

Frequency per year	Water descent (m)	Water ascent (m)
Average tide	2.82 (0.32 = σ)	2.82 (0.32 = σ)
2	3.65	3.72
1	3.75	3.81
0.5	3.85	3.89
0.2	3.98	4.00
0.1	4.07	4.09
$5 \cdot 10^{-2}$	4.17	4.17
$2 \cdot 10^{-2}$	4.30	4.28
10^{-2}	4.40	4.37
$5 \cdot 10^{-3}$	4.49	4.45
$2 \cdot 10^{-3}$	4.62	4.56
10^{-3}	4.72	4.65
$5 \cdot 10^{-4}$	4.81	4.73
$2.5 \cdot 10^{-4}$	4.91	4.81

Table 4 Hydraulic head in m across the closure gaps.

Frequency per year	Low tide without CT	Low tide with CT	High tide without CT	High tide with CT
2	1.22	0.99	1.39	1.17
1	1.26	1.03	1.43	1.21
0.5	1.31	1.07	1.48	1.26
0.2	1.36	1.12	1.54	1.31
0.1	1.40	1.16	1.58	1.35
10^{-2}	1.54	1.28	1.73	1.49
10^{-3}	1.68	1.40	1.87	1.62
$2.5 \cdot 10^{-4}$	1.76	1.48	1.96	1.70

CT = Compartmentalization of the Oosterschelde.

lesser degree, a redistribution of the total discharge across the three closure gaps can take place because of the shallows between the main channels.

This meant, for example, that with an average tide the ebb hydraulic head in the Roopot, without compartmenting (approx. 0.90), can be increased to a hydraulic head that would normally occur with a frequency of 10^{-1} per year. The relation between the extent of closure in the Roopot (A/A_0) and the relative increase of the flow velocity (through the larger hydraulic head) is represented in Figure 29.

A correct monitoring of the possible hydraulic head during gate manipulations in the construction phase was thus necessary, because the probability of exceedance of the design hydraulic heads were real. Also in the final phase when, for example, for

maintenance purposes a number of gates are closed, or by the opening of the barrier after a total closure, the hydraulic heads must be monitored across the open barrier, especially at ebb conditions.

4.3.6 The hydraulic head over the closed barrier

By gate manipulation in the storm-surge barrier two procedures can be distinguished, e.g. close all gates in connection with the fact that the sea water level has reached or will reach a certain boundary level, and gate manipulations to influence the tide in the basin in favour of certain activities (see also Part 5, Chapter 1). The observations already given in the previous paragraph apply for a partial closure.

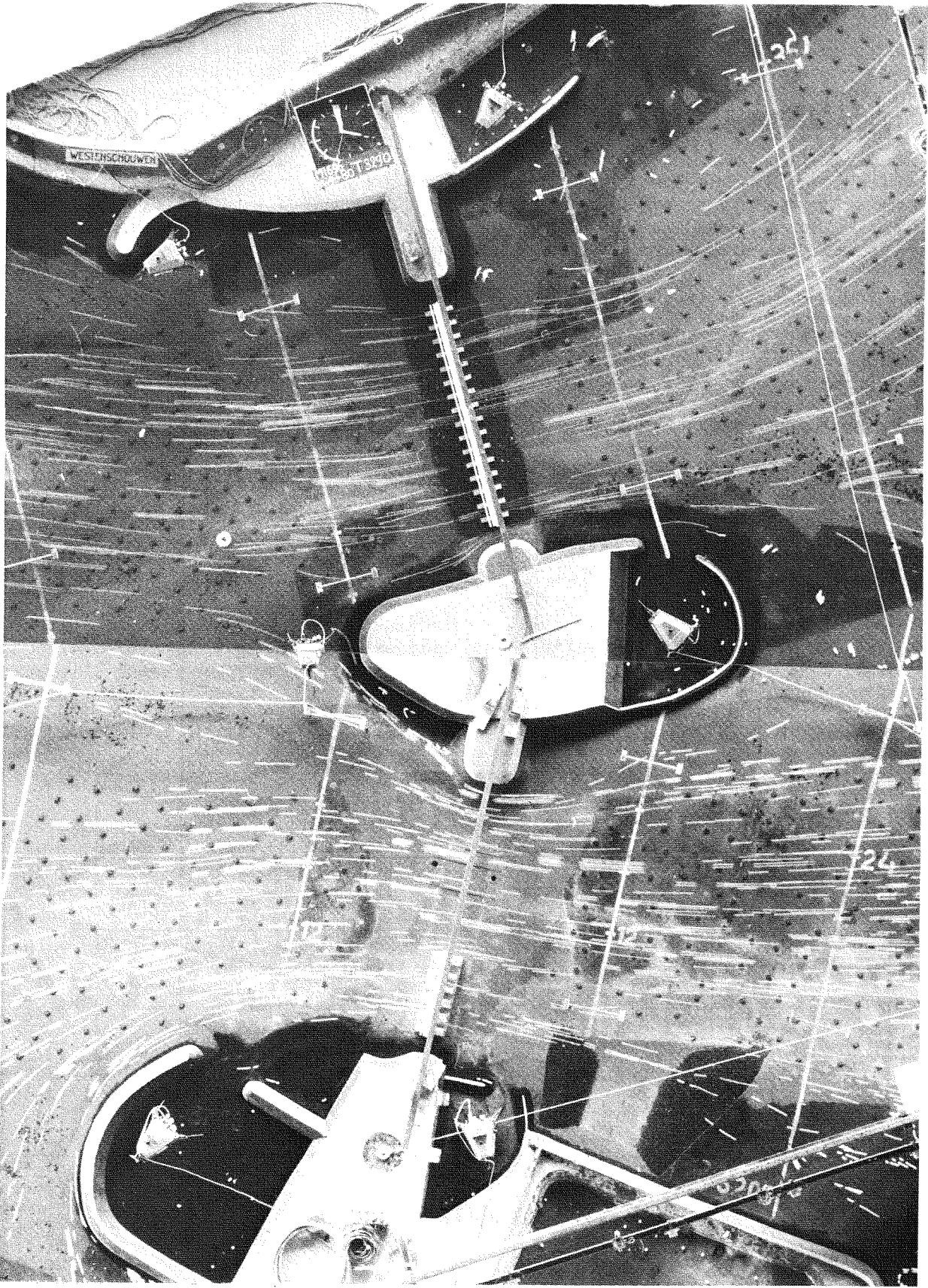

Fig. 27 Flow pattern Schaar and Hammen.

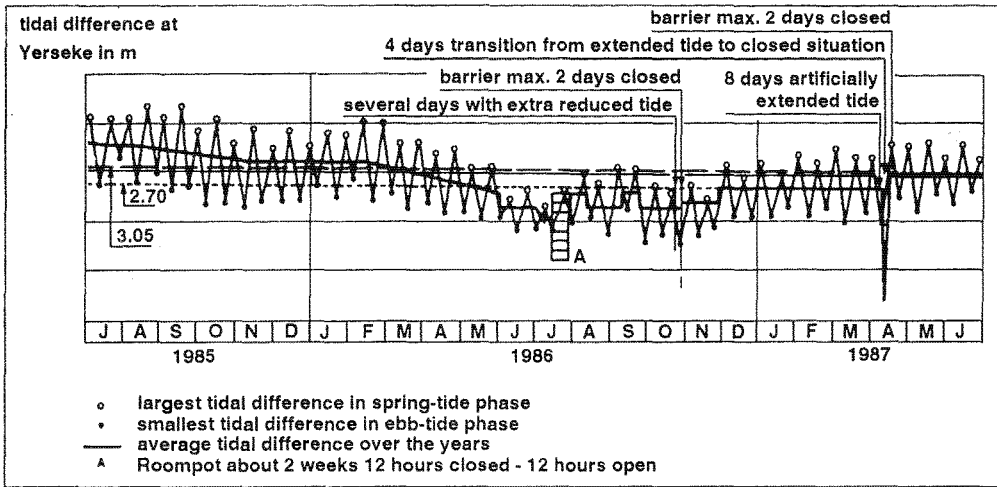

Fig. 28 Global behaviour of the hydraulic head at Yerseke.

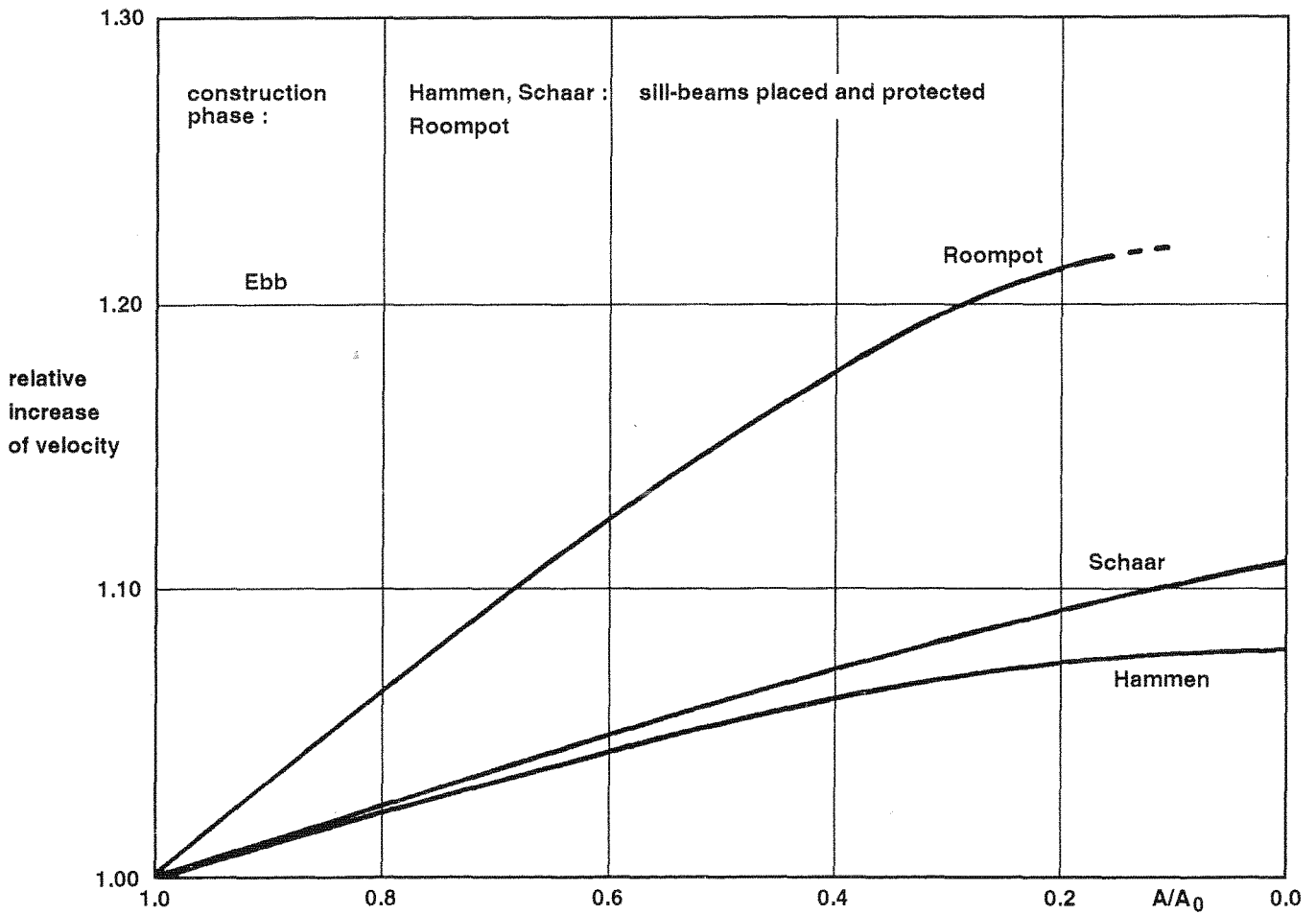

Fig. 29 Flow velocity increases in the Roompot; gate manipulations in the Roompot.

With a storm-surge closure, the maximum hydraulic head across the barrier is influenced by the time of closure and the closing strategy. Figure 30 gives the probabilities of exceedance of the hydraulic head across the closed barrier for different closing strategies.

In general, these hydraulic heads have no consequences for the current durability of the sill and the bed protection because then there will be practically no moving current.

An exception to this is formed by the situation, in which one or more gates fails to close during a storm-surge closure. Then a discharge into the Oosterschelde basin can occur through the pier sections involved with a big hydraulic head. The biggest hydraulic head occurs when only one gate fails.

For this situation the design hydraulic head is 4.20 m, taking into account the probability of that hydraulic head and the probability of a gate failure.

The negative hydraulic head across the closed barrier (sea water level lower than basin level) is decided by the Oosterschelde water level after a storm-surge closure, and the level of the following North Sea low tide, when the barrier remains closed. In general, this is an unusual situation which only occurs when, during an expected multi-peaked storm-surge, it has been decided not to open the barrier, or, by management failure, when the instructions to open the barrier are not given (in time).

The normal procedure is that the barrier will be opened with an equal inside- and outside water level with descending outside water.

The outside water level is dependent on the astronomical tide and the then valid meteorological influences, while the inside water level is determined to a significant degree by the resulting closing strategy.

Also with a negative hydraulic head across the closed barrier it is conceivable that one or more gates are not closed.

For this situation a design hydraulic head of 2.40 m is taken into consideration.

Further, in Section 4.4.2 an overview is given of the most significant hydraulic heads indicative for the design.

4.3.7 Monitoring and control

With each forecast, it has to be taken into account that the accuracy of the final result is limited. Therefore, measurements have to be carried out in the environment at set times to control the forecast system systematically, and if necessary, to adjust. The entire forecast system is then updated step by step.

At first, and on the basis of these environmental measurements, tests will be carried out to find out which models show defects, and how great these defects are. Dependent on the result, it will be decided if a new adjustment, or a readjustment of the model is necessary. For the check on the water level on the North Sea side it is necessary to regularly compare the predicted astronomical tide with the occurring tide.

By filtering the meteorological influence from the water level registrations, the quality of the predicted tide can be monitored. This was, and is, a constant issue of thought.

The reproduction of the water movement in the Oosterschelde basin was evaluated periodically by comparing the occurring water levels on both sides of the barrier, in the middle and at the end of the Oosterschelde basin with the results of a simulation with the IMPLIC tidal model. Systematic deviations show that the model schematisation was out of line. The possible causes, such as a change in the closure gap form, the flow situation, the roughness of the bed or a deviation in the estimated discharge coefficients of a closure gap, would be investigated; then adjustment of the model followed.

The differences between the R1495 model and reality were

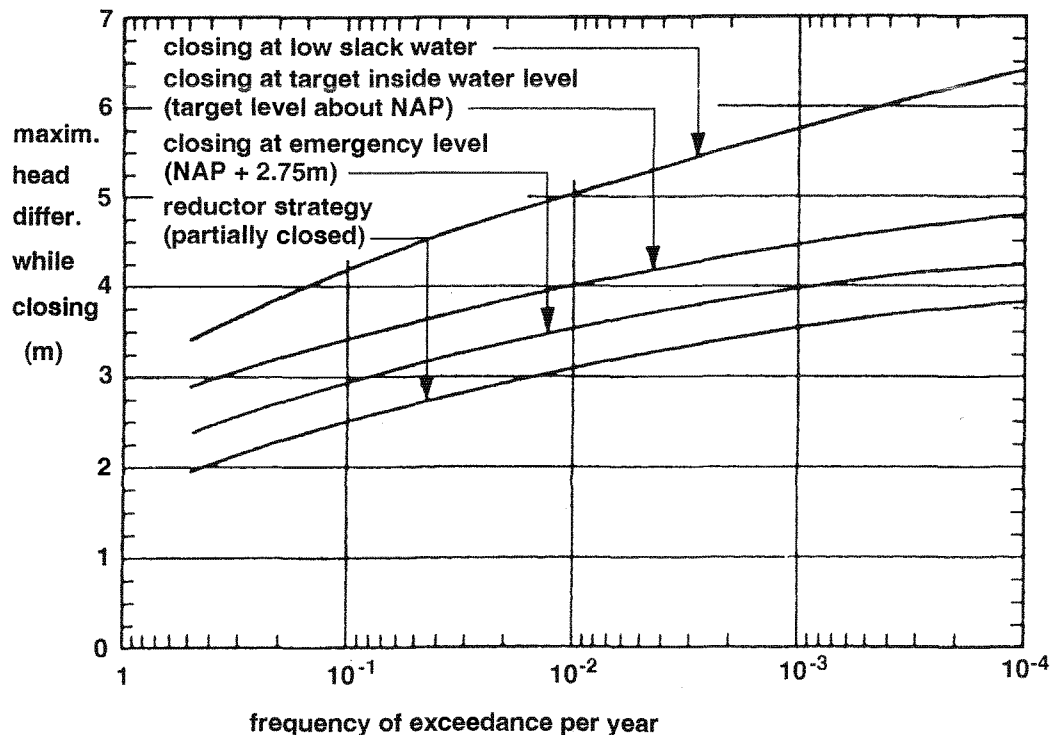

Fig. 30 Exceedance curves for the maximum hydraulic head after closure.

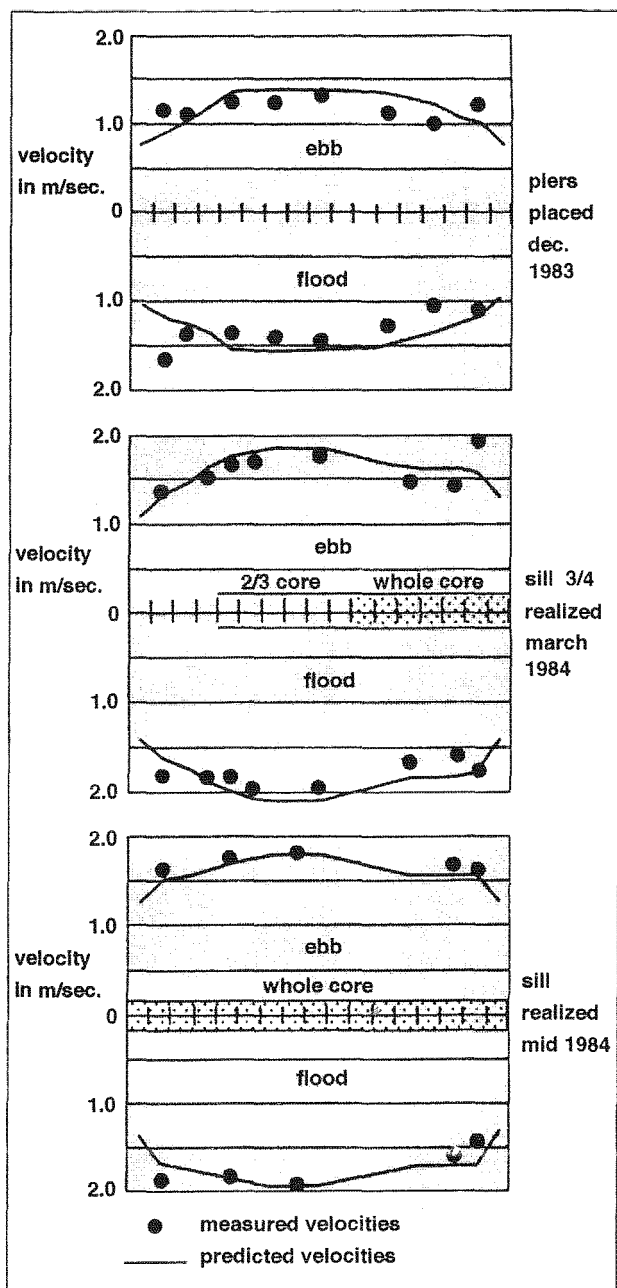

Fig. 31 Comparison between predicted (IMPLIC/R1495) and increased flow.

often traced back to interpolation errors between scale model results, and to differences in construction phases within the closure gap. The biggest defects were detected on the edges. The differences between model and reality were repeatedly smoothed out by the introduction of a correction factor. This correction factor had to be monitored at regular times by means of measurements (see Fig. 31).

By the simultaneous measurements of the closure gap discharge at 200 to 500 m before the barrier, and of the flow velocity in a relevant number of pier ports, the flow velocity and the distribution of the velocity across the flow could be determined, and compared with the outcome of the IMPLIC-R1495 model.

The aim of these monitoring measurements for the velocity

distribution in the pier sections was twofold. In the first place, a calibration could be carried out along these lines for the forecast system for the benefit of the operational support. In addition to this, and for the benefit of the design, calculated velocities per pier section were monitored.

The standard deviation of the predictions was, just after an adjustment, the smallest. The calibration worsened during progressive construction, so that the limits of reliability widened.

The frequency of prototype verification was determined by the progress of the closure gap form changes (Fig. 32), and by the accuracy requirements of the user.

4.4 Translation of the boundary conditions to hydraulic loads

4.4.1 Methodology

From the derived three-dimensional p.d.f. of the hydraulic boundary conditions for the closed barrier (Section 4.2.5), the probability distribution hydraulic loads are calculated from which finally the extreme loads, belonging to a probability of exceedance of 2.5×10^{-4} per year, can be determined.

The transformation of the hydraulic boundary conditions in the wave and hydraulic head loads on the barrier, occurs via transfer functions. These functions form the connection between the environmental conditions and the loads:

$$\begin{aligned} \text{hydraulic head load } S &= S(Z_m, Z_{LW}, \text{geometry}); \\ \text{wave load spectrum } S_w &= W(Z_m, S_{\eta}, \text{geometry}). \end{aligned}$$

In the case of the hydraulic head load, this function can be simply derived from the hydrostatic load distribution on both sides of the barrier and the flow in the sill around the pier foot. For the calculation of the wave load the linear wave theory is applied. The wave load ($w(t)$) is determined by the load distribution across the height which is caused by the incoming and the partially reflected sinusoidal wave.

The value of the transfer function is found by dividing the maximum of $W(t)$ by the amplitude of the incoming regular wave. By repeating this procedure for a large number of frequencies, the transfer function is fixed.

The transfer function is thus, in fact, the wave load which is caused by a regular wave with an amplitude of 1 m, represented as a function of the wave frequency.

If the linear system is taken for granted, the wave spectrum which describes an irregular wave image can be transformed in the spectrum force with the help of the transfer function (see Fig. 33).

The registration time of the irregular load image is fixed with the spectrum load (see Fig. 34). Supposing the spectrum is narrow enough, the individual maximum wave loads follow a Rayleigh distribution. The traditional parameters, the significant load W_s and the average wave loads period T_w are obtained by means of the known relations. Also the number of waves N inside a storm with a time D is fixed.

The linear assumption on which the spectral approach tolerability depends, such as mentioned above, was fully researched in the wave flumes of Delft Hydraulics. Many tests were carried out both with regular as well as with irregular waves to demonstrate the validity of the described calculation methods. The conclusion was that the results of model tests supported the

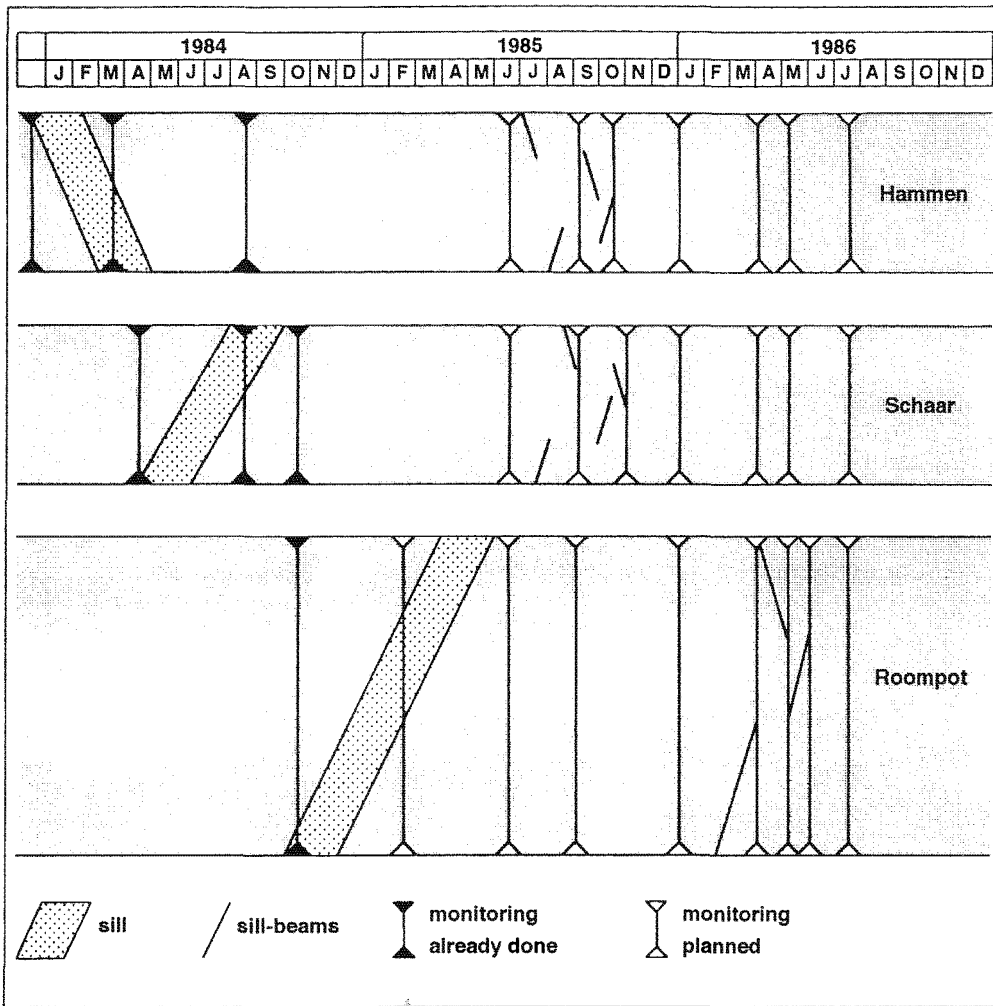

Fig. 32 Planning of control measurements.

mathematical model. The calculation models for the hydraulic head load and the wave load were adjusted in the subsequent calculations.

With the help of the transfer functions derived for the hydraulic head load and wave load, the derived three-dimensional p.d.f. of the boundary conditions described in Section 4.2.5 were transformed into the two-dimensional p.d.f. of the hydraulic head load and the significant wave load.

Numerically, this integration is carried out in two stages (see Fig. 35). Firstly, the probability of an integration block $\Delta z, \Delta b, \Delta S_\eta$ is fixed according to:

$$P_r(z, b, S_\eta) = f_{z, b, S_\eta}(z, b, S_\eta) \Delta z \cdot \Delta b \cdot \Delta S_\eta$$

Then, the probability contents of the block is put in the right place in the (S, W_s) -section. The place is determined by the hydraulic head load and the significant wave load, which belong to the boundary conditions (z, b, S_η) (see Fig. 35):

$$S = S(z, b)$$

$$W_s = W(z, S_\eta).$$

By repeating these procedures for all boundary conditions, the p.d.f. of the hydraulic head load and the wave load $f_{W_s, S}(W_s, S)$ is derived.

To conclude, the p.d.f. $f_{W_s, S}(W_s, S)$ has to be converted into the p.d.f. of the hydraulic head load and the individual wave load

maximum W , taking into account the character of the considered boundary conditions.

Three common cases for this are:

1 For boundary conditions, whereby in principle all load peaks are important, the Rayleigh distribution applies.

In the design of the storm-surge barrier, this distribution is applied with the fatigue calculations of the gate and for the calculation of continuous soil mechanical deformations.

2 Supposing a limit state is considered, whereby a once only excess of a certain loading level leads to failure, then the use of an extreme value distribution is required. This is applied by determining the maximum loads in the structural design of the piers, the sill beams, the upper beams and the gates.

3 Finally, the third possibility is failure after repeating exceedance of a stress level. In this case the binominal distribution can be applied to determine the probability of at least one exceedance by a stress peak of a certain level W within N maxima.

To find the probability density function of the individual wave load and hydraulic head load according to one of the three types mentioned, the probability contents $P_r(z, b, S_\eta)$ in the numerical process has to be replaced by the right distribution function.

Then a similar procedure follows and the selected probability density function is placed in the (W, S) section (see Fig. 35).

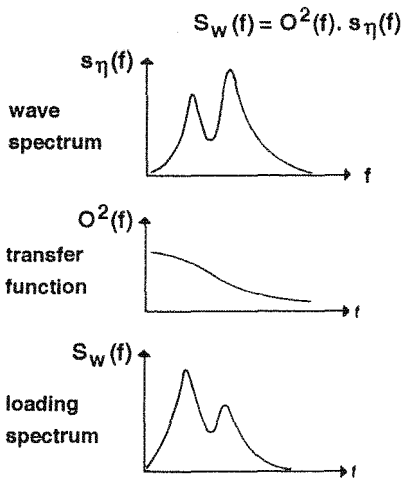

Fig. 33 Calculation of the force spectrum.

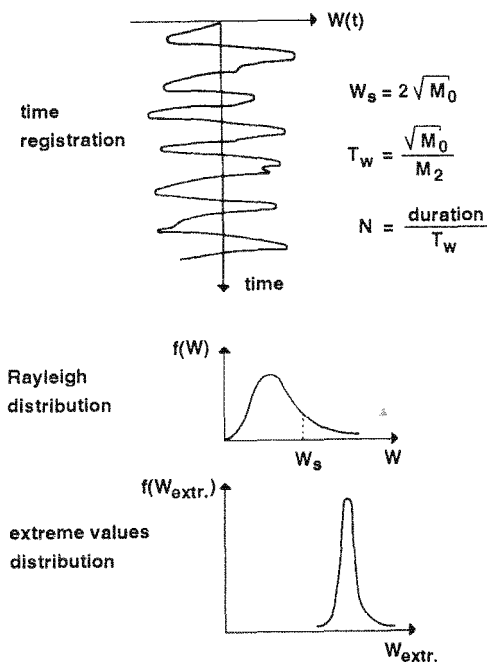

Fig. 34 Relation between the behaviour of the wave load in time and the probability density function of the extreme wave load.

The transformation of $F_{w,s}(W_s, S)$ into $f_{w,s}(W, S)$ is a fact as soon as the complete procedure is carried out for all points of the (z, b, S_η) -space and the result has been placed in the (S, W) section (see Fig. 36).

The last step includes the calculation of the line of exceedance of the total load for a certain limit state. For this it is necessary to know in which ratio the wave load and the hydraulic head load contribute to the limit state.

Generally formulated:

$$\underline{T} = \beta S + \underline{\gamma} W$$

The probability of exceedance can be calculated by integrating the p.d.f. $f_{w,s}(W, S)$ in the area where $\beta S + \underline{\gamma} W > T$ (Fig. 37).

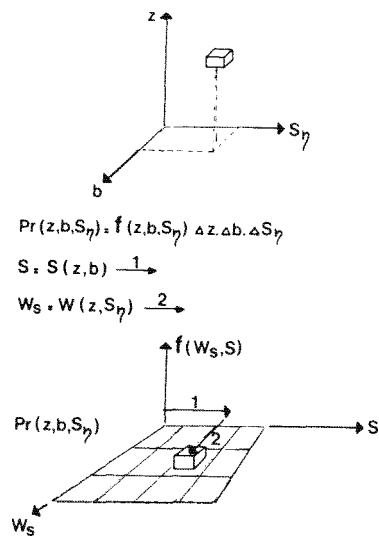

Fig. 35 Transformation of the probability density function of the environmental boundary conditions to the p.d.f. of the significant wave load and hydraulic head load.

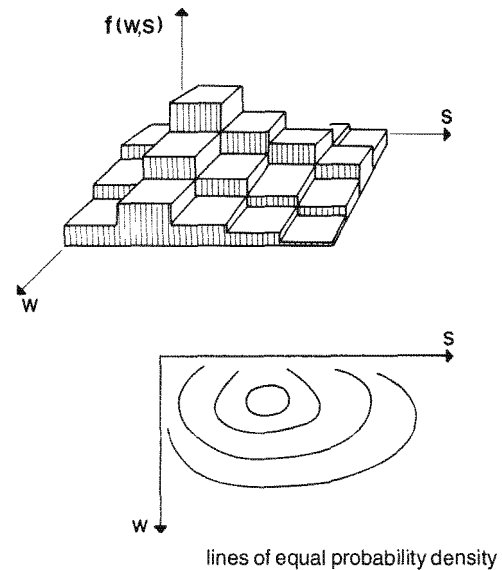

Fig. 36 Result, probability density function of wave load and hydraulic head load.

$$Pr(\underline{T} > T) = \int \int_{\beta S + \underline{\gamma} W} f_{w,s}(W, S) dW dS$$

The result, the probability that the total load T on, for instance, a pier will be exceeded, can be well approached with an extreme distribution (see Fig. 38).

4.4.2 Specific situations

With the help of the above mentioned generally applicable methodology, the lines of exceedance for the load of a number of essential components of the barrier can be determined for various operational situations of the barrier.

The environmental boundary conditions used in the calculations of the loads are the boundary conditions which are determined by the environmental boundary conditions' work group (see Doc. 1). The hydraulic boundary conditions are established in 'chances of exceedance of hydraulic heads and water levels of the storm-surge barrier Oosterschelde' (Doc. 4). The most important hydraulic heads and the accompanying probabilities of exceedance are summarized in Table 5.

These environmental boundary conditions were used in the calculation programmes SEAST 9 and PROBER. These programmes calculate the longitudinal forces on a closed storm-surge barrier with the help of a probabilistic method. SEAST 9 is an earlier version of the PROBER programme (Doc. 2). Notice DDWT-78.276 (Doc. 3) gives insight into the reliability of the result from SEAST 9.

A wave height with matching period and a hydraulic head with a certain inner and outer water level were established, with the SEAST9 (PROBER), from the probabilistically arranged total load (= wave + hydraulic head load) with a probability of exceedance of 2.5×10^{-4} per year. This wave height and

hydraulic head were used as semi-probabilistic boundary conditions to determine the stress patterns and the calculation of forces with a failing gate or during the closing procedure. To calculate the stress behaviour along the sill a wave was taken with a longer period, than the semi probabilistic wave, because waves with longer periods contribute the most to the probability of exceedance of 2.5×10^{-4} per year for load on the sill. Waves with shorter periods give no rise in load on the sill, because the wave load does not transmit to the bed.

Table 6 shows the analysed situations for the various components of the barrier, using the above mentioned methods. Document 6 contains more information.

4.5 Preconditions of the construction phase

4.5.1 Introduction

During the construction phase the hydraulic conditions are of importance for design purposes (materials, building phase load design) and for feasibility considerations (materials). In

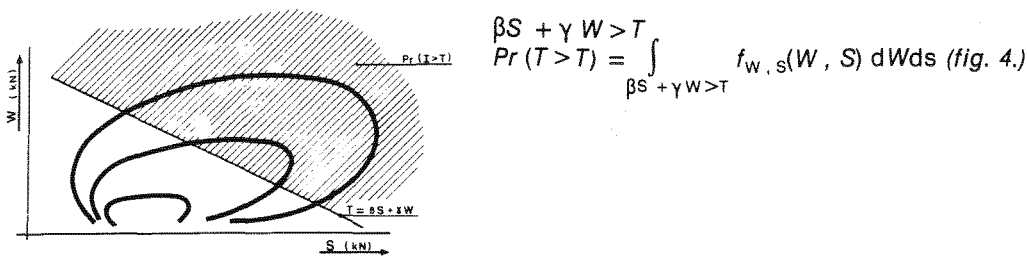

Fig. 37 The calculation of the probability of exceedance of the total load T.

Table 5 Probability of exceedance of hydraulic head for three management strategies.

Representative component	Design head (m)	Probability of exceedance				
		LWK strategy ⁵	Alarm level 1 strategy ⁵	Closing strategy 2-1-2 ⁵	Daily situation	
High tide						
Closing	Top layer sill operations work	4.20	$2.5 \cdot 10^{-4}$	$2.5 \cdot 10^{-4}$	$2.5 \cdot 10^{-4}$	
Closed	O.S. deposits	5.30 ⁴	$2.5 \cdot 10^{-4}$	$2.5 \cdot 10^{-4}$	$2.5 \cdot 10^{-4}$	
Closed + failing gate (open)	Top layer sill bed protection	4.15 ⁴	$2.5 \cdot 10^{-4}$	$2.5 \cdot 10^{-4}$	$2.5 \cdot 10^{-4}$	
Open	Operations work	2.50	$2.5 \cdot 10^{-4}$	$2.5 \cdot 10^{-4}$	$2.5 \cdot 10^{-4}$	
Open + failing gate (closed)	Bed protection	2.70	n.a.	n.a.	n.a.	$P_2 \cdot 10^{-3}$
Open	Bed protection	2.80	n.a.	n.a.	n.a.	$P_2 \cdot 10^{-3}$
Low tide						
Closing	Operations work	3.40	n.a.	n.a.	n.a.	
Closed	N.S. deposits	3.40 ³	$2.5 \cdot 10^{-4}$	$2.5 \cdot 10^{-4}$	$P_1 \cdot 10^{-4}$	
Closed + failing gate (open)	Top layer sill	2.40 ¹	$P_1 \cdot 2.5 \cdot 10^{-4}$	$P_1 \cdot 2.5 \cdot 10^{-4}$	$P_1 \cdot 10^{-4}$	
Opening	Bed protection	2.30		$P_1 \cdot 3.5 \cdot 10^{-2}$	$P_1 \cdot 10^{-2}$	
Open + failing gate (closed)	Bed protection	1.90	n.a.	n.a.	n.a.	$0.19 \times 3.3 \cdot 10^{-42}$
Open	Bed protection	2.30	n.a.	n.a.	n.a.	10^{-5}

¹Including probability of 1 failing gate (open) is 10^{-2} per closure. $P_1 = 10^{-4}$ probability that the barrier is opened when the water level seaward is lower than the water level O.S. side. $P_2 = 10^{-1}$ probability that the barrier is open during extreme boundary conditions.

²Including probability of failing gate (closed) = 0.19 per closure.

³Including fouling.

⁴Here use is made of the probability exceedance line of hydraulic head which takes into account leakage, wave overtopping and wind set up.

⁵For an explanation of the strategies see Part 5.5, Chapter 1.

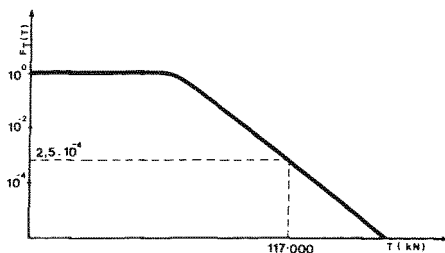

Fig. 38 The line of exceedance for the total load T on pier R17.

principle, the same probabilistic working method can be followed for design purposes as previously described in Section 4.2 and 4.4. Usually a simple semi-probabilistic approach is chosen which takes into consideration the limited period of exposure.

Feasibility considerations are based on the statistics of the daily hydraulic conditions. Because numerous surveys had been carried out in the Oosterschelde area, these statistics were sufficiently known. This is valid in particular for the undisturbed situation. The Databank Book (Doc. 6) gives a good overview of this.

In subsequent construction phases, when the barrier obviously began to disturb the hydraulic boundary conditions, support was particularly sought from models and transformations. This was also valid for the operational management with hydraulic predictions.

Firstly, the wave models for the construction phase will be dealt with, then we will deal with the hydraulic conditions and finally we will discuss the construction phase loads.

4.5.2 Wave models for the construction phase

For the benefit of the construction phase a large number of wave models were used. This large number was especially focussed on the operational management. For design purposes the wave model described in Section 4.2.4 was constantly used.

The calculation system was built up as a chain of models (see Fig. 39) in which during the operational management the possibility to adjust still existed (input meteorologist and hydraulic engineer). By means of this chain the system was divided into a number of specific subsystems.

For both the North Sea and the Oosterschelde various wave models were available. Physical mathematical models and correlation models were in use.

The wave models used by the Dutch Meteorological Office to predict waves on the boundary of the Oosterschelde, were the well known GONO-model, the Kruseman method and a wave/wind relation.

GONO is a physical mathematical model. For the North Sea it calculates according to a regular net-work with distances between the grid points of 75 km sea waves from the prevailing wind fields (either predicted or actually present). For a few locations, such as Eurogeul and IJmuiden, the swell is added to it. This is done by checking each grid point to find out if the swell will be able to reach those locations.

Therefore, GONO calculates both sea and swell. The Eurogeul location was used to set up the boundary condition for the boundary of the Oosterschelde in the place of location BG II (see Fig. 40).

The Kruseman-method is made up of 14 sections on the North Sea. For every section the sea field is determined from the occurring or predicted wind, and from this, by means of tables, the low frequency energy contribution is calculated at the Eurogeul location. The tables are based on the physical process which play a role. In the past, the method used was carried out manually, but nowadays it is automated. Actual wave data of the North Sea can be simply included which, for the better, increases the reliability. The wave/wind relations are statistical relationships for a certain location between on the one hand wave parameters, such as wave height and wave duration, and on the other the local wind. The relationships are mostly used for swell.

The correlation models MDC4 and MDC5 were used for the transformation of waves at the boundary of the Oosterschelde, across the shallow channels and banks area to the edge of the alignment. These Multi Dimensional Correlation models describe the wave parameters as a linear combination of the boundary conditions. In MDC5 the four boundary conditions are: the wave at BG II, the wind, the water level and the flow, and a constant; so that in this model five coefficients have to be dealt with. With MDC4 there is one less: the wave boundary condition is lacking at BG II. MDC4 is therefore less suitable for determining swell. The above mentioned coefficients are determined for a large number of wind and flow directions. Both models are very precise.

The transformation to the work location was built using two components. A simple linear transmission function was employed which was only dependent on the tidal phase up to 200 m before the axis of the alignment. For work locations closer to the axis or east of the barrier it appeared from M1752 research (wave influence and current during the construction phase) that the locally strong current had a strong influence on the waves. Therefore, a wave model was developed which took into account the influence of the local current.

This so-called EXCO model is based on physical relationships such as flow refraction and was calibrated with the help of measurements in and around the barrier. Because the influence of the current on the waves very much depends on the wave period, it is necessary to use a wave spectrum here. A parametric spectrum model was used which was especially developed for the Oosterschelde. The spectral form parameters were determined from relationships with the significant

Table 6

	Hydraulic loads on					
	Pier	Sill	Sill	Gate	Upper	Column
			beam		beam	v.k.k.
Closed storm-surge barrier	X	X	X	X	X	X
Jammed storm-surge barrier	X	X	X	X	X	X
Closed or open storm-surge barrier	X	X	X	X	X	
Diagonal force	X					
Construction phase force	X					
Oblique waves				X		
Daily circumstances				X		
Ice force				X	X	

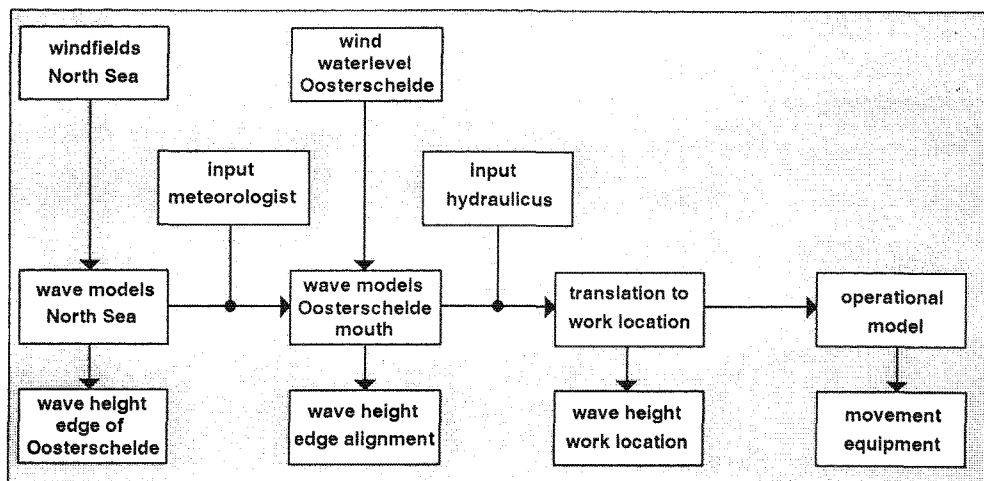

Fig. 39 Schematic representation of the calculation method.

wave parameters. These relationships are statistically determined from a large number of measured spectra.

The last link in the system was the calculation of the movement of the construction equipment. Although this does not greatly concern a wave model, it does have a strong relationship with it. The movement of a ship is strongly dependent on the wave period with which it is affected. A transmission value can be established per wave period. By multiplying the wave spectrum per period with this transmission value, a movement spectrum is created (Fig. 41). The transmission functions of the relevant movements are calculated in advance. Verification studies have shown that the transmission functions so obtained are sufficiently reliable.

4.5.3 Determining the boundary conditions with regard to the design

For the design conditions in the construction phase waves and/or currents were of particularly importance. Usually a semi-probabilistic method was followed to establish these design conditions. A design condition was chosen with a certain probability of exceedance.

With regard to the waves, the line of exceedance for the wave height followed from the methodology used for the final phase design (see Section 4.2.4).

This also applied to the wave conditions on the Oosterschelde side of the barrier. This means that during construction phase no consideration is given to eventual reduction of wave conditions by the barrier. Figure 42 shows the line of exceedance of the wave height.

Normal distributions were maintained for the flow whereby mean and standard deviation were, for that matter, still dependent on the exposition period.

A method for considering the limited exposition period is set out below.

Methodology for a limited exposition period

Generally, the method can be described as follows.

The exposition period can be expressed in the number (N) of tides or (N) high tides. It is assumed that every high tide has an equal probability distribution for an extreme high water level and that the N realizations were mutually independent.

The probability of exceedance Q_N of an N times repeated event with a probability of exceedance Q is determined by means of the following equation:

$$Q_N = 1 - (1 - Q)^N$$

When the probability of exceedance (Q_N) of the wave height is established during the exposition period, the probability of exceedance (Q) per event can be determined by the following inverse relationship:

$$Q = 1 - (1 - Q_N)^{1/N}$$

To find the wave height belonging to the probability of exceedance per event, one has to determine first of all the number of high tides per year (horizontal axis of Fig. 43). This is carried following the relationship:

$$Q = n/705$$

The wave height can be found with the value n according to:

$$n = 705 * [1 - (1 - Q_N)^{1/N}]$$

In particular in later construction phases the flow played an important role. That is why the combinations of wave- and flow boundary conditions were important.

It is assumed that waves and current are not correlated. This is acceptable for extreme conditions, although a little pessimistic. This means that for the probability of exceedance of a combination it suffices the relationship:

$$Q_{H,V} = Q_H * Q_V$$

where Q_V is the probability of exceedance of the flow.

Document 7 explains the determination of the value Q_V , dependent on the exposition period.

Numerous combinations of Q_H and Q_V belong to the value $Q_{H,V}$ and with that many velocities and wave heights. In practice two combinations are continually given, one whereby the probability of wave is high and the other of flow small and reversed. One or the other depends obviously upon the sensitivity of the construction vessel or construction (component) for wave and flow.

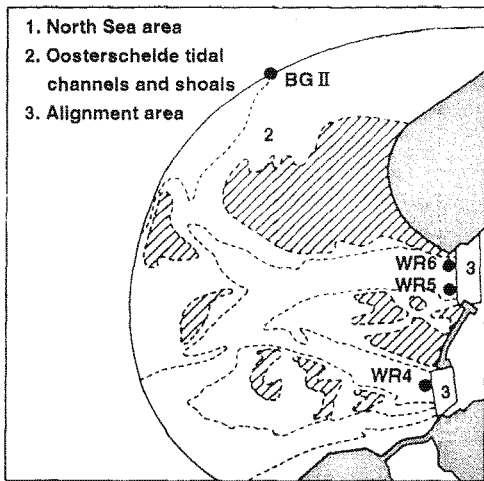

Fig. 40 Division of areas.

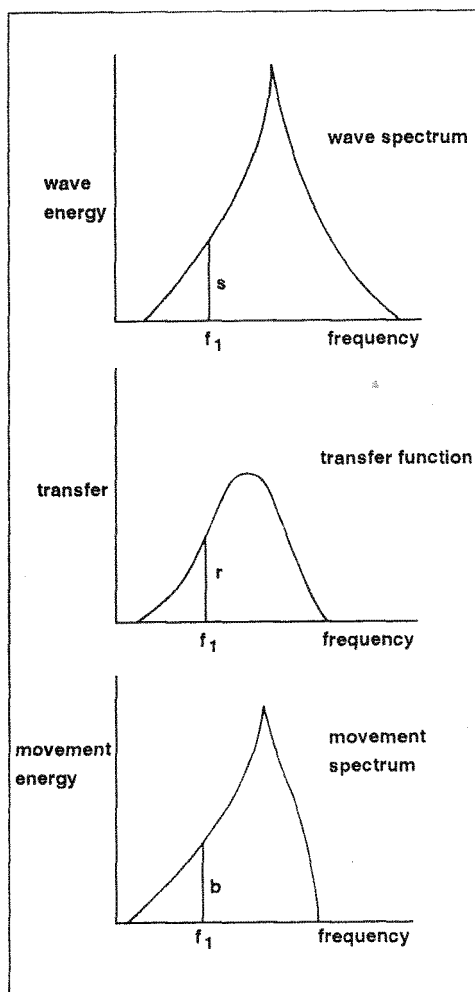

Fig. 41 Schematic reproduction of calculation of responses.

1% probability in the exposition period

The starting-point for the determination of the boundary conditions has been that a 1% probability of exceedance in the exposition period was acceptable. Ostrea was the exception. Consideration was taken for the fact

Table 7 Hydraulic boundary conditions for the work ships (combinations) for the pier-operation placement.

	H_s	Vstr (m/s)
Ostrea	1.70	–
Macoma	2.50	–
Mac + Os	1.70	2.05
	1.30	2.50
Mac + Dos I	2.30	2.05
	1.80	2.30

that Ostrea would only be going into the closure gap under certain conditions and could escape by expected bad conditions.

Also taken into consideration is the accuracy of the HMC (Hydro Meteo Centre) predictions. As an example, Table 7 shows the boundary conditions for the placement pier operation. Figure 43 shows the design wave spectrum of the Ostrea.

Particularly, during the construction phases – because the calculation models for ships movements became operational – numerous survival analyses were carried out (see Doc. 8). In one case this has led to the adjustment of the design boundary conditions (combination MacDos).

4.5.4 Determining the boundary conditions with regard to the workability

Generally, workability can be described as the percentage of time that maximum tolerable responses (such as displacements, velocities or accelerations) of certain parts of the construction vessels are not being met. The contributions of the waves to these responses can be described via a response-transmission function. By multiplying the wave spectrum with the transfer function, a movement spectrum is created (see Fig. 41) from which significant movement parameters can be derived (such as significant movements, peak frequencies). Because each ship has its own specific transfer function it is hard to formulate a general workability spectrum. This has been eventually tried with the help of standard transfer functions. With that, the starting-point is a workability of 80% to 90%.

Methodology

For determining the workability spectra a standard form of the wave spectrum is used as follows:

$$S(f) = \alpha f_p^{-9.5} \cdot f^6 \quad 0 \leq f \leq f_p$$

$$= \alpha f^{-3.5} \quad f > f_p$$

where α = proportionality constant, f = frequency and f_p = peak frequency ($f_p = 1/T_p$ with T_p the peak period).

Another starting-point was the standard transfer functions for large and small (auxiliary) equipment according to Figure 44. By a combination of spectrum form, the transfer function and the statistics of x and f_p (from measurements), the probability of exceedance (= workability) of a significant movement could be determined.

Because more spectra (α, f_p combinations) belong to one significant movement, a representative spectrum has to be selected. Different spectra are provided for high- and low tide.

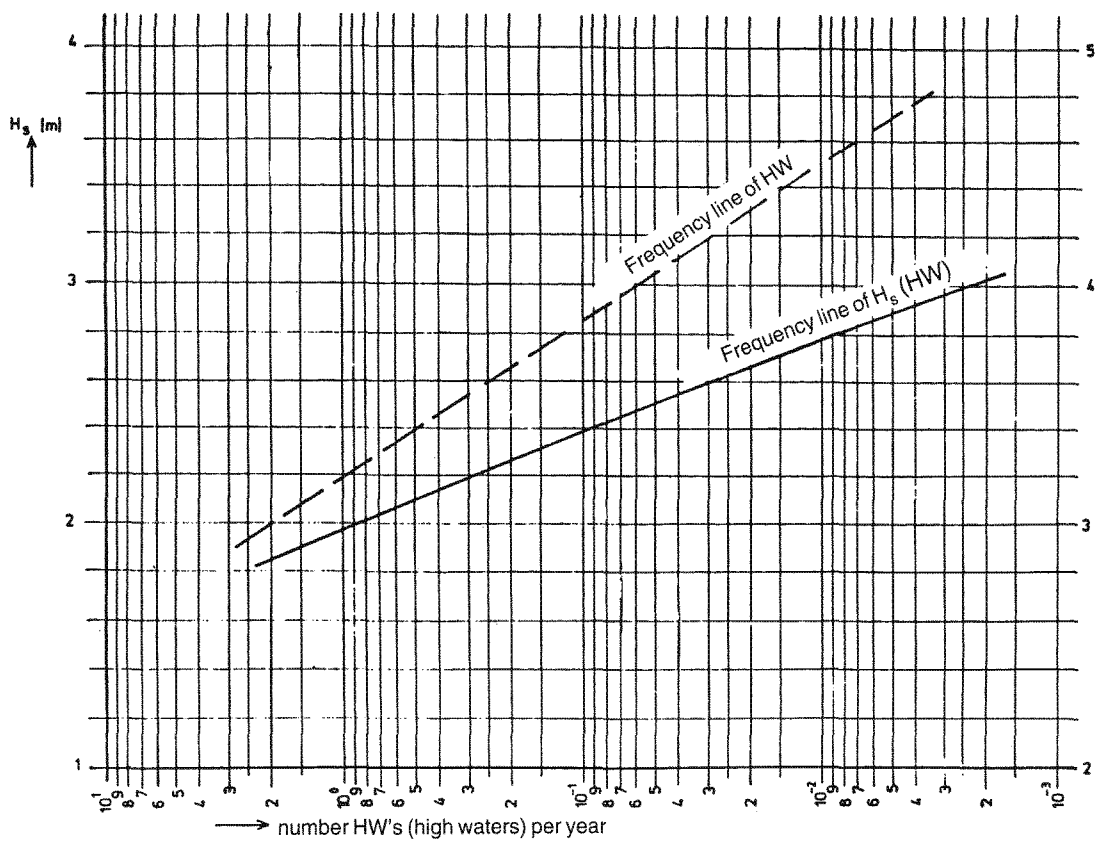

Fig. 42 Line of exceedance of wave heights (H_s) during high tide.

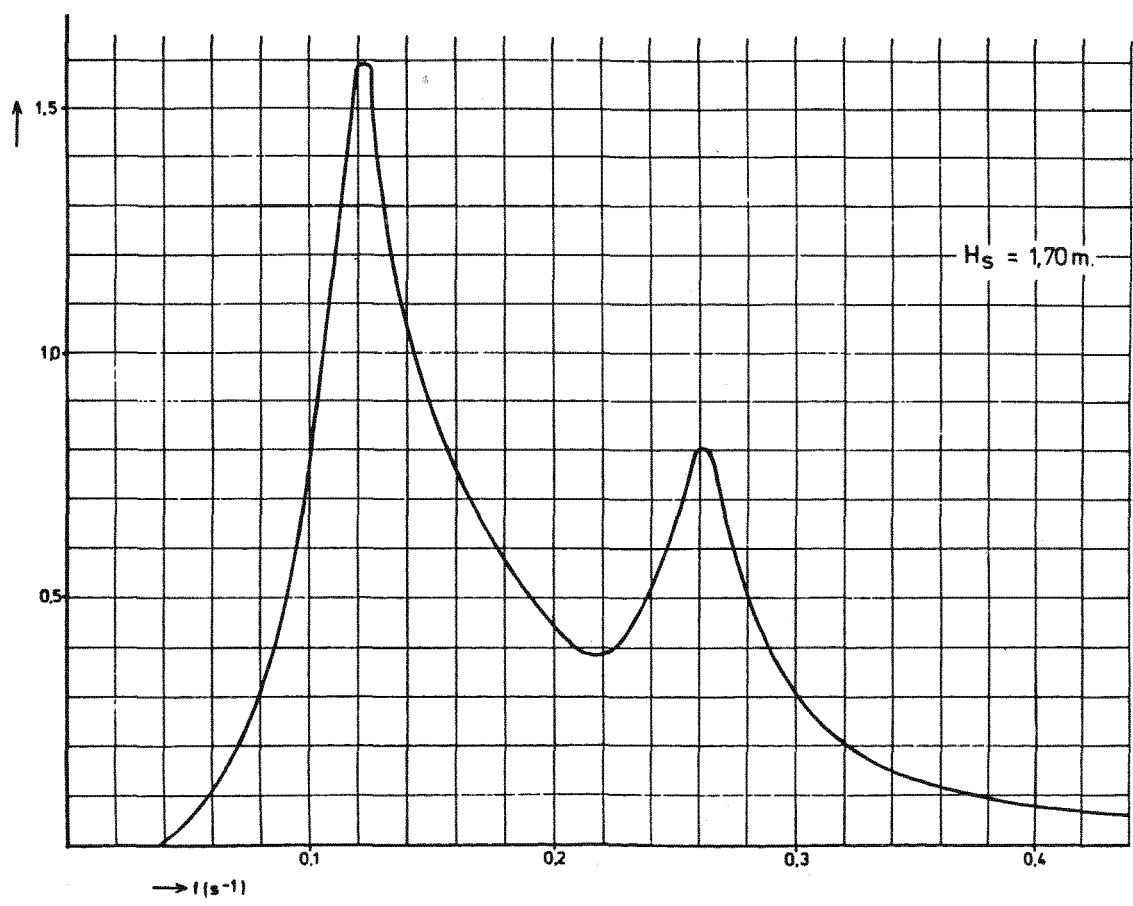

Fig. 43 Standard spectrum survival conditions *Ostrea*.

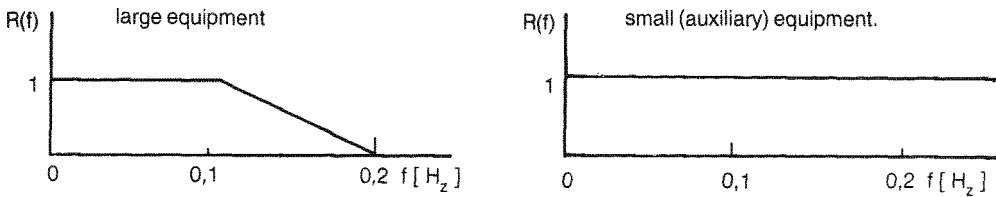
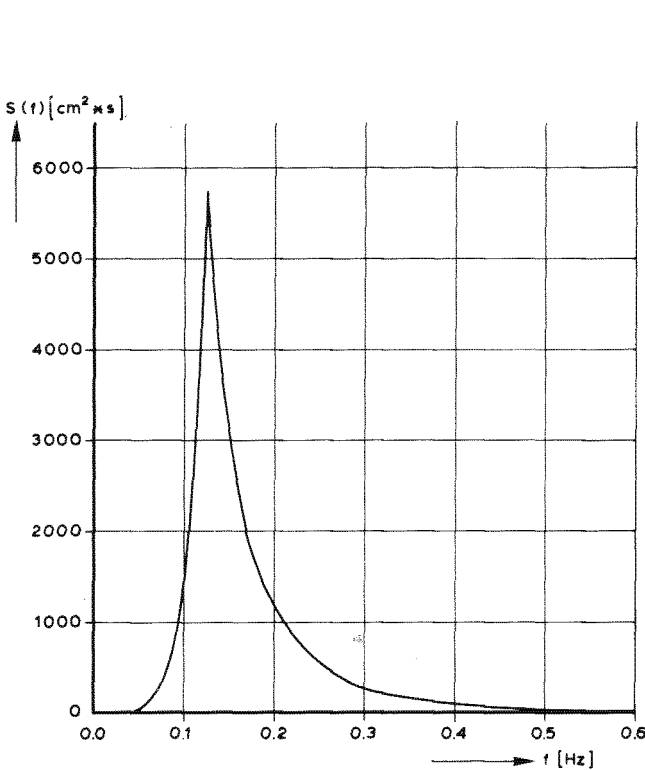
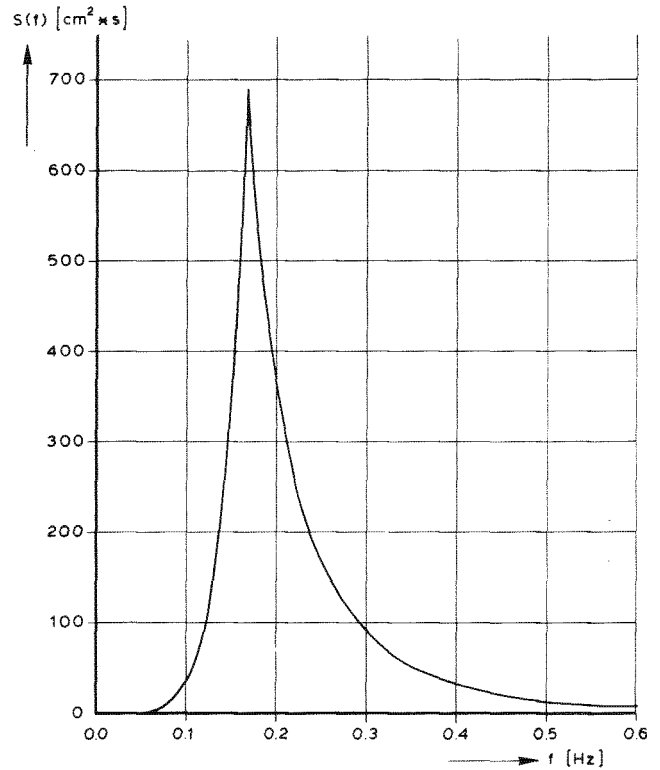

Fig. 44 Standard transfer function for wave movement on ships.



$H_s = 75 \text{ cm}$ $T_D = 8 \text{ sec}$

Fig. 45 Workability spectrum for large vessels high tide.



$H_s = 30 \text{ cm}$ $T_D = 6 \text{ sec}$

Fig. 46 Workability spectrum for large vessels low tide.

Document 9 contains detailed information of these calculations.

Workability spectra

Using the method mentioned above, representative spectra were chosen with a workability of 80% to 90%.

In terms of H_s and T_D , the spectra are as follows (Table 8).

For the large equipment the workability for the above mentioned circumstances is roughly 90%. For small equipment it is roughly 80%. Particularly, the low tide spectrum for large equipment is frequently used as a test for decisive movements, whereby the requirement was that the ship had to be capable of working under these conditions at all times. Figures 45 and 46 show the workability spectra for large equipment at high and low tide.

This form of workability consideration related to the responses, is explicitly made clear during the construction phase by including these quantities in the HMC operational prediction

system. This was made possible because, for critical movements and forces dependable transfer functions could be determined with the help of previously mentioned dynamic models. The resumption of movement predictions advanced the operational decision making.

For instance, at the placement pier operation the predicted movement of the pump intake of Macoma was involved in the decision concerning the placing of the pier.

4.5.5 Hydraulic loads in the construction phase

Construction phase loads were of importance for those construction components which did not yet have their definite strength during construction. The most important components which applied to this were: the pier before it was packed into the sill, the negative overlapping during construction of the sill, the sill beam before the grouting of the adjustable jack and the sill during the construction.

Table 8 Workability spectra for floating equipment.

	H_s (m)	T_p (sec)
Large equipment	0.75	8 at high tide
	0.30	6 at low tide
Small (auxiliary) equipment	0.75	

The construction phase load for the pier is determined with help of the model test results of the M1000 construction phase research and the M1506, M1525, M1532 tests and the NSP-tests. With help of these tests the transfer functions were determined for the probabilistic load calculation. The extreme construction phase load is one with a probability of exceedance of 1 in a period of 3 years. The results of these calculations are discussed in the final research construction phase loads report (Doc. 10).

Subsequently, for the construction phase stage the load was determined for two situations, whereby the gates were placed but the sill and upper beams were not yet placed, namely:

- 1 The construction phase storm load with raised gate, and
- 2 Spring tide load with a closed gate.

For the negative overlapping and the sill beams, the construction phase loads led to adjustments in the design (disposable gravel mat, temporary wedged sill beam). For the sill, the construction phase load led to the formulation of maximum

admissible hydraulic heads across the barrier and a stringent inspection after exceedance.

Documentation

- 1 DDWT 86.001- Natuurrandvoorwaarden.
- 2 DDWT-80.002 PROBER, een programma voor de berekening van de probabilistische langs belasting op de stormvloedkering in de Oosterschelde in gesloten toestand (NOTA)
- 3 DDWT-78.276 Betrouwbaarheid van de m.b.v. 'SEAST9 bepaalde kansverdeling van de totaal belasting (NOTA)
- 4 DDWT-79.016 Overschrijdingskansen van vervallen en waterstanden bij de stormvloedkering in de Oosterschelde (NOTA)
- 5 Belastingen stormvloedkering Oosterschelde (concept), sept. 1985, PEGESS-N-85357, nota met bijlagen in twee delen
- 6 Databankboek d.d. 2 december 1981, deel E
- 7 SOOCOO-M-84508 Deel 5, Stroom informatie t.b.v. de afbouw van de stormvloedkering Deel 5, Ontwerpmethodiek korte expositieduur
- 8 Evaluatie van het onderzoek naar het dynamisch gedrag van het bijzonder SVKO materieel, BEBIMA, SOOCOO-R-84212
- 9 DDWT-81.513 Werkbaarheidsanalyse t.a.v. bewegingen of krachten
- 10 SOOCOO-N-81190 Nota Bouwfasebelastingen pijlers

5 Ecological aspects

5.1 Short characterization and overall design input

At the time of deciding to construct a storm-surge barrier one spoke of the Oosterschelde as a 'community with its vast wealth of all sorts of organisms in the water and on the banks ...' (Doc. 1). How rich the Oosterschelde was of sorts was well known. Also the biomass of the different groups of organisms was globally known.

From the latter, one could get an impression of how 'fertile' the ecosystem was at that time. The document and the underlying knowledge of the 'Colours of south-west Holland' by the contact commission for environmental protection (lit. 1) was an important source of information. When designing the Oosterschelde model with a storm-surge barrier and other constructions (such as dams, sluices) it was attempted to affect the environment as little as possible. The model selected was seen as a compromise (see Part 1, Section 2.1) in which the hydraulic head was maintained but limited (the hydraulic head at Yerseke was then 2.30 m) whereby the environmental changes in the shore area would be kept at a minimum. There would have been radical changes in this area if the Oosterschelde had been closed.

To illustrate briefly the issues of 1976, the ecosystem is described from a recently published plan (Doc. 2). This contains information of researches carried out in the last few years so that a more complete illustration can be given than using data from 1976. Between 1976 and now (1985) no real changes occurred, so that should not be counted as a drawback.

The tidal system of the Oosterschelde is wide and open. The surface covers 47.000 ha of which 38.000 ha is water. After compartmenting 38.050 ha remains of which 31.500 ha consists of water. The tidal movement takes 850 million m³ water in and out of the basin. Before the construction of the storm-surge barrier this was 1220 million m³. The water remains in the Oosterschelde basin for about 175 tides. The basin receives water from polders and (until 1987) from small rivers from Brabant.

In the final situation, a water inflow of 3.8 m³/m² per year remains. Because of this water inflow, which consists of fresh to brackish water, the chlorine content of the Oosterschelde is a little lower than that of the North Sea. The average chlorine content in the period 1972-1981 in the 'Krabbenkreek' was 15.1 g/l Cl⁻, while in the mouth of the Oosterschelde it was 17.3 g/l Cl⁻. Thanks to the expected hydraulic head in the final situation, which will be significantly higher than was expected in 1976 (3.10 m instead of 2.30 m), a small increase of the chlorine content, instead of a decrease, is expected in the back of the Oosterschelde. A high chlorine content is a vital condition for most sorts of organisms.

Sea-weed and sea-grass vegetation are found in the inter-tidal

area. The most different sorts of species are around and below the average low tide line, but the largest biomass is found in the 'eulitoral', the part of the dikes which runs dry during the ebb tide.

Especially on the higher shallows there are large sea-grass and small sea-grass, the first is quite rare.

By decreasing the hydraulic head, the lines of vegetation will shift with the average high and low tides.

The bed fauna on the plates and shallows is seen as fertile. This consists of 10 different sorts of worms, shellfish and crustaceans.

There are 10 to 20 dominant bed fauna species which are found everywhere in the Oosterschelde. A well known and commercially important bed animal is the mussel. This is cultivated and forms the most important source of income in the entire Oosterschelde fishing industry.

Because of the bed fauna fertility and the sea-weed and sea-grass, the inter-tidal area also provides food for a large number of birds.

During Spring, Autumn and Winter a large number of hibernating and migrating birds can be found there. The Oosterschelde belongs to the 10 most important areas for hibernation in Western Europe.

The Oosterschelde with its surroundings is also a significant breeding area; both nationally and internationally.

The mud-flats, so called saltings have an important environmental value because, amongst others, of the specific salt plants communities. Compartmenting has decreased the area from 1700 ha to 650 ha. It is not expected that the saltings will increase much because there is not enough sediments which can settle in the water. Because of the decrease of the high water the significance of the saltings for bird nesting and as high water refuge site has increased a little.

Around 75 different sorts of fish have been observed in the period 1969-1976. The sorts which are caught most are plaice, dab, sole, flounder and eel.

The results of the research, which led to the above mentioned characteristics, are included in the policy-analysis study in preparation for the decision making on the construction of the storm-surge barrier (Doc. 1, see Part 1, Section 2.1); the policy analysis study to determine the desirable cross section (see Part 1, Section 3.1) and the policy-analysis study into the management possibilities of the storm-surge barrier (BARCON-research, see Part 5, Chapter 1).

This contributed to the formulation of the environmental boundaries which the design of the storm-surge barrier had to meet, amongst others with regard to the remaining vertical hydraulic head in the Oosterschelde. On the basis of this it can be expected that the consequences of the construction of the storm-surge barrier for the environment will remain acceptable.

The knowledge gained from research made it possible to judge the design and the construction from an environmental angle, to adjust and to advise on particular (especially growth) problems. The following Sections will discuss certain aspects of this.

Documentation

- 1 Analyse Oosterschelde Alternatieven, Rijkswaterstaat 21 Mei 1976
- 2 Te verwachten ontwikkelingen in het Oosterscheldebekken na 1987 en de consequenties voor het beleid, Middelburg, november 1985

Literature

- 1 Contact-Commissie voor Natuur- en Landschapsbescherming: De kleuren van Zuid-West Nederland, visie op milieu en ruimte; Amsterdam, mei 1972

5.2 Migration of fish and bed animals in relation to the sill design

The exchange, via the tide, of fish and other organisms between the North Sea and the Oosterschelde is an important feature for both waters. The Oosterschelde functions as a nursery for various sorts of fish. These fish propagate in the North sea, as young fish they go into the Oosterschelde to grow up before going back to the North Sea. Also fully grown fish use the tidal flows to swim in and out of the Oosterschelde and the North Sea.

The sill of the storm-surge barrier can limit the free exchange of water organisms in different ways.

The sill and the sill beam could form an obstacle for bed fish, crabs and shrimps. The significant flow velocities in and around the barrier could carry away the fish. Because the fish would be forced to tackle a difference in height of 10 to 20 m in a short period of time, internal damages can occur. These problems were discussed in Document 1 and the conclusions were:

- The higher flow velocities and the differences in load in and around the barrier are unlikely to cause much damage to the fish swimming in and out;
- The sill will cause little problems for the migration of young plaice, eel and shrimps. Fully grown fish will continue to swim in and out to a certain extent, but the size of this can only be established by directed research;
- Because of a decrease in the water exchange per tide, there will probably also be a decrease in the exchange of young fish. This does not necessarily mean that the size of the fish population will be affected since other factors such as food etc., might sooner have a limiting function.

Documentation

- 1 Peeters, J.C.H., Birnbaum, E.: Eventuele migratie problemen voor waterdieren veroorzaakt door de stormvloedkering, d.d. 16 mei 1978, DDMI-78316

5.3 The influence of construction material on the environment

With regard to the selection of construction materials for the storm-surge barrier, research has been carried out in three cases into the effect of these materials on the environment. The research only related to rock types or industrial slag which could be used in the construction of the sill. There has been no research into the influence of other construction materials, because on the basis of their chemical composition, these materials would not affect the environment.

Research relating to the destructive speed of copper containing combinations as a result of the mechanical erosion of bacterial activity and the influence of the destruction of the bed organisms attached to these stones, has been carried out for two rock types from Finland (Outakompu and Raukaruaki).

The use of the Outakompu-rock would not cause any problems for the environment.

The Raukaruaki-rock appeared to contain combinations which would cause bacteria to dissolve copper. This would limit the growth of bed organisms. If this rock was only applied on the North Sea side of the sill, the stability of the sill would have been negatively influenced in an extreme case.

Both rock types were not included in the sill because of other objections not related to the environment (such as high costs or undesirable mechanical erosion).

Research was also carried out into the transference of copper to water by the copper containing industrial slag. From this the industrial slag would be covered with a 5 to 10 m thick layer of rubble and that the flood volume, after completion of the storm-surge barrier, would be around $1.5 \cdot 10^9$ m³ per day.

The copper concentration of the Oosterschelde water is 3 µg/l; calculations show that the use of industrial slag could increase the concentration with a maximum of 0.0002 µg/l. On the basis of this slight increase in copper concentration, 50,000 tons of industrial slag was used in the construction of the sill.

Literature

- 1 Dijkzeul, A.H.J. 1979. De afgifte van zware metalen en fluoride door diverse oeverbeschermingsmaterialen, 1979, RIZA, Lelystad
- 2 Leewijs, R.J. en C. ter Kuile, 1985. Ecotoxicologische verkenningen met betrekking tot erts-lakken in waterstaatswerken. Vakblad voor Biologen, nr 13/14, in druk

Documentation

- 1 Eck, G.T.M. van, 1981. Stortsteen Oosterschelde, notitie DDMI-81403, Middelburg
- 2 Saeijs, H.L.F. Levering industrielslakken, brief DDMI-20597, 25 januari 1982, Middelburg

5.4 Problems of fouling

The growth of marine organisms in and on the storm-surge barrier was not allowed to have an influence on the construction and the long term condition. Below a number of problems regarding the fouling of various components of the storm-surge barrier are set out, which could arise both during and after the construction.

Mussels received the most attention, because they are the only organisms that appear en masse, and can form thick layers. Also oysters, sea fowl, caddis worms and other sorts could, however dependent on the construction- or design requirements, be undesired.

Foundation bed (see also Book 2, Parts 6 and 7)

In the foundation bed the growth of mussels could adversely influence the transfer of horizontal gate loads from the pier to the subsoil. Eventual existing growth must be removed.

Because of the rather long exposition time after laying, prevention of growth was most likely on the upper mats (see Doc. 1). For the lower mats and the eventual, yet to be placed, slab mats, the exposition time was too short for that purpose. Also in the spaces below the pier which, after placement must be subsequently filled with mortar injection, fouling may occur however this seems, seeing the small water exchange possibilities, less probable.

It was advised to monitor these spaces for growth and eventually counter growth with injection of, for example, a copper solution.

Looking back, only the growth of shell caddis worms in the thin sand layer set out on the upper mat have provided some hinderence in a number of places during construction. Just like the establishment of caddis worms in the, yet to be removed, sand sedimentations at the foundation mattress.

This had to be removed by divers, which was for that matter quite easy (Doc. 2 and 3).

Sill and rubble rock dams (see also Book 2, Parts 8 and 9)

The sill is a major construction built up mostly from rubble and thus porous. Under the influence of the static and the wave loads, differences in water loads are built up in the sill which have a significant influence on the soil mechanical stability of the sill.

Mussel growth significantly influences the porosity of the sill and so affects the distribution of the differences in water load.

On the basis of growth models, the influence of mussel growth on the sill construction was checked in combination with calculation models for the differences in water load (Book 2, Part 8, Chapter 4 explains this further).

It appeared that the designed constructions had enough strength to resist the consequences of the most likely growth of mussels.

It was advised to carry on monitoring the porosity of the sill and also the growth (Doc. 4). In the final phase for the most likely growth model for the sill, the theoretical leakage in the sill was estimated at about 320 m², compared with 1346 m² for a clean sill (Doc. 5). These data are of importance for the estimate of the total leakage through the barrier which, again, is of influence on the water level in the Oosterschelde when the barrier is closed.

With regard to the growth, similar problems applied for the stability of the rubble dam.

Here also, the influence of the growth by mussels on the stability was checked with the aid of calculation models, and it also appeared here that the designed construction had enough strength (see Book 2, Part 9, Chapter 4 and Doc. 6).

Remaining growth problems

The growth of sea fowl and mussels in the supporting areas in front of the sill beams in the piers could hinder construction. It could not be prevented. Growth had to be removed from the

supporting surfaces of the sill beams by divers.

Because the gate conductivity growth was prevented as much as possible by applying aluminium-bronze in the sliding surfaces attached to the piers. The high copper content has a limiting effect on the growth. Eventual growth can be further controlled by regular test movements of the gates.

For an (because of other motives non applicable) alternative with a sand asphalt body as a filter construction in the dam abutments, research has been being carried out on the possible deterioration of the sand asphalt by growth (Doc. 7 and 8). The conclusion of this research was that the probability of deterioration was very small.

Documentation

- 1 Werkgroep 511AMO-PGS: Interim rapport aangroei 1981, 341PRO/-81044 of 34FUND-M-81233 of 510NRA-M-81083
- 2 Birnbaum E., Meijering A.I.M.: Aangroei op de bovenmat, 1983, DDMI-83449
- 3 Verwijdering kokerwormvestiging in negatieve overlap, 311KWO-M-83058
- 4 Werkgroep MOSSEL, mosselaangroei in de drempel van de stormvloedkering Eindverslag, 311DRO-N-81018 of LGM-rapport: CO-406609/29, april 1981
- 5 Invloed mosselaangroei op leakopening, SVK DDWT-85264
- 6 Werkgroep MOSSEL, Mosselaangroei in de breukstenendam van de stormvloedkering, 311DRO-M-82005 of LGM-rapport: CO-407046
- 7 Meijering A. I. M.: Aanwezigheid van boormosselen in zand-asfalt, 1979, DDMI-79058
- 8 Birnbaum, E.: Aantasting van zandasfalt in damaanzetten SVK door boormosselen, 1980, DDMI-80441

5.5 Problems relating to 'closed gates'

In the final phase of the construction of the storm-surge barrier it was recognized that certain construction activities had to be carried out behind closed gates which had consequences for the tide in the Oosterschelde. As long as the designed section narrowing in the closure gaps was not realized, this did not cause problems. But, in particular after placing of all the sill beams in the Roompot, this did cause problems.

The activities which had to be carried out were the placement of the upper beams with a floating crane (Taklift IV) and the construction of the rubble protection of the sill beams with help of a crane (TRIAS) placed on a pontoon.

Because of the required strict accuracy of manoeuvring with this floating equipment the high requirements regarding the operation conditions had been formulated. The maximum flow velocity would increase because of the narrowed opening of the barrier, this meant that the maximum flow load on this floating equipment would also increase.

The current velocity would be sufficiently low only around the shortened turn of the tide.

It was recognized that insufficient time was available to carry out the remaining construction works in the Spring and Summer of 1986.

In particular for the placing of the sill beams it was feared that the time available during the turn of the tide would be insufficient. Because of these reasons, the placing of the upper

beams and of a part of the dumpings had to be carried out behind closed gates.

When it concerned the shallow sections, which were relatively near to the bank of the closure gap (Hammen, Schaar or Roompot), it was sufficient to close a number of gates beginning with the ones closest to the bank. For the deep sections in the middle of the closure gap however, the whole closure gap had to be closed to prevent unacceptable damage to the bed protection.

For the designed sand closure of the compartmenting dams in the Tholense Gat (October 1986) and in the Krammer (April 1987), the tide in the Oosterschelde had to be stretched for a certain period, or temporarily halted, in order to decrease the local flow velocity to a certain level, which could be done by closure of the barrier.

These desired (partial) closures of the barrier, necessary for the finishing of the barrier and the above mentioned sand closure, could have adverse affects for the environment and the fishing interests in the Oosterschelde. They were the subject of further research (see Doc. 1) which was aimed at reaching a compromise acceptable to all parties.

By placing the remaining sill beams in the Roompot (Spring 1986) the cross section at the storm-surge barrier would gradually be reduced to the designed value. The average hydraulic head at Yerseke would then be reduced to approximately 2.60 m (temporarily till the completion of the compartmenting).

A further narrowing by closure of a number of gates or the closure of an entire channel would lead to a further reduction of the tide in the Oosterschelde.

In general, the objections against a further reduction of the tide for a limited period of a number of months were:

- With regard to the horizontal tide: the decrease in flow velocities which would cause a decrease in the changing of the water above the mussel and oyster banks and less mixing would occur between the fresh water from the Volkerak and the brackish water of the Kreekrak gates, which could cause, locally, a too low chlorine content and stratification;
- With regard to the vertical tide: the upper part of the tidal zone on the banks and shallows and the lower parts of the dikes would run dry. In just two days this could lead to death by drying up and too much heat (especially in the Summer) of organisms settled there. Also the accessibility to the mussel banks for fishing boats would become less good.

The above mentioned objections became more serious with an increase in the reduction of the tide and the longer duration. Although not without objections, a reduction of the average tide at Yerseke to 2.30 m for a number of months, was still acceptable. It was possible to close the Hammen and the Schaar completely only when the other openings would be completely open.

A total closure of the Roompot, necessary for the placing of 12 sill beams in the middle section, would lead to an average tidal difference at Yerseke of about 1.20 m. According to the plans, the reduction would last about a week. This created objections from the environment and the fishing industry.

Although it was technically and economically less attractive, a compromise was reached for this closure by allowing the Roompot to be closed for a maximum of 12 hours at a time interchanged by in between periods with an open barrier for a minimum of 12 hours. The closed periods had to be at night time as much as possible. The whole operation could not exceed two weeks. By allowing the normal tide every other tide and having the reduced tide at night, an attempt was made to prevent drying up and the risks of stratification as much as possible.

The level of 2.30 m as an average tide at Yerseke and the limitations of the complete closure of the Roompot were the boundary conditions for planning and constructions of those activities which required a closure of the gates. The first boundary condition was translated in the specifications as a maximum of closed gates, the tolerable closure of the Roompot was precisely set out in the specifications.

Also a procedure for tide manipulation was established for the sand closures, which will not be further discussed here. Actually, the assessment of the following closing strategies and the consequences for the Oosterschelde basin happened in particular coherence with the closure for the construction of the storm-surge barrier itself, which was dealt with in this Section. Taking into account the above mentioned boundary conditions for closures, on behalf of the finishing of the barrier and closure strategies for the sand closure of the compartmenting dams, the following (shortened) conclusion could be made of the effects on the Oosterschelde:

On the basis of the present knowledge and insights, it is expected that there will be a number of negative effects for the environment and fishing industry.

Although in particular zones of the inter tidal area vegetation and sea-bed life will die, this will not lead to the extinction of plant and animal sorts, nor will it cause irreparable damage.

The consequences for the fishing industry can be reduced if detailed arrangements can be made in relation to the planning of the activities of the fishermen.

Finally it was noticed that, after completion of the study discussed in this Section, new insights and experiences were gained in relation to the placing of sill beams, the construction of dumpings of the sill beams and the manipulation of gates.

This led to a slightly different working method than planned, however, without affecting the above mentioned boundary conditions.

More details can be found in the future evaluation of the construction.

Documentation

1 Pieters, T., Stronkhorts, J., Westen, C.J. van (redacteurs): De effecten tijdens de afbouw van de Oosterscheldewerken op milieu en visserij, Deltadienst, nota DDMI-8508, d.d. 4 september 1985

Part 4: Description of the design

Contents

- 1 Alignment and summarizing description 130**
 - 1.1 Choice of alignment 130
 - 1.2 The geographical position of the barrier 130
 - 1.3 Summarized description of the design 131

- 2 Movable storm-surge barrier 133**
 - 2.1 Soil improvement 133
 - 2.2 Compaction 134
 - 2.3 Foundation bed 134
 - 2.4 Bed- and bank protection 134
 - 2.5 Piers 135
 - 2.6 Other concrete elements 142
 - 2.6.1 Sill beam 142
 - 2.6.2 Upper beam 142
 - 2.6.3 Consoles 143
 - 2.6.4 Traffic box girders 143
 - 2.6.5 Sequence of assembling 143
 - 2.7 The sill 144
 - 2.8 Design of gates and operating machinery 144
 - 2.8.1 Sluice Gates 144
 - 2.8.2 Operating machinery 145
 - 2.8.3 Energy supply 149
 - 2.8.4 Operation 150
 - 2.8.5 Emergency closure system 153
 - 2.8.6 Lightning security 153

- 3 The solid barrier 155**
 - 3.1 Introduction 155
 - 3.2 Neeltje Jans island complex 155
 - 3.3 Roggenplaat 157
 - 3.4 Dam abutments and traffic transitions to the movable storm-surge barrier 160
 - 3.4.1 Dam abutments 160
 - 3.4.2 Abutments 163
 - 3.4.3 Land abutment box girders 163
 - 3.5 Rubble dams 163
 - 3.6 Roompot lock 164

- 4 Secondary works 167**
 - 4.1 Control building 167
 - 4.2 Through traffic- and construction road 168
 - 4.3 Harbours, depots, construction sites 169
 - 4.4 Support systems and tools 171
 - 4.4.1 Introduction 171
 - 4.4.2 Support systems 175
 - 4.4.3 Support equipment 175
 - 4.4.4 Support means for monitoring 175

1 Alignment and summarizing description

1.1 Choice of alignment

The alignment of the storm-surge barrier follows in the main lines the alignment of the original dam which was established by a Parliamentary decision on 22 January 1969.

The alignment was:

- On the north side adjacent to the storm-surge protection of the Schouwen-Duivenland polder district between the dike poles 23 and 25 of the Burgh and Westland polder sea dike;
- On the south side adjacent to the main water storm-surge protection of the Noord-Beveland polder district on the border between the Onrustpolder and the Jacobapolder;
- It follows a long S-shaped line across the west offshoot of the Roggenplaat and the Neeltje Jans and Middelplaat, and the east offshoot of the Noordland plate.

This alignment is crossed by three main channels:

- The Hammen
- The Schaar van Roggenplaat
- The Roompot

and the secondary channel Geul between the Middelplaat and the Noordland.

Figure 1 shows the alignment.

The motivation for this alignment is given in a memorandum of the Delta Division (Doc. 3).

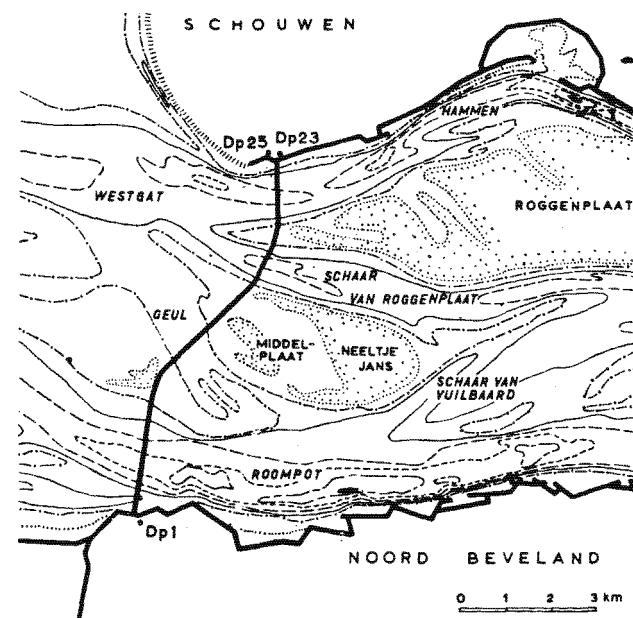

Fig. 1 Alignment of the dam through the Oosterschelde.

Basically, the arguments for the choice of the alignment are the following:

- To bring as many existing dikes behind the new storm-surge barrier as possible;
- To have a maximum square crossing of the main channels which are to be dammed up;
- To have a minimum wet cross section to be closed;
- To have a minimum additional flow attack on the vulnerable banks during construction;
- In connection to this, to have an as favourable as possible flow distribution across the three main channels through the dam compartments on the plates;
- To have a connection on the existing banks where these are less vulnerable (less steep underwater slopes);
- To have a minimum depth of the main channels at the location of the crossing, whereby the greatest depth in the channels should be as far out as possible from the banks;
- To have the possibility of making fixed support points (construction islands) on the plates which have a minimum influence on the flow pattern;
- To have a more or less sheltered position with regard to construction activities;
- To have a favourable position for the alignment on Noord-Beveland and Schouwen-Duivenland for the motorway which will be constructed over the barrier.

These arguments applied, practically unabridged, for the now executed design. And, with maintaining the original alignment maximum use could be made of the earlier work.

1.2 The geographical position of the barrier

The components of the barrier are located in three different municipalities, namely:

- The dam abutment Schouwen, the closure gap Hammen and the island Roggenplaat lie in the municipality of Westerschouwen;
- The closure gap Schaar van Roggenplaat, the island complex Neeltje Jans and the closure gap Roompot lie in the municipality of Veere; and
- The dam abutment Noord-Beveland lies in the municipality of Wissenkerke.

The alignment of the barrier is similar to the outer crest line of the original design of the earthen Oosterschelde dam (see Fig. 41).

Along this line a hectometering has been carried out which forms the basis for the identification locations of the complete construction.

In relation to the State Triangulation measurement, the outer crest line is fixed with the starting point on the dam abutment Noord-Beveland and the finish on the dam abutment Schou-

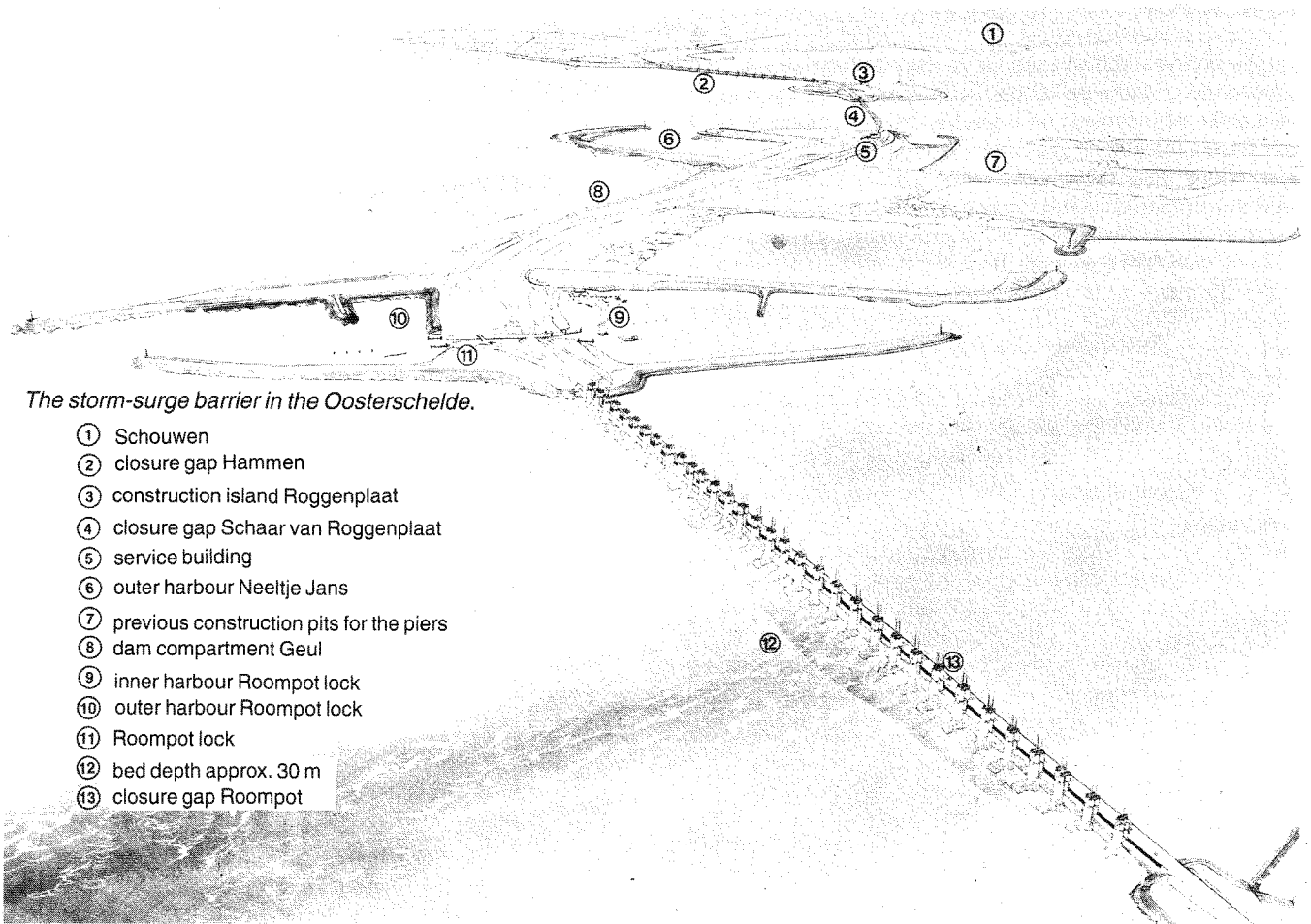

The storm-surge barrier in the Oosterschelde.

- ① Schouwen
- ② closure gap Hammen
- ③ construction island Roggenplaat
- ④ closure gap Schaar van Roggenplaat
- ⑤ service building
- ⑥ outer harbour Neeltje Jans
- ⑦ previous construction pits for the piers
- ⑧ dam compartment Geul
- ⑨ inner harbour Roompot lock
- ⑩ outer harbour Roompot lock
- ⑪ Roompot lock
- ⑫ bed depth approx. 30 m
- ⑬ closure gap Roompot

Fig. 2 The storm-surge barrier in the Oosterschelde.

wen, as well as the mutual points of intersection of the straight lines of the alignment.

The co-ordinates of these points are:

A = hm 0, on the dam abutment

Noord-Beveland $x = 36739.670$; $y = 402179.190$

B, near the construction island of Noordland: $x = 37075.000$;
 $y = 405250.000$

C, on the construction island of Neeltje Jans: $x = 39087.000$;
 $y = 407222.000$

D, on the construction island of Roggenplaat: $x = 39769.000$;
 $y = 408521.000$

E = hm 90.0034 on the dam abutment

Schouwen: $x = 39742.313$; $y = 410231.414$

At the intersection points B, C and D, a curvature radius of respectively 2050.00 m, 1949.80 m and 1949.80 m were applied for the alignment.

The axis of the movable components of the barrier in the three flow channels, has been shifted and is parallel to the straight parts of the outer crest line.

The shift is 75.00 m to the east, perpendicular to these parts of the crest line.

The applied hectometering on the axis of these closed sections is the hectometering projected here of the outer crest line (see also Doc. 4 and 5). Local grids have been applied for all kinds of surveys. Grids are defined in Document 6 and, if necessary, related to the position of the outer crest line with the fixed hectometering thereon.

1.3 Summarized description of the design

The design of the barrier involves (Fig. 2):

- Fixed dam abutments against the banks of Schouwen-Duivenland and Noord-Beveland;
- A fixed component of the dam going from Noordland to the Neeltje Jans plate with a damming up of the secondary channel Geul (Dam compartment Geul);
- A fixed dam component on the Roggenplaat;
- Movable barriers with matching bed protection in the three main channels: Roompot, Schaar van Roggenplaat, and the Hammen;
- A navigation lock with a control building in the sea defence barrier on the north bank of the Roompot near Noordland with accompanying outer harbours;
- A central control building for the movable barrier and power station in the axis of the sea defence barrier on the Neeltje Jans plate;
- A motorway and a road for construction traffic and slow traffic over the entire barrier.

The construction sites, construction harbours and construction pits will be allocated a final destination in the future physical planning of the Oosterschelde area and will be an integrated part of the design.

The movable barrier consists in principle of a combination of pre-fabricated concrete elements such as piers, sill beams and upper beams with steel gates in between which are driven by electro-hydraulics.

Under the sill beams there is a permeable sill construction built up of various layers of rubble.

Via the concrete tabular girders, resting on the piers, a construction road and a traffic road is created across the barrier. With a simple extension on the piers and the placing of extra box girders the traffic road can be extended to a motorway in due course. This whole is placed on a foundation bed which has been prepared for this function. The foundation bed mainly consists of a consolidated soil improvement, covered by a prefabricated filter construction to prevent erosion at the place of the movable barrier and to distribute the loads of the pier to the subsoil.

Distributed over the three main channels, the movable barrier has a gross cross section of below MSL of 18.000 m² and a retaining height of MSL + 5.80 m for the Roompot and the Schaar, and MSL + 5.60 m for the Hammen. To prevent erosion, which could endanger the stability of the movable barrier a largely porous but sand proof bed protection was constructed on both sides of the barrier over a breadth of 550-650 m from the axis. For the most part, this bed protection consists of prefabricated and on the spot so called sunken block mats, and for a small part (Hammen and Schaar), of stone asphalt mats. In the neighbourhood of the barrier, where under certain conditions the expected current is strongest an apron was constructed, which consisted of liquid asphalt dumped underwater, across the possible already present bed protection.

On the edge of the bed protection, the subsoil was also compacted to prevent settlement flows in the formed erosion pits.

The earth barrier mainly consists of an earth body built up of sand, protected against erosion by constructions in asphalt-concrete and stone asphalt above the waterline, and by filter constructions of rubble under the waterline. The height of the earth barrier was mainly determined by the longitudinal section of the traffic road across the barrier (MSL + 12 m) while the design height of the earth barrier was MSL + 11.50 m (Doc. 7). This barrier is interrupted in three places by lower sections on the island complex Neeltje Jans, namely at the road connection Neeltje Jans (MSL + 9 m), a cutoff in Dam compartment Geul (MSL + 8 m) and the Roompot Lock (MSL + 5.80 m).

At the connection of the movable and earth barriers, the earth bodies of the fixed barriers are replaced by a construction of

sand, grain and rubble which include prefabricated concrete elements as foundation of the future abutment to be built up for the traffic bridges.

The remaining gap up to the first pier is, with regard to the barrier function, closed off by a porous rubble dam reaching roughly to MSL + 7 m, and with regard to the traffic roads is bridged with a light weight concrete box girder with a length of 68 to 80 m, depending on the local situation.

Documentation

Section 1.1

1 Keuze van een tracéband voor het laboratoriumonderzoek ten behoeve van de tracébeoordeling van de Oosterscheldedam Rijkswaterstaat, Deltadienst, Afsluitingswerken, Afdeling Zuid, Nota nr 1-1962, d.d. september 1962

2 Tracékeuze voor de afsluitdam door de Oosterschelde, Rijkswaterstaat-Deltadienst, Afsluitingswerken, Afdeling Zuid, Nota nr 5-1966, d.d. november 1966

3 Tracékeuze Oosterscheldedam Rijkswaterstaat Deltadienst, Nota bijgevoegd als bijlage, bij de brief, kenmerk 10133, d.d. 21 december 1967, van het hoofd van de Deltadienst aan de Directeur Generaal van de Rijkswaterstaat, betreffende een voorstel tot tracékeuze

Section 1.2

4 Tracé met hectometrering op buitenkruinlijn en op as stormvloedkering, met coördinaten van een aantal vaste punten Rijkswaterstaat Deltadienst, Afdeling Waterbouwkundige Werken West, tekening nr 77.4.074, d.d. 9-3-1977

5 Hectometrering-coördinatenstelsel Stormvloedkering Oosterschelde, notitie Survey-M-80019, d.d. 2 april 1980

6 Coördinatenstelsels SVKO, notitie Survey-M-83060, d.d. 7 juni 1983

Section 1.3

7 Afsluiting Oosterschelde, Ontwerp dwarsprofiel Oosterscheldedam, Rijkswaterstaat Deltadienst, Afsluitingswerken, Afdeling Zuid, nota nr 1-1968 d.d. 20 mei 1968

2 Movable storm-surge barrier

2.1 Soil improvement

At the bottom of the main channels, layers of small bearing capacity appear in various places in the alignment of the barrier which can cause unacceptable settlements of the piers (see Part 3, Chapter 1).

These layers consist partially of loosely structured sand and partially of silt containing sand, clay and sand containing clay. The bearing capacity of relatively clean loosely structured sand can be improved by mechanical consolidation. This does not apply to loosely structured sand which contains more than 12% of silt, clay and sand containing clay, which was the reason why this sort of soil, within the influence sphere of the pier forces, had to be removed and replaced with clean soil.

In the alignment of the movable barrier a bed protection in various construction forms had already been constructed for the benefit of the closure of the main channels within the

framework of the previous design for the complete closure of the barrier. This bed protection did not fit in the present design with regard to construction and height. Remnants formed risks for the new construction of the foundation bed. The necessity for soil improvement resulting from the geological condition, combined with the necessity for removal of existing bed protection, led to the soil improvement over the full length of the movable barrier in the three main channels.

The depth of the soil improvement was dependent on the local situation (see Fig. 3). The bed width of the dredged trench was around 50 m, depending on the depth, and the slopes varied between 1:5 and 1:7.

The dredged trench was supplemented with clean sand to a certain desired level. In the deepest parts of the channels this sand supplement reached to 7.5 m above the original bed. For the protection against erosion, while waiting for the foundation bed to be constructed, and definite bed protection the sand supplement was covered with a layer of sea grain.

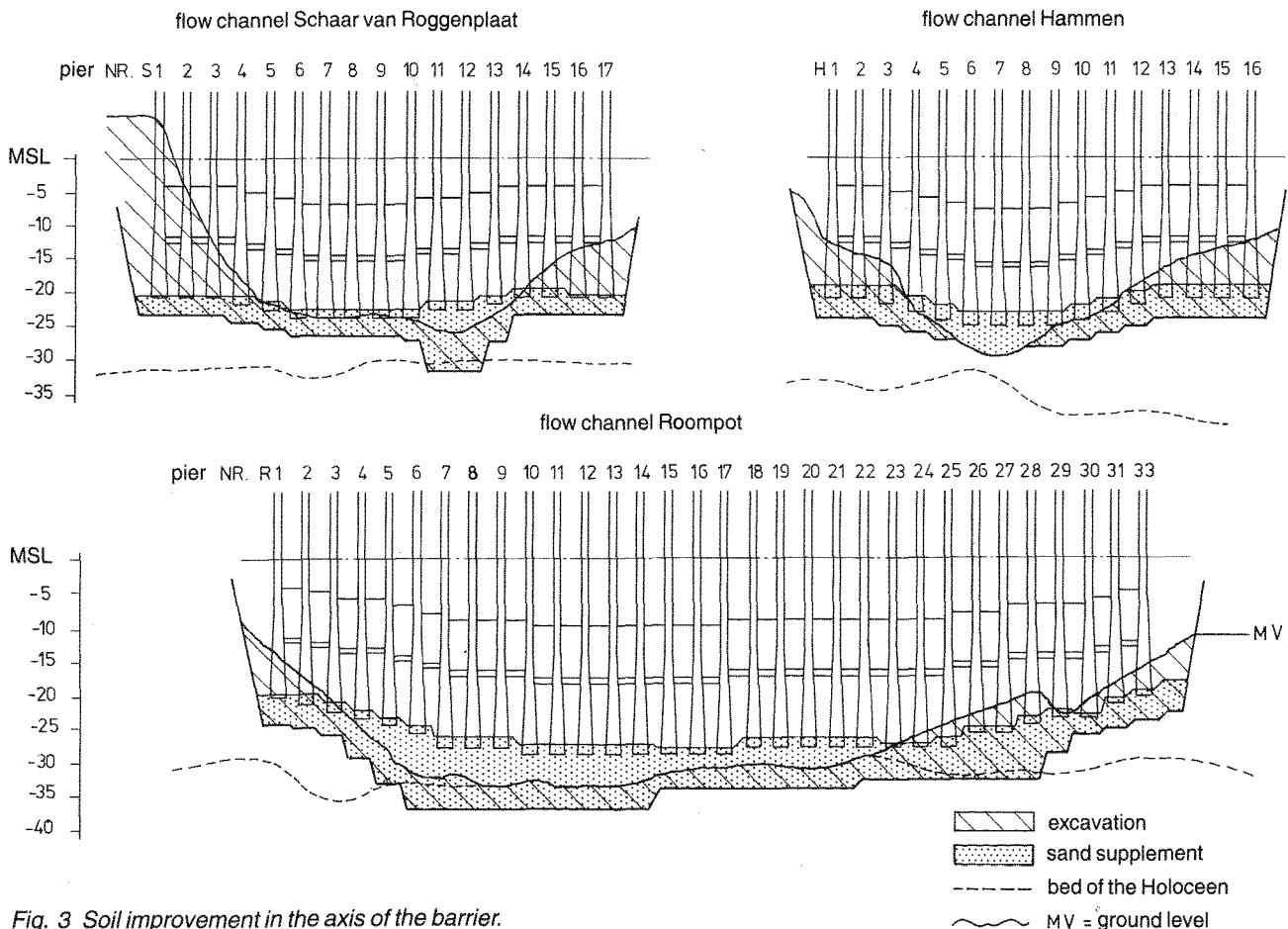

Fig. 3 Soil improvement in the axis of the barrier.

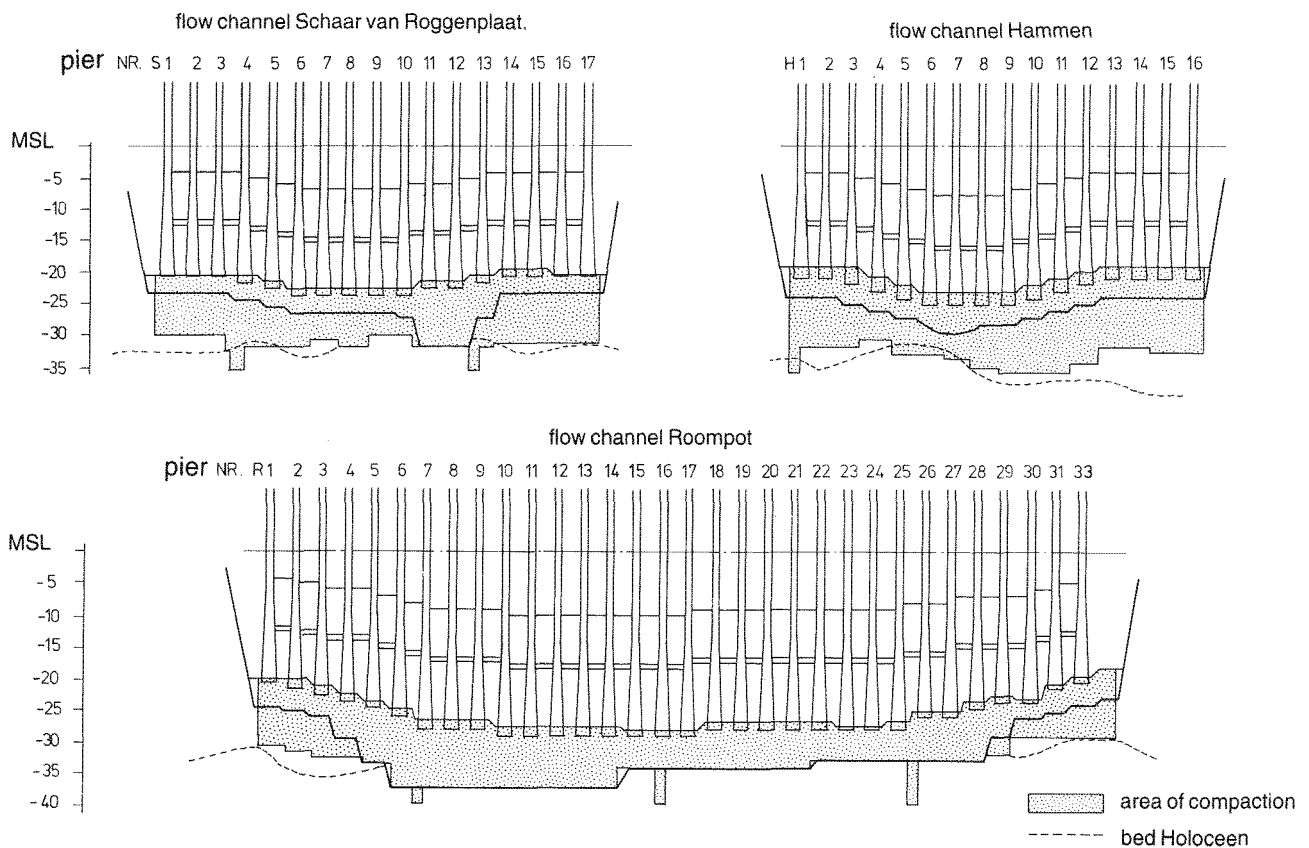

Fig. 4 Compaction in the axis of the barrier.

2.2 Compaction

The relatively loosely structured sand layers, mainly situated in the holocene sediments in the bed of the main channels, and the sand supplements of the soil improvement had to be compacted to such an extent that a minimum conus resistance of $13\text{MN}/\text{m}^2$ was reached (see Fig. 4).

The total width of the strip that needed to be compacted was 78 m; 41 m out from the axis of the barrier on the Oosterschelde side and 37 m out from the axis on the sea side.

The depth compaction was carried out by inserting vibrators in the bed according to a certain pattern which vibrated vertically. This was carried out from a specially developed pontoon (Mytilus) (see Fig. 5).

2.3 Foundation bed

The foundation bed designed has two functions:

- Firstly, to form a porous but sand proof cover of the bed underneath and around the piers and sill construction;
- Secondly, to form a bearing surface for the piers which can transmit horizontal and vertical loads from the piers to the subsoil with a minimum of deformation. In the place of the pier foot ($50 \times 25 \text{ m}^2$) a taut and, as well as possible, flat surface of approximately $60 \times 30 \text{ m}^2$ had to become available.

In particular for the first above mentioned function, a prefabricated filter mat (under mat) was designed of $200 \times 42 \text{ m}^2$ which was placed on the bed of the channel with specially developed

material (Cardium).

Before the placing of the under mat, the bearing surface of $60 \times 30 \text{ m}^2$ had to be levelled as well as possible. The mats lie with their length axis perpendicular to the axis of the barrier so that, at a pier distance of 45 m theoretically a space of 3 m remains between two mats (negative overlap).

The under mat has an overlap at its ends of about 10 m with the previously placed apron of asphalt mastic. To protect the filter-mat against possible damage by the pier foot, a grain containing upper mat ($60 \times 31 \text{ m}^2$) was placed on the projected location of the pier.

Figure 6 shows the construction of the under mat and the upper mat.

After placing, both upper mat (complete) and under mat (over $100 \times 36 \text{ m}^2$) were compacted with help of vibration plates. The negative overlap was filled with sea gravel and rubble and further covered by a gravel-brush mat (Fig. 7).

In the case of unacceptable deformations in the level position of the upper mat, a flagstone mat would then be placed (see Fig. 8 and 9) which would compensate these deformations to 45 cm in steps of 5 cm. For that matter, this flagstone mat has only been constructed at a few places.

Figures 10 and 11 give an outline of the overall build up of the foundation.

2.4 Bottom- and bank protection

In the framework of the original closure of the Oosterschelde by means of a barrier dam, the construction of a bed protection

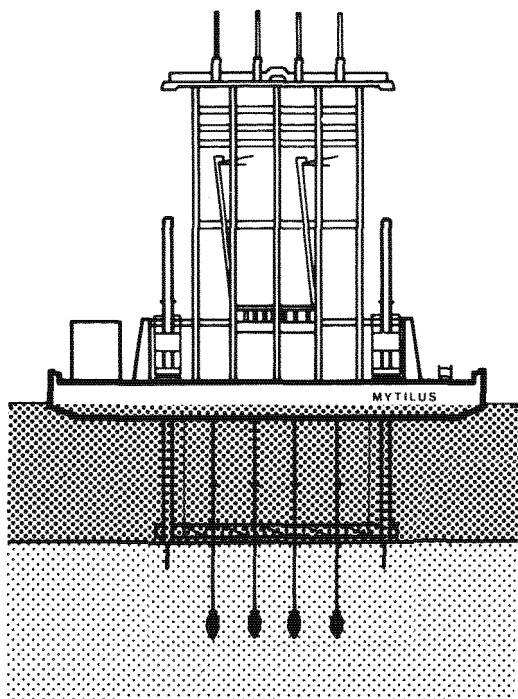

Fig. 5 Bottom compaction by the vibrators of the Mytilus.

in the closure gaps was already executed, aimed at a gradual closure with the help of a cable-lift and loosely dumped materials (stone- and concrete blocks).

An important part of this bed protection, namely the stone asphalt mats in the Hammen and the Schaar van Roggenplaat, and the block mats in the Roompot, were already constructed. For the flow gaps of the movable storm-surge barrier, this bed protection was further extended with the help of block mats to 650 m on both sides of the axis in the Hammen and the Roompot, and to 550 m in the Schaar. 200 kg/m² of steel slag was dumped on the block mats after they were placed.

On the location of the axis of the barrier a strip of bed protection of about 100 m wide had to be removed for the installation and compaction of the soil improvement and the construction of the foundation bed.

On both sides of the sill construction in the axis of the barrier, breadthwise dependent on the expected current attack, an apron of asphalt mastic (approx. 30 cm thick) was constructed across the present bed protection.

The asphalt mastic was dumped on the spot in overlapping layers (such as roofing-tiles) of ± 10 cm thick. Instability of the block mats- and/or the edges of the stone asphalt mats could occur under certain conditions during construction or once the barrier became operational. In order to prevent this, an extra load of rubble was dumped on the block mats on both sides of the barrier across a breadth dependent on the current attack. The stone asphalt mats in the Hammen and the Schaar were completely dumped with steel slag and rubble. Figures 12, 13 and 14 show an overview of the size of the bed protection.

The transition of the prefabricated bed protection to the bank protection at the flow gaps was formed by material such as phosphorus slag, steel slag and/or rubble.

Along the edge of the bed protection, where it passes into the unprotected channel bed, erosion scour holes could appear during the construction of the barrier itself.

To prevent instability occurring at the location of the scour holes, the scour slopes which were too steep were filled up. On those places where there was a probability of settlement yield, because of loosely structured bed sand after the forming of a scour hole, the bed was compacted over a depth of 15 m. This took place in the east and west side of Roompot-north, in the east side of the Schaar and in the east side of the Hammen.

The support slope on the west side of the Schaar was sucked up and dumped as a preventative measure because compaction was not possible.

On the east side of the Roompot, along the bank of Noord-Beveland connected to the existing bank protection, extra bed protection was constructed, consisting of a strip of 650-1450 m out from the axis of the barrier with a width of 100-150 m, to prevent the destabilisation of this vulnerable bank by the expected scour hole. An extra rock dumping of the edge of the scour hole was necessary (see Fig. 15).

At the other banks on the east side of the flow gaps, dumping of the edge of the scour hole could be done afterwards.

2.5 Piers

The piers, together with the sill beams and the upper beams, form the framework of the proper net cross section. There are 62 sections (originally 63) distributed over the three flow channels, which can be closed by a steel gate, the Hammen has 15, the Schaar 16 and the Roompot 31 (originally 32).

The piers also function as support for the traffic bridges and as carrier for the operational mechanisms of the gates. The distance between the piers is 45 m h.o.h. which results in a clear width of the flow section of 39.5 m. The height of the flow section varies according to the place in the cross section of the flow channel, which results in a variation of the foundation depth of the piers of MSL - 21.50 to - 30m) (see Figs. 16 and 4).

Although they differ in detail, the basic form of all piers are similar (see Fig. 17):

- A hollow, in cross section, triangular form with a bottom plate of 25 x 50 m² and a height of 16 m; and
- A pier shaft with a length of 22 m and a variable height.

One of the starting points of the design was that the piers would be prefabricated elsewhere, and would be positioned with a specially developed vessel (the Ostrea). In the first instance the pier was positioned on the foundation bed via two 4 m broad ribs placed length ways in the foot plate. The remaining space between the foot plate and the foundation bed was, in a later stage of construction of the barrier, filled up by means of a grout injection for which a groutproof closure was constructed with gravel bags around the foot plate (Fig. 18). The pier foot was imbedded in the sill construction at a height varying from 8-12 m depending on the location in the cross section of the channel. Above that level, the sill beam is supported by the pier foot. To cut down on transport weight, the pier foot was made hollow (see Fig. 9).

For the necessary stiffness and strength six transverse partitions with holes were constructed inside the pier foot. Directly after positioning, this hollow space was filled with water to increase the stability of the pier. In a later stage, after undergrouting of the foot plate, the space was filled with sand ballast. The holes in the transverse partitions had to ensure a good spreading of the sand.

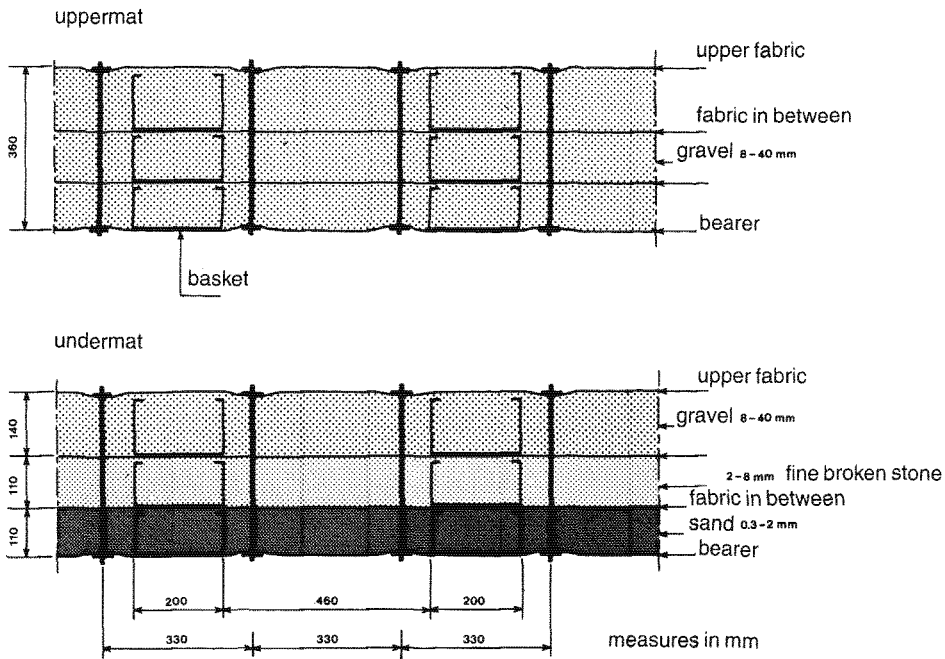

Fig. 6 Construction of upper- and under mat.

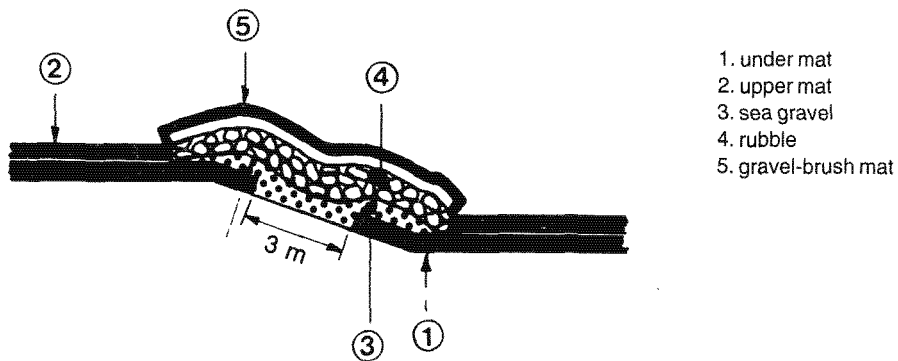

Fig. 7 Transition (negative overlap).

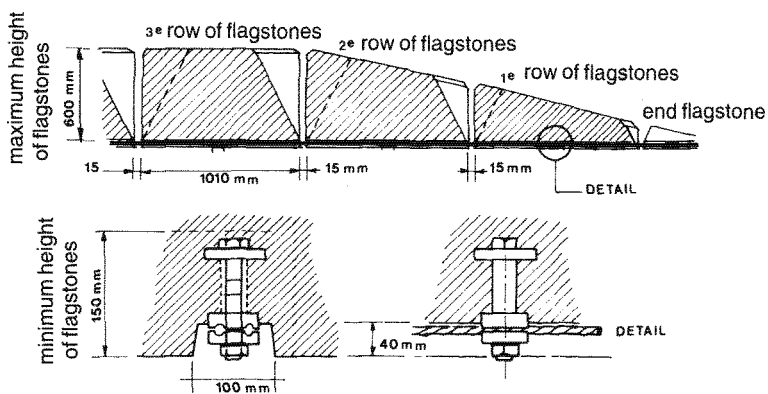

Fig. 8 Construction of the flagstone mat.

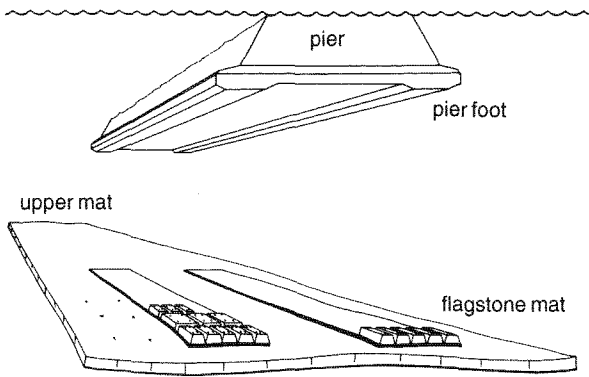

Fig. 9 Use of the flagstone mat.

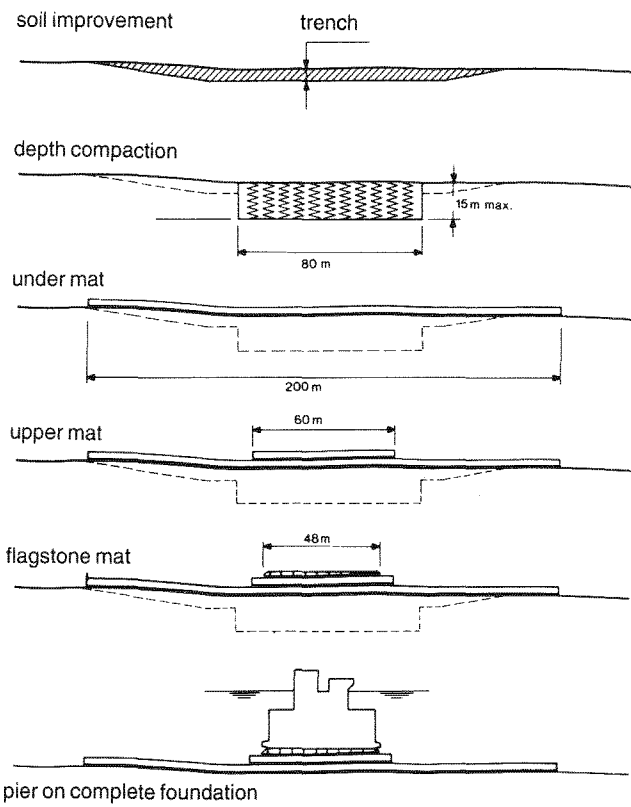

Fig. 10 Construction of the foundation.

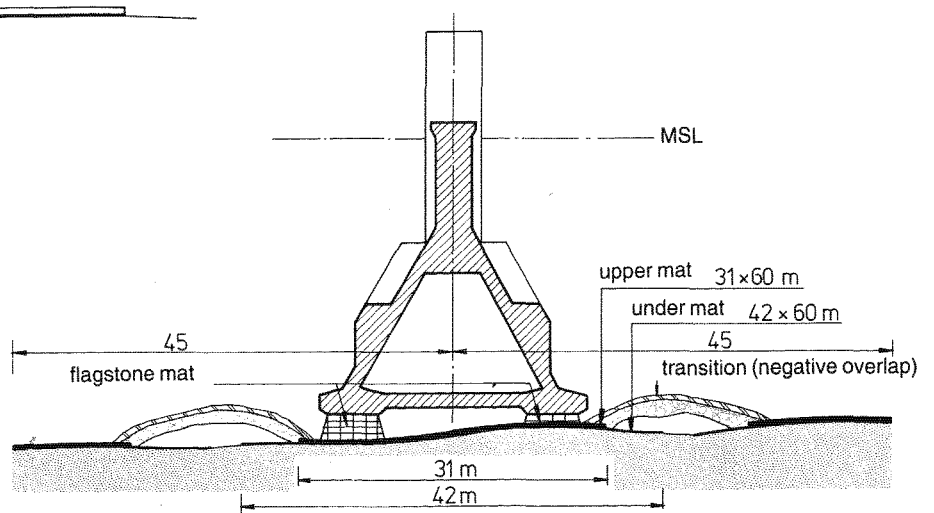

Fig. 11 Location of foundation- and flagstone mats.

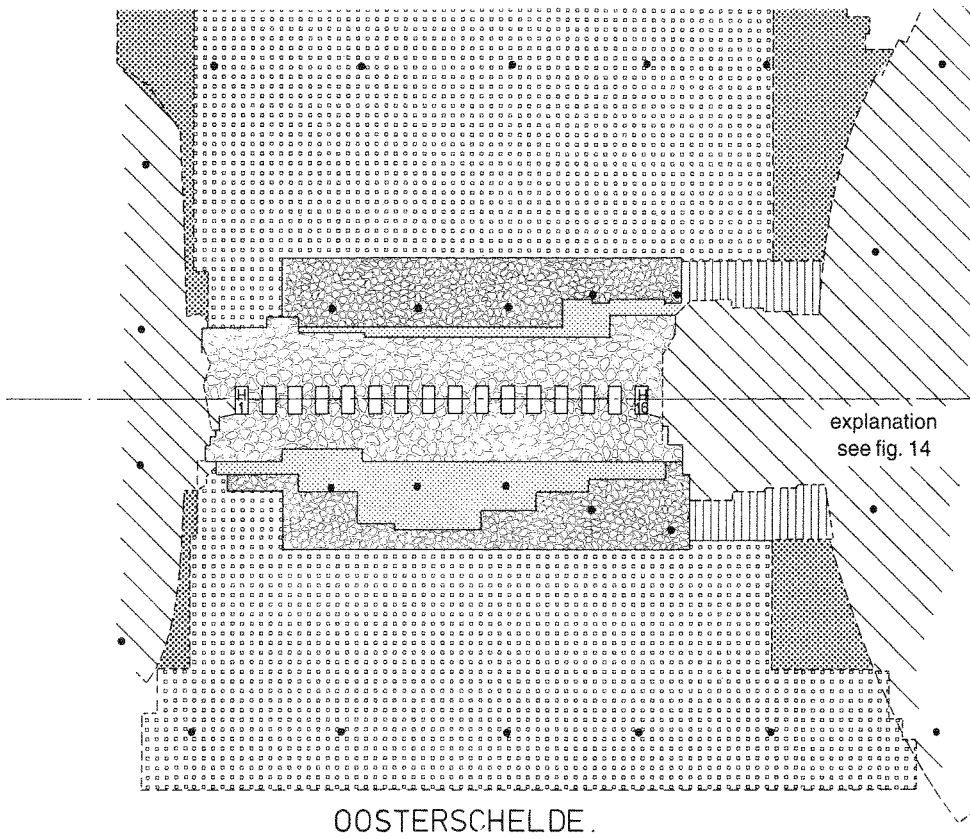

Fig. 12 Bottom protection Hammen.

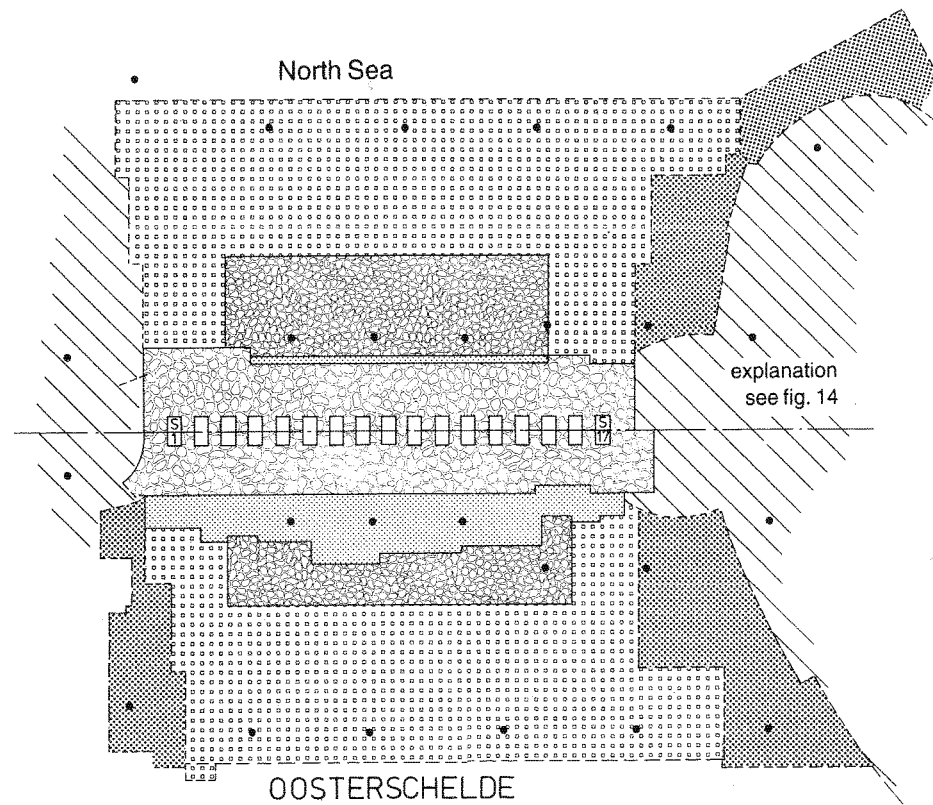

Fig. 13 Bottom protection Schaar van Roggenplaat.

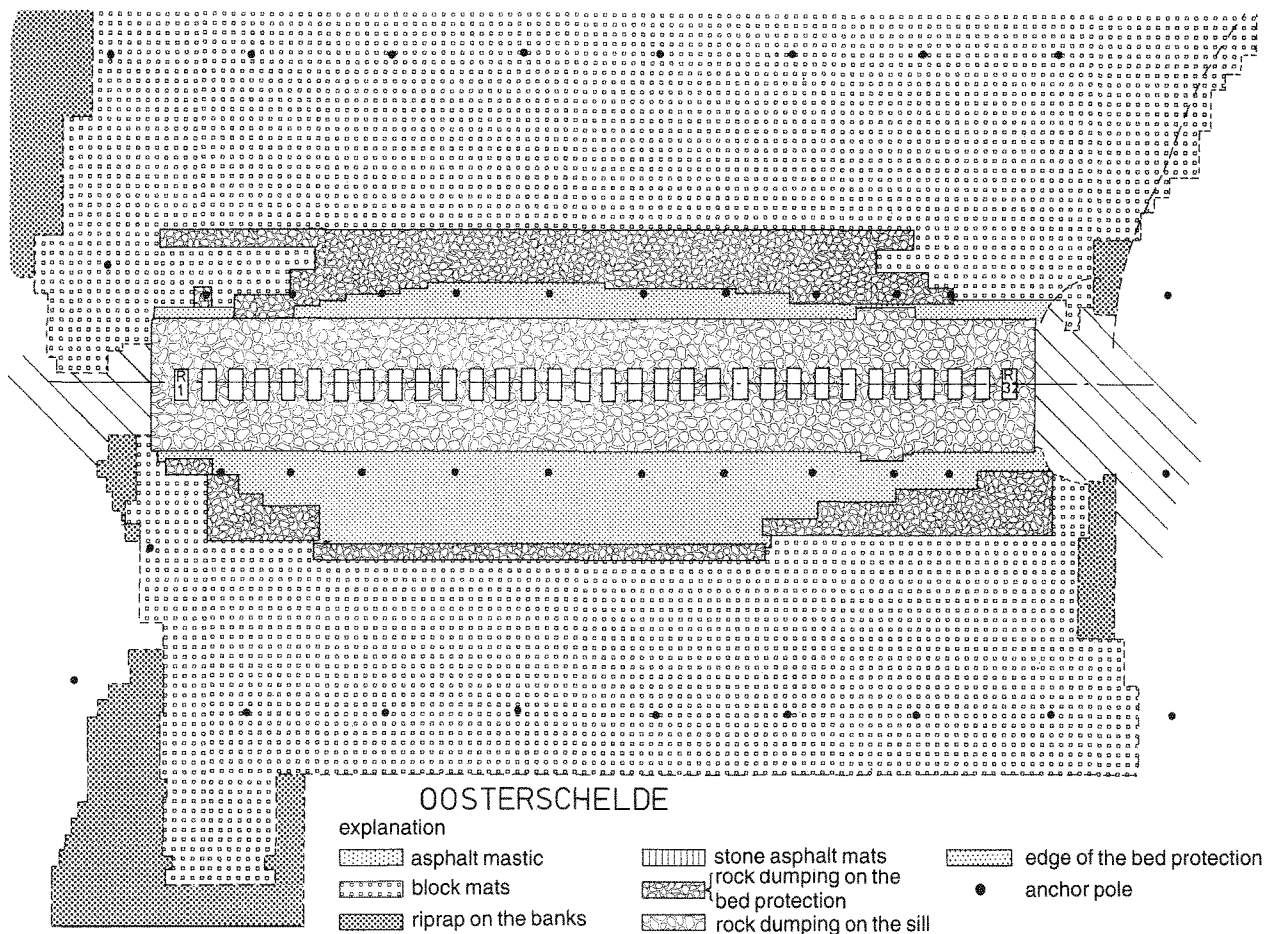

Fig. 14 Bottom protection Roompot.

On the upper-, back- and front side of the pier foot, heavy cams were constructed for gripping the hoisting equipment of the previously mentioned transport and location vessel.

The pier shaft has a twofold function:

- On the one hand, to supply a conductor to the gates;
- On the other hand, to support the upper beam of the stream gap and the traffic bridge (Fig. 19).

On the seaside, there are grooves in the sides of the pier shaft for the conductor of the gates.

In this, the aluminium bronze sliding sections of the actual conductor are constructed on a cast-in steel construction.

On both sides of the gate recesses the pier shaft is lengthened by means of concrete extension pieces placed later (consoles), for supporting the hydraulic cylinders of the operating mechanism of the gates. Behind the gate recesses there is space left for supporting the upper beams.

On the Oosterschelde side the pier shaft supports the concrete boxes of the traffic bridge. To limit, on the one hand, the horizontal size of the pier shaft, and on the other hand, to ensure sufficient support space, the top of the pier shaft is extended with a cast-in console. There are two openings inside this section of the pier which give access to the hollow space of the pier foot making undergrouting and filling this space up with sand possible. If, in the future, it is desirable to extend the motorway across the Oosterschelde with an extra lane, then it is possible to place a concrete element on the pier foot of the Oosterschelde side adjacent to the pier shaft and the console,

to support the extra traffic bridges (Fig. 17).

The edge piers of the three flow channels also have, beside the previously mentioned support- and conductor functions, a function as abutment at the end of the rubble dam which forms the transition to the earth dam components. For this purpose, the horizontal size of the pier shaft in the direction of the Oosterschelde is enlarged, and both on the seaside and on the Oosterschelde side a triangular shaped concrete extension piece is positioned on the pier foot and against the pier shaft (Fig. 20).

Two piers have accessible spaces in the pier foot to make future research into the condition of the foundation bed and sub soil underneath the pier foot possible. Normally these spaces are filled with water and may only be dried during the carrying out of investigation.

One of the piers is designed as a Universally Usable Pier (UUP). From this, the shaft section could only be finished off at a later stage with the help of individually made elements so that the required shaft height, dependent on the position, could be realised. In a later stage of construction, this pier became a reserve pier, which reduced the number of outlets in the Roompot from 32 to 31.

This reduction became possible because less flagstone mats were placed in practice than was expected in the design, which increased the realized flow gap beneath the level of MSL. Going out from the required 18.000 m², one flow section could be dropped (see Part 1, Section 3.1).

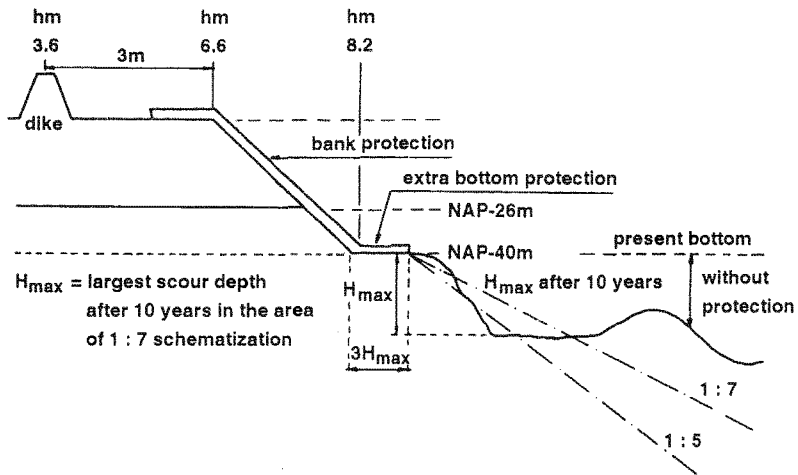

Fig. 15 Bottom protection along the Noord-Beveland bank, Roompot-east.

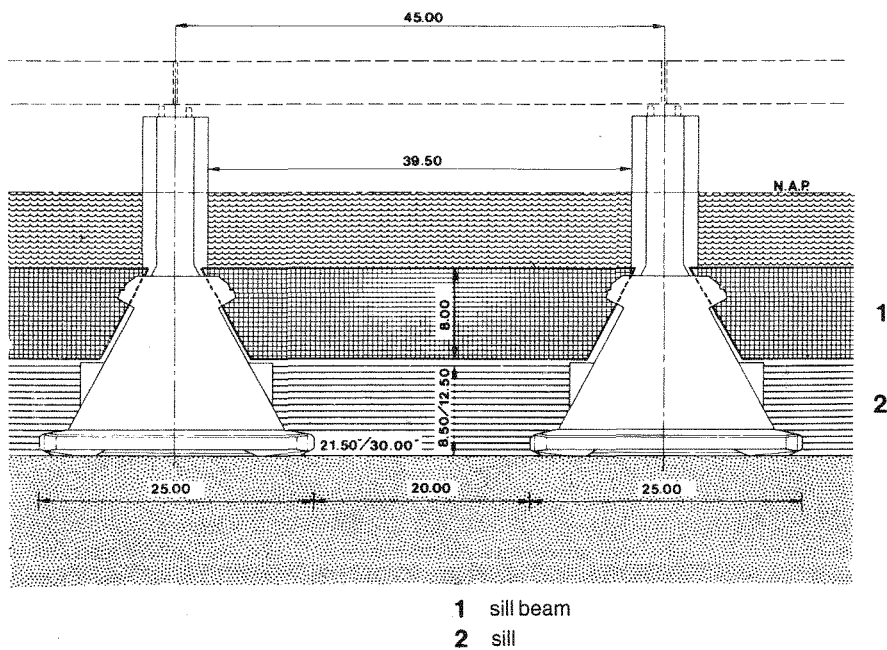

Fig. 16 Main measurements of the construction in transverse direction.

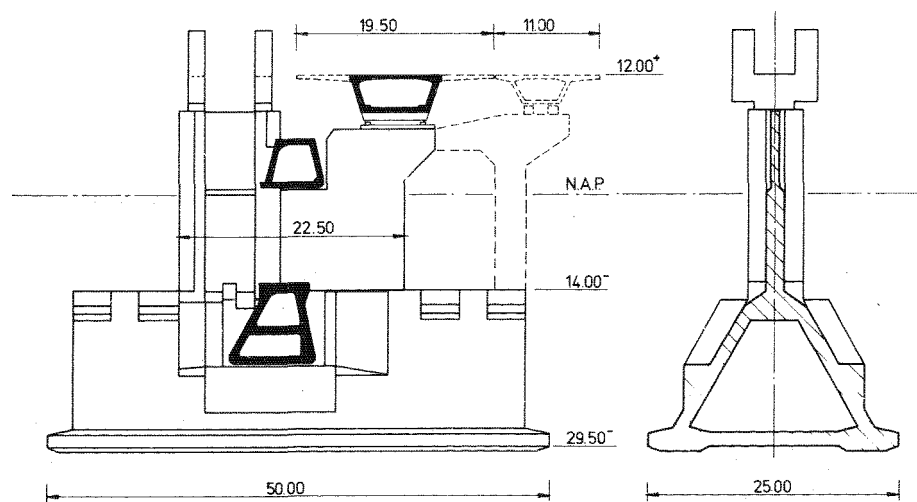

Fig. 17 Profile and section of the pier.

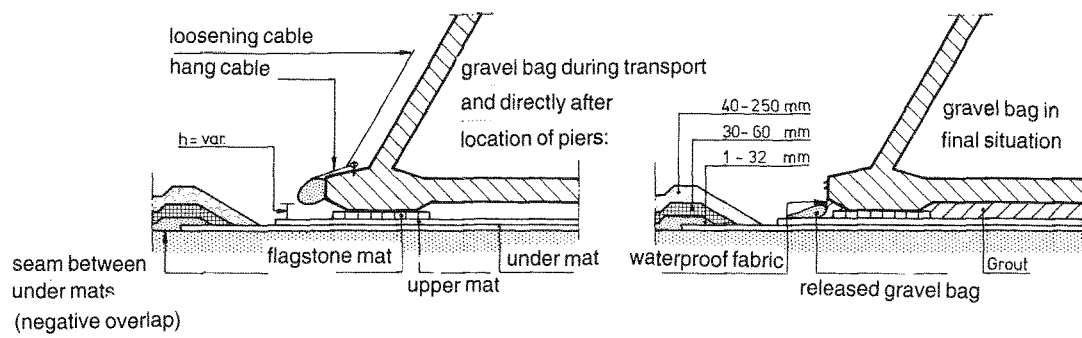

Fig. 18 Under grouting of the pier.

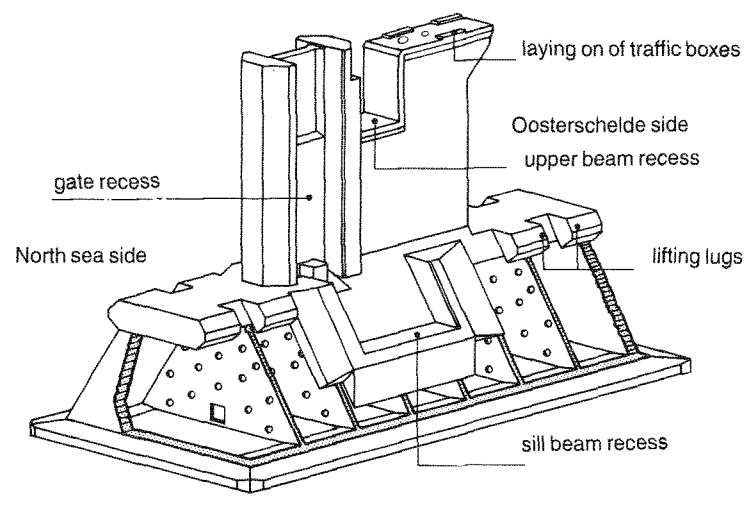

Fig. 19 More details of the pier.

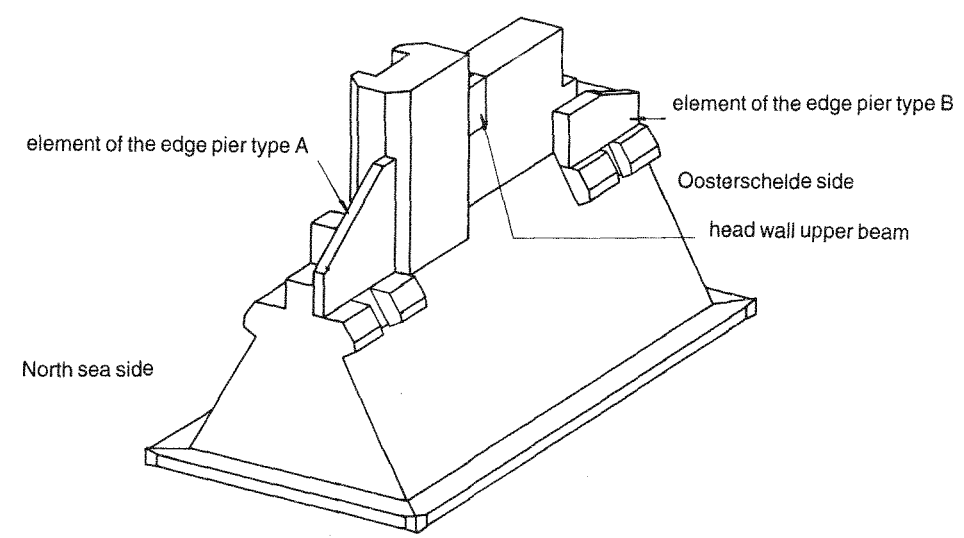

Fig. 20 Abutment pier.

Finally, the Universally Usable Pier was not used.

2.6 Other concrete elements

In the previous Sections, a number of concrete elements were already mentioned which form, together with the piers, the fixed part of the movable storm-surge barrier. This Section will discuss these elements in more detail, including the sequence of assembly.

2.6.1 Sill beam

The sill beam (Fig. 21) is designed as a box with, basically, a trapezium formed cross section of 8 m high, with at the top a width of 5 m and at the bed a width of 8.73 m. The finishing walls are adjusted to the form of the recess on the side walls of the pier foot. The total length is roughly 39 m, adjusted to the distance between the piers between which it will be placed.

The height of the sill beams is dependent upon the location in the cross section of the flow channel and varies between MSL - 4.50 m and MSL - 10.50 m for the upper side of the beam in one meter stages.

The lower sill of rubble is designed in such a way that it does not support the sill beam.

The transmission of horizontal- and torsion loads is dependent upon the deformations of the sill and the pier. Flexures in the planes perpendicular to and parallel with the axis of the barrier are admissible.

The support system of the sill beam consists of 4 support constructions per side (see Fig. 21), which have built in steel jacks. After placing the beam, these jacks are filled with a grout mixture.

In case of a failing gate under storm-surge conditions, water with a great difference in head can flow over the sill beam with high velocity.

Because of the difference in load below and above the beam, strong forces can occur. The trapezium form and the sand filling (± 8000 KN below the water level) guarantee the vertical stability.

The dry weight of the sill beam is about 28000 KN.

The sill beams were made in a construction dock and transported, partially hanging below the water level, to the construction site. From this, the lifting capacity of the placement vessel could be limited to 15000 KN. On the upper edge of the sill beam, points of application were constructed for the hoisting equipment.

2.6.2 Upper beam

For the most part, the cross section of the trapezium formed upper beam (Fig. 22) also has the same height of 4.80 m, a bed width of 6 m, and a top width of 4 m. In the pier shaft support position the width is decreased to 3.5 m.

On the sea side of the lower edge, a nose was designed to reduce the variations of loads in the flowing water between the upper beam and the steel gate and through that to decrease the generation of vibrations in the upper section of the gate.

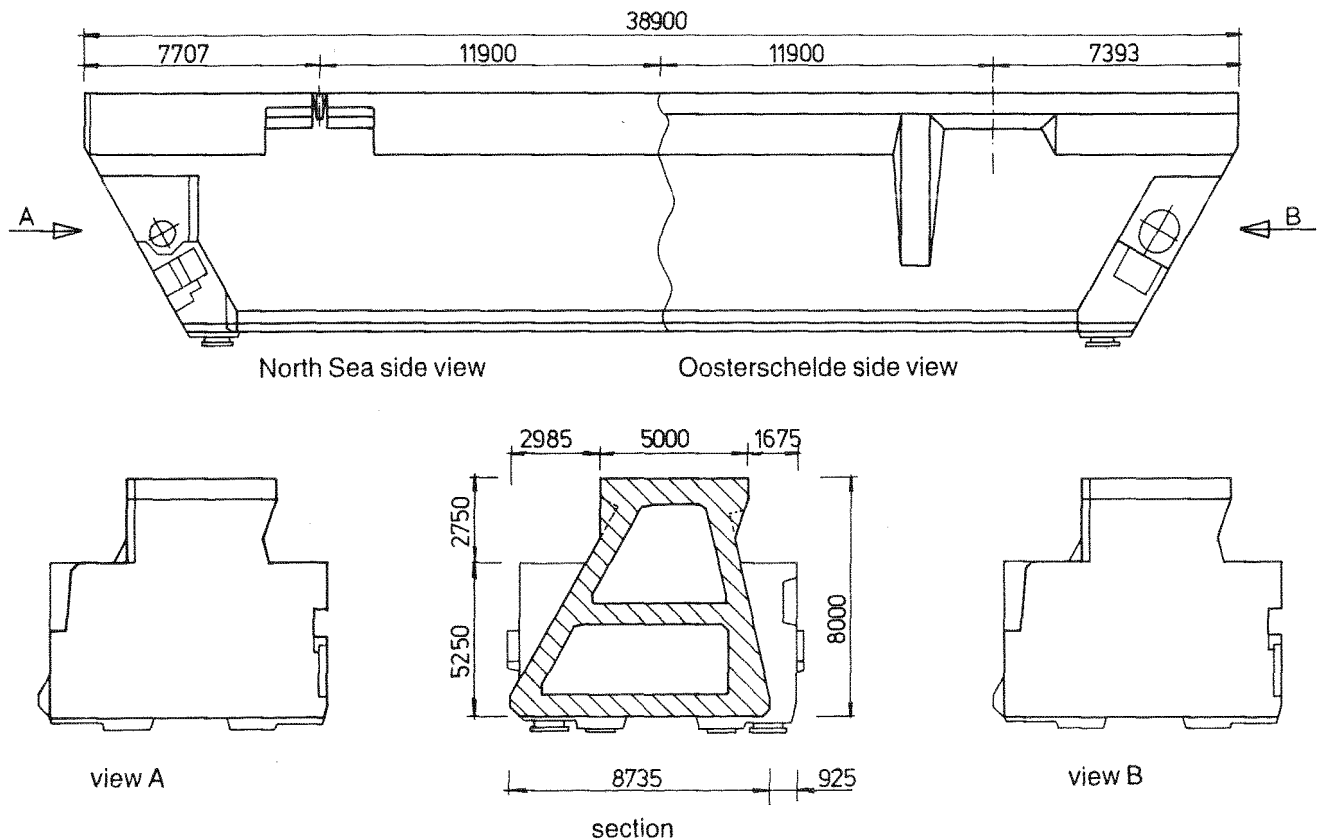

Fig. 21 Sill beam (measurements in mm).

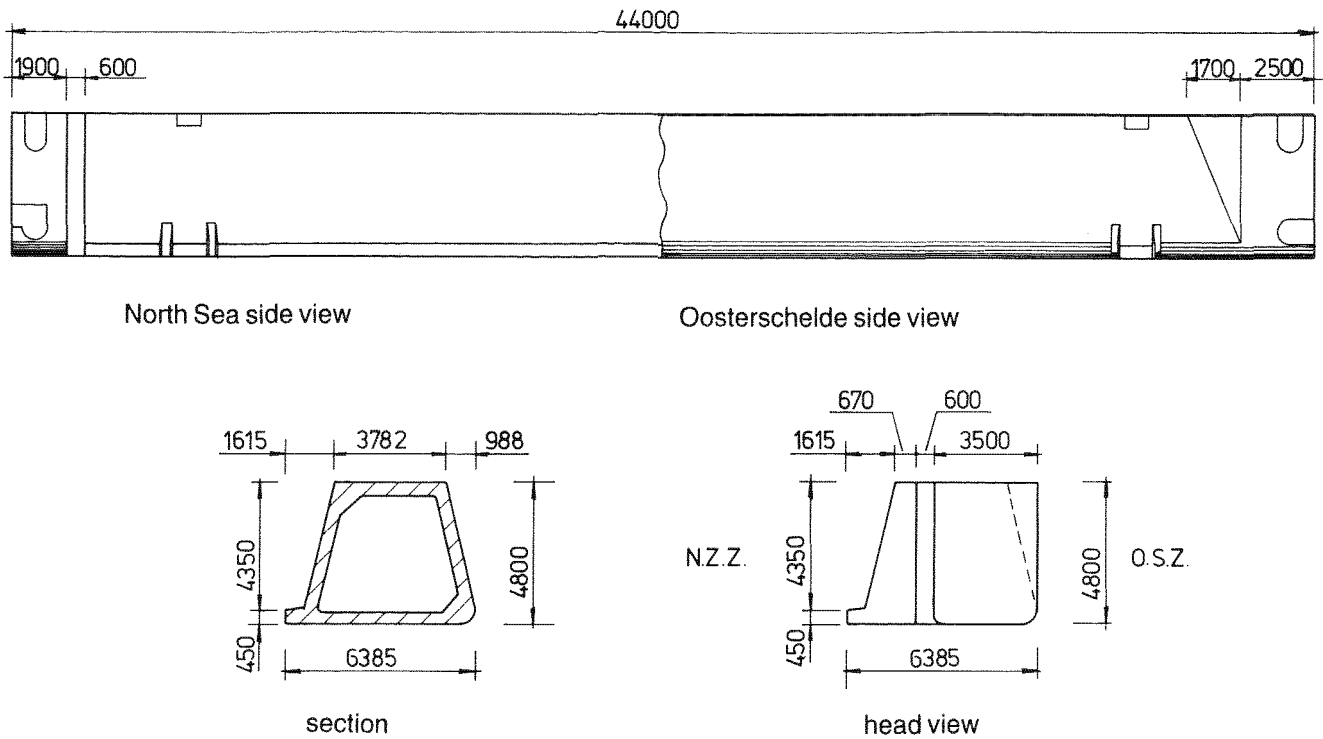

Fig. 22 Upper beam (measurements in mm).

The length of the upper beam is approx. 44 m, dependent on the, in practice realised, pier distance.

Contrary to the sill beam, the upper beam has a fixed level, the top is at MSL + 5.80 m and the bed part is at MSL + 1 m, with regard to the Hammen and the Schaar it is respectively MSL + 5.60 m and MSL + 0.80 m for the Hammen.

The nett weight of about 12.3000 KN of the upper beam is sufficient to compensate the vertical wave load so that no ballast is necessary.

2.6.3 Consoles

The name of these prefabricated extension pieces is derived from a previous design.

At present, they are more or less forked extension pieces (see Fig. 23) which are attached to both sides of the gate recesses by means of a prestressed anchoring on the pier shaft. They serve as support for the hydraulic cylinders (see Fig. 25).

The height of the legs of the fork varies between 0.73 m and 6.40 m, calculated from the upper surface of the horizontal section. This size is mainly determined by the length of the hydraulic cylinder. There are seven different types, the largest weighs approx. 2500 KN. The height of the foot of the fork was adjusted to the realised height of the support level on the pier.

2.6.4 Box girders

The bridge spans which have to direct a motorway and a construction road across the storm-surge barrier are constructed as concrete box girders with extensions on both sides (Fig. 24).

The box has a trapezium formed cross section with a top width

of 9.25 m (under 6 m), and a normal height of 3.60 m, in the place of the supports enlarged to below to 4.50 m. The length of the box is approx. 44.20 m dependent on the realised pier distance. The traffic boxes, which weigh about 12.000 KN, were placed as a whole without extensions. With an eye on uneven pier settings a three-points support was devised, that is to say on one pier two supports and on the other pier one support.

The extensions on both sides (with a width of approx. 4.80 and 5.45 m) were constructed in a later stage after placing the box. A total width of 19.51 m then results which is divided into a construction road with a width of 5.50 m and a traffic road with a width of 10.95.

The inner space of the traffic box is used to store hydraulic and electrical equipment necessary for the control of the hydraulic cylinders and to store cables used for energy- and signal transmission, a water conduit, and possibly in a later stage a load pipeline for sewage and PZEM-energy cables. Also, across the entire length of a flow channel a passage has been left open so that each point of the traffic box can be reached with a small carriage from the inside (see Section 2.8.2 and Fig. 38).

2.6.5 Sequence of assembly

The sequence of assembly of the above mentioned concrete elements and the steel gates with their operational mechanisms, are determined by a number of factors such as:

- The position and geometry of the element;
- The increasing flow velocities in the stream gap due to the increasing narrowing thereof, which causes limitations for the placement vessels;
- The mutual dependency of the elements;

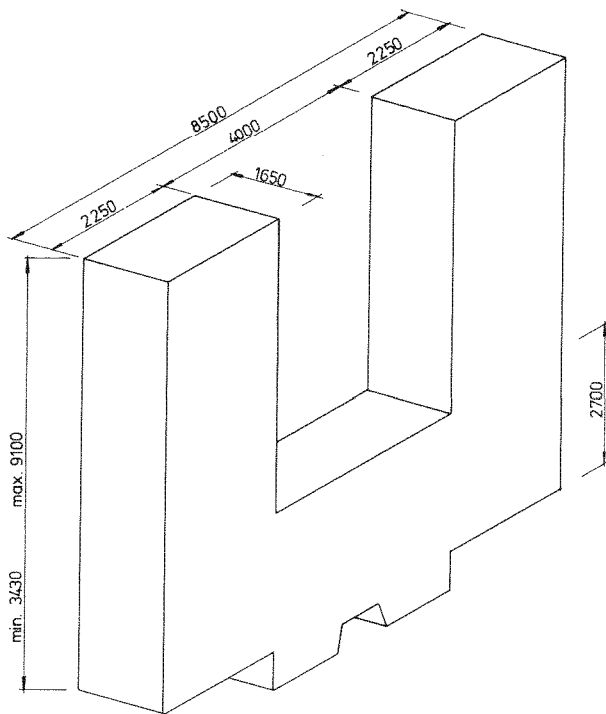

Fig. 23 Console (measurements in mm).

- The passage of time of the final construction after placement.

Without going into further details and considering these factors, the following sequence of assembly was used (Fig. 25).

In relation to the three closure gaps, construction was carried from north to south. For the placing of the various elements, a.o. sill beams and gates, at times another sequence was used for hydraulic and morphological reasons.

2.7 The sill

The sill forms the flow resistant but permeable closure of the space between the sill beam and the bed of the stream gap.

The sill is made up of various sizes of rubble. The sizes of the rubble are determined by the gradient (slope) in the sill body and the sub soil, and by the current attack along the surface in various situations. The design requires that in these situations no material can be moved. The principle of the filter build up is maintained with the transition of fine to more coarse material. This is valid for both the transition of the bed to the sill body, whereby no consideration is given to the presence of the fabric of the foundation mats, and for the construction of the sill body itself.

The core of the sill is mainly rubble (weight per piece is 10-60 kg). Along the surface and on the top, heavier varieties of stone were used. The stone sorts used were granite and basalt which have a specific gravity of 2.8 to 3.0 whereby in the outer layers and at the top only stone with a specific gravity of 3 was used (basalt).

Figure 26 and 27 show a section of the sill located at respectively a shallow (Schaar 4) and a deep stream gap (Roompot 12). On the sea side slope inclines of 1:3 are applied; on the Oosterschelde side, only in the Roompot, a slope incline of

1:3.5 is applied, and also in the Hammen and the Schaar a slope incline of 1:3.

In the place of the heaviest stones (larger than 3 ton weight per stone), the pier foot is protected against overturning stones by dumping of stone asphalt (Fig. 28).

The sill is constructed in two phases.

The first phase, the biggest part of the sill body (see Figs. 26 and 27), was constructed before the placing of the sill beam. The upper level of the sill was then about 1.5 m beneath the bed side of the sill beam. After the placing of the sill beam the top of the sill was constructed whereby the sill beam was partially packed in. The gap of approx. 1.5 m between the bed side of the sill beam and the upper side of the sill (phase 1) remained and was closed off on both sides. On the sea side concrete blocks of 1 and 2 m³ were used for this, while on the Oosterschelde side heavy rubble was used in the range of 1-3 ton and 6-10 ton, depending on the expected loads.

Between the toe of the sill and the aprons of asphalt mastic already mentioned in Section 2.4, a transition construction of rubble was built which covered the protruding ends of the filter mat of the foundation bed (Fig. 29). Here also the principle of filter build up is continued. The stone sorting of the top layer is dependent upon the expected flow attack. Figures 30 and 31 show an overview of the stone sorts in the top layer of both the sill and the transition construction in the three flow gaps.

2.8 Design of gates and operating machinery

2.8.1 Gates

The actual stream apertures formed by the piers, sill- and upper beam, can be closed by steel gates which are positioned on the sea side of the sill- and upper beam (Fig. 25).

The closure of the aperture is not complete, between the gate and the sill- and upper beam there will always be a gap. The gate is therefore only supported in the recesses in the piers.

As mentioned earlier (Section 2.6.1) the height of the aperture varies with the location in the cross section of the relevant flow channel. This variation occurs in steps of 1 meter, whereby the clear measure between the sill- and upper beam varies from 5.50 m to 11.50 m. So that seven different sizes of apertures exist for which seven different types of gates were designed, once again with in between steps of 1 meter in height varying from 5.90 m to 11.90 m.

There are 62 gates in total, their weight varying from 3000 to 5000 KN. The gates are composed of the following components (Fig. 32):

- Vertical plate construction;
- Horizontal main support system;
- Vertical connection system;
- Two vertical end boxes.

Cylindrical segments are chosen for the plate construction, which are situated on the Oosterschelde side of the gates. There are mainly tensile strains in the segments; there is only compressive stress when the water level of the Oosterschelde is higher than the water level of the North Sea. The segments are designed in such a way that this compressive stress is admissible. The loads on these segments are transmitted to the main supporting system via small vertical girders.

The main supporting system is composed of two or three horizontal lattice girders, dependent on the gate height.

The lattice girders, and also the rods of the vertical connection

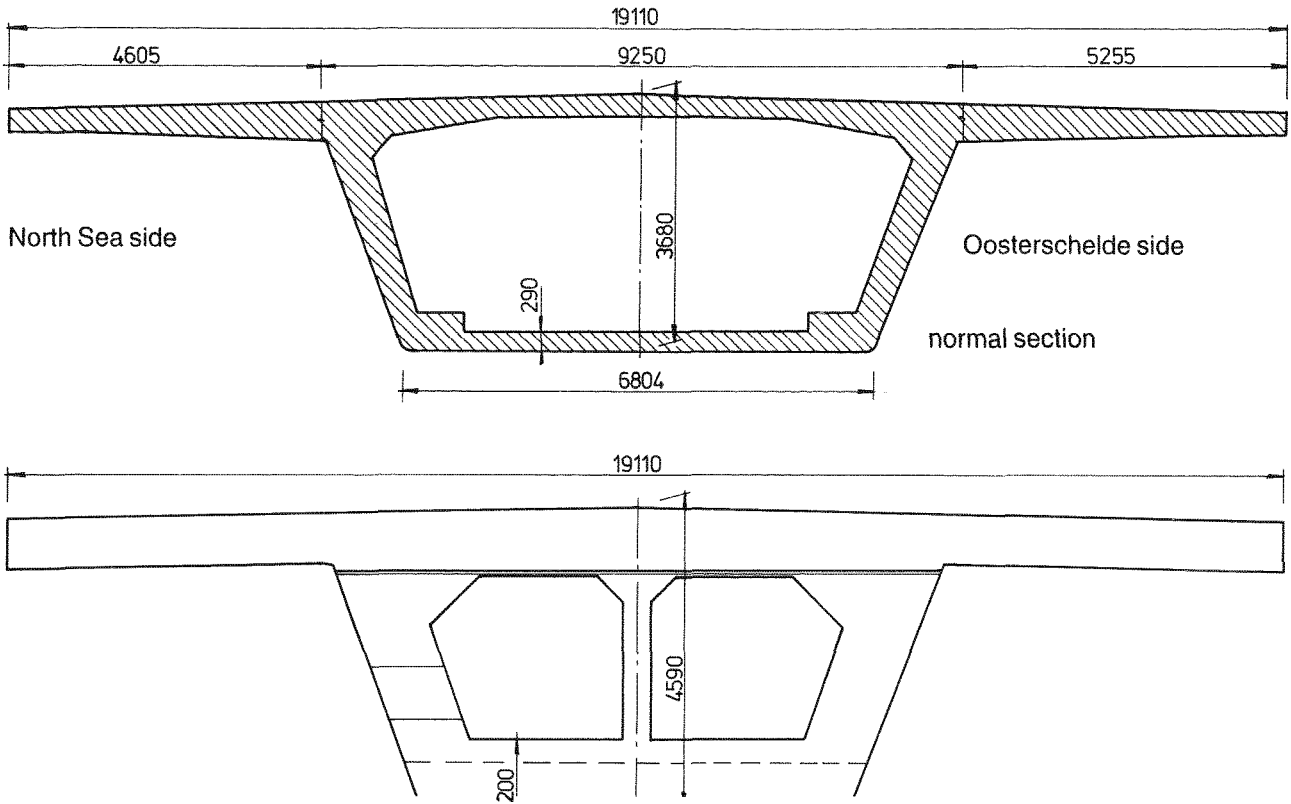

Fig. 24 Box girder (measurements in mm).

are constructed out of tubes, which produce less sensitivity with regard to wave impact.

The vertical connection in the gates is chosen and positioned in such a way that the torsion stiffness of the gates is no larger than is necessary for the stability. From this a limited torsion deformation can be accepted without too much secondary stress.

The horizontal loads on the gates are transmitted via the end boxes to the gate recesses in the piers. In the connection of the lattice section of the gate on the end box it was possible to adjust the length of the gate to the distance between the piers. The gates are designed as sliding gates. The original sliding plane is formed by a strip of synthetic material attached to the end box via a thick rubber strip, and an aluminium bronze strip which is electrically insulated to prevent galvanized corrosion, attached to a steel strip cast in the concrete at the recesses of the pier (Fig. 33).

In comparison with the hydrostatic load, the wave load on the gates is high. To limit the resulting horizontal movement of the gate, perpendicular on the axis of the barrier, to a minimum the gate is clamped between the conductors in the recesses, whereby the previously mentioned rubber strips are brought to a certain prestress. The horizontal movements, parallel to the axis of the barrier are accounted for by separate supports which are constructed in the recesses against the pier shaft. The whole gate was lowered into the recesses by a floating derrick whereby a searching device above the recesses made sure that the rubber strips were gradually brought under prestress.

2.8.2 Operating machinery

Each gate is hung at both ends and moved. In principle, per gate there are two operational mechanisms which function independently from each other. The task of the operational mechanism can be summarized in the following four points:

- 1 To keep the gate lifted;
- 2 To close the gate;
- 3 To keep the gate pressed to the bottom stops (in the pier);
- 4 To open (lift up) the gate.

Per side, the operational mechanism of a gate consists of the following main components:

- A double-working hydraulic cylinder;
- An electro-hydraulic drive unit;
- An electronic steering unit.

The design of the operational mechanism, in particular the hydraulic cylinder and the drive unit, is adjusted to the (lift)height of the gate to be operated. Because there are seven different types of gates, there are also seven different types of operational mechanisms. For practical and esthetical reasons there are two similar operational mechanisms per pier, which means that in practice not every gate is operated by two similar operational mechanisms.

The previously mentioned practical reasons meant the mutual interchangeability per pier of the drive unit. For esthetical reasons it was desired to set up two cylinders with similar measurements per pier.

The hydraulic cylinder (see Fig. 34) is supported by the legs of the consoles on the pier via a yoke. The yoke is a welded steel frame which is hinged to the cylinder casing. The yoke spans the gate and is hinged on the legs of the recess of the consoles with bearing brackets. The rotating axis of the two mentioned

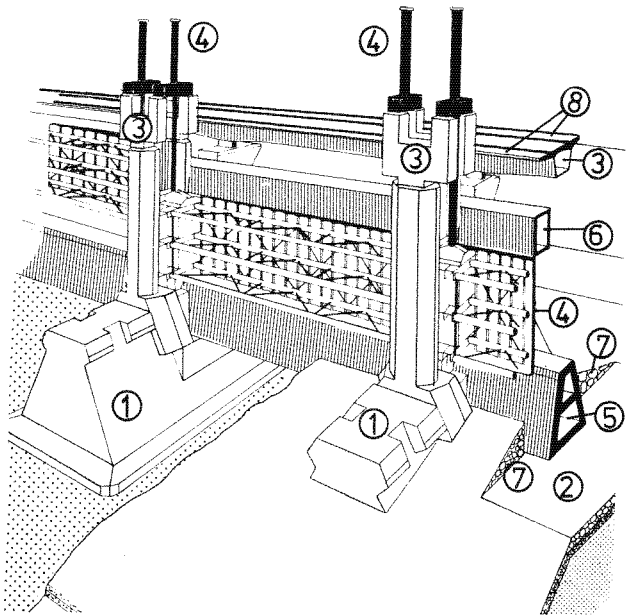

1. Piers
2. Dumping of the sill to the bed part of the sill beam
3. Girder boxes and consoles
4. Sluice Gates and cylinders
5. Sill beams
6. Upper beams (behind closed gates)
7. Top layer of the sill (wrapping the sill beam)
8. Construction of extensions of the girder boxes

Fig. 25 Assembly sequence of elements for the movable barrier.

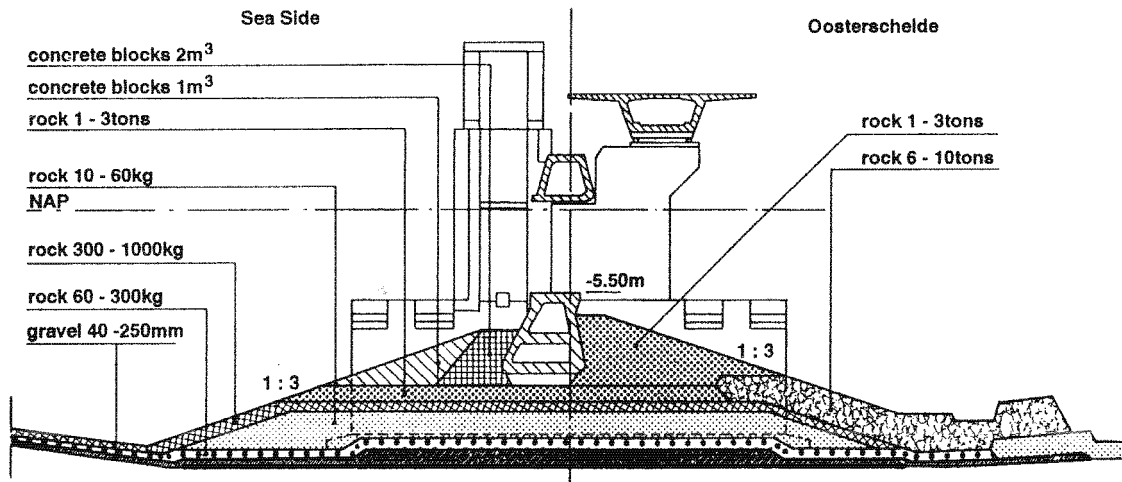

Fig. 26 The sill at the location of Schaar 4.

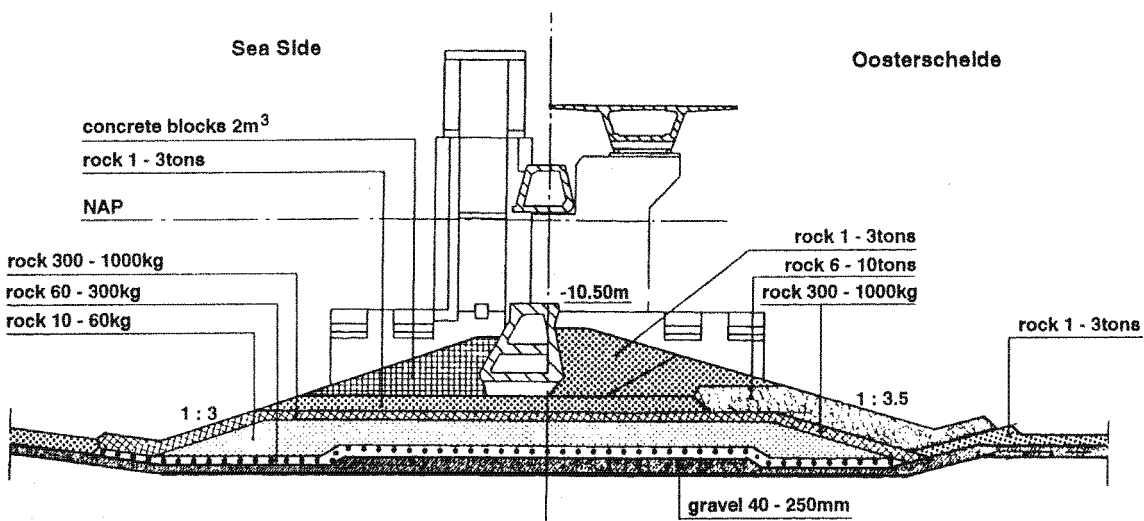

Fig. 27 The sill at the location of Roompot 12.

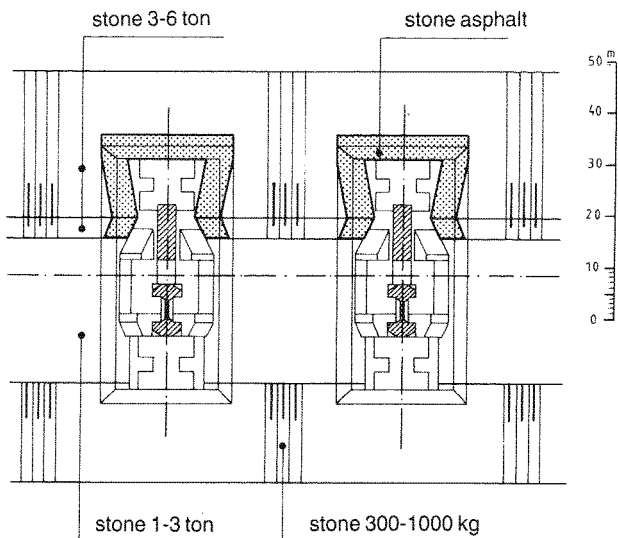

Fig. 28 The sill with asphalt strip around the pier.

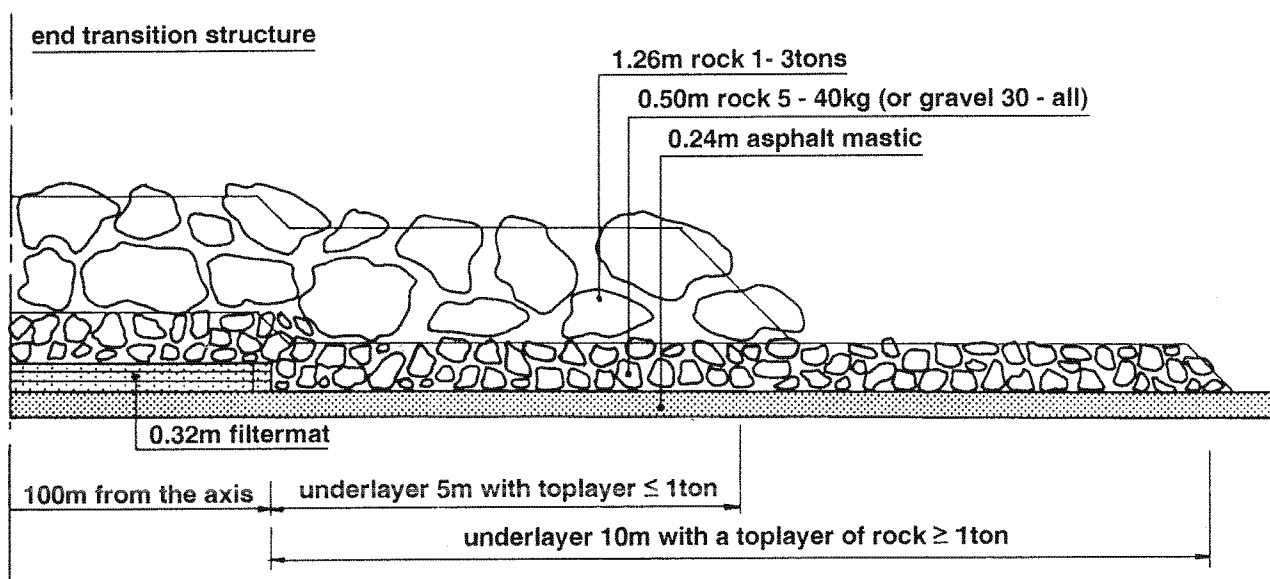

Fig. 29 Finishing transition construction.

hinged connections are perpendicular to each other. This makes angle rotations of the cylinders possible in all directions with regard to the pier. All hinge points are fitted with ball and socket bearings because of the strong loads, the small rotation angles under the occurring loads, and because of the compact construction.

The hydraulical cylinder consists mainly of:

- A cylinder casing, closed with a lid from the top, and closed with a pin wheel from the bed and a preservation chamber;
- A piston rod with a piston and an eye for the hinge connection with the gate. The eye is connected with the end post of the gate via a ball and socket bearing and a short axis.

The stroke of the cylinder is adjusted to the (lift)height of the relevant gate with an extra lift height of 1300 mm to be able to set the gate in a higher position for the maintenance purposes.

The piston is led with a bush in the cylinder casing and carries a

double set of oil seals.

The piston rod is led with a bush in the pin wheel, which also contains the rod seal.

To accommodate the bearers of the hinge points and for the introduction of the longitudinal loads in the cylinder wall, a thickened section, the universal ring, is included in the cylinder casing. The supply and drainage of oil for the movement is done via the lid and the pin wheel.

To improve the sliding qualities of the piston rod and to protect it against corrosion it is provided with an electrolytically applied layer of chrome, and with a layer of nickel underneath. As extra protection against corrosion, an oily preservation layer is applied from the preservation chamber to the rod section which slides out, which when sliding in is again removed.

All operations are carried out under an active oil load, the downwards movement is carried out against a passive oil load to receive wave impact in the system. The condition of the gate

Schaar van Roggenplaat

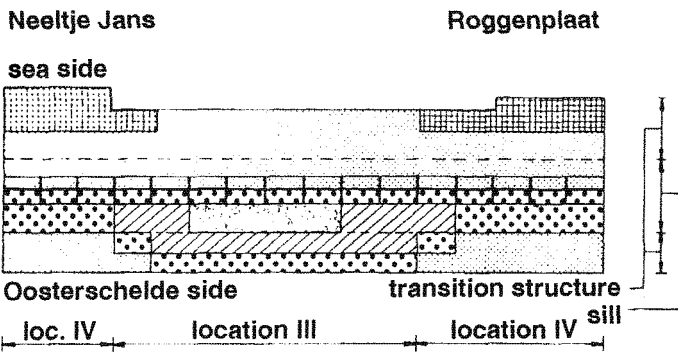

Hammen

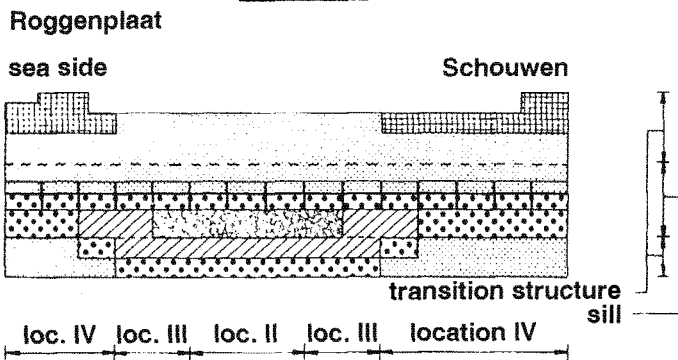

symbols:

	rock range 6 - 10t.
	" " 3 - 6t.
	" " 1 - 3t.
	" " 300 - 1000kg
	" " 60 - 300kg

- for all rock in the toplayer $\rho = 3t/m^3$

- ΔH failure sea side = 2.40m

Fig. 30 Sorts of stone in the top layer of the sill: Schaar and Hammen.

Roompot

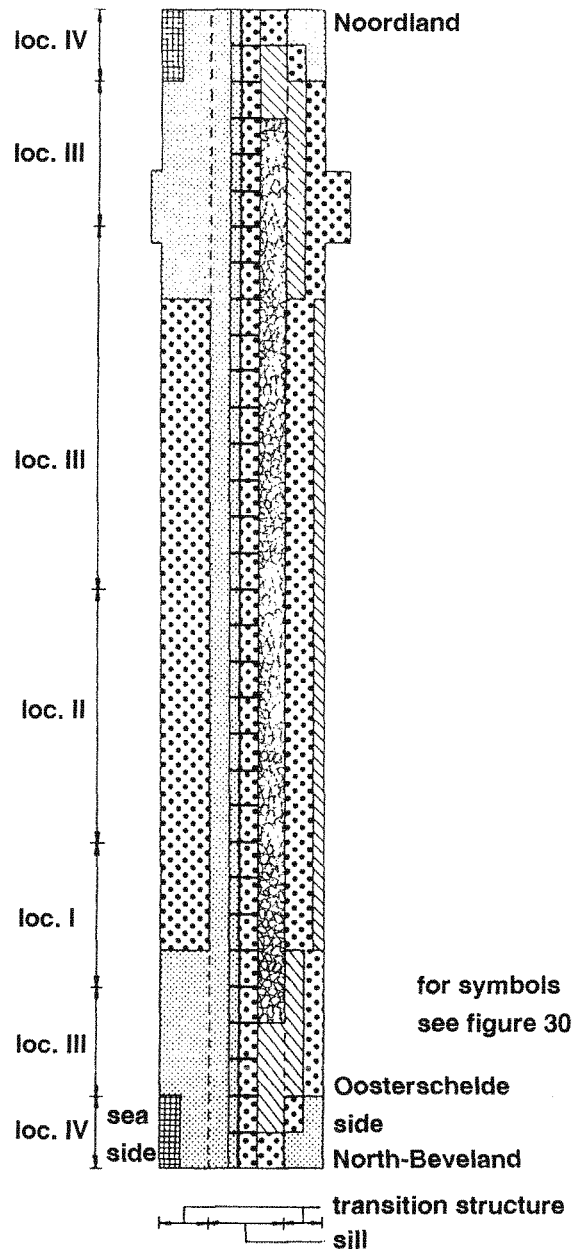

Fig. 31 Sorts of stone in top layer of the sill: Roompot (for explanation see Fig. 30).

is also monitored by active oil load when it is standing still. All cylinders have the same load level: maximum operational load 220 bar and testing load 270 bar (1 bar = 10^5 N/m^2).

Table 1 shows some measurements of the cylinders.

Both upward and downward movement velocity is fixed at approx. 3 mm per second.

Every cylinder is supplied with signal apparatus for the steering unit to indicate the position of the piston rod and of the relevant gate.

The hydraulic operational unit for a cylinder consists mainly of an electrically driven pump, valves, gates, securities and load switches. This operational unit supplies the pressurised oil for the movement of the piston rod and maintains the pressure in

the system during standstill. Figure 35 shows, in a diagram, the operational unit in combination with the cylinders.

The two operational units for the cylinders on one pier are housed together in one container in the inner chamber of the box girder. By a relatively simple manual switch-over, these units can function as each others reserves. The installation container had the advantage in that the installation work on the building site was limited to the construction of the connection pipes (once only) and that both during the finishing construction of the barrier and during the operation, a good protection against damages and pollution was given. Also the noise level in the box girder is limited when the units are operational.

The buffer tank for the hydraulic oil is positioned beside the

hydraulic container in the box girder.

The hydraulic pipes which connect the operational unit with the cylinder are placed against the casing of the box girder and go outwards at the side of the fixed support of the box girder. On the pier, these pipes are combined as much as possible with the railings of the steps together with the electrical connections which give access to the cylinders on the pier (see Fig.36).

The electrical steering unit for the operational work looks after the translation of the central or local input of operational orders and receives the signals concerning the situation from the cylinders and the operational unit in the necessary steering- and power current switches. This unit also feeds back important information to the central management (see Section 2.8.4). It is also possible to put in and present data there and then. Vital components of this steering unit are carried out in triplicate, whereby majority decisions are passed on (2 out of 3).

Figure 37 shows the outline of the relationship between the steering unit with the operational unit and central control. The steering units of the operational work of one gate, with its apparatus for power- and steering current are also accommodated in the container in the inner chamber of the box girder. In the box girder, spread over the barrier, there are also containers for construction places, condition surveillance, environmental surveys, transformers, etc.

All these elements were constructed beforehand at the place of fabrication of the box girders (Fig. 38).

2.8.3 Energy supply

The power necessary to operate a gate, varies from between 49 and 73 KVA depending on the size of the gate.

For the simultaneous movement of all gates, the total power necessary is 4000 kVA.

The remaining power necessary for the barrier to operate the lights, the heating, the surveillance, the signalling, for the monitoring and service building and for the Roompot Lock, is 450 KVA in total.

The necessity for simultaneous movement of the gate will only rarely occur. The maximum output will seldom have to be generated.

With regard to the energy supply, the decision was made whereby the maximum output would be supplied by two individual diesel power stations, and the power necessary for operating under normal circumstances would be drawn from the provincial network of PZEM (see Fig. 39). For this purpose a connection has been provided of 800 kVA at 10.000 Volt.

The individual maximum output is generated with 10 diesel aggregates with a capacity of 725 kVA per piece divided over two power stations. While determining the number of aggregates there was the possibility that a small number would not be available because of revision, failure, etc.

The power stations can function electrically independent from each other; they are separated from each other for fire precautions and each contain 5 units.

Per aggregate the low voltage generated is raised with the help of a transformer to the distribution-voltage of 10.000 volt. Provisions have been made to synchronize every aggregate to the frequency of the provincial network so the take-over of the supply occurs without interference and, when testing the aggregates, the generated energy can be returned to the provincial network.

Also, provisions have been made to make it possible, in the case of a current failure in the provincial network, to supply a part of the network with the full capacity of the power stations.

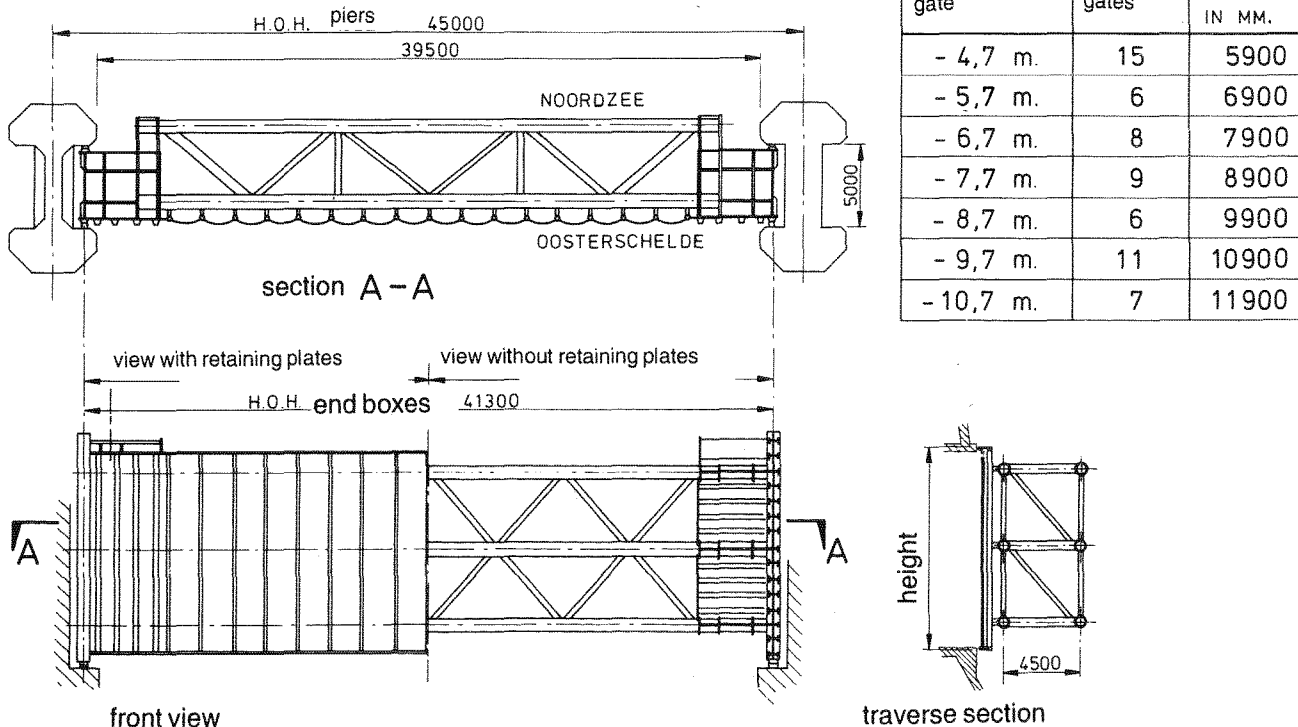

Fig. 32 Construction of the gate.

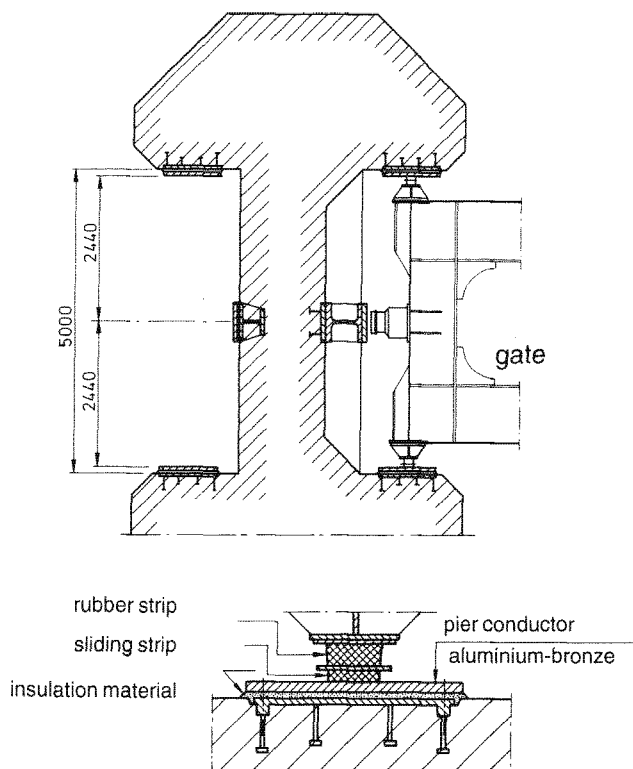

Fig. 33 Sluice Gate conductors in the pier.

The capacity of the power stations or the provincial network is supplied via two main distribution stations, to the distribution network of the barrier. These main distribution stations can independently supply the entire network and are also separated from each other as a fire precaution.

The distribution network for the barrier consists of two ring mains:

- One for the Roompot closure gap and the Roompot Lock; and
- One for the Hammen and Schaar closure gaps.

Under normal circumstances, the ring mains would be open at the end; the circuit would only be closed when there is a failure in the supply of the distribution network, whereby it is possible to switch off the defective section.

On the barrier the distribution voltage is decreased to the working voltage of 220/380 Volt via a number of transformer stations.

From these transformer stations a number of, per box girder, unusual electrical installations are supplied, whereby transformer stations adjacent to each other, on the low voltage side, can function as each others reserve.

The low voltage is distributed per box girder for the different installation components: the illumination, the steering installation, the hydraulic installation and the communication installation. As far as these installations need a rectified current supply, such as for instance the steering, the alternating current supply is transformed, with the help of converters, into a rectified current of high quality.

2.8.4 Operation

During the design of the control complex a central control and a far-reaching automatization of the routine procedures was

created. In addition to this it is also possible to control the operational works individually, per gate, and on the spot, the latter specially for the sake of maintenance.

The control is split into a number of elements (functions):

- To give instructions to perform certain movements with the gates, etc. (centrally and decentrally);
- The feedback of performed instructions, signalling of the situation, including reporting of failures (central presentation and coordination);
- The actual administration of the operational process (decentralized);
- The surveillance of the system against damage caused by failures (decentral and central, by double or triple performance of vital components);
- The passing on of process data (central processing, central and decentral presentation);
- Failure analysis for the sake of repairs and maintenance (central).

The central part of the above mentioned functions are accommodated in the gate controls and surveillance installation in the control building (Fig. 37).

The main components are:

- An operational unit consisting of one drivers panel and one signalling panel controlled by one person, which presents the most important data (Fig. 40);
- A control computer for the operational processing of the process data and instructions of, previously fed in, optional closure programmes;
- A reserve computer, a stand-by, with the same functions as the control computer;
- A service and maintenance computer for processing the process data for the benefit of the maintenance and for the carrying out of failure analyses.

The decentralized section of the functions is accommodated in the control unit already mentioned in Section 2.8.2 with its accompanying peripheral equipment, which is installed per operational work.

The organization of the above mentioned installations is such that the so-called safety closure (all gates to be closed as quickly as possible) can be performed at all times, having priority above other possible control programmes being carried out. The instruction for this procedure goes, bypassing the central control computer, to the decentralized control units, all of which contain a fixed programme for the performance of a safety closure. The connection between the central and decentralized section of the control is maintained by two networks.

- A control network for giving control instructions (a.o. safety closure) and feed back of the results; and
- A data- and communication network, also for passing on

Table 1 A few measurements of cylinders.

	Smallest cylinder (mm)	Largest cylinder (mm)
Length of stroke	5900 + 1300	11900 + 1300
Inside diameter of cylinder	635	830
Minimum wall thickness	62½	75
Piston rod diameter	390	520
Total length inwards	14,675	21,390
Total length outwards	21,875	34,590

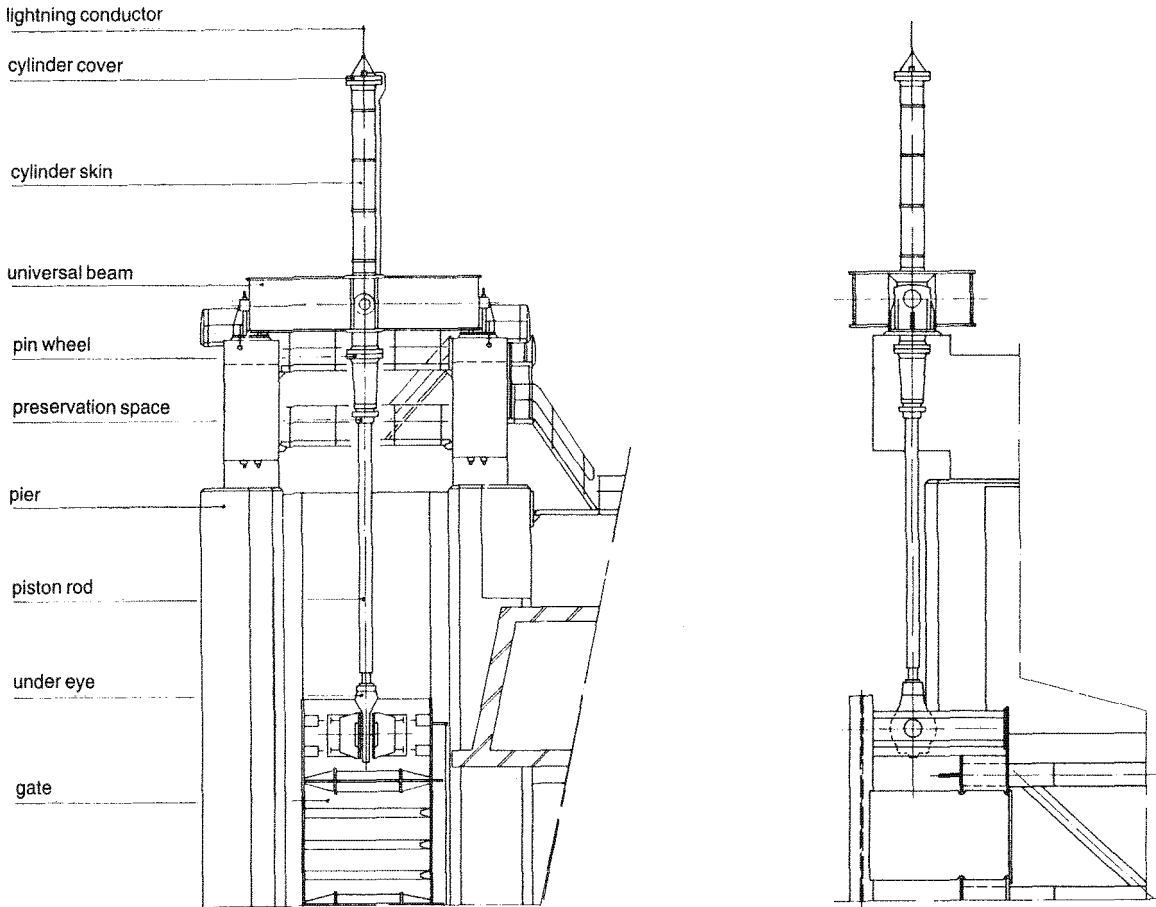

Fig. 34 Operating machinery for gate $h = 11900$ mm.

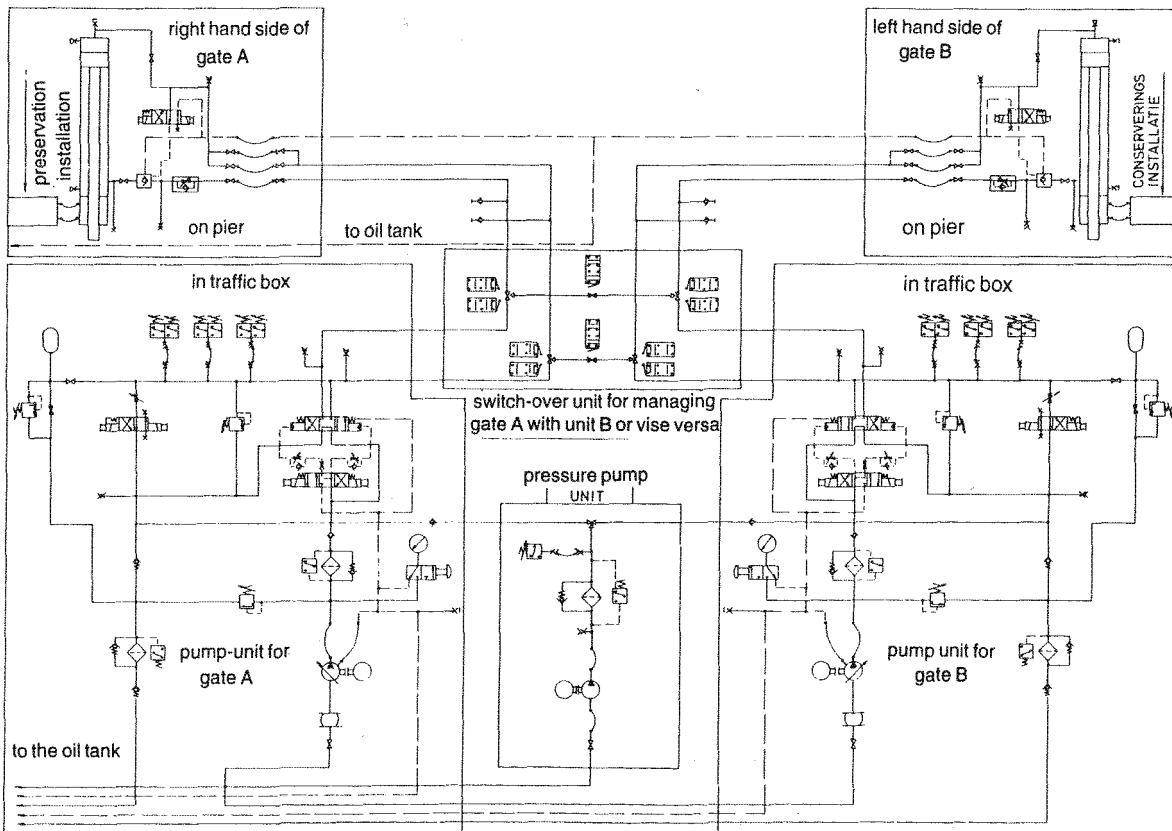

Fig. 35 Hydraulic outline for the operating machinery preservation installation.

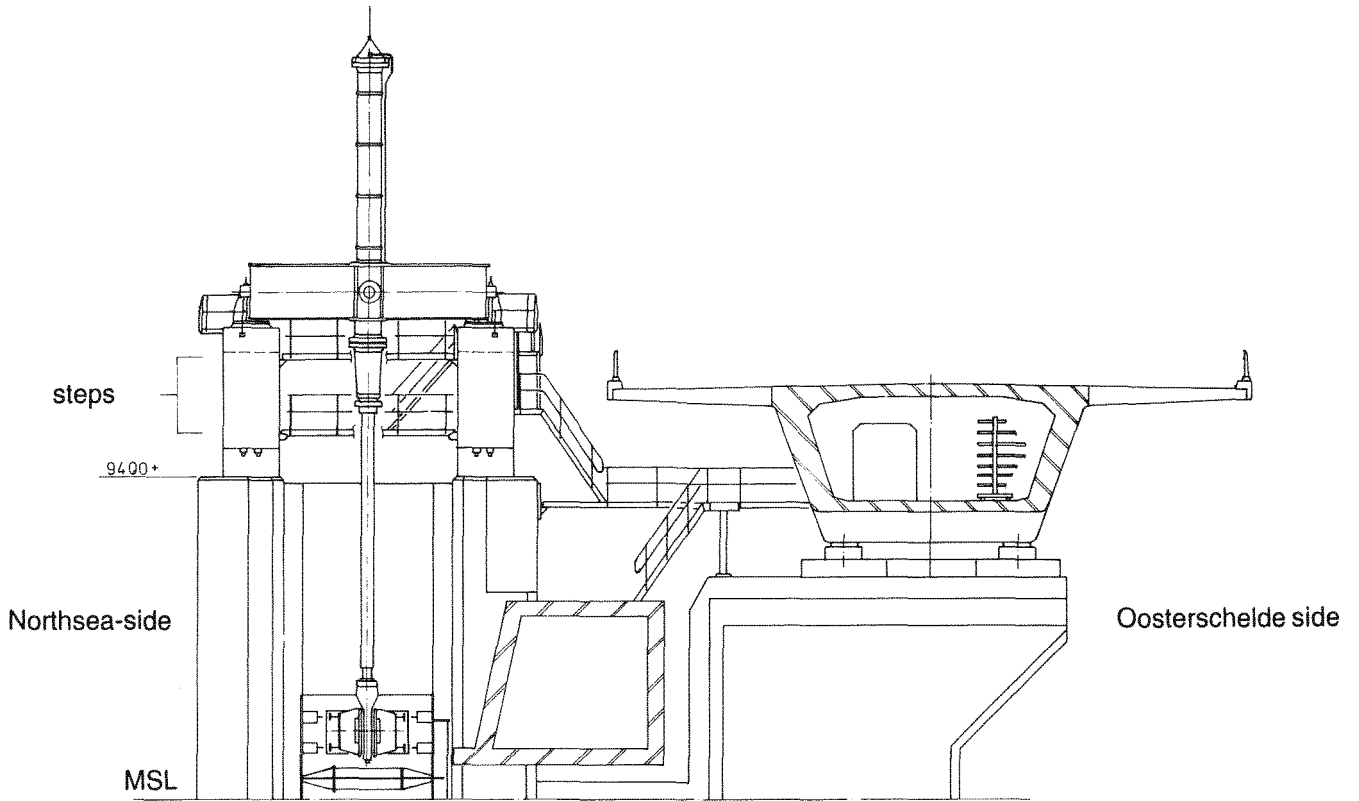

Fig. 36 Steps on pier for gate $h = 11900$ mm.

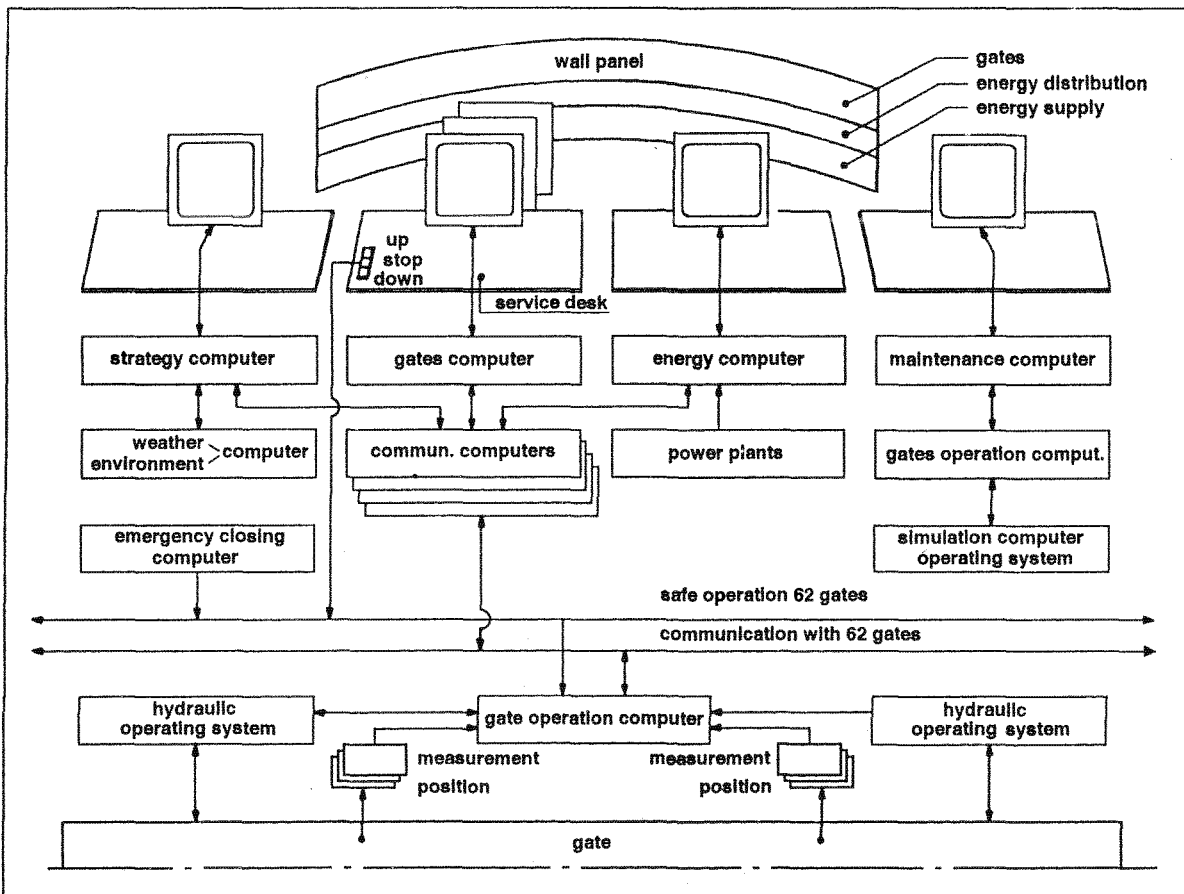

Fig. 37 Outline of the central control and central hydraulic steering.

instructions and feed back of results, as well as for the exchange of various process data.

From this latter network it is also possible to present data elsewhere.

2.8.5 Emergency closure system

To secure the possible failure of the supervisor in the giving of the closure instruction in storm-surge situations (see Part 5, Section 1.7), a provision is made for an automatic emergency closure system.

This system is connected to the control network (safe closure) and generates a start-instruction on the basis of a measured exceedance of the water level.

The emergency closure system consists of:

- A combination of two survey stations on both sides of the barrier, respectively in the Outer- and Inner harbour of

Noordland, with per piece a treble effective measurement system (float-tide-meters).

- A digital data transmission via a double effective cable to the Central Control Building;
- A double effective computer which checks and evaluates the measurement signals and when necessary gives a start instruction to the control network (safe closure) via an automated start.

As can be seen from the above particular attention is paid to the reliability of the emergency closure system.

2.8.6 Lightning security

The storm-surge barrier is a high rising construction in the flat landscape of the Oosterschelde. In particular the cylinders of the lift installations are towering high above. Taking into consideration the statistical lightning expectation for the area around the Oosterschelde, one or two strikes per year have to

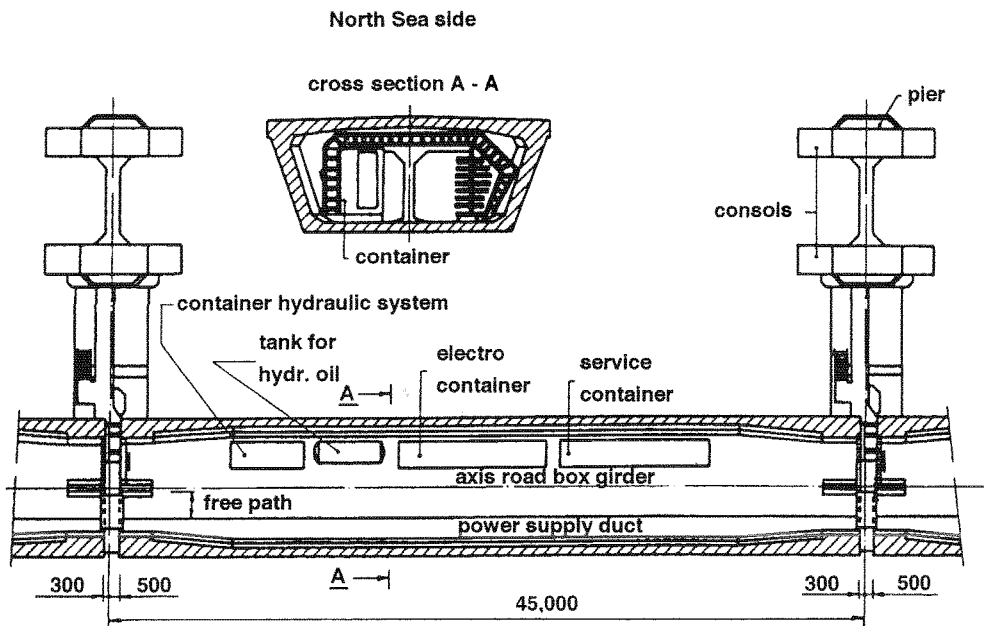

Fig. 38 Allocation of traffic box.

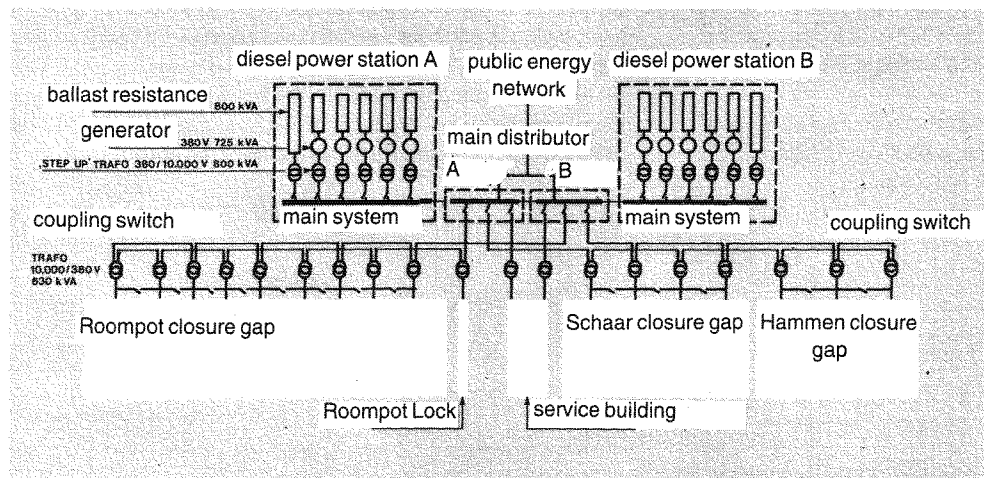

Fig. 39 Outline of the energy generation and distribution.

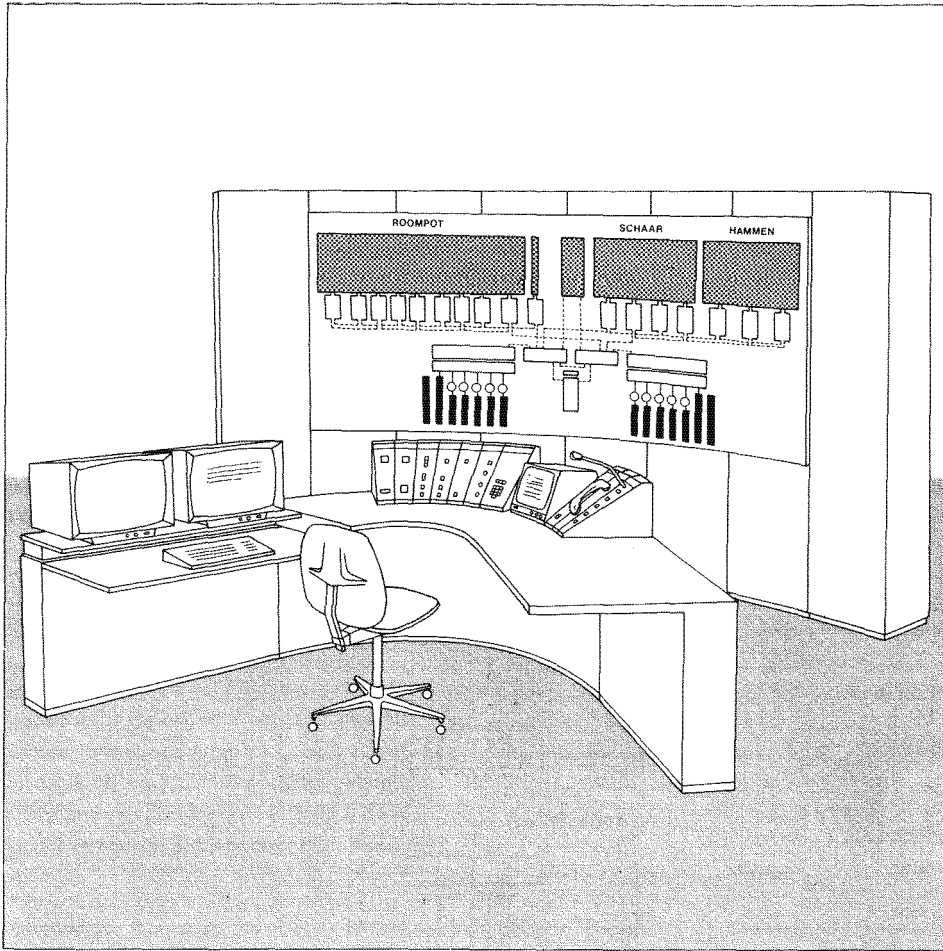

Fig. 40 The central control and signaling panel.

be taken into account. The following solution has been chosen to limit the damage of these strikes. The cylinders have to be the receiving points for the lightning. For this a steel pipe has been constructed on top of these cylinders. By creating the shortest route to earth for the lightning, it is attempted to limit the damage and accidents.

The steel constructions and the reinforcement nets of the concrete constructions were coupled to prevent relay on uncontrollable places. Such couplings had to be constructed between the bracket of the yoke, and to an earth rod welded to the reinforcement steel of the consoles, and also between the fixed point of the tension rods at the bottom of the hammer piece and the reinforcement.

The impedance of the conductor had to be decreased to limit that part of the discharge current which would discharge via the

piston rod. With this, damage of the closed bush can be prevented. In order to reach this situation the reinforcement in the console needed to be fully welded and extra connections had to be constructed between the pier and the console. The better these connections are, the less current will discharge via the tension cables.

With the help of flexed copper cables a low-ohm bypass is brought on from the universal bearings by means of gas filled overvoltage deflectors across the bearing of the lower eye of the piston rod.

A provision is made to the gates which would divert the lightning strike directly to the water.

All electrical equipment which has been placed near the yoke is provided with overvoltage deflectors, just like the electrical mains which enter the traffic boxes from the piers.

3 The solid barrier

3.1 Introduction

The first chapter of this section mentioned the influence of the original design for a solid barrier and the chosen construction methods on the design of the now constructed storm-surge barrier.

Except for the choice of alignment, this is valid in particular for the construction of the closed dam components as far as they were not determined by the transition to the movable barrier. The decision to construct the closed barrier in phases determined the location of the solid dam components in the present barrier. Stronger still, large parts of these dam components had already been constructed when the decision was made to make a movable storm-surge barrier.

Briefly, these phases meant the following:

- To make construction islands and then a section of the dam in the shallow areas of the Oosterschelde, and the construction of dam abutments bordering the closure gaps on the Schouwen- and Noord-Beveland bank;
- To protect the bed in the closure gaps against further erosion;
- With the help of stoney material a gradual blockage of the current in the closure gap. These materials would be supplied by cable ways;
- To further build up the dam body in the closure gaps with sand.

The shape of the first ground works, with regard to the bordering of the closure gaps, is determined by the hydraulic model research, whereby an attempt was made to keep an eye on preventing strong erosion from occurring, and to try and obtain a favourable flow pattern.

Also the transverse section of the barrier, certainly with regard to the stemming height of MSL + 11.50 m and the contour on the sea side, is based on considerations which were made for the design (Fig. 41) of a solid dam through the Oosterschelde (Chapter 1, Doc. 7), which does not alter the fact that these

considerations are still valid for the closed parts of the present barrier.

Only the altitude of the motorway designed across the barrier led to radical changes in the transverse profile. Originally this motorway was designed on a relatively low level on a wide inner berm of the solid dam, and now it is constructed, also on the solid parts of the dam, on a level of MSL + 12 m as a consequence of the altitude of the movable barrier.

3.2 Neeltje Jans island complex

The final shape of this dam compartment is mainly determined by the historical development from the original set-up of a solid barrier to the present design of the storm-surge barrier. There was then no mention of an integral design which led to the present design of the dam compartment, which through the addition of all kinds of secondary works with a permanent character gained more the appearance of an imitation island than of a piece of high barrier.

There are about 6 phases to be distinguished in the development of this island:

- 1 The construction of the work islands Neeltje Jans and Noordland as abutments for the extension of the solid dam across the shallows in the middle of the Oosterschelde and as closure gap borders in respectively the Schaar and the Roompot (Figs 42, 43 and 44).
- 2 Construction of the original dam compartment Geul (Fig. 45) between the construction islands, with a sand closure of the Geul of approx. 10 m deep between the Middelplaat and Noordland.
- 3 The construction of a trench on the former construction island Noordland for the original construction of a deep outlet, later used for the construction of the Roompot Lock (Fig. 46).
- 4 Extension of the Dam compartment Geul with construction

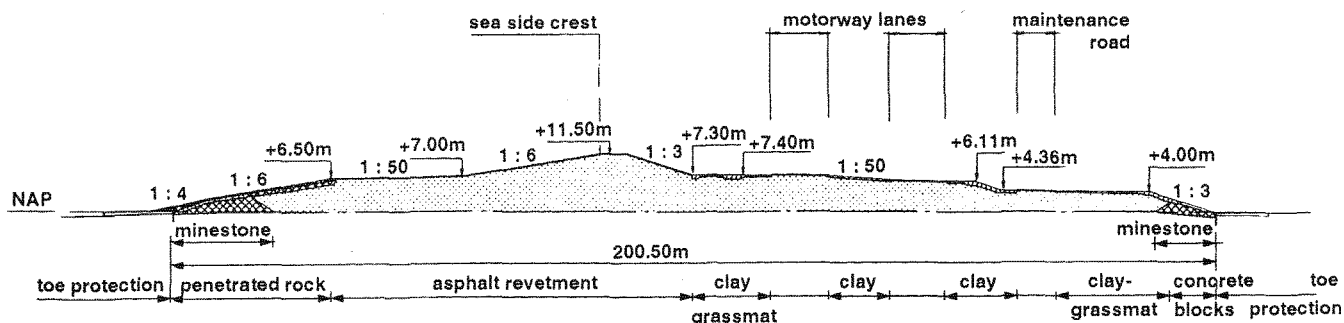

Fig. 41 General transverse section of the Oosterschelde dam according to the original design.

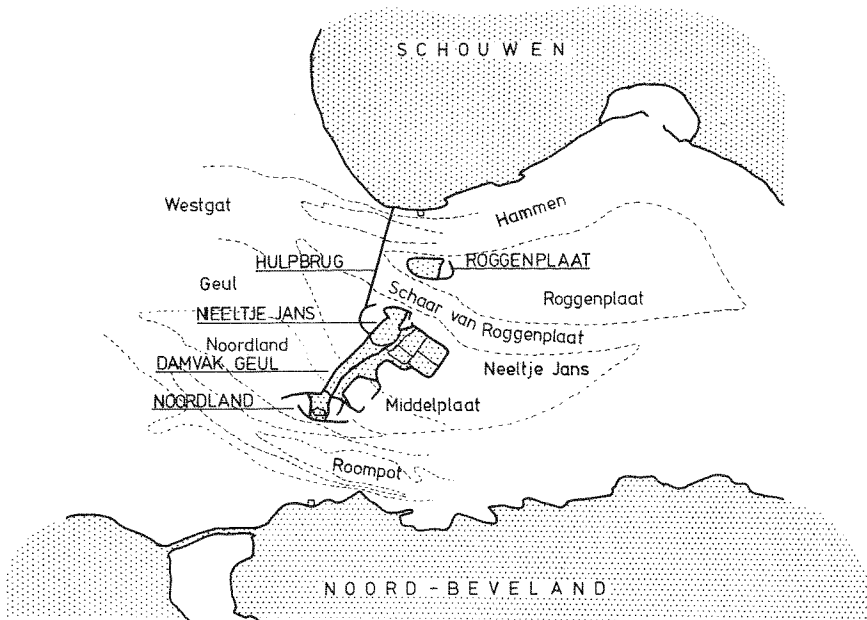

Fig. 42 Situation of the construction islands in the Oosterschelde.

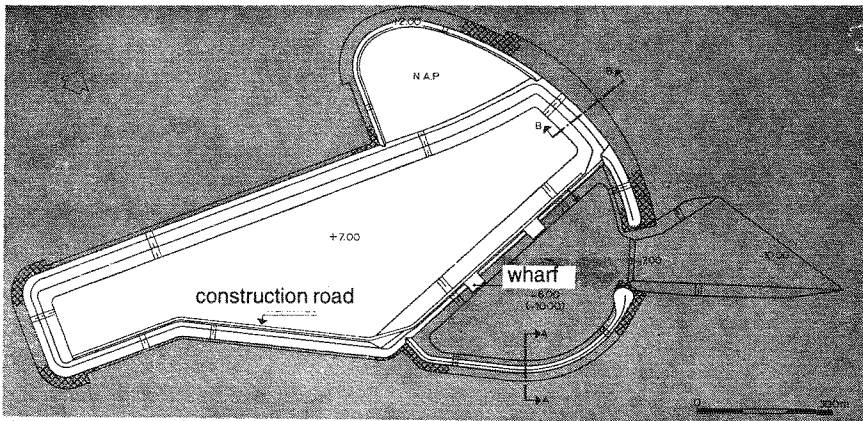

Fig. 43 Construction island 'Neeltje Jans', phase 1.

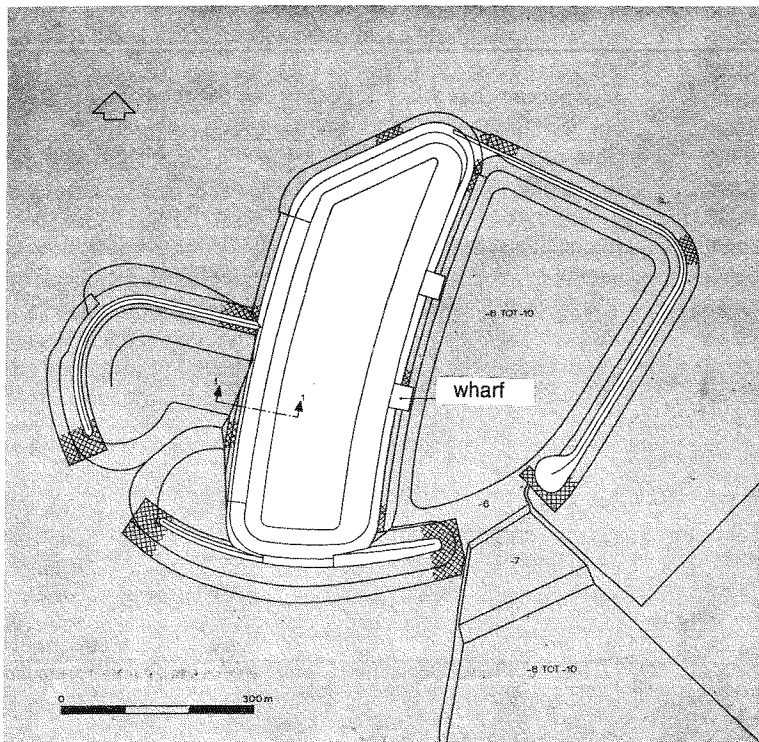

Fig. 44 Construction island 'Noordland', phase 1.

docks for caissons, to be used as culvert means for the storm-surge barrier (Fig. 47).

5 Extension of the island complex with the lock approaches for the Roompot Lock, the outer construction harbour Neeltje Jans and the transformation of the construction docks for the caissons to the construction harbour (Roompot Harbour), and respectively compartmentalized construction dock for the piers and sill beams (Schaar construction pit, Fig. 48).

6 The final form of the island for future use, after completion of the storm-surge barrier.

Part 5, Chapter 2 discusses the final shape (Phase 6) of those sections (construction harbours and sites) which have no relationship with the storm-surge barrier.

With regard to the aspects of the high water barrier, the island can be divided into three main elements (Fig. 49):

- The situation on the former construction island Neeltje Jans;
- The original dam compartment Geul; and
- The situation surrounding the Roompot Lock on the former construction island Noordland.

On the former construction island Neeltje Jans the original high water barrier is formed by the body of the motorway on a level of MSL + 12 m. The plateau surrounding the control building (ir. Tops-House) is partially finished off on a level of MSL + 10 m and partially on a level of MSL + 12 m.

The harbour dams of the outer harbour Neeltje Jans have a permanent breakwater function for the protect of the high water barrier. From this, it was possible to allow the harbour platform lying behind it under a slope of 1:40 to increase to a retaining height of MSL + 9 m at the exit location of the motorway and the entrance to the parking area on a level of MSL + 10 m in front of the control building. A short cut on a lower level in the earth body of the motorway, necessary for transverse traffic, then becomes acceptable.

On the original dam compartment Geul, the main high water barrier is also formed by the earth body of the motorway with a height of MSL + 12 m.

The previously constructed dam compartment with a retaining height of MSL + 11.50 m which deviates increasingly in the alignment in the northern direction, is partially included in this. On the sea side the toe section of this dam is protected with collar sections and further with constructions of penetrated rubble and asphalt concrete, as indicated in the transverse section of Figure 45.

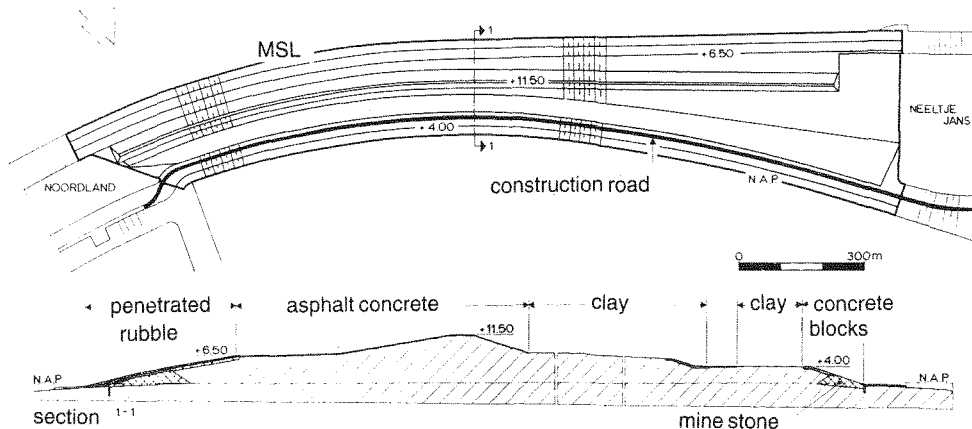

Fig. 45 Dam compartment Geul, phase 2.

In a later stage, at the sea side of this dam compartment a beach is raised whereby dune forming exists and is stimulated. This dune forming, with at the moment a height of more than MSL + 5 m, is considered to be an essential part of the high water barrier, which made:

- A further continuation northwards of the temporarily completed original dam body unnecessary;
- On the other hand, at the height of the Roompot harbour, a short cut in the earth body of the motorway with a retaining height of MSL + 8 m is justified.

This short cut was considered to be desirable for the construction of a transverse connection for pedestrians and cyclists.

The lock platform with the Roompot Lock on the former construction island Noordland, forms essentially a large short cut in the fixed barrier with a retaining height of MSL + 5.80 m. Although from the harbour dams of the outer harbour Noordland a certain protective function emanates, heavy wave overflow will have to be taken into consideration here.

Because of the construction of flow-resistant lining on the lock platform and the slopes of the adjacent earth bodies, this is considered to be acceptable.

3.3 Roggenplaat

This island is also originally designed and constructed in the framework of the total closure of the Oosterschelde. From a chronological point of view this was the first construction island which was constructed in the Oosterschelde. It forms the separation between the closure gaps in the Hammen and the Schaar van Roggenplaat. Figure 42 shows the location.

The shape of the ringdike is established with help of model research to obtain an as favourable as possible flow pattern along the edges of the mentioned closure gaps.

During the determination of the size of the island, it was taken into consideration that inside the ringdike a construction pit could be made for an eventual outlet. This is also the reason why the western part of the island was not filled any further with sand than was necessary for the profile of the ringdike (see Fig. 50). At the east side of the island a construction harbour is situated and a platform of approx. 200 m wide at an altitude of approx. MSL + 4 m to be used as a construction site. In a later phase this platform is widened (+ 300 m westwards) and raised to a level of MSL + 5 m to be used as a base for the ends of the

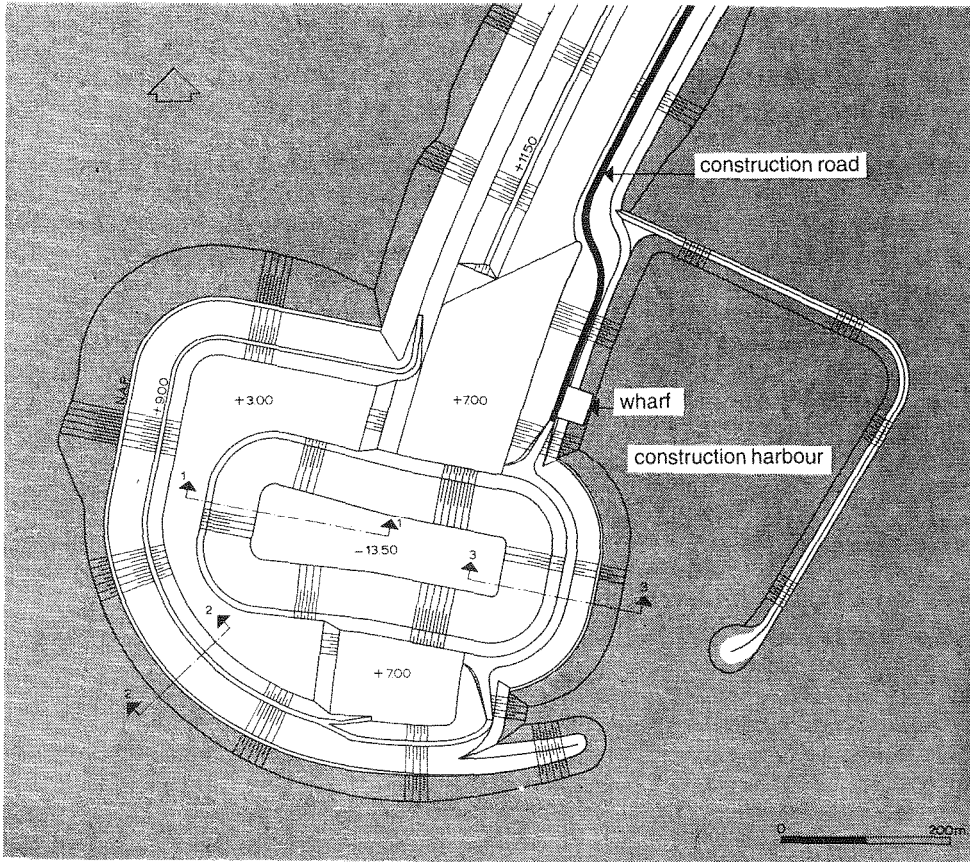

Fig. 46 Construction pit Roompot Lock in the previous construction island Noordland, phase 3.

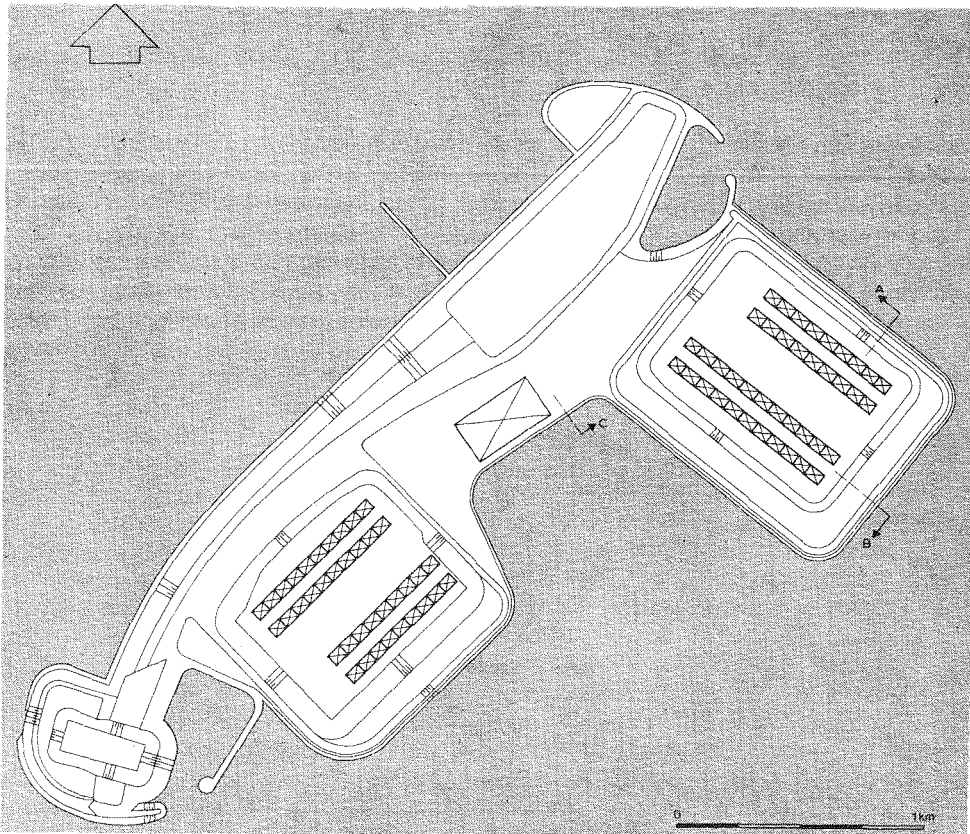

Fig. 47 Location of construction docks and construction sites on the Neeltje Jans island complex, phase 4.

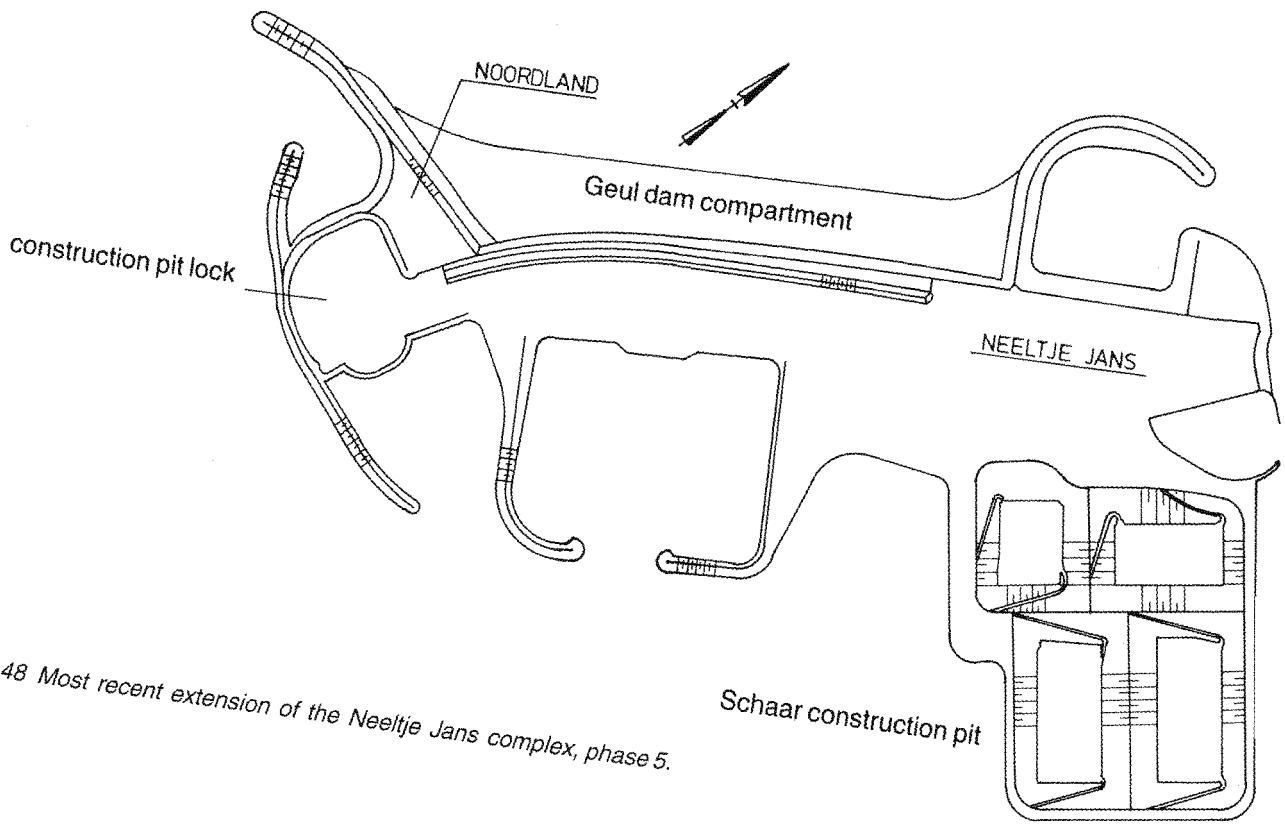

Fig. 48 Most recent extension of the Neeltje Jans complex, phase 5.

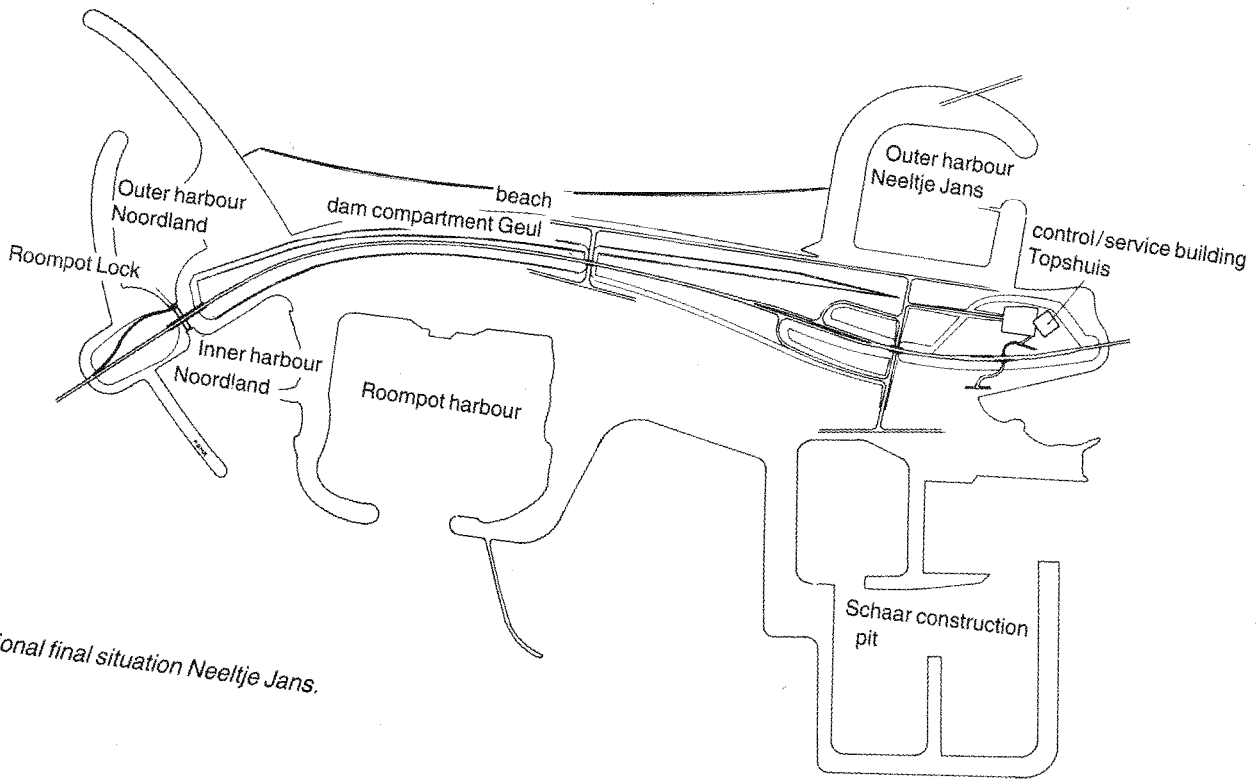

Fig. 49 Provisional final situation Neeltje Jans.

cable ways, which would be used at the closure of the flow channels. The planned outlet was moved to the Noordland island (Section 3.2, Phase 3). Within the framework of the design of the storm-surge barrier, the dam abutments are extended on both sides of the alignment to be able to reach the movable section of the barrier in both flow channels, and a sand dam with a crest height of 12 m + MSL is constructed diagonally across the island to guide the planned motorway on an equal level (Fig. 51).

Together they form the solid part of the barrier. Considering the lower level of the foreland (MSL + 0.50 m) and the limited height of the western ringdike (MSL + 8 m) the western slope of the earth dam across the island is provided with an extra heavy clay lining.

Information about the allocation of the remaining sites can be found in Part 5, Chapter 2).

3.4 Dam abutments and traffic transitions to the movable storm-surge barrier

3.4.1 Dam abutments

Previous Sections of this chapter have mentioned that large parts of the solid high water barrier had already been designed and partially constructed as an in-between phase for the construction of a solid Oosterschelde dam. This is also valid for the connections on the banks of Schouwen and Noord Beveland. The dam abutments designed for this interim phase were kept

limited on both banks with a so smooth as possible finish (Figs 52 and 53). The dimensions of the movable barrier in the three closure gaps, are smaller than the original closure gaps (Fig. 54).

This means that the solid parts of the barrier generally had to be extended inwards in the closure gaps, via the transitional construction in the form of the rubble dam, to make a connection with the movable barrier.

Where the components of the barrier were strategically placed in relation to the deepest parts of the flow channels, is where these components do not lie symmetrically in the original closure gap. The extended dam compartments are therefore different in length, depending on their location. Because of natural shifting southwards of the deepest part of the Schaar van Roggenplaat, even the completion of the former construction island Neeltje Jans had to be extended 100 m further backwards to obtain enough space for the dredged trench, and the applied soil improvement, as well as the extension of the dam abutment.

The dike section, built up of sand, is finished up to the closure gap with a filter construction which has to prevent that the material from the dike body, which is under the influence of cyclical gradients, is rinsed out to the porous rubble dam. For the sake of the traffic roads a land abutment is constructed on the dam abutment, which is mainly based on the previously mentioned filter construction. The space of the rubble dam is then bridged with a freely situated concrete span (Fig. 55). The filter construction mainly consists of a sort of artificial mound made from gravel sand, covered on the side of the rubble dam

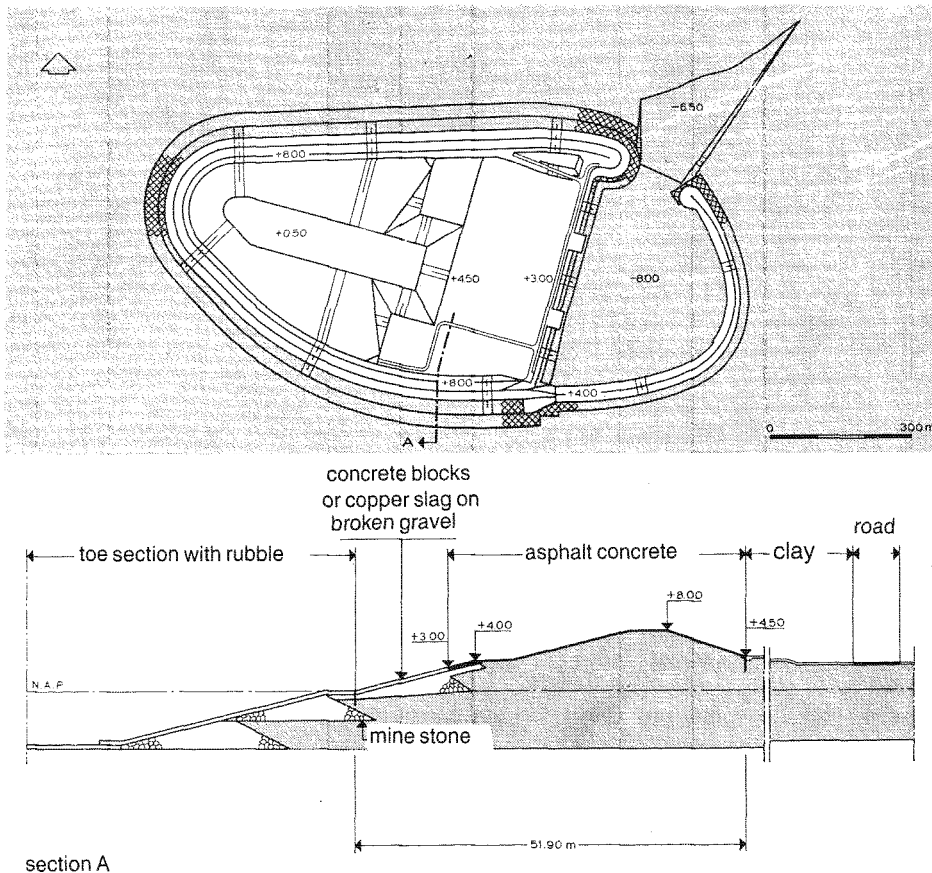

Fig. 50 Construction island Roggenplaat, original design.

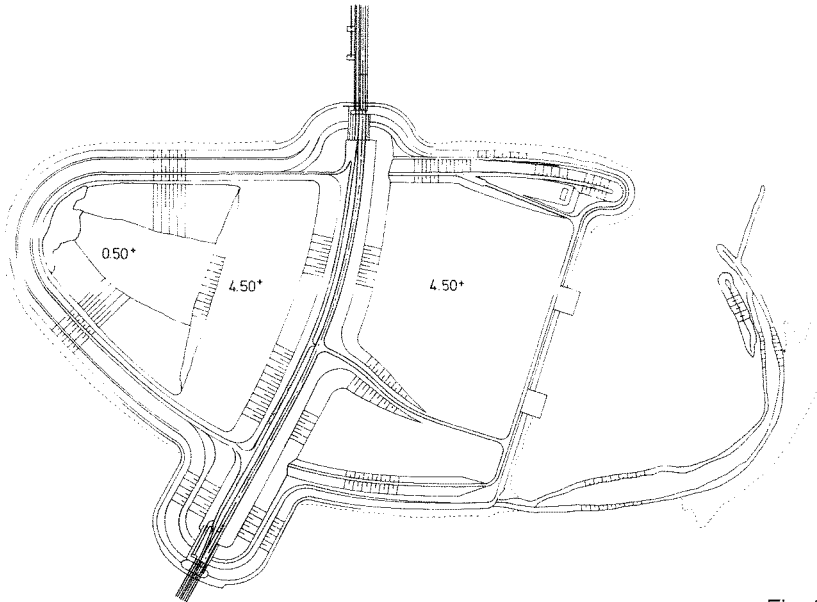

Fig. 51 Construction island Roggenplaat, final situation.

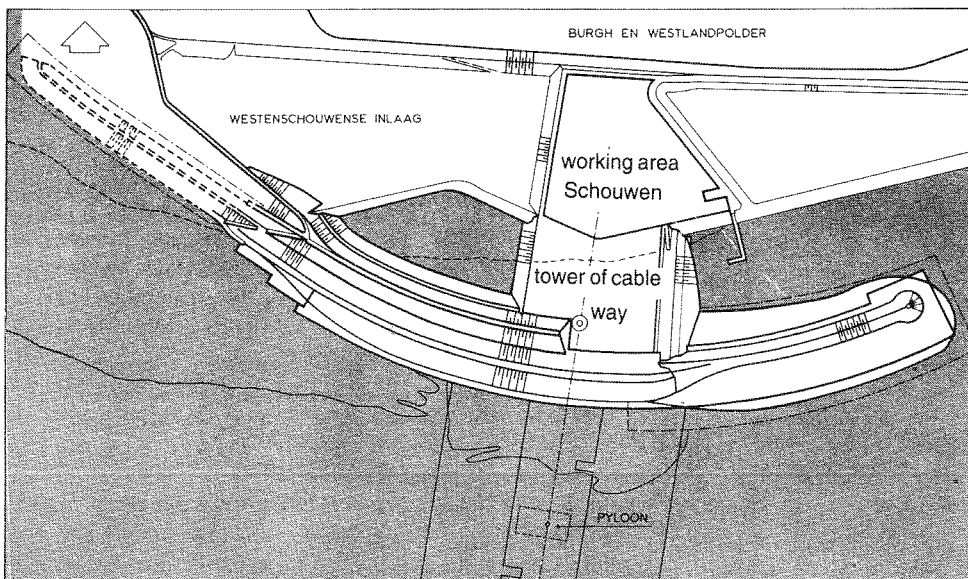

Fig. 52 Dam abutment Schouwen, original design.

with an additional rubble filter in various levels (Figs 56 and 57). Hereupon, the most important section of the land abutment is based, as a result of which relatively strong demands had to be met in order to prevent unequal settlements.

The filter construction is carried out in two variations. In the original design (Fig. 56) one filter layer in the rubble on the gravel sand is described.

In places vulnerable to sedimentation, sand lenses could be locked in during construction which could be washed out later, and which could then cause unacceptable settlements in front of the land abutment.

There was a similar problem at the dam abutment South-Roggenplaat. This design also started with a cut in the bed upon which the filter construction was built. The length of the land abutment traffic box was designed at 68 m.

To guarantee a better stability of the land abutment in relation to the above mentioned problems, the abutment at South-

Roggenplaat was moved 12 m further backwards and the length of the land abutment traffic box was changed to 80 m, similar to the dam abutments designed later according to the revised design.

Problems such as described above were also expected during the future construction of the remaining abutments.

In the revised design (Fig. 57), the problem of sedimentation and the possible future washing out are more adequately dealt with. The characteristics in relation to the original design are:

- The filter construction has a 'sandwich' construction, to reduce the gradient;
- A phased construction of the filter construction from the ground level instead of a cut to reduce sedimentation;
- A land abutment moved 12 m further backwards;
- A land abutment box girder of light concrete and 80 m long.

Table 2 shows a summary of the applications of the different constructions.

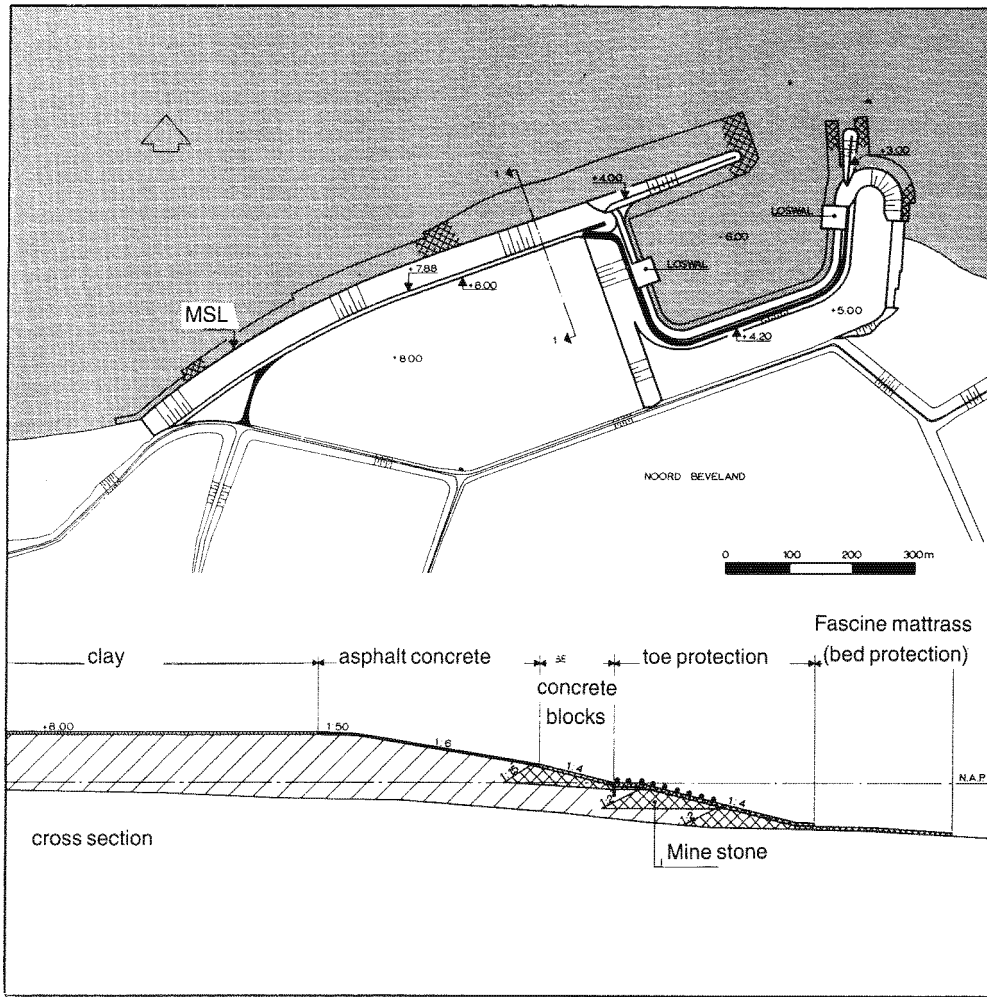

Fig. 53 Dam abutment Noord-Beveland, original design.

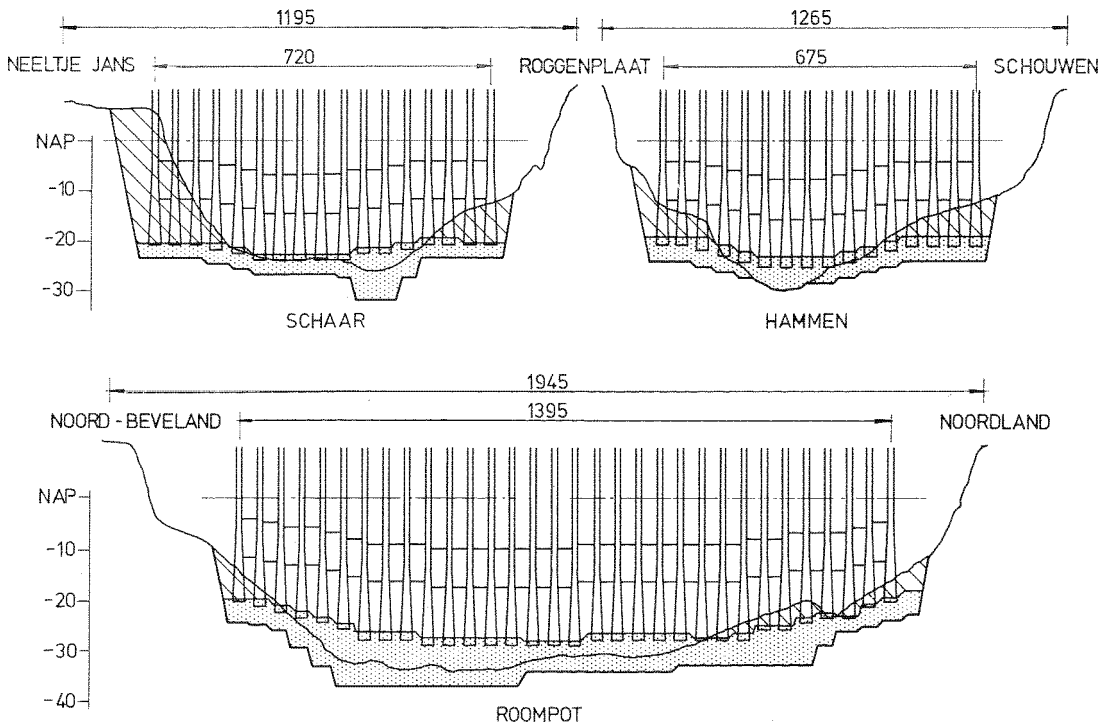

Fig. 54 Location of movable barrier in the closure gaps.

Table 2 Overview of adjusted constructions for dam abutments.

Location	Dam abutments	Length of land abutment (traffic) box girder (mm)
Schouwen	Single filter	68
Roggenplaat North	Sandwich	60
Roggenplaat South	Single filter	80
Neeltje Jans	Sandwich	80
Noordland	Sandwich	80
Noord-Beveland	Sandwich	80

3.4.2 Abutments

The concrete abutment (Fig. 58) consists of a prefabricated substructure and a superstructure, which is poured on the spot. The substructure consists of seven concrete rings with a diameter of 9 m which are located on a level of MSL – 3.5 m on the previously mentioned artificial mound of gravel sand from the filter construction.

The clearance between the rings is also closed with prefabricated elements. The inside of the rings and the remaining hollow spaces are filled with gravel and concrete. On top of this substructure a concrete superstructure, which is poured on the spot, is constructed which includes:

- A bearer for the land abutment box girder;
- A protected exit which gives access to the inside of the land abutment box girders and so to the inside of all box girders on the barrier (see Section 2.6.4);
- Soil- and water retaining walls which guarantee the continuity of the barrier between the dike body and the connecting rubble dam.

The soil retaining wing walls located further backwards, are also poured on the spot and are directly based in the dike body of the dam abutment.

3.4.3 Land abutment box girders

The land abutment box girders have about the same profile as the box girders across the movable barrier, but they have a height of 4.5 m instead of 3.6 m.

The land abutment box girders, in their entirety and without projections, were included in the construction with the help of two floating derricks. The extensions were constructed at a later stage on the building site, after completion of the rubble dam. The land abutment box girders were made of lightweight concrete so as to reduce the nett weight, whereby, with derrick placement, the weight was about 15400 KN and 17500 KN, and the length respectively 68 and 80 m for the box girders. There were 5 girders made of 80 m and 1 of 68 m (Table 2).

3.5 Rubble dams

The rubble dam is the actual transition between the solid part and the movable part of the barrier. Contrary to the remaining components of the solid barrier, the rubble dam is designed as an open permeable construction, with functions such as:

- To break the force of the tidal flow; and
- To break the force of the waves.

The design of the dam is based on the gradient of the flows

present in the dam body, the wave impact on the outside and the soil mechanical qualities of the rubble used. Also, consideration is given to the possibility of mussel growth and the influence thereof on the gradient.

The dam body is also constructed according to the filter principle, with light stone in the core and heavy stone on the outside.

Where necessary, transition layers are connected with the filter constructions of the foundation bed and the dam abutment. With regard to the foundation bed, these transition layers were also used to protect the mats against falling rubble during construction. The core of the dam, up to a level of MSL – 6 m, is built up of rubble 10-60 kg or 60-300 kg and on top of that rubble of 60-300 kg or 300-1000 kg, depending on the present flow velocities during the construction phase of the core.

The outer layer of the dam is constructed of different sorts of heavy rubble. Just like the sill, the stone sorts used are granite and basalt with a specific gravity of 2.8 to 3.0, whereby in the outer layers and in the top only basalt with a specific gravity of 3.0 was used. The transverse section and the sorting of the heavy rubble on the outer skin of the dam is optimised separately for the various locations. Figure 59 shows an overview of this.

On the sea side, the slopes are established at 1:1.5 and on the Oosterschelde side at 1:2 or 1:2.2. The crest height varies with the location between MSL + 6.8 to + 7.4 m with a width of approx. 5 m.

On the side of the aperture of the movable barrier, the rubble dam is closed in by the edge pier and the stone retaining framework pieces placed thereon (see Section 2.5).

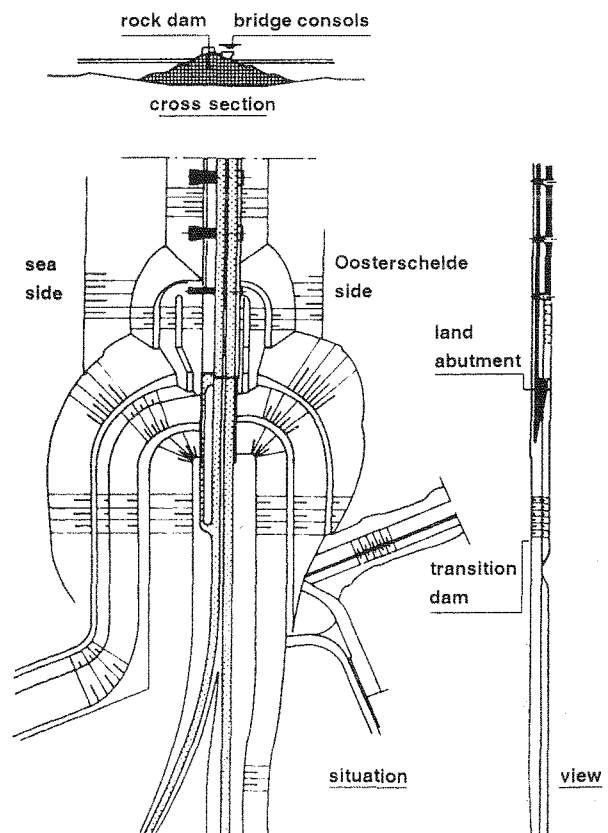

Fig. 55 Dam abutment and land abutment (Noord-Beveland).

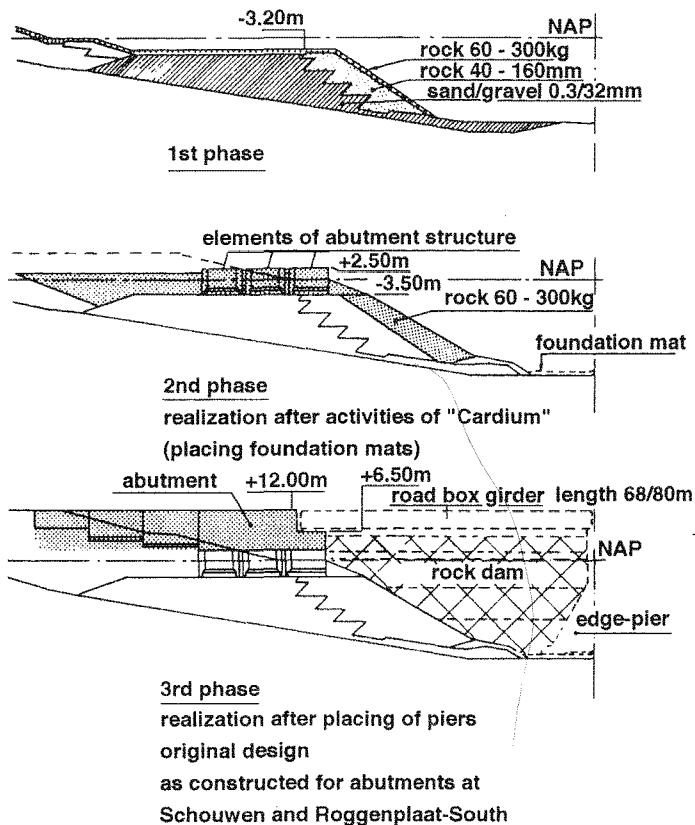

Fig. 56 Dam abutment, construction in phases (original).

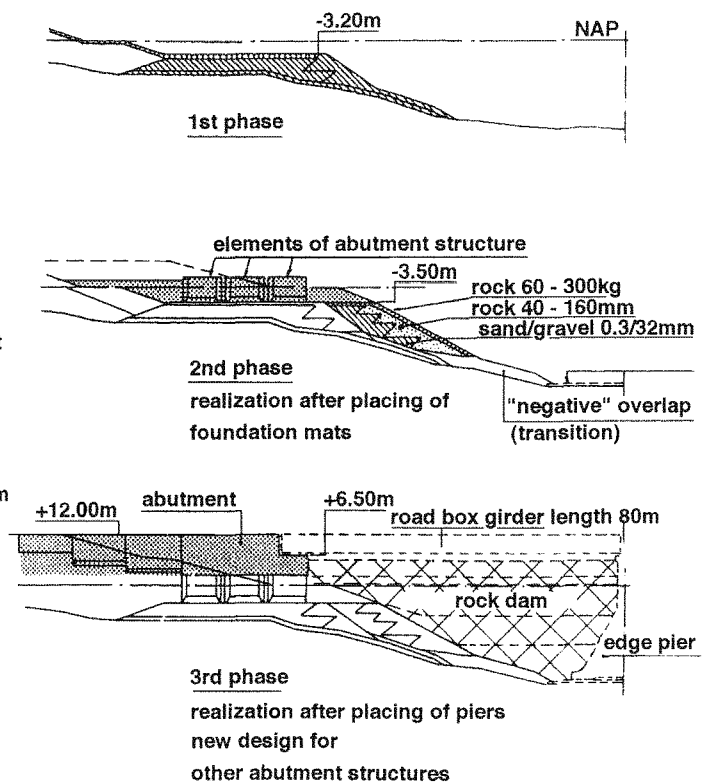

Fig. 57 Dam abutment construction in phases (present) (translation see Fig. 56).

3.6 Roompot Lock

Through the realization of the storm-surge barrier the direct navigational connection between the sea and the Oosterschelde is broken. Without further provisions, the seaward side of the Oosterschelde can only be reached via a significant detour across the Westerschelde or across the Volkerak and Haringvliet. There is a need for a more direct connection for:

- The exchange of construction material in the final phase of the construction and for maintenance of the storm-surge barrier;
- Fishing navigation;
- Recreational navigation;
- Small merchant navigation.

This need is met by including a lock in the design of the storm surge barrier, which is located in the northern bank of the Roompot, in the former construction island Noordland.

The dimensions of the lock chamber ($100 \times 16 \text{ m}^2$ with a sill depth of $\text{MSL} - 5.70 \text{ m}$) is mainly adjusted to the needs of the regularly used contractors equipment. In the rare case that wider equipment has to be transported, use could be made of the Volkerak (24 m) or of the Channel through Walcheren (20 m). The capstone height of the lock is fixed at $\text{MSL} + 5.80 \text{ m}$ (see Section 3.2). Where the closing devices of the lock have to be two-sided, and there is a need for a ground level connection for traffic across the lock, rolling doors have been chosen, which have been designed in such a way so as to allow trucks to drive across. The traffic load on the rolling doors is an adjusted class 60 according to VOSB 1963.

The lock is operated from a separate building with separate

foundations on the southern side of the outer head. This operational building accommodates the Inspection Import and Excise Duties department.

The lock is constructed in a construction pit which was previously built for the construction of a deep level outlet, designed in the framework of the plan for a total closure of the Oosterschelde (see Section 3.2 and Fig. 46). Because of the small construction depth of the then realized lock, a soil supplement (-improvement) had to be constructed first to the required height, whereon the lock is further founded on foundation bed.

The outer and inner Noordland harbours form the entrance to the Roompot Lock (Fig. 60).

Because of its western position, the wave penetration from the sea is an important aspect in the design of the outer harbour. In particular at the back of this harbour, at the entrance of the lock and at a planned loading- and unloading jetty for stone, necessary in the final phases of construction of the barrier, a calm position for the ships had to be guaranteed.

The outer harbour Noordland consists of two compartments, an outer harbour and an inner harbour.

The inner harbour is mainly intended for moorings while the main function of the outer harbour is to break the penetrating waves. The spacious dimensions of the already present construction pit were also decisive for the design of the plan. For instance the separation dam between the outer and inner harbour is a part of the ringdike and the inner harbour is strictly speaking, a remainder of the construction pit (see Fig. 46).

The design of the inner Noordland harbour is determined significantly by previously constructed works, such as the

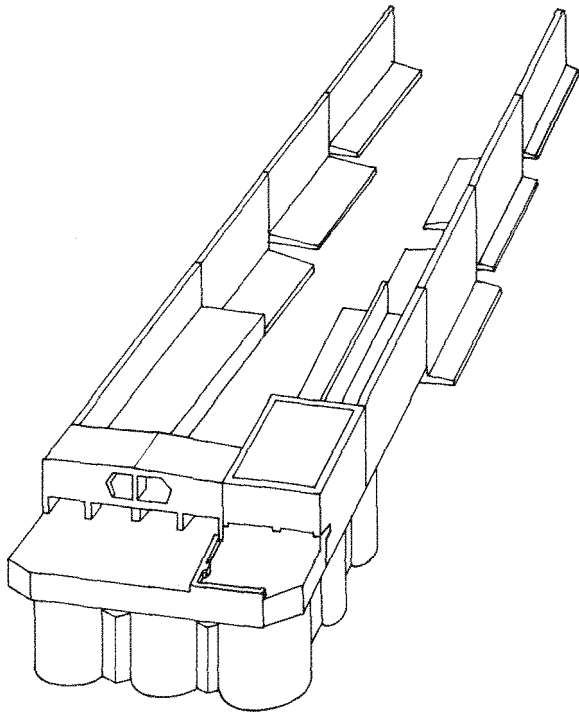

Fig. 58 The concrete abutment.

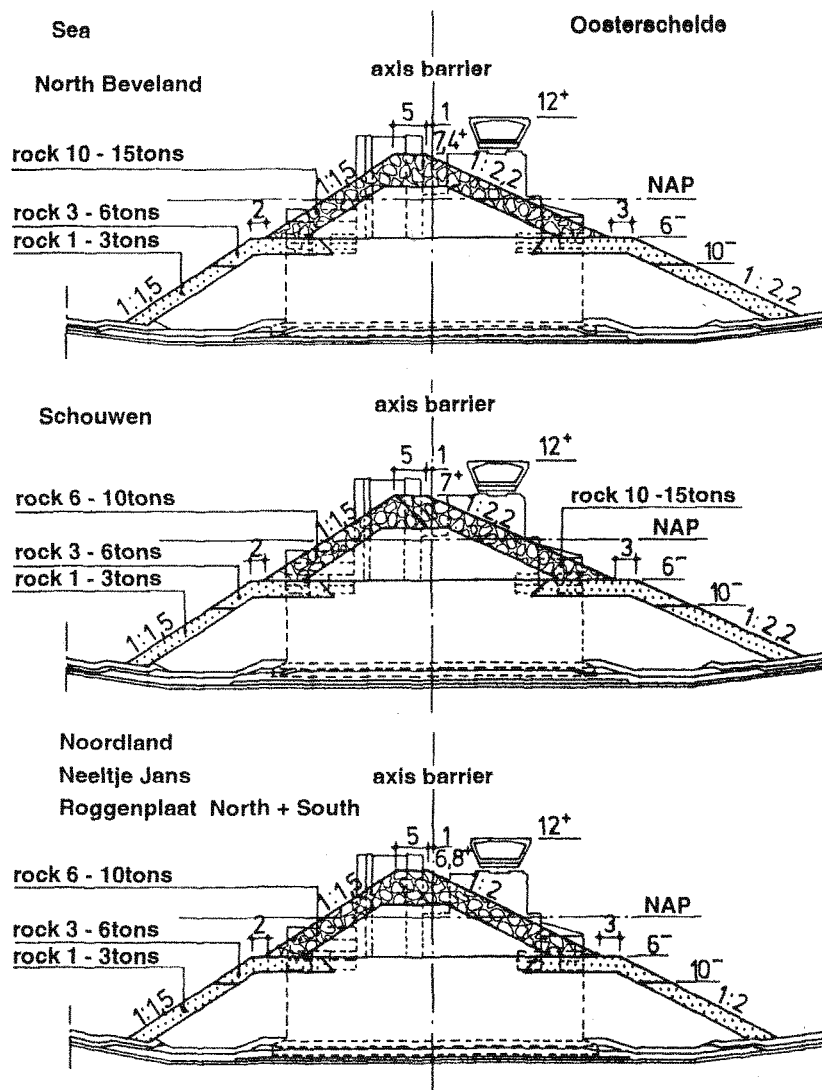

Fig. 59 Overview of designs for the rubble dam.

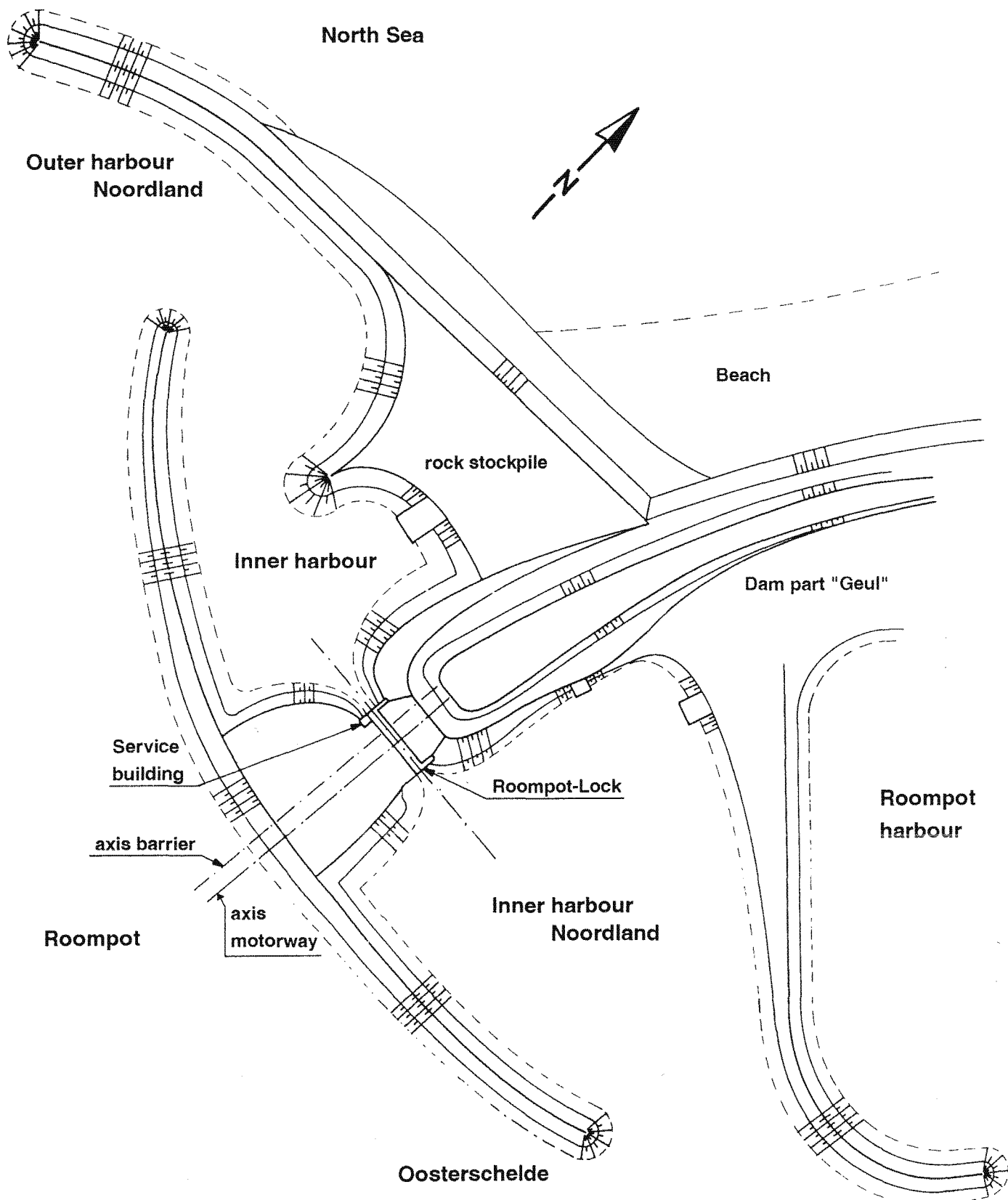

Fig. 60 Harbours Noordland.

originally constructed work harbour and the southern dam of the already constructed Roompot harbour. The original harbour entrance, situated close to the dam abutment and bearing southwards, was moved more eastwards and also with a more

easterly bearing. As a result of this, the harbour entrance is less influenced by the strong current through the open movable barrier and makes navigation to the mouth of the lock easier.

4 Secondary works

4.1 Control building

For a brief description of the central operations building, the 'ir. J.W. Topshuis (Tops-House)', the architect is quoted below (see Fig. 61).

Programme

For the operation and maintenance of the storm-surge barrier, the building has a control room, work places and warehouses for the mechanical engineering and civil-technical services. The power necessary to close the gates is generated in two diesel chambers by ten diesel aggregates in total. These technical and maintenance rooms take up approx. 5.800 m² of the building.

Offices and canteen spaces take up approx. 1.000 m² and for exhibition rooms regarding information on the Delta works there is approx. 2.000 m² available.

Location

The building is located at the sea side of the former construction island Neeltje Jans and so has a direct relationship with the gate complex and the water. This pronounced position makes the tension between safety and the dynamics of the sea tangible.

From the through road on the dam compartment at MSL + 12 m one can reach the carpark at MSL + 10 m via the lower situated outside terrain; from this position the building can be seen as a diagonal axis where both the office entrance and the visitors entrance can be seen.

Essence of the building

The building is robust and sober, a compact and introverted form partially hidden in the site.

The internal allocation is such that both to personnel and visitors the relationship between management and operations, and the one to which these activities apply, 'the storm-surge barrier' is exposed in an intensive way. Through the service section of the building the visitor rises to a level from which he can view both the natural and technical environment.

Description

The building itself is high, surrounded by lower buildings in which the working places, washing facilities and the diesel chambers are situated. These rooms are pointed towards the central inside hall, which is created by constructing the high building on columns and it receives daylight through a glass strip between the high and lower buildings. This gives the building its introverted character.

The first floor of the high building consists of the offices of the circuit services and the operational room of the storm-surge barrier, including the accompanying computer department. On the second and third floor the exhibition of all Delta works will be held. Access to the exhibition is via a bridge in the central hall, separated from the rest of the building. The two floors are connected by an open central staircase and a void. From the corner windows on the floors the complete Oosterschelde environment can be seen. By making the roof accessible to visitors an extra dimension is added to the experience.

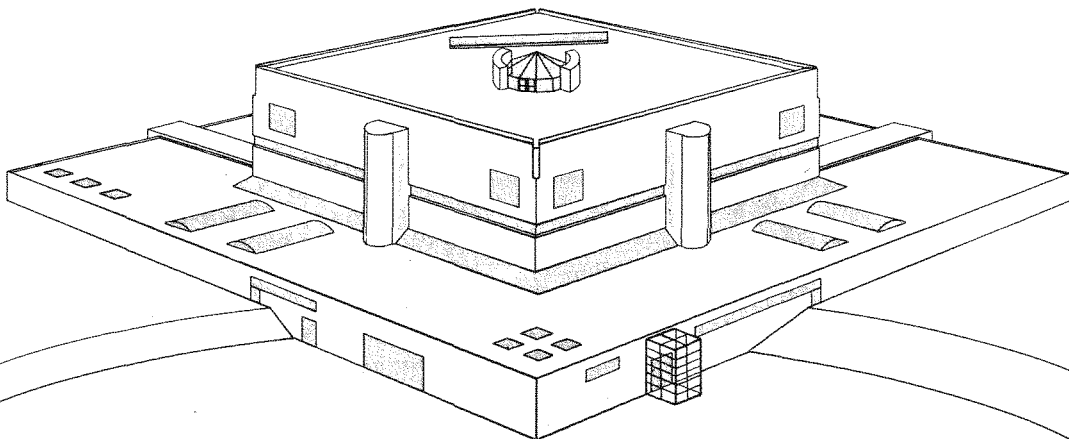

Fig. 61 Central operations building.

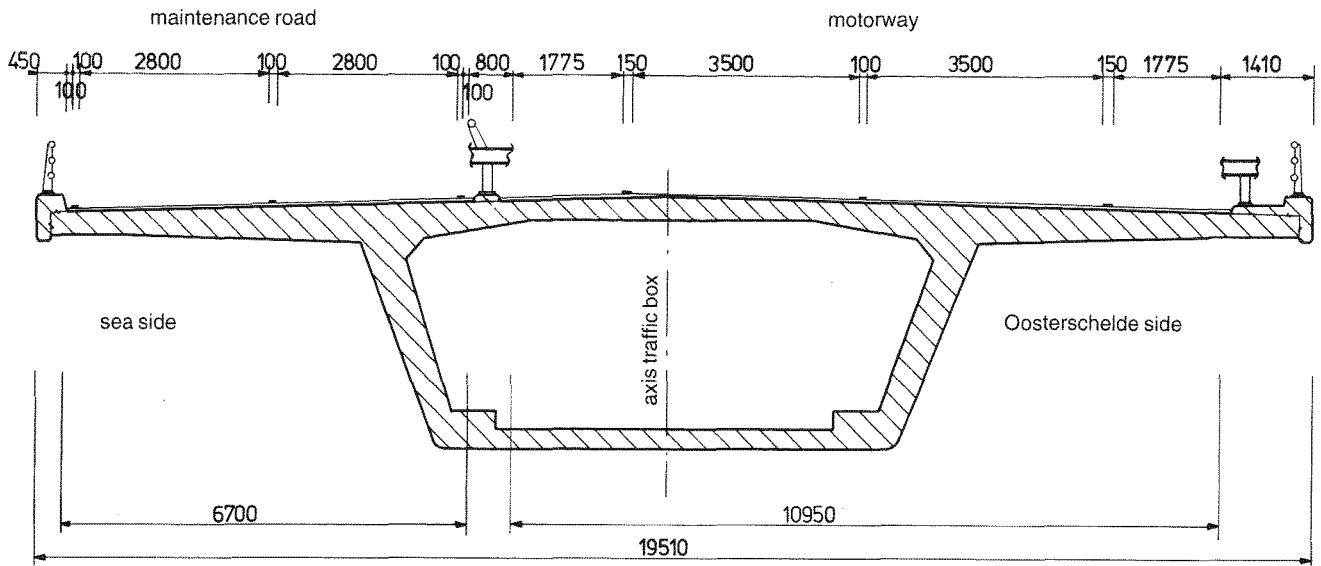

Fig. 62 Transverse section of roads on the movable barrier.

The core is in the centre of the building, in which the conduit shafts, stairs and a lift are situated. Lift shaft and stair case are surrounded by glass fronts and are covered above the roof by a large glass cover.

The stairs are designed in such a way that personnel and visitors are separated, but looking through the glass front one gets an impression of all the activities which take place in the building. The building explains itself to the visitor.

Construction and materials

The building is constructed as a concrete skeleton and has its foundations in sand fillings. The building has concrete fronts, partially poured, partially prefabricated. The outside window frames are of iroquo which will turn grey under influence of the weather.

Concrete and wood are the two materials which give the building its robust character.

Inside the building, the main materials are: concrete, white concrete stone, and wooden and steel inside fronts. The fronts of the central staircase are made of steel profiles and connect to the steel profiles of the glass cover. By applying mainly light colours in combination with the glass covers and front openings the building has, in spite of its introverted character, a light interior.

4.2 Through traffic- and construction road

The traffic road across the storm-surge barrier will be part of the R.W. 57 (dam roads), the most western North-South connection over the South Dutch and Zeeuwse islands. In this framework, the most significant function of the dam road is to form a connection between Schouwen on the one hand and Noord-Beveland and Walcheren on the other. In addition to this it also has the function of access road to the Neeltje Jans island complex on which activities are planned which will attract traffic (see Part 5, Chapter 2).

Because the through character of the road connection is dominant, the design was determined by the construction of a fully-fledged motorway with a design speed limit of 100 km/

hour. Slow traffic is not allowed on these roads, neither are crossings on the same level with slow traffic. This means that slow traffic and construction traffic for maintenance of the movable barrier need a separate road.

Because the barrier is on the seaward side of the road connection, this construction road, in relation to the motor way, has to be on the seaward side. The construction road does not go through the Neeltje Jans island complex but joins the local road network.

Figure 62 shows the transverse section of the roads across the barrier. The section of the motorway is also decisive for the transverse section of the remaining future constructions in the motorway.

Except for the fixed bridging of the Roompot Lock, the motorway will be on a level everywhere of MSL + 12 m.

A future extension of the motorway, by adding an extra lane on the Oosterschelde side, is taken into consideration (see Section 2.5 and Fig. 17).

The motorway will be joined at Schouwen on the already existing section of R.W. 57 and at Noord-Beveland it will join the existing provincial East-West connection (S8).

However, these connections fall outside the framework of this design plan, just like an eventual provisional connection at the secondary road network on these islands.

This design plan is limited to the section which coincides with the storm-surge barrier:

- Dam abutment Schouwen
The construction road joins the existing road, this is the same for the motorway as long as the connection to the existing part of the R.W. 57 is not realized (Fig. 63).
- Roggenplaat
This island will not have a destination which would attract large amounts of traffic.
The island is made accessible via the construction road with a crossing on the same level as the motorway (Fig. 64).
A normal connection to the motorway with left turn lanes is thought to be undesirable for traffic safety.
- Neeltje Jans island complex
Close to the Neeltje Jans dam abutment, the construction road joins the existing road network of the Neeltje Jans

island complex.

The motorway goes further through alone. At the outer harbour Neeltje Jans, just passed the Topshouse, and making use of the available height differences, an East-West connection in the local road network is crossed with a viaduct. Further down, the local road network on the Dam compartment Geul is opened up to traffic from the motorway with exits on both sides. At this intersection, the motorway is split into two lanes which makes it impossible for traffic to turn left (Fig. 65).

At the level of the car park in front of the Topshouse, a small tunnel is constructed under the motorway for the crossing of pedestrians and cyclists. There are bus stops along the motorway for a future bus service across the storm-surge barrier.

Halfway through the original Dam compartment Geul a tunnel has been constructed to make a transverse connection for pedestrians and cyclists between the beach activities on the seaward side and the activities on the Oosterschelde side at the Roompot harbour.

The Roompot Lock is crossed with a high fixed bridge through the motorway. The required free headroom is MSL + 20 m, whereby the motorway there will be on a level of approx. MSL + 21.50 m.

The earthen path section between the bridge across the

Roompot Lock and the Noordland land abutment on the bank of the Roompot is too short to reach the required height with an acceptable slope, and an acceptable curvature radius in the longitudinal profile of the motorway.

Therefore the southern approach to the bridge is already set up at the three northern box girders of the movable barrier.

As already mentioned in Section 3.6 of this section, the construction roads on the Neeltje Jans island cross the Roompot Lock at ground level via the rolling doors made of the lock. At the Noordland dam abutment there is again an access to the construction road across the movable barrier in the Roompot (Fig. 66).

– Dam abutment Noord-Beveland

The motorway is directly connected with the existing S8.

The construction road is joined here directly with the polder road network (Fig. 67).

4.3 Harbours, depots and construction sites

For a civil-technical work the size of the storm-surge barrier, an infrastructure was needed to deal with the large amount of people, equipment and materials. An infrastructure which did not exist on the islands around the Oosterschelde. What was needed was:

- Harbours for storage and transport of the millions of tons of materials needed, which had to come from elsewhere: stone, slag, gravel;
- Sheltered moorings for floating material when it was not being used;
- Possibilities for the transport of personnel;
- Construction sites for the large concrete elements;
- Space for the factories which would construct the mats for the bed protection and the foundation bed;
- Construction sites for the construction of all kinds of secondary works.

The provisions made for the construction of the solid Oosterschelde dam could be partially used, such as:

- The construction harbours near Schelphoek and Burghsluis in Schouwen;
- The construction harbours in the former Sophia polder and near the dam abutment on Noord Beveland;
- The construction harbours near the already built construction islands Roggenplaat, Neeltje Jans and Noordland.

The capacity of the infrastructure present was however insufficient to meet these needs. After studying various alternatives, the decision was made to concentrate the rest of the necessary provisions as much as possible on the complex Neeltje Jans Dam compartment Geul Noordland, because here the transport distance to the construction locations were the shortest. The most important element in this choice was the construction site for the piers and sill beams. In fact, the choice had been made at an earlier stage; when there was still talk of using the caissons as an apertures for the movable barrier.

The Schaar construction pit and the present Roompot harbour were originally constructed as construction docks for these caissons (see Section 3.2 and Fig. 47).

Because of this decision, the Neeltje Jans complex was significantly extended with harbours and sites for wet and dry storage of materials (see Fig. 68).

The construction pit Schaar, divided into four compartments, was used for the construction of the piers and the sill beams, for which also a concrete power station was constructed.

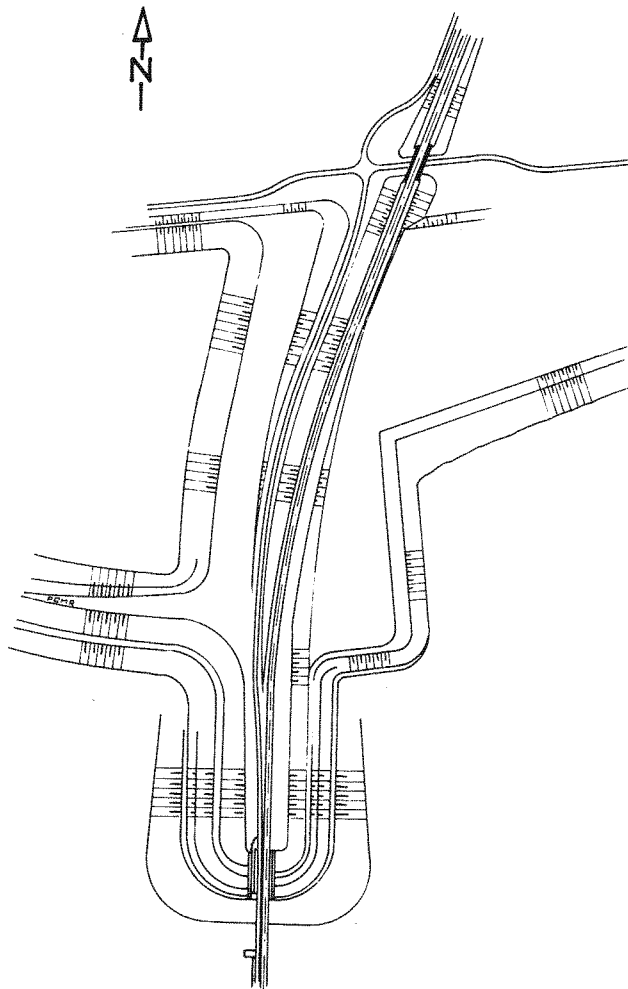

Fig. 63 Road connection Schouwen dam abutment.

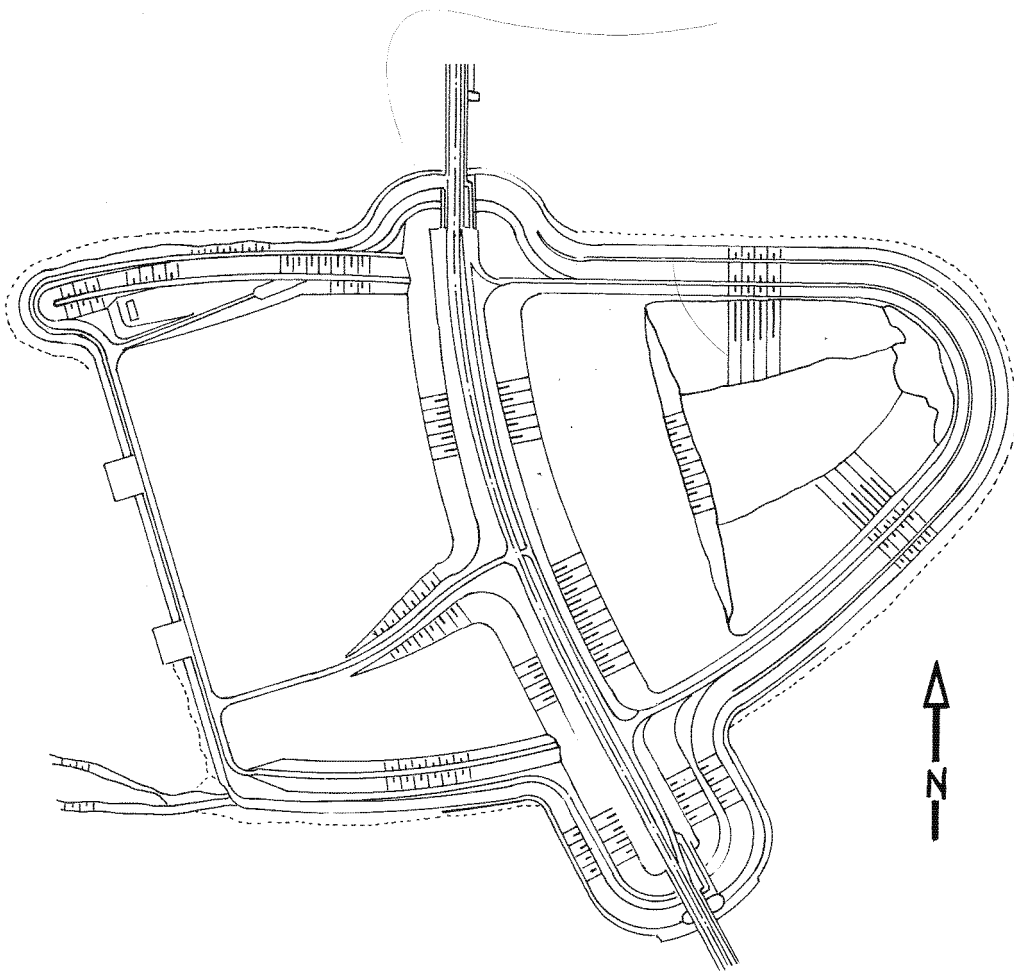

Fig. 64 Connection Roggenplaat island.

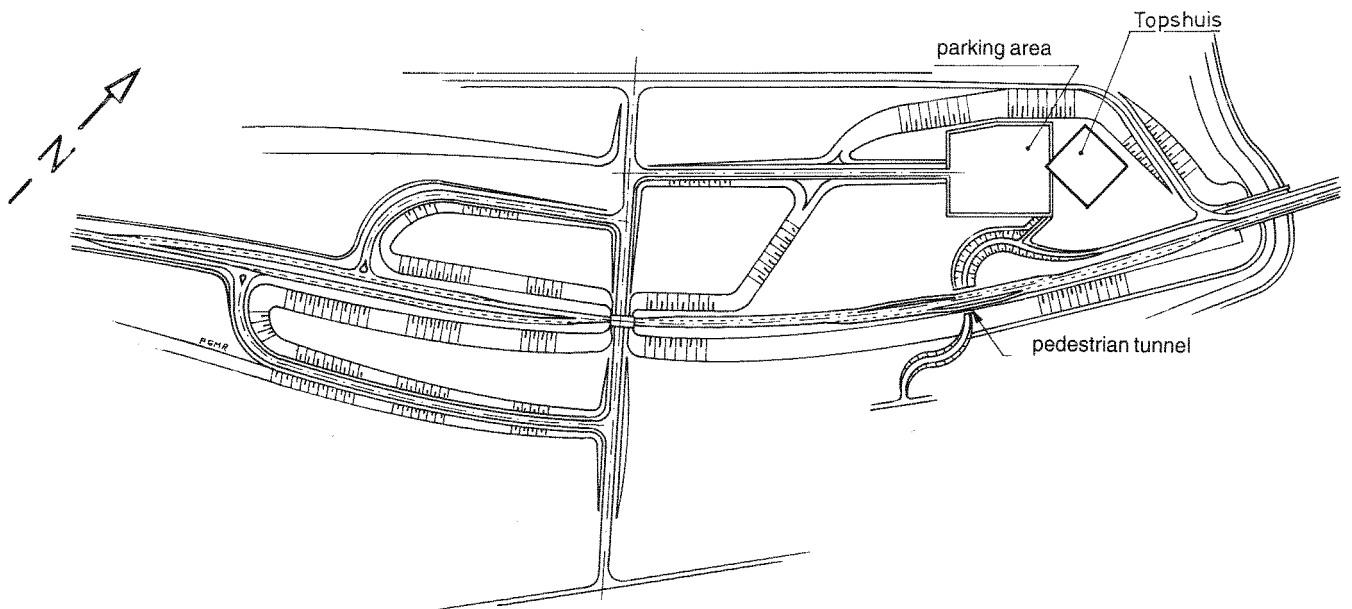

Fig. 65 Connection Neeltje Jans Dam compartment Geul.

The Roompot harbour was used for establishing the foundation mats factory and a roll-on roll-off jetty for the unloading and loading of the heavy rubble, partially imported from abroad. Both contractor and management had offices on the island for their personnel.

The entire complex was supplied with electricity by its own power station, from which a section of the diesel generators, after revision, were later put into the definitive power station in the control building.

During peak construction, about 1000 personnel of both contractor and management worked on the island in shifts. For the transport of personnel and for road and rail transport of goods, a temporary bridge with a length of 2780 m was built from the harbour dam of the outer harbour Neeltje Jans to a point west of the dam abutment Schouwen, which could carry class 30 vehicles according to VOSB 1963 (Fig. 69).

The following existing provisions ashore were used:

- The harbour platform of Burghsluis, as main establishment for the construction bureau of both management and contractor;
- The construction harbour Schelphoek, as moorings for construction ships which were not in use, and as construction site and storage site for both wet and dry materials;
- The construction harbour Sophia polder, as established site for the block mat factory, where the flagstone mats were also manufactured;
- An existing construction site for heavy elements near Kats, originally made for the benefit of the construction of the Oosterschelde bridge, for manufacturing the remaining concrete elements for the barrier.

4.4 Support systems and tools

4.4.1 Introduction

With the present design, a big step was taken in the construction of hydraulic structures in the tidal zone close to the sea. Important elements in this were:

- The mechanical compaction under water, covering a layer thickness of 15 m, of sand layers or soil improvements at great depth;
- The foundation of extremely large concrete elements (piers) on a sandy subsoil in an area exposed to strong tidal flows, combined with high demands regarding precision positioning and stability (shifting, rotations) under the influence of acting loads during the lifespan of the construction;
- The execution of a large surface area (approx. 4.5 km²) of bed protection at great depth (15-30 m) during strong tidal flows, with high demands on flow resistancy, sand density, and at the place of the structural works (foundation bed) to quality and precision of measurement according to the design requirements of these structural elements;
- The manufacturing of structural works, in combination with loosely dumped materials, with large prefabricated elements using, in principle, the method of 'loose piling' construction.

The big advantage of this design was the fact that during construction on the building site those activities which were vulnerable to bad hydrodynamical (flow and waves) and meteorological conditions, could be limited to a large number of quick activities of short duration (maximum of a few hours). The already constructed work had a good resistance against these bad conditions. This could significantly limit the accident

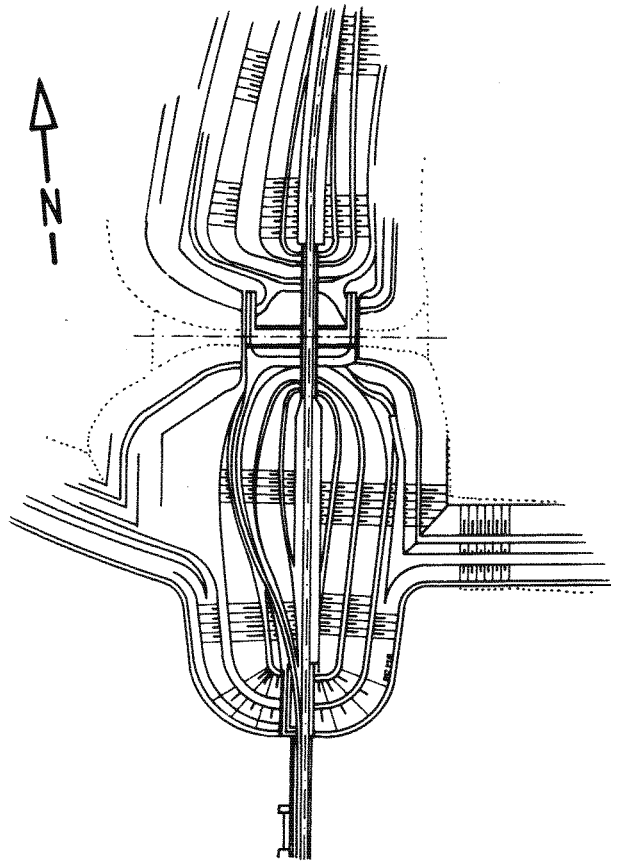

Fig. 66 Roads surrounding the Roompot Lock.

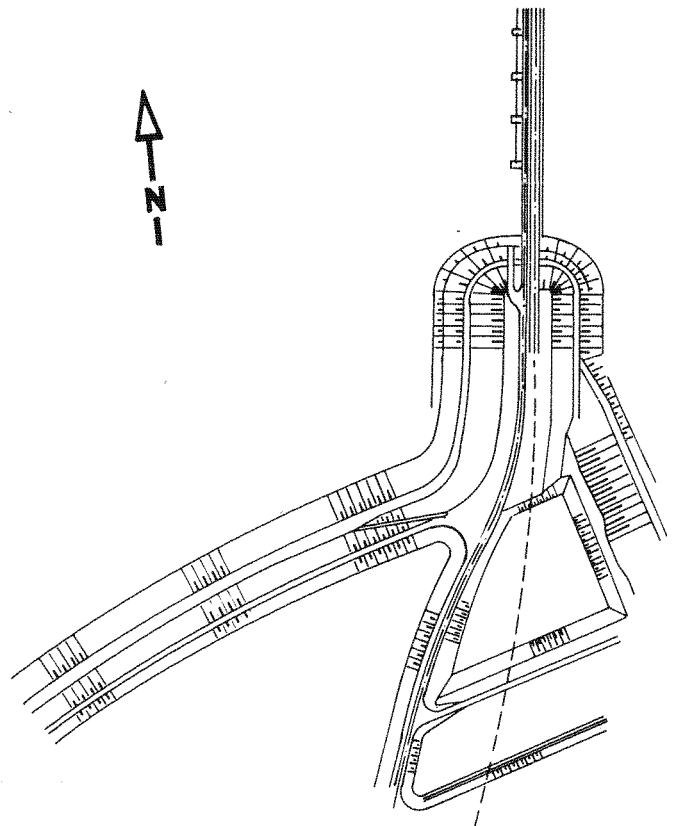

Fig. 67 Road connection Dam abutment Noord-Beveland.

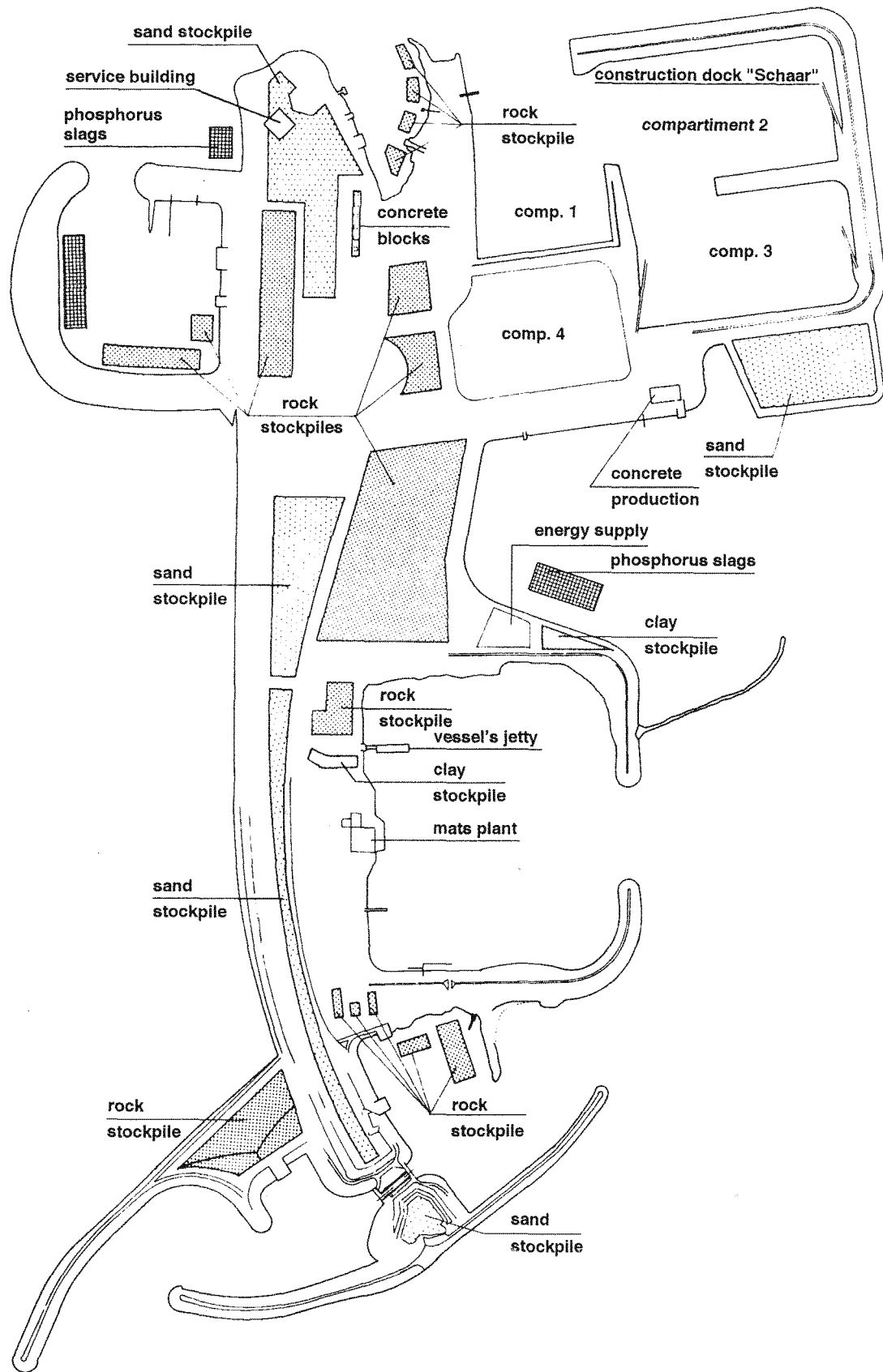

Fig. 68 Allocation Neeltje Jans construction island.

risk with personnel and equipment. The availability of a system that could predict these so called hydrometeo-circumstances with reasonable precision was necessary and at a reasonable period beforehand. The high quality requirements, in particular relating to the work carried out deep under the water level, made it necessary that this work had to be controlled and if necessary improved.

The above-mentioned elements were largely new to hydraulic engineering, which meant that the support means necessary for construction often had to be especially designed and constructed.

Book 5 of this design plan explains the details of the design and the construction of these support means. A brief description is set out below.

The support means can be sub-divided into three groups:

- The support systems for the operational execution of the work;
- Equipment for the performance of various operational activities, and;
- Support means for the inspection of the constructions manufactured deep under water.

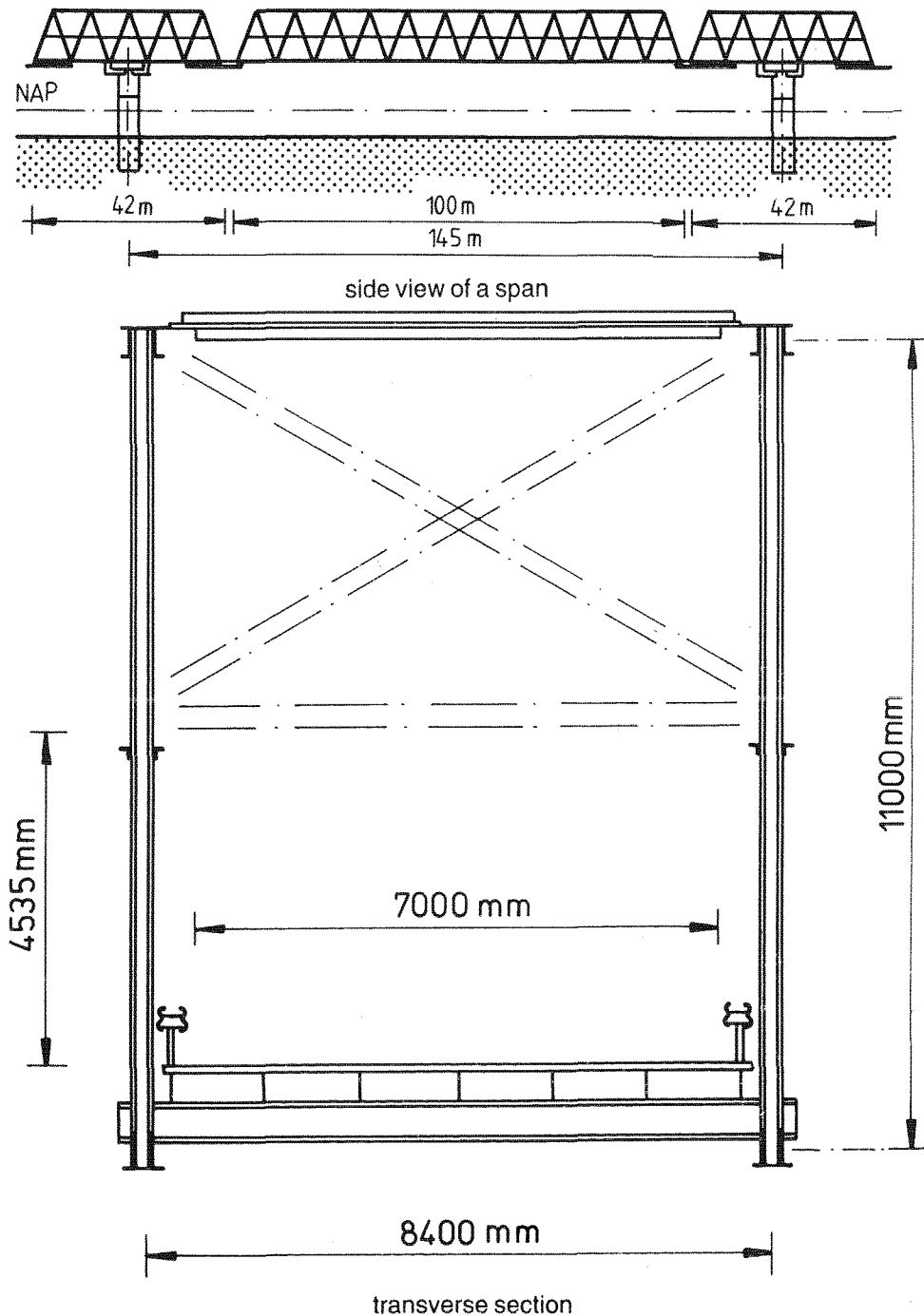

Fig. 69 Support bridge to Neeltje Jans, length 2780 m.

investment in million dutch guilders

10 20 30 40 50 60 70 80 90 100 110 120

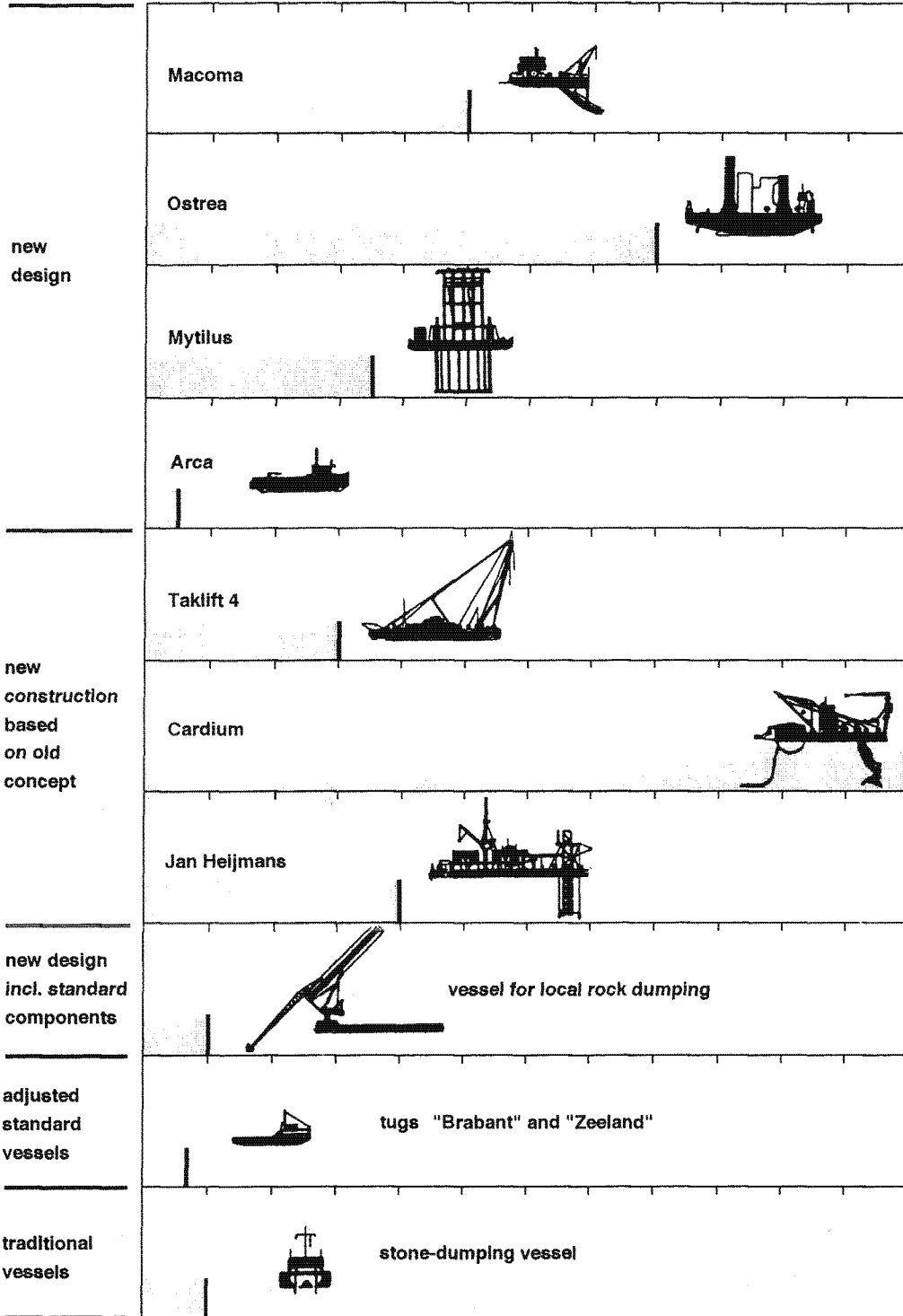

Fig. 70 Overview support equipment.

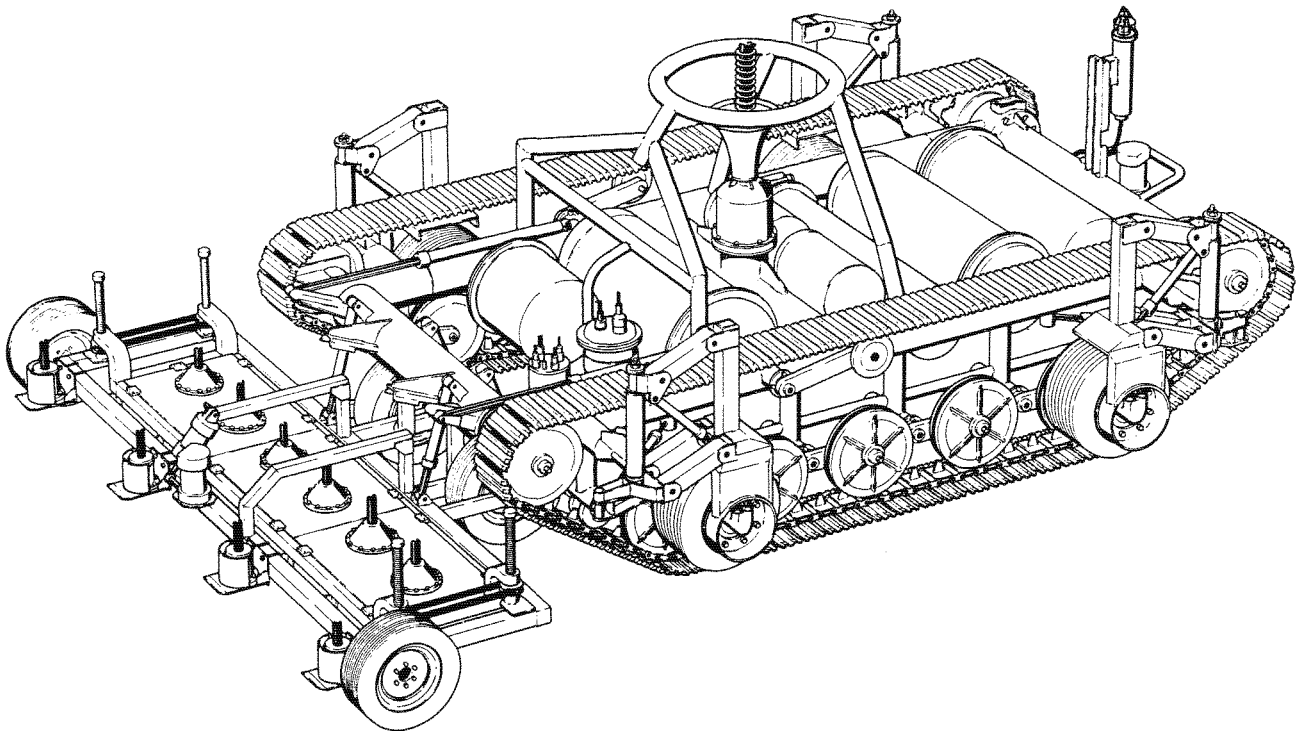

Fig. 71 Subaqueous monitoring vehicle Portunus.

4.4.2 Support systems

The first group consists of a.o.:

- The HISTOS-information system for data concerning wave heights and water levels;
- The Hydro-Meteo-Centre for the prediction of expected hydrodynamical and meteorological conditions;
- Localisation systems with different grades of accuracy, for the active positioning of the various construction vessels in the horizontal area;
- Under water working systems which accurately establish the position of the bed, and objects in relation to the construction vessel.

As far as necessary for the active positioning, the location systems were either on a vessel or ashore with telemetrical presentation aboard the vessels. Computers could present the data as simply as possible to the captains of the construction vessels.

4.4.3 Support equipment

The second group consists of a large number of construction vessels which are not all shown in Figure 70.

These vessels were:

- Completely newly designed, such as the positioning- and cleaning-up vessel MACOMA, the pier lifting vessel OSTREA, and the compaction vessel MYTILUS;
- Newly constructed on the basis of previous developments such as the CARDIUM as laying vessel for the foundation mats which, with regard to the laying part, was developed from the previously designed blockmat laying vessel DOS I/DONAX, and with regard to the sand suction section, formed a further development of the previously developed 'dustpan' (= hoover)suction head of the reconstructed suction-cutter dredger Slidrecht 27; The stone asphalt mat layer 'Jan Heymans' was reconstructed into a mastic strip

layer and later again into a dumping vessel for the construction of loose filter layers from relatively fine material in the negative overlaps (transitions) between the foundation mats;

- Newly developed on basis of compositions of more or less standard components, such as the top layer-dumper TRIAS which was used to place very heavy rubble in the sill construction.

Finally, there is a category of construction vessels which belong in principle to the standard equipment of a contractor, but were at times more or less adjusted to the specific requirements of the work to be carried out, for instance the abovementioned suction-cutter dredger Slidrecht 27.

4.4.4 Support means for monitoring

In the third group there is a large differentiation of tools and systems, such as:

- A diving bell for soundings and for taking underwater bed samples;
- The simultaneous sounding system of Wijker Rib;
- The bed crawler PORTUNUS for carrying various instruments for the inspection of the foundation mats (Fig. 71);
- The inspection sledge ASTERIAS, belonging to the CARDIUM, which also functions as instrument carrier;
- A large differentiation of instruments and sensors such as underwater television cameras, sand and silt detectors and acoustic working distance measuring equipment.

In particular with regard to locations both under- and above water, and the underwater inspection, the rapid development of micro electronics coupled with the observation-, measurement-, regulation-, and calculation technics have opened up many new possibilities for the introduction into hydraulic engineering.

Part 5: Management, monitoring and maintenance

Contents

- 1 Management of the storm-surge barrier 180**
 - 1.1 Introduction 180
 - 1.2 Management of the barrier during storm-surge conditions 181
 - 1.2.1 The safety criterion 181
 - 1.2.2 Operational possibilities 181
 - 1.2.3 Safety analysis 182
 - 1.3 Consequences of closure of the storm-surge barrier during storm surges 182
 - 1.3.1 Juridical aspects 182
 - 1.3.2 Impact on the functions of the Oosterschelde 183
 - 1.4 Evaluation and adjustment of management 183
 - 1.5 The use of the barrier for secondary purposes 183
 - 1.6 Consequences of closure of the storm-surge barrier for secondary purposes 184
 - 1.6.1 Juridical aspects 184
 - 1.6.2 Impact on the functions of the Oosterschelde 184
 - 1.7 The system of decision making of the Oosterschelde 184
 - 1.7.1 Deciding and controlling 184
 - 1.7.2 Basic set-up and activation of the decision making system 185
 - 1.7.3 Functions and operational performance of the Decision Simulation System (DSS) 185
 - 1.7.4 The Emergency Closure System (ECS) 186
- 2 Possible secondary functions of the barrier 188**
 - 2.1 Introduction 188
 - 2.2 Policy scheme for the Oosterschelde 189
 - 2.3 Possible secondary functions for Dam compartment Neeltje Jans and Roggenplaat 190
- 3 Security aspects of the barrier 192**
 - 3.1 Introduction 192
 - 3.2 Security of the barrier against sabotage and other destructive actions 192
 - 3.3 Security against accidents caused by the barrier 192
- 4 Monitoring of changes in the abiotic and biotic conditions 193**
 - 4.1 Introduction 193
 - 4.2 Changes in flora and fauna of the Oosterschelde 193
 - 4.3 Erosion of shoals, shallows and saltings in the Oosterschelde 194
 - 4.4 Ecosystem research of saltings 194
 - 4.5 Large-scale morphological developments 194
- 5 Monitoring and control of performance and condition of completed barrier 196**
 - 5.1 Introduction, definitions and functions 196
 - 5.2 Aim of performance monitoring and condition control 196
 - 5.3 Performance monitoring and condition control in practice 197
- 6 Fields of interest for maintenance 201**
 - 6.1 Rough survey of the maintenance problems 201
 - 6.2 Further survey and analysis of points of interest 202
 - 6.3 Further analysis of functions and relationships between components 203
 - 6.3.1 Active and passive components 203
 - 6.3.2 Primary functions against supporting functions 203
 - 6.3.3 Mutual dependency of primary components 203
 - 6.3.4 Independent primary components 204
 - 6.4 Overview of supporting relationships regarding the retaining function 204
 - 6.5 Final consideration and policy of the Regional Division of Rijkswaterstaat for Zeeland 205

1 Management of the storm-surge barrier

1.1 Introduction

Together with the water retaining structures along the Oosterschelde and the compartmenting dams, the storm-surge barrier forms a system which secures the areas adjacent to the Oosterschelde against flooding. The system meets the requirements of the Delta Committee and at the same time maintains the salt tidal environment in the Oosterschelde.

Within this system, the task of the storm-surge barrier is to keep the dangerous storm-surges outside the Oosterschelde basin. The fulfilment of this assignment, shortly called 'the management', means several options are possible. These refer to:

- At what water level should the barrier be closed, either based on predictions or on actual water levels;
- What water levels are generated after closure of the Oosterschelde barrier;
- Should the barrier be opened in between two storm peaks if the storm-surge continues longer than one tidal cycle.

The combination of these above mentioned possibilities are indicated with the term '**the management strategies**'. The choice of the most desired management strategy or strategies is a policy decision, to be taken by the Minister of Public Works, Transport and Water Management after a consultation procedure and advice by the Board of Public Works. Once present, the storm-surge barrier can also be used under other condi-

tions than those during storm-surges. The policy for these different conditions is also to be decided by the Minister.

To support this decision making, the State Department for Public Works set-up a research project, called BARCON (BARrier CONtrol), to go into all aspects concerned.

This project consisted of two phases.

Phase 1 involved the establishment of a programme of requirements from a management point of view which were of importance to the design of the storm-surge barrier. These studies were used in the so called 'Rand Report' in 1979 (see Doc. 1). Phase 1 will not be further discussed in this Chapter.

Phase 2 involved the overview and analysis of various application possibilities of the storm-surge barrier. The following Sections (1.2-1.6) represent a summary of the document that resulted from this project, 'Management of the Storm-Surge Barrier Oosterschelde' (Doc. 2).

Parallel to Phase 2, on request from the State Department of Public Works, TNO (some items in cooperation with the American Institute SRI) carried out research studies into the decision making system for the operational management of the storm-surge barrier and the equipment needed (see Doc. 3).

Section 1.7 gives a short description of the decision making system designed with the help of this research.

To draft the above mentioned document 'Management of the Storm Surge Barrier Oosterschelde' and the underlying basic studies, a project organization called BARCON was set up

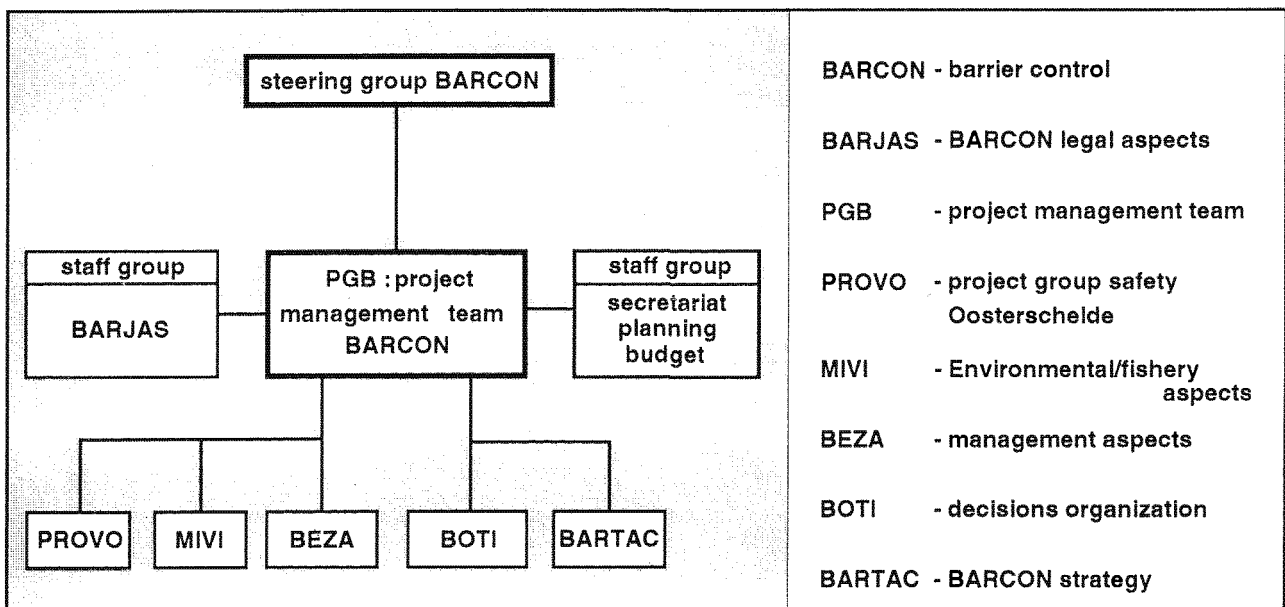

Fig. 1 Organizational structure of the BARCON project.

(see Fig. 1), acting under the responsibility of the Guidance Group Oosterschelde (BGO) (see Part 1, Section 5.1).

Within workgroups, beside RWS personnel, experts from the Provincial Department of Public Works, the Polder Alliance Zeeland, the Department of Fishing of the National Department of Agriculture and Fishing, the National Institute for Environmental Management, the Delft Soil Mechanics Laboratory, Delft Hydraulics, the Delta Institute for Hydro-biological Research, the State University in Gent and the Organization for Applied Natural Science (TNO) all participated directly and indirectly in the basic studies.

Beside the above mentioned research into the design of a decision making system, the following projects have been carried out:

- Safety aspects of the management of the storm-surge barrier;
- Safety of the Oosterschelde dikes in relation to the use of the storm-surge barrier;
- Effects of the management of the storm-surge barrier Oosterschelde on the environment and fishery;
- Aspects of management of the storm-surge barrier Oosterschelde;
- Methods of use of the storm-surge barrier Oosterschelde during storm-surge conditions.

Information on these research reports has been used in the aforementioned plan; however, they do not form a subdivision from it as such.

1.2 Management of the barrier during storm-surge conditions

1.2.1 The safety criterion

Newly constructed or reinforced water retaining structures have to meet the requirements of the Delta Committee. The Delta Committee stated that the water retaining structures in the south-west of the Netherlands had to be designed for a water level with a probability of exceedance of 2.5×10^{-4} (1/4000) per year. Under these design circumstances there still has to be a certain amount of safety. As indicated by the Technical Advisory Committee for Water Retaining Structures (Doc. 5), the accepted probability of failure should be at least a factor of 10 smaller than the mentioned frequency of exceedance (thus 2.5×10^{-5}). This safety criterion should be the starting point for management of the storm-surge barrier.

The safety of the coastal area along the Oosterschelde is determined by various factors which influence each other:

- 1 Natural conditions on the North Sea, such as the tide, the wind force and the wind direction;
- 2 The quality of the water retaining structures around the Oosterschelde which are determined by a.o. the crest height, the quality of the slopes, the revetments, the grass-mats etc;
- 3 The technical characteristics of the storm-surge barrier;
- 4 The management of the storm-surge barrier, the moment and way of closing;
- 5 The hydro-meteo conditions in the basin, such as water levels, wave height, flow velocity, wind force, etc.

Per component of the safety system, the probability of occurrence has been calculated of a certain water level in combination with a certain wave impact as well as the probability that, as a result of these conditions, this component collapses. The combination of these two probabilities ensures the probability

of flooding of a certain part of Zeeland. The total probability of flooding should not be greater than the safety criterion of 2.5×10^{-5} per year.

1.2.2 Operational possibilities

In principle the barrier can be closed when a certain (measured) water level is exceeded or when it is expected that a certain (other) water level will be exceeded (prediction).

- The measurement

When a certain level, still to be specified, on the seaward side of the barrier has actually been exceeded, the barrier closes automatically; the level at which this happens is called the **emergency level**. When the barrier closes automatically, a water level in the Oosterschelde arises which is almost equal to the emergency level.

- The prediction

In this case the barrier will be closed by the operational personnel when it has been predicted that the level, yet to be established, will be exceeded. This level is called the **closure level**. The closure can then be performed in time before the closure level is reached, so that in the Oosterschelde a lower level than the closure level can be created. In case of a closure based on prediction there has to be an automatic closure mechanism that serves as an emergency system. In case the prediction system fails and the water level reaches the emergency level, the barrier will then close automatically.

In case of closure on the basis of predictions, various more or less constant water levels can be generated in the Oosterschelde basin because the predictions are generally available 12 hours prior to the flood. This strategy is called **Closure on Basin level**.

During a storm-surge with several peaks it is also possible to open the storm-surge barrier after the first and second high tide and to close it before the next high tide in such a way that a new basin level is installed. This method of use is called the **Exchange strategy**. On the basis of a predicted water level, the barrier can in principle, also be partially closed. The moment the closure procedure begins and the size of the remaining opening, determine the level of the Oosterschelde basin. This method of use is called the **Reduction strategy**. However, from the points of view of construction and management of the barrier, there are significant objections against this strategy because it increases the probability of mistakes in management and monitoring systems. Therefore, the reduction strategy has not been considered any further in storm situations. This strategy can be used, in principle, for the additional functions of the storm-surge barrier.

The possible choices for closure- and emergency levels are limited, from a safety point of view, by the maximum acceptable water level in the Oosterschelde during storm-surges. From calculations it appeared that a closure procedure should be started before a water level of MSL + 3.50 m has been reached. This level serves as an upper limit for the emergency level.

Because of inaccuracies in the prediction of the water level, the closure level is 0.25 m lower than the emergency level. The maximum acceptable closure level is therefore MSL + 3.25 m. For the assessment of the lower limit for closure- and emergency levels, the exceedance frequency of certain water levels is of great importance. The choice of a very low lower limit would cause a large number of closures which are unnecessary from a safety point of view.

A closure level of MSL + 2.50 m should e.g. lead to 3 to 4 closures per year, while the limited monitoring level (emergency watch) in the situation before completion of the barrier is merely exceeded once a year. Therefore the lower limit for the closure level MSL + 2.75 m was kept.

In brief, the following management strategies and emergency level/closure level combinations have been analyzed:

Emergency level/closure level combinations:

- E-level: MSL + 3.00 m and C-level: MSL + 2.75 m;
- E-level: MSL + 3.25 m and C-level: MSL + 3.00 m;
- E-level: MSL + 3.50 m and C-level: MSL + 3.25 m.

Control strategies:

- Only the automatic closure system, which means closure of the barrier when an assessed water level is actually exceeded;
- Closure on basin level strategy:
 - a) A fixed basin level of MSL + 1 m in the Oosterschelde basin
 - b) A fixed basin level of MSL + 2 m in the Oosterschelde basin
- Exchange strategy: with alternatives shown in Table 1.

In the analysis regarding the control strategies, no lower fixed basin water levels are included (MSL or lower), because the storm often increases the low water level and therefore lower levels are not realistic.

Moreover, a basin level of MSL during a two or three peak storm cannot be maintained because of the leakage through the barrier. Higher fixed basin levels are not considered because they do not meet the safety requirements.

Beside the mentioned exchange strategies, in general many alternatives are possible.

These are not included in the analysis because of the negative results found in the preliminary investigation.

1.2.3 Safety analysis

The probability of failure of the water barrier is determined for the loads occurring during the control strategies and the emergency level/closure level combinations.

The following failure mechanisms have been investigated:

- 1 Flooding: A water level exceeding MSL + 3.50 m is not acceptable.
- 2 Insufficient stability of the inner dike slope: A number of dike compartments are vulnerable to this failure mechanism.
- 3 Insufficient stability outer dike slope: This mechanism is not indicative for safety, because critical situations can be prevented in a simple way with the help of the storm-surge barrier.

Table 1 Variants of the exchange strategy.

Variants	Closing before 1st top on MSL + m	Closing before 2nd top at MSL + m	Closing before 3rd top at MSL + m
Variant a	0	1	2
Variant b	1	2	3
Variant c	1	2	1
Variant d	2	1	2

4 Internal erosion due to piping: At water levels exceeding MSL + 2 m internal erosion occurs after some time in a number of dike compartments because of groundwater flow through or underneath the dike;

5 Damage/destruction to slopes and revetments by concentrated wave impact: A number of compartments do not meet the set requirements and need to be reinforced;

6 Damage to the grassmat by concentrated wave impact: With water levels exceeding MSL + 2 m problems can be expected for a number of dike compartments.

The probability of dike failure under a certain hydraulic loading, multiplied by the probability of occurrence of this load, must be smaller than 2.5×10^{-5} per year. Strategies with larger failure probability concerned it will be regarded as unsafe. Analysis of the safety of the Oosterschelde dikes show that the slope protections on a number of dike compartments are not yet in a condition which meets the set requirements. Also, a number of drainage sluices are present in the water barrier which no longer fulfil any function. These sluices form a weak link in the chain of the water retaining structures and need to be removed. During the calculations of the probabilities of failure it was taken into account that these sluices were removed before the completion of the storm-surge barrier and that renovations would be carried out on the revetment structures.

The safety analysis shows that an automatic closure system is not sufficient; the inundation probability is too high. Only an operational system will be considered for the operation of the storm-surge barrier supplemented with an automatic closure as a reserve system.

Of the analyzed control strategies with an operational system, the closure-on-basin level strategy of MSL + 2 m and the exchange strategy 1-2-3, appeared to have a too high inundation probability.

The other control strategies could be performed safely for all closure level/emergency level combinations.

So the following alternatives remain:

Emergency level/closure level combinations:

- E-level: MSL + 3.50 m and C-level MSL + 3.25 m;
- E-level: MSL + 3.25 m and C-level MSL + 3.00 m;
- E-level: MSL + 3.00 m and C-level MSL + 2.75 m

Control strategies as shown in Table 2.

The safety analysis did not take into account the psychological aspects related to the various methods of operation of the storm-surge barrier. These aspects could be important particularly to the exchange strategies, because the barrier is opened and closed during the continuing storm to install another basin water level.

1.3 Consequences of closure of the storm-surge barrier during storm surges

1.3.1 Juridical aspects

On the basis of the Delta Law and the decision of 1976, it must be concluded that safety is a priority for the operation of the storm-surge barrier. Therefore, the task of the management team is to close the storm-surge barrier during high storm-surges to protect the areas around the Oosterschelde.

The decision to close the barrier will be made on the basis of an

Table 2 Possible management strategies.

Management strategy	Establish basin level near 1st top	Established basin level near 2nd top	Established basin level near 3rd top
Strategy closure on basin level	1	1*	1*
Exchange strategies	0 1 2	1 2 1	2 1 2

*Due to leakage through and overtopping over the barrier this level will increase slowly. The quantity of the leakage will decrease due to growth of organisms in the sill construction.

instruction concerning the managing operation, which instruction has been drafted a.o. on the basis of this document.

Such use of the storm-surge barrier is not different from the use of other special structures, such as the storm-surge barrier in the Holandsche IJssel, and possible damage to third parties caused by closure of the barrier is an acceptable risk.

1.3.2 Impact on the functions of the Oosterschelde

The effects of the safe emergency level/closure level combinations are determined for the most important aspects of the environment, the fishery, and for the other functions of the Oosterschelde area.

The relevant aspects for the environment are:

- The shallow river bed in the Oosterschelde;
- The inter tidal area: the area which runs dry during the ebb tide;
- The saltings: the higher situated boundary areas;
- The hard substratum: the dike slopes protection to the average high water level;
- The birds.

With regard to the fishery, particularly the mussel- and cockle fishery has been taken into consideration.

With the remaining functions the shipping industry, the drainage of polders and the objects outside the dikes, such as for instance companies, are indicated.

The effects can be summarized as follows:

- Effects of the closure levels

At a closure level of MSL + 2.75 m, the barrier will be closed on average 1.7 times per year, and at a closure level of MSL + 3.25 on average once per 5 years. This number of closures does not lead to extensive damage for the environment and fishing industry. There is talk of gradual differences; a low number of closures of the barrier is most favourable to the environment and fishing industry. In particular the erosion of the intertidal areas and of saltings are of importance because of its mostly irreversible character.

- Effects of the adjustable basin water levels

The degree to which negative effects occur for the environment and the fishing industry is determined by the adjusted basin water level as well as by the number of closures. Table 3 shows the effects for the different functions per adjusted basin level. The table illustrates that the adjustment of a low basin level is the most favourable with regard to salting erosion.

- Effects of exchange strategies

In most cases the storm-surge barrier will be closed in connection with a one peak storm-surge; the period of closure is then

limited. By the effects analysis of the different control strategies during multiple peak storm-surges it was shown that by varying the fixed water level after the different storm peaks the effects will be spread across the different environmental components. To minimize the effects for the environmental components, it seems meaningful to apply the exchange strategy during multiple peak storm-surges. The relevance of this is however limited because of the low frequency of the occurrence of multiple peak storm-surges.

1.4 Evaluation and adjustment of management

Investigation of the control of the storm-surge barrier showed uncertainties in a number of points. They concern environmental effects and the effects of the so called leakage through the barrier on the time variation of the water level in the Oosterschelde. The control strategies are developed on the basis of model calculations for which the size and effects of the leakage had to be assumed. These assumptions must be verified in practice, on the basis of which the choice for the optimum basin level and the decision to use the exchange strategy or not can be adjusted.

After the storm-surge barrier has been in operation for a maximum of five years, the State Department of Public Works will draw up an evaluation report concerning management. This document could include proposals for the adjustment of management. This document will be presented to the Board of Public Works.

1.5 The use of the barrier for secondary purposes

A study has been carried out into the operational possibilities of the storm-surge barrier for other than storm situations. Firstly, possible situations were listed in which the use of the storm-surge barrier could be considered. The relevant research report (Doc. 4.4) gives an overview of this list. Examples from the list of application possibilities are the simplification of vessel salvation, extension of the working period in the low water zone, influencing of the morphological and vegetation development, and the simplification of installation of cables and pipe lines. Each of these application possibilities has been studied in order to find out to which extent the storm-surge barrier can be an effective instrument for reaching the intended objective, and if the intended objective can also be obtained by other means.

On basis of this analysis, the closure of the barrier appeared to be effective when:

Table 3 Effects of single basin levels on different functions.

Environmental component or function	Basin levels		
	MSL	MSL + 1 m	MSL + 2 m
Underwater bed	0	0	0
Inter tidal area	-	-	0/-
Shoals	0	-	-
Hard substrate	-	-	0
Birds	0	0	0
Fishery	0	0	0/-
Other functions	0	0	0

- Consequences of a dike (flow) slide and occurring storm damage can be kept limited;
- The combat against oil pollution can be carried out more efficiently;
- Serious damage to the dikes caused by drifting ice can be prevented.

1.6 Consequences of the closure of the storm-surge barrier for secondary purposes

1.6.1 Juridical aspects

The use of the storm-surge barrier for secondary purposes is studied from a juridical point of view, because it can cause damage to persons or instances. This study showed that when closure of the storm-surge barrier is necessary because of calamities (such as a dike slide, serious damage to slopes caused by drifting ice), it is also the responsibility of the management team to prevent dangerous situations.

Therefore the manager cannot be held accountable for personal damage or damage as a result of the use of the storm-surge barrier. In case of other calamities, such as oil pollution, it is the responsibility of the manager to prevent serious consequences. The instigator of these calamities can be held responsible, if this person can be identified and found.

1.6.2 Impact on the functions of the Oosterschelde

The consequences of the use of the barrier for the environment, fishing industry and other functions of the Oosterschelde, can be summarized as follows:

Closure of the barrier causes a decrease in the flow velocity. This causes an increase in sedimentation and mineralisation, which may create a layer without oxygen above the bed. This can happen particularly above areas with sea-bed life (mussels). An increase in the clearness of the water can cause an increase in the growth of algae. This increase in algae can be stimulated even more by an increase of the nutrition concentration as a result of the extension of time that the water stays on the same level. A significant increase in the water temperature (more than 23°C) may cause death of organisms. In the winter the water might freeze earlier. In creating both a low and high fixed basin water level, starting at the Krammer Locks, fresh water can spread across the Oosterschelde. Especially in spring, the larvae are vulnerable to a decrease in the salt content. The creation of a fixed basin water level or a reduced tide will have consequences for the functions of the Oosterschelde area. The effects for the environment and the fishing industry depend on the created level. Creating a low fixed basin water level may have the following consequences:

- Death of sea-bed life can occur after approx. 48 hours of high temperatures (air temperature 25°C); a moderate temperature and a lot of rainfall are favourable for the survival of sea-bed life;
- The algae mats on dike slopes and saltings will die, depending on the temperature, after a couple of days;
- The feeding places for birds are limited; after some time the birds will extend their feeding time;
- The forming of bacteria on fixed organisms will strongly increase after 7 to 10 days;
- The plant types situated lower on the saltings, will dry up;
- With an increased wind velocity there will be an increased

erosion of shelves and saltings;

- The navigability of sections for shell fish cultivation will likely decrease.

The introduction of a high fixed basin water level can lead to:

- The withdrawal of the feeding possibilities for birds;
- Decline of the saltings, particularly by the wave action;
- Decrease of the production process of vegetation in the summer during high temperatures;
- An extension of the navigability over the shell fish sections.

When applying a reduction strategy similar effects will take place in the zone which is constantly flooded and in the zone which is constantly dry.

Furthermore:

- The number of birds could decrease;
- During a longer period the flooding frequency of the saltings could decrease, and the vegetation could dry up;
- Extra erosion could take place during higher wind velocities.

The consequences of using the barrier for other functions are limited. Navigation could be hindered locally when there is a low water level; at fixed basin water levels, the bank positions can hardly be used. The capacity of the pumping stations will decrease at water levels exceeding MSL. Objects outside the dikes will not be hindered by this. The most negative effect for recreation is the smell of dead plants and animals at a low water level or when applying the reduction ('reductor') strategy.

When it is necessary to use the barrier for those reasons, negative effects for the environment and the fishing industry in particular, can be prevented or limited by keeping the period of use of the barrier as short as possible.

1.7 The system of decision making of the Oosterschelde

1.7.1 Deciding and controlling

A distinction is made between making decisions on barrier operations and the management of the barrier.

The service-control of the gates will take place in the central control building by means of the Central Computer Configuration (CCC). With the help of this CCC, signals can be sent via a data network to each of the 62 gates in order to completely or partially open or close them. Feedback will also take place (action realised, failing gate, etc.).

With the help of the CCC, gates can be manipulated individually to different levels. Human interference is necessary for the control of the gates via the CCC.

There is also a special component, the so-called safe-service-control, which works independent from the CCC directly on the local control of the gates. The safe-service-controls can move the gates up and down and the gate movement as a whole can be started or stopped (see Part 4, Section 2.8.4. and Book 4).

The management personnel, the CCC, the data network and local control units are called the Management System. The Management System performs orders from the 'decision maker' to close or open the barrier.

The decision maker decides if a barrier operation is necessary and if so, which one. If necessary, individual gate positions are indicated. The decision maker also decides the starting moment of the chosen operation.

The organization and the computerised support of this order issuing component will now be further discussed.

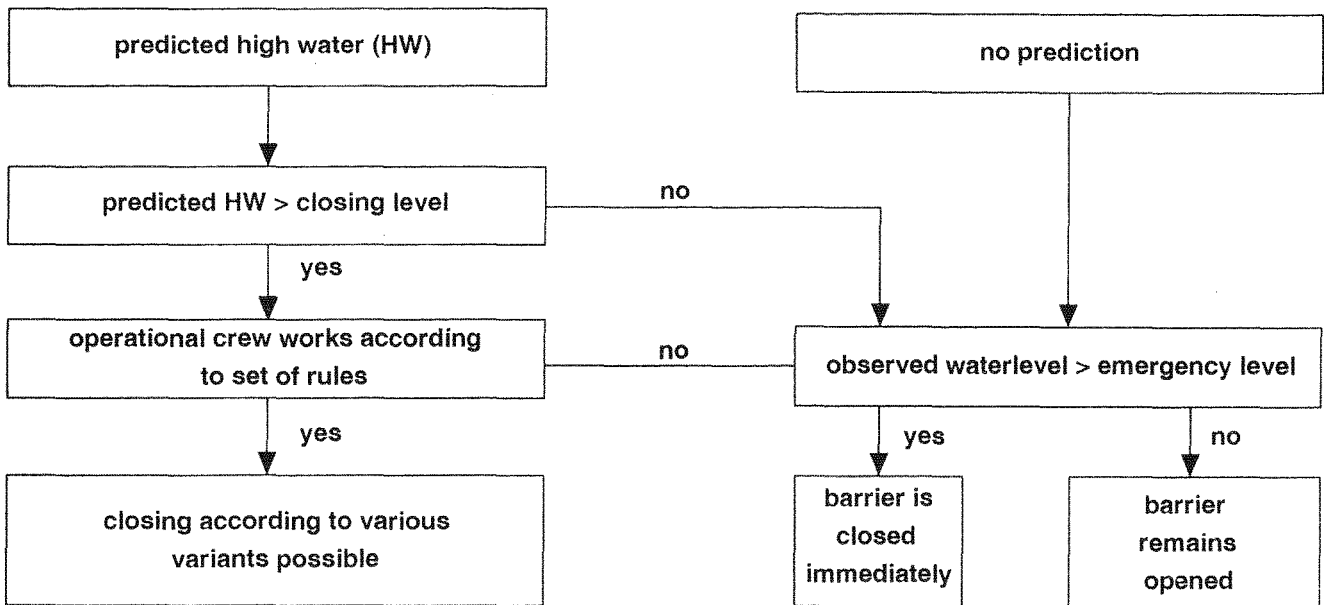

Fig. 2 The decision-making system has a twofold structure: primary decisions are made based on prediction, secondary based on actual (too high) water levels.

1.7.2 Basic set-up and activation of the decision making system

In Section 1.2.3 it was concluded that for safety considerations only a service-control system with an automatic closure system (as back up) will be considered for use of the barrier. The analysis of the application possibilities, with the lower limit for the basin level of MSL + 2.75 m, given in Section 1.2.2 shows that a necessary closure once a year of the barrier should be taken into account. It is therefore reasonable to have a system in which the decision making team can be called up. The basic set up of the decision making system provides for integration of a primary system which, by human interference, makes decisions on the basis of predicted water levels, and a secondary emergency closure system (ECS), which automatically decides on the basis of measured (actual) water levels. The basic structure of the decision making process is outlined in Figure 2.

Just like the service-control the decision making takes place in the central service-control building of the barrier.

In the primary system, the fairly small decision making team is supported by a computerised Decision Simulation System (DSS) with regard to:

- The presentation of actual data from the outside events;
- The decision: 'closure yes/no' and the choice of closure strategy;
- The follow up and monitoring of the decisions made.

The Emergency Closure System (ECS) works automatically and basically independent from the DSS. But there are connections between the ECS and the DSS for mutual exchange of information and a, between safe limits, strictly limited influencing of the ECS.

The on-duty personnel of the barrier can be largely automatically called up by the DSS on the basis of a.o. water level predictions and interruption signals.

The water level predictions come in from the KNMI (Meteorological Institute) or the SVSD via a permanent connection with DSS; the interruption signals of the monitoring system of the

barrier. In the call up process an already existing (because of another function), permanently manned RWS-post (Rijkswaterstaat) is called in, in relation to:

- The passing on of messages to called up personnel;
- To start the call up procedures for (other) calamity messages;
- The follow up of the reactions to the DSS of called up personnel, whereby the automatic call up of reserve personnel can be prevented.

A simple terminal screen is available for these call up functions to the RWS-post, which is connected to the DSS.

The commencement of the Emergency Closure System also activates the call up procedure via the DSS, this has not yet been started up earlier.

On arrival at the central service-control building, the called up personnel begin the decision making process. In principle, the operational personnel consists of:

- A responsible chief (Service Group), who makes the final decisions within strict directions;
- An assistant (preparation of tasks);
- A communications man (external communication);
- A control operator of the CCC; and
- Interference technicians.

1.7.3 Functions and operational performance of the Decision Simulation System (DSS)

The functions of the DSS in calling up personnel and the support of the decision process have already previously been mentioned. Although the DSS is primarily meant for the storm-surge conditions, it can also perform similar functions for possible (other) calamities. It also serves a, mainly informative, means of support for the daily management of the barrier. Briefly summarized, the DSS has the following functions:

- To receive, store and process data for simple presentations;
- To call up the personnel of the barrier;
- To support the decision making by predicting the conse-

quences of suggested decisions using simulation models, and the verification of these decisions to policy criteria and to suggest the most favourable closure procedure after a closure decision has been made;

- To support the monitoring of decisions carried out, also via simulation models; the assessment of important deviations in the actual situation which necessitate the revision of the decision made;
- Registration of data, actions during the decision process, manual input of statements and messages etc. for various purposes later on;
- As an expedient during the training of the barrier personnel by simulation of a realistic external event.

Besides the already mentioned terminal in the RWS-post for communication with the call up system, the DSS is provided with three terminal screens with input possibilities at the disposal of the decision team, and a monitor screen for the permanent presentation of the most recent values of a number of crucial data. The functions of the three terminal screens are related to the functions of the decision team, the requirements of daily management and the use during eventual calamities. Almost all capabilities of the DSS are accessible with a limited number of function keys. This is possible by using a safe and user friendly programme.

In order to perform its functions, the DSS constantly receives data via permanent communication lines with a.o. the KNMI (Meteorological Institute). There are also a number of connections from the DSS to the ECS, and the CCC.

ECS and CCC also supply data, such as data on the barrier, automatic emergency orders and water level data. Figure 3 shows the complete configuration of the DSS.

For training purposes, the active component of the DSS is detached from the rest for the support of the decision team,

which remains on in the background. The call up component can stop the training if necessary. This is outlined in Figure 4.

1.7.4 The Emergency Closure System (ECS)

As indicated in Section 1.2.3 an additional automatical emergency closure system (ECS) is necessary to meet the safety requirements.

By setting very high reliability requirements for the ECS (attainable through simple structures and multi designs), it is admissible to lower the requirements for the primary system (human decisions on the basis of predictions), to a realistic level.

Empirical data indicate that both in the predictions and in the call up procedure for personnel and also in the decision process, the probability of failure and mistakes can occur which lie in the range between 1% and 10% per barrier operation.

The combination of the ECS and the primary system (human decisions on the basis of prediction), supported by the DSS, gives a technically attainable and an economically attractive solution which meets the safety requirements.

The ECS has a simple structure: the water level at the basin and seaward side of the barrier is measured and when both exceed a certain fixed criterion, a closure signal goes to the gates via a direct connection with the safety control system.

The ECS is equipped with a number of directly linked water level sensors in the inner- and outer harbour of the Roompot Lock.

The ECS has furthermore a two way connection with the DSS. This connection has the following background:

- The action of the ECS is monitored by the DSS;
- During the closure of the barrier by the ECS, the call up system (DSS) has to be activated;
- The basin and seaward side water levels are also crucial for

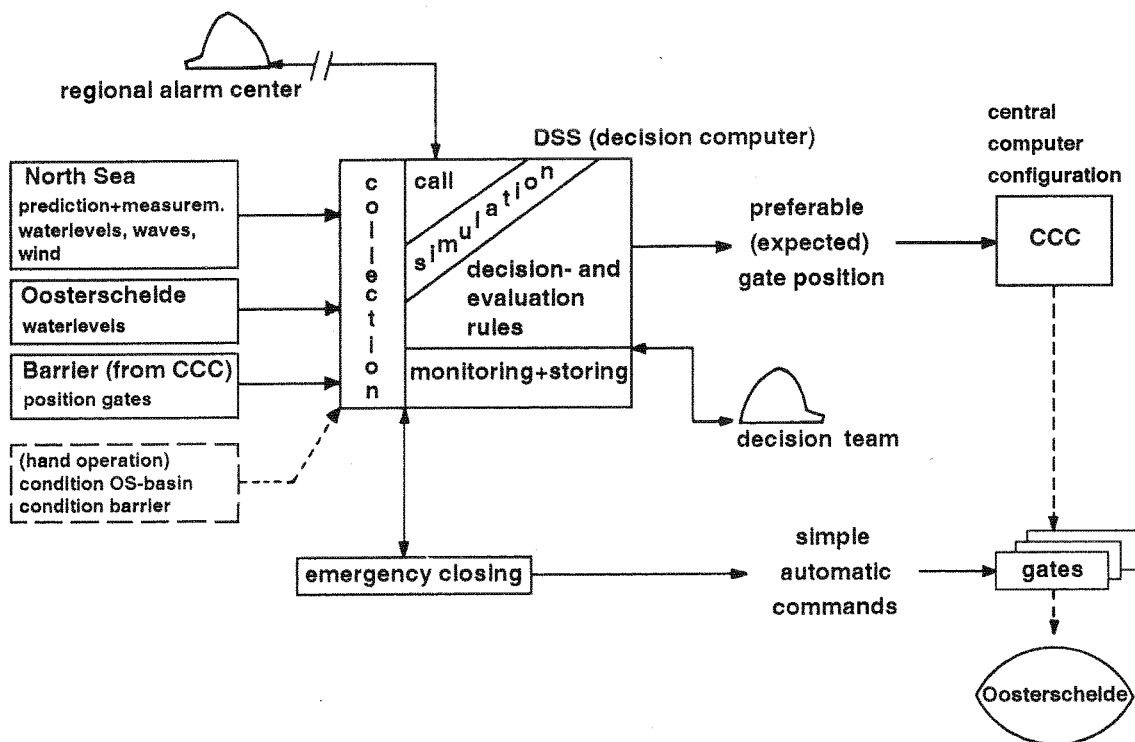

Fig. 3 The DSS (decision computer) is used by the decision team for the preparation of barrier operations. The DSS and a regional post make sure that the barrier personnel are called up. For this, the DSS has in- and out going information lines.

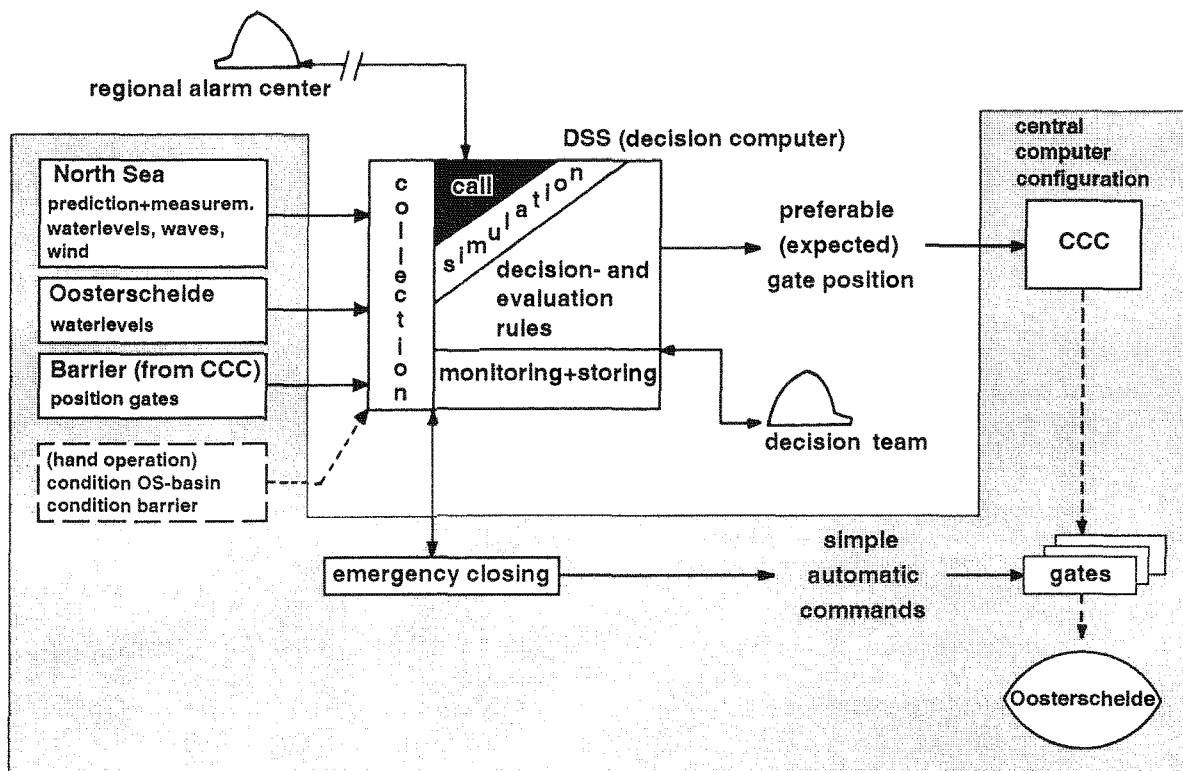

Fig. 4 The DSS simulates the outside world when it is used as a training facility (shaded: uncoupled active during training).

the DSS (c.q. the operational team); the ECS acts for that purpose as a reliable gathering station;

- The ECS must be influenced, in a strict limited way, during operational periods. This concerns adjustment of the basin criterion of emergency closures and a temporary break on automatic opening by the ECS.

The following explains the previous item. The ECS has to be able to automatically open the barrier after a closure, because prolonged relatively high water levels in the basin have to be prevented on account of wave impact. As a rule, this must take place automatically, just in case the personnel are unable to reach the barrier in time.

This automatic opening is also one of the reasons for the measuring of the basin water level.

Also during the generation of an emergency closure, the basin water level needs to be involved in order to prevent the ECS from making various, sometimes necessary operations of the decision team, impossible. This concerns a.o. the closure on changeable target levels and possible reductor operations. The criterion for the basin water level therefore needs to be adjustable, though within strict limits.

The above-mentioned necessary influencing possibilities of the ECS are bounded by reliable limitations. Within these boundaries, the DSS increases the control facility, flexibility and takes care of the necessary error messages.

Documentation

1 Catlett, L.; Wildhorn, S.; Stanton, R.; Roos, A.; Al, J.: Controlling the Oosterschelde storm-surge barrier. A policy analysis of alternative strategies

vol. I Summary report

vol. II Sensitivity analysis

vol. III Predicting North Sea water levels

vol. IV Basin response to North Sea water

Levels: The BARCON SIMPLIC Model

Rand Corporation, Santa Monica, USA, September 1979,

R-2444/1 - 4 -Netherlands ISBN 0-8330-0196-5 (vol.1)

2 BARCON Projectgroep

Beheer stormvloedkering Oosterschelde

Middelburg, 1 augustus 1985, Rijkswaterstaat, Dir. Zeeland (in Dutch)

3 Cierand, C.D.J.; Een beslissysteem voor de stormvloed-

kering in de Oosterschelde, Delen I t/m IV

TNO Hoofdgroep Maatschappelijke Technologie, Apeldoorn 1983 (in Dutch)

4 BARCON, werkgroepen; eindrapportages van uitgevoerde studies: (in Dutch)

4.1 'Veiligheidsaspecten van het beheer van de Stormvloedkering'

4.2 'De veiligheid van de Oosterscheldedijken in relatie tot het gebruik van de stormvloedkering'

4.3 'De effecten van het beheer van de Stormvloedkering op milieu en visserij'

4.4 'Beheersaspecten van de stormvloedkering Oosterschelde'

4.5 'Gebruikswijzen stormvloedkering Oosterschelde onder stormvloedomstandigheden'

Middelburg, april en mei 1985, Rijkswaterstaat, dir. Zeeland

5 Technische adviesgroep van de Waterkeringen;

Leidraad voor de beoordeling van duinen als waterkering, T.A.W. 5, uitgave 1984

2 Possible secondary functions of the barrier

2.1 Introduction

For the benefit of the Oosterschelde works (first the closure, later the storm-surge barrier with the compartmenting dams) a number of infra structural structures have been built in and along the Oosterschelde (particularly construction harbours and construction sites) to be able to realise the actual project (see Part 4, Section 4.3). These works, which have through their nature a more or less permanent character may, after they have served their purpose during the construction period of the barrier, be eligible for new allocations. Allocations, which have a favourable effect on the future developments in the Oosterschelde area. Conversely, for the entire area, the developments anticipated by the administration are of great importance for the choice of the intended new allocations. First of all, in Section 2.2 more detail is given on the development of a policy plan for the Oosterschelde in which the developments are described.

In the framework of this design document it particularly concerns the island Neeltje Jans and the construction island Rog-

genplaat, which are a part of the project, but of which large areas do not form part of the barrier in a restricted sense, and can therefore be considered for other allocations.

With the term 'Secondary functions' the functions which these islands (or parts thereof) can fulfil are indicated which are not directly connected with the functions (storm-surge barrier, road connection) for which the project has been initiated. Section 2.3 discusses this in more detail.

In Doc. 1, partially new, from that moment officially employed descriptions are introduced. In Section 2.3 use has been made of these descriptions.

Table 4 shows a complete overview of the suggested descriptions.

Documentation

1 Naamgeving objecten S.V.K., Directie Zeeland, Dienstkring Deltakust, notitie nr DK 86-18B, d.d. 6 juni 1986 en nr. DK 86-20B d.d. 5 juni 1986 met 1 tekening

Table 4 Overview of official terms (Section 2.1).

Objects	Names presently used c.q. locations	Suggested names
Barrier	Oosterschelde barrier	Oosterschelde barrier
Closure gates	Hammen	Hammen
	Schaar	Schaar
	Roompot	Roompot
Harbours	Noordland inner	Noordland inner harbour
	Noordland outer	Noordland outer harbour
	Roompot	Mats harbour
	Concrete harbour	Concrete harbour
	Construction dock 1	Delta Expo harbour
	Construction dock 2	Construction dock
	Construction dock 3	Construction dock
	Construction dock 4	Construction dock
	Neeltje Jans outer	Neeltje Jans port of refuge
Viaduct	Roggenplaat	Roggenplaat harbour
Tunnel	Close to the Topshuis	Poolfoot
	Close to the Topshuis	Keele
Lock	Abutment Geul	Geul
	Roompot lock	Roompot lock
Bridge	Roompot lock	Noordland
Former work island	Roggenplaat	Roggenplaat
	Neeltje Jans	Neeltje Jans
Roads	Parallel road North Sea side	High Plaet road
	Parallel road Oosterschelde side	Fael road
	Road under the viaduct and road to Ir. J.W. Topshuis	Dijkgraaf Geluk road

2.2 Policy scheme for the Oosterschelde

The government's decision in relation to the construction of the barrier is based on the fact that in this way sufficient protection could be given to the area around the Oosterschelde and that the salt tidal environment could be maintained. As a consequence of the Oosterschelde works changes will occur in the tidal environment (i.e. surface reduction of the Oosterschelde basin) as well as in the characteristics and operational possibilities of the area. The care for the maintenance of the tidal environment means that also occurring changes will be channelled in the right direction and an integrated policy of management and space allocation will be strived at. In order to achieve this, it was decided to 'create an integrated and coherent organizational- and management plan' (to be interpreted further as the 'Policy plan'), whereby effective cooperation and concern of the local government and population are seen as essential for the success of this Policy Plan. In the Oosterschelde Steering Committee, established in 1977 by the County delegates of Zeeland, the various management levels were also involved; besides government representatives (from the most involved departments), the Steering Committee consisted of representatives of the Province of Zeeland, of councils surrounding the Oosterschelde and of the polders involved.

The Coordination Group Oosterschelde (CGO) was created to initiate and coordinate the activities in connection with the design and drafting of the Policy Plan, which can establish project- and working groups for these tasks (Fig. 5).

In preparation of the Policy Plan, a report appeared in 1978 which supplied a list of the abiotic and biotic characteristics of the Oosterschelde area and contained an overview of the space allocation and formulated views and policy intentions with regard to developments in the area (Doc. 1)

On the basis of this report and of other studies on the development possibilities of the environmental, fishery, nature and recreation functions (Doc. 2 and 3) six policy alternatives were developed (Doc 4) which all start from the primary aim of the policy: 'The maintenance and, if possible reinforcement of the present environmental values, taking into consideration the basic conditions for a satisfactory social functioning of the area, including the fishery industry. Overview reports were also published in relation to management aspects and the present juridicial set of instruments (Doc. 5), and policy possibilities (Doc. 6).

This latest document had been the subject of consultation and participation; on the basis of the results the Oosterschelde Steering Committee made a basic statement concerning the allocation and management of the Oosterschelde area up to 1990.

This principle statement is included in the concept-policy plan for the Oosterschelde (Doc. 7). The government's commitment to the policy plan was given by signing a 'Statement of Intention' by the participants. This Statement of Intention meant that the participants would base their policy on the Policy Plan. After consultation, the final Policy Plan and the Statement of Intention was approved by the Cabinet in 1982 after which the Provincial States/County Council confirmed the Plan (Doc. 8). From the main aim of the Policy Plan, a hierarchy of functions follows which is decisive for the Policy: 1. Nature; 2. Fishing industry; 3. Other functions such as recreation, shipping and others.

The main aims are worked out in the plan into policy core points

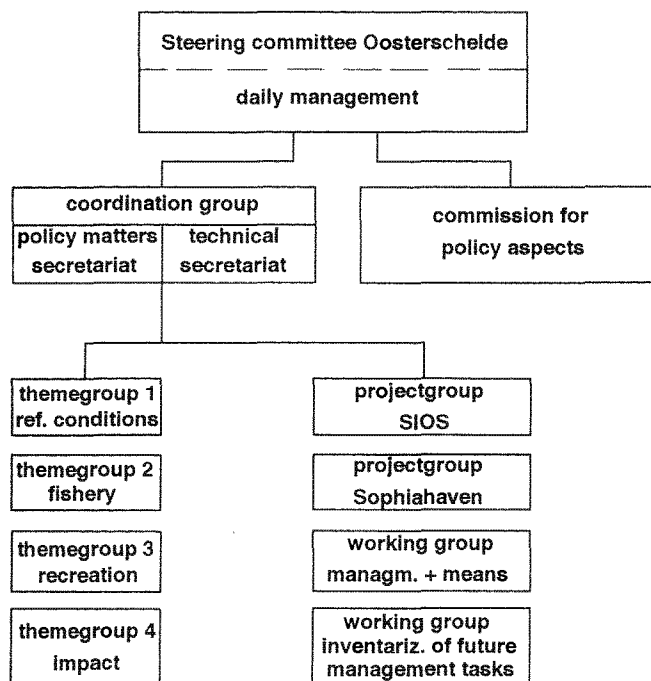

Fig. 5 Consultation and operational structure Oosterschelde.

relating to the functions of the area. The Policy Plan also includes:

- An allocation outline showing which projects and development could be realised before 1990;
- A rough description of the desired management;
- An overview of the studies and projects which should be performed in the period 1980-1990 for evaluation and possible adjustment of, and additions to the Policy Plan;
- A procedure on the basis of which the policy (according to the Policy Plan) can be adjusted.

The developments in the policy relating to the Oosterschelde are included in the yearly published progress- and evaluation reports. These reports consider whether results of the policy supporting studies carried out or alterations in social needs make it necessary to adjust the Policy Plan (Doc. 9, 10 and 11).

Documentation

- 1 Coordinatiegroep Oosterschelde, 1978, Inrichting Oosterschelde, deelrapport inventarisatie
- 2 Coordinatiegroep Oosterschelde 1980, Studies over de Oosterschelde Deel 1
- 3 De ontwikkelingsmogelijkheden van natuur-, visserij- en recreatiefuncties
- 4 Coordinatiegroep Oosterschelde 1979, Verkenningen inzake de ontwikkelingen in het Oosterschelde gebied
- 5 Coordinatiegroep Oosterschelde 1980, Studies over de Oosterschelde. Deel 3, Beheeraspecten en instrumentarium Oosterschelde
- 6 Coordinatiegroep Oosterschelde 1980, De Oosterschelde: een overzicht van de beleidsmogelijkheden
- 7 Stuurgroep Oosterschelde 1981, Concept beleidsplan voor de Oosterschelde
- 8 Stuurgroep Oosterschelde 1982, Beleidsplan voor de Oosterschelde

- 9 Stuurgroep Oosterschelde 1983, Beleidsplan Oosterschelde. Voortgangs- en evaluatie rapportage 1982
- 10 Stuurgroep Oosterschelde 1984, Beleidsplan Oosterschelde. Voortgangs- en evaluatie rapportage 1983
- 11 Stuurgroep Oosterschelde 1985, Beleidsplan Oosterschelde. Voortgangs- en evaluatie rapportage 1984

2.3 Possible secondary functions for Dam compartment Neeltje Jans and Roggenplaat

In the framework of the activities of Oosterschelde Steering Committee, a study was carried out into the future allocation of the Neeltje Jans island. The Steering Committee established the Project group Dam compartment Geul with the task of preparing and drafting a number of allocation alternatives for the Neeltje Jans island. The study concludes with an overview of the consequences of various allocation possibilities for aspects of management of the storm-surge barrier, for the environment, for the development of the fishing industry, etc. (Doc. 1).

This report presents the following alternatives:

A. Minimum alternative

For the time being this alternative allows few new developments, except for those already chosen. The decision making in relation to further allocations will be, for a considerable part, postponed to the future and then might possibly relate to functions which were not mentioned now or which were rejected;

B. Fishing industry alternative

This alternative gives as many development facilities as possible to the various fishery functions;

C. Presentation- and innovation alternative

Emphasis is on the functions related to the initiation of (new) developments in science and business sectors which are directed towards research and exploitation of the marine environment;

D. Integration alternative

The integration alternative is not based on a specific theme, but it attempts to show the different sorts of functions inside the harmony-criterion as much as possible, as a result of which this alternative contains elements of all other themes;

E. Day recreation

This alternative is especially directed to the functions which contribute to the development of a high quality (day)recreation.

Because a number of choices have already been made relating to allocation, the following functions appear in all alternatives:

- The primary hydraulic function of the original dam body, the control- and service building, the Noordland inner harbour with an adjoining north-eastern site and the already present wet and dry stone storage in some of the harbours;
- The traffic function of the dam body;
- The reservation of other hydraulic functions of the Roggenplaat island;
- The beach recreation;
- Hotel and catering industry north-east of the Concrete harbour;
- The yacht harbour reservation in the south west part of the Mats harbour with an adjacent dry terrain;
- The trailer slope along the North Sea in the Noordland outer harbour;

- The information- and exposition facilities in the ir. J.W. Tops-huis.

Furthermore, in all alternatives an exposition which deals with the richness of the sea, on the site north west of the Construction dock and the Delta Expo harbour; a berth for life-boats in the Neeltje Jans harbour and a customs post in the service-control building of the Roompot Lock is incorporated, selected.

At the end of August 1984 the Oosterschelde Steering Group made a choice out of the above mentioned alternatives A-E. The choice was the so called integration alternative (D).

In this alternative many functions are combined. In particular the exposition of the richness of the sea and the public works recreation ground (e.g. a recreation ground/play ground based on the theme water and public works) are mainfunctions, but related to the other significant functions of this alternative. The public works recreation ground is located north west of the Concrete harbour. It is an extension of the richness of the sea exposition and the centre can contain elements connected to functions such as the mariculture centre, information and promotion of energy, off-shore and practised functions of the fishing industry. In connection with the exposition and the public works recreation ground, a naval museum might be built in the Construction Dock. On the south west bank of the Mats harbour, bank recreation possibilities are indicated.

A number of other functions, which were mentioned in the other alternatives, are also projected in this alternative, such as recreational fishing from the bank, berths for large recreational fishing boats, diving, fish cultivation, berths and quays for touring boats, fish transshipment and eel- and lobster fishing. Furthermore, spontaneous environmental developments will be encouraged where possible. A variant on this alternative can be formed by integrating the information and promotion of energy and off-shore in the public works recreation ground and to situate the richness of the sea exposition in the transition area of these functions. The site adjacent to the north east side of the Mats harbour can then be made available to recreation possibilities.

A large number of the considered functions are not/could not be defined and detailed to the extent that more or less detailed locations could be assessed.

The carrying out of the chosen policy has been worked out in more detail by the Neeltje Jans Policy Group. This policy group, which is subdivided into a number of working- and project groups, also has a coordinating task for the management, for instance the prevention of undesirable developments and for the planning approach (preparation zoning plan).

Provincial policy plan for recreation and tourism (PBRT)

In the PBRT, which still has to be established by the County Council (Provincial States) of Zeeland, the main points of provincial policy of the desired recreational development of Zeeland are indicated. In the concept of this sector-plan, Neeltje Jans is described as a so-called 'spear point'. According to the concept-plan, spear points can function as starting point and generator of the (in the long term) desired developments. According to the concept PBRT, Neeltje Jans can develop into a national and international attraction with opportunities for the promotion of Zeeland at home and abroad. It offers unique possibilities for arrangements of the hotel sector. Starting from the possibilities and the limitations, the idea is to build a touristic multi-functional centre with different activities clearly

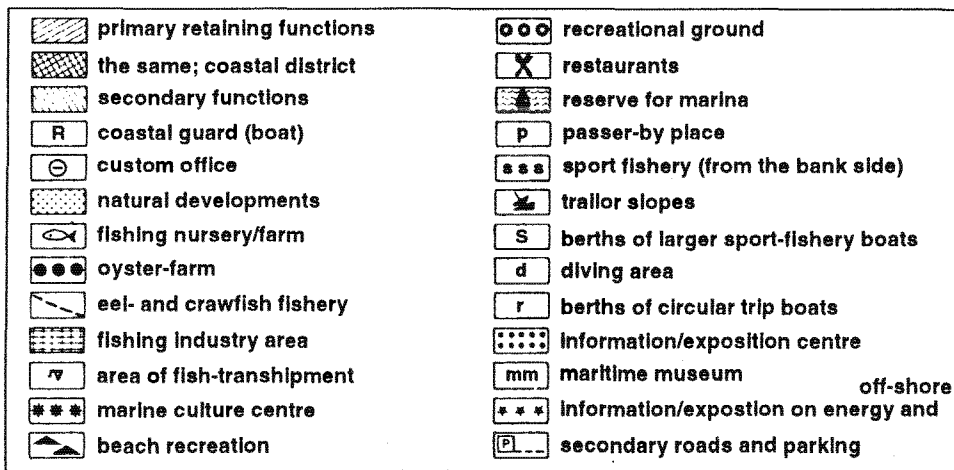
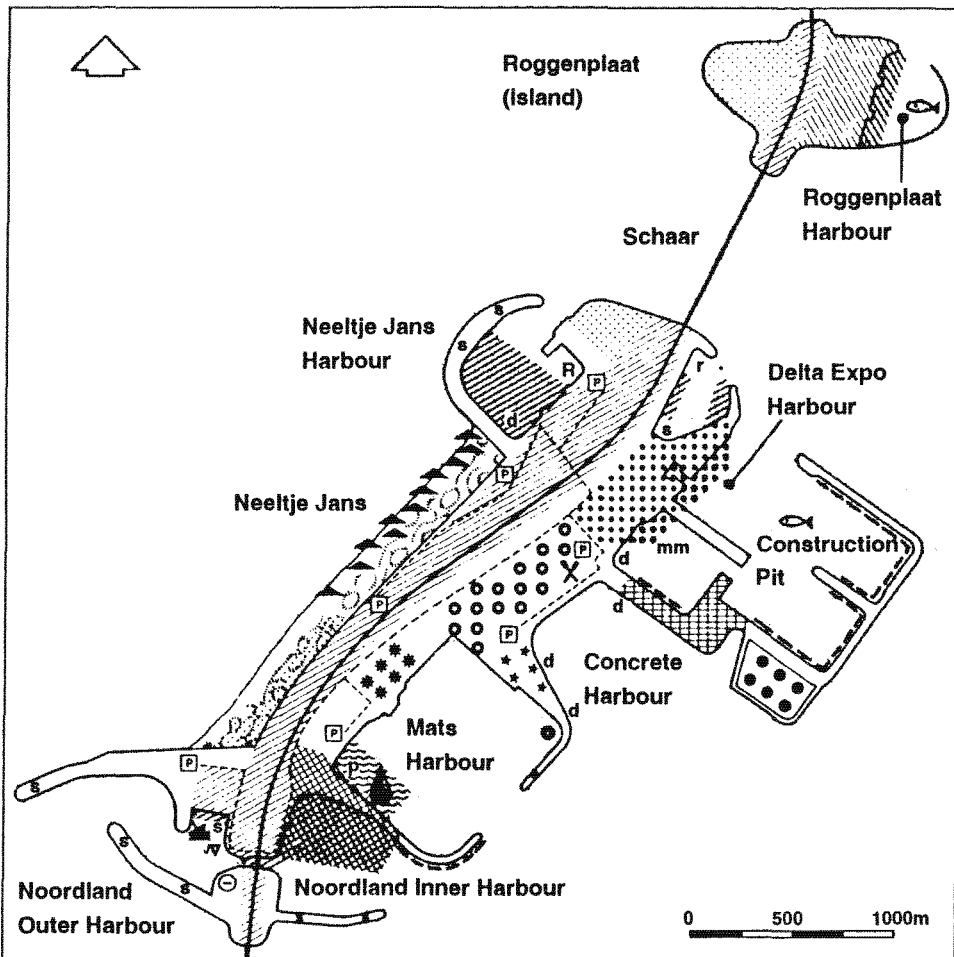

Fig. 6 Integration alternative.

linked to certain themes. The PBRT concept mentions as its main points:

- Day recreation
 - Naval expo (hydraulic technology of pier dam and compartmenting works in relation to the fishing industry, flora and fauna, directed towards educational and 'special-interest' aspects) and the beach;
- Water recreation

Fixed berths and passers-by places, trailer slopes.

Documentation

- 1 Inrichtingsalternatieven Neeltje Jans, Project groep Damvak Geul, juni 1984
- 2 Provinciaal beleidsplan voor recreatie en toerisme

3 Security aspects of the barrier

3.1 Introduction

The subject of security involves two aspects:

- Firstly it concerns the access security of the object, whereby damage or defective affects of the barrier can be prevented;
- Secondly it is the protection of the users in the surroundings (in particular the waters) against accidents which can be caused by the presence of the barrier; these accidents can possibly lead to damage of the barrier.

Obviously this has nothing to do with accidents concerning the barrier itself. This has been fully discussed earlier in the design and the maintenance of the barrier.

The following Sections will discuss the two safety aspects in more detail.

3.2 Security of the barrier against sabotage and other destructive actions

Because of the extensiveness of the object and the relatively remote location, the storm-surge barrier is quite vulnerable to actions which cause damage. It is even more vulnerable because normally, outside working hours, the object is not manned (except for the Roompot Lock).

The vulnerability is reasonably limited where the possible consequences of destruction are concerned, if the total of defective affects of the barrier is regarded as a serious consequence.

The consequences of destruction to the barrier will probably be limited to a single section/gate.

The total break down of the barrier could be caused in case the central control system and/or its communication system, or the central energy supply are radically disordered. Protection will have to be directed towards this area.

Because of the aim and the character of the protection measures mentioned here, they will not be further discussed. Suffice it to say that appropriate measures have been taken.

Besides protection against motivated actions directed towards a maximum effect, damage to the object by unmotivated actions, such as vandalism, should also be taken into account.

Vandalism, regardless of the consequences, can happen at every vulnerable point accessible to the public. The frequency of vandalism will mainly be linked with the presence of 'unorganized' public.

Measures against vandalism can be taken by making the most vulnerable components of the barrier inaccessible to the public. The accommodation of the decentralized parts of the control, the operating units of the mechanical and electrical system and all connections in the box girder, are a good example of this.

However, protection against motivated actions will also prevent vandalism to a certain extent.

3.3 Security against accidents caused by the barrier

This involves two user categories of the surroundings, namely:

- The road users on the box girders; and
- The (recreation) vessels on the waters in the surroundings of the apertures.

With regard to the road users on the box girders it must be noted that they will be hindered by changing wind forces, particularly when there is a strong westerly wind as a result of the shape of the barrier, the so-called 'pier effect'.

This is a familiar phenomenon of long bridges such as the Zeeland Bridge and the bridge across the Haringvliet. In particular for vehicles vulnerable to wind, such as cars with caravans, this can cause dangerous situations.

The wind hindrance is reinforced by local discontinuities as a result of one or more lowered gates. At the moment of writing this design, research was still continuing as to the possible seriousness of this phenomenon and to the character of the possible measures to be taken.

For vessels near the barrier there is a risk of being dragged into the apertures by strong tidal currents and strong wind. The limited headroom at low tide and the fact that there is no head room at high tide will then almost certainly cause serious accidents and even damage to components of the barrier. This risk exists both for professional navigation, but even more for recreation vessels and wind surfers.

The expected watersport activities near the barrier emphasizes the need for precautions.

Therefore a clearly visible marker at a good distance from the barrier is considered and/or a navigational ban in the neighbourhood of the outlets.

Precautions such as a safety line constructed of marked buoys near the Brouwers discharge sluice and the Haringvliet, showed that this increased the safety of the mentioned groups of users.

From a safety point of view and for marking uniformity in the entire Delta area, it is desirable to construct safety lines in the Oosterschelde near the storm-surge barrier.

The technical elaboration of such a structure and the aspects related, such as the exact location, related to the expected current velocities in the flow channels under different circumstances, as well as maintenance aspects, still formed the subject of research during publication of this design document.

4 Monitoring of changes in the abiotic and biotic conditions

4.1 Introduction

With the completion of the Oosterschelde works a long period of significant technical and financial efforts will finally come to an end. These were conducted by a Governmental decision, whose aim was not only to obtain protection against storm-surges, but also to maintain the salt tidal environment in the Oosterschelde as much as possible. The result of all efforts for the Delta Plan will be: an increased protection against storm-surges while retaining a large part of the environmental values in the south-west of the Netherlands.

The realization of the Delta works means that the wet infrastructure in the south west of the Netherlands will change radically. For certain areas the existing salt water ecosystem will disappear and become a fresh water ecosystem. For other areas the former tidal environment is changed into a stagnant salt water basin (Veerse Meer, Grevelingen Meer). Where the tidal environment is maintained (Oosterschelde, Voordelta) new dynamic balances will be created. The changes in the basins demand extra attention from the managers in the period when the balance is obviously disturbed. In particular the water manager will need extensive knowledge to be able to manage the newly created hydraulic units separately and in their mutual dependency. During previous closures it was found that various undesirable developments could occur (layering and a lack of oxygen in the Grevelingen Meer, bed pollution in the Hollandsdiep/Haringvliet and bank degradation in the Grevelingen Meer and Haringvliet). In order to take the necessary measures in time, alertness and expertise is essential from a water management-, ecological- and financial point of view.

A responsible management firstly needs a good insight into the developments in the area (on the basis of observations a.o. to check expectations). In a balanced way, the attention of management has to be focussed on:

- The part of the Oosterschelde which remains open, where environmental conditions will change because of tidal reduction which results in:
 - * A decrease in flow velocities;
 - * An increased clarity and an increased chloride content of the water; and
 - * A reduction in the number of shelves, shallows and saltings;
- The future Zoommeer, which will be desalted and for which a part of the shallows, saltations and shelves will run dry permanently.

In order to determine the research efforts for the management of the Oosterschelde, the management of the Grevelingen Meer also plays a role. In case the lake remains salty, the planned flushing of this lake from west to east relates to the water quality requirements in a section of the Oosterschelde basin (Mastgat-Zijpe).

If it is decided to change the Grevelingen Meer into a fresh water lake, then its management will depend on that of the Volkerak-Zoommeer.

For the development of a management strategy a research and advice programme has been developed for the previously mentioned basins and its water systems, for a period of 5-10 years. A problem analysis served as a starting point for the transition phase of the ecosystem to the new circumstances.

The aim of the programme is to recognise in time undesirable developments and to prepare measures to be taken. The State Department of Public Works will attempt to manage the Delta works according to the policy intentions of the Minister of Transport and Public Works with regard to water management.

Sections 4.2-4.5 will discuss in more detail the research aspects of a number of environmental components.

4.2 Changes in flora and fauna of the Oosterschelde

The gradual decrease of the tide in the Oosterschelde will have consequences for flora and fauna. The conditions for the seabed life (mussels, oysters) will change. Therefore the State Department of Public Works must have an insight into the complex changes with regard to possible claims from the fishing industry on the basis of the Delta damage law.

The water management will be directed to minimize the possible consequences of the use of the storm-surge barrier (see Chapter 1). In addition to this the water management is able to take adjusting measures.

Information must be passed on to other managers other than the State Department of Public Works, and after mutual consultation (see Section 2.2) it must be decided to what extent the various functions of the Oosterschelde can be stimulated.

The closure of the storm-surge barrier will temporarily turn the Oosterschelde into a stagnant basin. The consequences of this are analysed in the BARCON-study (see Chapter 1), and in the studies for temporary closure of the barrier for the benefit of the construction and closure of the compartmenting dams (see Part 3, Section 5.5). The seriousness of the consequences depends on the applied closure strategy and the period of closure.

In the tidal ecosystem, the main water management elements (hydraulic and water quality), bed morphology and flora/fauna together form a dynamic balance.

The large hydraulic engineering structures disturb this balance. To make responsible decisions and for the design of hydraulic engineering structures in the system, it is of significant importance to be able to predict to what extent the system will be influenced. Therefore one has to know the system and understand how it functions. This means that research must be carried out.

After the study of human interference begins a very important phase in the research, namely the determination of the effect of the interference and the evaluation of the prognosis.

The research involves three phases:

- 1 To make a list of the elements in the ecosystem;
- 2 Process-research, aimed at the understanding of the functioning of the ecosystem. This involves on the one hand research into the energy flow and the movement of suspended particles through the biological system, and on the other the relationship between hydraulics and water quality variables, morphology/sea bed and spreading and growth of flora and fauna;
- 3 To follow developments after the interference with special attention for predicted changes in the system. This is necessary to enable recommendations and advice for the policy decisions to be taken.

Phases 1 and 2 have already been undertaken (see Part 3, Chapter 5).

In Phase 3, which will commence after 1986, attention will be directed towards analysis of consequences of the construction of the Oosterschelde barrier and the compartmenting dams for the ecosystem. This means that the actual situation will be compared with the predictions made on the basis of the research of Phase 1 and 2.

It has to be assessed whether the desired environmental aims with the hydraulic provisions and its management have been obtained: an account has to be given on the basis of the newly occurred situation.

The evaluation is further essential in order to verify the suitability of the proposed management measures, and to be able to realise eventual adjustment and additional measures. Considering the uncertainties which will remain during the estimate of the effects of a similarly large scale interference, the possibility that deviations can occur at important points with regard to the prognosis must be taken into account.

The evaluation also offers the possibility of improving the methods of study and analysis.

At first, the research effort in Phase 3 will have to be significant to be able to follow the quick developments during the initial period. It is anticipated that research is necessary up to 1990 which will be in line with the present lay-out and effort. After 1990, it is expected that sufficient insight will have been developed in the direct effects of the built structures and the short term stabilisation of the ecosystem, on the basis of which management measures can be taken. As shown by the developments in the Grevelingen Meer, there will be no question of a new balanced situation, especially with regard to the morphology. It mainly focuses on study into the long term effects. When a method for this type of research has been developed, the research effort could be continued, after 1990, on a lower level.

In the long term (after roughly 1995) the research effort will be completely comparable with that for the management of similar areas such as the Waddenzee.

4.3 Erosion of shoals, shallows and saltings in the Oosterschelde

At this moment one tries to analyze the dynamic geo-morphological balance in the Oosterschelde and to make predictions of the changes which will occur when the tide in the Oosterschelde will be reduced by the storm-surge barrier.

These studies have indicated that degradation of shoals, shallows and saltings will occur, which might significantly reduce the intertidal area and the saltings. These areas are of great significance for the environment and fishing industry. The shoals and shallows play an important role as a food source for birds and fish. The environmental value of the saltings is immense because of the specific vegetation and the function of a high water refuge for birds.

Shortly after 1986/1987, the manager will have a need for an evaluating study which verifies the prognoses of the present investigations and insight. This concerns a complex request, because many changing factors have an influence on the morphology. Also, the question will arise if, and to what extent, measures are needed to regulate erosion.

4.4 Ecosystem research of saltings

At present, research is carried out in the Oosterschelde into the processes which are taking place in the surroundings of the salt cliff. The relationship between vegetation, morphology, bed, flooding frequency, and the effects of long term flooding on salt plants are investigated. These studies are almost at an end (Doc. 2). Research is also being carried out into the consequences of the introduction of a grazing-regime on a salting, and a full description of the saltings will take place.

The insights resulting from these studies will have to be verified after 1987, through research, especially because of the relationship with the RWS-management.

4.5 Large-scale morphological developments

The storm-surge barrier reduces the volume of the tide going in and out of the Oosterschelde by approx. 30%. This value is based on a model calculation which will have to be verified in practice.

As previously described on numerous occasions in this document, the decrease in tidal volume will lead to a decrease in flow velocity in the Oosterschelde basin. This will almost certainly take place in the main channels, but possibly also at other locations, through which a sedimentation process will be initiated in locations where it has been absent before.

Besides flow velocity, the sedimentation process is also dependent on the supply of material which settles (sand, silt, organic material). The supply of this sort of material from the North Sea will most probably decrease as a result of the low tidal volume; the local supply from erosion (from intertidal areas) and organic production might increase. It is not clear as to how these influences apply quantitatively. The resulting morphological changes in the basin of the Oosterschelde can be of influence on the spreading and mixing of the water masses and on the water quality.

The soil types of possible new depositions also have, because of the interaction between water and bed, an influence on the water quality and on the local flora and fauna.

In the mouth of the Oosterschelde, outside the storm-surge barrier, changes will occur too.

In the mouth of the Oosterschelde, ever since its creation, there is a constant movable system of bars and channels, maintained by the incoming and outgoing tidal currents and the influences from the North Sea.

As a result of the tidal volume reduction of the Oosterschelde,

the North Sea influence on this system will become relatively stronger and could thereby change the existing pattern.

The disappearance of the transverse tidal flows as a result of the construction of the Brouwers dam and the discharge complex Haringvliet, have already brought about radical changes in the system of channels and bars in front of the coastal apertures concerned; namely, a number of coast parallels originated. This process is still going on. It is not out of the question that this might once more influence the system in the mouth of the Oosterschelde.

Combined, the reported influences can lead to radical changes in the morphology of the mouth of the Oosterschelde. It is not yet clear how these changes will take place.

Changes in the morphology will, most likely, have consequences for the hydraulic resistances which influences the movement of the water masses under different circumstances.

Under normal circumstances (open barrier) this can lead to a change in the tidal volume going in and out of the Oosterschelde and so influences the tidal situation in the Oosterschelde

basin. During storm-surge conditions (closed barrier) this can lead to a change in the water levels in front of the barrier and in the wave impact on the barrier. Several starting points in the design would have to be re-checked in this case. This makes clear that monitoring and control, and if possible, prediction of morphological and hydraulic developments are important for the future management of the areas concerned.

Documentation

1 Onderzoek en advieswerk ten behoeve van versterkt beheer Deltawateren, Nota DDMI-85.01 d.d. januari 1985

2 Kohsiek, L.H.M.; Berg, D. v.d.; Smaal, A.C.; Stortelder, P.B.M.; Leewis, R.J.; Jong, A. de: Onderzoeksvoorstel Voor-delta, Nota DDMI-85.02, d.d. december 1984

3 Groenendijk, A.M.; Vink-Lievaart, M.A.: Invloed van de Stormvloedkering en het beheer daarvan op de Schorvegetatie in de Oosterschelde, VEGIN-SCHOR, eindrapport 1985

5 Monitoring and control of performance and condition of completed barrier

5.1 Introduction, definitions and functions

One of the requirements for the storm-surge barrier together with the other barriers around the Oosterschelde, is that it should give sufficient protection against storm-surges, working in one system with the water retaining structures around the Oosterschelde. Within this system, the storm-surge barrier plays a significant role which has to be maintained for 200 years.

In view of this main function, a quality requirement has been set on the storm-surge barrier which can be summarized in a probability of failure of maximum 10^{-7} per year, with regard to the peak event 'flooding of parts of Zeeland'. In relation to this failure criterion the maximum hydraulic loads which are exceeded less than 2.5×10^{-4} per year, should be taken into account.

This quality requirement can be affected in many ways during the initiation process (design and construction) and during the further life span of the barrier.

The series of measures aiming at: 'the assessment, guarantee, maintenance, and, if required, repair of the quality' can be indicated with the term 'quality management'. The quality management can, in time, be subdivided into two aspects:

- The quality management in the initiation phase;
- The quality management during the further life span of the storm-surge barrier.

During the initiation phase the attention is focussed on the establishment and guarantee of the quality of the measures to be taken, while after completion and during the life span of the barrier the attention of the measures focusses on the further assessment of the realized quality, the maintenance or improvement, or the eventual repair of the quality, in case this has been reduced due to one or other reason.

The quality management in the design- and construction phase is strongly linked with the creative shape and was, with regard to the design, fully discussed in part Document 1.2 and in the compiled part design documents in Books 2-4. With regard to the construction, one should keep in mind the continuous verification of the realised work on the requirements of the design, the feedback of construction experiences to the design and the verification of the results of, in particular hydraulic, model research to practical measurements in the prototype during various construction phases. Further attention will be given to these items in the written construction-evaluation documents.

This chapter and the next will discuss in more detail the quality management after the completion and during the further life span of the barrier.

The quality management can then be subdivided into:

- Performance monitoring and condition control; and
- Maintenance.

'Performance monitoring and condition control', in the framework of these design documents, can then have two definitions.

1 More design oriented:

'The control of the validity of the estimates (conditions) under which the design originated'.

This relates then to, a.o.:

- The validity of estimates surrounding the expected external loads;
- The validity of utilization of used schematizations in calculations;
- The validity of transfer to the prototype of data obtained from (model-, laboratory-)research.

2 More maintenance oriented:

'The monitoring of the performance capacity (condition) of the barrier which, without changing the design assumptions referred to above, can be affected by all sorts of decomposition processes (erosion, corrosion, wear and tear, etc)'.

In practice the distinction between the two types of condition control, according to the above mentioned definitions, cannot always be indicated clearly.

The term 'maintenance' can be defined by:

'all those measures, which are necessary to prevent damage and shortcomings of the structure, to observe, recognize and repair, and to limit wear and tear'. The damage and defects referred to are those which did not originate as a result of changes in the design boundary conditions.

On the basis of this definition of the maintenance, it will be clear that the 'maintenance oriented performance monitoring and condition control' is part of it.

This chapter will further discuss 'maintenance oriented performance monitoring and condition control' which can be defined more clearly than before and more practically oriented, with:

'the analysis, as well as the evaluation, of the predicted behaviour of the structure and its boundary conditions introduced schematizations and extrapolations, so that a conclusion can be formulated as to the extent of which the construction can fulfil its present and future function (on the basis of the observed behaviour of the structure)'.

5.2 Aim of performance monitoring and condition control

The storm-surge barrier in the Oosterschelde is a very special structure. It actually concerns a structure that has to close a coastal aperture under extreme hydraulic- and meteorological conditions.

Because of this the structure must be able to resist very strong loads which will occur with a very low frequency.

From the technical and economical considerations, a choice

was made for a main structure consisting of loose prefabricated elements with shallow foundations, combined with structures made from granular materials.

Due to the fact that the piers are constructed as bending moment free, a redistribution of loads to the structure itself is not possible. On the other hand the settlement differences between the piers are only acceptable within very strict limits, in relation to the operation of the enclosure means.

During the design of the storm-surge barrier a large number of assumptions were made with regard to the loads, the calculation methods and the transfer of research results to the prototype. Assumptions which are surrounded with an uncertainty margin, which influences the quality of the barrier.

With other structures these estimates can often be checked on their accuracy by testing with a clearly defined (excess-)load of the completed structure. In the case of the storm-surge barrier that is impossible because of its large size and the extreme design forces. Only a small number of components can be tested in this way. The only possible way to test the validity of the assumptions of the design of the storm surge barrier is to observe the behaviour during a certain period with actually occurring loads, and to compare this with the predicted behaviour in the design. During this period of observation, a sufficient number of heavy storm-surges has to occur of such a size that a statistically accountable extrapolation of the results to extreme design conditions is possible.

Because an active position had to be taken during the observation of the behaviour of the barrier and the forces experienced on it (see Section 5.3), the expression 'condition control' is correct, although in fact it concerns the verification of the design conditions.

The intention of the research for the performance monitoring and condition control is to decrease the uncertainty margins surrounding the realised project which originates from lack of knowledge by an increase in knowledge. The increase in knowledge leads, in the first place, to a better understanding into what the capabilities of the structure are resulting a better defined framework within which operations can be carried out with the storm-surge barrier. This framework can be bigger or smaller than the design framework.

Depending on this, measures have to be taken to limit the loads on the structure or the operational possibilities can be enlarged.

In general the aim of the condition control and performance monitoring can be defined as:

'The control of the functioning of the storm-surge barrier to, if necessary, take timely measures to guarantee this functioning during its life span'.

This more generally defined aim can also be applied to the maintenance oriented condition control. Specifically aimed at the design (pre)conditions, the following subdivision can be made:

- a) Verification of the predicted behaviour of the storm-surge barrier and its components as a result of external forces (on the basis of the observed behaviour of the construction).
- b) Verification of the boundary conditions which were introduced in the design, by means of extensive model research (mathematical/physical), such as loads, transfer coefficients, wave spectra, soil mechanical phenomena, etc., as well as schematizations and extrapolations introduced in the design.

With the help of the results of a) and b) an evaluation can be made of the design criteria, the used safety coefficients and the

probability of failure of the storm-surge barrier and/or its components. The final aim of this evaluation is:

- To establish and carry out measurements guaranteeing the quality of the barrier during its life span if necessary;
- To establish in more detail the possibilities of use of the barrier which could be changed, for example in relation to the ecology.

Beside the above mentioned primary aims a) and b), the following secondary aims can be mentioned:

- c) Judging of the consequences resulting from possible morphological changes (e.g. the shifting of banks, flow channels, etc.) on the management of the storm surge barrier.
- d) Gaining more insight in relation to the design of, for example, off-shore structures which have an equivalent degree of difficulty (in other words a clearer scientific aspect), especially the soil mechanical phenomena.

5.3 Performance monitoring and condition control in practice

The practical elaboration of the performance monitoring and condition control was put into the hands of the working group HISCON which was finally accountable to the PGS.

This project group established a project plan for the condition control (Doc. 1) to verify the design starting points and to study the behaviour of the barrier as a whole, and of its components. It concerns research during the construction phases and after its completion, with the emphasis on the latter.

Because the project organization will be dismantled after the completion of the barrier and the various research programmes will continue for some time, the manager (Regional Division of Zeeland) is responsible for the carrying out of the condition control, who cooperates with the expert services in the Rijkswaterstaat and the external experts, such as TNO and Delft Geotechnics.

Besides the mentioned project plan, this working group had to take care of the scenarios for the necessary research, the specification of the necessary tools, and had to obtain the necessary provisions for components of the barrier which were essential for the installation of survey equipment.

From the total concerned area around the barrier (further elaborated in Table 5), for which in principle, the performance monitoring and condition control has been initiated, the already formulated aims were assumed (Section 5.2), a choice was made for the specific research related subjects.

The performance monitoring of so-called wet works (group B and C of Table 5, see also Table 6) is also part of the project plan, but it is also part of the performance control for the benefit of the maintenance. Especially for the evaluation of the behaviour of hydraulic structures, knowledge of the actual occurring hydraulic loads is necessary. However, these hydraulic loads can be derived from the more general control of the environmental boundary conditions.

With respect to the durability of the geotextile in the bed protection, a special research project has been started (Doc. 2 and 3), beyond the intended project plan mentioned above. In the first place, this project comprises an accelerated durability research, from samples of the constructed work.

On the basis of the results of this investigation, a further performance monitoring and condition control programme, together with the maintenance, was established. Further it was thought that a future information system, as a follow up to the

Table 5 Subdivision of the main components in which performance monitoring and condition control can in principle be applied.

-
- A. The barrier
 - foundation structure, including subsoil
 - piers
 - sill beams
 - upper beams
 - box girders
 - gates
 - mechanical components
 - electrical installations
 - B. The sill construction and the bed protection
 - connection sill dumpings against the sill beams and the piers
 - aprons
 - bed protection
 - C. The edges of the bed protection and the adjacent banks
 - erosion holes
 - stability edges and banks
 - D. The areas in front and behind the barrier
 - morphological changes in the seaward side delta
 - morphological developments in the Oosterschelde basin
 - E. The natural boundary conditions
 - water levels, currents
 - hydraulic head over the barrier
 - tidal characteristics on both sides of the barrier
 - wave height and wave direction
 - wind direction and wind force
-

Hydro-meteo Informations System Oosterschelde (HISTOS), which would yield data for the control of the barrier (see Chapter 1, Section 7) should also be able to supply data on the basic environmental and hydraulic boundary conditions for condition control.

The HISCON-project plan mainly contains subjects in relation to:

The environmental and hydraulic boundary conditions

A verification of the influence of the barrier on these environmental boundary conditions such as:

- The measurement of the reflection coefficient of the closed barrier for waves;
- The loss of energy of the waves because of the open barrier;
- The determination of the discharge coefficient (discharge measurement) of the three closure gaps under different circumstances;
- The measuring of the environmental and hydraulic conditions near the barrier on behalf of the condition control for the barrier. These data are necessary in order to establish the relationship between the occurring conditions (especially waves) and the measured loads, and to obtain data to calculate experienced loads (especially flow velocities).

The behaviour of the barrier

A verification of the total equilibrium system of the barrier. This is of importance for an insight into possible changes occurring in the position of the piers. When certain tolerances are ex-

ceeded these changes are of great importance for the functioning of the barrier. This research can, in the main, be subdivided into three blocks, namely:

- Hydraulics (loads);
- Transfer functions in the structure;
- Soil mechanics (reaction of the subsoil)

Furthermore, a large number of variables play a role (see Table 7).

The soil mechanical aspects are of significance for these problems.

1 Research into the behaviour of and loads on the upper beams, gates and operational mechanisms, influenced by flow and waves during various conditions (open, closed, partially opened, movable). This research can be divided into a number of section aspects as shown in Table 8.

The importance lies in the relationship with the control rules and in the verification of expectations around the life span (fatigue problems).

2 Research into the durability of the concrete as a construction material, as well as a number of important components, such as supports and anchoring of the prestress systems

The aspects which are discussed here are:

- Damage, both above and under the water level;
- Erosion of the concrete.

These aspects are similar to the condition control for maintenance (inspections for establishing the necessary repairs).

For the measurement of erosion, reference points have to be installed in the considered places.

A third aspect would be:

- Corrosion of concrete and anchorings, as well as the weakening of the rubber bearings. The penetration of Cl-ions are involved in the problems of concrete corrosion.

This aspect will have to be investigated with the help of dummies in similar circumstances, because to obtain samples from the structure itself would cause damage difficult to repair.

The Project plan-condition control contains more detailed information (Doc. 1).

In relation to the operational period of the condition control, the following remark has to be given:

- Most research can be carried out in relatively short lasting survey campaigns;
- A significant number of them, however, have to be carried out under heavy storm conditions (wind force 10).

(This means that on the one hand to obtain sufficient data, and on the other hand to make the necessary extrapolation to the extreme design circumstances indicated as small as possible for the design).

- Many observations will have to be repeated (about 10 times) to obtain sufficiently reliable statistical data.

All these items make it necessary to have an active waiting position for the actual operation of the measurement programmes involved until nature produces the desired circumstances.

These programmes are expected to last several storm seasons (2 to 3);

Furthermore it can be stated that:

- Measurements on behalf of the verification of the total equilibrium of the system have to be carried out in short campaigns (during or after heavy storms) covering a period of about 25 years;
- The research into the durability of concrete (with the help of

Table 6 Overview of aspects of performance monitoring and condition control relating to hydraulic engineering works.

Component	Aspects of condition control
Sill structure	Stability of the top layer with regard to currents, deformations of the sill structure
Dumpings at the piers	Relative position of the dumpings with regard to the sill beams
Rubble dam	Stability, deformations
Foundation mat	Stability filter materials
Bed protection (asphalt mastic, stone-asphalt mats and block-mats)	Durability, stability bed protection structure and its dumping materials, bed protection damages and possible scour holes arising from these
Edges of the bed protection and adjacent banks	Control of occurring scour holes, dumping of slopes which are too steep, stability of dumpings

Table 7 Overview of variables, which are of importance in the total equilibrium system.

Description	Type	Location/component
Hydraulic loads	Dead weight	Pier
		Sill beam
		Gate
		Upper beam
		Dumpings
	Hydraulic/static NS/OS	On pier
		Sill beam
		Upper beam
	Hydraulic cyclic NS/OS	Gate
		On pier
		Sill beam
		Upper beam
	Hydraulic cyclic N/S	Gate
		On pier
		Sill beam
		Upper beam
Hydraulic static vertical	Gate	
	On pier	
	Sill beam	
	Upper beam	
Hydraulic cyclic vertical	Gate	
	On pier	
	Sill beam	
	Upper beam	
Stiffnesses	Static	Bed
		Sill head wall
		Sill side wall
		Dumpings
		Gate
	Cyclical	Bed
		Sill head wall
		Sill side wall
		Dumpings
		Gate
Deformations	Static displacements and rotations	Pier
	Cyclic displacements and rotations	Pier

NS = North Sea side structure; N = North side structure;
 OS = Oosterschelde side structure; S = South side structure

Table 8 Overview of performance monitoring and condition control aspects of gates and operating machinery.

Aspects	Aim
The own frequencies of the gates	Coupling with completed model research; necessary for the interpretation of other measurements on the gates
The structural measures of the bars and gates to the current excitation	In case of a high vibration level, this can lead to special closure instructions or to structural measures of flow disturbing supplies on the bars
The weakening factor of the joints	Is of importance in relation to the inspection of the gates and the expected life span of the gates
The magnitude of the wave impact pressures	Depending on the magnitude of the wave impact pressures, this can cause changes in the way gates are moved
The horizontal- and vertical transverse pressures on the gates	Is interesting from a point of view of a possible decrease in pressure as a result of spreading of wave directions.
The longitudinal slopes on the gates and the dynamic forces when the gate collides against the pier and the occurring acceleration of the hydraulic cylinders	To gain more insight into the exchange between the gate movement and the hydrodynamical forces, and the verification of the calculation model used for the design
The dynamic behaviour of the hydraulic system of the operating machinery	Control of the dynamic phenomena in the hydraulic system, and the verification of the calculation model used for the design

dummies), although with a very low research frequency, will spread over a period of about 50 years.

From the above follows that maintaining the continuity of the long term programmes, the maintenance of the installed measurement provisions, and the activation of the occurring measurements (when the circumstances are favourable), are important aspects during the programme for the design oriented-condition control.

Although the research and the technical-scientific interpretation is the work of experts, these aspects will need the attention and involvement of the manager. Because of his position, the manager will be closely involved with the storm-surge barrier

and is one of the main interested parties in the final results of the condition control of the constructed work.

Documentation

- 1 Project groep HISCON Project plan Conditie bewaking, HISCON-M-84.050, d.d. 1 juni 1984
- 2 Rijke, W. de; Duurzaamheidsonderzoek geotextiel blokkenmat, SOOCOO-M-85155/22RABO-M-85127, d.d. 8 mei 1985
- 3 Rijke, W. de; Duurzaamheid materiaal blokkenmat 2PROBU-M-85053

6 Fields of interest for maintenance

6.1 Rough survey of the maintenance problems

Maintenance is part of the process of quality control which begins with the realization of the object (see Section 5.1). The starting point of the quality control after delivery of the object, is the maintenance of such a quality that the object can fulfil its functions satisfactorily in the future.

This can be obtained on the one hand by performance monitoring, the control of conditions under which the object has to fulfil its functions and if necessary, by the taking of measures. On the other hand this is obtained by maintaining the quality of the object: the maintenance.

Improvements to the object, resulting from imperfections which were discovered afterwards, or originated from adapted quality requirements (including changed circumstances), are strictly speaking not part of the maintenance although in many cases they might be carried out within the frame work of maintenance.

The aim of maintenance can be formulated as follows:

'To maintain the realized quality of the object'.

Therefore the maintenance effort is focussed on the continuation of the initial quality of the structure.

The aim of maintenance can also be formulated from an opposite, rather negative point of view.

'To prevent such a decrease in the quality of the object that the required fulfillment of its functions could be endangered'.

In this case the sufficient functioning of the object is the focus point of the maintenance effort.

These two descriptions of the aim of maintenance indicate that there might be a certain margin between the realized quality of the object and the minimum quality required.

With a good design and a good construction of the structure this margin will be available although it will be reduced when the quality requirements are set at a higher level. In general, the manager will make use of this margin when carrying out maintenance activities.

In the case of the storm-surge barrier the quality requirements are extremely high especially for its functioning during storm-surges and the quality margin for maintenance will be small.

The small reserve available in the structure, can be partially derived from the design described in this document and has to be established further with the help of the condition and performance control research.

When the storm-surge barrier is regarded as a combination of

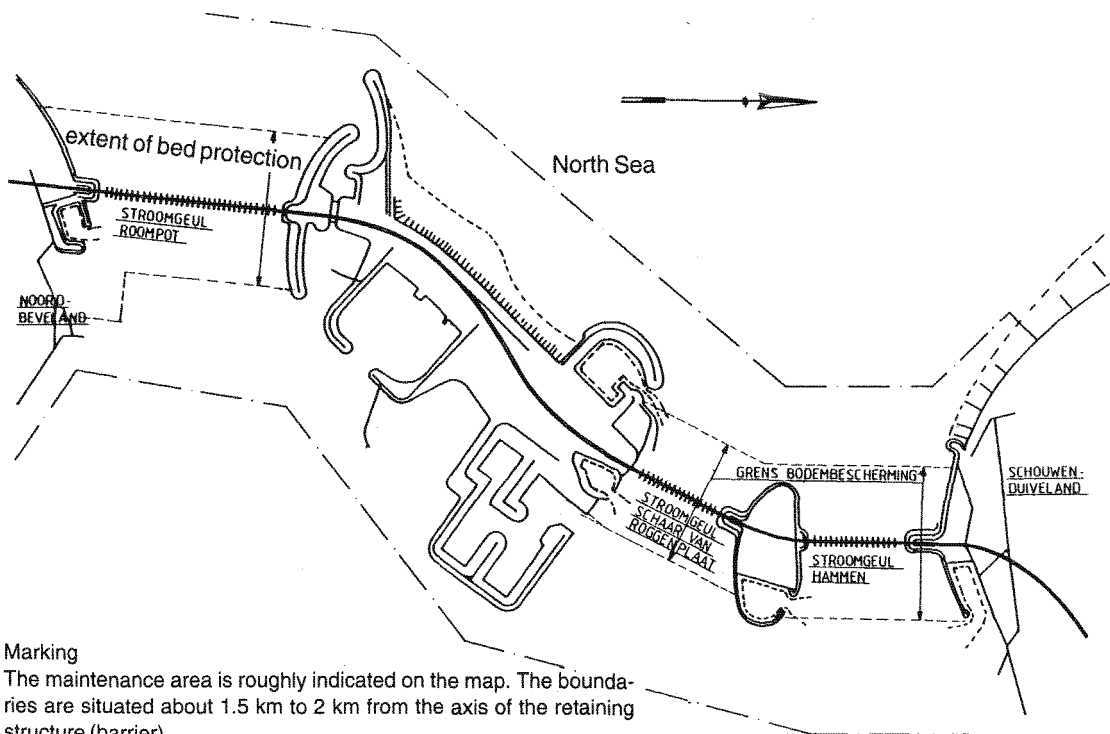

Marking

The maintenance area is roughly indicated on the map. The boundaries are situated about 1.5 km to 2 km from the axis of the retaining structure (barrier)

Fig. 7 Considered area for maintenance.

components, it will appear that, for various reasons, the available quality margin for maintenance activities is different. Not every component will be loaded to the extreme and damage or failure of a number of components will not necessarily lead to the failure of the entire barrier. In this case there will be a larger margin between the initial quality and the minimum acceptable quality.

The quality of the maintenance can be judged with the help of the following criteria:

- The degree of prevention of quality decrease;
- The time elapsed before the quality decrease of the object can be detected and the time needed to take action (the degree to which the team is prepared for quick action);
- The extent of quality recovery of the object after measures have been carried out.

A positive review of these criteria will in general lead to a relatively high average of the real quality of the object with a small standard deviation.

In other words: the original quality of the object will be maintained as well as possible. The costs of the maintenance effort will be higher when the required quality of maintenance needs to be higher. This relationship will be frequently progressive on the cost side.

It has been mentioned earlier that the required quality of maintenance is not an established parameter.

It is therefore possible to strive for an optimum maintenance effort as opposed to the attainable results. This can be indicated as the second aim of the manager during the execution of his maintenance activities.

The manager has to weigh the pros and cons concerning:

- The interests served by the quality of maintenance; and
- The volume of the maintenance effort in order to obtain the desired quality level.

The interests are indicated by the aims of the object and its functions. This will be further discussed in the following Sections.

Further details will be given below on the problems of the maintenance effort.

The valuation criteria for the quality of maintenance also give an indication of the instruments used by the manager for quality maintenance of the object, such as:

- The prevention of a decrease in quality by preventive maintenance;
- The detection of quality decrease and the review of the necessary measures by inspections (controls); and
- The execution of quality recoveries by repair, also called corrective-maintenance.

In the maintenance strategy, to be established by the manager, it is indicated in which way and to what extent, varying over the different components of the barrier, these instruments will be applied. The weighing of costs against interests forms an important part of this strategy.

The technical construction of the object as a whole, or of its components as well as the level of the technique for maintenance activities can be a restricting factor.

Besides, when establishing the maintenance strategy, policy- and economical aspects will also emerge, such as:

- The manager's own vision;
- The costs;
- The possibilities of the own organization or those of possible third parties with specific aspects, such as:
 - * Preparedness for quick action;
 - * Expertise;

* Quantitative input of people and means.

Briefly, it can be said that the maintenance problems are complex whereby a large number of aspects have to be judged by the manager. It is also mentioned that in the design of the barrier as a whole, there are aspects which can influence the maintenance strategy and the carrying out of maintenance activities. These aspects are further analyzed in the next Section.

6.2 Further survey and analysis of points of interest

The total considered field for maintenance involves the entire storm-surge barrier with nearby surroundings (see Fig. 7). A large number of components can be distinguished which can be subdivided into groups from different angles.

Firstly, subdivision is possible according to the techniques carried out, such as:

- Typical road- and engineering structures above and below the water level, to be subdivided into structures consisting mainly of granular and bituminous materials;
- Concrete structures;
- More or less static steel structures;
- Hydraulic structures;
- Electrotechnical and electronical structures.

Such a subdivision is relevant for maintenance purposes, because the techniques applied are most relevant for the techniques which can be applied for maintenance. A further elaboration of this subdivision is not necessary, because details are sufficiently known.

The components can be classified according to their functions which are ascribed to the entire barrier structure, such as:

Main functions:

- The retaining of storm-surges under extreme conditions;
- To allow the tides in the Oosterschelde under normal circumstances;
- Because these two functions can not be carried out simultaneously, it is essential to be able to switch from one function to the other.

Additional functions:

- To keep a road connection across the Oosterschelde;
- To allow navigation from the Oosterschelde to the sea or vice versa (Roompot Lock).

Secondary functions:

- The possible secondary functions discussed in Chapter 2.

For the classification components to these functions it can occur that the components play a role in more than one function.

The relevance, for maintenance purposes, of such a function classification is that the functions have a different importance. From this importance a priority sequence can be established for maintenance.

In other words: The more important the function, the higher the quality requirements for maintenance.

Finally, starting from the above mentioned function classification, the character of the function of a component (active or passive) and the mutual relationships between components can be analyzed.

This analysis is further discussed in the next Section. Such an analysis makes sense because aspects of it could be of consequence to the maintenance strategy.

6.3 Further analysis of functions and relationships between components

6.3.1 Active and passive components

The functions of the storm-surge barrier as a whole (mentioned in Section 6.2) can be divided into active and passive functions and in passive and active components.

'Active' could be defined as: 'to be able to adjust, at the right moment, a desired situation (not existing previously) in order to carry out a required function'.

'Passive' could be defined as: 'The fulfilment of a required function by its (static) presence'.

'Active components' are components which can carry out a certain activity or undergo a certain activity in order to change a certain situation.

Active functions of the storm-surge barrier are:

- To be able to change the storm-surge barrier from a permeable construction to a barrier or vice versa.
This function has been allocated to the gates with the mechanical actuators;
- To be able to allow navigation through the barrier.
This function has been allocated to the Roompot Lock; more in particular to the horizontal roller-bearing gates and the mechanical systems.

All other functions mentioned and the components can be regarded as passive, except for providing the functions of illumination and so on.

With regard to the Roompot Lock, in principle, it can be remarked that as a barrier it has a passive role (see Section 6.3.3).

When the expression 'interference' is defined with: 'not being able to carry out the required action at the desired time',

then only active components are vulnerable to interference.

An interference is acute, it immediately prevents the execution out of a certain function.

For the purposes of maintenance, the difference between active and passive components is expressed by the fact that for the active components the purpose 'maintenance of initial quality' can be subdivided into:

- The prevention and/or restoring of interferences as quickly as possible; and
- The maintaining of the general quality of the component.

This subdivision is not possible for passive components.

In the maintenance activities for active components, a clear distinction can be made between these two aims.

In view of the acute character of interferences, the maintenance will be directed in the first case towards the prevention of interferences, and in the second case to enable quick action if required. The priority for both these aspects will be higher than that of the maintenance directed towards the second purpose: the maintenance of the general quality.

6.3.2 Primary functions against supporting functions

Within the functional classification, another distinction can be made between components with, as their most important function, one of the functions of the entire structure (mentioned in Section 6.2), the so-called primary components and components which have a supporting function for one of the primary components. An example:

The combination of sill, transition structure, piers, sill beams, upper beams and gates, has a primary function as barrier and water discharging structure.

The adjacent aprons and bed protection have a supporting function, which is to prevent erosion which can affect the stability of the primary component.

The care for the remaining presence of the edge of the bottom-edge protection (scour holes, etc.) has, in turn, a supporting function for the bed protection.

The consequence for the maintenance of such a supportive component is that a certain limited quality decrease is acceptable, as long as the function of the primary component is not affected.

The individual integrity of the supporting component concerned does not determine the minimum acceptable quality of that component, but the integrity of the component which is supported has to be maintained.

This broadens the general margin for supporting components. Besides the above mentioned example, various groups of components can be indicated in the entire complex which form a unit via this supporting relationship (see Section 6.4). It can be stated that for such a unit, the priority of the primary component is relevant for the entire group.

6.3.3 Mutual dependency of primary components

In relation to this subject, a distinction can be made between active and passive components, such as defined in Section 6.3.1.

Active components can form a functional chain in which an interference to one component can paralyse the functioning of the components behind it. That is the reason why components of such a chain can be called equal and primary, in spite of their mutual dependency.

This sort of chain is vulnerable to interference and demands extra attention from the interference oriented maintenance.

In the barrier, similar chains appear in a complex form in:

- The components of the system for closure of the apertures: gates, mechanical actuators, hydraulic units, energy supply, control units, service units, decision making system (including the emergency closure system);
- The Roompot Lock: closure system, roller-bearing gates, gates, mechanical system, hydraulic units, management system, energy supply.

The first mentioned chain is of vital importance for the functioning of the storm-surge barrier because it deals with the switching over of the two main functions. Therefore in order to decrease the probabilities of interference, a number of safety measures and reserves were incorporated in the design (see Part 4, Section 2.8 and Book 4).

To check the reliability of the design, a detailed probability of failure analysis was carried out for the entire system (see Part 2, Chapter 3), which could also support the establishment of a maintenance strategy.

The second chain is of importance to the passage function for navigation. For the main functions of the complex, this chain is not very important; under normal circumstances at least one roller-bearing gate is closed so there is a barrier present.

Passive components can form a combination which has to fulfill one or more functions.

The most important example in the storm-surge barrier is the combination (previously mentioned in Section 6.3.2) of: foundation bed, sill, transition structure, piers, sill beams and upper

beams. The gates are also an essential part of this. The main functions of this combination are the transmission/permeable function for the tide (especially sill, piers and sill beams) and the retaining function for the storm-surges (all mentioned components together).

The box girders which are (technically) part of it, have a supporting function in relation to the main function (accommodation) for the movement of the gates. When the additional function 'road connection' is included, then the box girders have a primary function in relation to the piers and the foundation bed, literally meaning a supporting role.

The mutual dependency of the mentioned components is characterised by the following:

- The failure of one component has as a result that the whole system cannot properly function as a barrier;
- In particular for the combination of concrete and steel components this means that, if exceeding certain tolerances, a deformation leads to excess loading of these components, and to the prevention of the appropriate motions of the gates.

Because of the mutual dependency this combination is relatively vulnerable, and its functioning particularly dependent on the stability of the piers and shape stability of the sill. The design and a good construction have to provide the required safety. For control purposes a probability of failure analysis was carried out (see Part 2, Chapter 3).

The prevention or the stabilization of erosion in time which threatens the stability of the piers and the shape stability of the sills is an important point of interest for the maintenance because repairs later on, especially to the concrete components, are extremely difficult and very costly.

Furthermore, the quality of the dumpings around the sill beams are of significant importance, in particular for the sill.

6.3.4 Independent primary components

These components have the distinguishing characteristic of being relatively independent of each other, and of being able to contribute to one of the functions of the entire object. This independence is best expressed in one of the main functions of the object, namely the retaining of storm-surges.

In addition to this, independent primary components can more or less be considered for:

- a) The water retaining earth bodies on the Neeltje Jans and Roggenplaat islands respectively, and on the shores of Schouwen and Noord-Beveland;
- b) The movable barrier respectively in the flow channels Hammen, Schaar of Roggenplaat and Roompot;
- c) The rubble dams with the dam abutment structures as a transition between a) and b);
- d) The Roompot Lock.

A similar coordination of primary components can be established by the function: road connection, whereby the following independent elements can be considered:

- The road hardening on the respective earth bodies;
- The structures constructed in and between the earth bodies;
- The crossing of the flow channels (box girders).

The meaning of the independence of primary components for the maintenance is the fact that these components can be considered independently from each other. The only similar element of these components is that their probability of failure relating to the communal function has to be roughly the same.

Vice versa, a further decrease of the probability of failure of one of the components will have almost no influence on the probability of failure of the other coordinated components.

With this last statement an exception has to be made for the rubble dams and the Roompot Lock with regard to the retaining function during storm-surges.

A complete break-through of a rubble dam threatens the adjacent components of the movable barrier and the dam abutments; a complete break-through of the Roompot Lock threatens the adjacent earth bodies of the barrier.

In extreme situations there is a certain dependence between these elements (see Part 2, Chapter 2 and 3).

6.4 Overview of supporting relationships regarding the retaining function

With reference to the statements in Section 6.3.2, this Section gives a list of components which support the storm-surge retaining function with primary components from the entire barrier structure.

First of all the supporting function, already discussed in Section 6.3.2, of the aprons and the bed protection in the flow channels are mentioned (see also Section 2.10). Along the North-Bevelands bank of the Roompot this bed protection is extended eastwards. The erosion expected along the edges of the bed protection (especially during the construction phase, but possibly also in the final phase) can also form a threat for the stability of the nearby water barrier of the Noord-Beveland island (see Part 4, Section 2.4 and Book 2, Part 11, Section 5.2).

The other supporting functions connected to this relate to the existing retaining structures on the Neeltje Jans and Roggenplaat island.

For both islands an indicative height of MSL + 11.50 m is valid for the barrier, taking into account an undiminished wave impact, and the design and defense of slopes (see Part 4, Chapter 2 and Book 2, Part 3). As already mentioned, for other reasons the general water retaining height became MSL + 12 m.

Normally the outer slopes are covered with an asphalt layer.

The ring dike on the seaward side of the Roggenplaat island forms a part of the safety assessment of the main water barrier on that island (see Doc. 1).

Because of the supporting role of the ring dike (decrease of the wave impact), the seaward side slopes of the main barrier could be given a clay covering (cheaper and aesthetically amiable).

The harbour dams of the Neeltje Jans outer harbour are included in the considerations for the retaining height of a cut in the main water barrier behind this harbour for the cross traffic on the Neeltje Jans island (see Doc. 2). Here too, a decrease in the wave impact is taken into account because of the presence of these dams, which also indicate their supporting role.

The artificially created sand dunes and the beach on the seaward side of the Dam compartment Geul (Neeltje Jans) are included in the considerations for the retaining height of a cut in the main water barrier at the level of the Roompot harbour. The braking action on the wave impact due to the volume of beach and dune sand is taken into account. The maintenance and possible further extension of the mentioned dune forming is therefore of essential importance for the small flooding probability of the intended cut.

The harbour dams of the outer harbour of the Roompot Lock (Noordland) are not included in the assessment of the design boundary conditions for the roller-bearing gates and the protection of the lock platform with regard to their wave breaking effect under storm-surge conditions (see Doc. 1). With a retaining height of MSL + 5.80 m a water overflow is acceptable. For this reason, the lock platform and the lowest section of the slopes of the adjacent earth bodies are provided with a flow resistant covering of loose elements because of the cables and pipes buried in the lock platform.

Although this has not been taken into account, and as long as the harbour dams have not disappeared completely, the wave impact will be decreased, which means that there is a supporting role for the safety of the local barrier.

Documentation

1 Korf, W., Afwerken werkeiland Roggenplaat en complex Noordland, d.d. 16 sept. '85, BS4-M-85113 of PEGESS-M-85303 met bijlagen

2 Kerende hoogten bij damvak Geul en bij buitenhaven Neeltje Jans, d.d. 12 sept. '84, 2PROBU-M-84.080, met bijlagen

6.5 Final consideration and policy of the Regional Division of Rijkswaterstaat for Zeeland

This chapter gives a view of the problems of maintenance of the storm-surge barrier in general.

Via a rough analysis of the functions and mutual relationships of components of the storm-surge barrier aspects of importance for the establishment of a complete maintenance strategy and in particular for groups of components are mentioned.

More concrete attention is being paid to the aspects relating to the retaining function of the storm-surge barrier. The reason for this is that this function, of all named functions, is seen as the most important because:

- The protection of a large part of the Province of Zeeland against flooding is dependent upon the satisfactory fulfilment of this function;
- During the fulfilment of this function in general, the heaviest loading will occur on the barrier;
- The required life span of 200 years for the entire object is coupled specifically to this function.

However, this does not mean that the other functions can therefore be neglected.

The Regional Division of the Rijkswaterstaat Zeeland, as manager of the storm-surge barrier has stated her view on the various aspects of management and maintenance in a policy document (Doc. 1).

This document recognises a number of specific technical and social characteristics of the storm-surge barrier.

These characteristics lead to the conclusion that on the basis of the social characteristics the barrier should be seen as a vital public works construction and in connection with the technical

characteristics special requirements had to be made with regard to management.

The specific technical characteristics are:

- The storm-surge barrier has a low frequency of use; the number of storm closures will on average not be more than once or twice a year;
- The storm-surge barrier needs to be ready for immediate use because of the required Delta-safety; this results in high requirements with regard to inspection and maintenance;
- The storm-surge barrier has a large number of movable components and a complex control- and emergency closure system.

The social characteristics are:

- Malfunctioning of the barrier results in an unacceptably high probability of a serious disturbance in the social and economical life;
- On the basis of long and careful decision making processes, there are high expectations from the public. Disturbance of these expectations create (political) problems;
- It will be very costly to replace the barrier; the financial consequences of inexpert use are significant;
- Finally it can be expected that the national and international reputation of Dutch engineering will be seriously damaged by malfunctioning of the barrier.

In relation to the maintenance, the above mentioned special requirements resulted in a more detailed organization than that which is usually required for large hydraulic engineering works.

Its characteristics are:

- To establish, in cooperation with the designers, a maintenance scenario in which all points of attention and special features of components are listed;
- The probability of failure analysis made for the design will in the future be used as testing instrument for the maintenance (quality, planning, repairs, adjustments etc.);
- For guidance of the maintenance, a formal Maintenance-Information-System will be established which will use a set of up-to-date 'fault trees' in an operational form.

For the carrying out of the maintenance, teamwork will be organized with the Rijkswaterstaat Division Bridges, Locks and Weirs, in which the Regional Division for Zeeland plays a leading and initiating role.

Interference-observation duties will be carried out by the Regional Division for Zeeland, while the other maintenance activities will be carried out by others.

Documentation

1 Nota: Beheer en Onderhoud Stormvloedkering Oosterschelde, Directie Zeeland, AX 86.148, d.d. 11 februari 1986

2 Handboek Stormvloedkering, Projectorganisatie Stormvloedkering, stafgroep COGRON, COGRON-D-86051

3 Onderhouds Informatie Systeem, Eindrapportage vooronderzoek, S.B.C., Zwijndrecht, 22 januari 1986, COGRON-M-86013

Additional bibliography

- 1 Foundation Aspects of Coastal Structures, International Symposium on Soil Mechanics Research and Foundation Design for the Oosterschelde Storm Surge Barrier, Delft, Netherlands, October 9-12, 1978.
- 2 Hydraulic Aspects of Coastal Structures; Developments in Hydraulic Engineering related to the design of the Oosterschelde Storm Surge Barrier in the Netherlands, Delft University Press, 1980, Netherlands.
- 3 Eastern Scheldt Storm Surge Barrier, Proceedings of the Delta Barrier Symposium, Rotterdam, October 13-15, 1982.
- 4 Integration of Ecological Aspects in Coastal Engineering Projects, Proceedings of International Symposium, Rotterdam, June 6-10, 1983, Netherlands.
- 5 The Closure of Tidal Basins; Closing of Estuaries, Tidal Inlets and Dike Breaches, I.C. Huis in 't Veld et al. (ed.), Delft University Press, 1987, Netherlands.
- 6 The storm surge barrier in the Eastern Scheldt: for safety and environment. Rijkswaterstaat, 1987, Netherlands.
- 7 Storm Surge Barrier Eastern Scheldt. Evaluation of water movement studies for design and construction of the barrier. Delft Hydraulics-Rijkswaterstaat, July 1989.
- 8 Fresh-Salt water separation systems for navigation locks in the Netherlands, A.A. Balkema, Rotterdam, 1993.
- 9 Man-made Lowlands; History of water management and land reclamation in the Netherlands, Van de Ven, G.P. (ed.), 1993, Matrijs Publisher, Utrecht, Netherlands.

Design plan Oosterschelde Storm-surge barrier

Overall design
and
design philosophy



A.A. BALKEMA / ROTTERDAM / BROOKFIELD / 1994

annex

Coloured Pictures

